

SERIE526

SET DE MOBILIER MODULAR (7PCS) – EXTENSIE CU DULAP
CU 4 SERTARE (REF.16627)

ACERO
STEEL

MDF

67,90Kg



INCLUDE

x1	16494	DULAP DE PERETE (REF. 54327)
x1	16497	PLACĂ MDF 680X500X40MM (REF. 16627/16628/16500)
x2	16498	PANOU PENTRU SCULE 680X340X25MM (REF. 54327)
x1	16627	DULAP CU 4 SERTARE (REF.54327)
x2	16561	BARĂ SUPORT (REF.54327)

Modulul include borduri frontale și laterale

JBM CAMPLLONG S.L.

CIM La Selva - Ctra. Aeropuerto, Km 1,6 Nave 2.2 CP 17185
Vilobí d'Onyar - GIRONA - ESB17419292 - SPAIN

www.jbmcamp.com
jbm@jbmcamp.com
+34 972 24 55 53

COMPONENTE

16627

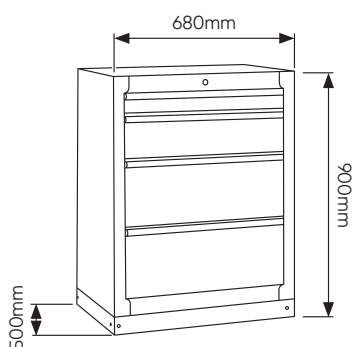

16494

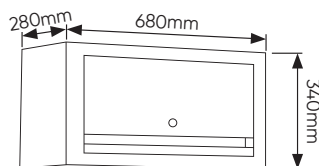

16498

338x25x680mm



16497

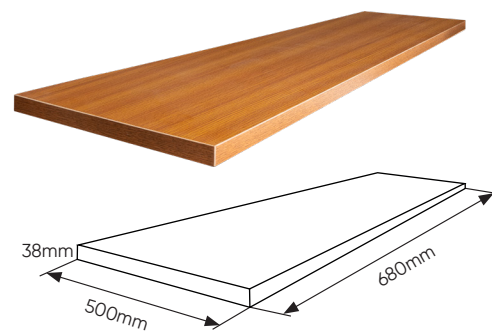

16561



COMPONENTE

SERIE526

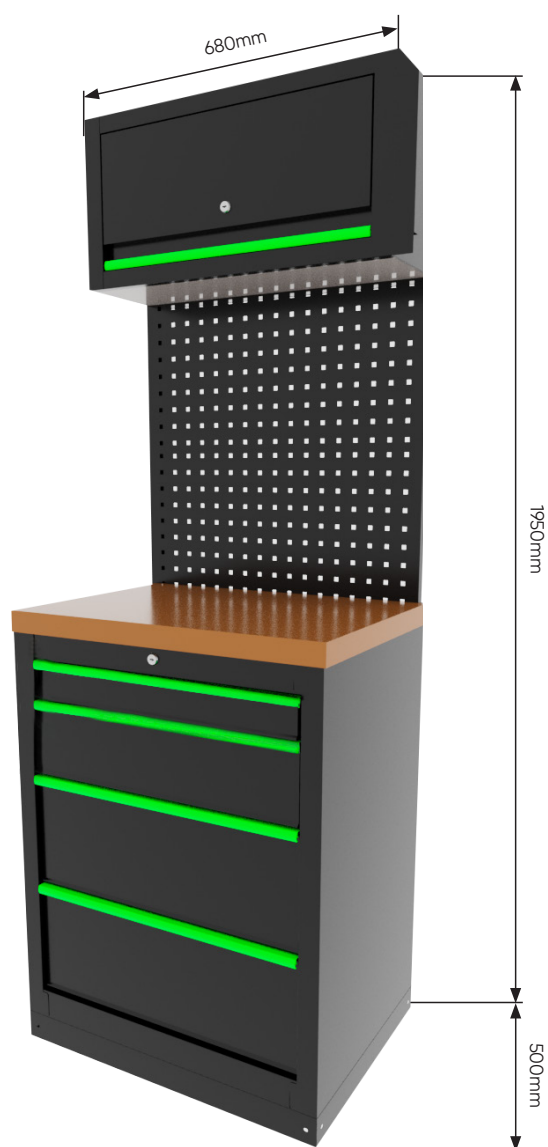

CULORI DISPONIBILE
SERIE526R



SET DE MÂNERE

18005

SERIE526B

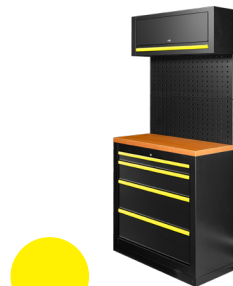

SET DE MÂNERE

18006

SERIE526Y

SET DE MÂNERE

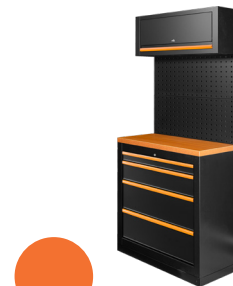
18007

SERIE526O

SET DE MÂNERE

18008

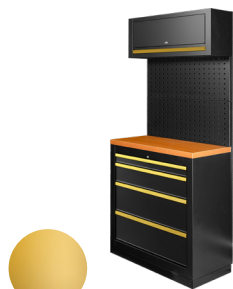
SERIE526G

SET DE MÂNERE

18009

SERIE526P



SET DE MÂNERE

18010

SERIE526K

SET DE MÂNERE

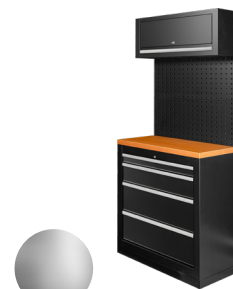
18019

SERIE526S

SET DE MÂNERE

18020



Seturile noastre modulare sunt livrate cu mânere verzi standard, dar primești și mânere în culoarea aleasă din paleta noastră. Astfel, îți poți personaliza rapid și simplu setul pentru a se potrivi cu culorile corporative ale atelierului tău. O metodă practică de personalizare care te ajută să menții o imagine profesională și coerentă în spațiul tău de lucru.