

SERIE596

SET DI MOBILI MODULARI (6 PZ) – ESTENSIONE ARMADIO
CON LAVANDINO (RIF.18103)

ACERO
STEEL

INOX
SS

57,30Kg



INCLUDE

- | | | |
|----|-------|-----------------------------------|
| x1 | 16494 | ARMADIO A MURO |
| x2 | 16498 | PANNELLO 680X340X25MM (RIF.54327) |
| x2 | 16561 | BARRA DI SUPPORTO (RIF.54327) |
| x7 | 18103 | ARMADIO CON LAVELLO INTEGRATO |

Il modulo include cordoli frontali e laterali

JBM CAMPLLONG S.L.

CIM La Selva - Ctra. Aeropuerto, Km 1,6 Nave 2.2 CP 17185
Vilobí d'Onyar - GIRONA - ESB17419292 - SPAIN

www.jbmcamp.com
jbm@jbmcamp.com
+34 972 24 55 53

COMPONENTI

18103

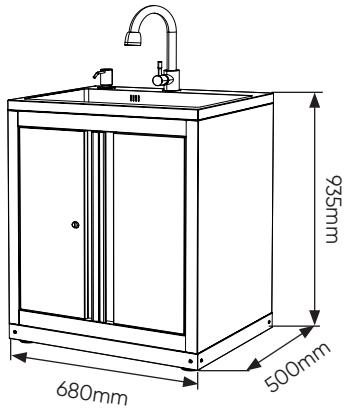
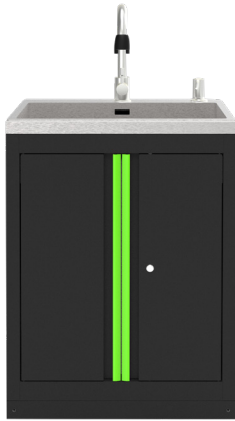

16494

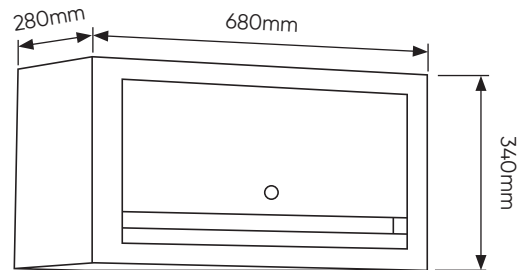

16561



16498

338x25x680mm



COMPONENTI

SERIE596

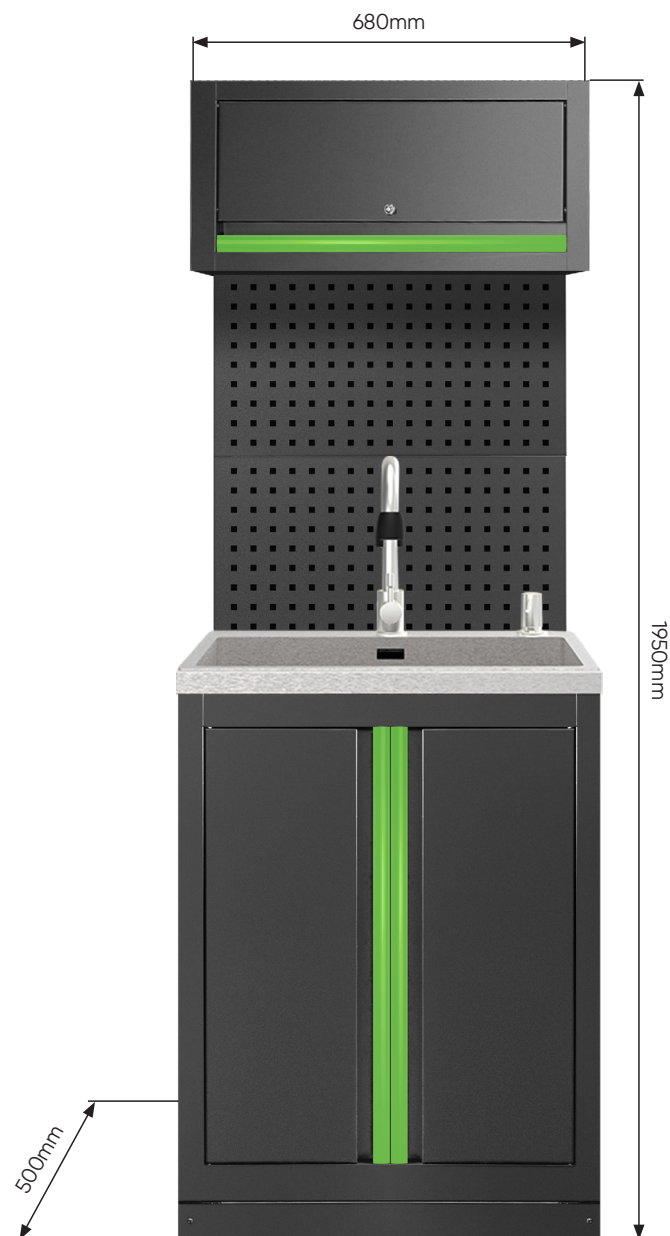

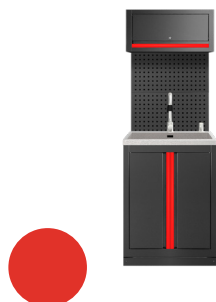
COLORI DISPONIBILI
SERIE596R

SET DI MANIGLIE

18308

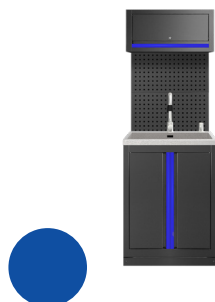
SERIE596B

SET DI MANIGLIE

18309

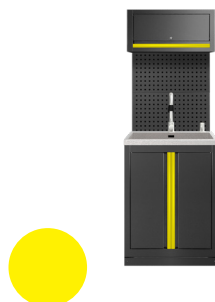
SERIE596Y

SET DI MANIGLIE

18310

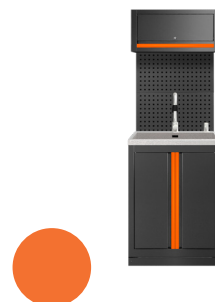
SERIE596O

SET DI MANIGLIE

18311

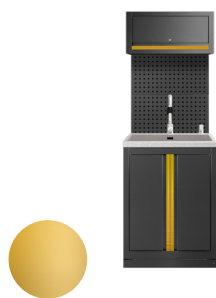
SERIE596G

SET DI MANIGLIE

18312

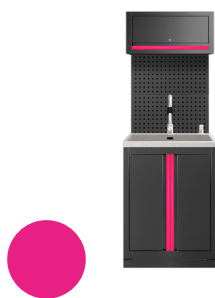
SERIE596P

SET DI MANIGLIE

18313

SERIE596K

SET DI MANIGLIE

18314

SERIE596S

SET DI MANIGLIE

18315



I nostri set modulari vengono forniti con maniglie verdi di serie, ma ricevi anche le maniglie nel colore che preferisci dalla nostra palette. In questo modo puoi personalizzare facilmente e velocemente il tuo set per abbinarlo ai colori aziendali della tua officina. Un metodo di personalizzazione pratico che ti aiuta a mantenere un'immagine professionale e coerente nel tuo spazio di lavoro.