

SERIE596

CONJUNTO DE MÓVEIS MODULARES (6PCS) – EXTENSÃO
DE ARMÁRIO COM LAVATÓRIO (REF.18103)

ACERO
STEELINOX
SS

57,30Kg



INCLUI

- | | | |
|----|-------|---|
| x1 | 16494 | ARMÁRIO DE PAREDE |
| x2 | 16498 | PANEL DE FERRAMENTAS 680X340X25 MM (REF. 54327) |
| x2 | 16561 | BARRA DE SUPORTE (REF.54327) |
| x7 | 18103 | ARMÁRIO COM PIA INTEGRADA |

O módulo inclui lancis frontais e laterais

JBM CAMPLLONG S.L.

CIM La Selva - Ctra. Aeropuerto, Km 1,6 Nave 2.2 CP 17185
Vilobí d'Onyar - GIRONA - ESB17419292 - SPAIN

www.jbmcamp.com
jbm@jbmcamp.com
+34 972 24 55 53

COMPONENTES

18103

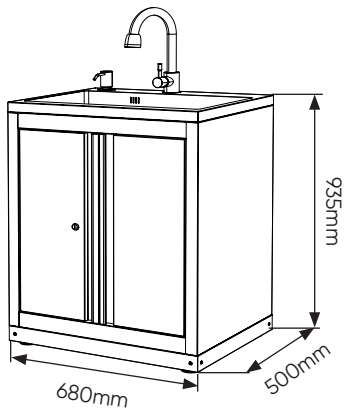
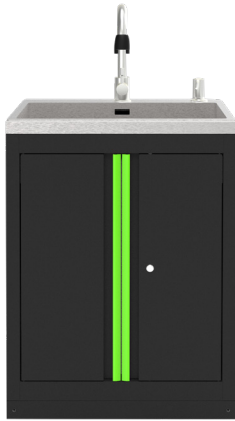

16494

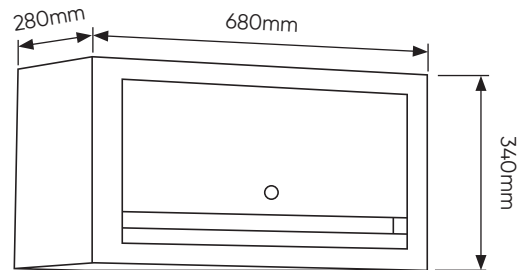

16561



16498

338x25x680mm



COMPONENTES

SERIE596

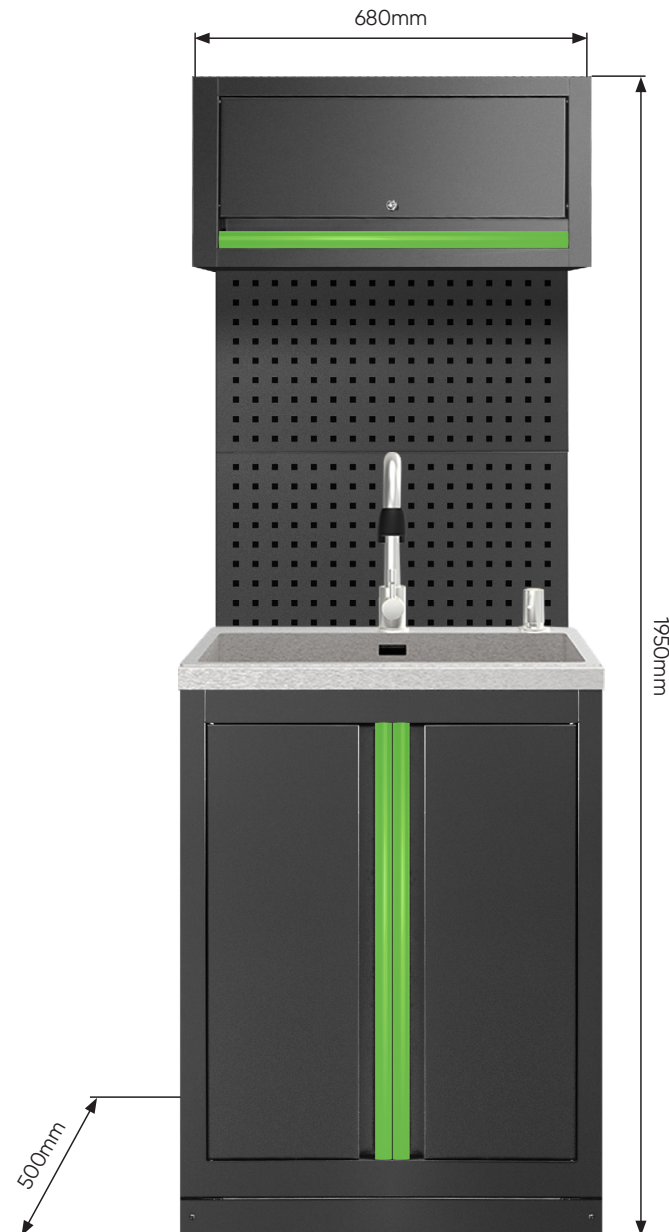

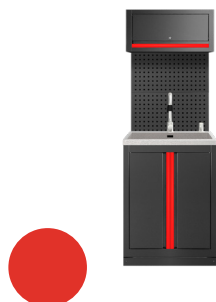
CORES DISPONÍVEIS**SERIE596R**

JOGO DE PUXADORES

18308

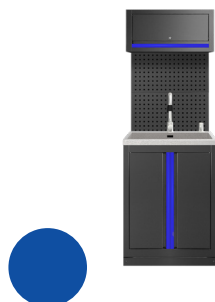
SERIE596B

JOGO DE PUXADORES

18309

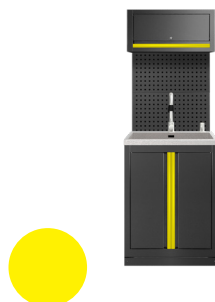
SERIE596Y

JOGO DE PUXADORES

18310

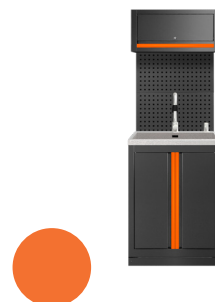
SERIE596O

JOGO DE PUXADORES

18311

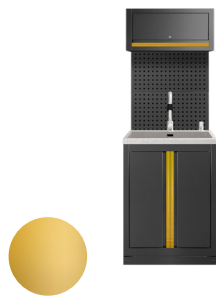
SERIE596G

JOGO DE PUXADORES

18312

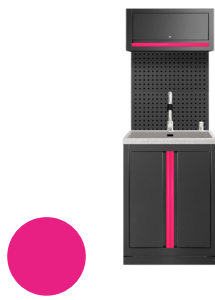
SERIE596P

JOGO DE PUXADORES

18313

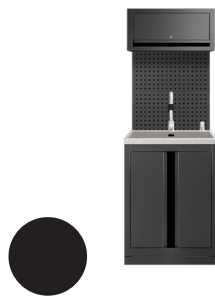
SERIE596K

JOGO DE PUXADORES

18314

SERIE596S

JOGO DE PUXADORES

18315



Os nossos conjuntos modulares são entregues com puxadores verdes de série, mas também recebe puxadores na cor que escolher dentro da nossa paleta. Assim, pode personalizar o seu conjunto de forma rápida e simples para combinar com as cores corporativas da sua oficina. Um método de personalização prático que o ajuda a manter a imagem profissional e coerente do seu espaço de trabalho.