

SERIE596

SET DE MOBILIER MODULAR (6PCS) – EXTENSIE DE DULAP
CU CHIUVEȚĂ (REF.18103)

ACERO
STEELINOX
SS

57,30Kg



INCLUDE

- | | | |
|----|-------|--|
| x1 | 16494 | DULAP DE PERETE |
| x2 | 16498 | PANOU PENTRU SCULE 680X340X25MM (REF. 54327) |
| x2 | 16561 | BARĂ SUPORT (REF.54327) |
| x7 | 18103 | DULAP CU CHIUVEȚĂ INTEGRATĂ |

Modulul include borduri frontale și laterale

JBM CAMPLLONG S.L.

CIM La Selva - Ctra. Aeropuerto, Km 1,6 Nave 2.2 CP 17185
Vilobí d'Onyar - GIRONA - ESB17419292 - SPAIN

www.jbmcamp.com
jbm@jbmcamp.com
+34 972 24 55 53

COMPONENTE

18103

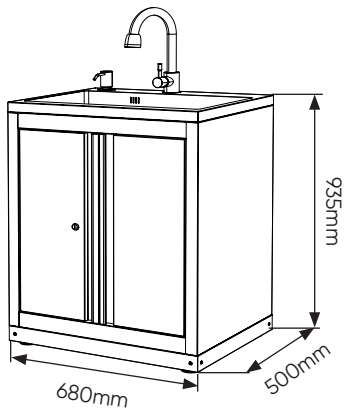
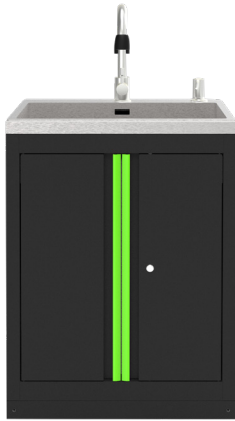

16494

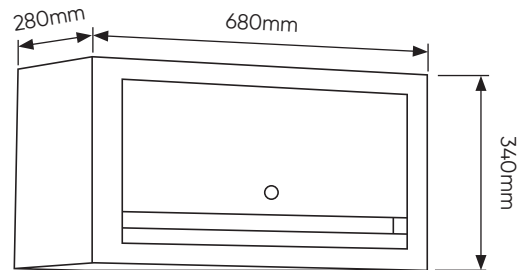

16561



16498

338x25x680mm



COMPONENTE

SERIE596

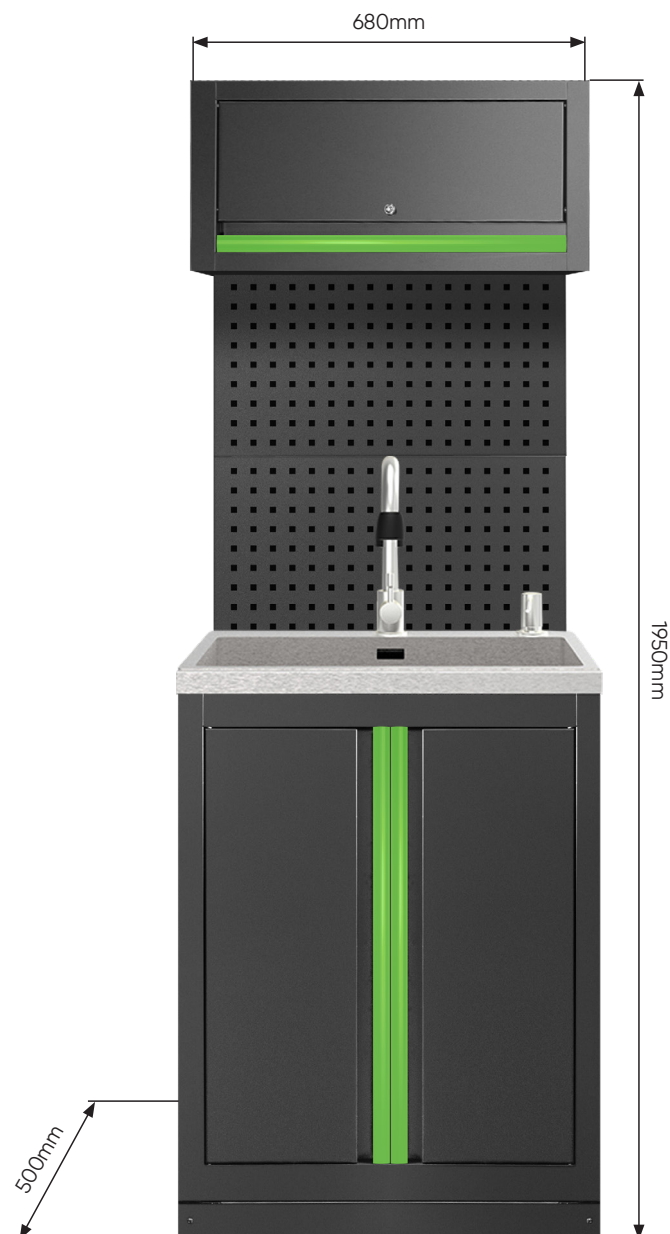

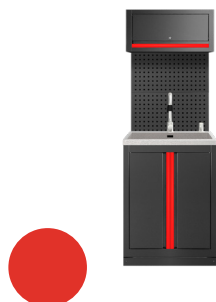
CULORI DISPONIBILE
SERIE596R

SET DE MÂNERE

18308

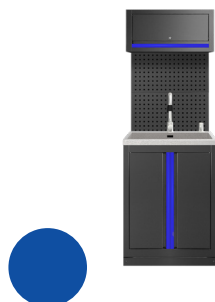
SERIE596B

SET DE MÂNERE

18309

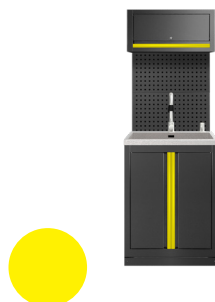
SERIE596Y

SET DE MÂNERE

18310

SERIE596O

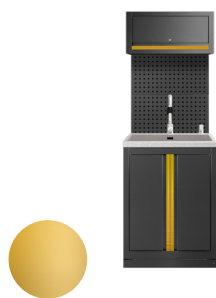

SET DE MÂNERE

18311

SERIE596G

SET DE MÂNERE

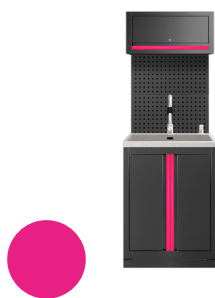
18312

SERIE596P

SET DE MÂNERE

18313

SERIE596K

SET DE MÂNERE

18314

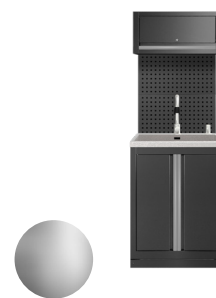
SERIE596S

SET DE MÂNERE

18315



Seturile noastre modulare sunt livrate cu mânere verzi standard, dar primești și mânere în culoarea aleasă din paleta noastră. Astfel, îți poți personaliza rapid și simplu setul pentru a se potrivi cu culorile corporative ale atelierului tău. O metodă practică de personalizare care te ajută să menții o imagine profesională și coerentă în spațiul tău de lucru.