

AUSTRALIAN PORK LIMITED

# Code of Practice

for On-farm Biogas Production and Use (Piggeries)

April 2015



APL Project 2011/1013.423, Code of Practice for On-farm Biogas Production and Use at Piggeries

Please cite this document as follows:

Australian Pork Limited (2015). *Code of practice for on-farm biogas production and use at piggeries*. APL Project 2011/1013.423.

**The following were author-contributors:**

Michael Yap. Prime Consulting International (Australia) Pty Ltd  
Stephan Tait. The University of Queensland/CRC for High Integrity Australian Pork  
Janine Price. Australian Pork Limited (APL)  
Rob Wilson. Rob Wilson Consulting/CRC for High Integrity Australian Pork  
Sam Ponder. Prime Consulting International (Australia) Pty Ltd  
Grant Jeffrey. Prime Consulting International (Australia) Pty Ltd  
Stephan Heubeck. National Institute of Water and Atmospheric Research Ltd (NIWA).  
Angus Davidson. Prime Consulting International (Australia) Pty Ltd

**Technical Review and Consultation:**

Office of Energy-Department of Natural Resources and Mines QLD  
Energy Safe Victoria  
Office of the Director of Gas Safety Tasmania  
Office of the Technical Regulator SA  
Department of Commerce-Energy Safety WA  
Gas Advisory Services Pty Ltd  
Safe Work SA  
Work Safe Vic  
Environment Protection Authority Victoria  
Environment Protection Authority SA  
Department of Environment and Regulation WA  
Primary Industries and Regions SA  
NSW Department of Primary Industries  
Department of Agriculture and Fisheries QLD  
Department of Agriculture and Food WA  
Adelaide University  
AQ ARQUA  
Australian Biogas group  
Quantum Power Ltd  
ADI Systems Asia Pacific  
Sunraysia Tafe  
Industry Capability Network  
Ian Connaughton consultant  
Producers: Edwina and Michael Beveridge, Tom Smith, Robert Nahkla, Andree Rowntree, Greg Kingston, Jeremy Whitby, Wil Beijnsens.

Disclaimer: The opinions, advice and information contained in this publication have not been provided at the request of any person but are offered by Australian Pork Limited (APL) solely for informational purposes. While APL has no reason to believe that the information contained in this publication is inaccurate, APL is unable to guarantee the accuracy of the information and, subject to any terms implied by law which cannot be excluded, accepts no responsibility for loss suffered as a result of any party's reliance on the accuracy or currency of the content of this publication. The information contained in this publication should not be relied upon for any purpose, including as a substitute for professional advice. Nothing within the publication constitutes an express or implied warranty, or representation, with respect to the accuracy or currency of the publication, any future matter or as to the value of or demand for any good.

## Table of Contents

<b>1.0</b>	<b>SCOPE AND GENERAL</b>	<b>2</b>
1.1	Scope	2
1.2	Exclusions	2
1.3	Biogas project overview	3
1.4	Referenced documents	5
1.5	Definitions	6
1.6	Risk matrix	11
<b>2.0</b>	<b>Design and Construction Considerations</b>	<b>13</b>
2.1	Pre-project considerations	13
2.2	Design considerations	13
2.2.1	Feedstock and feedstock storage	17
2.2.2	Construction materials	18
2.2.3	Digester design	19
2.3	Biogas transfer pipelines	20
2.4	Biogas storage	21
2.5	Biogas conditioning	21
2.6	Biogas flare	22
2.7	Biogas use equipment	24
2.8	Safety signage	25
<b>3.0</b>	<b>Commissioning, Operation and Maintenance Considerations</b>	<b>26</b>
3.1	Commissioning and start-up	26
3.2	Operation and maintenance	28
3.2.1	General risks	28
3.2.2	Biogas-specific safety	29
3.2.3	Hazardous chemicals	29
3.2.4	Maintenance	29
3.2.5	Information, training and instruction	30
3.2.6	First aid	30
3.2.7	Emergency plans	30
3.2.8	Monitoring and record keeping	30
<b>4.0</b>	<b>Environmental Protection</b>	<b>31</b>
4.1	Manure and digestate management	31
4.2	Noise	32
4.3	Odour control	32

4.4	Waste discharge	32
<b>5.0</b>	<b>References</b>	<b>33</b>
<b>Annex A:</b>	<b>Australian Regulators</b>	<b>35</b>
<b>Annex B:</b>	<b>Biogas Use Equipment</b>	<b>37</b>
<b>Annex C:</b>	<b>Biogas Conditioning Methods</b>	<b>38</b>
<b>Annex D:</b>	<b>Ventilation Criteria. Excerpt from AS/NZ60079.10.1:2009.</b>	<b>42</b>
<b>Annex E:</b>	<b>Examples of Zone Classification from the Safety Rules for Biogas Systems by the German Agricultural Occupational Health and Safety Agency (2008).</b>	<b>44</b>

## List of Tables

Table 1.1 Australian Standards that are referred to in this Code of Practice	5
Table 1.2 Typical properties of raw Australian piggery biogas	6
Table 1.3 Potential human health effects from short-term exposure to hydrogen sulphide	8
Table 1.4 Biogas project risk matrix	11
Table 2.1 Hazardous zone definition example	15
Table 2.2 Materials performance in contact with manure	18
Table 2.3 Materials performance in contact with biogas	18
Table A.1 Summary of State gas safety agencies	35
Table A.2 Summary of State environmental authorities	36
Table B.1 Substitution values for various energy applications of 1.5 m <sup>3</sup> biogas = ~ 1 m <sup>3</sup> CH <sub>4</sub>	37
Table C.1 Water vapour removal methods	38
Table C.2 Hydrogen sulphide (H <sub>2</sub> S) removal methods	40

## List of Figures

Figure 1.1 Typical components of a piggery biogas plant	4
Figure 2.1 Fence exclusion can clearly demarkate restricted access areas and related hazards	14
Figure 2.2 Example of a biogas blower at an Australian piggery rated to Zone I	15
Figure 2.3 Typical on-farm biogas spark-ignition flares in Australia	22
Figure 2.4 Emergency switches located outside an on-farm generator skid	24
Figure 2.5 Typical safety signage around an on-farm biogas plant	25
Figure 3.1 Measurement of biogas composition on-farm	27
Figure 3.2 Typical portable biogas/hydrogen sulphide safety detectors	29

## **1.0 SCOPE AND GENERAL**

### **1.1 Scope**

The Code of Practice (CoP) aims to provide a consistent framework and guidance for the safe design, construction, operation, and maintenance of biogas systems in order to facilitate greater uptake of biogas in the Australian Pork industry.

The CoP makes reference to international best practice and Australian regulations and standards relevant to biogas. This CoP is in support of and NOT an alternative to relevant State and Territory legislation and requirements. Users of this CoP are responsible for compliance with all peripheral and relevant legislation, including that which is not identified in this CoP. Users of this CoP should consult relevant regulatory authorities early in a biogas project, to ensure that all aspects of the project meet the relevant requirements.

The CoP uses a risk-based approach, identifying risks associated with on-farm biogas as well as potential options to mitigate those risks.

Due to a focus on on-farm installations, the scope of the CoP is limited to:

- a) the recovery of biogas from agricultural waste and by-products (primarily pig manure),
- b) at a rate of less than 500 m<sup>3</sup> of raw biogas per hour, that
- c) is conveyed or stored at pressures of less than 50 kPa; and
- d) that does not cross the boundary or title of land on which the biogas is produced (which may have additional regulatory requirements outside the scope of this CoP).

Where possible, the structure of the CoP followed the Standardisation Guide 006, Rules for the Structure and Drafting of Australian Standards.

### **1.2 Exclusions**

Whilst the CoP is tailored to circumstances and conditions most commonly encountered on-farm at piggeries, site-specific conditions must be considered. It is recognised that other site specific risks may exist and/or that other site specific controls and practices may better mitigate the risks.

The CoP doesn't deal with:

- a) feedstock handling – based on best on-farm practice of manure management;
- b) structural design of ponds/lagoons/tanks;
- c) general OH&S requirements - based on workplace health and safety legislation;
- d) environmental aspects not associated with the biogas project – covered by existing environmental legislation and the National Environmental Guidelines for Piggeries (2010 revised);
- e) high pressure and consumer applications of biogas or its derived energy, such as upgrading of biogas to a transport fuel or injection into a consumer gas network, or the specifics of grid connections and exports of electricity; and
- f) on-farm projects where biogas being produced is sold to a consumer.

Users of this CoP should be aware that biogas projects may be assessed in a manner outside the scope of this CoP.

### **1.3 Biogas project overview**

The relevant biogas project typically involves the production, movement, handling, processing and combustion of biogas on-farm for energy and/or destruction of methane and odour. Effluent is collected from pig sheds and pumped or gravity drained, with or without prior separation of coarse waste solids, into an anaerobic treatment system which produces the biogas. At piggeries, biogas can displace fossil-fuel derived energy used for heating (e.g. boilers), for electricity generation, for combined heat and power (CHP) or for other emerging applications. To increase the life of the biogas use equipment, corrosive ingredients and moisture in the biogas are often removed prior to using the biogas.

For a covered lagoon system, an impermeable cover over an anaerobic lagoon captures (and sometimes stores) the biogas that is produced. Importantly, the typical pressure under a cover on a lagoon is usually very low (50-100 Pascals maximum). Therefore a biogas blower is usually required to convey biogas from a covered lagoon to a flare or onsite biogas use equipment.

Figure 1.1 illustrates a basic schematic of the typical infrastructure of an on-farm piggery biogas project.

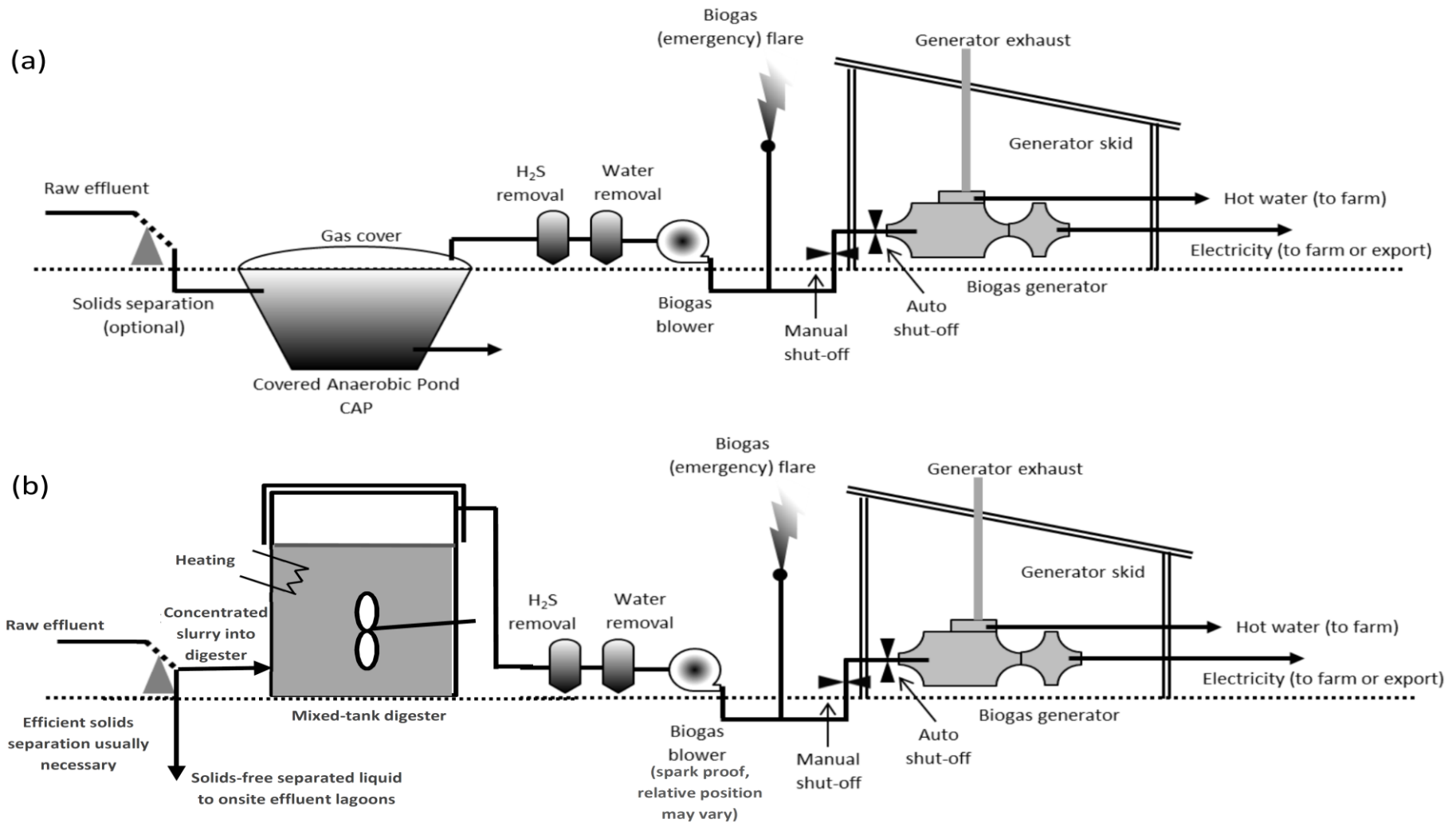

Figure 1.1 Typical components of a piggery biogas plant with a (a) covered anaerobic lagoon or (b) an above-ground mixed tank digester



#### 1.4 Referenced documents

Table I.1 lists Australian Standards that are referred to in this CoP. Users of this CoP shall consult the most current versions of the relevant standards which may be amended from time-to-time. Note that additional standards may be enacted by reference in the listed standards, for relevant circumstances.

Table I.1 Australian Standards that are referred to in this Code of Practice

Standards	Description
<b>AS 3814 (2010).</b>	Industrial and Commercial Gas-fired Appliances. Sets out minimum requirements for Type B appliances (see Definitions).  Note that a revised version exists for this standard (2015).  Appendix M of AS 3814 provides an informative (not a requirement) list of SIGNIFICANT HAZARDS which may be relevant for Type B appliances.
<b>AS 5601.1 (2013)</b>	Gas Installations – General Installations. Sets out minimum requirements for pipework, fittings and other matters relating to gas installations. Also referenced in AS 3814.
<b>AS 1375 (2013)</b>	Industrial Fuel-Fired Appliances – Could cover appliances which may not be explicitly covered by AS 3814, e.g. solar spark flares. Also referenced in AS 3814.
<b>AS 3000 (2007)</b>	Electrical installations (also known as the Australian/New Zealand Wiring Rules). Sets out minimum requirements for the electrical installations, including those of a biogas system. Note that hazardous area classification may be a separate related requirement.
<b>AS/NZS 60079.10.1 (2009)</b>	Explosive atmospheres - Classification of Areas - Explosive gas atmospheres. Sets out the requirements for classification of areas around a biogas system to exclude viable ignition sources from potentially explosive atmospheres.

## 1.5 Definitions

For the purpose of this CoP, the following definitions apply:

### 1.5.1 Anaerobic Digestion (AD)

The natural biological break down of organic matter (e.g. manure) in the absence of oxygen, producing raw biogas and other by-products (i.e. liquid and solid digestate).

### 1.5.2 Anaerobic Lagoon (AL)

An earthen structure that contains and treats piggery wastewater by anaerobic digestion.

### 1.5.3 Biogas - Composition and Properties

Biogas is a mixture of gases that is produced by anaerobic digestion. Table 1.2 presents typical properties of raw piggery biogas.

Table 1.2 Typical properties of raw Australian piggery biogas

	Biogas
Heating value (MJ/m <sup>3</sup> )	18-24 <sup>(a)</sup>
Density (kg/m <sup>3</sup> )	1-1.2 <sup>(b)</sup>
Explosive atmosphere range (as % by volume of biogas in air)	5-24 <sup>(c)</sup>
Raw biogas temperatures (°C)	10-70
Methane (CH <sub>4</sub> ) % by volume	60-70
Carbon dioxide (CO <sub>2</sub> ) % by volume	30-40
Hydrogen sulphide (H <sub>2</sub> S) % by volume	0.07-0.30
(a) Influenced by moisture and methane content.	
(b) Influenced by methane and carbon dioxide content.	
(c) The lower explosive limit for pure methane in air is 5% by volume, which was taken as a conservative estimate for piggery biogas. The upper explosive limit of 24% by volume in air reflects the dilution effect of carbon dioxide.	
Source: Ross, C.C. and Walsh, J.L. (1996). Handbook of Biogas Utilization. US Department of Energy.	

### 1.5.4 Biogas plant

Means the equipment and structures comprising the system for producing, storing, handling and using biogas.

### 1.5.5 Biogas scrubbing or conditioning

Is the partial or total removal of non-methane contaminants from biogas prior to use, such as particulates, and trace by-gases such as hydrogen sulphide (H<sub>2</sub>S), water and ammonia (NH<sub>3</sub>). Biogas scrubbing or conditioning is often done to protect a biogas plant.

### 1.5.6 Buffer distance

The distance provided between the piggery complex or reuse areas and sensitive natural resources (e.g. bores, watercourses and major water storages), as an important secondary measure for reducing the risk of environmental harm.

### 1.5.7 CHP unit

A combined heat and power (CHP) unit simultaneously produces electricity and heat.

### 1.5.8 Co-digestion

Refers to the anaerobic digestion of additional organic materials together with manure, usually to produce more biogas. For a lagoon-based biogas plant, options for co-digestion may be limited to liquid/fluid organic co-substrates.

#### *1.5.9 Co-generation*

Energy conversion process, whereby more than one utility is derived from a particular energy resource such as biogas. Biogas co-generation typically entails simultaneous electricity generation and waste heat recovery in the form of hot water.

#### *1.5.10 Contaminant*

A contaminant is a foreign unwanted substance (biological, chemical or physical) in a material (e.g. feedstock, biogas).

#### *1.5.11 Covered Anaerobic Pond (CAP)*

An anaerobic lagoon fitted with an impermeable cover which captures biogas, to reduce odour and GHG emissions, and/or to make biogas available for energy. Covers can be full perimeter or partial floating or a combination.

#### *1.5.12 Desludging*

Removing settled solids from an effluent lagoon.

#### *1.5.13 Digestate*

A by-product of anaerobic digestion which can be used as fertiliser and/or as a soil conditioner.

#### *1.5.14 Digester (reactor, fermenter)*

Refers to a covered lagoon (mixed or unmixed) or an above-ground tank which contains the anaerobic digestion and captures the biogas being produced.

#### *1.5.15 Electrical worker*

A licensed person who carries out electrical work.

#### *1.5.16 Emergency service*

Means ambulance, fire, police or other emergency service.

#### *1.5.17 Environmental Management Plan (EMP)*

An EMP focuses on the general management of the whole farm, taking into account the environment and associated risks. It documents design features and management practices; identifies risks and mitigation strategies; includes ongoing monitoring requirements to ensure impacts are minimised; and processes for continual review and improvement.

#### *1.5.18 Equipment*

Includes fittings, fixtures, appliances and devices.

#### *1.5.19 Explosive limits*

If the concentration of biogas in air is between the lower explosive limit (LEL) and the upper explosive limit (UEL), the biogas-air mixture is flammable. At concentrations above the UEL, the gas mixture is deprived of oxygen, and below the LEL it is deprived of fuel. For biogas in air, a conservative LEL is 5% biogas by volume, and a conservative UEL is 24% biogas by volume (refer to Table 1.2).

#### *1.5.20 Feedstock*

The feedstock (sometimes also known as substrate or input) is the reagent of anaerobic digestion. A feedstock can be a mixture.

### 1.5.21 Flare

A device for the safe combustion of biogas that does not yield usable energy.

### 1.5.22 Gas fitter

A licensed person who carries out gas fitting work. Note that licensed gas fitters may not be aware of the unique dangers of biogas (e.g. hydrogen sulphide).

### 1.5.23 Gas storage

Container or membrane bag in which biogas is stored (can also be the headspace under the cover of a covered lagoon).

### 1.5.24 Gastight

The condition of a gas installation where any leakage of gas is at a sufficiently low level to not cause any significant hazard.

### 1.5.25 Greenhouse gases (GHG)

Greenhouse gases have a global warming potential. Relevant GHG's are carbon dioxide, methane and nitrous oxide.

### 1.5.26 Hazard

A hazard is a source or a situation with a potential to cause harm in terms of human injury or ill-health, damage to property, damage to the environment, or a combination of these. Hazards can include objects such as machinery or dangerous chemicals, or unsafe work practices.

### 1.5.27 Hydrogen sulphide (H<sub>2</sub>S)

Hydrogen sulphide is a minor gas ingredient of raw piggery biogas. Hydrogen sulphide poses a major health hazard. Table 1.3 summarises some of the potential health effects of hydrogen sulphide.

Table 1.3 Potential human health effects from short-term exposure to hydrogen sulphide

Hydrogen sulphide content of a gas mixture (parts per million)	Human health effects after short term exposure
<b>0.003–0.02</b>	detectable “rotten egg” odour
<b>10*</b>	causes eye irritation and chemical changes to blood and muscle tissue
<b>100</b>	causes loss of sense of smell so an exposed person does not know that conditions are dangerous
<b>320–530</b>	causes fluid accumulation in the lungs with risk of death
<b>500–1000</b>	causes rapid breathing then loss of breathing
<b>1000</b>	causes nervous system failure
<b>700–3000</b>	typical concentration in piggery biogas - causes nervous system failure

\*Warning alarms on many handheld gas safety detectors are set at 10ppm signifying safe short term exposure levels.  
Sources: Department of Health New York USA. Health Effects from Inhalation of Hydrogen Sulfide; Skrtic, L. Hydrogen Sulfide, Oil and Gas, and People's Health. 2006.

### 1.5.28 IEC

The International Electro-technical Commission through the IEC Ex is an international certification scheme that rates explosion hazards. It covers equipment certification and zone classification. Certificates issued under this scheme are accepted by all member countries including Australia.

*1.5.29 Kilowatt hour (kWh)*

A common measure of (electrical) energy, equal to 1kW of power applied for a 1-hour period. 1 kWh = 3.6 MJ.

*1.5.30 Liquid manure storage*

Containers (includes tanks, lagoons and ponds) either in-ground or above-ground, in which liquid manure, slurry or digestate is stored.

*1.5.31 May (also Could)*

Indicates an option.

*1.5.32 Manure*

Animal faeces plus urine and may contain spent bedding, waste feed and water.

*1.5.33 Manure Guidelines*

Refers to APL project 2012/1028 Piggery Manure and Effluent Management and Reuse Guidelines 2015.

*1.5.34 Mesophilic*

Refers to anaerobic digestion at temperatures of around 30 - 45°C.

*1.5.35 National Environmental Guidelines for Piggeries (NEGP)*

Refers to the most up-to-date version of the National Environmental Guidelines for Piggeries. At the time of publishing it is the National Environmental Guidelines for Piggeries Second Edition Revised (Tucker et al., 2010).

*1.5.36 Nutrient*

A food essential for cell, organism or plant growth.

*1.5.37 On-farm/farm*

An area of land and its buildings used for growing crops and rearing animals, typically under the control of an owner or manager.

*1.5.38 Permeability*

Refers to the ability of a soil layer or barrier to transmit water, liquids or gases. For most components of a biogas system, low permeability is desired to prevent uncontrolled release.

*1.5.39 Psychrophilic*

Refers to anaerobic digestion at temperatures below about 30°C.

*1.5.40 Receptor*

A Receptor is a person or site that receives and is sensitive to community amenity impacts, including a residential dwelling, school, hospital, office or public recreational area.

*1.5.41 Reuse areas*

Refers to land areas where by-products such as digestate are spread for the purpose of using the nutrients and water they contain for crop or pasture growth.

*1.5.42 Risk*

A risk arises when it is possible that a hazard will cause harm. In relation to any potential injury or harm, the risk is the likelihood and consequence of that injury or harm occurring.

#### *1.5.43 Risk assessment*

A risk assessment is a process of identifying hazards and analysing or evaluating their associated risk, and identifying appropriate ways to eliminate or reduce the risk.

#### *1.5.44 Safety Management Plan*

A safety management plan documents aspects of safety associated with a biogas project, including a detailed description of plant and operations pertaining to safety, record keeping with regards to safety, safety governance arrangements, a comprehensive and systematic risk assessment, identification of skilling and training, and identification of interactions with other plants or projects pertaining to safety. An example is *Australian Pork Limited, Gas Safety Management Plan Template VI* (available from Australian Pork Limited or [www.australianpork.com.au](http://www.australianpork.com.au)).

#### *1.5.45 Setbacks*

A setback is the minimum required distance between any two points of interest.

#### *1.5.46 Separation distance*

The distance provided between the piggery complex and sensitive receptors as an important secondary measure for reducing the risk of negative amenity impacts. Separation distances are measured as the shortest distance between the piggery complex and the nearest part of a building associated with the receptor site land use.

#### *1.5.47 Shall*

Indicates a mandatory requirement.

#### *1.5.48 Should*

Indicates a recommendation.

#### *1.5.49 Sludge*

The accumulated solids separated from piggery effluent by gravity settling during normal treatment and storage.

#### *1.5.50 State*

Means an Australian State or Territory.

#### *1.5.51 Standard conditions pertaining to a gas*

Standard conditions refer to a temperature of 15°C and a pressure of 101.325 kPa (NGER, 2008).

#### *1.5.52 Supernatant*

Refers to a liquid layer above a sediment or settled precipitate (e.g. sludge).

#### *1.5.53 Thermophilic*

Refers to anaerobic digestion at temperatures of around 45 - 70°C.

#### *1.5.54 Type B appliance*

An appliance with gas consumption in excess of 10 MJ/h (about 0.5 m<sup>3</sup>/h biogas flow), for which a certification scheme does not exist.

#### *1.5.55 Waste discharges*

Are categorised as discharges of solid waste, effluent or air emissions.

#### *1.5.56 Zones*

Potentially explosive areas are classified into zones according to the probability of the occurrence of a potentially explosive atmosphere in accordance with AS/NZS 60079.10.1: Explosive atmospheres - Classification of areas - Explosive gas atmospheres.

## 1.6 Risk matrix

This CoP is compiled around the risk matrix presented in Table 1.4.

Table 1.4 Biogas project risk matrix

Project Element	Risk Description	CoP Section
<b>Design and construction considerations</b>		
<b>Pre-project considerations</b>	a) Unrealistic expectations; b) Inappropriate designs/project; c) and poor communication during planning and approvals phase, leading to unsafe and non-compliant projects.	2.1
<b>Design considerations</b>	a) Risk of unintended biogas release posing a hazard, e.g. fire, explosion and intoxication b) Risks associated with unauthorised and unsafe access to biogas plant/equipment	2.2
<b>Feedstock and feedstock storage</b>	a) Inappropriate feedstock leading to inhibition of anaerobic digestion and/or environmental risks and/or safety risks b) Fermentation of feedstock prior to entering a digester, causing odour or safety issues	2.2.1
<b>Construction materials</b>	a) Using inappropriate materials of construction leading to a safety or environmental risk	2.2.2
<b>Digester design</b>	a) Digesters are inappropriate for their feedstock and situation, and pose a hazard	2.2.3
<b>Biogas transfer pipelines</b>	a) Leaking of biogas producing flammable mixtures or hazardous exposure b) Condensate or entrained solids causing blockages and unsafe conditions c) Unsafe venting of biogas leading to hazardous exposure	2.3
<b>Biogas storage</b>	a) Inappropriate biogas storage systems which pose a hazard b) Biogas storage become excessively pressurised or bloated, leading to structural failure, a substantial biogas release, and hazardous conditions c) Hazardous exposure to vented biogas	2.4
<b>Biogas conditioning</b>	a) Condensate or entrained solids causing blockages b) Unconditioned biogas causing structural failure of the biogas plant and unsafe conditions c) The conditioning systems posing a safety risk or environmental risk	2.5
<b>Biogas flare</b>	a) Direct venting of unburnt biogas posing a hazard b) Ingress of air and ignition causing a fire c) Flare operation causing a fire	2.6
<b>Biogas use equipment</b>	a) Biogas use equipment posing a hazard	2.7
<b>Safety signage</b>	a) The risk of persons walking around a biogas plant being unaware of hazards and required personal protective equipment	2.8

Table 1.4 continues on the following page

<b>Project Element</b>	<b>Risk Description</b>	<b>CoP Section</b>
<b>Commissioning, operation and maintenance considerations</b>		
<b>Commissioning and start-up</b>	<ul style="list-style-type: none"> <li>a) Unfinished/untested biogas plants being commissioned</li> <li>b) Safety risk associated with transient explosive gas mixtures during start-up/commissioning</li> </ul>	3.1
<b>Operation and maintenance</b>	<ul style="list-style-type: none"> <li>a) Non-biogas related health and safety issues, such as falls, entanglement, electrical and noise associated with operation and maintenance of a biogas plant</li> <li>b) Biogas-specific risks associated with operation and maintenance of a biogas plant, such as the flammability of methane in biogas, the toxicity of trace gases such as hydrogen sulphide (H<sub>2</sub>S) and ammonia in raw biogas, and the asphyxiation risk with displacement of oxygen by raw or treated biogas in poorly ventilated spaces</li> </ul>	3.2
<b>Hazardous chemicals</b>	<ul style="list-style-type: none"> <li>a) Unsafe use of hazardous chemicals</li> </ul>	3.2.3
<b>Maintenance</b>	<ul style="list-style-type: none"> <li>a) Biogas equipment and piping posing a hazard during maintenance</li> </ul>	3.2.4
<b>Environmental protection</b>		
<b>Manure and digestate management</b>	<ul style="list-style-type: none"> <li>a) Imported material for co-digestion introducing new environmental risks to the operation, including contamination and biosecurity risks</li> <li>b) Imported materials complicating nutrient (and salt) management at the farm</li> <li>c) Environmental hazards associated with manure/feedstock handling</li> <li>d) Unintended fugitive emissions (leakage)</li> <li>e) Concentrated waste (nutrient) discharges (manure, digestate) from storage facilities</li> <li>f) Nutrient loads in digestate and sludge being estimated incorrectly or poor digestate management, leading to problems with excessive application of nutrients to land</li> </ul>	4.1
<b>Noise</b>	<ul style="list-style-type: none"> <li>a) Potential for noise nuisance associated with the biogas plant</li> </ul>	4.2
<b>Odour control</b>	<ul style="list-style-type: none"> <li>a) Potential for odour nuisance associated with the biogas plant</li> </ul>	4.3
<b>Waste discharge</b>	<ul style="list-style-type: none"> <li>a) Hazardous materials required for the operation of a biogas plant (e.g. generator motor oil, biogas filter media) becoming new environmental risks</li> </ul>	4.4



## 2.0 Design and Construction Considerations

### 2.1 Pre-project considerations

What risks does this section aim to manage/eliminate:

- a) Unrealistic expectations;
- b) inappropriate design/project; and
- c) poor communication during planning and approvals phase, leading to unsafe and non-compliant projects.

Project planning should include (but not be limited to):

- a) Consultation: It is strongly recommended that local authorities and state-based regulators be consulted early on in the planning phase to seek further information and clarification about requirements. For reference, Annex A summarises gas safety regulations. Regulations may be amended from time-to-time and projects should meet the most up-to-date requirements.
- b) Feedstock evaluation: The feedstock should be evaluated with respect to digester technology selection and potential impacts on digester operation (refer Section 2.2.1). Management of digestate should be incorporated into existing manure management and reuse practices (refer to NEGP).
- c) Consideration of potential discharges from the biogas plant, including flaring, boilers, cogeneration equipment, and other biogas appliances.

### 2.2 Design considerations

What risks does this section aim to manage/eliminate:

- a) Risk of unintended biogas release posing a hazard, e.g. fire, explosion and intoxication
- b) Risks associated with unauthorised and unsafe access to biogas plant/equipment

The following represents a checklist of general considerations for biogas plant design:

- a) Availability of suitably qualified technical support;
- b) Requirements of state-based regulators and other relevant stakeholders;
- c) Requirements of relevant standards and codes;
- d) Safe access for operation and maintenance, including access to equipment, access to sludge, treated effluent and biogas, and access for sampling as required;
- e) Wherever possible, maintenance and work platforms, as well as operating parts of agitators, pumps, and purging devices, should be placed at ground level;
- f) Restricting unauthorised access where relevant: Fence exclusion may be considered (see Figure 2.1 for an example);
- g) Selecting suitable materials of construction (see Section 2.2.2);
- h) Appropriate level of automation and control;
- i) Equipment fail safe devices, including emergency shut-off as appropriate, emergency flare(s), clear identification and safe access to safety systems, and back-up power for essential services;
- j) Access to hazardous mechanical and electrical components should be restricted and clearly and unambiguously marked with warning signs (e.g. guards or within locked switchboards);
- k) Noise damping should be a standard feature of the design of noisy plant;
- l) Ring buoys, ropes, or ladders at open manure structures should be available where there is a significant drowning risk.

Some of these design aspects are further considered in the sections that follow. Note that a safe design includes appropriate infrastructure (e.g. emergency flare) as well as appropriate administration (procedures, training) to reduce the risk of harm to humans and the environment.



Figure 2.1 Fence exclusion can clearly demarkate restricted access areas and related hazards

(Photos courtesy of the Pork CRC)

*Plant layout:* The infrastructure of a biogas plant is similar to agricultural waste storage facilities, on-farm storage facilities, silos and on-farm fuel storages. Section 6 of NEGP provides guidance for piggeries on recommended buffer distances for surface water and groundwater and separation distances for community amenity. Section 10 of NEGP provides guidance on preventing releases to surface water and groundwater. An on-farm biogas plant will generally not be in a public place so access to dangerous goods would generally be controlled, but should be considered in the design. As noted above, all digester and equipment siting and sizing should consider safe access for maintenance of the plant. The project may consider fence exclusion as a means of preventing unauthorised access or damage to equipment. Safety signage should clearly identify hazards where appropriate (e.g. also including management practices, such as no smoking/no naked flame signs to exclude ignition sources and no unauthorised entry signage) (see Figure 2.1 for an example).

Fence exclusion, safety signage and gas-detection should be considered in a site-specific risk assessment, because these risk mitigation options may vary with site-specific requirements.

*Biogas-specific hazards – Flammability/Explosion:* Biogas is flammable and poses an explosion hazard. The designer should consider opportunities to reduce the risk of build-up of flammable or dangerous gas atmospheres around biogas equipment and piping, e.g. via open skids, well-ventilated shelters or isolation, e.g. *Annex D - Example of Adequately Vented Shelter* provides a relevant excerpt from AS/NZS 60079.10. The designer shall provide appropriate setback around biogas equipment and piping to exclude viable ignition sources. Hazardous area or zone classification is a method by which electrical equipment is selected with appropriate protection for installation in potentially explosive environments (e.g. Figure 2.2). In Australia, AS/NZS 60079.10 states the requirements for hazardous zone classification (e.g. Table 2.1). The Safety Rules for Biogas Systems by the German Agricultural Occupational Health and Safety Agency (2008) is noted as a useful guidance document in this regard, because it is more stringent than AS/NZS 60079.10 and can be easier to apply in a farming context. *Annex E - Examples of Zone Classification* provides examples from the German document.

Table 2.1 Hazardous zone definition example

<p><b>AS/NZS 60079.10 Explosive atmospheres - classification of areas - explosive gas atmospheres</b> (Replaces AS 2430.3.1)</p> <p>Explosive gas atmospheres are subdivided into zones as follows:</p> <p><b>ZONE 0</b> - In which an explosive atmosphere is present continuously, or is expected to be present for long periods, or for short periods which occur at high frequency. (More than 1000 hours per year)</p> <p><b>ZONE 1</b> - In which an explosive gas atmosphere can be expected to occur periodically or occasionally during normal operation. (More than 10 hours per year but less than 1000 hours per year)</p> <p><b>ZONE 2</b> - In which an explosive gas atmosphere is not expected to occur in normal operation and when it occurs is likely to be present only infrequently and for short duration. (Less than 10 hours per year)</p>
--

Source: AS/NZS 60079.10 Explosive Gas Atmospheres - for full definitions refer to the Standard.

**IMPORTANT:** Explosion-proof equipment (e.g. biogas blower) shall be appropriately certified to IEC or Australian standards via an acceptable certification scheme (see Figure 2.2 for Example).



Figure 2.2 Example of a biogas blower at an Australian piggery rated to Zone 1  
(Photos courtesy of the Pork CRC)

The responsibility of hazardous area classification rests with the person(s) or organization(s) in control of the (biogas) installation, which in this case might be the farm occupier, owner or biogas system operator. A hazardous area classification should be performed and documented by a competent individual or organization who can demonstrate appropriate technical knowledge and relevant skills to perform the hazardous area assessment. The person(s) or organization(s) in control of the (biogas) installation is(are) often guided by the original equipment manufacturer in terms of equipment and its classification. For the area that the biogas installation is in, the person(s) or organization(s) in control may need to delegate the preparation of the hazardous area documentation to an expert body or organization. For Type B appliances, the responsible Type B gasfitter, with advice from the equipment manufacturer, would be a competent person.

**NOTE** that, in accordance with Annex ZA.6.2.2 in AS/NZS 60079.10.1:2009, hazardous area classification may not be required in cases where:

- a) compliance with relevant standards (e.g. AS 3814 and AS 5601) and codes, ensures containment of the biogas supplies to the extent that reasonably foreseeable leaks are negligible (a gastight installation); and
- b) in accordance with Annex ZA.6.2.2 in AS/NZS 60079.10.1:2009, the installation is within a consumer premises and NOT;
  - within the exclusion zone of a pressure relief device and vent pipe discharge points,
  - within poorly ventilated pits/below ground enclosures containing gas equipment, and
  - other relevant exceptions in Annex ZA.6.2.2 in AS/NZS 60079.10.1:2009.

Also note that hazardous area classification would probably be required if gas supply pressures exceed 200kPa or gas consumption exceeds 10GJ/h (above about 500m<sup>3</sup>/h of biogas, which falls outside the scope of this CoP).

Lastly, note that if electrical workers or electrical inspectors have any concerns, they have a right and indeed a responsibility, to request a hazardous area assessment from the person or organization in charge of the biogas installation.

#### *Biogas-specific hazards – Toxic Hydrogen sulphide (H<sub>2</sub>S):*

Hydrogen sulphide is a minor gas ingredient of raw piggery biogas but has the potential to be a major health hazard as outlined in Table I.3.

**IMPORTANT:** A unique danger of hydrogen sulphide is that, while it has a distinct rotten egg smell (which blends with other odours), it numbs the sense of smell at reasonably low concentrations (Table I.3). Consequently, a person being exposed to dangerous levels of hydrogen sulphide may not be aware of the danger. In this regard, fixed gas-detectors with hydrogen sulphide detection with alarms can warn of dangers in poorly ventilated areas, and portable gas-detectors with hydrogen sulphide detection should accompany or be worn by persons working in close vicinity to the biogas plant.

**IMPORTANT:** Hydrogen sulphide is denser than air and can collect to dangerous levels in low-lying areas and even in poorly ventilated open-top tanks.

### 2.2.1 Feedstock and feedstock storage

What risks does this section aim to manage/eliminate:

- a) Inappropriate feedstock leading to inhibition of anaerobic digestion and/or environmental risks and/or safety risks
- b) Fermentation of feedstock prior to entering a digester, causing odour or safety issues

Key considerations for feedstock of relevance to piggeries are:

- Flush manure
  - Some antimicrobials and chemicals can affect the microbial population and subsequent digester health.
  - Biogas yields are directly related to the amount of biodegradable organic matter entering the digester and biogas production can be boosted with additional organic matter. However, organic or hydraulic overload can upset the balance of the digestion process and can cause digester failure.
  - Selection of a suitable digester type should consider the solids content and organic strength of a feedstock.
  - **NOTE** that a wide range of other on-farm wastes such as feed wastage or by-products may also enter the digester, and should be considered in digester load calculations and load management.
  
- Handling and storage
  - NEGP recommends the collection and transfer of effluent from shed to treatment facilities with minimal odour generation and no releases to surface water or ground water. In this regard, long collection intervals or storage times prior to entering a digester can lead to pre-fermentation, fugitive gas emissions and odour.
  - Pits or tanks can be established when storage or mixing is needed prior to digestion, however, storage time should be minimized.
  
- Contaminants
  - All feedstock should be free of foreign materials that can block pipelines, pumps, and other relevant equipment, or can accumulate under the cover of a covered anaerobic pond. Screens, sand traps and pro-active management can reduce problems associated with such foreign materials.
  - Off-farm materials intended for co-digestion carry increased biosecurity and contaminant risks (e.g. heavy metals) and fall outside the scope of this CoP.

### 2.2.2 Construction materials

What risks does this section aim to manage/eliminate:

- |   |
|---|
| a) Use of inappropriate materials of construction leading to a safety or environmental risk |
|---|

Materials of components around a biogas plant are exposed to harsh conditions. Both raw effluent and digestate can be corrosive. The trace amounts of hydrogen sulphide (H<sub>2</sub>S) in raw piggery biogas (Table 1.3) can be highly corrosive. Materials of components around a biogas plant, such as a lagoon cover and pipework, must provide appropriate thermal, UV and chemical resistance. Careful selection of materials of construction is important. Table 2.2 presents an overview of typical materials performance with respect to manure or digestate. Table 2.3 provides an overview of typical materials performance in contact with biogas.

Selection of pipework and components (including materials of construction) shall consider operating pressures and temperatures. For instance, the boosting/compression of biogas for conveyance or the radiative heat under the cover of a CAP can substantially increase biogas temperatures which may influence the structural strength of plastics (temperatures as high as 65°C have been reported for biogas under a black HDPE cover). Cooling of the biogas prior to conveyance can help in this regard.

**NOTE:** Section 4 of AS5601 does not permit above-ground use of plastic pipework or fittings. Therefore, plastic biogas pipework above-ground would probably require an exemption under a performance-based design in accordance with Section 2 of AS5601. Note that the means of compliance with Section 2 of AS5601, that is, a performance-based design, must achieve a level of safety, convenience and efficiency of operation which is not less than an installation carried out to Sections 3 to 6 in AS5601. Note also that the Technical Regulator may require written design specifications and drawings together with sound justification for a deviation of the means of compliance specified in Sections 3 to 6 of AS5601.

Table 2.2 Materials performance in contact with manure

Material Status	Material List
<b>Recommended</b>	Polyethylene, polypropylene (PP), UV resistant PVC effluent piping. Most stainless steel grades, Clay, Concrete.
<b>Not recommended</b>	Copper, brass and aluminium. Uncoated steel other than stainless steel. PVC shall not be used for lagoon liners or covers. Polypropylene shall not be used when significant quantities of fats and oils are present (e.g. whey).

Table 2.3 Materials performance in contact with biogas

Material Status	Material List
<b>Recommended</b>	Plastic pipework and fittings below-ground e.g. polyethylene, PVC, or polypropylene (only if no fat is present in wastes being digested). Most stainless steel.
<b>Not recommended</b>	Copper, Steel other than stainless steel, Brass, Traditional butyl rubber. Galvanized iron. Plastic pipework and fittings above-ground.

### 2.2.3 Digester design

What risks does this section aim to manage/eliminate:

- |   |
|---|
| a) Digesters are inappropriate for their feedstock and situation, and pose a hazard |
|---|

Solids accumulation, sludge management and nutrient and digestate reuse should be considered during the design phase. There are a range of sludge management options, e.g. sludge extraction pipework, intermittent mixing to maintain suspension, sizing for long-term sludge accumulation.

To prevent structural damage to a cover on a CAP or erosion of the lagoon bank, the design of the cover should consider controlled rainwater conveyance off the cover. An array of rainwater ballast/guidance pipes can direct rainwater to a sump for pumping. Such ballast pipes can be filled with water or sand or other materials to provide the necessary weight. However, water filling may provide greater flexibility because the water contents in the ballasts can be drained or refilled as required, e.g. during maintenance. Ballast pipes can also reduce adverse exposure of the cover to wind.

Where CAPs are constructed as a retrofit of an existing lagoon, the reduced evaporative water loss off the surface of the formerly uncovered existing lagoon needs to be considered in a revised site water balance. This may also be important where uncovered lagoons are superseded by a digester.

All CAPs, digestate storage structures and effluent collection systems need to be tightly sealed to prevent effluent seepage. A permeability requirement of  $1 \times 10^{-9}$  m/s applies to all manure structures as a legal requirement in most states of Australia. Furthermore, all structures need to be structurally sound and pose no environmental risk in accordance with Section 12.1 of NEGP.

Emergency and maintenance events may require a bypass pipeline around the digester or CAP (e.g. from shed to a secondary lagoon) as well as emergency storage/treatment capacity.

For monitoring purposes, the design of CAPs and digesters should provide safe access to sample sludge, treated effluent and biogas.

Although the covers on CAPs may appear rigid enough to support the weight of an adult, the cover material and installation may not be rated as trafficable. Persons should be made fully aware of the immediate danger to life and health of the hydrogen sulphide levels in the raw biogas under a cover.

### 2.3 Biogas transfer pipelines

What risks does this section aim to manage/eliminate:

- a) Leaking of biogas producing flammable mixtures or hazardous exposure
- b) Condensate or entrained solids causing blockages and unsafe conditions
- c) Unsafe venting of biogas leading to hazardous exposure

AS5601 details comprehensive requirements for biogas pipework and fittings, including burial requirements for underground pipework.

In accordance with good agricultural practice and on-farm biogas installations:

- a) Biogas pipelines should be labelled as carrying a fuel gas (which may include colour-coding yellow). Care shall be taken to not compromise the structural integrity of the piping materials by this labelling/coding.
- b) On-farm biogas pipelines should be operated at pressures below 50kPa.
- c) Pipelines shall be installed by a licensed gas fitter who is aware of the unique risks associated with biogas and the precautions required (e.g. carrying a hydrogen sulphide gas detector).
- d) Appropriate integrity checks shall be carried out (and documented) before pipelines are commissioned.
- e) Where condensate is likely to form, biogas transfer pipelines shall be installed with an appropriate fall to a low point (e.g. 2% and care taken to prevent sagging in pipework) and a safe drainage point shall be provided for removal of the condensate.
- f) Buried pipework should have a length allowance for expansion and contraction.
- g) The pipework may have pressure or other test points at regular intervals as a means of detecting blockages or leaks of biogas flow (see *Commissioning* below).
- h) Allowance should be made for safe purging/venting of biogas-air mixtures contained in-pre-commissioned pipework, fittings and equipment.
- i) ANY BIOGAS VENT SHALL BE LOCATED IN A SAFE PLACE TO PREVENT HAZARDOUS EXPOSURE (e.g consider above head height). This includes condensate drainage points which may vent biogas inadvertently.
- j) AS3814 outlines requirements for piping and valving associated with Type B appliances, including emergency shut-off systems, bleed lines and pressure protection.

**IMPORTANT:** Persons who are licensed to perform fuel-gas installations and maintenance may not be aware (and need to be made aware) of the unique dangers of biogas, especially hydrogen sulphide.



## 2.4 Biogas storage

What risks does this section aim to manage/eliminate:

- a) Inappropriate biogas storage systems which pose a hazard
- b) Biogas storage become excessively pressurised or bloated, leading to structural failure, a substantial biogas release, and hazardous conditions
- c) Hazardous exposure to vented biogas

The gas headspace of a CAP could provide sufficient biogas storage to accommodate short maintenance periods or facilitate advanced biogas usage (e.g. peak demand generation). However, the cover on a CAP can become dangerously bloated at relatively low pressures (e.g. 50-100Pa), which can cause dislodgement of ballasts, adverse exposure to wind, or other dangerous scenarios. To prevent unsafe elevated pressures, biogas storage shall allow for emergency biogas venting. The location and height of a vent (e.g. above head height) shall prevent hazardous exposure to biogas. A flare can be a suitable venting option, if appropriately located. Biogas storage can be protected from wind damage through suitable restraining (such as appropriately positioned ballasts on the cover of a CAP).

## 2.5 Biogas conditioning

What risks does this section aim to manage/eliminate:

- a) Condensate or entrained solids causing blockages
- b) Unconditioned biogas causing structural failure of the biogas plant and unsafe conditions
- c) The conditioning systems posing a safety risk or environmental risk

To protect pipework and equipment, raw piggery biogas may need to be conditioned prior to conveyance and use. The management of condensate in biogas pipelines is dealt with in Section 2.3. With respect to cooling of a biogas for drying, the dew point temperature of a dried biogas should be several °C below the minimum expected temperature throughout the biogas transfer pipelines. Trace amounts of hydrogen sulphide in raw piggery biogas can be highly corrosive and pose a substantial health hazard (Section 2.2). Hazardous areas and electrical equipment (e.g. chillers) are discussed in Section 2.2.

Annex B: Biogas Conditioning Methods lists some of the available biogas conditioning options. Two technologies are noted here for their potential secondary safety risks:

1. Solid iron-based filter media (“iron sponge”) are commonly used to remove hydrogen sulphide. The vessel containing the media should be fitted with a safely located condensate drain (see Section 2.3), and with easy and safe access to change over the solid media. **NOTE** that iron-based filter media can release significant quantities of heat when exposed to air for regeneration. This heat can melt plastic equipment.
2. One type of biological scrubbing involves the addition of small quantities of oxygen (as air) to biogas (micro-aeration) to induce a biochemical reaction that removes hydrogen sulphide. This is a common (and can be cost-effective) approach and is on offer by a number of technology providers. However, **NOTE** that the **uncontrolled** addition of air to biogas is **dangerous** and can lead to explosive atmospheres. In cases where biological scrubbing is used, the associated safety risks shall be strictly mitigated by appropriate design, operation and monitoring.

Selection of a suitable scrubbing media should consider potential environmental impacts of disposal when spent. Condensate can often be recycled into downstream treatment lagoons, but not into a CAP because the sulphur entrained in the condensate can reform into hydrogen sulphide which exacerbates hydrogen sulphide in the biogas.

## 2.6 Biogas flare

What risks does this section aim to manage/eliminate:

- a) Direct venting of unburnt biogas posing a hazard
- b) Ingress of air and ignition causing a fire
- c) Flare operation causing a fire

All on-farm biogas plants should have an emergency flare to minimise direct venting of unburnt biogas, and for emergency and maintenance events. The flare should have a rated capacity to safely combust all biogas in storage (e.g. under the cover of a CAP) within a reasonable time period. By routing biogas via a working flare, the biogas is combusted and odour and fugitive air emissions can be greatly reduced.

The typical high methane content of piggery biogas (>50% CH<sub>4</sub>) can provide a high level of flame stability at an appropriate biogas supply pressure. Accordingly, continuous electric spark ignition systems without pilot flames have been common in Australian piggery installations (Figure 2.3). Note that unique cases may require a different ignition system.

A biogas flare should be designed by a qualified person and installed by a licensed person in accordance with the manufacturer's specifications and regulatory requirements. Safety authorities should be consulted early-on in a biogas project to clarify requirements for a biogas flare. AS 3814 and AS 1375 stipulate requirements for a flare as fuel-fired appliances, including design (e.g. ignition systems, pressure protection, safety shut-off), construction, commissioning (e.g. purging) and operation.



Figure 2.3 Typical on-farm biogas spark-ignition flares in Australia  
(Photos courtesy of the Pork CRC)

In line with best practice principles, the following should be considered for a flare:

- a) Flare location shall prevent hazardous exposure to unburnt biogas or heat.
- b) Flare location should minimise fire risk.
- c) The flare shall be constructed of appropriate materials.
- d) The provision of a safety shut-off system to interrupt the biogas flow when necessary. A manual isolation valve should be available for flare maintenance purposes. The on-and-off position of a manual isolation valve should be clearly labelled and unambiguous.
- e) Any electrical installations associated with flares shall be in accordance with AS 3000 and other relevant requirements.
- f) A flowmeter should be in place to meter the quantity of biogas that has been sent to the flare.
- g) A dedicated blower should be used for each combustion device (e.g. flare) to minimize the risk of air ingress by draw-back into the device.
- h) Fencing can prevent unauthorised access to the flare. However shut off valves and other relevant safety features need to remain safely accessible.
- i) A flame arrestor and backflow prevention device can prevent flame propagation from the flare back into the upstream biogas pipeline, and is a requirement of relevant Australian Standards.
- j) Fire risk associated with open flares should be mitigated by for instance locating the flare on a hard surface pad and/or by landscaping keeping vegetation down in the surroundings of a flare. Partial shrouding of the flare burner tip may also reduce fire risk.

**NOTE:** A biogas flame burns clear and may be INVISIBLE DURING DAY TIME. For this reason, a measurement device such as a thermocouple or a flare eye should be in place to confirm that a flare is operational.

The use of a biogas flare (including emergency flare) may be affected by rural fire regulation, such as total fire bans. Rules and regulations are set by the local fire authority and can differ considerably between different authorities. The flare operator should clarify requirements with the local fire authority before the biogas flare is installed and commissioned. Providing sufficient biogas buffer storage (see Section 2.4) may accommodate disruptions in flare operation during short periods of total fire ban. Exemptions may apply and operators need to consult their local fire authority.

## 2.7 Biogas use equipment

What risks does this section aim to manage/eliminate:

- a) Biogas use equipment posing a hazard

AS3814 *Industrial and Commercial Gas-fired Appliances* stipulates requirements for Type B appliances. Type B appliances (e.g. biogas-fired boilers, generators and combined heat and power units) should be designed by qualified persons and installed/signed off by a Type B gasfitter in accordance with manufacturer's specifications and regulatory requirements.

**IMPORTANT:** Persons who are licensed to perform fuel-gas installations and maintenance may not be aware (and need to be made aware) of the unique dangers of biogas, especially hydrogen sulphide.

In line with best practice principles, the following should be considered for biogas-fired appliances:

- a) Manual isolation valves shall be installed for maintenance purposes. The on-and-off position of manual isolation valves shall be clearly labelled and unambiguous.
- b) There shall be a means to safely shut-down a biogas appliance when required. The shut-off mechanism shall be safely accessible, clearly visible and unambiguous (e.g. an illuminated switch located in an accessible location outside of a generator skid/shelter - see Figure 2.4).
- c) Equipment fail safe devices should be in-place, e.g. an external/back-up radiator to reject the residual heat from a generator.
- d) Any electrical installations associated with biogas-fired appliances shall be in accordance with AS 3000 and other relevant requirements.
- e) AS 5601 and AS 1375 state requirements for exhaust (flue) and vent (bleed) lines, which in general shall prevent hazardous exposure to unburnt or burnt biogas. This should include consideration of setbacks to combustible materials and openings into buildings.
- f) Noise damping should be a standard feature for noisy plant.



Figure 2.4 Emergency switches located outside an on-farm generator skid  
(Photos courtesy of the Pork CRC)

## 2.8 Safety signage

What risks does this section aim to manage/eliminate:

- a) The risk of persons walking around a biogas plant being unaware of hazards and required personal protective equipment

Warning signs and tags should identify hazards where appropriate and should be clearly visible and unambiguous (diagrams can be useful for non-english speaking or illiterate persons). Safety signage of should include warnings about the toxicity and flammability of manure gases/biogas, burn hazards, risks of entanglement, drowning risks, electrical hazards, noise, restricted access areas and other relevant hazards (Figure 2.7 provides some typical examples). Signage should also clearly and unambiguously indicate requirements for personal protective equipment (e.g. “hearing protection is required in this area”).



Figure 2.5 Typical safety signage around an on-farm biogas plant  
(Photos courtesy of the Pork CRC)

### 3.0 Commissioning, Operation and Maintenance Considerations

#### 3.1 Commissioning and start-up

What risks does this section aim to manage/eliminate:

- |   |
|---|
| <ul style="list-style-type: none"><li>a) Unfinished/untested biogas plants being commissioned</li><li>b) Safety risk associated with transient explosive gas mixtures during start-up/commissioning</li></ul> |
|---|

A clear and sequential procedure/commissioning plan should be in place before a plant is commissioned.

Prior to commissioning of a biogas plant (first filling), all biogas plant components need to undergo a thorough testing/check regime and this shall be well-documented. This includes (but is not limited to):

- a) Checking of all gas containing equipment such as liner and cover welds for gas/liquid tightness (best done by installer);
- b) Checking of cover seal and anchor trenching for tightness (best done by installer).
- c) Checking of all biogas carrying pipelines, biogas scrubbing vessels, biogas blowers including connection pieces for gas tightness;
- d) Inspection of any pipeline liner or cover penetrations for liquid/gas tightness;
- e) For concrete tanks, checking of all penetrations (e.g. mixer shafts) for liquid/gas tightness; and
- f) For heated digesters, checking that the digester heating system, circulation pumps and other relevant equipment are operational.

**IMPORTANT:** During start-up/commissioning, air/oxygen may be present in equipment and pipelines and is to be displaced with biogas (or an inert gas). The volume of gas mixture that is to be displaced during purging also includes any gas storage (Section 2.4). AS 5601, AS 3814 and AS 1375 stipulate requirements for purging. Viable ignition sources such as biogas appliances should remain off during pre-commissioning purging, until it has been confirmed that the gas mixture in equipment or piping has successfully transitioned to above the UEL (see Definition 1.4.19). Such conditions can be confirmed by measurements with a gas composition meter which is appropriately rated for use in potentially explosive gas atmospheres (see Figure 3.1).



*Figure 3.1 Measurement of biogas composition on-farm can confirm whether explosive gas mixtures have successfully been purged from biogas equipment and piping. The biogas meters shall be appropriately rated for use in potentially explosive gas atmospheres (courtesy of the Pork CRC)*

### 3.2 Operation and maintenance

What risks does this section aim to manage/eliminate:

- a) Non-biogas related health and safety issues, such as falls, entanglement, electrical and noise associated with operation and maintenance of a biogas plant
- b) Biogas-specific risks associated with operation and maintenance of a biogas plant, such as the flammability of methane in biogas, the toxicity of trace gases such as hydrogen sulphide (H<sub>2</sub>S) and ammonia in raw biogas, and the asphyxiation risk with displacement of oxygen by raw or treated biogas in poorly ventilated spaces

#### 3.2.1 General risks

This section adopts a workplace framework by Safe Work Australia (2011).

Operation and maintenance of a biogas plant poses unique hazards of a general nature, including hazardous exposure to electrical and mechanical systems (including potential for entanglement), noise, slips and falls, and drowning (US EPA, 2011). These hazards can be partly managed by:

- a) providing all individuals working around the biogas plant with adequate training and awareness (see *Training, Monitoring and Record Keeping*);
- b) regular visual integrity inspection of above-ground biogas plant components (checking for cracks, tears, or damage, or the presence of an odour). Record keeping of notable observations is important;
- c) carrying out preventative maintenance per manufacturer's specifications. Manufacturer's operating and maintenance manuals should be sourced and should be readily accessible for maintenance;
- d) restricting electrical work to licensed electrical workers;
- e) NOT allowing access (unless by strict permit) INTO manure pits, digesters and other confined spaces (do not enter a confined space, Safe Work Australia, 2011a);
- f) providing appropriate personal protective equipment (PPE) for persons working around a biogas plant (e.g. ear plugs, portable gas detectors);
- g) discouraging the wearing of loose clothing or jewellery and tying back long hair to prevent entanglement;
- h) operating and maintaining all biogas equipment in accordance with manufacturers' specifications; and
- i) where possible, performing all work at ground level, or providing appropriate fall protection and associated training and competency.



### 3.2.2 Biogas-specific safety

The specific hazards of biogas were highlighted in Sections 1 and 2 above, and a range of relevant design and installation features were also introduced to help address the associated risks. The following are important considerations for operation and maintenance:

- **IMPORTANT:** Persons who are licensed to perform maintenance on fuel-gas installations may not be aware of the unique dangers of biogas, especially hydrogen sulphide.
- **IMPORTANT:** Portable hydrogen sulphide and/or flammable gas detectors should be worn or carried by people working around biogas equipment to warn of dangerous gas atmospheres. Figure 3.2 shows typical examples of portable gas-detectors.



Figure 3.2 Typical portable biogas/hydrogen sulphide safety detectors  
(Google images)

### 3.2.3 Hazardous chemicals

What risks does this section aim to manage/eliminate:

- a) Unsafe use of hazardous chemicals

Some chemicals used in biogas plants are hazardous and may have specific handling and storage requirements. Include, make available and use materials safety datasheets (MSDSs).

### 3.2.4 Maintenance

What risks does this section aim to manage/eliminate:

- a) Biogas equipment and piping posing a hazard during maintenance

Biogas-fired appliances need to be maintained in accordance with manufacturer's specifications, and where appropriate, by licensed Type B gas fitters.

Before maintenance or major overhauls, a biogas system can contain biogas with lethal amounts of hydrogen sulphide. This hazardous gas mixture is to be displaced with air (or an inert gas) prior to safe access for maintenance. During decommissioning/maintenance, pipework and equipment shall remain gastight until it has been confirmed that the gas mixture has successfully transitioned to below the LEL and to safe levels of hydrogen sulphide. Such conditions can be confirmed via measurements of biogas composition with an explosion-proof biogas composition meter (as in Section 3.1).

### 3.2.5 Information, training and instruction

A training program and induction process should be developed for each site and should include important features of the biogas plant. Training and information should be given to assess contractors, suppliers and staff working with biogas equipment. Training should highlight the unique dangers of biogas (e.g. hydrogen sulphide, flammability). Access to biogas facilities shall be restricted to authorised persons, and visitors to a biogas plant should be escorted at all times. Users of personal protective equipment shall be appropriately trained in its purpose and use.

### 3.2.6 First aid

The First Aid Code of Practice (Safe Work Australia, 2012) provides information on tailoring first aid to a workplace, providing detailed guidance on requirements such as the number of first aid kits, their contents and the number of trained first aiders. Refer to Appendix A and B of the First Aid Code of Practice for sample templates (Safe Work Australia, 2012).

### 3.2.7 Emergency plans

An emergency plan shall be in place and shall consider safety requirements of the biogas system as appropriate. Refer to business.gov.au publication *Emergency Management & Recovery Plan Template* for an emergency plan template (business.gov.au, 2012). Emergency procedures should include (but not be limited to):

- a) an effective response to an emergency situation;
- b) procedures for evacuating the workplace;
- c) notification of emergency services at the earliest opportunity;
- d) medical treatment and assistance; and
- e) communication protocols to coordinate the emergency response.

### 3.2.8 Monitoring and record keeping

A written schedule of monitoring activities should be defined for the biogas project. As highlighted in Section 2.2, the design of the biogas plant should enable safe access to sludge, effluent and biogas for sampling and monitoring. Indicators that may be logged can include (but are not limited to):

- a) the pH of the outflow from a CAP or digester;
- b) the volatile solids content in the outflow from a CAP or digester;
- c) a measure of accumulated sludge volumes in CAPs;
- d) scheduled biogas composition checks, especially where micro-aeration is used for biological scrubbing of hydrogen sulphide (see Section 2.5);
- e) condensate pH for iron sponge scrubbers because acidic condensate can correspond to a reduced H<sub>2</sub>S removal efficiency;
- f) biofilm growth in biogas conditioning devices, especially with biological scrubbing methods. For packed columns this may be simply done via pressure measurements directly upstream and directly downstream of the column, where a large pressure drop may indicate that the column is fouled/blocked;
- g) biogas flow rate and cumulative amount to each combustion device (can be back-calculated from the electricity output of a generator, assuming a reasonable electrical efficiency); and
- h) a temperature probe or flare eye detection of the operational status of each flare.

PigBal can be used to reasonably estimate organic loading to a CAP or digester, given accurate records of stock numbers, feed purchases and by-products that end up in the effluent management system.

Lastly, metered chemical and power usage and records of maintenance of the biogas plant components allow a reliable estimate and tracking of costs associated with running of the plant, and can identify key emerging issues and opportunities for improvement or troubleshooting.

## 4.0 Environmental Protection

Most on-farm biogas plants at piggeries will be add-ons to existing manure management systems. These systems will likely enhance the environmental performance of the farm, e.g. by reducing odour, energy use and greenhouse gas emissions. Nonetheless, biogas plants can generate unique discharges, which are outlined in this section. These include:

- a) odour emissions (although significantly reduced by capturing and combusting biogas) – managed as per NEGP;
- b) used oil and filter associated with generator engines;
- c) spent scrubbing media and condensate from scrubbers; and
- d) decommissioning waste, including the plastic cover for a CAP and other demolished materials.

Annex A, Table A.2, provides a list of State authorities and legislation for environmental protection relevant to biogas plants. The legislative framework may be subject to change from time-to-time.

### 4.1 Manure and digestate management

What risks does this section aim to manage/eliminate:

- |   |
|---|
| <ol style="list-style-type: none"><li>a) Imported material for co-digestion introducing new environmental risks to the operation, including contamination and biosecurity risks</li><li>b) Imported materials complicating nutrient (and salt) management at the farm</li><li>c) Environmental hazards associated with manure/feedstock handling</li><li>d) Unintended fugitive emissions (leakage)</li><li>e) Concentrated waste (nutrient) discharges (manure, digestate) from storage facilities</li><li>f) Nutrient loads in digestate and sludge being estimated incorrectly or poor digestate management, leading to problems with excessive application of nutrients to land</li></ol> |
|---|

Biosecurity and contaminants (such as heavy metals) are key considerations when importing of off-farm feedstocks for co-digestion. It is also important that the fertilizer nutrient (and salt) contents of additional imported feedstocks are recorded and added to farm nutrient budgets where appropriate. NEGP Sections 10, 11, 12 and 13 apply to management of on-farm biogas feedstocks, including minimising odour generation with transport and treatment, while achieving good volatile solids reduction, and with no releases to ground and surface waters. Note that anaerobic digestion provides minimal reduction in nitrogen (N), so most of the nitrogen that enters the digester will also end up in the treated effluent outflow.

NEGP Sections 10, 11, 12, 13 and 14 and the Manure Guidelines (APL 2015) provides guidance around Effluent Management (collection and treatment), Solids Separation Systems, Solid By-products Storage and Treatment Areas and Reuse Areas, to manage the risks associated with effluent and digestate. Producers should be aware that anaerobic digestion can make fertiliser nutrients (nitrogen in particular) more plant available which can have associated positives and negatives. For lagoon systems, significant quantities of nutrients (especially phosphorus) can accumulate in the sludge. Other “nutrients” that accumulate in lagoon sludge (particularly copper [Cu] and zinc [Zn]) can limit sludge application in some areas. In general, potassium (K) and nitrogen is relatively mobile and stays predominantly in the liquid effluent outflow from a CAP or digester. Testing of manures and digestate can assist in calculating sustainable application rates.

## 4.2 Noise

What risks does this section aim to manage/eliminate:

- a) Potential for noise nuisance associated with the biogas plant

It is important to carefully locate a biogas plant (especially noisy equipment) to be separate from sensitive land uses, to reduce the risk of noise nuisance to nearby receptors. Engineering/design options for consideration include:

- a) installation of mufflers on equipment; and
- b) use of noise barriers and/or insulated walls.

## 4.3 Odour control

What risks does this section aim to manage/eliminate:

- a) Potential for odour nuisance associated with the biogas plant

Unburnt biogas may be a significant source of odour if not managed properly. The most effective and simplest way to minimise biogas odour is to burn the biogas in a combustion device.

An imbalanced anaerobic digestion process can cause unique odour during start-up, affiliated with septic and/or poorly treated manure. During start-up, irrigation of partially digested effluent should be avoided/minimized because such can exacerbate odours. Local and environmental protection authorities are best notified of a commissioning or upset event, together with providing details of a clear plan to resolve temporary elevated levels of odour.

## 4.4 Waste discharge

What risks does this section aim to manage/eliminate:

- a) Hazardous materials required for the operation of a biogas plant (e.g. generator motor oil, biogas filter media) becoming new environmental risks

Spent generator motor oil should be stored in fully-enclosed sumps with adequate storage volume without leaks, or in rooms with oil skimming bottom drains. A disposal contract should be in place for spent generator motor oil and documentation should be available for presentation to the environmental protection authority upon request.

Some spent biogas scrubbing filter media can be recycled on-farm (e.g. iron sponge or active carbon), and such recyclable materials should be preferred where possible over materials that cannot be safely disposed of. Spent biogas filter media and any significant quantities of condensate should be appropriately managed.

## 5.0 References

Standards Australia references which may be subject to change (refer to the most up-to-date version):

AS 1375, 2013. Industrial Fuel Fired Appliances.

AS 3814, 2010. Industrial and Commercial Gas-fired Appliances. A revised version (2015) is available for this standard.

AS/NZS 4801, 2001. Occupational health and safety management systems

AS 5601.1, 2013. Gas Installations.

AS 3000, 2007. Electrical installations.

AS/NZS 60079.10.1:2009 Explosive atmospheres - Classification of areas - Explosive gas atmospheres

APL (2015). APL project 2012/1028 Piggery Manure and Effluent Management and Reuse Guidelines 2015.

BC Ministry of Environment, (2010). On-farm Anaerobic Digestion Waste Discharge Authorization Guideline.

Bourke, Dennis A. (June 2001). Dairy Waste Anaerobic Digestion Handbook, Options for Recovering Beneficial Products From Dairy Manure.

Business.gov.au, (2012). Emergency management & recovery plan template, Accessed 2 December 2012.

<http://www.business.gov.au/Howtoguides/Thinkingofstartingabusiness/Whatplanningtoolscanhelpme/Pages/Emergencymanagementplantoolsguides.aspx>

Carbon Farming Initiative, (2013a). Undertaking a CFI project, Department of Climate Change and Energy Efficiency, Accessed 5 March 2013.

<http://www.climatechange.gov.au/government/initiatives/carbon-farming-initiative/handbook/project.aspx>

Carbon Farming Initiative, (2013b). Methodology determinations, Department of Climate Change and Energy Efficiency, Accessed 5 March 2013.

<http://www.climatechange.gov.au/government/initiatives/carbon-farming-initiative/methodology-development/determinations.aspx>

Davidson, AA, (2010). A Review of Australian Regulations and Standards for the Handling and Treatment of Biogas, Prime Consulting International (Australia) Pty Ltd.

Department of Health New York USA. Health Effects from Inhalation of Hydrogen Sulfide

German Agricultural Occupational Health and Safety Agency, 2008. Safety Rules for Biogas Systems.

Heubeck, S. (2010). "Biogas Use Options" Conference presentation at Bioenergy Australia 2010 Conference; 10<sup>th</sup> December 2010, Sydney, Australia.

Hyam & Mitchell, (1997). Environmental Resolve, The Environment Council (UK), Anaerobic Digestion of farm and food processing residues – Good Practice Guidelines.

NGER, National Greenhouse and Energy Reporting (Measurement) Determination 2008, accessed 21 December 2012 at <http://www.comlaw.gov.au/Details/F2012C00472>

Office of Gas Safety, (2005). Gas Safe, Draft Landfill/ Biogas Flare Systems Guidelines.

Petroleum and Gas (Production and Safety) Act 2004 Victoria Gas Safety (Gas Installation) Regulations 2008 - 165/2008, 18/01/2009 001 (Latest Version).

Safe Work Australia, 2011. Model Work Health and Safety Regulations: Model Regulations, 4 November 2011.

Safe Work Australia, 2012. First Aid in the Workplace Code of Practice. Draft March 2012.

Safe Work Australia, 2011a. Confined Spaces Code of Practice, December 2011.

Skerman, Alan, (2005a). Earth pad preparation requirements for deep litter pig production systems and solids waste stockpile and composting areas.

Skrtic, L. Hydrogen Sulfide, Oil and Gas, and People's Health. 2006.

Standards Association of New Zealand. (1987a). Code of Practice for the Production and Use of Biogas, Farm Scale Operation: Part 1 Production of Biogas, Publication No. NZS 5228, Wellington, New Zealand.

Standards Association of New Zealand. (1987b). Code of Practice for the Production and Use of Biogas, Farm Scale Operation: Part 2 Uses of Biogas, Publication No. NZS 5228, Wellington, New Zealand.

Standards Australia, 2012. Standards Development – SG-006 – Rules for the structure and drafting of Australian Standards, version 2.4, 3 April 2012.

Tucker, RW, McGahan, EJ, Galloway, JL and O'Keefe, MF, (2010). National Environmental Guidelines for Piggeries - Second Edition, APL Project 2231, Australian Pork Ltd, Deakin, ACT, Australia.

USEPA - United States Environment Protection Agency, (2011). (AgStar) Common Safety Practices for On-farm Anaerobic Digestion Systems.

Victoria Environment Protection Authority, (2012). Regulatory Impact Statement for the Environment Protection (Scheduled Premises and Exemption) Regulations 2007; New Exceptions.

## Annex A: Australian Regulators

Refer to the Gas Technical Regulators Committee [www.gtrc.gov.au](http://www.gtrc.gov.au) for up to date regulations and Authority contact details.

Table A.1 Summary of State gas safety agencies

State	Regulation	Authority	Notes
<b>NSW</b>	Gas Supply (Consumer Safety) Regulation 2012	Department of Fair Trading	For further information, refer to <i>Part 6 – Gas installations (not supplied from a gas network)</i> to ensure the correct testing and certification requirements are completed, where biogas installations operating under 200 kPa are regulated.
<b>QLD</b>	Petroleum and Gas (Production and Safety) Regulation 2004	Petroleum and Gas Inspectorate	Further information and application forms for a Gas Work Authorisation (Industrial Appliances) and a Gas Work Authorisation (servicing) can be sourced from the regulator. Biogas production facilities are operating plant and require a safety management system to be implemented before commissioning. For more information on Biogas see <a href="http://mines.industry.qld.gov.au/safety-and-health/petroleum-gas-safety.htm">http://mines.industry.qld.gov.au/safety-and-health/petroleum-gas-safety.htm</a>
<b>VIC</b>	Victoria Gas Safety (Gas Installation) Regulations 2009 <b>001</b>	Energy Safe Victoria	For further information refer to Energy Safe Victoria – to Schedules 7, 8, 9, 10, 11 and 12.
<b>TAS</b>	Gas Safety Regulations 2002	Workplace Standards Tasmania, under the Department of Justice - Office of the Director of Gas Safety	A Safety Management Plan pursuant to Sec 77 of the Gas Act 2000 and Regulation 46 (d & g) of the Gas Safety Regulations 2002 is required for an on-farm biogas installation. The pertinent document is the <i>Guideline for the preparation of a submission for the acceptance of Gas Installation (major)</i> “safety management plan.”
<b>SA</b>	Gas Regulations 1997	Office of the Technical Regulator, Department of Transport, Energy and Infrastructure	While safety and technical issues involving gas installations are covered under Part 4 of the Gas Regulations 1997, neither the Act nor Regulations are applicable to an on-farm biogas facility in South Australia, unless an LPG pilot light is being used.
<b>WA</b>	Gas Standards (Gas fitting and Consumer Gas Installations) Regulations 1999	Energy Safety WVA, Department of Consumer and Employee Protection	Gas Standards Act 1972 and the subordinate legislation the Gas Standards (Gas fitting and Consumer Gas installations) Regulations 1999 do not cover on-farm biogas where an operator produces and consumes biogas on the same site (unless piped to a neighbouring farm).
<b>NT</b>	Dangerous Goods Regulations 2010	NT Work Health and Electrical Safety Authority	The applicable legislation is Part 3 of the Regulations ‘Class 2 dangerous goods (gases)’. Furthermore, the general licensing requirements for the manufacture and storage of dangerous goods, is covered in Section 3 and 4, respectively, of the Regulations.

Refer to your State Environment Protection authority for up to date regulations.

Table A.2 Summary of State environmental authorities

State	Regulation	Competent Authority	Notes
<b>NSW</b>	Protection of the Environment Operations (Clean Air) Regulation 2010	Department for Environment, Climate Change and Water	Part 4 of the Regulation which covers the Emission of Air Impurities from Activities and Plant is limited to particulate emissions from a flare with a larger capacity than those most likely to be installed on farms.
<b>QLD</b>	Environmental Protection Regulation 2008	Queensland Department of Environment and Heritage Protection	Requires a licence for any “Environmentally Relevant Activity” (ERA) listed in the Regulation. For biogas flaring, a fuel burning licence is required for all equipment with a fuel burning capacity of 500 kg/h or more, as per ERA 15 in the Regulation. For installations not requiring a licence, the general intention of the Act is to be complied with and all reasonable practicable measures taken to prevent environmental harm.
<b>VIC</b>	Environment Protection (Scheduled Premises and Exemptions) Regulations 2007 and State Environment Protection Policy (SEPP) (Air Quality Management)	Environment Protection Authority (EPA) Victoria	EPA works approval is required but a new exemption from a discharge control licence is provided for gas fired boilers and turbines of a rated capacity of not more than 20MW (Victoria EPA, 2012).
<b>TAS</b>	Environment Protection Policy (Air Quality) 2004	Environmental Protection Authority within the Department of Primary Industries, Parks, Water and Environment	No licence required for on-farm biogas as it is under the threshold of burning combustible matter of one tonne or more per hour. However, compliance with the Policy is required as its Schedule I specifies ‘in-stack concentrations that would normally be expected to be achievable using accepted modern technology.’
<b>SA</b>	Environment Protection Regulations 2009	Environmental Protection Authority	Fuel Burning licence under the Act has a minimum threshold limit of 5MW. It is not applicable to a biogas flare as the largest on-farm biogas flare has maximum heat out output of 4.4MW. With no licence requirement, flaring shall still comply with the air quality impact assessment requirements included in EPA 386/06 which requires that the combustion process adequately disperses nitrous oxide and other pollutants that may be detrimental to human health, and may be applied differently depending on the proximity to residential areas.
<b>WA</b>	Environmental Protection Regulations 1987	Environmental Protection Authority	Farm-scale biogas plants do not meet the threshold criteria.
<b>NT</b>	Waste Management and Pollution Control Act 2009	Natural Resources, Environment, The Arts and Sport (NRETAS)	On-farm biogas emissions are not regulated.



Source: Davidson (2010).

## Annex B: Biogas Use Equipment

Biogas is a versatile renewable energy resource. This versatility can make selection of the optimum use of biogas complex, and the optimum biogas use is likely to be influenced by site and project specifics. While biogas flaring is an appropriate low cost and effective means for reducing farm odour and GHG impact, it does not yield any further energy benefit. Wherever practical and economically feasible, the use of biogas for boiler, generator or transport fuel applications is therefore encouraged. The highest value end use of the biogas should be targeted. Table B.1 provides indicative advantages for various biogas uses.

Table B.1 Substitution values for various energy applications of 1.5 m<sup>3</sup> biogas = ~ 1 m<sup>3</sup> CH<sub>4</sub>

Substitute	GHG Mitigation	Gross Value	Complexity
~ 1m <sup>3</sup> Natural gas boiler fuel	~ 2 kg CO <sub>2eq</sub>	\$0.20 – 0.50 Location specific	Simple and cost effective
~ 1.4 L LPG boiler fuel	~ 2.2 kg CO <sub>2eq</sub>	\$0.60 – 0.80	Simple and cost effective
1.5 – 3 kg Coal (Lig – SB) Boiler fuel	3.3 – 3.6 kg CO <sub>2eq</sub>	\$0.07 – 0.25 Location specific	Quite simple and cost effective
3 – 3.5 kWh electricity	NZ: 0.6 – 0.7 kg CO <sub>2eq</sub> AU: 2.7 – 3.2 kg CO <sub>2eq</sub>	\$0.12 – 0.20 export \$0.30 – 0.60 own use	Moderately complex Moderately expensive
0.9 – 1.05 L Transport fuel (Diesel/petrol)	2.4 – 2.7 kg CO <sub>2eq</sub>	\$1.00 – 1.20 NZ & AU (no tax)	Complex Relatively expensive technology

Source: Heubeck, S. 2010, value indications based on year 2010.  
Approximate costs in AUD

If an on-site CHP unit is to run in parallel with the existing power supply system (grid synchronous), or is to be configured to export electricity, it is recommended that the local distribution network be contacted early on in the planning phase to clarify requirements. The complexity and timing of connecting to grid infrastructure should not be underestimated.

## Annex C: Biogas Conditioning Methods

Table C.1 Water vapour removal methods

Water Vapour Removal Method	Technical Description	Contaminants Introduced to Biogas or Digestate	Waste Discharges	Advantages and Disadvantages
<b>Passive gas cooling</b>	A section of biogas pipeline with condensate drains is installed underground. Biogas piped underground for a short time period is passively cooled by the ground temperature. Cooling condenses some water vapour from the biogas which is collected.	No contaminants introduced.	Condensate water can carry substantial amounts of dissolved H <sub>2</sub> S. Condensate needs to be handled with care to avoid odour nuisance.	Pro: <ul style="list-style-type: none"> <li>• Simple construction</li> <li>• Minimal maintenance</li> </ul> Con: <ul style="list-style-type: none"> <li>• Only partial water removal</li> <li>• Condensate needs to be managed</li> </ul>
<b>Active gas cooling</b>	Heat exchangers or water spray towers are used to cool the biogas to desired dew point. Water vapour condenses and is removed via drain valves or separators. Cooling source can be cold (bore or CAP) water or refrigerated water.	With water spray towers the biogas is contacted with a water of specific purity.	As above for passive cooling.	Pro: <ul style="list-style-type: none"> <li>• Near complete removal of water vapour possible</li> <li>• Automated process</li> <li>• Moderately complex</li> </ul> Con: <ul style="list-style-type: none"> <li>• Refrigeration can be moderately costly</li> <li>• Parasitic energy load</li> <li>• Condensate to manage</li> </ul>
<b>Absorption</b>	Glycol or hygroscopic salts absorb water as biogas is directed through the drying medium. The medium can be regenerated by exposure to a high temperature.	No contaminants introduced.	Process can be regenerative but eventually the drying media will have to be replaced. Hygroscopic salts will result in a non-hazardous solid waste stream.	Pro: <ul style="list-style-type: none"> <li>• Near complete removal of water vapour possible</li> <li>• No liquid condensate handling</li> </ul> Con: <ul style="list-style-type: none"> <li>• Difficult to automate</li> <li>• Maintenance and operating costs</li> <li>• Relatively large vessels required</li> </ul>

Water Vapour Removal Method	Technical Description	Contaminants Introduced to Biogas or Digestate	Waste Discharges	Advantages and Disadvantages
<b>Adsorption</b>	Silica gel or aluminium oxide adsorbs water as biogas is directed through the medium. Drying medium is regenerated by drying it at a high temperature and pressure (otherwise air needs to be injected for regeneration).	Same as absorption.	Same as absorption.	Same as absorption.

Source: Based on BC Ministry of Environment, 2010.

Table C.2 Hydrogen sulphide (H<sub>2</sub>S) removal methods

Removal Method	Technical Description	Contaminants Introduced to Biogas or Digestate	Waste Discharges	Advantages and Disadvantages
<b>Biological oxidation</b>	Small quantities of air is injected into the biogas and sufficient contact time is provided (such as under in the headspace volume of the digester) to allow sulphur oxidising bacteria to consume the oxygen and convert H <sub>2</sub> S into elemental sulphur.	Nitrogen gas is introduced to the biogas with air injection. Excess air may drive the biological reaction to instead produce sulphuric acid.	Sulphur deposits and is to be managed.	<p>Pro:</p> <ul style="list-style-type: none"> <li>• Low investment costs</li> <li>• Low operational costs</li> <li>• Can be very effective</li> </ul> <p>Con:</p> <ul style="list-style-type: none"> <li>• In an unmixed CAP, the sulphur that deposits may end up back in the lagoon liquid volume and can exacerbate H<sub>2</sub>S formation</li> <li>• Air injection dilutes with inert nitrogen gas</li> <li>• Excessive air injection can produce sulphuric acid which is corrosive or produce an explosive gas mixture.</li> </ul>
<b>Iron chloride dosing</b>	Liquid iron chloride solution is injected directly into the digester or into the feedstock mixing tank. A typical dose might be 4g/litre. H <sub>2</sub> S precipitates as an insoluble mineral solid and ends up in the sludge.	Chloride (salinity) which remains mobile.	Added iron forms sludge and added chloride adds salinity to the digestate.	<p>Pro:</p> <ul style="list-style-type: none"> <li>• Can be highly effective.</li> <li>• Near-permanently sequesters the sulphide.</li> </ul> <p>Con:</p> <ul style="list-style-type: none"> <li>• Ongoing chemical reagent costs, which are very significant.</li> </ul>
<b>Water scrubbing</b>	Dissolves the H <sub>2</sub> S in water contacted with the biogas in a spray tower.	Depends on the quality of the scrubbing water used.	The process can be designed as a regenerative manner where hydrogen sulphide is stripped from the circulated water before recycling the water back to the spray-tower.	<p>Pro:</p> <ul style="list-style-type: none"> <li>• Can also simultaneously remove CO<sub>2</sub> and other trace contaminants.</li> <li>• Can be automated.</li> </ul> <p>Con:</p> <ul style="list-style-type: none"> <li>• Large water volumes and flowrate.</li> <li>• May require higher pressures to work effectively.</li> <li>• Parasitic energy load.</li> </ul>

Removal Method	Technical Description	Contaminants Introduced to Biogas or Digestate	Waste Discharges	Advantages and Disadvantages
<b>Activated Carbon</b>	Raw biogas flows through an activated carbon filter, often impregnated with potassium iodine (KI) or sulphuric acid (H <sub>2</sub> SO <sub>4</sub> ). This method is usually used in combination with and subsequent to, addition of air into the biogas (see biological oxidation). H <sub>2</sub> S is converted to elemental sulphur (S).	No gaseous contaminants introduced, unless air is also used in tandem.	Activated carbon is listed as a Dangerous Good.	<p>Pro:</p> <ul style="list-style-type: none"> <li>• High biogas purity achievable</li> <li>• Simultaneous removal of other trace contaminants</li> <li>• Relatively cheap and simple infrastructure</li> </ul> <p>Con:</p> <ul style="list-style-type: none"> <li>• Ongoing costs for activated carbon purchases</li> <li>• Some maintenance required.</li> </ul>
<b>Iron Hydroxide or Oxide</b>	Biogas is passed through a solids media impregnated with iron oxide or iron hydroxide. H <sub>2</sub> S reacts to form iron sulphide.	No gaseous contaminants introduced.	<p>This process is often regenerative, but eventually the filter media becomes spent and is be disposed of.</p> <p>Note: When exposed to air, FeS in media can be pyrophoric – can spontaneously combust.</p>	<p>Pro:</p> <ul style="list-style-type: none"> <li>• High biogas purity achievable.</li> <li>• Relatively cheap and simple infrastructure.</li> </ul> <p>Con:</p> <ul style="list-style-type: none"> <li>• Ongoing costs for media purchases.</li> <li>• Some maintenance required.</li> <li>• Fire risk if regeneration is not managed carefully.</li> </ul>
<b>Sodium Hydroxide</b>	Biogas bubbled in a caustic solution which dissolves the hydrogen sulphide to a larger extent than in plain water.	No gaseous contaminants introduced.	The caustic solution eventually becomes spent, and depending on its pH may be hazardous.	<p>Pro:</p> <ul style="list-style-type: none"> <li>• High biogas purity achievable</li> </ul> <p>Con:</p> <ul style="list-style-type: none"> <li>• Ongoing costs for caustic purchases</li> <li>• Moderately complex infrastructure required for safe handling of caustic</li> <li>• Some maintenance required</li> <li>• Health and safety risk with handling caustic substances</li> </ul>

Source: Based on BC Ministry of Environment, 2010.

**Annex D: Ventilation Criteria. Excerpt from AS/NZ60079.10.1:2009.**

<b>Table ZA.1 – Ventilation criteria</b>		
	<b>Adequate ventilation</b>	<b>Inadequate ventilation</b>
1 Open-air (Note 1)	An open-air situation with natural ventilation, without stagnant areas, and where vapours are rapidly dispersed by wind and natural convection. Air velocities should rarely be less than 0.5 m/sec and should frequently be above 2 m/s*	Natural ventilation limited by topography, nearby structures, weather conditions  Artificial ventilation may be necessary to meet adequate ventilation and this is normally easily achieved
2 Sheltered structures (Note 2)	(a) Within a structure having no more than three walls (See Figure ZA.2) and where all walls have continuous or virtually continuous ventilation openings along their full length comprising not less than 0.4 m high effective opening at the bottom, 0.3 m high effective opening at the top of the walls and 0.3 m virtually continuous effective opening at the highest part of the roof	Structures having less wall and roof ventilation than that given in (a).  Structures that have a low profile or are extensive
	(b) A structure having effective openings equal to at least 10% of wall surface in all walls at both top and bottom of all sides, and 0.3 m continuous, or virtually continuous effective opening at all ridges of the roof	Structures having less wall and roof ventilation than that given in (b)  Structures that have a low profile or are extensive
	(c) For LP Gas cylinder filling (other than in situ), a structure having no more than two closed walls	—
* Typically air velocities of not less than 0.5 m/s would suffice.		
NOTE 1 – Where air movement is limited due to topographical features, other nearby structures or unusual meteorological conditions, artificial ventilation may be required by the provision of suitably located fans to improve the ventilation in order to achieve adequate ventilation (see AS 1482 for further guidance).		
NOTE 2 – The ventilation criteria noted are generally applicable to small or medium structures with medium to large sources of potential release. For small sources of release, large structures or highly buoyant gases, alternative criteria may be applicable.		

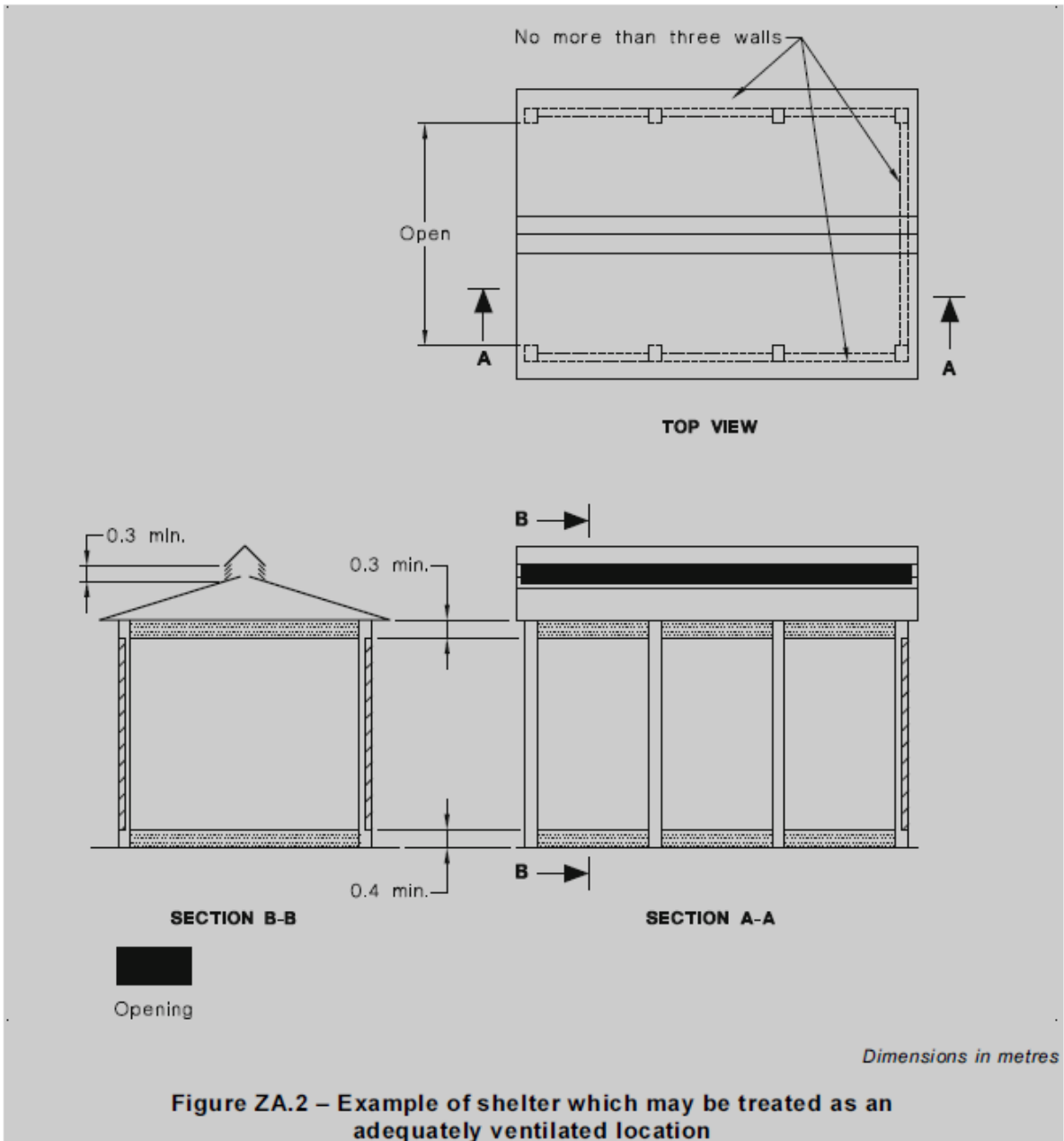

Source: AS/NZ 60079.10.1:2009 page 69-70.

**Annex E: Examples of Zone Classification from the Safety Rules for Biogas Systems by the German Agricultural Occupational Health and Safety Agency (2008).**

This is an excerpt from the German document (Appendix 9 in that document).

Examples Zone Classification			
System Part	Type of Impermeability	Zone 1	Zone 2
<b>General</b>			
Around: System parts, equipment parts, connections	Equipment and system parts with operational gas outlet	1 m around the outlet point	2 m around Zone 1
	tight	-	3 m around system part
	permanently tight	-	-
<b>Examples</b>			
Burst safety device that in normal operation seals securely		-	3 m around system part
Outlet opening of exhaust lines		1 m around outlet opening	2 m around Zone 1
<b>Service Opening</b>			
If the service openings are not opened during normal operation	With operational gas outlet	1 m around the outlet point	2 m around Zone 1
	tight	-	3 m around system part
	permanently tight	-	-
<b>Gas Storage</b>			
Around: Simple membrane storage out in the open  Simple membrane domes on digester containers and storage  Around ventilation and exhaust openings of vapour-sealed gas storage rooms  Double membrane domes with digester containers and storage, if the through-flow leads the diffusing biogas sufficiently diluted (<< 10% LEL) from the gas storage, and the exiting air is continuously monitored.			3 m from above
			3 m to the side
			2 m downward at 45° gradient
		-	-



System Part	Type of Impermeability	Zone 1	Zone 2
<b>Condensate Separator</b>			
Room that contain the condensate collector.  With open water locks, formation of a hazardous, possibly explosive atmosphere must be anticipated as a result of puncture or drying out of the water locks, or as a result of faulty operation:  a) with the discharge in closed rooms without ventilation – <b>Zone 0 in the entire room</b>			
b) with the discharge in closed rooms with natural ventilation		Entire room	1 m around openings of the enclosed room
c) closed drainage system, locks with double locking devices or automatic drainage For the total space, 1 m around openings of the enclosed room.		–	–
<b>Solid Substance Dosing</b>			
If during normal operation, forced submersed supply is guaranteed.		–	–

#### **Dimensioning of the Area of Zone 1**

A spherical area with a radius of 1 m around is considered an area of Zone 1 (see also, TRBS 2152) such as system parts, equipment parts, connections, sight glasses, pass-through, service openings at the gas storage and at the gas-carrying part of the digester container and around the outlet openings of exhaust lines, if an operational outlet of biogas must be anticipated.

The radius of 1 m applies in the case of natural ventilation.

Under normal operating conditions, releases into closed rooms must be avoided. If possible, the entire room is Zone 1.

## **Dimensioning of the Areas of Zone 2**

### **Gas-Carrying System Parts**

A spherical area with a radius of 3 m around system parts classified as impermeable are considered areas of Zone 2 such as equipment parts, connections, pass-through, service openings, as well as burst plates. The radius of 3 m applies in the case of natural ventilation. Closed rooms are entirely areas of Zone 2 (see also, TRBS 2152).

A spherical shell with a radius of 2 m thickness around system parts not classified as impermeable are considered areas of Zone 2, such as equipment parts, connections, sight glasses, pass-through, service openings, and at the gas-carrying part of the digester container, as well as around the outlet openings of exhaust lines, if these have an operational outlet of biogas.

### **Gas Storage**

If the membrane storage is stored out in the open or housed in a room ventilated all around, the area of Zone 2 encompasses the periphery of 3 m upwards and to the side, and 2 m downwards with a 45° gradient. In the case of housing the membrane storage in a vapor-tight and, therefore, extensively gas-tight room, Zone 2 encompasses the interior of the gas storage room and the periphery of 3 m around the ventilation and exhaust opening upwards and to the sides; the extent downwards amounts to 2 m with a 45° gradient.

Vapour-tight rooms can be rooms constructed with, e.g.:

- brickwork walls with trim
- concrete walls
- walls whose coating consists of non-combustible and spackled plates
- standardized containers with metal walls

### **Note**

Around system parts that are permanently impermeable, according to TRBS 2151, Section I 1.3.2.2 (see Appendix 10), there is no zone

### Double Membrane (Support Air)

No zone is present around the outer membrane and in the intermediate space between the two membranes if the through flow sufficiently thins (< 10% LEL) the biogas diffusing from the gas storage and leads it off in a targeted manner, and the air that is being discharged is continuously monitored according to the maintenance plan (manufacturer specification).

A ring-shaped potentially explosive atmosphere can occur around the transition to the digester if the connection is not implemented in a permanently impermeable manner.

If it is not possible to prevent backflows into the support air blower, these are to be implemented according to 94/9/EU.

### Example – Biogas System, Top View with Permanently Tight System Parts

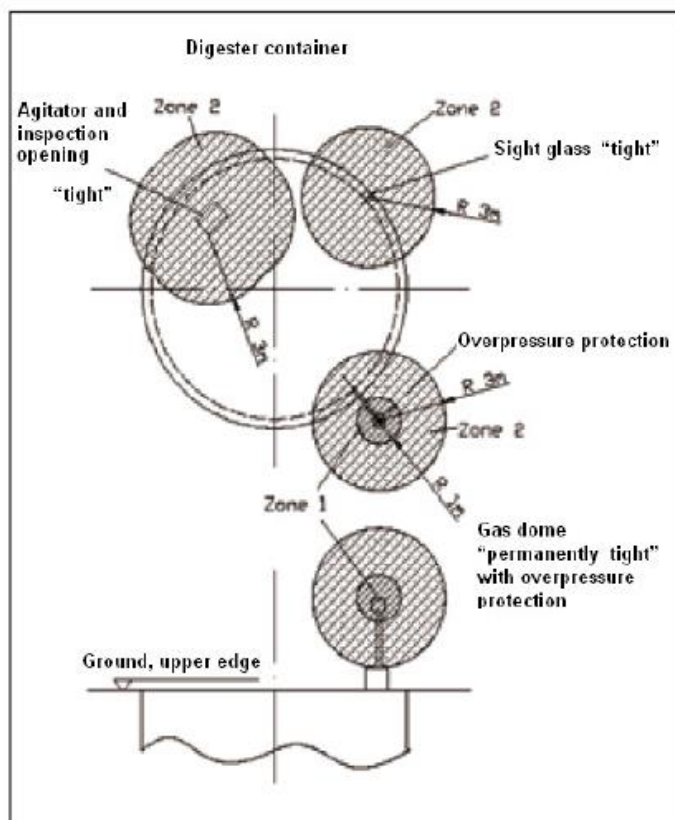

**Example – Housed Gas Storage (Storage Room Without Further Technical Measures)**

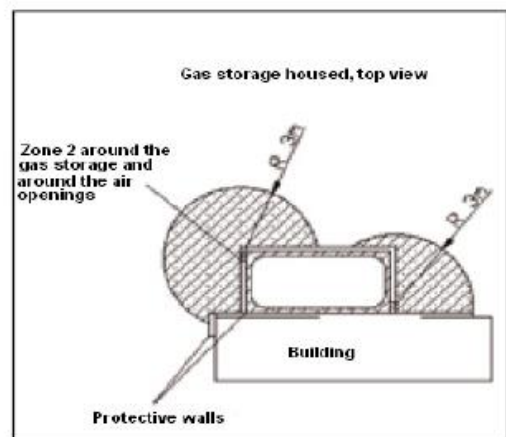
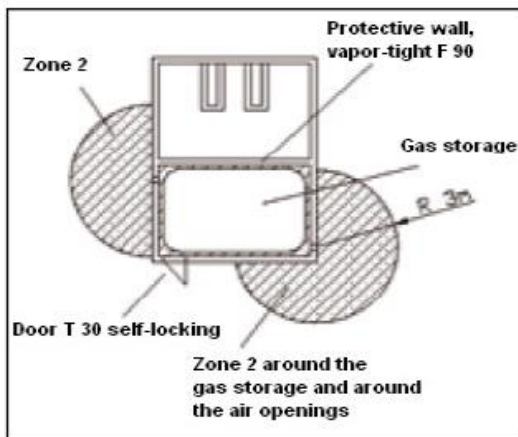
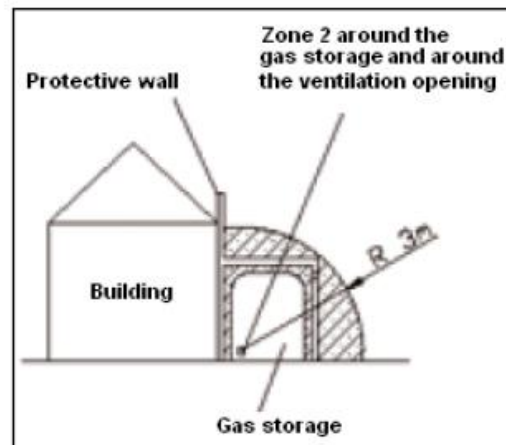
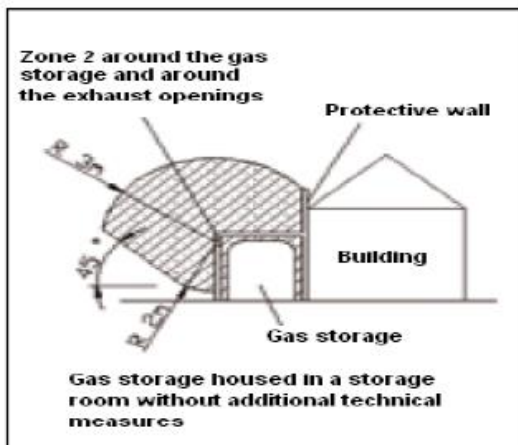
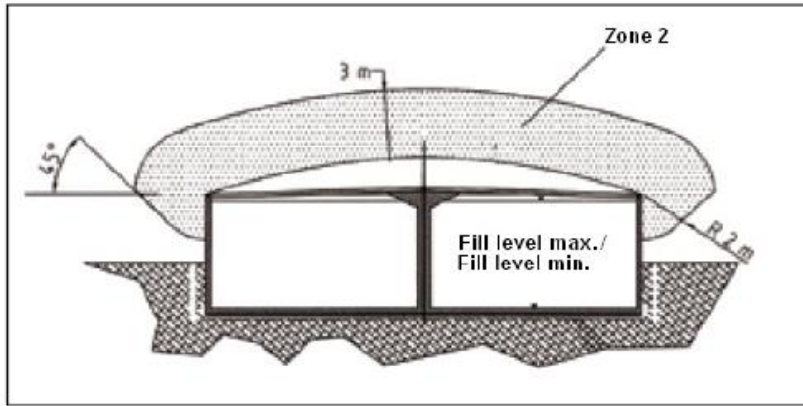

Source: German Agricultural Occupational Health and Safety Agency, 2008.