

RIPPER II: GROWING KIDS ON FARMS

AN EDUCATION RESOURCE FOR PRIMARY SCHOOLS



INDEX

1. FOREWORD AND ACKNOWLEDGEMENTS	3
2. FOCUS AND BACKGROUND INFORMATION FOR TEACHERS	5
3. LINKS TO THE PRIMARY CURRICULUM	9
4. UNITS OF WORK AND ACTIVITY SHEETS	25

FOLDER SLEEVE

1: CD: RIPPER II - **GROWING KIDS ON FARMS. An education resource for primary schools**

- *PDF and Word files - for reproduction and insertion of state learning outcomes on activity sheets*
- *Supporting resources indicated in **Units of work** - PDF files and Image slideshows*

2: STORYBOOK: **GEENA AND HARRY'S FARM**





1. FOREWORD AND ACKNOWLEDGEMENTS



FOREWORD

This resource aims to support educators of primary school age children, with ideas and activities that promote child safety on farms; and an understanding of safety within the context of Australian farming environments and production systems. Information provided is consistent with the research of farm injury risks and solutions and is presented to in a format supportive of outcomes based / learner-centred approaches to primary education. The resource includes background information for teachers; links to state curricula; and units of work framed around topics which can be used in series or individually or to suit programming needs. Reviews of child safety education resources produced by other organisations are also provided.

Whilst child safety is an adult responsibility, children can learn age-appropriate knowledge and skills for identifying, assessing and dealing with farm injury risk as they grow. This resource supports this process and fosters the development of positive safety attitudes, behaviours and decision-making amongst the next generation of farmers, graziers and horticulturalists.

ACKNOWLEDGEMENTS

This resource has been made available as part of the Child Safety on Farms Program, a work of Farmsafe Australia. The Program has been funded by the Commonwealth Department of Health and Ageing; and is based at The Australian Centre for Agricultural Health and Safety, (ACAHS) Moree NSW, part of the School of Public Health, University of Sydney.

Sponsorship for the resource has been kindly obtained from Cargill Australia. CEO for Cargill Australia, Mr. Ralph Selwood states that:

"Working with the rural community, Cargill recognise that farms can be a dangerous place. The statistics show that children are killed or seriously injured in farm-related accidents each year. For this reason we decided it was important to support this education resource and to promote it in the rural community.

We believe there is enormous benefit from children getting a thorough appreciation of the risks that they may face in rural situations, together with understanding how to protect themselves and others. Not only can it help safe guard the children themselves, but they can be an extra set of eyes for the adults."

This new edition of the resource supports key evidence-based recommendations of the Child Safety on Farms Program and reflects learning needs as agreed by the Education Working Group. Teaching content builds upon concepts presented in the first Rural Injury Prevention Primary Education Resource (RIPPER, 1998) developed by Ms. Lyndall Horton-Jones for the Victorian Farmers Federation. A number of activities from the original resource have been reformatted and integrated into the new edition with kind permission.

New edition contributors:

Written by:	Julie Depczynski; ACAHS
Design + Art direction:	Paul Beseler; pbeseler@mac.com
Illustrated by:	Dean Tonkin; dean@deantonkin.com Caroline Keys; car_keys@bigpond.com
Photographs:	Australian Centre for Agricultural health and Safety CSIRO Land and Water
Printing:	Sovereign Press Pty Ltd

For further information:

Child Safety on Farms Program, Farmsafe Australia
Australian Centre for Agricultural Health & Safety
The University of Sydney
PO Box 256 Moree NSW 2400
Ph. 02 6752 8218 Fax 02 6752 6639
Email: ag-health@health.usyd.edu.au

Suggested citation:

Farmsafe Australia 2008 (revised edition).
RIPPER II: Growing Kids on Farms.
An Education Resource for Primary Schools.
Australian Centre for Agricultural Health and Safety, Moree

ISBN: 1 876491 671

© Farmsafe Australia and Victorian Farmers Federation, 2008



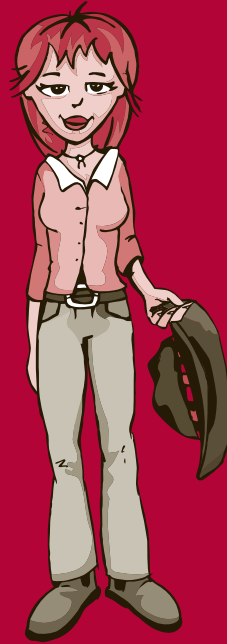

2. FOCUS AND BACKGROUND INFORMATION FOR TEACHERS



FOCUS OF THE RESOURCE

This resource aims to provide teachers with a variety of ideas for promoting safety on farms within the context of exploring different Australian farming environments and production systems. In particular, learning experiences aim to reduce the risk of injury to children on farms by increasing awareness and understanding of farm hazards; helping children develop strategies and behaviours to prevent injuries; and by fostering the development of positive attitudes toward safety.

BACKGROUND INFORMATION FOR TEACHERS

1. The role of teachers

Teachers play an essential role in safety education of children, in partnership with parents and carers. Child safety messages and processes can be integrated into learning throughout the curricula, particularly within Health and Physical Education and Humanities (Society and Environment) subject areas, as they are variously referred to across the states.

Key messages delivered through the formal education sector compliment those being promoted through the wider farming community. Teachers can be involved in educating children for safety both directly and indirectly (eg. checking the appropriateness of images and text of classroom resources that sometimes portray children engaging in unsafe practices – such as riding on tractors). Teaching children strategies to deal with the major injury risks on farms within their domain of influence, can help to ensure their immediate safety. Teaching children the processes involved in making farms safer, is a life skill consistent with workplace safety requirements and directions.

2. Facts about child injury on farms and rural properties

Children can have enriching life experiences on farms - yet are exposed to a variety of workplace hazards not accessible to most children. Children are seriously injured on Australia farms and rural properties each year.

- There is about one farm- related child death in Australia every 3 weeks ¹.
- Around eight or more children are admitted to hospitals with farm related injuries each week ².
- Many more children with farm related injuries present at Emergency Departments of country hospitals and to General Practitioners ³.

Key problem areas identified through the research are:

- Drowning (0-5 years)
- Injury associated with farm machinery
- Injury associated with other farm vehicles
- Injury associated with 2 and 4 wheeled motorcycles (5-15 years)
- Horse-related injury (5-15 years)



Other hazards/causes of injury on farms include silos, chemicals, noise and firearms. However, injuries from these do not appear prominently in injury statistics.

One prominent study⁴ of fatalities on farms found that one third of child fatalities were visitors to the farm. Boys were killed more often than girls (3:1) and three-quarters of children were playing at the time in an area where farm work was being carried out.

Younger children are at greater risk, with two thirds of child fatalities on farms being under five years of age. Older children 5-15 years are hospitalised or present to emergency departments with non-fatal injury more than younger children, perhaps reflecting more leisure activities with horses and motorbikes and their expanding work roles.



1. Pollock K, Fragar L, Morton C 2007 *Traumatic Deaths in Australian Agriculture - The Facts*. Rural Industries Research and Development Corporation and Australian Centre for Agricultural Health and Safety, Moree

2. Kreisfeld R 2007 *Hospitalised farm injury among children and young people 2000-01 to 2004-05 AIHW NISU Proceedings of the Farmsafe Health and Safety Conference Adelaide Sept 2007*

3. Franklin R and Crosby J 2002 *NSW Public Health Bulletin Vol 13 No.5 May 2005*

4. Franklin, R, Mitchell, R, Driscoll, T, Fragar, L. 2000. *Farm-related Fatalities in Australia, 1989 - 1992* Australian Centre for Agricultural Health & Safety, National Occupational Health & Safety Commission, & Rural Industries Research & Development Corporation, Moree NSW.

3. Why children are injured on farms

a. The nature of farm hazards and child injury

There are a wide variety of hazards present on farms and rural properties that are not present in urban homes. Major types of injury sustained by children on farms are drowning, head injury, fractures and crush injury. Examples of the main types of hazards to children on farms are shown in **Table 1**.

Table 1. Main types of hazards and mechanisms of injury			
Water	Horses and other animals	Farm vehicles and machinery	Other hazards
Dams	Horses	Family cars and utilities	Chemicals
Creeks and rivers	Cattle	Tractors	(eg. pesticides, herbicides, fuels, fertilizers, solvents)
Irrigation channels	Sheep	Motorbikes – 2 wheeled	Grain/hay storage (eg. silos, haystacks, grain bins)
Effluent ponds	Snakes	ATV's – All terrain vehicles (4 wheeled)	Electricity
Tanks and troughs	Dogs	Trucks	(eg. powerlines, circuit wiring)
Dips and pits		Harvesters	Firearms
Post holes after rain		Power take off drives (PTO's)	Sun exposure
Household hazards: baths, pools, spas and open containers		Machinery attachments (eg. ploughs, slashers)	Noise exposure
		Workshop tools (eg. angle grinders, saws)	Bushfires
		Mowers	
Child wanders away from safe area /supervision and falls into water;	Falls whilst riding horses	Falls and vehicle runovers	Falls; crush; chemical exposure; firearm discharge; excessive sun and noise exposure
Child swims without adequate safeguards and supervision	Kicks, bites, crush injuries whilst handling animals	Lacerations	

b. Frequency / duration of exposure to risk

Farm families work where they live and off-farm childcare is not always available. Children on farms can frequently engage in / are exposed to hazards and activities with serious consequences if something goes wrong. This places them at particular risk.



c. A child's development – inconsistent and unpredictable behaviour

Children are **not always** able to make the right judgements in the interests of their own safety. Children tend to focus on play and the 'here and now' rather than seeing the 'big picture'. As they grow they seek greater independence, but often cannot fully foresee consequences of their actions. Children are:

- Smaller than adults
- Have limited experience
- Are easily distracted
- Tire easily
- Have a poor sense of danger
- Increasingly mobile and seek independence
- Influenced by peer pressure
- Impulsive and take risks beyond their capabilities
- Often overwhelmed / slow to respond in unexpected / dangerous situations.
- Don't always remember / apply abstract concepts and rules across different situation

Children can learn appropriate safety behaviours as they grow, but this requires on-going education and training with regular reinforcement and practice.

4. Key elements for child safety on farms

Adults, rather than children, can most effectively control the safety risks to children on farms. Adults are in most control of the farm environment and their choices determine the activities and hazards children are exposed to.

The following key recommendations are based on a review of research which has indicated the most effective ways to prevent children being injured on farms. Farmsafe Australia is working to promote these within the wider farming community through industry networks, media campaigns and through policy.

Best practice recommendations need to be reinforced through a range of reputable sources, including the formal education sector. Whilst not in a position of control, children can learn essential safety behaviours as well as learn the processes for creating safer farms environments as the adults of tomorrow.

Key recommendations for child safety on farms

1. Create a safe play area for children, such as a securely fenced house yard.

2. Have safety rules that everyone knows and follows.
Minimum rules to include:

- Children stay in the safe play area unless an adult takes them out and looks after them (close and active adult supervision)
- Children always wear seat belts when in cars, utes and trucks
- Children do not ride on tractors, ATV's or on the back of utes
- Children always wear helmets when riding any bikes or horses

3. Develop a system to identify / reduce hazards and minimize risk using a variety of control options.

1. A safe play area, such as a securely fenced house yard, can help prevent unsupervised access of children to farm hazards; and help define the boundary between safe and unsafe places – especially for young children. Recognising a safe area and staying in it unless accompanied by an adult are priority learning goals for school entry children.

2. Developing appropriate safety rules to their development can help to keep children safe on farms, with the support of adults. The above recommended rules are consistent with messages from other programs such as road/traffic safety, water safety and bike safety.

3. A systematic process can be used to ensure safety solutions fit the needs of individual farms/situations. Consistent with the primary school curriculum, children can learn to identify specific farm hazards, assess risk and explore possible solutions and plan for safety. This process is a life skill that becomes directly relevant for farm/ workplace safety management as children grow to become adults.

Assessing risk can provide scope for exploring the stories of children; activities they engage in on farm; consequences of safe/unsafe actions; and family roles / maturity for different farm activities / tasks.

Hierarchy of control for child safety on farms

1. Remove / eliminate child safety hazards

eg. Fill in old sheep dips, cover tanks, remove keys

2. Substitute for a hazard of lesser risk

eg. Size / age appropriate horses and bikes

3. Engineer/design for safety

eg. Create securely fenced safe play areas, speed limited throttle on motorbikes

4. Safe practice and safety rules

eg. Family rules that everyone follows (as above); specific training and supervision for farm tasks to match the child's age and ability

5. Personal protective equipment

eg. Helmets and boots for motorcycle / horse riders; sunscreen and hat

6. First aid

eg. Learn First aid and resuscitation skills

A variety of solutions can be explored, although emphasis on the evidence based recommendations is advised.

Exploring ways to behave safely in different situations and create safer environments is consistent with the 'heirarchy of control' framework familiar to many farm families in Occupational Health and Safety (OHS) management.

The '**heirarchy of control**' is used to describe levels of injury prevention action. It refers to the principle of creating safer environments by firstly trying to eliminate or reduce hazards where possible and design /engineer for safety.

After these higher order measures are explored, safe practices and use of protective equipment may also be required – but these tend to be less effective. Using a variety of controls will be more reliable.

Whilst many prevention measures higher in the heirarchy are under the control of adults, older primary age children can learn the processes involved in creating safer farms and advocate for developing safe practice and safety rules with their families at home.

BACKGROUND INFORMATION FOR TEACHERS CONT...

Further resources and contacts:

A selection of independent programs and organisations have resources available for loan or purchase that support key child safety on farms messages. Some of these are referred to through this resource as the basis for some suggested activities, but need to be obtained independently through each organisation.

1. Supporting primary school resources:

Farm Safety is Fun Early Childhood Program and Resource Kit

Ms. Vicki Connell; vickiconnell@austarnet.com.au,
Ph.(02) 6027 1560

Farm safety: A kid's perspective (video)

Laura & District Hospital, SA. On loan through ACAHS (02) 6752 8210

Giddy Goanna (activity books, demonstration days, DVD, CD)

Ms. Pam Brown; Giddy@giddygoanna.org, Ph.(07) 4639 3888

No helmet, no boots, no way (poster)

Gloucester Community Health.

Limited stock from ACAHS, Ph: (02) 6752 8210

Royal Life Saving Society

www.royallifesaving.com.au

Workboot Series (farm education books)

Kondinin Group; Ph.(08) 9478 3343, www.kondinin.com.au

Worksafe KIDS Education Program

Integrated Safety Education Program;

Ph: 1300 734 733, www.kidsfoundation.org.au

2. Resource persons

Some areas have Community Health Centres or locally based farm safety action groups with members that may be willing to speak about farm safety with children. For more information, contact your local Health Service or State Farmsafe Organisation.

3. Field Day Programs

There are a number of programs in operation at regional level, based on the principle of interactive demonstration / field days. Some are arranged around the theme of farmsafety specifically, or safety generally. These programs provide a "hands on / practical" experience that compliments classroom learning.



Information or advice on farm-safety field days for school children can be obtained from the following programs:

Name	Field day resource/program	Nature of assistance	Contact
Wellington Farmsafety Action Group (Gippsland, Victoria)	Farm Safety Field Day Program for Grade 5 & 6	Information and advice on conducting a field day program	Jill Tucker; aces1@netspace.net.au Ph. (03) 5144 1234
Giddy Goanna Program	Giddy Goanna: Health & Safety Demonstration Day Resource Kit	Resource manual for purchase	Pam Brown Giddy Goanna Ltd. Giddy@giddygoanna.org Ph. (07) 4639 3888
Farmsafe QLD. Queensland Workplace Health & Safety	Safety on the Land Program	Information on resource, local field days and contacts	Fiona O'Sullivan; fiona.osullivan@dir.qld.gov.au , Ph. (07) 4987 7725
NSW Farmsafe	Future Farmers: A Rural Health & Safety Resource for High School Students	On-line Secondary School Resource FSAG contacts in NSW	On-line resource: www.aghealth.org.au , aghealth@health.usyd.edu.au , Ph. (02) 6752 8214



3. LINKS TO THE PRIMARY CURRICULUM



LINKS TO THE PRIMARY CURRICULUM

A summary of links to the most directly relevant curriculum outcomes for each state is provided, focusing on content-oriented outcomes within the Health and Physical Education (HPE) and Studies of Society and Environment (SOSE) curricula, as variously named across the states.

These reflect an attempt to match goals for child injury prevention on farms with learning outcomes for safety in the context of investigating farms as places of natural and social significance. Activities also support literacy and communication outcomes for English; and Technology curricula such as use of problem-solving, communication and thinking skills.

This section refers to curriculum outcome statements for each state, accessed on-line and current as of April 2008. Alignment to national learning goals and standards are increasingly being articulated in state curricula documents as part of an ongoing curricula revision process.

Terms

Key learning areas (KLAs) are examples of curriculum organisers. They represent one of a number of ways of depicting the curriculum (or emphasis therein) to focus teaching and learning.

The Australian Education Council (in 1991) adopted eight KLAs: English, Health and Physical Education, Languages other than English, Mathematics, Science, Studies of Society and Environment, Technology, and The Arts. The belief that these eight KLAs could effectively encapsulate the range of desirable learnings offered in schools Australia-wide was affirmed in the Adelaide Declaration (MCEETYA, 1999).

Strands are groupings of the concepts in each of the eight KLAs.

Levels, stages, bands or standards (as variously named) are points along the developmental continuum of student learning, listed in order of increasing sophistication and complexity of learning outcomes.

Learning outcomes (CLOs) or essential learnings are what students should know and be able to do as a result of planned learning experiences.

Statements on essential learning outcomes, achievements or performance criteria (as variously named), are outcomes unique to a particular KLA in terms of the knowledges, practices and dispositions that should be developed by students who engage in that KLA.

CD FORMAT – INSERTION OF STATE-SPECIFIC LEARNING OUTCOMES

Activity sheets within each level of this resource have hyperlinks which enable teachers to click on the relevant curricular learning outcomes for their state. These can be inserted onto activity sheets electronically prior to in-school reproduction of templates. These can be used as a record to indicate that specified learning outcomes have been achieved. The following is an example of a state specific activity sheet with NSW Early Stage 1 (Level 1) PDHPE and HSIE learning outcomes inserted from curricular summaries of this resource.

TOPIC 4: ANIMALS ON THE FARM (L1.AS4.1)			
Name:	Class:		
Learning Outcomes: NSW			
IRES1.11 Identifies how individuals care for each other.			
SLES1.13 Demonstrates a developing awareness of the concepts of safe and unsafe living.			
SSES1 Identifies ways in which their own needs and the needs of others are met, individually and cooperatively.			
Tasks and Indicators	Achieved	Working towards	Not Yet
Identifies safe and unsafe places on a farm			
Identifies animals found on farms			
Identifies safety rules when playing with animals			
ACTIVITY: 1. COMPARE THE PICTURES BELOW			

AUSTRALIAN CAPITAL TERRITORY

Learning activities within this resource can be related to the following curriculum outcomes for:

- Health and Physical Education - HPE
- Science and Social Science

Level	Key learning Area	Strand	Learning Outcomes or Essential Learning Achievements
Early Childhood Band (Preschool to Year 2)	HPE	ELA 12 Takes action to promote health ...safety	<p>Students have opportunities to understand and learn:</p> <p>12.EC.7 ways to protect themselves from the sun and when near water (e.g. water safety awareness)</p> <p>12.EC.8 ways they can keep themselves safe as pedestrians (e.g. hold an adult's hand) and as passengers (e.g. use of seatbelts)</p> <p>12.EC.9 rules for safe play and appropriate behaviour at home and at school</p> <p>12.EC.12 to recognise safe and unsafe situations</p> <p>12.EC.13 to recognise injury and how to contact emergency services</p> <p>12.EC.14 to respond to situations that make them feel unsafe and identify people who can help.</p> <p>Markers of progress - Students can... ...distinguish between feeling safe and unsafe ...identify safe and unsafe situations ...describe protective strategies they can use in unsafe situations ...identify people who can keep them safe and help them when they feel unsafe</p>
	Science	ELA 20 Acts for an environmentally sustainable future	<p>Students have opportunities to understand and learn:</p> <p>20.EC.1 elements of the natural environment that humans, animals and plants need for survival</p> <p>20.EC.2 different living things in their local environment and some observable relationships between living things and their environment</p> <p>20.EC.3 how people cooperate to care for places in a community</p> <p>20.EC.4 why it is important to conserve resources, protect the environment and participate in positive environmental action.</p> <p>20.EC.5 observe and discuss changes evident in the local environment, both natural (e.g. seasonal changes) and those caused by human action (e.g. changes to the built environment)</p> <p>Markers of progress - Students can... ...identify a range of living things in their local environment and some elements of the natural environment that humans, animals and plants need for survival ...describe changes they have observed in their local environment ...explain ways they can care for their environment at school ...know that some resources can be reused and recycled and describe some of the ways this happens at school and at home</p>
	Social Sciences	ELA 21 Understands about Australia and Australians ELA 22 Understands and values what it means to be a citizen within a democracy	<p>Students have opportunities to understand and learn:</p> <p>21.EC.1 Australia as a large land mass with a variety of environments (e.g. varied landscapes, places where people live)</p> <p>21.EC.2 some places and landmarks in the local community local community.</p> <p>21.EC.5 Indigenous people as the first Australians and aspects of Australia's history predating British colonization</p> <p>Markers of progress - Students ...have a sense of Australia's shape and geographical diversity ...can describe the location of places that are familiar to them in the local community ...know that Indigenous Australians are the first inhabitants of Australia</p> <p>Students have opportunities to understand and learn:</p> <p>22.EC.1 personal rights and responsibilities in familiar contexts (e.g. home)</p> <p>22.EC.2 the key purpose rules have in protecting people's rights and responsibilities ...and in supporting the values that help communities live and work together...</p> <p>Markers of progress - Students can... ...identify their rights and responsibilities as citizens ...discuss the purpose of rules and understand there are consequences for breaking them.</p>

AUSTRALIAN CAPITAL TERRITORY *CONT.*

Learning activities within this resource can be related to the following curriculum outcomes for:

- Health and Physical Education - HPE
- Science and Social Science

Level	Key learning Area	Strand	Learning Outcomes or Essential Learning Achievements
Later Childhood Band (Year 3 to Year 5)	HPE	ELA 12 Takes action to promote health ...safety	<p>Students have opportunities to understand and learn:</p> <p>12.LC.10 when and how to protect themselves from the sun</p> <p>12.LC.11 safe practices as pedestrians (e.g. near buses), passengers and on wheels (e.g. using bicycles, skateboards and roller blades)</p> <p>12.LC.12 how the places people live, work and play can influence their health</p> <p>12.LC.13 emergency first aid</p> <p>12.LC.17 assess options and consequences in responding to unsafe situations</p> <p>12.LC.18 identify risk situations, people and places and ways to respond</p> <p>12.LC.19 plan how to take responsibility for their own safety and that of others (e.g. swim only in safe places, wear seatbelts and helmets)</p> <p>12.LC.20 formulate and practise action plans for accidents and medical emergency situations at home, at school and in the local area</p> <p>Markers of progress - Students can... ...identify ways in which they can protect themselves from harm ...describe ways they can act to increase the safety and health of those around them</p>
	Science	ELA 20 Acts for an environmentally sustainable future	<p>Students have opportunities to understand and learn:</p> <p>20.LC.1 natural cycles and systems in the environment (e.g. water cycle, food chains)</p> <p>20.LC.2 the concept of habitat and the diversity of living things within a habitat</p> <p>20.LC.3 some effects of human action on natural environments (e.g. land clearing, air and water pollution) to human or natural events (e.g. school. nearby creek)</p> <p>20.LC.6 how protecting the environment requires that people work together as citizens and consumers and participate in appropriate actions</p> <p>20.LC.10 explore probable and preferred futures in relation to environmental issues familiar to them and discuss actions needed to make (these) happen.</p> <p>Markers of progress - Students can... Identify built and natural elements of familiar environments describe some Inter relationships between parts of natural cycles and systems investigate and describe the impact of human activity on familiar environments</p>
	Social Sciences	ELA 21 Understands about Australia and Australians	<p>Students have opportunities to understand and learn:</p> <p>21.LC.1 a range of natural environments and features in Australia, how these have shaped Australia's settlement and development and how people have shaped these environments and land uses</p> <p>21.LC.10 identify and represent key features of places in Australia on maps</p> <p>Markers of progress - Students ...know there are dynamic relationships between people and places in Australia ...can locate some significant landmarks, places and population centres on a map</p>

AUSTRALIAN CAPITAL TERRITORY *CONT.*

Learning activities within this resource can be related to the following curriculum outcomes for:

- Health and Physical Education - HPE
- Science and Social Science

Level	Key learning Area	Strand	Learning Outcomes or Essential Learning Achievements
Early adolescent Band (Year 6 to Year 8)	HPE	ELA 12 Takes action to promote health ...safety	<p>Students have opportunities to understand and learn:</p> <p>12.EA.10 factors influencing risk-taking and possible consequences of risk behaviour</p> <p>12.EA.11 strategies to minimise harm (e.g. acquiring knowledge, safe attitudes, developing personal skills, identifying support networks)</p> <p>12.EA.12 basic procedures for first aid and emergency assistance.</p> <p>12.EA.18 identify risk factors and behaviours in real-life situations and identify and assess strategies to minimize harm (e.g. on the road, at a party, in water environments, as a passenger, being offered drugs)</p> <p>12.EA.19 recognise unsafe situations and make judgements about when it is necessary to seek help from others.</p> <p>Markers of progress - Students can... predict the consequences of risk behaviours associated with safety and identify and assess strategies to minimise harm.</p>
	Science	ELA 20 Acts for an environmentally sustainable future	<p>Students have opportunities to understand and learn:</p> <p>20.EA.2 some of the processes by which human activities change natural environments in positive and negative ways (e.g. reducing feral animal populations, tourism, deforestation)</p> <p>20.EA.10 examine issues of sustainability of the natural, built or social environment, extending from local to global perspectives ...</p> <p>Markers of progress - Students can.... ... describe some of the processes by which human activities change natural environments in positive and negative ways and investigate practical ways of conserving resources. ... identify issues of sustainability of the natural, built or social environment, understand the need for individual and collective actions to address them, and discuss strengths and limitations of possible actions.</p>
	Social Sciences	ELA 21 Understands about Australia and Australians	<p>Students have opportunities to understand and learn:</p> <p>21.EA.1 characteristics that make Australia unique (e.g. landforms, basins, climate, weather, resources, vegetation, flora and fauna, natural hazards, latitude and longitude)</p> <p>21.EA.2 how the geography of Australia influences what people do to survive and prosper (e.g. where people live, the location of natural resources and the development of industries and cities)</p> <p>21.EA.8 current issues and challenges facing the local community and Australian society.</p> <p>21.EA.9 use geographical language, tools and conventions to interpret and create representations of Australia's physical and human geography (e.g. a variety of maps, diagrams, images and data)</p> <p>Markers of progress - Students can.... ...locate and describe key features of Australia's landscape. ...explain how geographical features influence where people live and what they do.</p>

NEW SOUTH WALES

Learning activities within this resource can be related to the following curriculum outcomes for:

- Human Society and Its Environment - HSIE
- Personal Development, Health and Physical Education - PDHPE

Level	Key learning Area	Strand	Learning outcomes
Early Stage 1	PDHPE	Communicating	COES1.1 Expresses feelings, needs and wants in appropriate ways.
		Decision-making	DMES1.2 Identifies some options available when making simple decisions.
		Problem-solving	PSES1.5 Seeks help as needed when faced with simple problems.
		Inter-personal relationships	IRES1.11 Identifies how individuals care for each other.
		Safe Living	SLES1.13 Demonstrates a developing awareness of the concepts of safe and unsafe living.
	HSIE	Roles, rights and responsibilities	SSES1 Identifies ways in which their own needs and the needs of others are met, individually and cooperatively.
Stage 1	PDHPE	Communicating	COS1.1 Communicates appropriately in a variety of ways.
		Decision-making	DMS1.2 Recalls past experiences in making (safe) decisions.
		Problem-solving	PSS1.5 Draws on past experiences to solve familiar problems (eg. safety)
		Inter-personal relationships	IRS1.11 Identifies the ways in which they communicate, cooperate and care for others.
		Safe Living	SLS1.13 Recognises that their safety depends on the environment and the behaviour of themselves and others.
	HSIE	Patterns of Place and Location	ENS1.5 Compares and contrasts natural and built features in their local area and the ways in which people interact with these features.
		Relationship with Places	ENS1.6 Demonstrates an understanding of the relationship between environments and people.
		Resource systems	SSS1.7 Explains how people and technologies in systems link to provide goods and services to satisfy needs and wants.
		Roles, rights and responsibilities	SSS1.8 Identifies roles and responsibilities within families, schools and the local community, and determines ways in which they should interact with others.

Learning activities within this resource can be related to the following curriculum outcomes for:

- Human Society and Its Environment - HSIE
- Personal Development, Health and Physical Education - PDHPE

Level	Key learning Area	Strand	Learning outcomes
Stage 2	PDHPE	Communicating	COS2.1 Uses a variety of ways to communicate with and within groups.
		Decision-making	DMS2.2 Makes decisions as an individual and as a group member.
		Problem-solving	PSS2.5 Uses a range of problem-solving strategies.
		Inter-personal relationships	IRS2.11 Describes how relationships with a range of people enhance well-being.
		Safe Living	SLS2.13 Discusses how safe practices promote personal well-being.
	HSIE	Patterns of Place and Location	ENS2.5 Describes places in the local area and other parts of Australia and explains their significance
		Relationship with places	ENS2.6 Describes people 's interactions with environments and identifies responsible ways of interacting with environments
		Resource systems	SSS2.7 Describes how and why people and technologies interact to meet needs and explains the effects of these interactions on people and the environment
Rights and responsibilities		SSS2.8 Investigates rights, responsibilities and decision-making processes in the school and community and demonstrates how participation can contribute to the quality of their school and community life.	
Stage 3	PDHPE	Communicating	COS3.1 Communicates confidently in a variety of situations.
		Decision-making	DMS3.2 Makes informed decisions and accepts responsibility for consequences.
		Problem-solving	PSS3.5 Suggests, considers and selects appropriate alternatives when resolving problems.
		Inter-personal relationships	IRS3.11 Describes roles and responsibilities in developing and maintaining positive relationships.
		Safe Living	SLS3.13 Describes safe practices that are appropriate to a range of situations and environments.
	HSIE	Identities	CUS3.2 Describes different cultural influences and their contribution to Australian identities.
		Relationship with places	ENS3.6 Explains how various beliefs and practices influence the ways in which people interact with, change and value their environment.

NORTHERN TERRITORY

Learning activities within this resource can be related to the following curriculum outcomes for:

- Health and Physical Education - HPE
- Studies of Society and Environment – SOSE

Level	Key learning Area	Strand	Learning outcomes
Band 1	HPE	Promoting Individual and Community Health	HP 1.1 Individual and Community Health and Safety....apply basic elements of health care and explain the importance of achieving a balance between the dimensions of health; identify health-care providers and services in the community and describe their role in keeping us healthy and safe
	SOSE	Environments	Env 1.1 Place, Landforms and Features....describe the relationship between people and natural/built environments
			Env 1.3 Natural Systems....explain the ways elements of simple natural systems are connected and identify themselves as part of a natural system
Band 2	HPE	Promoting Individual and Community Health	HP 2.1 Individual and Community Health and Safety....demonstrate ways in which health and well-being can be enhanced and maintained including investigating products, services and information
		Enhancing Personal Development & Relationships	PD 2.1 Human Development....identify the changes in growth and development that occur throughout life and identify factors that enhance personal relationships
	SOSE	Environments	Env 2.1 Place, Landforms and Features....investigate the distribution of natural/built features and natural/human resources and describe ways in which these features and resources interact and impact on one another Env 2.3 Natural Systems....analyse the interactions between elements of natural and human systems and investigate flows and cycles
Band 3	HPE	Promoting Individual and Community Health	HP 3.1 Individual and Community Health and Safety....analyse images of health, develop strategies to promote personal safety and well-being and investigate the health services available to different groups in the community
		Enhancing Personal Development & Relationships	PD 3.1 Human Development....identify the physical, social and emotional changes that occur during puberty and plan actions to manage these changes; explain how taking on different roles affects relationships and behaviours
	SOSE	Environments	Env 3.3 Natural Systems....describe features of eco-systems, explain their location and deduce the conditions which contribute to their distribution and/or change

Learning activities within this resource can be related to the following curriculum outcomes for:

- Health and Physical Education - HPE
- Studies of Society and Environment - SOSE

Level	Key learning Area	Strand	Learning outcomes
Foundational	HPE	Promoting the health of individuals and communities	<ul style="list-style-type: none"> • Students are developing an understanding of their physical health and safety and can demonstrate actions they can take to promote their health and safety. • Students are also developing an understanding of the variety of environments in which people live, work and play and can identify places that are special to them.
	SOSE	Place and Space	<ul style="list-style-type: none"> • Students are developing an understanding that there are different environments and can indicate which environment they are in. • Students are developing an understanding that each environment can be used in a variety of ways and can present information about their use of an environment
Level 1	HPE	Promoting the health of individuals and communities	<p>1.3 Students decide which people and things make environments and activities safe.</p> <p>1.5 Students explain how elements of different environments, in which people live, work and play, affect health.</p> <p>1.6 Students explain how adherence to rules can promote health.</p>
	SOSE	Place and Space	<p>PS 1.4 Students organise and present information about places that are important to them.</p> <p>PS D1.8 Students explain why particular places are safe environments for children.</p>
		Systems, resources and power	<p>SRP 1.5 Students discuss strategies that assist them to manage limiting situations.</p> <p>SRP D1.6 Students enact consequences of following and not following rules of familiar places.</p>
Level 2	HPE	Promoting the health of individuals and communities	<p>2.3 Students propose and demonstrate ways to promote personal safety and the safety of others.</p> <p>2.5 Students recommend ways they can care for their environments to promote and protect their health.</p>
	SOSE	Place and Space	<p>PS 2.1 Students identify how environments affect lifestyles around Australia.</p> <p>PS D2.8 Students describe how their present use of places may change over time to meet their changing needs and interests.</p>
		Systems, resources and power	<p>SRP 2.4 Students analyse information about their own and others' rights and responsibilities in various settings.</p>

Learning activities within this resource can be related to the following curriculum outcomes for:

- Health and Physical Education - HPE
- Studies of Society and Environment - SOSE

Level	Key learning Area	Strand	Learning outcomes
Level 3	HPE	Promoting the health of individuals and communities	<p>3.1 Students describe the impact of their own and others' behaviours on health, and propose personal and group actions which promote the dimensions of health.</p> <p>3.3 Students identify potentially hazardous situations and demonstrate actions to respond to unsafe and emergency situations.</p> <p>3.5 Students describe features of places where they live, work and play that influence the health of themselves and others, and propose ways they can help the people who are responsible for keeping these places healthy.</p> <p>D3.6 Students classify a range of actions, behaviours and attitudes as contributing positively or negatively to their health, and explain their reasons.</p>
			<p>PS 3.1 Students compare how diverse groups have used and managed natural resources in different environments.</p>
	SOSE	Place and Space	SRP 3.5 Students explain the values associated with familiar rules and laws.
Level 4	HPE	Promoting the health of individuals and communities	<p>4.1 Students recommend actions they can take to promote their health in response to social, biological or environmental factors.</p> <p>4.3 Students propose ways of responding to situations and behaviours that are unsafe, harmful or risky, after assessing options and consequences.</p> <p>4.5 Students identify aspects of their social and physical environments that enhance, or pose threats to, their health, and plan strategies for achieving healthy environments for themselves and others.</p> <p>D4.6 Students identify laws and policies that apply to their behaviours and discuss the impact of these on their health and safety.</p>
	SOSE	Place and Space	PS D4.8 Students develop an action plan to contribute to a positive outcome for an issue of personal concern.

SOUTH AUSTRALIA

Learning activities within this resource can be related to the following curriculum outcomes for:

- Health and Physical Education - HPE
- Studies of Society and Environment - SOSE

Level	Key learning Area	Strand	Learning outcomes
Standard 1 R - Year 2	HPE	Health of individuals and Communities	1.7 Understands and can demonstrate behaviours and strategies that promote their health and safety and that of others. <i>[In] [T] [KC6]</i>
	SOSE	Place, Space and Environment	1.4 Explains and communicates how people interact and identify with environments. <i>[Id] [In] [KC2] [KC6]</i> 1.5 Represents and categorises features of places and resources, using maps, contextual language and models. <i>[C] [KC2] [KC5]</i>
		Social Systems	1.11 Identifies the sources of some goods and services, and can explain the ways our daily living depends on them. <i>[In] [T] [C] [KC1]</i>
Standard 2 Year 3-4	HPE	Health of individuals and Communities	2.7 Plans and practises strategies to maintain safety in the home, school and community. <i>[F] [Id] [In] [T] [KC3]</i>
	SOSE	Place, Space and Environment	2.4 Shows and reports on understanding of the interrelationships between natural and built environments, resources and systems. <i>[In] [T] [KC2]</i> 2.5 Uses symbols, maps, models and flow-charts to describe the location of places and demonstrate relationships. <i>[T] [C] [KC2]</i> 2.6 Understands that people cause changes in natural, built and social environments, and they act together in solving problems to ensure ecological sustainability. <i>[F] [In] [KC6]</i>
Standard 3 Year 5 -6	HPE	Health of individuals and Communities	3.7 Identifies skills to deal with situations that pose a risk to their health and safety. <i>[In] [T] [KC1]</i>
	SOSE	Place, Space and Environment	3.5 Interprets and represents data about natural and built environments, resources, systems and interactions, both global and local, using maps, graphs and texts. <i>[In] [T] [C] [KC1] [KC2] [KC5]</i> 3.6 Identifies factors affecting an environmental issue, and reports on ways to act for sustainable futures. <i>[F] [In] [T] [KC1] [KC2]</i>
		Social systems	3.11 Analyses an example of the flows in provision of a product or service, including links to resources, money, transport, technology and communication, considering fairness for human and environmental sustainability. <i>[In] [T] [C] [C1]</i>
Standard 4 Year 7 - 8	HPE	Health of individuals and populations	4.7 Analyses and articulates the consequences of risk-taking and demonstrates behaviours to minimise harm. <i>[In] [T] [KC1] [KC2]</i>
	SOSE	Place, Space and Environment	4.4 Describes places in Australia and elsewhere according to their location, natural and built features, and population and resources. Students explain interrelationships, including the effects of human modifications. <i>[F] [In] [T] [KC1] [KC2]</i>

Activities within this resource can be related to the following performance criteria for:

- Health and Well-being
- Society and History

Standard	Key Learning Area	Strand	Performance Criteria
Standard 1	Health and Well-being	Understanding health and wellbeing	<p>Students will understand how to maintain and integrate the elements of a healthy lifestyle (PCI)... to...</p> <ul style="list-style-type: none"> • describe a personal state of being healthy or well (Stg2) • understand and use some common safety signs, instructions and behaviours (Stg3) <p>Students will use health knowledge to promote personal and group health and wellbeing (PC2)... to...</p> <ul style="list-style-type: none"> • understand and follow rules about health & wellbeing (Stg3)
	Society and History	Interactions with the environment	<p>Students will understand relationships between people, resources and places (PC3)</p> <ul style="list-style-type: none"> • Identify key features of natural & built places in their local community (Stg2) • Identify and describe places that are valued by the community (Stg3)
		Interconnections between systems	<p>Students will understand social, economic and political systems and the connections between them (PC4)... to...</p> <ul style="list-style-type: none"> • Identify different people who supply goods (Stg2)
Standard 2	Health and Well-being	Understanding health and wellbeing	<p>Students will understand how to maintain and integrate the elements of a healthy lifestyle (PCI)... and...</p> <ul style="list-style-type: none"> • understand the purpose of safety rules and describe actions to promote personal safety (Stg6) <p>Students will use health knowledge to promote personal and group health and wellbeing (PC2)... to understand...</p> <ul style="list-style-type: none"> • how to formulate a simple plan to promote health & wellbeing (Stg6) • individual actions can affect personal & group wellbeing (Stg5) • immediate consequences of actions for health & wellbeing (Stg6)
	Society and History	Interactions with the environment	<p>Students understand relationships between people, resources and places (PC3)</p> <ul style="list-style-type: none"> • recognise how different places are identified by geographical features (Stg5) • identify particular land uses that help meet community needs (Stg5) • recognise a connection between where people live and how they live (Stg6)
		Interconnections between systems	<p>Students will understand social, economic and political systems and the connections between them (PC4)... to...</p> <ul style="list-style-type: none"> • recognise there are stages in production of goods and the provision of services (Stg6)
Standard 3	Health and Well-being	Understanding health and wellbeing	<p>Students understand how to maintain and integrate the elements of a healthy lifestyle (PCI)... to...</p> <ul style="list-style-type: none"> • identify situations and behaviours that are safe or unsafe (Stg7) • identify how situations can be made safer (Stg8) • understand and propose personal actions to promote personal and group safety (Stg9) <p>Students use health knowledge to promote personal and group health and wellbeing (PC2)... to understand...</p> <ul style="list-style-type: none"> • how to use particular personal & social skills in planning (Stg 8) • some factors that influence personal choice (Stg 9)
	Society and History	Interactions with the environment	<p>Students understand relationships between people, resources and places (PC3)... to identify / understand that...</p> <ul style="list-style-type: none"> • maps can be used to show information about human activity (Stg9) • conflicting values can affect decisions about land use (Stg9) • human activity can change landscapes over time (Stg8) • how places & resources affect where people live & the way people live (Stg7) <p>Students will understand social, economic and political systems and the connections between them (PC4)... to...</p> <ul style="list-style-type: none"> • understand that wants can sometimes be unlimited and difficult to attain (Stg9) • recognise that there are different types of industry (Stg8) • understand that some resources are scarce and need to be conserved (Stg7)

Activities within this resource can be related to the following Essential Learning Standards for:

- Physical, Personal and Social Learning
- Discipline based learning (Humanities)

Level	Strand	Domain	Learning focus
Level 1	Physical, Personal and Social Learning	Health and Physical Education <i>(Health knowledge and promotion)</i>	Students learn to identify those environments where they feel confident and those where they may be afraid or concerned for their safety. They practice how to respond to situations that make them feel unsafe, and learn about who can help them. They learn about local signs and symbols related to safety and explore possible actions to take when they feel threatened or unsafe. Students explore their emotions and identify the different ways in which people express and respond to emotions.
		Civics and citizenship	Students learn about...and compare classroom and family rules and other rules that they know...Students explore their responsibilities and rights and those of others in familiar contexts.
Level 1	Discipline based learning	Humanities	<p>Students draw on their own experience to help them understand the world around them. Through activities such as...examining photographs...and visits from community members, they learn about the concepts of...change and continuity.</p> <p>Through narratives, personal stories and celebrations students begin to learn about the cultures and histories that have contributed to Australian society and by seeing and hearing about other places outside their experience they begin to consider how and why other times and places are different from their own.</p> <p>Students develop spatial awareness through structured experiences within their immediate environment. They investigate the relative location, direction and distance of their home, school...and other significant features of their environment and begin to understand the geography of their local area...They draw simple pictorial maps from their developing mental maps of familiar environments. Students explore how and why natural factors...and human activities...affect their lives.</p>
		Humanities	<p>Students begin to identify the benefits of safe behaviours and learn how they can protect and increase their health and safety and the health and safety of others. In considering personal safety issues, they discuss the way various situations and behaviours affect the way they feel, and develop personal responses to such behaviours and situations.</p> <p>Students explore people's needs at various stages of development and recognise that some needs apply to all stages of life.</p>
Level 2	Physical, Personal and Social Learning	Health and Physical Education <i>(Health knowledge and promotion)</i>	<p>Students identify the range of groups to which they, their family members and their class belong...They explore the roles, rights and responsibilities of various family and community members. They discover why groups and communities have rules, begin to question rules which they believe are unfair, and make suggestions about improving the rules within the community.</p> <p>Students investigate the ways individuals, families, groups and communities can work to improve their environment.</p>
		Civics and citizenship	<p>Students develop their awareness of spatial concepts and use terms that demonstrate an understanding of absolute and relative locations. With guidance, they recognise and point to their (home) on an appropriate map. They recognise...and can locate Australia and other places with which they have links. Students learn to identify and name physical features and distinguish them on the basis of variables, including size (scale/height/distribution) and colour. Through observation, they investigate and describe elements of the natural and built environments in their local area. Students think about environmental differences, locally and in other parts of Australia...and why these differences exist.</p> <p>Students begin to grasp the role and importance of the various cultural groups that make up the Australian community, including Aboriginal and Torres Strait Islander communities. They explore what their local area might have looked like before European settlement.</p> <p>Students are introduced to the concept of resources and their management, and begin to understand how resource use reflects community interdependence and sustainability. They begin to understand how local resources are used to make products which meet local people's needs and the needs of people in other places...</p>
Level 2	Discipline based learning	Humanities	<p>Students begin to identify the benefits of safe behaviours and learn how they can protect and increase their health and safety and the health and safety of others. In considering personal safety issues, they discuss the way various situations and behaviours affect the way they feel, and develop personal responses to such behaviours and situations.</p> <p>Students explore people's needs at various stages of development and recognise that some needs apply to all stages of life.</p>
		Humanities	<p>Students identify the range of groups to which they, their family members and their class belong...They explore the roles, rights and responsibilities of various family and community members. They discover why groups and communities have rules, begin to question rules which they believe are unfair, and make suggestions about improving the rules within the community.</p> <p>Students investigate the ways individuals, families, groups and communities can work to improve their environment.</p>

Activities within this resource can be related to the following Essential Learning Standards for:

- Physical, Personal and Social Learning
- Discipline based learning (Humanities)

Level	Strand	Domain	Learning focus and standards
Level 3	Physical, Personal and Social Learning	Health and Physical Education <i>(Health knowledge and promotion)</i>	<p>Students investigate a variety of scenarios identifying potential hazards and harms at home, at school and in the community, using given criteria such as a home safety checklist. They begin to explore the relationship between safety, risk and challenge, with an emphasis on developing their knowledge and understanding of strategies and skills to reduce harms, prevent accidents and create safe and supportive environments...</p> <p>Students explore how the school and community contribute to the health (and safety) of its members, both through the impact of its physical and social environments and through the services and facilities it provides...</p> <p>At Level 3 Standard, students can:</p> <ul style="list-style-type: none"> • identify basic safety skills and strategies at home, school and in the community, and describe methods for recognising and avoiding harmful situations. • describe how physical and social components in the local environment contribute to wellbeing and identify how health services and products address the health (and safety) needs and concerns of the local community.
		Civics and citizenship	<p>Students develop knowledge about their community and environment and a sense that individuals contributions care for and improve the environment, their own lives and others.</p> <p>At Level 3 Standard, students can:</p> <ul style="list-style-type: none"> • explain why protection and care for the natural and built environment is important. • work with other students to identify a local issue and plan possible actions (for) a desired outcome.
	Discipline based learning	Humanities	<p>Students investigate the human and physical characteristics of their local area and other parts of Victoria and consider features of their local community that have changed over time. They learn about settlement patterns, major land uses, communication networks...and make some simple comparisons between local and other Victorian environments: natural features, climate, land use and types of human activities.</p> <p>Students develop awareness and understanding of the effects of people's interactions with their environment and the ways in which these affect their lives...</p> <p>Students learn to distinguish between basic needs and wants (for example, food, clothing, shelter, and affection), saving and spending, buyers (consumers) and sellers (producers), and goods and services. They examine and compare different types of work and specific jobs.</p> <p>At Level 3 Standard, students can:</p> <ul style="list-style-type: none"> • describe the human and physical characteristics of their local area and other parts of Victoria...(and).. how people use and affect different environments in Victoria. • draw simple maps and plans of familiar environments observing basic mapping conventions... (and)... identify the location of places on a simple map

Activities within this resource can be related to the following Essential Learning Standards for:

- Physical, Personal and Social Learning
- Discipline based learning (Humanities)

Level	Strand	Domain	Learning focus and standards	
Level 4	Physical, Personal and Social Learning	Health and Physical Education <i>(Health knowledge and promotion)</i>	<p>Students discuss how their role and responsibilities within the family setting and among friends may change... Students develop an understanding of the right to be safe. They learn to describe and assess the strategies for responding to situations that are potentially unsafe, risky or harmful in a range of settings (at home, at school and in the community)... Students discuss and develop strategies for improving their personal health (and safety).</p> <p>At Level 4 Standard, students can:</p> <ul style="list-style-type: none"> • describe actions they can take if they feel unsafe at home, school and in the community. • plan strategies for improving their personal health (and safety). • describe a range of health services, products and information that can be accessed to help meet health (and safety) needs and concerns. 	
		Civics and citizenship	<p>Students research an issue, or issues using a range of resources including electronic media. These could include current local, national and global issues; for example, natural disasters and human rights issues. They consider actual; and possible actions by citizens and nations in response to the issue/s.</p> <p>At Level 4 Standard, students can:</p> <ul style="list-style-type: none"> • present a point of view on a significant current issue or issues and include recommendations about the actions that individuals and governments can take to resolve issues. • demonstrate understanding that there are different viewpoints on an issue. 	
	Discipline based learning	Humanities	Economics	<p>Students learn about the nature of the economic problem (scarcity): that is, that our needs and wants are unlimited but the resources available to satisfy these wants are limited. They explore how the community defines, classifies and uses resources. They learn about the processes of consumption, production and distribution in meeting needs and wants, and the role of consumers, workers and producers in the economy...</p> <p>Students consider the nature and meaning of work and its relationship to other activities in people's lives, including leisure. They examine various types of work and enterprise in a range of settings, including home, school and the community, and identify the differences between paid and unpaid work.</p> <p>At Level 4 Standard, students can:</p> <ul style="list-style-type: none"> • describe the nature of the economic problem (scarcity) and explain how selected goods and services are produced and distributed. • describe the difference between needs and wants... • compare different types of work and enterprise in the local community.
			Geography	<p>Students investigate some of the significant natural processes that operate across Australia (for example, rainfall, El Nino, drought, flood, earthquake, cyclones and bushfire), and how people react to them, including their preparation for, and management of, natural disasters.</p> <p>Students explore how humans have affected the Australian environment, for example, Indigenous communities' care of the land; clearance by farmers and subsequent problems of land degradation and salinity; and protection of the natural environment.... Using an inquiry-based approach, students explore environmental issues and consider possible solutions to current and future challenges...</p> <p>Students develop more complex mapping skills and use conventional geographic language, including scale, compass points for direction, alphanumeric grid references and legends, to locate places...</p> <p>At Level 4 Standard, students can:</p> <ul style="list-style-type: none"> • describe Australia's significant natural processes ..(and).. the reaction of people to these... • compare the various ways humans have used and affected the Australian environment. • recommend ways of protecting environmentally sensitive areas in a sustainable way. • use geographic language to identify and describe the human and physical characteristics of local ... environments depicted by different kinds of maps, diagrams, photographs.... • drawsketch maps of (local places) using simple mapping conventions.

WESTERN AUSTRALIA

Learning activities within this resource can be related to the following curriculum outcomes for:

- Health and Physical Education - HPE
- Society and environment

Level	Key learning Area	Strand	Learning outcomes and standards	
Foundational	HPE	Knowledge and understandings	KU F	The student demonstrates an awareness of actions to maintain or improve their personal health and safety.
	Society and environment	Place and Space	PSF	The student recognises features, people and places in the environment and cares for those of personal importance.
			PS F.1	Recognises familiar features in the immediate environment.
			PS F.2	Recognises people and places of personal importance.
		Natural and social systems	NSS F	The student responds to elements in the natural and social world to meet immediate needs.
			NSS F.1	Attends and responds to the natural environment.
			NSS F.2	Responds to simple rules which influence them.
			NSS F.3	Indicates immediate needs.
Level 1	HPE	Knowledge and understandings	KU 1	The student recognises what it means to be healthy and the actions that they can take to optimise personal health, safety and physical activity.
	Society and environment	Place and Space	PS 1	The student understands that familiar places have a variety of features and that people care for places that are important to them.
			PS 1.1	Understands that people live in places made up of various features.
			PS 1.2	Understands that there is a relationship between a place and why people use it.
		Natural and Social systems	NSS 1	The student understands that the natural and social world contains elements.
			NSS 1.1	Understands that natural systems consist of elements including people.
			NSS 1.2	Understands that people's daily lives are influenced by rules.
			NSS 1.3	Understands that people endeavour to satisfy their needs and wants from the world around them.
Level 2	HPE	Knowledge and understandings	KU 2	The student recognises that there are different aspects to personal health and how these contribute to their overall health, safety and physical activity.
		Interpersonal skills	IPS 2	The student uses communication and cooperation skills to share feelings and achieve basic needs when interacting with people.
	Society and environment	Place and space	PS 2	The student understands that places in different locations contain specific features.
PS 2.1			Understands that places are characterised by their location and specific natural and built features.	
PS 2.2			Understands that people make choices in their use of places.	
		Natural and social systems	NSS 2	The student understands that in natural and social communities there are connections between parts or elements of the system.
			NSS 2.1	Understands that elements of natural systems form communities in which each element depends on another.
			NSS 2.2	Understands that groups and communities interact according to rules.
			NSS 2.3	Understands that groups and communities obtain goods and services to meet their needs and wants.

Learning activities within this resource can be related to the following curriculum outcomes for:

- Health and Physical Education - HPE
- Society and Environment

Level	Key learning Area	Strand	Learning outcomes and standards
Level 3	HPE	Knowledge and understandings	KU 3 The student understands that personal health, safety and physical activity practices enhance the physical, mental, emotional and social aspects of their own and others' health.
		Interpersonal skills	IPS 3 The student uses communication and cooperation skills that contribute to interpersonal and group interactions.
	Society and environment	Place and Space	PS 3 The student understands that processes affect the natural and built features of places and these features have an influence on human activity and on people's views about which places need to be cared for.
			PS 3.1 Understands that the features of places are influenced by various natural processes and by human activity.
		PS 3.2 Understands that the use people make of different places is affected by natural and built features.	
	Natural and Social systems	NSS 3 The student understands that, in natural and social systems, relationships occur to provide order to the interactions found within them.	
NSS 3.1 Understands that elements of natural systems link to form cycles of which people are a part.			
NSS 3.3 Understands that flows exist in the production, distribution and exchange of goods or services.			
Level 4	HPE	Knowledge and understandings	KU 4 The student understands how factors influence personal health behaviours and how to appraise their own and others' health, safety and physical activity practices.
		Interpersonal skills	IPS 4 The student selects and plans to use interpersonal processes and the related communication and cooperation skills, to enhance interpersonal and group relationships.
	Society and environment	Place and space	PS 4 The student understands that people and places are interdependent, resulting in patterns of features and activities across different places, and that people act to sustain the environment according to their values.
			PS 4.1 Understands that similarities in the natural and built features in different places give rise to patterns.
		PS 4.2 Understands that people and places are interdependent.	
	Natural and social systems	NSS 4 The student understands that modifications to natural and social systems occur as they respond to changes.	
NSS 4.1 Understands that different elements respond and attempt to adapt to changes in natural systems.			
NSS 4.3 Understands that people respond to change by making decisions about the production, distribution and exchange of goods and services.			



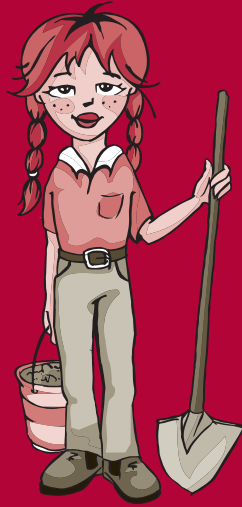

4. UNITS OF WORK AND ACTIVITY SHEETS



UNITS OF WORK AND ACTIVITY SHEETS

The following integrated units aim to address key injury prevention issues for children at different levels of cognitive development, within the general context of learning about farms as places and production systems. These streams primarily relate to learning outcomes within the Studies of Society and Environment and Health / Physical Education key learning areas for Levels 1 to 4, as variously named within state-based curricula.

SCHOOL ENTRY AND EARLY PRIMARY: INJURY PREVENTION ISSUES

- Many key safety interventions for young children on farms, (such as securely fenced safe play areas and active supervision) need to be put in place by adults. These provide a framework for young children to act safely in accordance with their stage of development. Involving the parent body to support/reinforce classroom learning in this area is a highly recommended strategy.
- A safe play area (such as a securely fenced house yard) is a place which clearly separates children from farm hazards such as dams, farm vehicles, machinery and animals. It enables children to better differentiate safe/ unsafe areas. It also provides a physical barrier to prevent younger children gaining unsupervised access to water bodies and the farm workplace.
- Safe play areas need to be supported by family rules about out-of-bounds areas and active supervision. Based on the injury research, key safety rules on farms should include:
 - *Children stay in designated "safe play areas" unless taken out and looked after by an adult*
 - *Children wear seatbelts and restraints in farm vehicles*
 - *Children do not ride on tractors, ATV's or on the back of utes*
 - *Children always wear helmets when riding bikes, motorbikes and horses*

MIDDLE AND UPPER PRIMARY: INJURY PREVENTION ISSUES

- Key safety interventions remain the responsibility of adults, but children are better able to participate in and be responsible for the safety of themselves and others.
 - A safe play area (such as a fenced house yard) remains an important safety measure and delineates work and play areas. Whilst older children may not be confined by fences, out-of-bounds areas on the farm need to be clear and consistently reinforced by adults. Older children not being directly supervised, need to tell an adult where they are going and how long they will be.
 - Older children engage in more recreational and work activities on farms. Injury profiles most often reflect changing recreational activities and roles, especially in relation to riding motorbikes (two and four wheel) and horses. Farm vehicles and machinery remain prominent causes of death and serious injury, whilst drowning is less prominent than it is for toddlers. Peer pressure and increasing independence can have a role to play on compliance to safety rules. Reducing hazards and designing for safety are preferred interventions.
- As for younger age groups, older children should continue to follow key safety rules such as:
- *Children stay in designated safe play areas, unless supervised by an adult*
 - *Children always wear seatbelts and restraints in farm vehicles*
 - *Children do not ride on tractors, ATV's or on the back of utes*
 - *Children always wear helmets when riding bikes, motorbikes and horses*

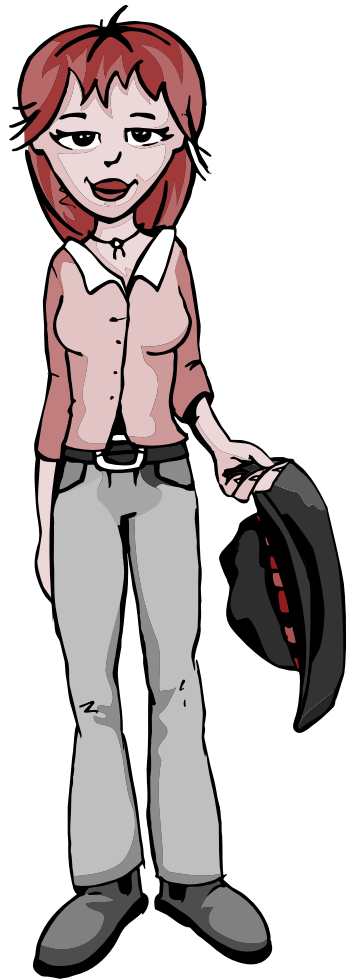

SCHOOL ENTRY FOCUS

School entry focus

SCHOOL ENTRY FOCUS

Young children are often unaware of the risks to their safety in farm environments. Children identify and explore some of the natural and built features of farms and the features of a safe place on a farm. Basic safety behaviours are introduced such as staying with an adult when out and about on the farm and calling for help when unsure / feeling unsafe. In particular, children at school entry working towards Level 1 / at Level 1 aim to:

- Recognise basic features of farm environments and activities of people on farms
- Recognise a safe place to play on the farm (eg. house yard)
- Recognise feelings when unsure / feel unsafe on the farm
- Gain knowledge and understanding of essential safety behaviours such as:
 - *The need to stay in the safe play area unless an adult takes them out and about on the farm looks after them.*
 - *When out and about on the farm, children need to stay within sight | sound | contact of a supervising adult.*
 - *Children tell their carer immediately if they are feeling unsafe | unsure of a situation on the farm.*

TOPICS

TOPIC 1: **KIDS ON THE FARM**

TOPIC 2: **FEELING GOOD FEELING SAFE**

TOPIC 3: **FARM VEHICLES AND MACHINES**

TOPIC 4: **ANIMALS ON THE FARM**

TOPIC 5: **KIDS AND WATER ON FARMS**

TOPIC 6: **OTHER HAZARDS AND SUMMARY**

TOPIC 1: KIDS ON THE FARM

Overview: Children identify common features and activities that are unique to rural properties. Many of these are needed for farming activities, but some can be hazardous to the safety of children (and adults). Children recognise safe areas and unsafe features areas and the need to have a carer in close proximity. Consequences of playing in unsafe places are explored.

Teaching strategies

ACTIVITIES

Resources

Teaching strategies	ACTIVITIES	Resources
	<p>Activity 1: FARM STORIES</p> <p><i>Keypoint: Children recognise and describe common features of farms and identify safe / unsafe areas to play. Children recognise the need to be supervised by an adult carer on the farm.</i></p>	
Story – reading	<p>Read the storybook “Geena and Harry’s farm” about a sister and brother who live on a rural property. Children can:</p>	*Storybook “Geena and Harry’s farm”
Knowledge and understanding	<ul style="list-style-type: none"> • Share what they liked about the story • Name features in the story that are typical of farms • Describe features on their own rural properties or on farms they have visited. • Identify and describe some of the activities carried out by children in the story • Compare the areas where the children were allowed to play and were not allowed to play. 	
Application	<p>Discuss and compare features of children’s play areas at their own homes. Children can:</p>	
Activity sheet	<ul style="list-style-type: none"> • Complete the “Safe play area” activity sheet 1.1* 	Activity sheet 1.1.1
Synthesis	<p>(Optional) If available, provide a selection of readers for children for in class / at home that focus on features of farms/ safe places/proximity of a carer. Children can:</p>	Selection of readers
Selection of readers	<ul style="list-style-type: none"> • Explain to parents/teacher/classmates what they thought the story was about; special features of each farm and where the safe vs. unsafe areas were. 	
	<p>Activity 2: FARM HAZARDS</p> <p><i>Keypoint: There are particular features and activities that are unsafe for children on farms and rural properties. Children need to stay in safe play areas or else watched closely by a carer / parent when out and about on the farm.</i></p>	
Knowledge and understanding	<p>Explain the terms “hazard” and “unsafe”. Present the series of pictures or slides showing features of farms, safe and unsafe scenes. Children can:</p>	Folder pictures CD Slideshow
Flashcards discussion	<ul style="list-style-type: none"> • Identify and list each feature / activity in a table • Share stories of the use of each item / activity in the course of farm work and others on local farms 	
Knowledge and understanding	<ul style="list-style-type: none"> • Count / tally by show of hands the most common features seen by the class • Complete the “farm features” activity sheet 	
Application	<p>Discuss what might happen to children around farm hazards / without an adult. Children can:</p>	Activity sheet 1.1.2
	<ul style="list-style-type: none"> • Describe situations that might cause serious injury, ie. fatal or require treatment by a doctor or at hospital (eg. drowning, fractures, amputations, crush). • Role play “what if” scenarios if children play in ear hazards / without an adult supervising 	
Analysis		

TOPIC 2: FEELING GOOD ABOUT SAFETY

Overview: Children identify and describe feelings when unsure / unsafe and situations when they should go to a carer for help. Different types of helpers are identified. Children describe examples of safety rules for different situations on rural properties. "Golden rules" for safety are reinforced ie: children play in safe areas; children stay with an adult if out and about on the farm; children call for help if feeling unsafe / unsure.

Teaching strategies	ACTIVITIES	Resources
<p>Class discussion</p> <p><i>Knowledge and understanding</i></p> <p><i>Analysis</i></p> <p><i>Application</i></p>	<p>Activity 1: FEELING SAFE</p> <p><i>Keypoint: Children can identify feelings they have when feeling unsafe or unsure. Children need to go to someone who cares for them to help them to feel safe.</i></p> <p>Discuss the meaning of the terms safe and unsafe. Discuss feelings children can have when feeling unsure or unsafe. Children can:</p> <ul style="list-style-type: none"> • Discuss feelings they have had before or might have if: <ul style="list-style-type: none"> • They are being cuddled by a parent / important person in their life. • A dragon was chasing them • They were lost and didn't know where to go • They felt unsafe at home • Describe how their bodies let them know (eg. 'butterflies', 'want to cry', 'frozen'). • Discuss any situations on a farm when they have felt unsafe / unsure. (eg. behind a reversing ute, approaching a parent operating a tractor, being told to do something by a brother). • Share what they did / should do when feeling unsafe / unsure. Who can they go to for help? • Suggest other people apart from parents who can help when feeling unsafe, hurt or in trouble and describe how they can help. 	
<p>Activity sheet</p> <p><i>Synthesis</i></p> <p>Art figures</p>	<ul style="list-style-type: none"> • Complete the activity sheet* • Make life size "helpers" by tracing around a child on butchers paper. Paint and label different helpers (eg. parent, neighbour, fireman, ses, police, doctor, nurse). 	<p><i>Activity sheet 1.2.1</i></p> <p><i>Paint, butchers paper, art & craft supplies</i></p>
<p>Class discussion</p> <p><i>Knowledge and understanding</i></p> <p>'Golden rules' game</p> <p><i>Analysis</i></p> <p>Make a banner</p> <p><i>Synthesis</i></p>	<p>Activity 2: GOLDEN RULES</p> <p><i>Keypoint: There are many particular rules for different situations, but some safety rules apply across situations. For young children, these relate to safe play areas; close adult supervision; and knowing when to get help.</i></p> <p>Discuss some of the things parents say children are not allowed to go/do at home (eg. swim alone, play on machinery, ride ATV's, ride on back of utes, ride without helmets, play in work areas). Children can:</p> <ul style="list-style-type: none"> • Suggest reasons why parents may have these rules. • Write a sentence to explain why families have rules (eg. My family has rules to keep me safe) <p>Display a "box" and put in slips of paper with three "golden rules" for young children on farms:</p> <ul style="list-style-type: none"> • "Children play in safe play areas" • "Children stay with an adult if out on the farm" • "Children call for help if feeling unsafe" <p>Place some pretend rules in the box and/or allow children to put in 'other'rules also. Children can:</p> <ul style="list-style-type: none"> • Take turns in pulling out clues and mime, charade or play 'yes/no only' to work out what the clue is • Discuss if each rule would protect children in most farm situations • At the end of the game, make banners for the 'golden rules' for display in class 	<p><i>Cardboard box with colourful wrap</i></p> <p><i>Paper, colours, art and craft supplies</i></p>

TOPIC 3: FARM VEHICLES AND MACHINES

Overview: Children examine vehicles and machines as common features of farms. The purpose of these and characteristics which can be hazardous to young children are explored. Children identify safety measures around vehicles and machines on the farm and reinforce key safety messages regarding safe play areas, close adult supervision and getting help when feeling unsafe.

Teaching strategies

ACTIVITIES

Resources

Picture based discussion

Knowledge and understanding

Activity sheet

Synthesis

Activity 1: FARM WORK

Keypoint: Vehicles and machines are needed on farms to transport people and help farmers to do their work. Some characteristics of these can be hazardous to children.

Display some pictures of farm vehicles and machines from magazines or the CD. Encourage children to bring in photos of farm vehicles and machines on their own properties. Children can:

- Identify the different vehicles and machines in the pictures.
- Discuss how each of these is used for transport or helps with farm work
- In particular, describe the different activities motorcycles are used for on rural properties (eg. recreation, mustering, spraying, transport) and safe ways to use motorbikes
- Complete activity sheet 3.1
- Using odds and ends and construction toys, make models of farm machines and vehicles.

Activity 2: IN THE SHED

Keypoint: Places where machines and vehicles are kept are not safe play areas. Children can be injured from machines even when they are not operating. If feeling unsure about being in an area, don't go there and get help instead.

Discuss the following scenario with children:

Mum has told you that kids aren't allowed to play in the machinery shed where the tractors, trucks and workshop tools are kept. You can only go in the shed with Mum or Dad to look after you and watch you.

Children can:

- Suggest reasons why Mum and Dad might not want them playing in the machinery shed
- Describe what they would do if they suspect little sister hid in the shed when playing hide and seek. Who would they go to?
- Write a sentence to explain why / why not it is a good idea to play around machines and vehicles.

Application

Evaluation

Farm magazines,
rural newspaper
advertisements
CD Slideshow

Activity sheet 1.3.1

TOPIC 4: ANIMALS ON THE FARM

Overview: Children examine the variety of animals found on farms and how they are used for recreation and production purposes. Characteristics of animals and safe ways of behaving around pets and larger animals are explored. Children identify ways of caring for animals and describe safety measures when handling and riding horses.

Teaching strategies	ACTIVITIES	Resources
	<p>Activity 1: CHARACTERISTICS OF FARM ANIMALS</p> <p><i>Keypoint: There are different kinds of animals found on farms, which produce food, clothing or are used for riding transport. Children can have fun with pets, but most farm animals are not pets and care needs to be taken with them.</i></p>	
Photo based discussion	<p>Display pictures of different kinds of farm animals from the CD or magazines. Encourage children to bring in their own photos of farm animals. Discuss the types of animals found on farms. Children can:</p> <ul style="list-style-type: none"> Identify the different kinds of animals found on farms and rural properties. 	Photos pictures of farm animals *CD
Knowledge and understanding	<ul style="list-style-type: none"> Draw/paint a picture of an animal they like that is found on a farm /rural property. 	Art and craft supplies
Word list	<ul style="list-style-type: none"> Attach each picture to a pinboard / layout on a table with pictures by other class members and in turn share with the class what they like about this animal. Next to each picture, decide on a word to describe what the animal does or is used for (eg. wool, ride). Make a word list of these for spelling 	
Knowledge and understanding	<p>Some animals on rural properties are quiet pets, but most farm animals are not pets and can behave in unpredictable ways. Children can:</p> <ul style="list-style-type: none"> List some of the fun things children can do with pets and quiet animals on farms. (eg. cuddle, ride, play ball, brush and feed) 	
Activity sheet	<ul style="list-style-type: none"> Complete the "Safety around pets" charter on Activity sheet 4.1* 	Activity sheet 1.4.1
Analysis	<ul style="list-style-type: none"> Discuss the characteristics of animals that can sometimes make them a bit scary or unsafe. (eg. large, heavy, wild, may not see / notice children) 	
Application	<ul style="list-style-type: none"> Share about situations on their own properties when an animal may charge, kick, bite or runover people (eg. may be distracted, get confused or threatened when being handled or when they have young). Complete the activity sheet* about important ways to be safe around other farm animals. 	
	<p>Activity 2: HORSES ON RURAL PROPERTIES</p> <p><i>Keypoint: Horses can be great fun, but people need to take care when riding or when around horses. Children should always wear a riding helmet and boots when on near horses.</i></p>	
Story-based discussion	<p>Read a story-book reader about children and ponies. Children can:</p> <ul style="list-style-type: none"> Discuss how the characters cared for their ponies 	Reader
Knowledge and understanding	<ul style="list-style-type: none"> Write a sentence or two to describe how they would care for a pony 	
Application	<ul style="list-style-type: none"> Complete the horse activity sheet* 	Activity sheet 1.4.2
Activity sheet	<p>(If available) Screen the video or display the poster on horse safety "No helmet, no boots, no way". Children can:</p> <ul style="list-style-type: none"> Discuss how adults and children should behave safely around horses 	Horseplay video or CD Poster design
Make a poster	<ul style="list-style-type: none"> Make their own safety poster about horses 	
Synthesis	<ul style="list-style-type: none"> Using construction toys, odds and ends or modeling clay, make models of a horse and rider. With the models, demonstrate how to be safe around horses. 	Modelling clay, craft odds and ends.
Clay modelling		

TOPIC 5: WATER ON FARMS

Overview: Children create a water chart to describe the different types of water on farms, what it is used for and important water safety measures. Children can have fun with water, but need to be closely supervised by an adult. Other water safety hints relevant to rural properties are explored and steps to take when in trouble in the water.

Teaching strategies

ACTIVITIES

Resources

Create a water safety chart

Knowledge and understanding

Analysis

Activity sheet

Knowledge and understanding

Application

Draw a picture

Synthesis

Activity 1: WATER CHART

Keypoint: *Water comes in a variety of forms on farms. Children need to be closely supervised by an adult when around farm water hazards. Children examine other safety hints and what to do when in trouble in the water.*

Children can make a chart about water on farms. Show children how to fold a large A3 paper into four quarters. Children can:

- Display the farm water scenes from the CD slideshow
- Make a heading with the words "Water on farms". Draw a circle in the middle of the paper big enough for a drawing. In each corner, write the following headings:
 - a. *Types of water*
 - b. *Fun with water*
 - c. *Water safety hints*
 - d. *When I need help*

- Discuss all the ways water is used on your farm or properties in the local area.

- Find pictures in magazines etc. / photos of different "types of water" on farms and label each. Cut out and paste the pictures onto one of the sections with a heading "Types of water". Write a sentence to describe what water is used for on your chart.

Drowning is the most common cause of death to children on farms. Discuss what drowning means and other ways children can be injured by water (eg. burn, electrocution). Children can:

- Complete the water safety activity sheet

Discuss what children need to do when feeling unsafe or needing help in / near the water. Children can:

- Make a list of possible actions you could take. Write these on the chart under the last heading (eg. tell an adult, hold hands with an adult, don't go in above your knees, use a floaty, call out loud for help, reach for the bank).
- Make up a water safety slogan. Write this on the chart or have a class competition to vote for the best slogan for your chart.
- Draw and label a picture of themselves playing safely in the water with a supervising adult.

*CD slides of farm water**

Rural magazines, photos – cut & paste materials

Activity sheet 1.5.1

TOPIC 6: OTHER HAZARDS AND SUMMARY POINTS

Overview: Children look at other features and activities on farms that can be hazardous to young children. Children consolidate learning by identifying the most important safety measures for young children living on or visiting a farm / rural property.

Teaching strategies	ACTIVITIES	Resources
<p>Picture-based discussion</p> <p><i>Knowledge and understanding</i></p> <p><i>Application</i></p> <p>Collage</p> <p><i>Synthesis</i></p> <p>Activity sheet</p>	<p>Activity 1: CHEMICALS AND OTHER FARM HAZARDS</p> <p><i>Keypoint: There are a variety of other features on farms that are used for farm work. Some of these can also be hazardous. Safety aspects of chemicals and some locally relevant farm hazards are explored.</i></p> <p>Obtain and display a collection of chemical company catalogues and pamphlets from a rural supplier, or rural newspapers with a range of pictures showing chemical containers and scenes of farmers using chemicals. Children can:</p> <ul style="list-style-type: none"> • Discuss and define what a chemical is and how they are used on farms (eg. help plants and animals to grow, kill weeds, put in machines) • Describe how they would recognise a chemical (eg. symbols, smell) • Share stories of how members of their own families use chemicals are where they are kept on their own farms (ie. Should be locked away out of reach, but sometimes aren't) . • Make a "chemical collage" of pictures from the pamphlets and catalogues. Make a heading for the collage "Children stay away from farm chemicals" <p>Discuss other hazards appropriate to your area – such as silos, windmills, irrigation channels. Reinforce safety precautions such as the need to stay in safe play areas, close adult supervision when out on the farm and calling for help if feeling unsafe or unsure. Children can:</p> <ul style="list-style-type: none"> • Complete the "Other hazards" activity sheet* 	<p><i>Chemical company catalogues</i></p> <p><i>Activity sheet 1.6.1</i></p>
<p>Workbook summary</p> <p><i>Synthesis</i></p> <p>Make a poster</p> <p>Make a model</p> <p><i>Evaluation</i></p>	<p>Activity 2: SUMMARY EXERCISES</p> <p><i>Keypoint: People live on farms but also work on farms. Some features of farms are hazardous. Children can have fun on farms with certain safety precautions. The most important are to identify and play in safe play areas; have an adult with you to watch you when out and about on the farm; and know when and how to get help if feeling unsafe.</i></p> <p>Children can:</p> <ul style="list-style-type: none"> • Write a series of headings in their workbooks and complete the sentences. <ul style="list-style-type: none"> • "Farms in our area have....". (add features of farms) • "People on farms....." (add some farm activities carried out) • "Safe places on farms"(add characteristics of safe areas) • "Kids on farms stay safe by ..." (add three key safety rules) • Design a safety poster based around one of the three main safety messages for young children on farms. Display these around the classroom. AND / OR • Make a model of a safe play area on a farm. Make a fence and some children playing inside it. Place any vehicles, machinery or large animals outside the area. • Write a sentence to describe: <ul style="list-style-type: none"> • what they like and dislike about farms rural properties • the best ways they think children can stay safe on farms 	<p><i>Craft supplies, toy farm sets people</i></p>

TOPIC 1: KIDS ON THE FARM (L1.AS1.1)

Name:

Class:

Learning Outcomes: ACT NSW NT QLD SA TAS VIC WA

Tasks and Indicators

Achieved

Identifies safe places to play on the farm

Identifies an adult who cares for them and keeps them safe

ACTIVITIES

1. COLOUR IN THE FARM PICTURE.

2. CIRCLE THE SAFE PLACE FOR CHILDREN TO PLAY.

3. DRAW YOURSELF IN THE PICTURE.

4. LABEL THE ADULT IN THE PICTURE. CAN THE ADULT SEE THAT THE CHILDREN ARE SAFE?

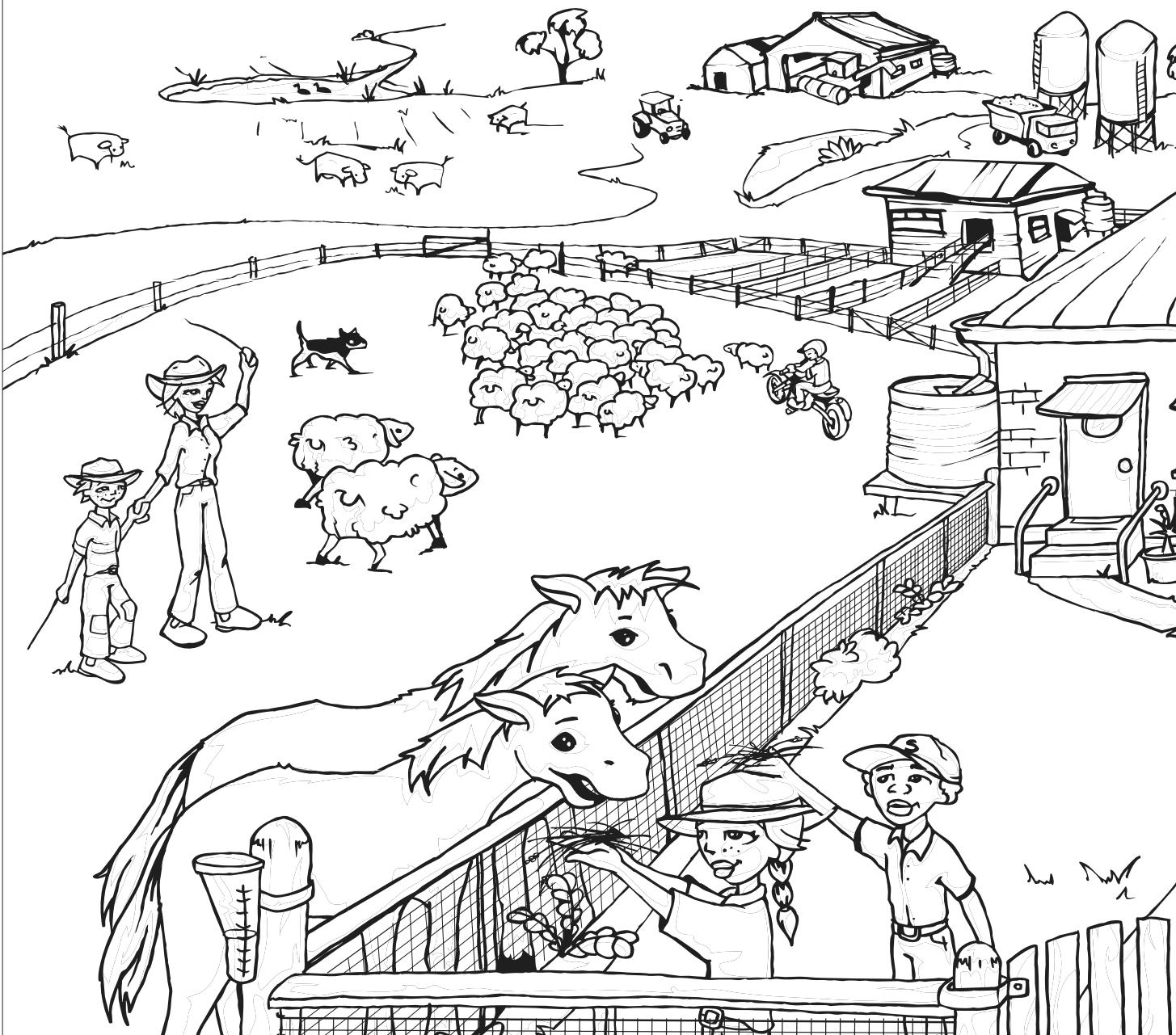

TOPIC 1: KIDS ON THE FARM (L1.AS1.2)

Name:

Class:

Learning Outcomes: ACT NSW NT QLD SA TAS VIC WA

Tasks and indicators

Achieved

Identifies features that can be unsafe for children on farms

Indicates safe and unsafe actions for children on a farm

ACTIVITIES:

Water, animals and big machines are common on farms. They can be unsafe to play near.

Ask an adult where it is safe to play. A house yard is a good place to play safely.

1. COLOUR IN THE FARM FEATURES. WRITE THE CORRECT NAME FROM THE LIST UNDER EACH FEATURE

Tractor

Motorbike

Ute

Horse

Bull

Dam

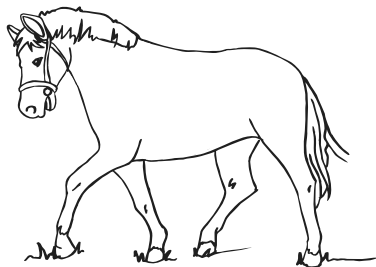
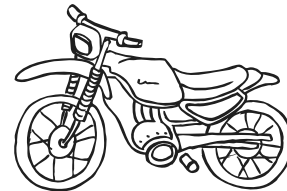
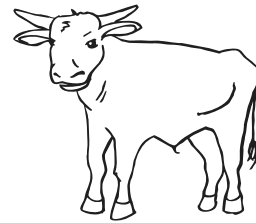
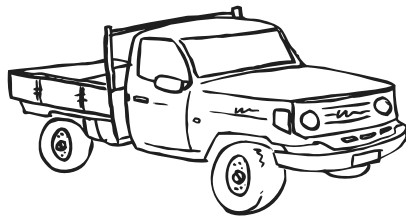

2. TICK THE SAFE AND UNSAFE ACTIONS FOR CHILDREN ON FARMS

Safe Not safe

Safe Not safe

Playing on the tractor

Swim in the dam on my own

Call for help if feeling afraid

Play in the house yard with Mum nearby

Ask an adult to watch and care for me

Play where the cars are parked

TOPIC 2: FEELING GOOD FEELING SAFE (L1.AS2.1)

Name:

Class:

Learning Outcomes: ACT NSW NT QLD SA TAS VIC WA

Tasks and indicators

Achieved

Identifies feelings when afraid or unsafe

Describes what to do when feeling unsafe/unsure

Identifies one or more adults to go to when needing help

ACTIVITIES:

1. COPY THE FACE THAT MATCHES EACH FEELING

Geena is happy



Harry is sad



Ryan is afraid



Geena is sad



Harry is afraid



Ryan is happy



TOPIC 2: FEELING GOOD FEELING SAFE (L1.AS2.1)

2. COMPLETE EACH SENTENCE

When I feel afraid I call for help

When I feel funny inside I call _ _ _ _ _

When I don't know what to do I _ _ _ _ _

When I feel unsafe _ _ _ _ _

3. DRAW A PICTURE OF AN ADULT WHO KEEPS YOU SAFE. LABEL THE PICTURE

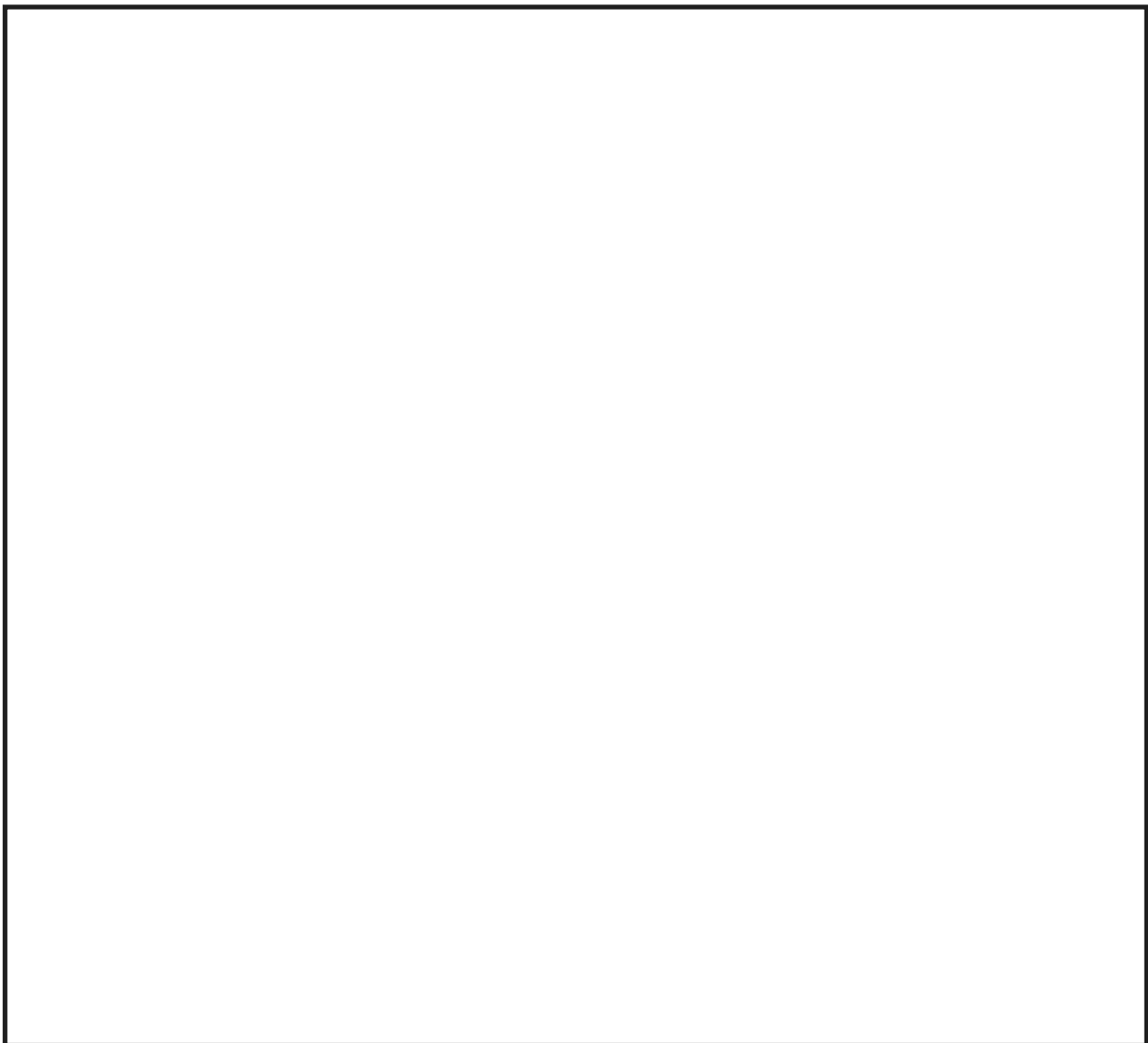

4. NAME ONE OTHER ADULT YOU CAN GO TO FOR HELP

TOPIC 3: FARM VEHICLES AND MACHINES (L1.AS3.1)

Name:

Class:

Learning Outcomes: ACT NSW NT QLD SA TAS VIC WA

Tasks and indicators

Achieved

Identifies features of machines common on farms

Describes how farm machines can be unsafe

Identifies safe and unsafe ways to use bikes and motorbikes

Remember: Tractors help farmers do farm work. Tractors are big and noisy. They have parts that can move fast. It is unsafe to play near tractors.

ACTIVITIES:

1. COLOUR IN THE TRACTOR AND LABEL ITS PARTS.

Wheel Engine Roof Door Steps



TOPIC 3: FARM VEHICLES AND MACHINES (L1.AS3.1)

2. COMPLETE THE SENTENCES.

Tractors are used to help farmers...

I don't play near tractors because...

3. COLOUR IN THE PICTURES. PUT A CROSS THROUGH THE UNSAFE WAYS TO USE BIKES

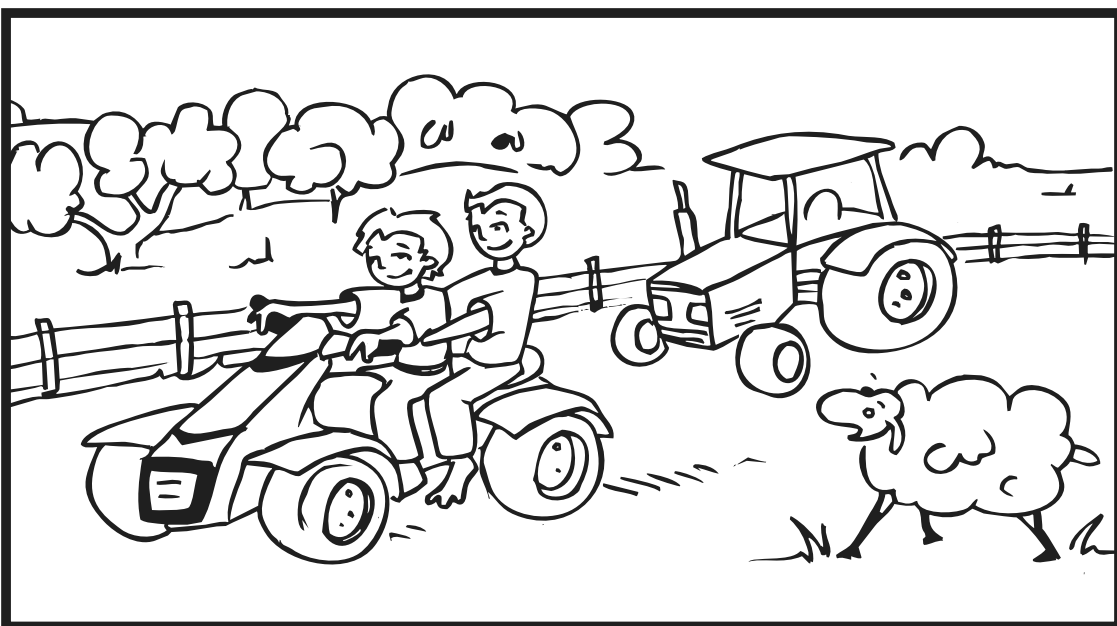
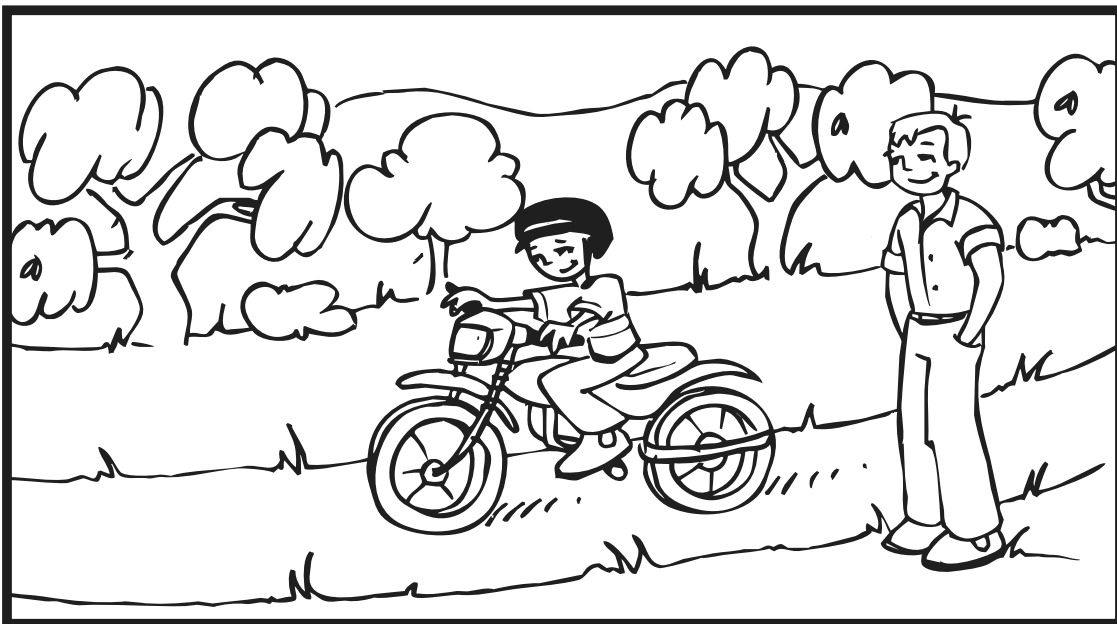

TOPIC 4: ANIMALS ON THE FARM (L1.AS4.1)

Name:

Class:

Learning Outcomes: ACT NSW NT QLD SA TAS VIC WA

Indicators

Achieved

Identifies safe and unsafe places on a farm

Identifies animals found on farms

Identifies safety rules when playing with animals

ACTIVITIES:

1. LOOK AT THE PICTURES BELOW

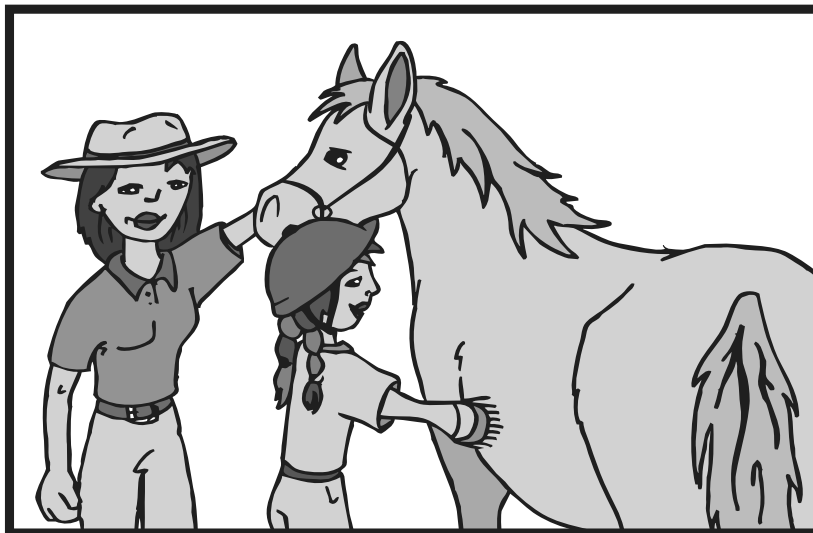

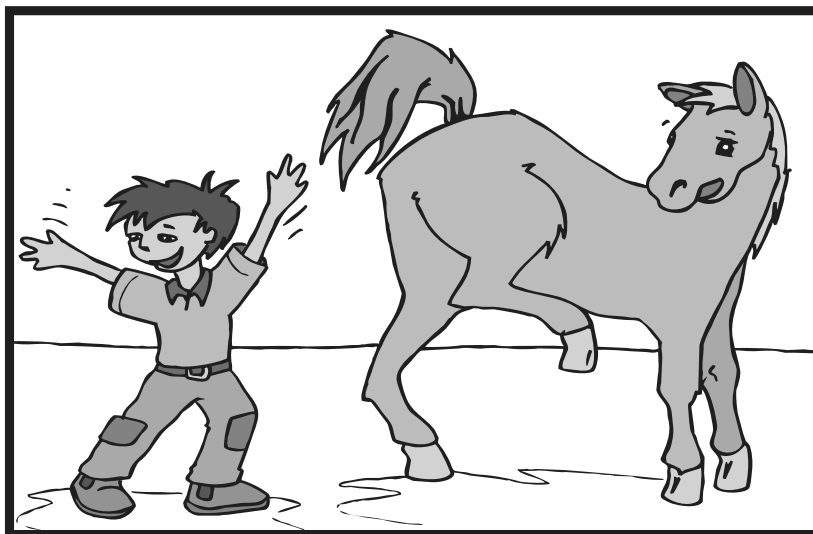

Tick the safe picture. **Write a sentence to describe why this picture is safe.**
Put a cross through the unsafe picture. **What features make it an unsafe scene?**

TOPIC 4: ANIMALS ON THE FARM (L1.AS4.1) CONT...

2. FARM ANIMAL MOBILE

Cut and paste each animal onto cardboard and tie them to a coathanger with string.

Find other pictures to go with the mobile.

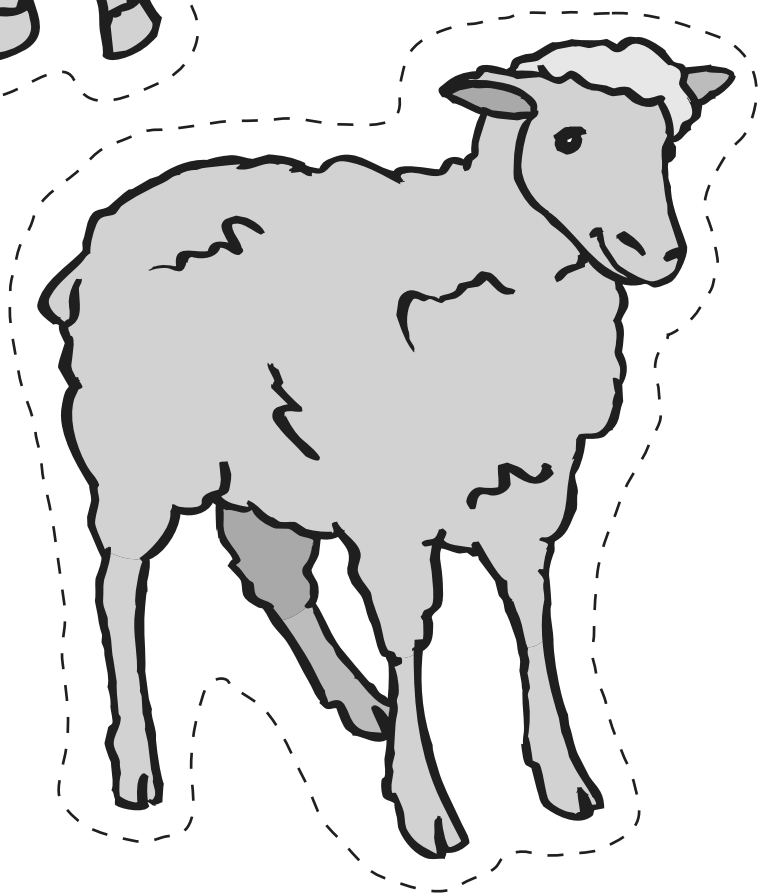
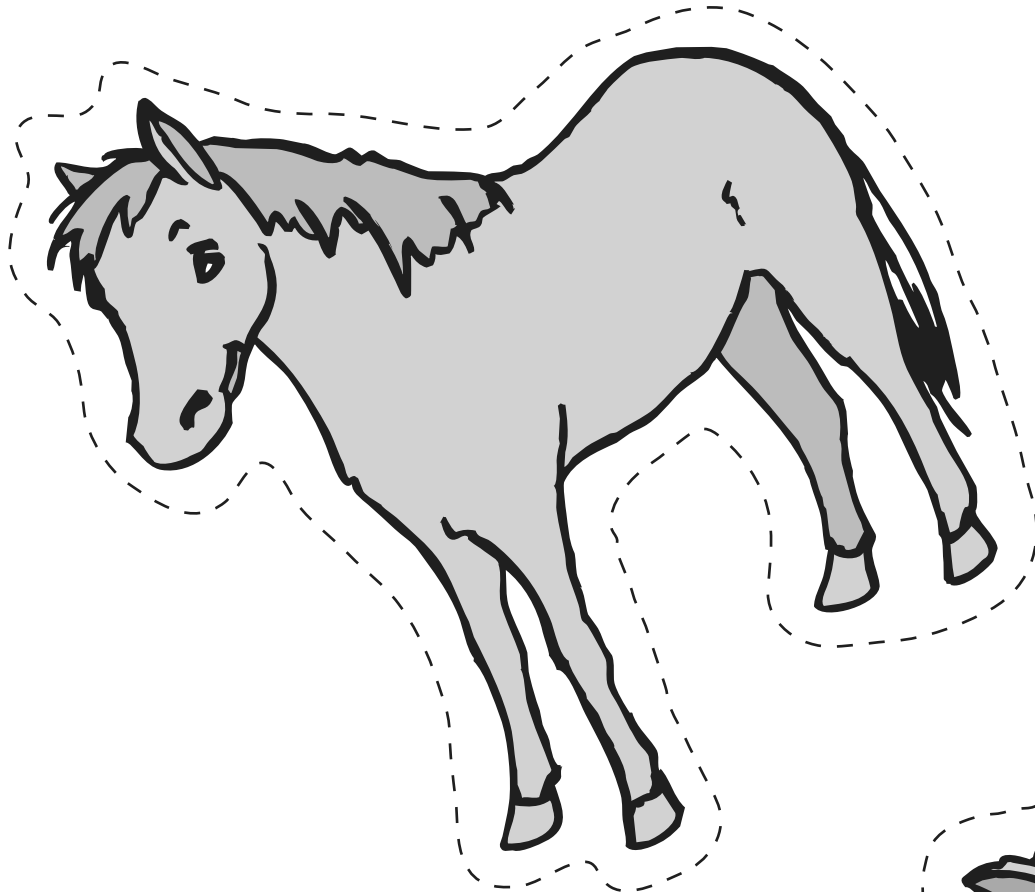

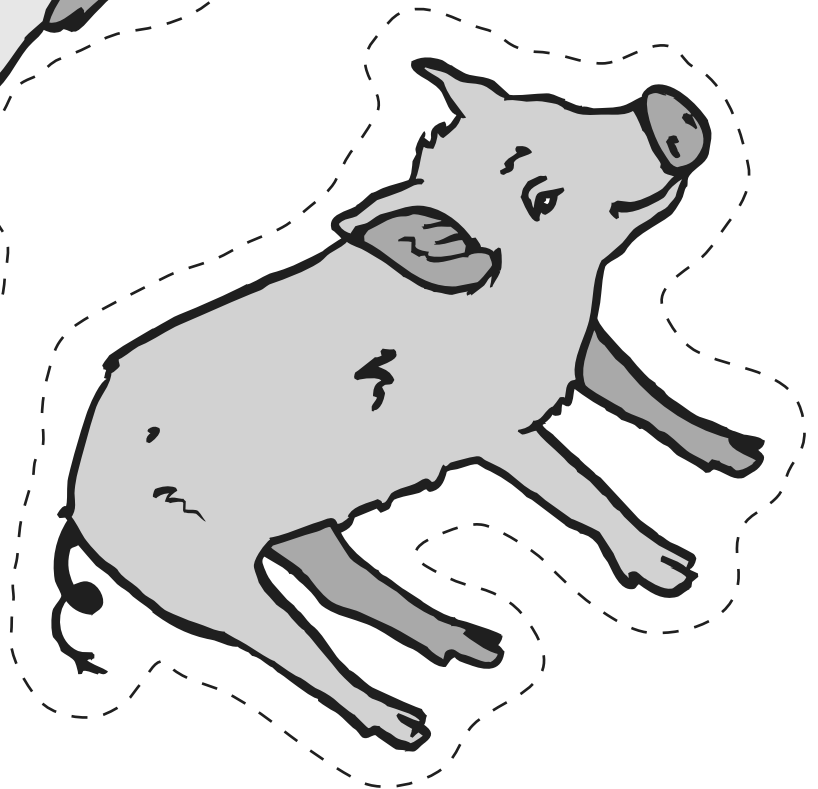
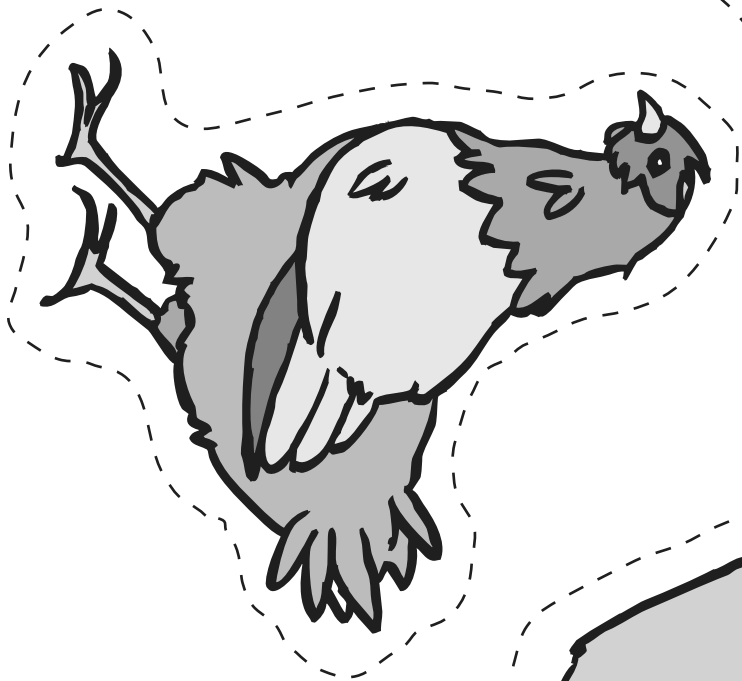
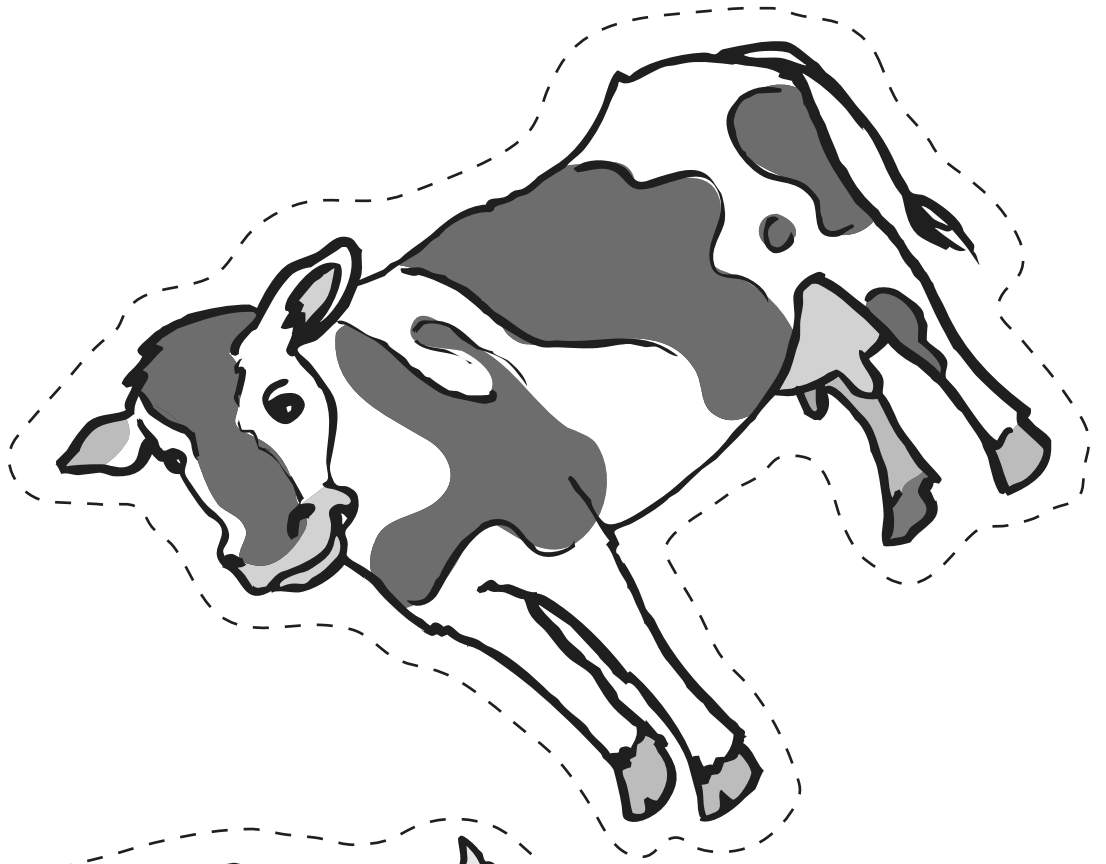

3. CUT OUT THE "RULES" AND STICK THEM ON THE CHARTER.



1. Ask Mum or Dad if it is OK

3. Wash my hands when I am finished

2. Call for help if I am afraid



Add this picture to your mobile

TOPIC 4: ANIMALS ON THE FARM (L1.AS4.2)

Name:

Class:

Learning Outcomes: ACT NSW NT QLD SA TAS VIC WA

Tasks and indicators

Achieved

Identifies safe and unsafe places on a farm

Identifies animals found on farms

Identifies safety rules when playing with animals

ACTIVITIES:

1. COLOUR IN THE PICTURE OF LORI AND THE PONY. LABEL THE FOLLOWING FEATURES:

Helmet Boots Saddle Bridle



Complete the following sentence with the correct words:

When I ride a horse, an adult is always with me. I always wear a and boots.

TOPIC 5: WATER ON FARMS (L1.AS5.1)

Name:

Class:

Learning Outcomes:

ACT NSW NT QLD SA TAS VIC WA

Tasks and indicators

Achieved

Identifies unsafe features of water on farms

Describes safe ways of behaving near water on farms

Remember: Water can be fun, but playing near water can be unsafe. Adults stay with me near water on farms.

ACTIVITIES:

1. COLOUR IN THE PICTURE OF THE FARM DAM BELOW. LABEL THE UNSAFE FEATURES.

Deep Rocks Reeds Steep sides

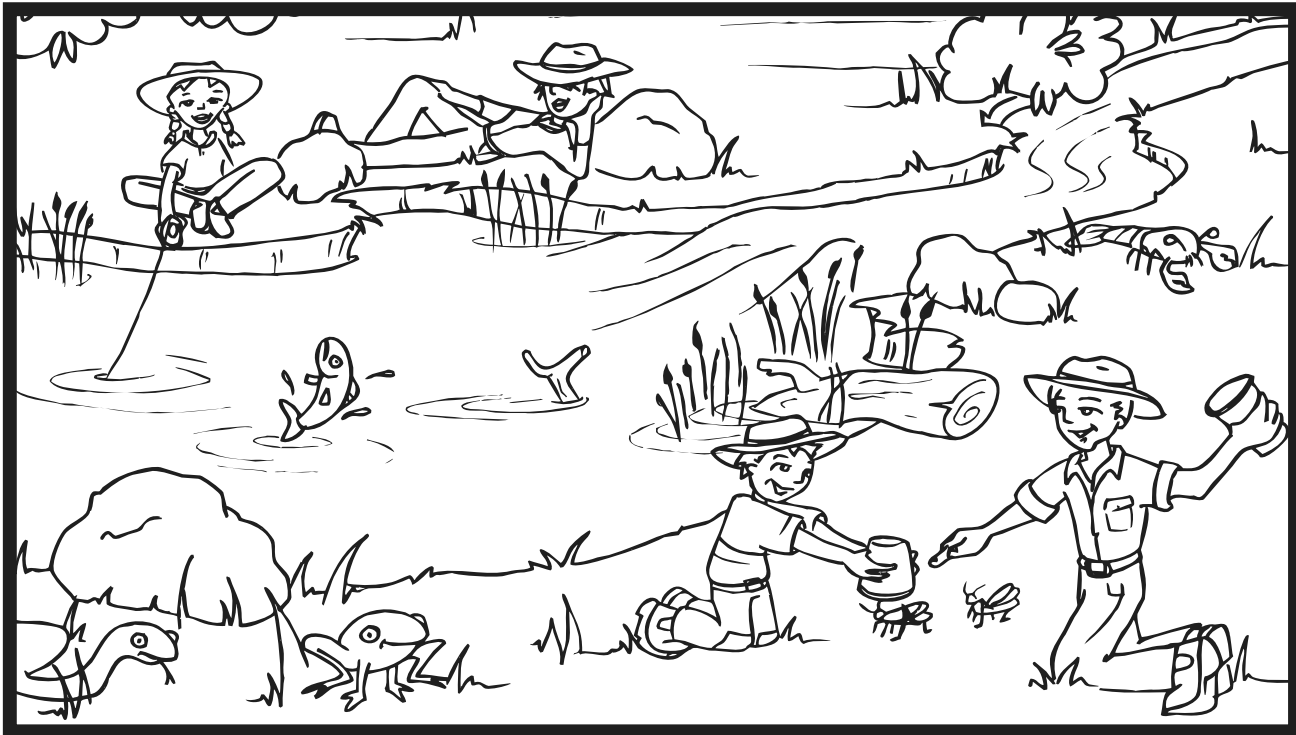

CALL FOR H__P IF AFRAID.
AD__LTS TEACH K__DS TO SW___.
NEVER SW__ ALONE.
WEAR S__NSCREEN AND A H___.
ADULTS K__P WATCH.

Explain what the last sentence means:

TOPIC 6: A LAST WORD ON FARMS (L1.AS6.1)

Name:

Class:

Learning Outcomes: ACT NSW NT QLD SA TAS VIC WA

Tasks and indicators

Achieved

Recognises the purpose of chemical warning labels

Identifies some features of farm work areas

Describes the use of safety gear for farm work

Remember: Farm chemicals have warnings. Children stay away from chemicals.

ACTIVITIES:

1. CUT AND PASTE A CHEMICAL SIGN ON THE DRUM.

What does it mean?

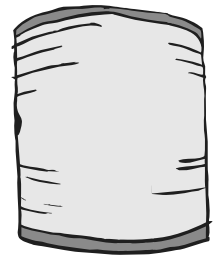

2. WRITE THE CORRECT NAME UNDER EACH FARM WORK AREA:

Silo

Shed

Windmill

Cattleyard

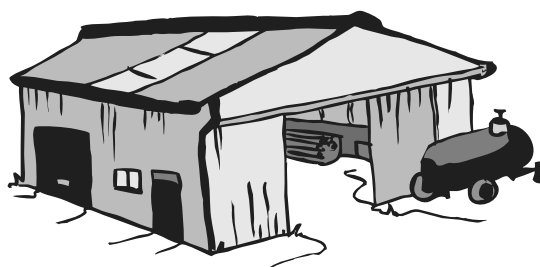
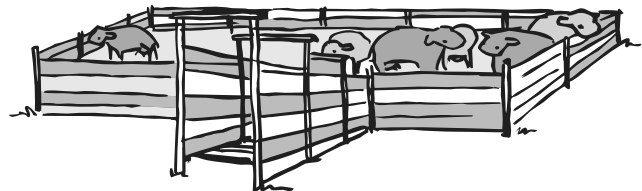
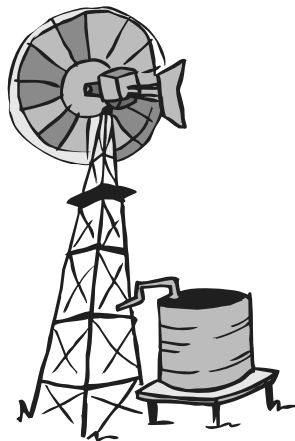

Tick the features you have seen on the farm. **Is it safe to play in any of these areas? Yes / No**

TOPIC 6: A LAST WORD ON FARMS (L1.AS6.1) CONT...

Remember: Safety gear helps protect some farmers for some jobs. Children keep away from farm work areas.

3. FILL IN THE SENTENCE.

FARMERS WEAR SAFETY GEAR FOR SOME FARM JOBS

Colour the...

Gloves - **Yellow**

Goggles - **Blue**

Ear muffs - **Red**

Overalls - **Grey**

Boots - **Black**

Hat - **Brown**

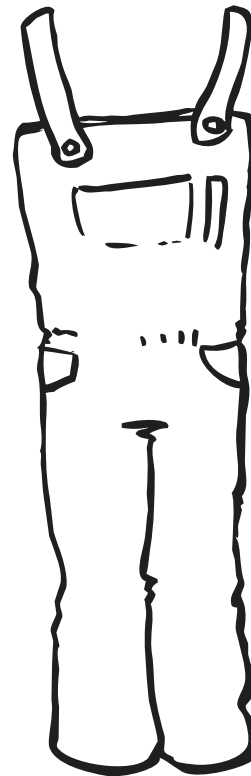
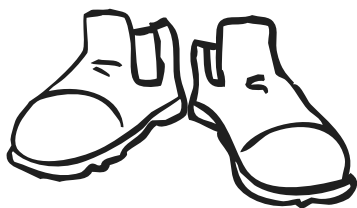
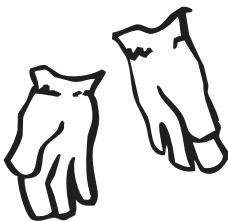
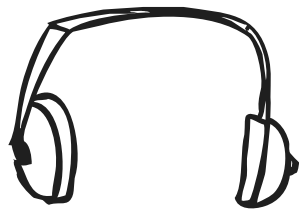

Cut out the gear and paste them on the farmer.

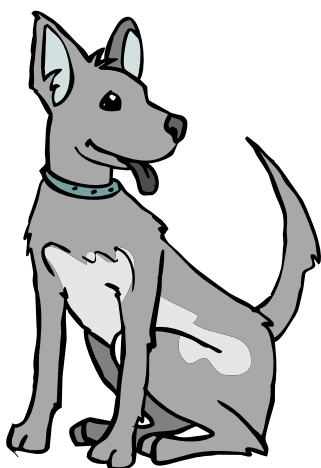

EARLY PRIMARY FOCUS

Early primary focus

EARLY PRIMARY FOCUS

Students further explore natural and built features of farms. Students develop an understanding of how people work with and modify farm environments in order to produce food and other products to sell. Different family members have different abilities and roles on the farm. Many features and activities in the farm workplace can be hazardous to children. Children develop a greater understanding of safe places to play; how to get help; and how rules and safe behaviours promote their own safety and that of others. Children can participate safely in some activities on the farm, but there will be different rules for different family members. Families can work together to make farms environments safer places.

TOPICS

TOPIC 1: **ABOUT FARMS**

TOPIC 2: **PEOPLE AND ENVIRONMENTS**

TOPIC 3: **WATER ON FARMS**

TOPIC 4: **SAFE PLACES**

TOPIC 5: **SAFE BEHAVIOURS**

TOPIC 6: **BEING MORE SPECIFIC**

TOPIC 7: **A FRIENDLY TOUR**

TOPIC 1: ABOUT FARMS

Overview: Students examine natural and built features of farms as places. Typical activities involved in farm production on local farms are explored and the need to consider safety aspects introduced. Children create a farm model or mural to reinforce learning about the features and purpose of farms.

Teaching Strategies	ACTIVITIES	Resources
<p>Storybook</p> <p><i>Knowledge and understanding</i></p>	<p>Activity 1: FEATURES OF FARMS</p> <p><i>Key point:</i> There are natural and built features common to many farms. Farms are local places where people grow plants or raise animals for their own needs or for sale.</p> <p>Read a story-book about a child who lives on a farm. Children can:</p> <ul style="list-style-type: none"> Identify features shown / mentioned in the book characteristic of farms. Describe activities carried out on a farm. 	<p><i>Examples:</i> Geena + Harry's farm,</p>
<p>Pictures / photo display</p> <p><i>Analysis</i></p>	<p>Display different photos/pictures of farms from the CD slideshow and from children who have brought in photos of their farm. Children can:</p> <ul style="list-style-type: none"> Name the features shown in the pictures Children from farms "Show" the features in their photos and "tell" the class about them. Choose one of these features to draw and label. Pin each drawing under one of the headings: people, natural and built features of farms. Discuss the differences between these 	<p><i>Pictures of different types of farms (CD slides)</i></p>
<p>Workbooks</p> <p><i>Synthesis</i></p>	<p>In workbooks, children can:</p> <ul style="list-style-type: none"> Make a title page for their unit on farms. Draw a picture of a farm with some typical features. Write a sentence to describe what type of farm it is and what activities people carry out. 	
<p>Visit by a farmer</p> <p><i>Knowledge and understanding</i></p>	<p>Activity 2: LOCAL FARM ACTIVITIES AND PRODUCTION</p> <p><i>Key points:</i> Farmers work with the land to grow plant and animal products for sale or for their own use. Some parts of the farm can be unsafe and people need to take care of children.</p> <p>Arrange a visit to the class by a local farmer to "show & tell" (preferably with slides and samples):</p> <ul style="list-style-type: none"> What is produced on their farm Activities carried out by different family members Safety aspects of the farm, with an emphasis on how kids stay safe 	
<p>"Workboot" reading</p> <p><i>Knowledge and understanding</i></p>	<p>Following the visit, read an extract from the "Workboot Series" of books for primary age children, for the type of primary industry discussed by the visitor (eg. rice, dairy). Choose a section that explains the stages of production on farm and the activities associated with these. Children can:</p>	<p><i>"Workboot Series"</i></p>
<p>Activity sheet</p> <p><i>Evaluation</i></p>	<ul style="list-style-type: none"> Complete the activity sheet* Explain if they would like to be a farmer or not. Why? 	<p><i>Activity sheet 2.1.2</i></p>
<p>Farm mural / model</p> <p><i>Application</i></p> <p><i>Synthesis</i></p>	<p>Activity 3: FARM MURAL / MODEL</p> <p><i>Keypoint:</i> Children can work together to create a farm model/mural with features typical of the local area. People modify natural environments to make farms.</p> <p>On an old bed-sheet, draw/paint an outline "map" to represent a farm. Use this as a 'floorplan' for the farm model or as the basis of a mural. Children develop the mural or model farm through the unit. To begin, children can:</p> <ul style="list-style-type: none"> Discuss, plan and decide the type of farm it will be and what natural and built features the farm will have (eg. dams, creeks, bush areas, fences. buildings, trucks, tractors, other farm implements, motorbikes, horses, dams etc). Cut-out pictures /make small 3-D models of these features <p>Add other features relating to safe places and safety features as children progress through the unit</p>	<p><i>Bedsheet, paint supplies, rural/farm magazines; craft cut paste materials</i></p>

TOPIC 2: PEOPLE AND ENVIRONMENTS

Overview: People make choices about how to use places and modify the natural environment to meet their needs. Children identify ways people have changed and interacted with the environment both past and present. Children examine ways of caring for different environments and how this can help to promote health and safety.

Teaching Strategies	ACTIVITIES	Resources
<p>Book-reading <i>Knowledge and understanding</i></p> <p>Picture based discussion <i>Knowledge and understanding</i></p> <p><i>Analysis</i></p> <p>Activity sheet <i>Synthesis</i></p>	<p>Activity 1: PEOPLE MODIFY ENVIRONMENTS</p> <p><i>Key point: People modify natural environments to meet their needs. Farmers and graziers use the land in certain ways. Before European settlement, Aboriginal people used the land in different ways.</i></p> <p>Read an extract from a “story-book” about early Aboriginal life (from your library). Children can:</p> <ul style="list-style-type: none"> • Discuss how Aboriginal people in the past: <ul style="list-style-type: none"> • lived on the land • modified the environment to suit their own needs • had different roles rules for different family members <p>Display the before / after pictures of a natural Australian landscape*.</p> <ul style="list-style-type: none"> • For the “before farming” landscape, children can: <ul style="list-style-type: none"> • Identify and name the natural features • Discuss how an Aboriginal family may have used the land and met their needs (eg. food, shelter) • How might Aboriginal people have modified the environment? • Discuss ways an Aboriginal family would have stayed healthy and safe in this environment (eg. identify unsafe areas, family rules, bush medicine etc.) • For the “after farming” picture, children can: <ul style="list-style-type: none"> • Identify and name the built features. • Discuss how a farming family meets their needs these days. • How have they modified the natural environment? • Suggest the type of farm products grown produced here. • Discuss ways current farmers promote health and safety today (eg. identify unsafe areas, family rules, design safer machines and safety gear) • Complete the “Spot the difference” activity sheet* 	<p><i>Library book on traditional Aboriginal life</i></p> <p><i>Australian landscape illustrations*</i></p> <p><i>Activity sheet 2.2.1</i></p>
<p>Class Discussion <i>Knowledge and understanding</i></p> <p>Drawing <i>Application</i></p> <p>Ask a family member <i>Analysis</i></p> <p>What do you think? <i>Evaluation</i></p>	<p>Activity 2: PEOPLE CARE FOR ENVIRONMENTS</p> <p><i>Keypoint: People can modify natural environments, but are also a part of it. People can promote health and safety by caring for the environments in which they live.</i></p> <p>Discuss the meaning of the terms environment, health, safety. Using examples, explain how caring for the environment can promote health and safety (eg. prevent fires, erosion, clean water and air, safety hazards). Children can:</p> <ul style="list-style-type: none"> • List ways they care for the environment: at home, at school, • Draw a picture of themselves in a scene where they are caring for the environment. • Ask a family member or other adult one or both of the following: <ul style="list-style-type: none"> • ways the local council and people in town care for their town environment • ways people on farms and rural properties care for their farm environment <p>Make a class list of ideas for how people in towns and on farms/rural properties care for the environment. Discuss which ideas also help people to stay healthy and safe.</p> <ul style="list-style-type: none"> • Imagine someone asks – “What’s the environment got to do with health?” <ul style="list-style-type: none"> • Write a response to this question • Give an opinion on whether they think caring for the environment is important or not. 	

TOPIC 3: WATER ON FARMS

Overview: Plants and animals have varying water needs and the amount of water available will affect what type of farm is common in an area. Water can be found in different forms on farms and rural properties. Some of these have characteristics that can be unsafe for children. Children need to identify water hazards and ways of staying safe around water on farms.

Teaching Strategies

ACTIVITIES

Resources

Activity 1: WE NEED WATER TO GROW THINGS

Keypoint: Farms need water for crops / pastures and for animals to drink. Most farms rely on rainfall for water. Some farms receive more rainfall and can grow "thirstier" crops and pastures. People adjust to water shortages in times of drought, but this can be difficult.

Garden walk

Walk the class around the school garden, discuss the water needs of plants and how some plants require more water than others. Children can:

Knowledge and understanding

- List some of the main plants in their own garden or farm (or on their farm). Identify those types that need more watering than others (if known).
- Describe what gardeners do to help plants grow (eg. dig, water, weed, fertilise).
- Suggest ways farmers help plants to grow. Do they do similar things to gardeners? Do they grow thirstier plants in places with more rain? (eg. lush dairy pasture)

Water-saving plan & role play

Synthesis

- Imagine you have a farm and the weather bureau forecasts a drought next year.
 - Draw up a plan of ways to could conserve water (eg. not waste water in the house, sell some animals, grow less thirsty crops / pastures, transport water)
 - In small groups, role play ideas at a "family meeting". Decide who are the parents and children – everyone can have an opinion, but who will have more say?

Evaluation

- Discuss when or if there is any such thing as too much rain

Activity 2: FARM WATER BODIES

Keypoint: Water can be found in different forms on farms / rural properties. Many farm water bodies have characteristics that can make them unsafe for children. There are some clear safety measures for water and children on farms and rural properties.

Picture based discussion

Display and discuss the type of water bodies found on farms and what water is used for on local farms / rural properties. Children can:

Farm model/mural

- Find pictures in magazines or draw pictures / make models of these for the farm mural / model.

Knowledge and understanding

Discuss characteristics of farm water bodies that can make them unsafe for children (eg. steep sides, muddy banks, murky water, deep, reeds and currents) and important safety measures that can help prevent drowning (eg. stay in safe play areas; close adult supervision if near water; swimming lessons, CPR; no fooling around; sunscreen). Children can:

Activity sheet

- Complete the activity sheet* relating to farm water bodies and safety measures
- In their own words, devise a set of water safety rules for children visiting the class farm (model / mural). Add these to the mural / model and a copy into their own workbook.

Application
Synthesis

(NB. Make sure these include safe play areas and adult supervision at all times)

School grounds/
gardens

Farm water scenes
CD slides

Rural magazines,
newspapers, craft
supplies

"Drowning" factsheet*

Activity sheet 2.3.1

Continued from previous page.

Teaching Strategies	ACTIVITIES	Resources
<p>Photo-based discussion</p> <p><i>Knowledge and understanding</i></p> <p>Irrigation experiment</p> <p><i>Application</i> <i>Analysis</i></p> <p>Cake demonstration and debate</p> <p><i>Analysis</i> <i>Evaluation</i></p>	<p>Activity 3: IRRIGATION ON FARMS (if locally relevant)</p> <p><i>Keypoint: Some farms and rural properties are in areas where they can use water for irrigating their crops and pastures. Irrigators use water from rivers and canals so they can grow thirstier crops / pastures in drier areas.</i></p> <p>Display the pictures of water on farms and identify those showing irrigation. Discuss the principles involved.</p> <p>Children can either:</p> <ul style="list-style-type: none"> • Make canals with sand and water in plastic containers. • Grow a bean or alfalfa “crop” in a sandbox, using irrigation. <ul style="list-style-type: none"> • <i>Plant alfalfa / bean seeds in one corner,</i> • <i>Water daily by pouring water in the other corner and allowing a ‘channel’ or ‘hose’ to take it to the seed.</i> • <i>Contrast this with a sandbox that has no canal/ hose supplying water top the seeds</i> • Imagine the sandbox was their farm. Does irrigation allow you to grow plants that wouldn't normally grow there? <p>Irrigation helps farmers to grow crops / pastures where they normally wouldn't grow. However, making sure everyone has a fair share of water is not always easy and people often meet to work these problems out. To demonstrate these difficulties:</p> <ul style="list-style-type: none"> • Bring in a “blue-iced cake” to represent “water in river / dam” • Cut the cake into slices for children, but not enough for everyone in the class • Ask the class to decide who will miss out or come up with ways to make distribution “fair” • How can we make sure everyone gets a share of the water, including the natural environment? What if people paid for large pieces of cake (water) Should they have that cake taken away? How would you feel and what would you do? 	<p><i>Farm water and irrigation scenes (CD slides)</i></p> <p><i>Large, flat plastic containers, sand, water, seeds</i></p> <p><i>Cake</i></p>

TOPIC 4: SAFE PLACES

Overview: Some features and activities carried out on farms are hazardous to children. Children identify characteristics of safe / unsafe areas on farms and rural properties and the main hazard categories that cause the most serious injury to children on farms. Children design / construct a model safe play area for a farm and add this to the class mural / model.

Teaching Strategies

ACTIVITIES

Resources

Picture cards

Knowledge and understanding

Analysis

Application

Pamphlet based discussion

Knowledge and understanding

Activity sheet

Synthesis

Design / construct a safe play area

Evaluation

Take home materials

Activity 1: SAFE AND UNSAFE

Key Ideas: Farms can be fun but children need to be aware of places and things that can be unsafe on farms. Children need to identify the differences between safe / unsafe places to play.

Discuss the meaning of the terms safe / unsafe, hurt / injured. Children can:

- Display the scenes farm and features from the slideshow and discuss if each is safe or unsafe for children to play
- Discuss reasons why each example is safe or unsafe for children to be.
- List other examples of places / features of children's own farms which might be unsafe.
- Arrange these into headings: water, farm vehicles & machinery, animals and 'others'.
- Describe ways their own families make these places / features safer.
Can these always be made completely safe? What can we do if we can't make hazards safer?

Activity 2: SAFE PLAY AREAS

Keypoint: A securely fenced safe play area separates young children from farm hazards. This makes supervising children easier and helps families make sure children are safe.

Read extracts of the Safe Play Areas on Farms* brochure/or booklet.

Discuss the main points at a child's level. Children can:

- Complete the Safe Play Areas on Farms activity sheet*
- Imagine they have been asked to design a safe play area on a local farm. In small groups:
 - *Discuss where they will locate it, what features would / would not be in the area. What type of fence will be around it.*
 - *Draw a picture or a plan of the area, showing features that (eg. Include unsafe features outside the "fenced area" such as tractors, vehicles and dams).*
 - *Present the plan to the rest of the class and compare the design features*
- Construct a safe play area (from craft odds and ends), based on these ideas and add this to the mural / model.
- Write a sentence to explain if a fenced safe play area is a good idea or not. Why?
- Take home a copy of the 'safe play areas on farms' pamphlet to discuss with parents

CD slideshow farm scenes

*Safe Play Areas on Farms pamphlet**

Activity sheet 2.4.1

Art & crafts odds and ends, paints, crayons etc.

TOPIC 5: SAFE BEHAVIOURS

Overview: Essential safety behaviours for children on farms are explored and rules for different family members discussed. Children compare safe and unsafe ways of behaving using activities in the Giddy Goanna Series. Basic first-aid situations are investigated and children practice how to get help in an emergency.

Teaching Strategies	ACTIVITIES	Resources
<p>Class discussion</p> <p><i>Knowledge and understanding</i></p> <p><i>Analysis</i></p> <p>Safety signs</p> <p><i>Knowledge and understanding</i></p> <p><i>Synthesis</i></p> <p>Activity sheet</p> <p><i>Application</i></p>	<p>Activity 1: SAFE BEHAVIOURS</p> <p>Keypoints: <i>Child safety agencies recommend the following behaviours as essential to prevent the more serious injuries that happen on farms. Under the care of an adult, children need to:</i></p> <ul style="list-style-type: none"> • Play in the safe play area unless an adult takes them out and looks after them. • Stay within sight / sound / contact of a supervising adult when out & about on the farm • Tell a carer immediately if they are feeling unsafe / unsure of a situation on the farm • Other important safety behaviours include: <ul style="list-style-type: none"> • <i>Wearing seatbelts and restraints in farm vehicles</i> • <i>Children do not ride on tractors, ATV's or on the back of utes</i> • <i>Always wear helmets when riding bikes, motorbikes and horses</i> • <i>Knowing how to respond in an emergency</i> <p>Discuss some of the rules children and adults need to follow at home, at school etc. Children can:</p> <ul style="list-style-type: none"> • Suggest why we have rules • Describe what might happen if children did not follow these rules. • Give examples and suggest reasons why rules are different for a toddler, an 8, and 14 year old. • Suggest why telling a toddler to follow rules does not usually work. <p>Make some "signs" based on the key safety rules described above (activity 1). Children can:</p> <ul style="list-style-type: none"> • Choose one of the key safety rules • Write a sentence to explain why this rule is important • Draw /find /cut and paste pictures to illustrate the message on A3 / 4 size poster • Attach the posters around the edge of the class mural / model <p>Focusing on key safety rules, children can:</p> <ul style="list-style-type: none"> • Complete the activity sheet* • Ask parents about ways they keep children safe at home/on farms and rural properties. 	<p><i>Art + craft supplies</i></p> <p><i>Activity sheet 2.5.1</i></p>
<p>Giddy Goanna books - game</p> <p><i>Knowledge and understanding</i></p> <p><i>Analysis</i></p> <p><i>Synthesis</i></p>	<p>Activity 2: GIDDY GOANNA (If available)</p> <p>Keypoint: <i>Giddy Goanna behaves in safe ways on farms and rural properties. The Careless cousins behave in unsafe ways. Children identify well with these characters.</i></p> <p>Using one or more of the 3 farm-based Giddy Goanna Activity Books, in small groups, children can:</p> <ul style="list-style-type: none"> • Point out how Giddy plays safely on the farm • Compare this with the behaviour of the Careless Cousins • Play the board game in the centre of the activity book • Draw a picture of Giddy in their workbook with a safety message Giddy might say. 	<p><i>Giddy Goanna Activity Books 1, 2 or 3</i></p>

From previous page...

Teaching Strategies

ACTIVITIES

Resources

Activity 3: WHAT DO I DO?

Keypoint: Children need to recognise when they need help and how to get it. Children can help with some basic first-aid situations, but need to know who to contact in an emergency.

Scenario role plays

Read through the scenario/role play*. Discuss with children what they might do in this situation when someone is badly hurt on the farm. (Optional: If there is a red cross, St. John Ambulance, community nurse, or volunteer – invite them to visit the class and assist with this activity). Children can:

Activity sheet 2.5.2

Knowledge and understanding

- Describe how they feel when they are scared or unsure of something. How does their body react? What should they do in this situation? (Tell someone, Get help)

Analysis

- Role play the scenario and explore variations of it to demonstrate basic first-aid skills for different types of injury (eg. stop bleeding with gentle pressure; clean and cover a wound; run cold water over burns; put an ice pack / bag of frozen peas on bumps to stop swelling; rest a sprained ankle and raise it).

Emergency phone guide

- Practice making an emergency call for help. Discuss the possible situations when this might be needed. Who would they call. What would they call? What would they need to say to get the right help? What could they do to stay safe until help arrived?

Activity sheet 2.5.3

Application

- Take home the emergency phone guide activity sheet and complete this with parents. (Adjust for use with a two-way radio if this is relevant for children in the class).

TOPIC 6: BEING MORE SPECIFIC..

Overview: There are specific features and activities on farms which can be explored in more detail. These provide greater choice to pursue issues of particular interest, but should consolidate general messages in Topics 4 and 5. Four themes are explored: water safety; farm vehicles and machinery; horses and farm animals; and other farm hazards.

Teaching Strategies	ACTIVITIES	Resources
<p>Activity cards</p> <p><i>Knowledge and understanding</i></p> <p><i>Analysis</i></p> <p><i>Synthesis</i></p>	<p>Activity Cards:</p> <p><i>Keypoint: There are particular types of farm hazards which have features that can be explored in more detail. Safety measures can be more tailored and specific, but should reinforce general safety messages (Topic 4).</i></p> <p>In small groups, provide children with one of the activity cards* which focus on particular types of farm hazards. Alternatively, select items from different cards. Children can:</p> <ul style="list-style-type: none"> • Work through the activities as a team • Share what they have learned about that type of hazard with the class • Complete the mural with items from the activity card options. <p>Activities should generally focus on:</p> <ul style="list-style-type: none"> • Identifying the features of the hazard • Consequences of injury • Key messages for staying safe with that type of hazard • Reinforce general safety measures (Topic 4 & 5) 	<p><i>Activity cards*</i></p>

TOPIC 7: A FRIENDLY TOUR

Overview: Children determine particular ways of keeping themselves and a friend safe when visiting the farm. Children are given opportunity to reflect on and display their work and take parents on a tour of the class mural / model.

Teaching Strategies

ACTIVITIES

Resources

Activity 1: A FRIEND ON THE FARM

Keypoint: *Children can help to keep themselves and others safe. Children can share their knowledge about farm safety by orienting an imaginary visitor.*

Children imagine some friends from the city are coming to stay for a holiday, but they don't know anything about farms or rural properties. Children can:

Letter-writing
Synthesis

- Write a letter to the friend describing how much they are looking forward to the visit, some of the activities they will do, some of the hazards to avoid and safety rules to follow.

Farm mural

- Draw a picture / make models of themselves and the friend doing an activity safely on the farm and add these to the farm mural/model.

Role play
Application

- Role-play giving their friend from the city a guided tour around your mural / model farm, explaining different features and the importance of safe play areas and safety rules.

Activity 2: WHAT DO YOU THINK?

Keypoint: *Children reflect and express what they liked and what they learned about farms through the unit and have the opportunity to take parents on a 'tour' of their class mural / model*

Class Presentation

Invite parents to come to the class to view the farm unit class mural / model, posters and children's workbooks. Children can:

Application

- Take their parents on a virtual 'tour' of the model or mural, showing the different features and safety aspects.
- Give a grade presentation at a school assembly, incorporating role plays, farm visit recounts and letter reading etc.
- Farm safety promotional resources* can be made available for parents to take home.

Book work

In their workbooks, children can write a summary to describe:

Evaluation

- What they liked most / and least about the farm unit and why
- What they have learned about farms from the unit
- What they think are important ways to stay safe on farms.

*Take home farm safety materials**

TOPIC 1: ABOUT FARMS (L2.AS1.1)

Name:

Class:

Learning Outcomes: ACT NSW NT QLD SA TAS VIC WA

Tasks and indicators

Achieved

Defines features and activities characteristic of local farms

Identifies ways of being safe in the farm environment

Describes how people interact with farm environments

Reports on resources and activities needed to produce a farm product

ACTIVITIES:

1. A VISITOR FROM A LOCAL FARM

We had a visit by _____ who told us about their farm.

We learnt the following things about farms:

Plants on the farm:

Animals on the farm:

Machines on the farm:

Buildings on the farm:

Jobs on the farm:

Children can do these things on the farm:

Children stay safe by:



TOPIC 1: ABOUT FARMS (L2.AS1.1)

2. WORDS TO DESCRIBE FARMS

a. Some people call “farms” by different names. Some other names for farms include:

property station plantation orchard market garden stud vineyard

What other words are used instead of ‘farms’ in your area? What do they mean?

b. There are also different kinds or ‘types’ of farms and properties in Australia. Some examples are:

sheep dairy rice wheat cattle cotton mixed hobby farms

Write a sentence or two to describe the ‘types’ of farms in your area.

3. PEOPLE WORK ON FARMS

Fill in the boxes below to show how farmers produce things for their own use or for sale.

a. **Wheat crops**

b. **On local farms**

The f__rmer uses
a tr__ctor to sow
the s___d

S__nshine and rain
m__kes the se_d
gr__w into plants

The f__rmer uses a
h__rvester to cut the gr__in.
A tr__ck takes the gr__in
to the s__lo.



TOPIC 2: PEOPLE AND ENVIRONMENTS (L2.AS2.1)

Name:

Class:

Learning Outcomes: ACT NSW NT QLD SA TAS VIC WA

Tasks and indicators

Achieved

Identifies ways people interact with and modify the environment over time

Explains how people are part of the environment and need to care for it to promote health and safety

ACTIVITY: ENVIRONMENTS AND TIME

1. COMPARE THE LANDSCAPE PICTURES BELOW. COLOUR AND LABEL EACH WITH THE WORDS LISTED.

Landscape 1: **Before European contact**



Bushland
Camp
Man
Woman
Creek
Kangaroo
Dingo
Children

Landscape 2: **Present day**

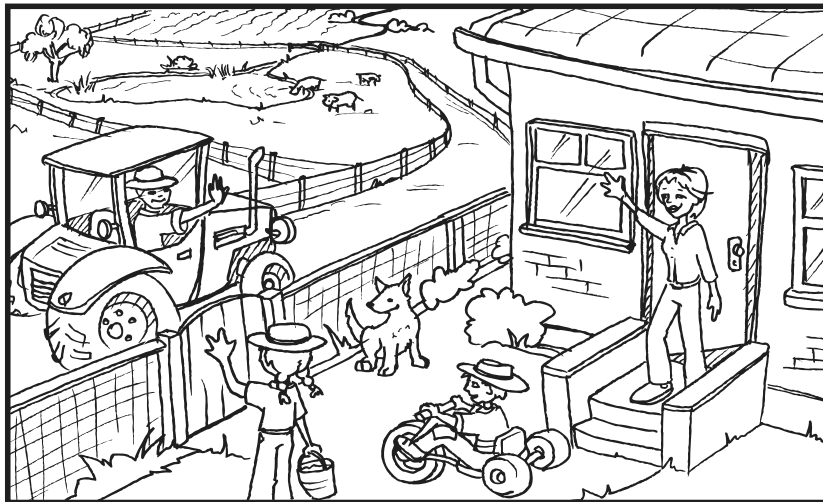

Paddock
House
Man
Woman
Dam
Cattle
Dog
Tractor
Children

2. ON A NEW PAGE, WRITE A PARAGRAPH TO EXPLAIN:

- How people may have changed the environment since traditional Aboriginal times.
- Why caring for the environment can help keep people healthy and safe.

TOPIC 2: PEOPLE AND ENVIRONMENTS (L2.AS2.1) CONT...

ILLUSTRATIONS FOR CLASS DISCUSSION

Landscape 1: **Before European contact**

In the past, Aboriginal women collected bushfoods such as vegetables, roots, fruits, nuts, eggs and honey. They hunted small animals such as snakes, goannas. Men fished and hunted emu, kangaroo and birds. Camp shelters were made of branches covered with brush and grass.



Landscape 2: **Present day**

Most people today live in houses and in towns. They buy food from a shop. People on farms have changed the environment, to grow crops and livestock such as sheep and cattle. These are used to make food and clothing for themselves and others in the towns. How do people care for this environment today? **How do they stay safe?**

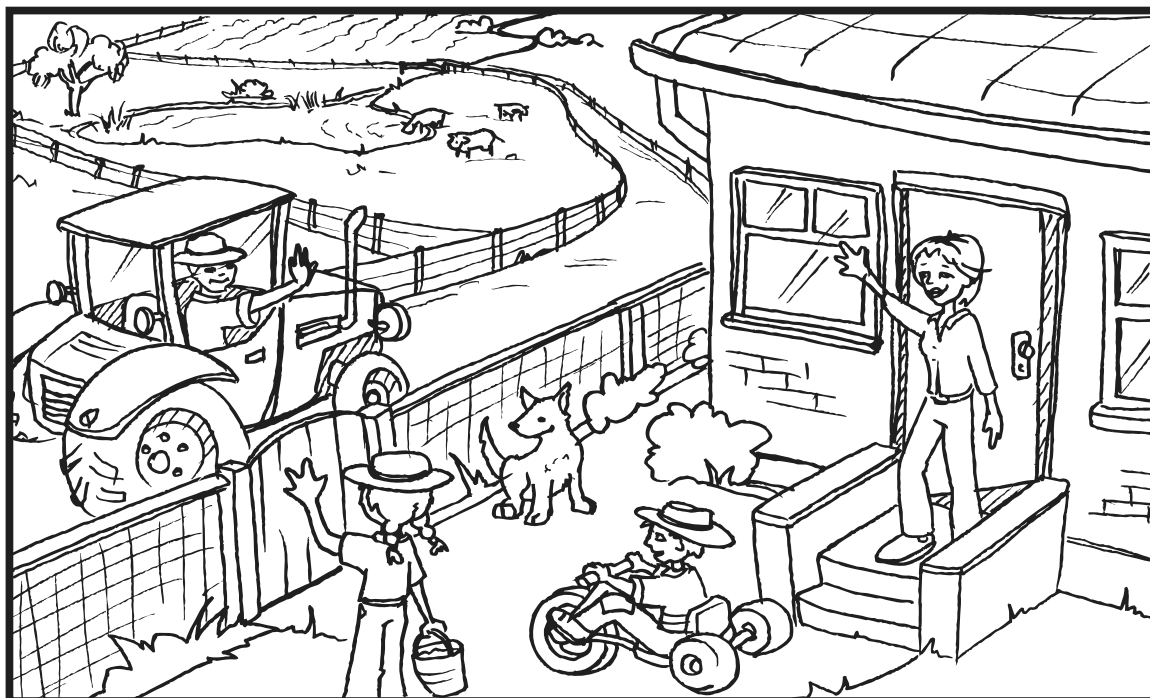

TOPIC 3: WATER ON FARMS (L2.AS3.1)

Name:

Class:

Learning Outcomes: ACT NSW NT QLD SA TAS VIC WA

Tasks and indicators

Achieved

Identifies types and features of water bodies found on farms

Describes ways of protecting the health and safety of self and others

ACTIVITIES:

1. FARM WATER BODIES

There are different kinds of water bodies found on farms. Colour and name the three water bodies shown below.

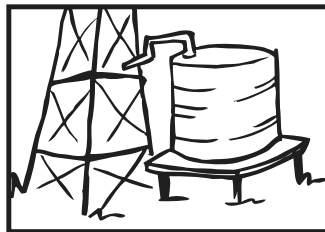
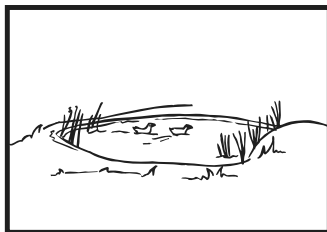

D _ _ _

R _ _ _ _

T _ _ _ _

There are other water bodies on farms too. Many of these have features that can be unsafe for children. For example, some have deep and murky waters or steep and slippery sides which make them easy to fall in. Always make sure an adult is “keeping watch” if you are near these places.

Find each of these water bodies in the water-word. Fill in the blank letters to complete each word.



CREEK

TROUGH

POND

DAM

RIVER

SHEEP DIP

DRAIN

POOL

LAKE

CHANNEL

						P			C
				T	R	?	?	G	H
			S	?		O			?
			H	N		L			N
C	R	?	?	K					N
	?		?			L	?	K	?
	V		P			?			L
	?		D			G			
D	R	?	?	N		O			
?			P		P	?	N	D	
M						N			

TOPIC 3: WATER ON FARMS (L2.AS3.1) CONT...

2. GEENA AND HARRY'S WATER-HOLE

Geena and Harry sometimes go to the creek to fish. Mum or Dad always go with them.

Find and colour in each of these animals in the picture below.

YABBIE (OR CRAYFISH)...YELLOW

FROG ... GREEN

FISH ... BROWN

SNAKE ... BLACK

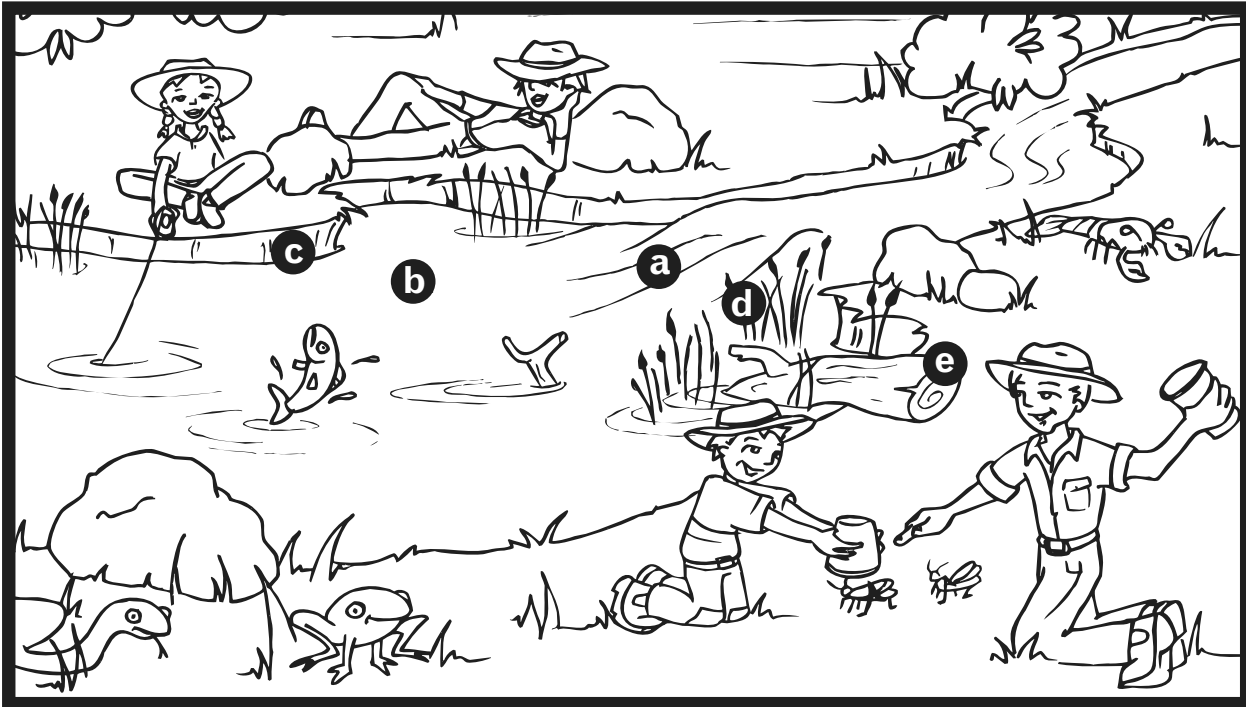

Look at the 5 features of the waterhole marked with the letters a,b,c,d,e.

Write a sentence or two to describe what makes these features unsafe.

a. fast currents:

b. deep murky waters:

c. steep banks:

d. water reeds:

e. underwater logs:

Fill in the letters to find the name of this famous waterhole. A certain swagman jumped into its deep and murky waters... **B _ L L _ B _ _ G**

3. WATER SAFETY RULES

Some places on farms are safe to swim in. Remember, ALWAYS ask an adult to check the water hole out first to make sure it is safeAND...have an adult STAY with you to KEEP WATCH while you swim. **Make up a set of safety rules for swimming on farms. Write these around your class farm model or mural. List the three most important rules here.**

1.

2.

3.

TOPIC 4: SAFE PLACES (L2.AS4.1)

Name:

Class:

Learning Outcomes: ACT NSW NT QLD SA TAS VIC WA

Tasks and indicators

Achieved

Defines features characteristic of farms

Identifies ways of being safe an the farm environment

Recognises that people's lives are influenced by rules

Remember: Farm hazards are things that can be unsafe.

ACTIVITIES:

1. SPOTTING FARM HAZARDS

Knowing what the hazard is, can help us work out the best ways to be safe.
 Help Harry spot the farm hazards with his Dad. Solve the "hazard clues" and give examples for each one.



Clue: I am runny and plants and animals need me to drink...

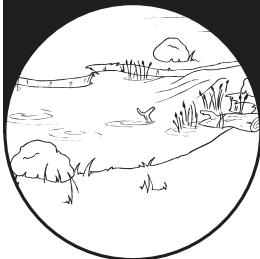

R _ _ _ _

Other kinds of farm water bodies:

Clue: I can be lots of fun if you learn to ride and wear a helmet, but take care, I have a mind of my own...

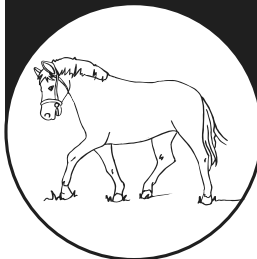

H _ _ _ _

Other kinds of farm animals:

Clue: I am noisy, have big wheels and pull things, spray things and plant things like crops...



T _ _ _ _

Other vehicles in the workshed:

Clue: I have two wheels and can be fun. Make sure someone teaches you to ride and wear your helmet...

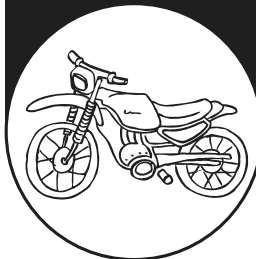

M _ _ _ _

B _ _ _

Other kinds of bikes:

Clue: I'm a "You beaut U_ _" but ride inside me, not on the back...

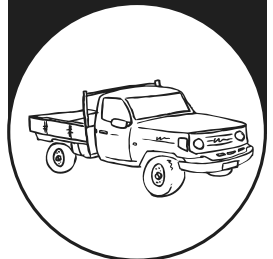

U _ _

Other vehicles in the driveway:

TOPIC 4: SAFE PLACES (L2.AS4.1) CONT...

2. OUT-OF-BOUNDS

Geena and Harry's family have out of bounds rules they follow.

Make a list of the places that are out-of bounds on the farm.



**OUT OF BOUNDS PLACES
ON THE FARM**



3. SAFE PLACES TO PLAY

Mum and Dad take Harry and Geena out and about on the farm, when they have time to keep a close eye on them. At other times, Geena and Harry play in the house yard where Mum and Dad can see they are playing safely. **What makes Geena and Harry's house yard a safe place to play?**

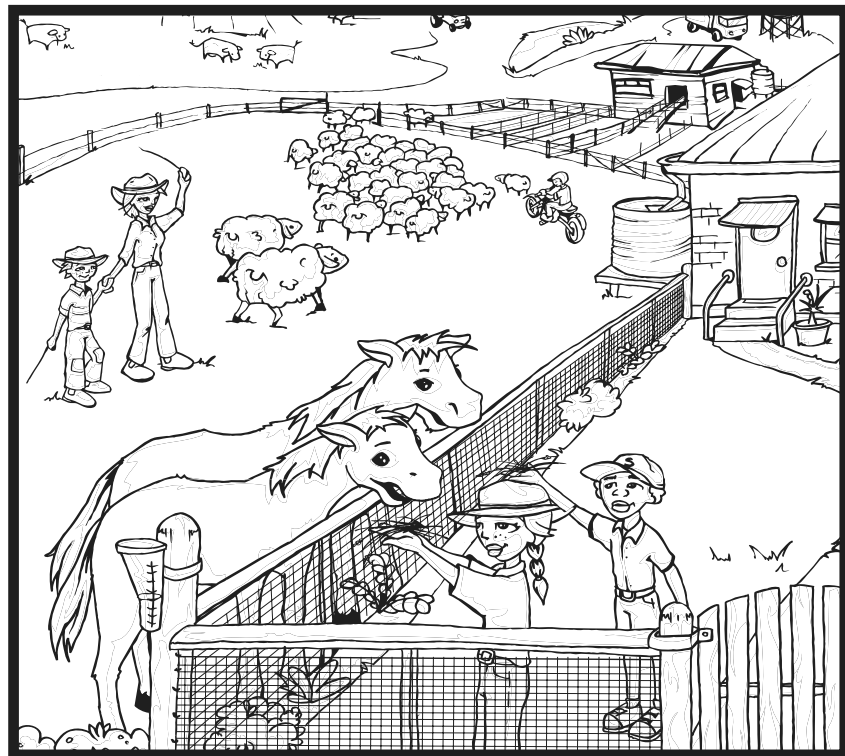

Harry and Geena have a 2 year old cousin, Mark. He likes to climb and wander.

Which part of the house yard will help to keep Mark from wandering away into the dam?

TOPIC 5: SAFE BEHAVIOURS ON FARMS (L2.AS5.1)

Name:

Class:

Learning Outcomes: ACT NSW NT QLD SA TAS VIC WA

Tasks and indicators

Achieved

Defines features and characteristics of farms

Identifies safe ways of behaving in the farm environment

Recognises that people make choices about activities and use of places

ACTIVITIES:

1. WHAT SHOULD THEY DO?

Children can have fun out on the farm, but small children need to have an adult close by to watch them and make sure they don't go "out - of - bounds". Always check with an adult if you are not sure what is unsafe.

Geena and Harry are out on the farm with Dad. Choose and circle the safe action at each spot.

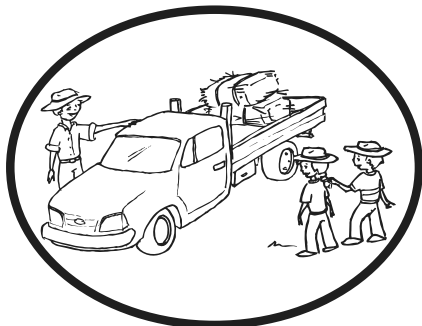

1. Geena and Harry go with Dad in the ute to feed some sheep. They:

Get in the front of the ute and buckle up their seatbelts.

Hop on the back of the ute, where they can fall off if dad hits a bump.



2. Harry gets a little scared when the sheep come running up for the hay. He:

Says nothing, stands in the way of the sheep and starts to cry.

Tells Dad he feels scared and moves out of the way of the sheep.

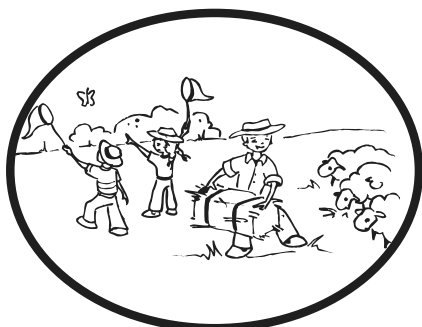

3. While Dad is feeding the sheep, Geena and Harry want to explore. They:

Don't tell Dad and wander off toward the creek.

Tell Dad and stay within sight and sound of him.

TOPIC 5: SAFE BEHAVIOURS ON FARMS (L2.AS5.1) CONT...



4. When they get back from the sheep, Dad has to do some work on the tractor.

Harry and Geena go to the house yard to play, where Mum can see them.

Harry runs over to Dad to hop in the tractor too.

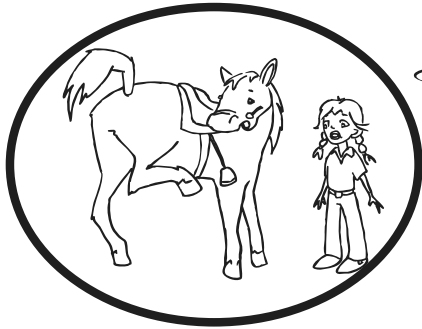

5. Mum asks the kids if they would like to go for a ride on the horses.

Mum catches the horse and Geena gets the riding helmets

Geena runs up behind the horse to catch him

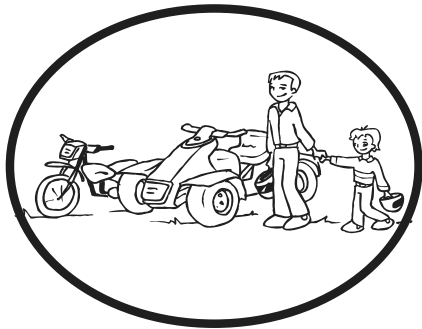

6. When dad is finished working, he asks Harry if he wants to ride the motorbike...

Harry jumps on the big four wheel motorcycle (ATV) and takes off down the track.

Harry gets on his own two-wheel motorbike and learns to ride with Dad's help.

1. WHY DID THEY DO THAT?

Explain what might happen if Harry and Geena made the **UNSAFE** choice.

1. _____
2. _____
3. _____
4. _____
5. _____
6. _____

HOMEWORK ACTIVITY:

When children are out and about on the farm, adults need to be "close-by to keep-an-eye" .

With the help of your parents, explain what this means?

TOPIC 5: SAFE BEHAVIOURS (L2.AS5.2)

Name:

Class:

Learning Outcomes: ACT NSW NT QLD SA TAS VIC WA

Tasks and indicators

Achieved

Describes ways appropriate behaviour can create a safe environment

Identifies family rules that keep them safe

Explains some reasons for having rules

Demonstrates basic first-aid skills

ACTIVITIES: 1. WHAT WOULD I DO?

Ryan comes to visit Harry. They are playing safely in the house yard. Ryan looks over the fence and sees some big machines over the fence. Ryan thinks they would be fun to climb on. "Let's go and play over there!" says Ryan. "I don't know", says Harry. "Mum says the shed is 'out-of-bounds' for kids." Ryan did not hear Harry. He climbs over the fence and is running to the shed. He is excited. "Wait!" says Harry. He follows Ryan. Ryan starts to climb on the tractor. He falls and bumps his leg on some metal. He cuts his leg and it starts to bleed. Ryan begins to cry.

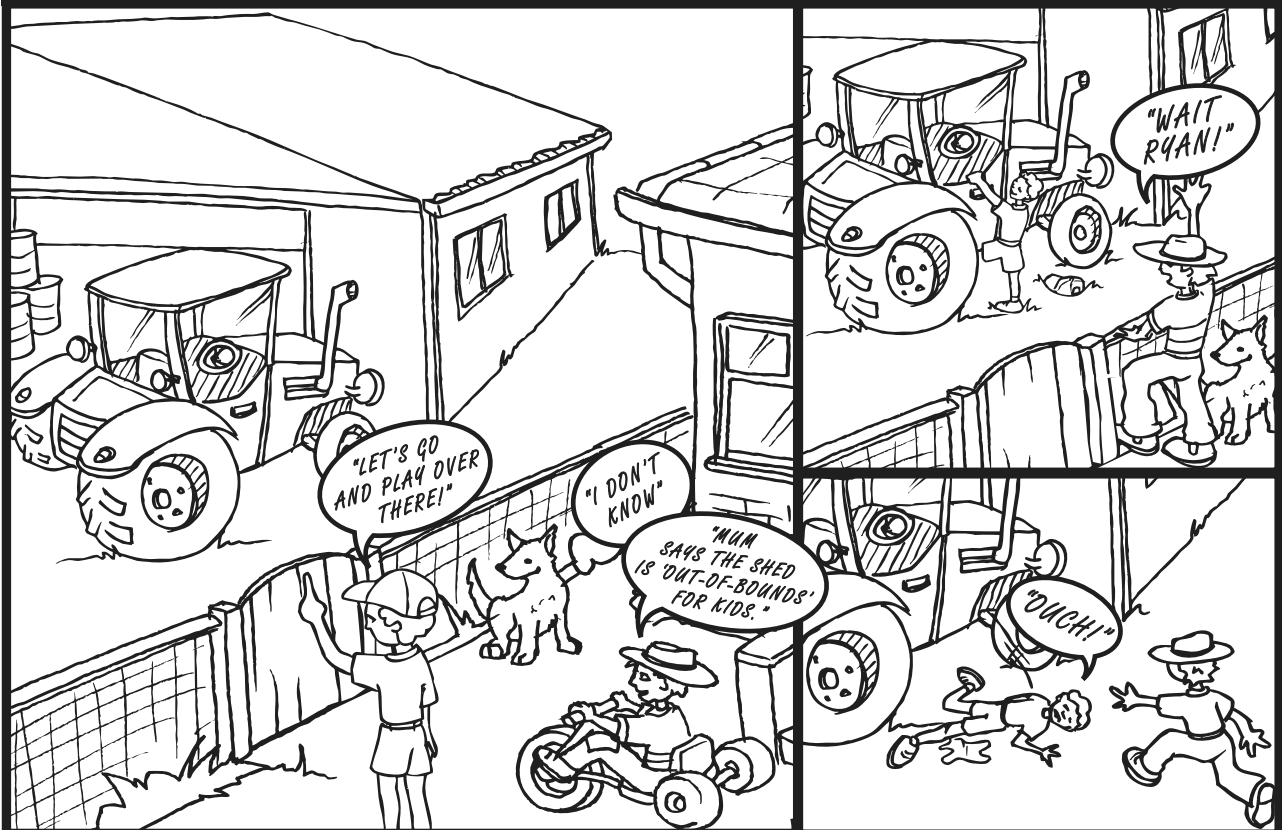

Discuss the actions of the boys in the story and how Ryan got hurt.

Identify places where the story could have changed and had a different ending.

How would you FEEL if you were Ryan? How would you FEEL if you were Harry?

What might you DO if you were Harry? Write down the MOST IMPORTANT thing for Harry to do?

Role play different ways of helping someone who is hurt on the farm.

TOPIC 5: SAFE BEHAVIOURS (L2.AS5.3)

Name:

Class:

Learning Outcomes: ACT NSW NT QLD SA TAS VIC WA

Tasks and indicators

Achieved

Describes and demonstrates how to make an emergency call

ACTIVITIES:

1. EMERGENCIES

Parents - We are learning about how to get help in an emergency. Please help us by discussing home / farm emergencies with your child and when to CALL 000. Tell children where they should go if they need to get out of the house. Help them with the information needed to complete the phone guide below.

Children - Colour in and fill out the Emergency Phone Guide below. Cover and place it near the phone.



IN AN EMERGENCY DIAL

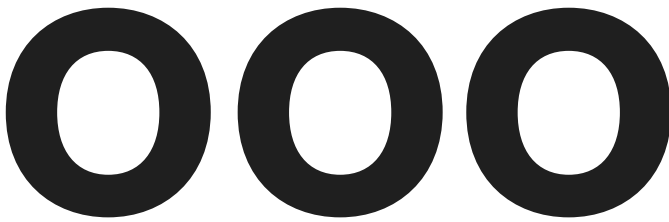

and answer
the questions
the person
asks...



1. WHICH EMERGENCY SERVICE DO YOU NEED? Say...

FIRE - if there is a fire

POLICE - if you are afraid and don't know what to do

AMBULANCE - if someone is really hurt and can't come to the phone

2. WHERE ARE YOU CALLING FROM? Say...

The address:

(ie. number and street, or property name/roadside number, town and state)

The nearest cross road:

3. WHAT HAS HAPPENED?

Say what happened. Speak slowly and clearly. Listen for instructions. **Help is already on the way!**

IF IT'S NOT AN EMERGENCY, BUT I STILL NEED SOME HELP OR ADVICE, I CAN CALL:

Name: _____ Contact No. _____

Name: _____ Contact No. _____

TOPIC 6: BEING MORE SPECIFIC (L2 ACTIVITY CARDS)

WATER SAFETY ON FARMS

1. Water safety rules

Building on from Topic 2, draw pictures to match the water safety rules on your mural/model. Include these safety rules:

- **Play in 'safe play areas' away from farm water**
- **Always have an adult 'keep watch' while you swim.**
- **Always wear sunscreen and a hat near the water**

2. Other safety measures

Find out if: **"Learn to swim" or "CPR" classes in your area.**
"Pool fences" are needed for pools on farms (ask council)

Make a 'flyer' with information about these for class members to take home.

Toddlers can drown in very shallow water. Drowning is the biggest danger to toddlers on farms. Families can:

- **Hold on to toddlers near water**
- **Empty old water troughs and put lids on tanks**
- **Have fenced safe play areas and gates that self-close**

Draw and label these safety rules for the mural or make models of these to add to the farm model.

FARM VEHICLES AND MACHINES

1. Children and machines.

In your group, make a poster about farm vehicles and machines.

- **Draw or find a picture of different machines describe what each is used for.**
- **Find out about each machine and under these headings.**
 - Unsafe features (eg. hard to see kids from)
 - Ways kids can be hurt (eg. runaway)
 - Safety messages. (Make sure to include the following):
 - **Play in 'safe play areas' away from farm vehicles and machines**
 - **Stay close to an adult who can watch and teach you**
 - **Follow family safety rules. Examples here could include:**
 - Always wear a seatbelt in cars and utes
 - Don't ride on tractors or large four wheel motorbikes (ATV's)
 - Always wear a helmet when riding two wheel motorbikes

2. Adults and machines

People who use machines need to take care. Find a picture or describe these safety features. Explain how each helps to keep people using machines safe.

- **Machine guards and locks**
- **ROPS**
- **Training and experience**

Present your poster and research to the class. Include the poster with your mural/model.

HORSES AND OTHER ANIMALS

1. Animal models and poster

Draw / make a model of different farm animals and add these to the farm model / mural.

Find out about horses and other farm animals for a poster. Place the information under these headings.

- **What the animal is used for**
- **Unsafe features (eg. can kick, bite)**
- **Ways kids can be hurt (eg. walk behind the animal and frighten it)**
- **Safety messages. (Make sure you include the following):**
 - Play in 'safe play areas' away from large animals
 - Stay close to an adult who can watch and teach you
 - Follow family safety rules. Examples here could include:
 - **"No helmet, no boots, no riding".**
 - **Don't run around behind horses and other large animals**
 - **Wash hands after handling animals**

2. Animal safety display

Arrange a display on safety with horses and other animals for the class. Include your poster and explain what is on it.

Ask family and friends to allow you to bring in items for the display. Present and explain what each item is for -

(eg. helmets, saddle, boots)

OTHER FARM HAZARDS

1. Chemicals

Chemicals on farms are used to run machines, to keep animals healthy, spray weeds and insects and clean things like milk sheds. But chemicals can burn and poison.

- Choose 3 or 4 chemicals used on farms. Make a factsheet about each. Include a picture of the container, its chemical symbol, its name, what it is used for and how to use it safely. Present these to the class.
- Talk about these questions in your group. Write down the groups ideas and share with the class.
 - **Why is a lock on the door of a chemical shed a good idea?**
 - **Should kids be allowed to play around chemicals? Why?**
 - **What should you do if you saw door of the chemical shed left open?**
 - **What if you saw a lemonade bottle in there. Would you go and get it?**
- Make your own model chemical containers by painting / pasting odds and ends, bottles and boxes. Invent names for them and put warning signs on them. Make a storage cupboard or shed out of cardboard carton. Put chemicals in it and lock it. Put a warning of some kind on the door. Add this to the farm model.
- If allowed, ask an adult to come, "show and tell" some chemical safety gear (eg. goggles, gloves, overalls, mask).

2. Noise

Noise is a hazard on farms. Loud noise from machines can damage your hearing. This takes many years, but by then it can't be fixed. Kids hearing can be damaged stacking wood near chainsaws; or when near adults using guns.

- **Find out five things people on farms can do to save their hearing. Present your findings to the class.**
If possible, include some earmuffs or plugs to show to the class.

3. Silos

You have a job for "**Kids-Encarta**", a kids encyclopaedia. You have to write about silos.

- **Describe what a silo is and what it is used for. Explain why silos are out-of-bounds for children.**
Include unsafe features of silos and how you can be hurt. Include safety rules and a picture.
- **Make a model of a silo for the farm model, or a picture to add to the mural.**

MIDDLE PRIMARY FOCUS

Middle primary focus

MIDDLE PRIMARY FOCUS

Learning at middle primary level builds upon the concept of the farm as having unique features / purpose and safe / unsafe areas; to focus on different roles of people in families and how people can plan for safety on farms. Children examine rainfall and the seasons as examples of how natural cycles effect what is produced on the farm and the activities carried out. Children can visit a local farm and look at the responsibilities and activities of different family members. Characteristics of farm hazards are explored and children assess the impact of injury on families. Basic injury responses and strategies to deal with unsafe / emergency situations are identified and practiced. Ways farm families can prevent farm injuries are examined through creation of safer play areas, safer design features, safe practices and safety gear.

TOPICS

TOPIC 1: **LOCAL FARM ACTIVITIES**

TOPIC 2: **RAIN, HAIL AND SHINE**

TOPIC 3: **IDENTIFYING HAZARDS**

TOPIC 4: **RESPONDING TO INJURY**

TOPIC 5: **FARM AND HOME EMERGENCIES**

TOPIC 6: **SAFE PLACES AND DESIGN**

TOPIC 7: **SAFE BEHAVIOURS AND GEAR**

TOPIC 8: **FARM SAFETY SUMMARY**

TOPIC 1: LOCAL FARM ACTIVITIES

Focus: Children visit a local farm / rural property to observe and describe activities involved in primary production. Children describe places / activities that can be unsafe and ways to ensure safety for family members and visitors. The different roles and responsibilities of family members are explored in the context of living on farms as well as levels of responsibility for safety.

Teaching Strategies

ACTIVITIES

Resources

Farm excursion

Knowledge and understanding
Analysis

Activity sheet

Evaluation

Activity 1: FARM EXCURSION

Keypoint: Farms are local places where people work to produce goods. Some places / activities on farms can be unsafe and children and families take particular measures to ensure safety.

Arrange an excursion to a local farm and ask the farmer to “show & tell” about the following aspects:

- Activities involved as part of farm work
- Safe places and rules for children on farms
- Roles of different family members

Children can:

- Complete the excursion activity sheet.*
- Write a paragraph to explain what they liked about the visit and what they learned.

Activity 2: FAMILY ROLES AND RESPONSIBILITIES

Keypoint: Family members carry out different activities at home and work (incl. work on farms). Some family members have greater levels of responsibility than others, depending on age and ability. This impacts upon what children of different ages can and can't do on farms.

Discuss the activities and responsibilities of parents and older vs. younger children.

Children can:

- Make a table and list the jobs / activities of different members of their family.
- Draw a picture of themselves with the heading: “I am responsible for....”. List the activities that they are responsible for in their own families (eg. feeding pet, tidying room etc.)
- Suggest reasons why age might influence what children can do at home / on a farm.

Class discussion

Analysis

Draw a picture

Application

Scenario

Evaluation

Discuss the following scenario:

“Imagine you are allowed to go with your dad in the ute to feed some stock up the paddock. Your three year old sister wants to go to, but Dad says she can't.” Children can discuss:

- Possible reasons why dad might not want to take her as well.
- What dad might say. What would you say?
- Who should have the “most say” about safety on the farm? Why?

Local farmer to host Excursion

Activity sheet 3.1.1

TOPIC 2: RAIN, HAIL AND SHINE

Focus: Activities on the farm are affected by rainfall and seasonal cycles. Children look at some of the activities carried out during different seasons on a farm. Children describe how plants and animals need water to live and grow and the types of water supplies found on farms. The nature of water bodies on farms is explored and children examine ways of staying safe around these. The importance of rainfall for rural properties is introduced and children have the opportunity to make their own rain gauges and rainfall charts.

Teaching Strategies	ACTIVITIES	Resources
<p>Class discussion <i>Knowledge and understanding</i></p> <p>Activity sheet</p> <p><i>Application</i></p>	<p>Activity 1: SEASONS ON FARMS</p> <p><i>Keypoint: Seasons affect the cycle of activities carried out on many farms. Farm families perform different activities in each season to assist plants and animals to grow and keep healthy.</i></p> <p>Discuss the characteristics of different seasons and how this can affect the activities carried out by different people in different jobs. Children can:</p> <ul style="list-style-type: none"> • Complete the activity sheet relating to the seasons and farm activities. • Discuss and compare the activities of family members on farms in their own area at different times of the year. • Draw a diagram to represent the seasons and list activities carried out during different times of the year on farms / rural properties in the local area. 	<p><i>Activity sheet*</i></p>
<p>Class discussion <i>Knowledge and understanding</i></p> <p>Activity sheets</p> <p><i>Analysis</i></p> <p><i>Synthesis</i></p>	<p>Activity 2: WATER ON RURAL PROPERTIES</p> <p><i>Keypoint: Water is needed on farms for crops, pasture, drinking water for stock. Rainfall affects farm activities and what is produced. Rainfall information helps farmers plan activities.</i></p> <p>Discuss what is produced locally on rural properties and ways water is used to support it. Children can:</p> <ul style="list-style-type: none"> • Bring in photos or 'samples' of local farm produce • Complete the activity sheet* to show how plants and animals need water to live and grow <p>Discuss ways farmers use and store water on farms (eg. for watering stock, crops, irrigation; found in creeks, dams, tanks, dips, channels, wells). Children can:</p> <ul style="list-style-type: none"> • Draw one of these and label characteristics that can make it unsafe (eg. steep, muddy banks) • Suggest ways families can prevent children from drowning on farms (eg. safe play areas, adult supervision, hold hands of toddlers, check depth & current, learn to swim, CPR). • Find out the average yearly rainfall in your area. What does this measurement mean? What time of the year does the rain mainly fall? What activities on farms might this influence? 	<p><i>Activity sheet*</i></p>
<p>Rain-gauge design & testing</p> <p><i>Analysis</i></p> <p><i>Synthesis</i></p> <p>Rain chart</p> <p><i>Application</i></p>	<p>Activity 3: MEASURING RAIN</p> <p><i>Keypoint: Rainfall information can be used on farms to help make decisions about what to grow, when to plant, sow, buy / sell stock etc. Rainfall is measured using a rain gauge.</i></p> <p>Children are encouraged to bring in rain gauges from their own property for display and:</p> <ul style="list-style-type: none"> • Discuss the similarities and differences in design / shape • Test to see if they measure the same amounts of water and explain what the measurement means • Design and make rain gauges from plastic bottles with a scale on the side. Test each to find out the most accurate one compared to a standard rain gauge. • Set up the rain gauge in the school grounds. Draw up a class rainfall chart and record rainfall for a period of time. • Suggest what decisions on the farm this information can be used for (eg. in selecting the right plants to grow in an area, in a particular month / year) • Find out what other information people use in selecting the right plants for their farm / rural property (eg. sun, soil, temperature, slope, cost). 	<p><i>Rain-gauges for display</i></p> <p><i>Plastic bottles, scissors, markers, rulers etc.</i></p>

TOPIC 3: IDENTIFYING FARM HAZARDS

Overview: Children identify characteristics of a range of farm features that can be hazardous to children and describe potentially hazardous situations. Children work together in groups to conduct further research on particular types of farm hazards and collate their research to present a group hazard chart.

Teaching Strategies

ACTIVITIES

Resources

Review / link with farm excursion

Knowledge and understanding

Analysis

Activity 1: FARM HAZARD OVERVIEW

Places where people live, work and play can influence health (eg. safety on farms). There are places and features on farms that can be unsafe for children.

Review the activity sheet from Topic 1, relating to the activities children do on the farm visited. Explain the terms hazard, injury and risk. Children can:

- Name and list hazards / unsafe places on rural properties for children (ie. places they are not allowed to go / activities they are not allowed to do due to risk of injury). Suggest why these are hazardous.
- Sort these hazards / unsafe places into categories (vehicles and machines, water, animals, other hazards)
- List activities that are fun, but with which precautions need to be taken (eg. riding, swimming). What are some of these precautions and why do they need to be taken?

Activity 2: FARM HAZARD PROJECT

There are particular types of hazards on farms that have similar characteristics. Children can work together to find out more about particular hazards, features that make them unsafe and what they have in common.

Group research

Children can work in groups to research one type of farm hazards from the categories above. Each student chooses one example from this category to contribute to the group project:

- Illustrate and label the hazard (eg. photos, magazines / newspaper, draw)
- Describe what it is used for on the farm (eg. ploughing, transport)
- List characteristics of the item that can be hazardous (ie. cause injury). eg:
 - *Machine: eg. a tractor - speed, moving parts, heavy, loud, blind spots*
 - *Water: eg. a dam - deep, murky, muddy sides, currents*
 - *Animal: eg. a horse - hoofs, teeth, big, heavy, unpredictable*
 - *Other hazards: eg. a chemical: poisonous, burns skin*
- Describe possible situations where an injury could occur with this item on a farm / rural property....egs.

Knowledge and understanding

Analysis

- *Vehicles / machines: child passengers falling off tractors, toddlers being run over by trucks, older children falling off ag-bikes, hands in moving parts*
- *Animals: mother protecting young, riding / leading a horse, animal is sick / injured or afraid when herding, milking etc.*
- *Water: child swimming alone, trying to rescue a friend, diving into shallow water, swimming near snags, slipping on mud or rocks into the water, playing in tanks*
- *Other hazards: playing with chemicals, in silos, on machinery*

Group Presentation

Synthesis

- Write a summary about the characteristics of this group and the injuries that can occur.
- Each group presents and reports on the chart/booklet to the class.

Cardboard | cut | paste | colouring materials

TOPIC 4: RESPONDING TO INJURY

Overview: Children map some of the consequences of injuries and develop background understanding of the need for safety interventions explored in following topics. Basic assessment and responses to minor vs. major injuries are introduced through farm-based examples. First-aid techniques are demonstrated and children practice these for common minor injuries.

Teaching Strategies	ACTIVITIES	Resources
<p>Newspaper report</p> <p><i>Knowledge and understanding</i></p> <p><i>Analysis</i></p> <p><i>Synthesis</i></p>	<p>Activity 1: CONSEQUENCES OF INJURY</p> <p><i>Keypoint: Injury can have serious consequences for both the person injured and their family. It is better to prevent injuries than to treat them after they occur.</i></p> <p>Discuss some of the impacts of an injury, using an example of a broken leg (eg. hospital, time off school, time off work for carers, lost income, stress on families, longterm disability).</p> <p>Read the newspaper clipping on the textsheet about an injury that has occurred on a farm.* Children can:</p> <ul style="list-style-type: none"> • Share important elements of the story and discuss any thoughts, reactions to it. • Identify the hazard and the type of injury in the situation. • Find out what the personal consequences of this injury might have been? • Draw a “chain of consequence” for this incident for the boy and his family (eg. What disabilities / difficulties might the person have. Who would take care of them. How farm work and income might suffer. What this could mean). • Write a follow-up article to this story in your own words, Include information on the consequences of the injury and how it has effected his life and that of his family. 	<p><i>News report* textsheet</i></p>
<p>Farm injury scenarios</p> <p><i>Analysis</i></p> <p><i>Evaluation</i></p> <p><i>Synthesis</i></p>	<p>Activity 2: FARM INJURY RESPONSES</p> <p><i>Keypoint: Children can determine if an injured person needs emergency help or not. The same steps can be taken in different situations.</i></p> <p>Divide the class into groups and give each group a scenario of different types of injuries* (ie. farm vehicles, machinery, animals, water, others). Children can:</p> <ul style="list-style-type: none"> • Assess the situation – what happened, who was involved, where, when, how (contributing factors) • Discuss possible responses from a set of choices ...(eg. 1. look out for danger, 2. decide if you need help, (if yes, then...1. get help (how, who), ...if no, then...basic first aid etc.) • Choose a course of action giving reasons why it is the best response • Each group presents their scenario and responses to the class • Complete the activity sheet on basic responses to an injury on farm/at home 	<p><i>Farm injury scenarios*</i></p> <p><i>Activity sheet 3.4.1</i></p>
<p>First-aid demonstration</p> <p><i>Knowledge and understanding</i></p> <p>Practice skills / role play</p> <p><i>Application</i></p>	<p>Activity 3: FIRST-AID SKILLS</p> <p><i>Keypoint: Children can develop and practice basic first aid skills for a variety of minor injury situations. When unsure, children should always get help.</i></p> <p>Display a first-aid kit and the items inside. Discuss what each item might be used for. Demonstrate basic first-aid techniques for:</p> <ul style="list-style-type: none"> • A minor cut - bleed • A painful / swollen joint / limb • A minor burn / scald • Someone tells you to go for help • Someone is not answering you (not responding) <p>Discuss and describe instances where such injuries might occur at home / on a farm. Children can:</p> <ul style="list-style-type: none"> • Practice / role play basic first aid techniques in pairs for the above situations • Suggest places where first-aid kits could be located / used 	

TOPIC 5: FARM EMERGENCIES

Overview: Children identify and respond to emergency situations. Children develop interviewing skills to gather information from a relevant “authority” and use this as the basis of a “news-style” report. Parents can assist children to develop an emergency plan and identify key contacts for children in the event of an emergency at home / on their farm.

Teaching Strategies

ACTIVITIES

Resources

Creating an “interview schedule”

Knowledge and understanding

Activity 1: PREPARING FOR INTERVIEW

Keypoint: Children can find out about actions in different kinds of emergency through interviewing an ‘expert’ in the field. Children can determine their own learning goals.

Invite and brief a guest speaker from one of the emergency services, police, ambulance, SES or fire service, doctor or community health / emergency department nurse to speak to the class about home / farm injuries. The week before the guest speaker / visitor arrives, guide children in:

- Determining what they would like to learn from the speaker about farm / home emergencies (eg. what is an emergency, examples, what to do).
- Devise a set of questions children would like to ask the speaker (eg. about their job, some rescue or treatment stories etc.) Supplement the children’s ideas where necessary to include basics on:
 - *What makes a situation an emergency (eg. the need to get help);*
 - *Who could help (eg. neighbours, relatives, emergency services)*
 - *How we could contact them*
- Create a table with a heading “Interview with -----” with the questions written in one column and a space for answers on the right.
- Children determine who will ask the pre-formed questions on their interview schedule

Activity 2: INTERVIEWING A GUEST SPEAKER

Keypoint: Children can ask questions and seek help from emergency workers, in class or in a real emergency. Knowing how to get help in an emergency saves valuable time and reduce the effects of injury.

Arrange for the guest speaker to attend the class, with a brief on the nature of the questions. Children can:

- Interview the speaker, starting with the prepared questions. In particular, find out what information children need to give over the phone to get help
- If time allows, ask any other questions in response to what the speaker has said.
- Thank the speaker and complete the interview sheet
- Discuss the interview as a class or in small groups
- Write an “article” or report about the interview using the interview sheets. Include:
 - *who the visitor was and their role*
 - *particularly interesting / important points the speaker made*
 - *what the class learnt about emergencies and about the interviewing process*
- Select a report to include in the school newsletter

Invite guest speaker and provide set of questions

Gathering information – by “interview”

Knowledge and understanding

Analysis

Presenting information – ...an article

Synthesis

Continued from previous page.

Teaching Strategies	ACTIVITIES	Resources
<p>Make an emergency contact sheet</p> <p><i>Application</i> Role Plays</p>	<p>Activity 3: EMERGENCY CONTACTS AND PLANS</p> <p><i>Keypoint: An emergency plan with checklists and a contact sheet is one way families can be prepared for an emergency. Families can use information provided as a guide and work through this together.</i></p> <p>Discuss the need to know who to contact in an emergency. With the help of their parents, children can:</p> <ul style="list-style-type: none"> • Complete the emergency phone contact sheet* (see AS 2.5.3) or make their own for display near the phone. Cut it out and put it on a card/cover to make it last and attach it with a string/blutack • Role-play telephoning for help in an emergency. (Explain that the other person at the end of the phone will tell them what to do next) 	
<p>Develop an emergency plan</p> <p><i>Application</i> <i>Evaluation</i></p>	<p>Display an example of an emergency plan (eg. the school's) which includes a map of buildings and evacuation assembly points. With the help of parents and using the information provided, children can:</p> <ul style="list-style-type: none"> • Share ideas about what is/should be on an emergency plan • Complete the emergency plan and checklist activity sheet* for different types of home / farm emergency for their home (eg. an injury, fire, intruder) • Take home the activity and discuss with parents. Discuss emergency actions at your home and whether an emergency plan is needed. • In groups, compare and discuss: <ul style="list-style-type: none"> • <i>family reactions to the activity</i> • <i>whether an emergency plan is useful or not</i> 	<p><i>School emergency plan</i></p> <p>Activity sheet 3.5.1</p>

TOPIC 6: SAFE PLACES AND DESIGN

Overview: Children build on an understanding of farm hazards (Topic 3) to identify ways the family can improve unsafe situations to prevent injuries. Children focus on two strategies – that of creating safer places by removing / reducing access to farm hazards and making hazards less dangerous through design features.

Teaching Strategies

ACTIVITIES

Resources

Develop signs

Knowledge and understanding

Design a fence

Application

Write a poem

Synthesis

Activity 1: SAFE PLAY AREAS

Keypoint: *There are a number of ways to prevent injuries. Safe play areas on farms can be made by removing hazards from a particular area where children can play. Fencing the area helps to prevent toddlers wandering off unsupervised and marks a boundary between play and work areas.*

Write up the first of a set of safety headings “Safe places”. Discuss the meaning of the phrase and describe the features of safe play areas in the pamphlet provided. Children can:

- Design and draw a plan of a fence for a safe play area on your farm | home that will prevent toddlers wandering off unsupervised. Label important features.
- Write a poem or jingle for little kids to tell them how staying in a safe play area can keep them safe on the farm. Make a class booklet of these and read them to an early primary class.

Safe play area pamphlet*

Activity 2: SAFER DESIGN

Keypoint: *Many features and machines on farms are needed to operate the farm and can not be removed. These can be made safer by designing guards and features that prevent injury.*

Write up the second heading “Safer design” and discuss its meaning.

Display the photos* that show machines with safety design features (ie. cabined tractors, ROPS, guards on workshop machines, PTO covers). Discuss how these features help to keep adults safe when doing farm jobs. Children can:

- Complete the activity sheet on safer design features for farm hazards*
- Give an opinion on the following:
 - Do you think it is a good idea to make machines as safe as possible? Why do you think some people leave safety guards off machines or not worry about making machines safer?
 - Is it easier to just rely on rules? What happens if people don't follow the rules?

*Farm machines on CD slides**

Activity sheet 3.6.1

Activity sheet

Knowledge and understanding

Evaluation

TOPIC 7: SAFE BEHAVIOURS AND GEAR

Overview: Children explore ways safe behaviour such as rules, supervision and learning help to prevent injuries. Children learn about key safety rules for farms and develop their own set of safety rules as part of a group. Reactions to rules which limit play and recreational activities are explored and differences in rules for family members are investigated. Children are given the opportunity to develop a safety charter with their parents for their own home / farm. The role of safety gear in preventing injury is described. A range of personal protective equipment used on farms is examined, with emphasis given to the use of helmets for riding activities.

Teaching Strategies	ACTIVITIES	Resources
<p>Safety sign discussion</p> <p><i>Knowledge and understanding</i></p> <p>Fridge magnet</p> <p><i>Analysis</i></p> <p>Short story</p> <p><i>Synthesis</i></p>	<p>Activity 1: SAFE BEHAVIOURS</p> <p><i>Keypoint: Safety rules, instruction and supervision are ways of behaving that help to prevent injuries. Key safety behaviours for the main hazards on farms / rural properties for children are identified. There are good reasons behind safety rules</i></p> <p>Write up the third safety heading “Safe behaviours”. Children can:</p> <ul style="list-style-type: none"> • Discuss the meaning of the phrase and give examples. • Suggest reasons for having rules on roads, at home, in school.....Why is there a particular need for rules on farms?... (Eg. many hazards present, farm is a workplace and a home, so children are more likely to come into contact with hazards) <p>Provide copies of the fridge magnet design with key child safety on farms messages. Children can:</p> <p>Explain how the rules listed will help to prevent an injury.</p> <p>Define the term “supervision” and suggest reasons why it is especially important that adults supervise young children.</p> <ul style="list-style-type: none"> • Imagine a world without rules. Write a short story “..the day there were no rules” 	<p><i>Fridge magnet design on CD</i></p>
<p>Activity sheet - safety rules</p> <p><i>Knowledge and understanding</i></p> <p>Write a poem</p> <p><i>Synthesis</i></p> <p>Role play</p> <p><i>Application</i></p> <p>Safety charter</p> <p><i>Application</i></p>	<p>Activity 2: DEVELOPING SAFETY RULES</p> <p><i>Keypoint: Children can participate in developing safety rules. Rules should be based on knowledge and experience of hazards, risks and safety measures that work. Rules need to be easy to remember and consistently reinforced, but are not necessarily the same for all family members..</i></p> <p>Discuss and list characteristics of good rules ad good rule making. In small groups, children can:</p> <ul style="list-style-type: none"> • Imagine they are a family who have decided to sit down and develop some safety rules for visitors to their farm / rural property. Complete the activity sheet*. • Write a poem about the way they feel when rules stop them doing what they would like to do. Share what can sometimes help them feel better about certain rules. <p>Discuss examples and reasons why there are different rules for different family members. In small groups, children can:</p> <ul style="list-style-type: none"> • Role play or describe helpful and unhelpful ways of dealing with one of the following situations: <ul style="list-style-type: none"> • You are allowed to ride a motorbike but a younger brother / sister isn't • A teenage brother / sister is allowed to learn to use some powertools in the workshed under supervision, but you are not. • A friend wants to ride your horse, but the helmet you always wear doesn't fit. • Provide children with copies of the take home materials for parents*. <p>With the help of parents, create a safety rules charter for your own farm or when visiting a farm.</p>	<p><i>Activity sheet 3.7.1</i></p> <p><i>Child safety take home materials*</i></p>

Continued from previous page.

Teaching Strategies

ACTIVITIES

Resources

Safety sign discussion

Knowledge and understanding

Demonstration personal protective equipment

Knowledge and understanding

Analysis

Activity sheet

Activity 3: SAFER GEAR

Keypoint: *Safety gear such as helmets and protective clothing is used to protect people from injury when doing activities that can be unsafe. Safety gear is often used by adults doing farm activities and helmets are recommended for all riding activities.*

Write up the fourth safety heading "Safety gear".

Children can:

- Discuss the meaning of the phrase and suggest why safety gear might be needed on farms.

Display a range of personal protective equipment (PPE) used on farms and rural properties. (eg. helmets, smooth sole boots, long trousers, shirts, sunscreens of different strengths, hat, earmuffs / plugs, gloves / masks, overalls, sunscreen). Children can:

- Suggest what jobs these might be used for on the farm.
- Make a dummy by stuffing pantyhose with crumples newspaper. Dress the dummy in the safety gear. (Note: Stress the items used only by adults for farm jobs)
- Compare the soles of riding boots and runners (eg. smooth sole, elastic sides). What features of riding boots make them safer to ride in and how? (ie..smooth soles, elastic sides - easily slip off if the rider falls to avoid being dragged along the ground).
- Compare the range of sunscreens on display. Discuss the meaning of the SPF+ rating and the hours each lotion lasts. Discuss when sunscreen should be worn.
- Complete the activity sheet* for personal protective equipment (PPE)

Personal Protective equipment display

Stockings, newspaper

Sunscreen bottles

Activity sheet 3.7.2

TOPIC 8: FARM SAFETY SUMMARY

Overview: Children consolidate safety themes on priority farm safety actions and responsibilities on farms. Children can choose to either design a safety pamphlet, a farm visitors guide or a farm safety game that demonstrates how safer places, safer design, safer practices and safer gear prevent injury. Children can express their ideas on the most effective safety measures.

Teaching Strategies	ACTIVITIES	Resources
<p>Poster / pamphlet</p> <p><i>Synthesis</i></p>	<p>Summary activities:</p> <p><i>Keypoint: The best ways to prevent injury are to use a range of different measures. Safer places and designing safer machines etc. is more reliable than relying on rules and supervision alone, but a mix of strategies is recommended. Adult carers are ultimately responsible for safety, but children can also play a part in keeping themselves and others safe.</i></p> <p>Options for consolidating unit themes are for children to:</p> <ul style="list-style-type: none"> • Design a poster or a pamphlet on the theme of “Safer farms...safer kids”. Base the pamphlet around the topics of Safer Places, Safer Design, Safer Behaviour or Safety Gear. Ask local rural businesses to display the posters in shop windows. 	
<p>Plan / present a farm tour</p> <p><i>Synthesis</i> <i>Application</i></p>	<ul style="list-style-type: none"> • Imagine they have a group of visitors coming to stay on their own farm / rural block. Make a guide that you can use to help orient them that includes: <ul style="list-style-type: none"> • <i>A sketch of the farm</i> • <i>Various locations you will visit on the property.</i> • <i>Hazards to stay clear of and any safe play areas, safe design features, safety rules and gear of interest</i> • <i>General information what the farm produces and activities carried out.</i> 	<p>Art and craft supplies</p>
<p>Farm safety Board game</p> <p><i>Synthesis</i></p>	<ul style="list-style-type: none"> • Make a farm board-game. Steps to include could be: <ul style="list-style-type: none"> • <i>Make a list of features and activities carried out on the farm.</i> • <i>Make a list of safe and unsafe things to do on the farm.</i> • <i>Write these actions on small cards, or type them on a computer with small font, then glue the cards.</i> • <i>Work out a penalty for unsafe actions, such as “go back 3 spaces” and a bonus for safe actions, such as “go ahead 3 spaces”. Put these on the cards as well, or make separate stacks of bonus and penalty cards.</i> • <i>Make a board base with squares and pictures of farm features, putting in a few curly ones, like “creek flooded, miss a turn” or “home early, have another go”. Put the cards face down near the board.</i> • <i>Play the game with a dice or spinner and some counters. Use toy farm animals and machines as tokens</i> 	<p>Art and craft supplies</p>
<p>Discussion / debate</p> <p><i>Evaluation</i></p>	<ul style="list-style-type: none"> • Have a class discussion or debate on one or more of the following topics: <ul style="list-style-type: none"> • <i>What they think are the best ways to prevent children being injured on farms.</i> • <i>Who has responsibility (or most responsibility) for safety on farms / rural.</i> • <i>When is an injury an emergency?</i> 	

TOPIC 1: LOCAL FARM ACTIVITIES (L3.AS1.1)

Name:

Class:

Learning Outcomes: ACT NSW NT QLD SA TAS VIC WA

Tasks and indicators

Achieved

Interprets maps using basic symbols for features

Describe places in the local area and explains their significance

Describes a flow in the provision of a farm product

ACTIVITIES:

1. FARM MAP

Paste/copy a map of the farm visited below. Identify the symbols shown and discuss what they might mean.

Match and draw the symbols next to each label in the key below.

Key:

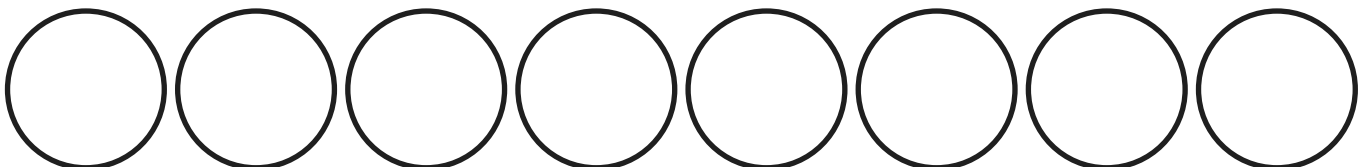

Creek / Dam

Trees

House

Shed

Crops

Animals

Fence

Road

TOPIC 1: LOCAL FARM ACTIVITIES (L3.AS1.1) CONT...

2. FARM REPORT

Write a report about the farm visit. Include in the report information under the following headings:

- Farm activities and production
- Activities of family members
- Safety for children and adults
- What I liked best about the farm visit and why

3. PRODUCTION FLOW CHART

From the information in your report, complete a diagram (flow chart) to show how plant or animal products are produced on the farm. Draw or paste a picture to show each step. Continue on another page if you need to.

The farm we visited produced _____

These are the steps involved

1.



2.



3.



TOPIC 2: RAIN, HAIL AND SHINE (L3.AS2.1)

Name:

Class:

Learning Outcomes: ACT NSW NT QLD SA TAS VIC WA

Tasks and indicators

Achieved

Describes how people's activities fit into a natural cycle

ACTIVITIES:

1. SEASONS AND FARM ACTIVITIES

Draw and label one activity carried out in each season of the year on local farms

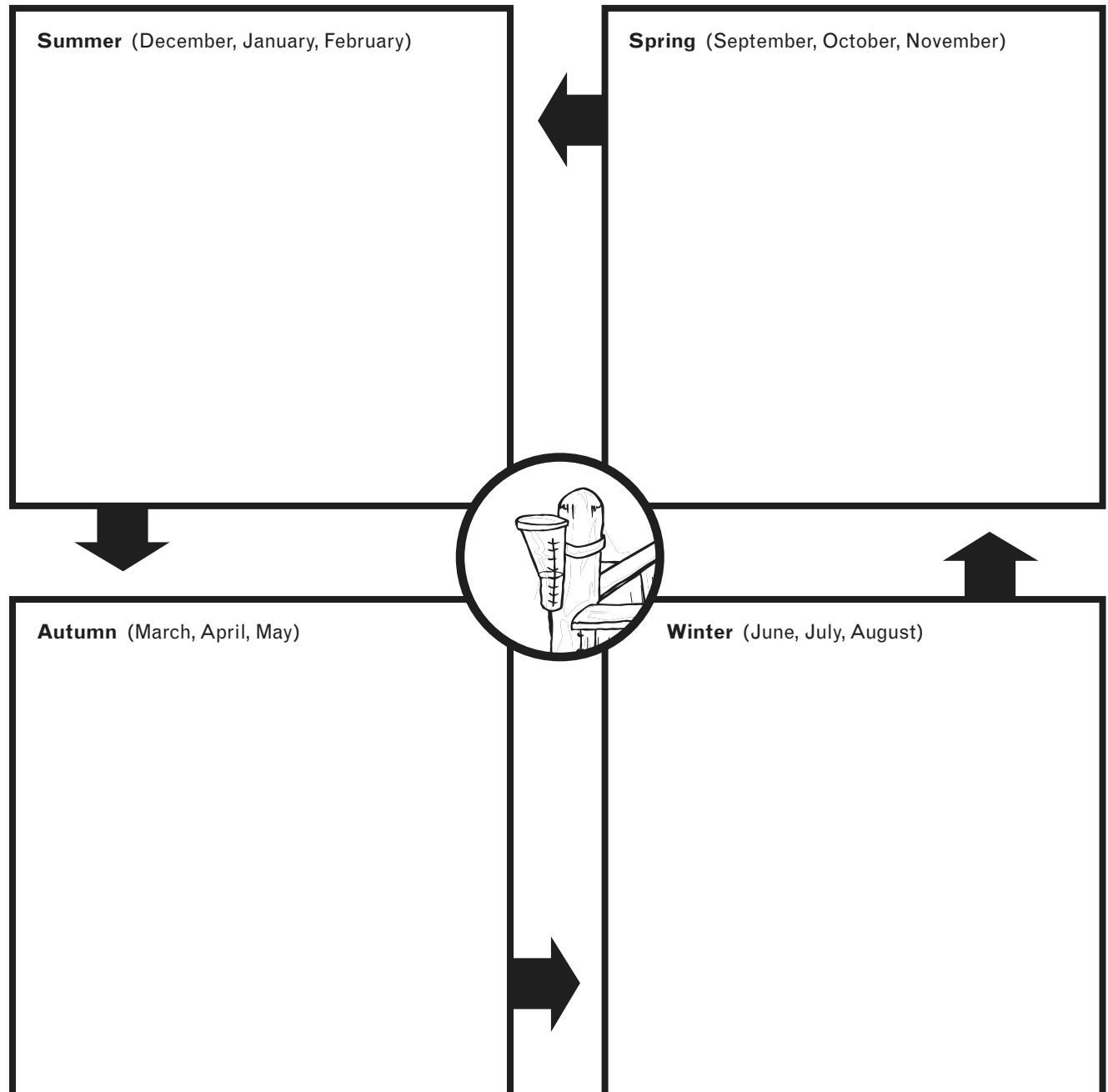

TOPIC 2: RAIN, HAIL AND SHINE (L3.AS2.2)

Name:

Class:

Learning Outcomes: ACT NSW NT QLD SA TAS VIC WA

Tasks and indicators

Achieved

Identifies water flow through a natural system involving plants and animals

ACTIVITIES:

1. WATER FOR PLANTS AND ANIMALS

Water is part of a natural cycle and is needed for all plant and animal life.

Use each letter to mark where each of the steps in the water diagram occur in the farm picture.

a. Water falls as rain from clouds



b. Water soaks into the soil

c. Roots of plants take water from the soil

d. Leaves use the water and sunlight to make plant food

e. Animals eat the plants as food

f. Rainwater runs over the land into creeks and rivers

g. Dams collect water runoff

h. Animals drink from the dam

i. Water from dams and rivers is used to irrigate plants



j. Water 'evaporates' from land, plants and water bodies to form clouds

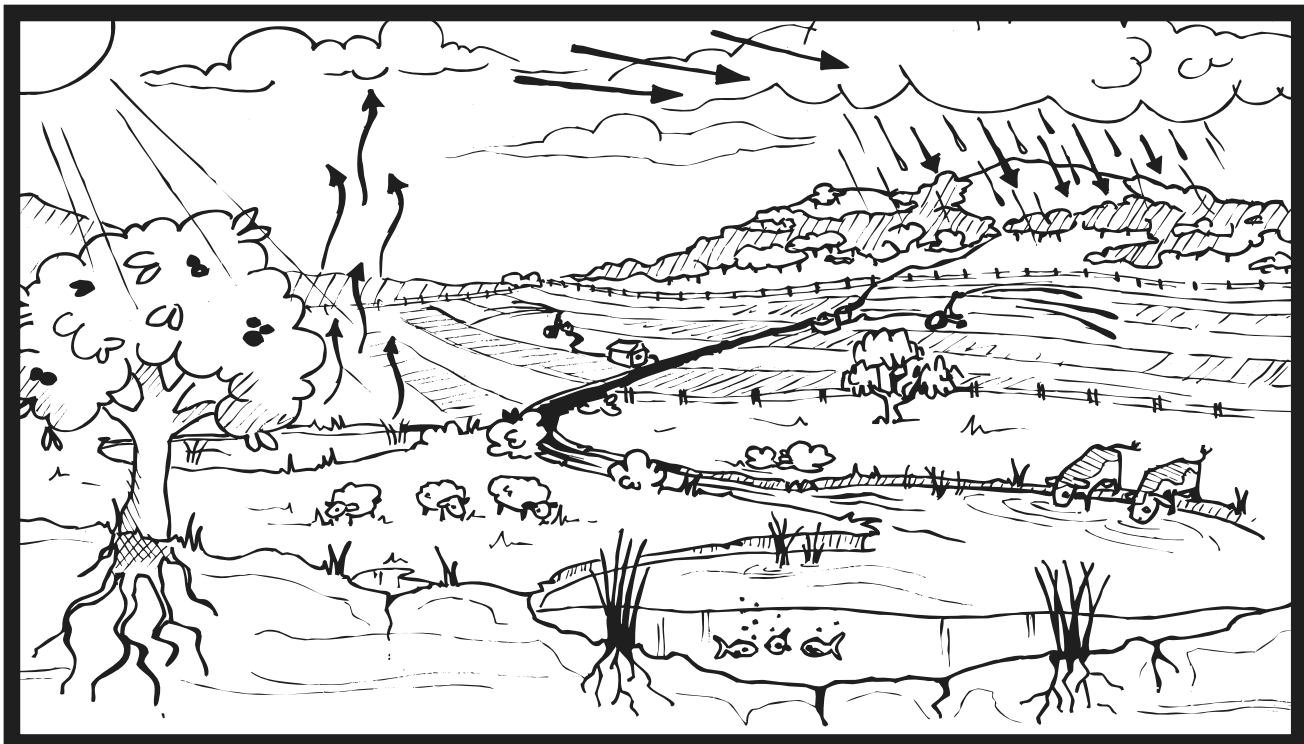

EXPLAIN WHAT WOULD HAPPEN HERE IF IT DIDN'T RAIN FOR A LONG TIME.

Eight serious quad bike accidents over three years

Injured boy, 9, fights for life

A BOY, 9, is fighting for his life in John Hunter Hospital after the quad bike he was riding rolled and landed on top of him at his [REDACTED] property yesterday.

[REDACTED] was found by his father [REDACTED] unconscious and not breathing in a paddock about 6am.

[REDACTED] found the quad bike on top of the boy, moved it off and started CPR.

Ambulance officers were called and paramedics stabilised the boy's condition before he was flown by the Westpac Rescue Helicopter Service to John Hunter Hospital with serious head injuries.

A Hunter New England Health spokeswoman said [REDACTED] was in a serious but stable condition and still unconscious in the intensive care unit.

Police said it appeared the bike had hit a pothole and flipped, but investigations were continuing.

Yesterday's accident was the Hunter's eighth serious accident in three years. Fifty-nine riders have died as a result of quad bike accidents in Australia according to the National Farm Injury Data Centre.

L3 TOPIC 4: RESPONDING TO INJURY (FARM INJURY SCENARIOS)

Farm injury situations are not just a matter of treating broken bones. There are “bruised egos” to deal with too. Many situations that lead to injury can also be avoided. **Discuss responses to one or more of the following situations**

SCENARIO 1:

Geena is 8 yrs old. Geena is grumpy. Geena says to her pet cat.....“Mum won’t let me go swimming in the dam on my own. She says I have to wait until she’s finished her jobs and has time to watch me. But I know how to swim and it’s so hot after school. It’ll take mum forever to finish her jobs and then it’ll be too cold or too dark or something. It’s not fair. I bet my friend Lori can go swimming whenever she likes.”

How would you feel if you were Geena? Why are rules in some families different to others? Do you think Geena’s family rules about swimming in dams are good rules or not? Why? Role play ways Geena and her Mum might work things out

SCENARIO 2:

Geena’s cousin Luke comes to visit. He is 2 years old. Someone leaves the houseyard gate open and Luke runs out while his Mum is busy inside. He runs toward the dam.....

Discuss what you would do in this situation? Which would you do first? Why? Suggest ways this situation could be prevented.

SCENARIO 3:

Harry’s Mum is teaching him to ride a horse. He usually waits for Mum, but today he climbs onto the horse from the fence rail. He has no saddle or bridle and everyone is inside. The horse starts to trot away and Harry falls off. He has grazed his knee and hurt his arm, which is swelling. Harry is scared to move because there are other horses standing around him.

Discuss the things you would do for Harry? How and Why? Describe how Harry’s graze could be treated. How would you treat his arm? What if he hit his head? What ways can people be safe with horses?

SCENARIO 4:

Harry’s parents have explained that the farm ATV is too heavy and powerful for the kids to ride. They say they are not strong enough or quick enough to manage it if something suddenly goes wrong (eg. he hits a rock and flips). Ryan comes over to visit. He says “Let’s go for a spin...I’ve ridden one of these before....” The ATV is in the house yard and the keys are in the ignition...

Describe how you would feel if you were Harry? What might you say to Ryan if you were Harry? What else could Harry’s parents do to keep kids off the farm quad, apart from rely on rules?

SCENARIO 5:

Geena would like to learn how to use the power drill in the shed to make Dad something for his birthday. She has never used the drill, but it looked easy when she saw Dad use it one day. She doesn’t want Dad to know. She sneaks over to the shed to use the drill. Her hand slips and she has hurt it. It is bleeding....

Discuss all the things Geena might be feeling. What would you do if you were Geena ? How should her hand be treated? What are some ways to help prevent injuries to children from farm machines?

TOPIC 4: RESPONDING TO INJURY (L3.AS4.1)

Name:

Class:

Learning Outcomes: ACT NSW NT QLD SA TAS VIC WA

Tasks and indicators

Achieved

Describes personal strategies to respond and deal with an injury

Identifies tools and actions that promote health

ACTIVITIES:

1. INJURY RESPONSES

Geena and her friend Lori have been riding their bikes. Lori skids on a stone and falls on her elbow. It is grazed and starts to bleed.



Help Geena respond to this injury.

1. LOOK for DANGER

Geena looks around to make sure there are no other dangers (eg. charging bull, car reversing) Why?

2. ASK for a RESPONSE.....

Geena looks at Lori and her injury. What might she ask her?

Lori says she is OK, but her arm hurts and she can't move it very well. Lori is upset. Geena thinks about the problem. It seems big, but she doesn't want to upset Lori more. What should Geena DO for Lori?

3. G ____ H _____ and tell Lori what she is doing. Who would YOU go to for this?

4. FIRST AID

Geena's Mum comes to help. She can see it is a problem, but it is not an emergency. Draw and label a picture to show one thing Geena and her Mum did for Lori.

2. FIRST AID KITS

DRAW AND LABEL A PICTURE OF A FIRST AID KIT.



LIST 3 THINGS FOUND IN A FIRST AID KIT. WHAT INJURIES MIGHT THEY BE USED FOR?

1.

Used for:

2.

Used for:

3.

Used for:

Do you have a first aid kit at your home?

If yes, where is it located?

Where else on a farm might it be a good idea to have a first aid kit?

TOPIC 5: FARM EMERGENCIES (L3.AS5.1)

Name:

Class:

Learning Outcomes: ACT NSW NT QLD SA TAS VIC WA

Tasks and indicators

Achieved

Identifies characteristics of emergency situations

Describes strategies to deal with emergency situations

ACTIVITIES:

1. WHAT IF...AN ADULT CAN'T HELP YOU?

Geena and Lori were riding their bikes. Lori fell off and hurt herself. At first, Geena thought it was just her arm, but Lori didn't do up her helmet strap and hit her head on the ground when she fell off. Lori is sleepy and is not answering Geena. (no response). Geena was going to get help from Mum. But Mum has popped into town (no help)



Is this an emergency or not? Why or why not?

Practice with a friend what you would do if you were Geena. Check this with you teacher or parent

TOPIC 6: SAFE PLACES AND DESIGN (L3.AS6.1)

Name:

Class:

Learning Outcomes: ACT NSW NT QLD SA TAS VIC WA

Tasks and indicators

Achieved

Identifies and designs safety features that deal with unsafe situations

Recognises that places where people live, work and play can influence health

ACTIVITIES:

1. SAFETY FEATURES OF TRACTORS

Tractors are common machines used on farms. Tractors are very useful for a range of farm jobs, including ploughing, spraying, fertilizing crops and providing power to other farm attachments. Tractors are large, have fast moving parts and can turn over easily if they become 'unbalanced'. But many farms couldn't operate without a tractor. Some farmers add safety features to the tractor to make it safer. This is an example of safe design

Identify these safety features on the diagrams. Write a sentence to explain how each helps prevent injuries.

Roll Over Protective Structure (ROPS)

Power Take Off (PTO) cover

Seatbelt

Platform steps

Sunshield

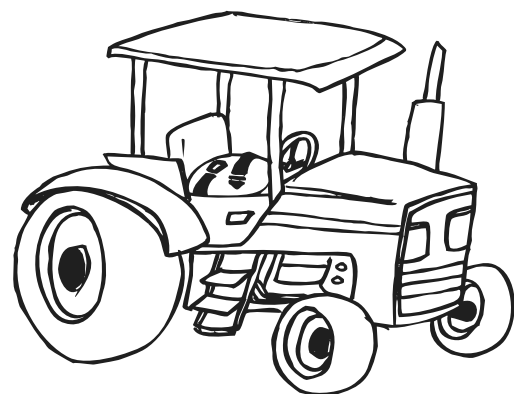
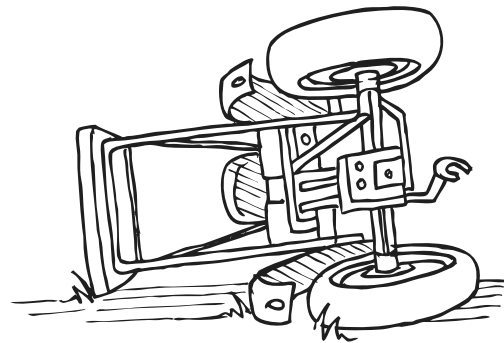
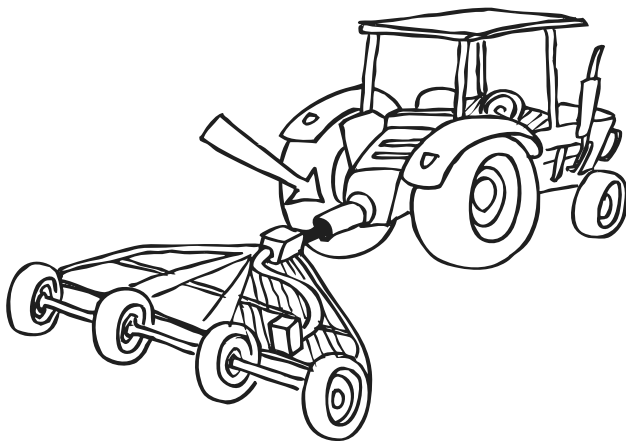

2. DESIGN A FARM GOBBLE- MUNCHER

Design and draw a diagram of FARM GOBBLE MUNCHER.

Include on the GOBBLE MUNCHER fast moving bits and sharp parts.

Describe what a FARM GOBBLE MUNCHER does. Explain how people might be injured using the GOBBLE MUNCHER.

Show safety features of the GOBBLE MUNCHER. Explain how the safety features prevent injury.

TOPIC 7: SAFE BEHAVIOURS AND GEAR (L3.AS7.1)

Name:

Class:

Learning Outcomes: ACT NSW NT QLD SA TAS VIC WA

Tasks and indicators

Achieved

Works out rules of behaviour to improve cooperation and safety

Demonstrates how being a member of a group can affect attitudes and behaviour

Links the right to enjoy recreation activities to the responsibility to care for things

ACTIVITIES:

1. "SAFETY RULES FOR OUR FARM"

We had a "family meeting" in our class group. On "our farm", we have made these safety rules for:

GENERAL PLAY

SWIMMING

RIDING BIKES AND MOTORBIKES:

We care for our bikes by:

RIDING HORSES:

We care for our horses by:

TOPIC 7: SAFE BEHAVIOURS AND GEAR (L3.AS7.2)

Name:

Class:

Learning Outcomes: ACT NSW NT QLD SA TAS VIC WA

Tasks and indicators

Achieved

Identifies ways safe practices can enhance safety and well-being

Uses a range of problem solving skills

ACTIVITIES:

1. SAFETY GEAR CROSSWORD

Find the clues and complete the 'safety gear' crossword.

				1. G						
		2. E				3. B				
								4. H		5. T
				6. G						
		7. P						L		
		8. S			S					S
								T		
9. M		S								
			10. O			R				S



Across:

- In summer, I would be very red-faced without my
- I'm very HANDY and I fit like a
- I am greasy and white, protect skin from sunlight
- Farmers breathe easy, near grain dust and chemicals
- I'm all-over your other clothes. I keep them clean.

Down:

- I only have eyes for you
- Without us, farm work would be a lot more noisy
- I like your foot. I stay there while you ride the horse
- Strap me up – I'm a step AHEAD of you with riding
- Your legs aren't scratched, but mine are patched.

- H _____
- G _____
- S _____
- M _____
- O _____
-
- G _____
- E _____
- B _____
- H _____
- T _____

Give 2 examples of safety gear used at your place. Explain what each is used for and how it prevents injury.



UPPER PRIMARY FOCUS

Upper primary focus

UPPER PRIMARY FOCUS

Learning in upper primary school develops further understanding of resource use on farms and production flows. The importance of water as a resource on farms and the natural and social impacts of drought are explored. Values and beliefs of different groups are examined through investigation of issues surrounding water and resource management on farms. Group membership and the role of the media in influencing opinions is explored. Children assess personal and wider consequences of injury and consolidate knowledge of responses to unsafe situations. Children develop skills in the process of farm hazard identification, risk assessment and control using a range of farm injury prevention measures. Children take responsibility for their own and others' safety by developing a safety plan for their home / farm with the help of their family. Pressures and influences on individuals to take risks are further explored and responses to these pressures developed.

TOPICS

TOPIC 1: **PRODUCTION AND TECHNOLOGY ON FARMS**

TOPIC 2: **WATER FOR LIFE**

TOPIC 3: **RESOURCE ISSUES...**

TOPIC 4: **WHAT HAPPENS WHEN...**

TOPIC 5: **LOOK, THINK, DO...**

TOPIC 6: **PLAN AHEAD....**

TOPIC 7: **ATTITUDES AND RISK**

TOPIC 8: **WHAT WOULD YOU DO?...**

TOPIC 1: PRODUCTION AND TECHNOLOGY ON FARMS

Overview: Children examine the role of farms and rural properties as places where people use resources and technology to create plant and animal products. Flows and chains are used to clarify stages of production on farms in the local area and / or for one primary industry in further detail. The role of technology in production is explored through a research project.

Teaching strategies

ACTIVITIES

Resources

Activity 1: FARMS – PLACES OF PRODUCTION

Keypoint: People work on farms and use resources and technology to produce plant / animal products for sale. Many products used in everyday life originate from farms and undergo stages in the production process before and after they leave the farm.

Defining terms and features

Review the common features of farms. Farms can be home, a workplace, or a combination of these (eg. rural hobby block, working farm without a home, working farm with a home). Children can:

Knowledge and understanding

- Describe what a farm is and give examples of different types of farms.
- Find pictures of farms and farm products and make into a collage.
- Define the following terms and explain / give an example of each in relation to a working farm: Resource, Product, Technology, Primary producer

Share stories

Invite children to share stories about what is produced locally on children's own farms or farms they have visited in the local area. Children can:

Analysis

- List products grown / produced on local farms
- Discuss the stages and activities involved in producing this product whilst on the farm
- Find out about the stages involved in processing after it leaves the farm.

Research assignment on primary production

As necessary, review or introduce the concept of flows and chains. If available display an example of a primary production chain, such as in the "Workboot" series. Children can choose a local primary industry OR research a particular primary industry of interest, focusing on aspects of farm production (eg. use "Workboot" series) and:

Analysis

- Construct a production flow / chain to identify the stages of production on farm
- Describe the activities associated with each stage of production on farm
- Explain stages of processing after the produce leaves the farm.

Activity 2: USE OF TECHNOLOGY ON FARMS

Keypoint: People on farms work with machines and technology to help them with different stages of production. Some machines are designed for farm production (eg. tractors). Other technologies include electronic devices (GPS), computers and communication tools (eg. two-way radios).

Class discussion

Invite children to share about machines and technology used on their farms. Children can:

Knowledge and understanding

- Make a list of all the machines, equipment, processes or devices that are used on local farms.
- Share knowledge about how each one is used to help farm production.

Make a poster

- Make a poster about one machine / device used on farms, as part of a "farm technology" display in the class (eg. tractors, shearing handpieces, milking machines, two-way radios, computers, chemical supplies and delivery systems). On the poster:

Synthesis

- Draw, label and describe features of this technology (or part of it)
- Describe how the farmer uses the technology in the course of his/her work.
- Identify any 'hazards' associated with this machine / system. Describe how these are managed to make use of the equipment safer.

Magazines, newspapers, cut & paste materials

"Workboot" Series

Cardboard, pencils / poster paper / cut & paste materials

TOPIC 2: WATER FOR LIFE

Overview: Features of farm water supplies and water safety implications for children on farms are examined. The importance of water as a resource and the influence of rainfall on land-use patterns is considered. Children investigate the impacts of drought on farm production and rural communities; or the issue of water rights for irrigation. Opportunity is given for children to explore water issues in developing countries.

Teaching Strategies	ACTIVITIES	Resources
<p>Class discussion</p> <p><i>Knowledge and understanding</i></p> <p>Create a factsheet</p> <p><i>Synthesis</i></p>	<p>Activity 1: WATER FEATURES ON FARMS</p> <p><i>Key point: Water is used for different purposes on farms. Farm water bodies have characteristics that can be hazardous for children. Awareness of these can assist people to identify and plan ways to prevent drowning on farms and elsewhere.</i></p> <p>Discuss and compare the ways water is used in households and on farms. Children can:</p> <ul style="list-style-type: none"> List the different sources of water on farms / rural properties. Draw / find pictures of water storage types on farms and label characteristics of these features that could be unsafe for children (eg. creek - fast, flowing water). Explain why these features can be unsafe for children, especially young children Create a factsheet to highlight ways families can prevent children drowning on farms (eg. fenced house yard for young children, separated from water hazards; 'no go' areas; cover old dips; swim only with an adult supervising; check depth, reeds, current before swimming; no diving; wear bright swimmers; learn CPR) 	<p><i>"Drowning factsheet" on CD Farmsafe website</i></p>
<p>Map interpretation</p> <p><i>Knowledge and understanding</i></p> <p>Assignment</p> <p><i>Analysis</i></p>	<p>Activity 2: WATER AFFECTS LAND USE</p> <p><i>Key point: Water is a natural resource and rainfall distribution effects what farms produce. There is a link between rainfall distribution and land-use patterns. Other natural resources include the soil, sunlight, landforms and vegetation.</i></p> <p>Discuss how maps can be used to show differences in climate and rainfall in different areas. Children:</p> <ul style="list-style-type: none"> Complete the map reading activity relating to rainfall and land-use patterns. Find out and explain how rainfall can effect what is produced on farms. Give examples. Describe how one other natural resource can influence what is produced on farms (eg. soil, sunlight, landforms and natural vegetation). <p>(NB: Choose one of the following activities on the following page, based on what is locally relevant)</p>	<p><i>Activity sheet 4.2.1</i></p>

Continued from previous page.

Teaching Strategies	ACTIVITIES	Resources
<p>Activity 3: DROUGHT AFFECTS RURAL COMMUNITIES</p>		
<p><i>Keypoint: Water and rainfall influences what can be produced on farms and the income farm families depend on. Rural areas can be badly affected by droughts.</i></p>		
Class discussion	<p>Children are invited to share their experiences of drought and how this affects activities at home and those involving farm production. Children can:</p>	
Application	<ul style="list-style-type: none"> • Define the meaning of the term 'drought'. Are droughts common in Australia? Locally? • Describe how drought can affect production on farms (and water restrictions in town). 	
Role play	<ul style="list-style-type: none"> • Imagine they have taken out a bank loan to buy a farm. They have to pay the bank several thousand dollars each month to repay the loan. A drought hits the area. 	
Synthesis	<ul style="list-style-type: none"> • List things that may have to be done in order to meet the loan repayments • Role play what they might say to the bank manager about this problem. 	
Flowchart	<p>Discuss how droughts affect rural communities beyond the farm. (eg. reduced incomes of farm families impact on the livelihoods of people in rural towns - local shops, employment, schools, rental housing, people leaving town etc.) Children can:</p>	
Analysis	<ul style="list-style-type: none"> • Create a flowchart to show how drought affects rural communities 	
<p>Activity 4: WATER RIGHTS AND IRRIGATION</p>		
<p><i>Keypoints: Access to water for essential needs (eg. drinking, washing, cooking) is a basic human right. People have different beliefs about the right to use water for other purposes and these views and demands often compete.</i></p>		
Water licences	<p>Display a copy of a "water bill" from the local council. If relevant, display a farm water licence. Discuss the terms and what the figures mean. Children can:</p>	<p>"Water bill"</p>
Knowledge and understanding	<ul style="list-style-type: none"> • Discuss the 'value' of water, in both cost and importance. 	
Evaluation	<ul style="list-style-type: none"> • Suggest reasons why water costs money. Do farmers pay for water? (If they use river or groundwater for production purposes – they need to pay for a water licence) 	
	<ul style="list-style-type: none"> • Complete the water issues role play described on the activity sheet* 	<p>Activity sheet 4.2.2</p>

TOPIC 3: RESOURCE ISSUES

Overview: People on farms manage natural resources in a range of ways. Children discover how local farmers care for the farm environment. The role of media and group membership in shaping opinions is explored. Use of a variety of sources for a more balanced view on issue is encouraged. Children research issues surrounding less popular farming practices and explore the attitudes and values of different groups toward natural resource management.

Teaching Strategies	ACTIVITIES	Resources
<p>Guest speaker <i>Knowledge and understanding</i></p> <p><i>Synthesis</i></p> <p><i>Evaluation</i></p>	<p>Activity 1: “LANDCARE” (or other) SPEAKER</p> <p><i>Key point: Farmers manage natural resources on farms as part of their everyday work. Caring for natural resources on farms is good for farm production.</i></p> <p>Invite a speaker from a local “landcare” group, “conservation farmers” group or agricultural department, to speak about the good, sustainable farm practices many farmers follow, to care for the environment. Children can:</p> <ul style="list-style-type: none"> • Write a report on the visit, that includes: <ul style="list-style-type: none"> • <i>What group the visitor represents</i> • <i>The activities of the group</i> • <i>What natural resources were discussed.</i> • <i>How farmers care for or manage these on farms</i> • <i>Whether you think caring for resources is important or not</i> 	<p><i>Invite and brief guest speaker</i></p>
<p>Media viewpoints <i>Knowledge and understanding</i></p> <p><i>Evaluation</i></p>	<p>Activity 2 : (Optional) MEDIA VIEWPOINTS</p> <p><i>Key Point: People in the community have different points of view about how natural resources are used. These are partly shaped by personal experience, information in the media, and by being part of a particular group. Some sources of information in the media are more ‘balanced’ than others.</i></p> <p>Distribute a copy of the newsclippings textsheet. Children can:</p> <ul style="list-style-type: none"> • Read and discuss the newspaper clippings provided (or find another more locally relevant one) • Write a summary to describe the stance of each group. • Debate whether news reports on TV, radio and the newspaper sometimes present information from one viewpoint only. Suggest how this might affect people’s opinions. • Provide their own opinion. Is it based on the information from the articles or other information or experience? • Share ideas with the class. How many different ideas are there? • Write a summary of ways you could make sure you have a ‘balanced view’ on an issue 	<p><i>Newspaper clippings*</i></p>

Continued from previous page.

Teaching Strategies

ACTIVITIES

Resources

Research a resource issue
Knowledge and understanding

Activity 3: FARM ISSUES AND INTEREST GROUPS

Keypoint: *Some ways of managing resources on farms have been criticised in the media by different groups. These groups have different interests and points of view based on information, experience and attitudes.*

Some farm management practices have come under criticism by different interest groups. Discuss the interests/beliefs of some the following groups: animal activists, environmentalists, conservationists, "greenies", "rednecks", "cowboys", consumer groups. Children can:

- Choose one of the following issues and find out more about it:
 - *Chickens in cages (battery hens) for egg-laying*
 - *'Mulesing' of sheep to prevent blowfly strike*
 - *Live export of sheep on ships to the middle east*
 - *Clearing land of trees and native vegetation*
 - *Planting genetically modified crops*
 - *Practices leading to soil salinity*

Include in the research:

- A picture that shows / represents the issue
- Describe what the practice involves and the reasons behind it.
- Explain why those who oppose the practice are against it
- Give their opinion on the issue

Present the research as either:

- A poster to contribute to a classroom "Farm issues wall" OR
- An article with a catchy news title
- Compile the stories and elect an editorial group to arrange them into a "Farm issues newspaper". Run copies for everyone in the class and make copies available to circulate in the school / in the community.

Analysis

Evaluate

Synthesis

Pencils/poster paper / cut & paste materials

Computer, paper

TOPIC 4: KEY SAFETY MESSAGES

Overview: Farms can be both a home and a workplace. Children are exposed to a variety of hazards not present in many homes. Children review these and the personal and wider consequences of injury. Children consolidate knowledge of responses to unsafe situations introduced through earlier years and consider the rationale for recommended safety interventions.

Teaching strategies	ACTIVITIES	Resources
<p>Class discussion</p> <p><i>Knowledge and understanding</i></p> <p>Ideas chart</p> <p><i>Analysis</i></p> <p>Activity sheet</p> <p><i>Analysis</i> <i>Synthesis</i></p>	<p>Activity 1: AT HOME IN A WORKPLACE</p> <p><i>Keypoint: Farms are good places to live, but also can be hazardous. Adults and children can be injured from farm hazards. Injuries on farms can have serious consequences for the person injured, their family and the farm.</i></p> <p>Discuss reasons why farms can be such good places to live and visit. Children can:</p> <ul style="list-style-type: none"> • Define the terms hazard and risk. • Describe work or play activities on farm that might involve some risk of injury. • Think about and list hazards at their own home / farm that can cause an injury. • Group hazards that are similar eg..machines, vehicles, animals, chemicals, water, other hazards. <p>Share stories about incidents of injury they know of (*NB, Be sensitive to recent events or those with close family members). Children can:</p> <ul style="list-style-type: none"> • Discuss the list the types of injury that can happen during work and play activities on farms. • Read and discuss the scenario and complete the activity sheet. 	<p><i>Activity sheet 4.4.1</i></p>
<p>Interpreting safety messages</p> <p><i>Knowledge and understanding</i></p> <p><i>Analysis</i></p> <p>Design a safety promotion poster / advert</p> <p><i>Application</i> <i>Synthesis</i></p>	<p>Activity 2: KEY SAFETY MESSAGES</p> <p><i>Keypoint: The main causes of serious injury to children on farms are water, farm machinery and vehicles, motorbikes and horses. Safety organisations recommend specific safety measures that can prevent the most serious injuries to children on farms.</i></p> <p>Universities and safety organisations conduct research into the main causes of injury to children and develop recommendations based on these.</p> <p>Display and distribute Farmsafe Australia’s checklist and fridge magnet promotional items. In pairs, children can:</p> <ul style="list-style-type: none"> • Identify the main hazards and injury risks to children mentioned in the resources • Identify who they think the target audience is and why • Explain what they think the key safety message/s are • (Extra) Visit a website of one safety organisation that promotes safety for children. Explain what their key messages are. <p>If available display the “Horseplay” poster or copy its design from the CD for distribution. Children can:</p> <ul style="list-style-type: none"> • Describe strategies the artist has used to get their message across (eg. colour, illustrations and simple phrases to get their message across). Who is the target group? • Identify the key messages and most important points <p>Key messages for farm motorcycle safety include:</p> <p>“Children using farm motorcycles should.....</p> <ul style="list-style-type: none"> • Always wear approved safety helmets • Have instruction on pre-ride safety checks and safe riding techniques • Always have adult supervision • Not ride 4 wheeled motorcycles if under 16 years • Wear gloves, long sleeves, pants and boots <p>Children can:</p> <ul style="list-style-type: none"> • Design a safety notice / poster focusing on one or more of these safety messages. Use colour, pictures and work out an attractive layout. Decide who the target group is and choose language and a format to suit. OR • Create a 15- 30 sec radio advert about children and motorcycle safety on farms, based on the above key messages. Script and record these and vote on the best three to send to the local radio station, with a letter asking them to play it. 	<p><i>CSOF checklist and magnet*</i></p> <p><i>Computer access</i></p> <p><i>“Horseplay” poster* on CD</i></p>

TOPIC 5: LOOK, THINK, DO....

Overview: Children practice identifying farm hazards and assessing risk in the home / farm environment. Ways to prevent injuries are explored using the categories of safer places, design, practices and gear. Opportunity is given to explore these processes for particular farm hazards in further detail. Design features of a range of helmets are examined and children design their own 'multi-purpose' helmet for riding activities.

Teaching strategies

ACTIVITIES

Resources

Simulated safety walk

Knowledge and understanding

Activity 1a: LOOK...

Keypoint: Children can assist their families to identify hazards unique to their home / farm environment.

Provide children with the activity sheet* and explain the steps involved in a safety walk.

Children:

- Look (identify):
 - List the features and places that could cause an injury to children
 - Discuss the types of injury possible (eg. drowning, falls, amputations, head injuries).
 - Suggest how such injuries might happen. (eg. children climb on machinery propped up on blocks, children playing with keys left in ignition, tractor rolls without a roll bar)

Activity 1b: THINK.....

Keypoint: Risk is how likely something unfavourable will happen. Risk of injury is higher if someone is in contact with a hazard more often or the hazard /activity is more dangerous (can cause a more serious injury). People can reduce risk in a variety of ways.

Conduct a class raffle. Make the "prize" having to tidy up the classroom (or such like).

Children:

- Think (of the risk):
 - Suggest ways "risk" is like a raffle with a bad prize. Suggest ways the chance of a "win" might be less random - like a horse race, where ability, training, equipment and environment have an affect.
 - Describe factors that can affect the risk of injury on a farm and how.
 - Categorise the hazards / unsafe activities on the activity sheet from most to least risky.

Activity 1c: DO....

Keypoint: People can reduce risk of injury. There are a variety of strategies to take. These can be categorised as making safer places, safer design, safer practices, and safer gear.

- Do (work out solutions):

As outlined on the activity sheet, brainstorm ways to solve the above hazards/unsafe situations under the following headings

1. Safer places – remove hazards from the area (eg. safe play areas)
2. Safer design – make hazards safer (eg. guards on machines)
3. Safer practices – rules, learning and supervision (eg. rider instruction)
4. Safer gear – helmets and protective clothing (eg. helmets)

Activity sheet 4.5.1

Slips of paper for a raffle

Raffle and discussion

Analysis

Evaluate

TOPIC 5: LOOK, THINK, DO....CONT...

Continued from previous page.

Teaching strategies	ACTIVITIES	Resources
<p>Activity card exercises</p>	<p>Activity 2: ACTIVITY CARD OPTIONS</p> <p><i>Keypoints: There are different types of hazards and control measures on farms that can be explored in greater detail. The principles of hazard identification, assessment and control are the same.</i></p> <p>Children select an Activity card to further investigate and apply thinking skills in identifying, assessing and controlling the risk of injury to children on farms*</p>	<p>Activity cards*</p>
<p>Application</p> <p>Helmet display and design</p> <p>Analysis</p> <p>Synthesis</p> <p>Evaluate</p>	<p>Activity 3: HELMET DISPLAY AND DESIGN</p> <p><i>Keypoints: Helmets are an important safety measure for riding activities – such as riding horses, motorbikes and bicycles. Design features of helmets are different according to the activity.</i></p> <p>Display bicycle and motorbike helmets with the equestrian helmet. Children can:</p> <ul style="list-style-type: none"> • List the similarities and differences between the helmets. • Relate these and compare to the similarities, differences and requirements of each riding activity. • Design a multi-purpose helmet for horse riding, motorbike riding and cycling that combines features needed for each one, such as: <ul style="list-style-type: none"> • strong material to absorb impacts from falls • light and cool for cycling • peak to brush away leaves, twigs for horse riding • covering much of the head and face for motorbike riding • giving sun protection to face and ears • Compare and decide upon the best design, giving reasons. Would this design be practical, useful, effective? Write a letter to a helmet manufacturer with this design and ask them whether such a helmet could be made. 	<p>Helmets for display</p>

TOPIC 6: PLAN AHEAD....

Overview: Children further develop skills in farm hazard identification, risk assessment and control by conducting a mock safety walk / hazard hunt. Children apply these principles to promote their own and others' safety by developing a safety plan for their own home / farm, that includes a review of emergency procedures.

Teaching strategies

ACTIVITIES

Resources

Hazard hunt

Knowledge and understanding

Analysis

Activity 1: "HAZARD HUNT"

Keypoint: *Planning for safety aims to prevent injuries occurring. The first step involves identifying the most important hazards / unsafe activities and then deciding on the best ways to make them safer.*

Review the principle of a 'safety walk' used in Topic 5.

Imagine the school grounds are a farm. Conduct a mock 'safety walk', or a 'hazard hunt'.

Divide the class into two teams. Each team will develop hazards/clues for a different type of farm:

- Choose 6-8 hazards or risky activities for children common on this type of farm. Develop a sign or picture to represent each hazard / activity and place these around the school grounds. Make up a set of clues to lead the other team to find and identify the hazards.
- Search and identify the other team's hazards / unsafe activities, by interpreting the clues.
- In a table, list these hazards / activities in order according to how severe an injury could be from it and how often children are exposed to it. Decide on the most important hazards / activities based on these criteria.
- Discuss some of the ways already suggested through the unit that could prevent injury.

Action plan

Synthesis

Display the example* and explain the idea of an action plan, which states the goals and actions taken for safety. Children can:

- Use the information in the table as the basis for developing a child safety action plan for the farm/s in the "hazard hunt".*

Example of an action plan (textsheat)*

Homework assignment

Application

Synthesis

Activity 2: OUR HOME / FARM SAFETY PLAN

Key point: *A home / farm safety plan uses information gathered by identifying and assessing safety risks and puts it in the form of an 'action plan'. Children can be involved in this process.*

With the help of their parents, children conduct a safety walk of their own home / farm and use it as the basis of a safety action plan. In each area at home / on the farm, children can:

- Move from area to area, starting from inside the home.
- Look for any features that may cause a serious injury to children (incl. visitors). Think of any hazardous activities that might occur there. (Use the checklist for some ideas).
- Draw a map of your home / farm and use a key to mark/label where these occur.
- Weigh up and decide on the most important hazards / activities for children, based on how severe an injury might be and how often children are near / do it. List these in the table from most risky to least risky*.
- For the first 3 listed, suggest a number of ways to prevent injury for each hazard / activity under headings for the main safety categories. (Repeat for the rest if time permits).
- Use information in the table to complete the "Home / farm safety action plan" on sheet provided*.
- Some people think home / farm safety action plans aren't really necessary. Why do you think some people might feel this way and give your opinion on whether a safety action plan is worth doing or not.

Activity sheet 4.6.1

Evaluation

Continued from previous page.

Teaching strategies	ACTIVITIES	Resources
---------------------	------------	-----------

Review emergency procedures

Knowledge and understanding

Emergency plan
Synthesis

Role play

Activity 3: EMERGENCY PROCEDURES

Key point: Safety action plans need to include information on who to contact in the event of an emergency and the range of possible emergencies at home/ on farm.

Discuss possible home / farm emergencies and the need to know who to contact to get help. (Review Level 3 Topic 5). With the help of their parents, children can:

- Make an emergency phone contact sheet to display near the phone at home.
- Develop an emergency plan* which includes the map of the farm / house, with evacuation assembly points labelled and brief checklists of what to do in the event of different types of home/farm emergency (eg. an injury, fire, intruder).
- Role-play telephoning for help in an emergency. (Explain that the other person at the end of the phone will tell them what to do next).

Activity sheet 4.6.2

TOPIC 7: ATTITUDES AND RISKS

Overview: Attitudes to safety can be influenced by many things, including personal experience of injury, beliefs and a perception of risk. Children research these and consider arguments for better safety practices in response to the opinion of others. Pressures on individuals to take risks are further explored in relation to activities on the farm and responses to these pressures developed.

Teaching strategies

ACTIVITIES

Resources

Research activity

Knowledge and understanding

Analysis

Evaluation

Activity 1: WHAT AFFECTS SAFETY ATTITUDES?

Keypoints: *People have different points of view about safety. Some have good intentions, but don't get around to doing something about it. Some think the risk is very low, so they don't worry about it. Attitudes can depend on many things, including experiences and beliefs.*

Beliefs and experience can affect what people do about safety at home / on the farm. Explain the steps involved in conducting a research questionnaire or survey and illustrate an example of a "Lickert-style" question. Children can:

- Develop a survey of 5-10 questions about child safety at home / on farm. Include questions about the most important safety measures covered so far in the unit. **OR**
- Alternatively, reform the key messages on the "fridge magnet"* into questions.
- Conduct the survey with class mates, another class or family members
- At the bottom of the survey, ask the following questions:
 - *Have you or someone close to you ever had an injury at home/on farm serious enough that they needed to go to hospital? If so, did any safety measures change?*
 - *Do you believe injuries to children on farms are common?*
 - *Do you think safety can always be improved on farms or are most farms safe enough?*
- Compare and graph the results. Draw conclusions and describe these.
- Discuss the safety behaviours shown by the survey results. Discuss possible reasons people might have different ideas about what is safe. Is there evidence that people think accidents won't happen to them? Is this a realistic attitude? Do all families behave safely all the time on their properties? What main safety measures could most people improve on?
- Write up a class report on the survey findings. Include this in your school newsletter or send a copy home to each family.

*Fridge magnet design from CD**

Continued from previous page...

Teaching strategies	ACTIVITIES	Resources
---------------------	------------	-----------

Develop and present an argument

*Synthesis
Evaluation*

Activity 2: STRONG OPINIONS

Keypoint: People can have strong opinions about safety. Opinions often include personalised language. We can recognise and respect opinions, but also challenge each other with better ways of doing things.

Children can:

- Imagine they got an award for the safest farm in Australia. Someone approaches them after the award ceremony and makes one of the following comments:
 - "If kids just did what they were told they wouldn't get hurt."
 - "Why all this fuss?... it's all just common sense"
 - "Only people who do something stupid get hurt"
 - "It's not my fault if someone gets hurt at my place".
 - "Nobody's been hurt at my place yet, so I don't need to worry about it."

Choose one of the statements. As a safety champion, describe what they would say to the person in response. Develop an argument using ideas covered in this unit. Include a scenario to illustrate why their idea might not always be true, but remember to respect the other person's opinion. Share ideas with the class.

Activity 3: BETTER SAFE THAN SORRY

Keypoint: Children can sometimes feel pressured to do something they would like to do but are unsure about. It can help to recognise such struggles and when unsure, choose the safer option.

Situational analysis

*Application
Evaluation*

In pairs, children think of an example in a farm / home situation where someone is being pressured to do something they would like to do are not sure about or aren't normally allowed to do.

- Describe the situation on a slip of paper
- Hand these in, then pass them out again so that each pair gets someone else's scenario.
- In this situation, discuss:
 - *How you would feel about the situation*
 - *What would you do / what you would say in the situation.*
- Share your thoughts with the rest of the class.

Slips of paper

TOPIC 8: WHAT WOULD YOU DO?....

Overview: Children consolidate understanding of farm safety themes introduced through the unit by developing a game with hazards, risks and safety solutions for a variety of situations. Children engage in an interactive story to reinforce the need for safe choices and responsibility for the safety of others in the farm environment.

Teaching strategies

ACTIVITIES

Resources

Develop a game

Synthesis

Activity 1: FARM SAFETY GAME

Keypoint: Knowledge and understanding of farm hazards, risks and safety solutions can be integrated to develop a game.

In small groups, children can design a farm safety board / card game. Ideas might include:

- A farm map with a number of hazards and a trail to negotiate safely
- Penalty squares / points or cards with injury scenarios described.
- "What would you do if" squares / cards with a multiple choice safe answer.
- Bonus points, moves to reward those who take safe measures.

Children can play their own and each others games or take home to play with siblings.

Cardboard,
cut | paste,
art supplies

Interactive story

Evaluation

Activity 2: MARVIN THE MARTIAN VISITS THE FARM

Keypoint: Children can recognise when safety decisions need to be made and choose the best options in a range of situations based on previous understanding of farm safety.

Children go on an imaginary journey with Marvin who knows nothing about farms or farm safety. In small groups, children can:

- Read the story of Marvin the Martian.
- At the places indicated in the text, stop and discuss the questions and options given.
- Continue and find out their outcome.
- Construct a different ending to the story.

Short story textsheet:
"Marvin the Martian
visits the farm"

Synthesis

TOPIC 2: WATER FOR LIFE (L4.AS2.1)

Name:

Class:

Learning Outcomes: ACT NSW NT QLD SA TAS VIC WA

Tasks and indicators

Achieved

Uses maps to locate and compare resource use in different areas

Identifies how natural factors such as rainfall can affect production and land-use

Describes how plants, animals and people respond to changes in a natural system

ACTIVITIES:

RAINFALL AND LANDUSE

Maps can help us to see where wetter and drier areas of Australia are. Rainfall is one natural factor that will influence how people use the land and what farmers produce. Examine the map provided and complete the exercises.

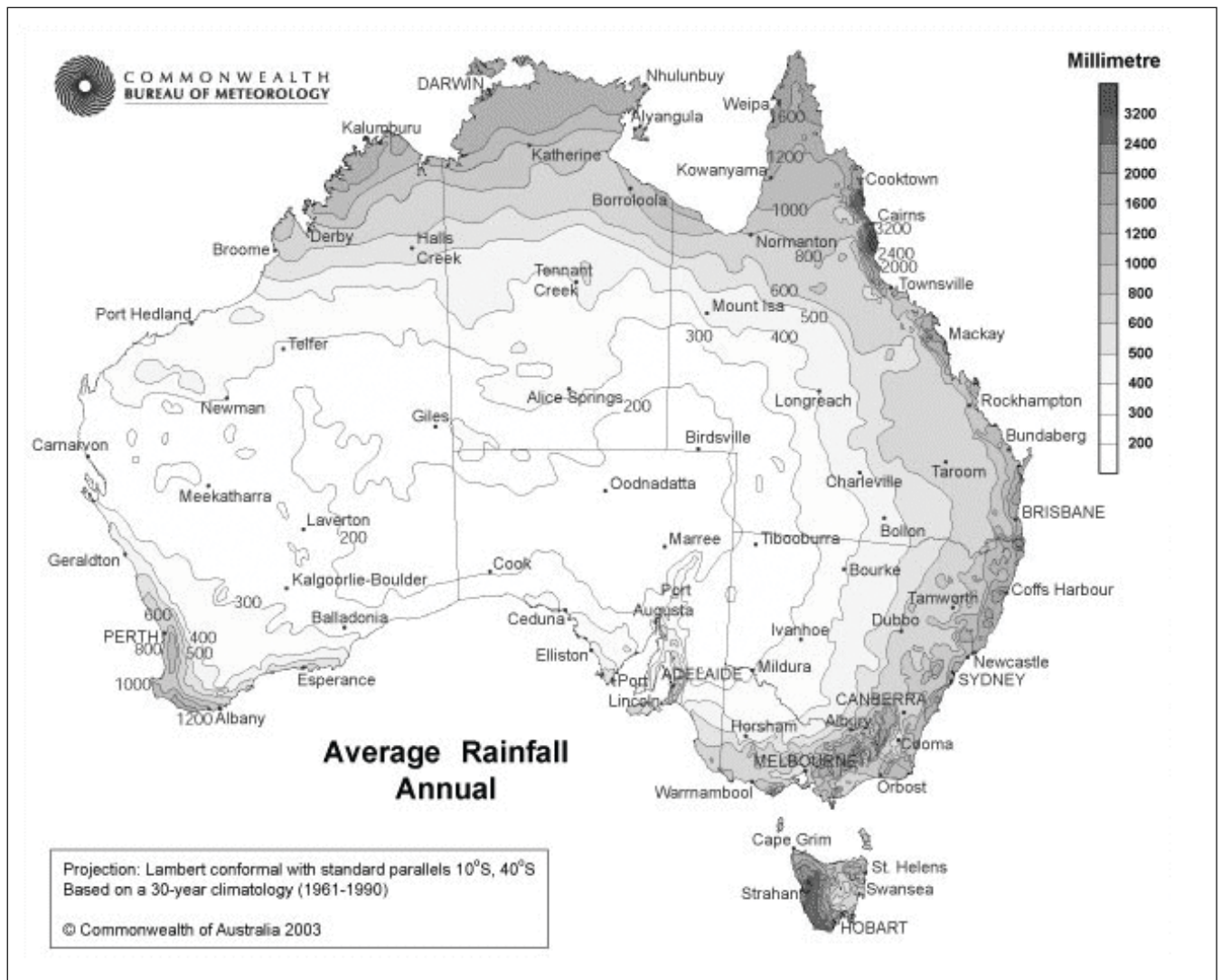

TOPIC 2: WATER FOR LIFE (L4.AS2.1) CONT...

WHAT DOES THE TERM "AVERAGE ANNUAL RAINFALL" MEAN?

Draw up a table with these headings.

Town	Average Rainfall	Main production and Landuse

Locate and list the names of five country towns on the map. For each town on the map, use the "legend" to find out the average yearly rainfall. Write this in the table.

Mark in the location of your town with an X. What is the average yearly rainfall around your town? Does this mean you always get this amount of rain each year? Add your town's details to the table

Is your town wetter or drier than your state capital city?

Describe where the wetter areas of Australia are located (darker shade).

Describe where the driest areas are (lightly shaded)

- Find out what the land is mainly used for around these towns. Write this in your table.
- Does this mean all land in the area is used for that purpose?
- What is the land mainly used for in the wettest areas?
- What is the land mainly used for in the driest areas?
- Do you think rainfall can effect landuse? Why or why not?
- What other climate and landform features can influence how land is used?

TOPIC 2: WATER FOR LIFE (L4.AS2.2)

Name:

Class:

Learning Outcomes: ACT NSW NT QLD SA TAS VIC WA

Tasks and indicators

Achieved

Describes how values and experiences can influence people's use of places

Identifies factors that affect resource use and development by different groups

Demonstrates how different roles affect relationships, attitudes and behaviours

ACTIVITIES:

1. WATER WARS

Imagine you saw the following notice in the local newspaper...

"A public meeting is to be held at 7.30 tonight, to discuss water issues in our area. Our local politicians will be there to listen to your concerns. Come along and have your say ..."

Find out what the "points of view" of these people might be.

Group 1

Pastoralists (sheep or cattle farmers) who live downstream from a cotton or rice growing area, which uses water from the river for irrigation. They have less water than they used to and times are harder when a drought comes. Some 'environmentalists' are also in this group. How might members of this mixed group of people feel?

Group 2

Dairy farmers, cotton, or ricegrowers, (choose), who have paid for water rights and have spent a lot of money developing their land for irrigation. They are afraid these water rights might be taken away and they may go out of business. How would they feel?

Role play what members of each group might say at the meeting. Have speakers and someone to run the meeting and keep it in order. Questions to consider:

- Should water be free to use, no matter what it is used for?
- Should people who use water for agriculture, pay more for it?
- What should happen in a drought when there is not enough water for everyone's needs? Who should lose out?
- Should the government stop people taking water out of rivers? Is this fair if people have already paid for a water rights and set up an irrigation system?
- Write a report on the role play. Include a summary of the different points of view given by the two groups and your opinions on the above questions.
- Suggest ways the community can make sure water users, the environment and people downstream get a fair share of the water according to their needs.

(Extension ideas):

- Conduct a small survey of people in your area to ask: What do you think water is worth?
- Look up an overseas development agency on the internet (eg. World Vision, Caritas).

Find out where access to clean drinking water is a real problem for some people.

Is clean drinking water a basic human right? How can people in richer countries help out?

National water plan starts to deliver

The NSW Farmers' Association has welcomed a joint Federal and State Government announcement to provide up to \$110 million in financial assistance for farming communities to adjust to the pain of reductions in groundwater use.

Announced by Prime Minister John Howard and Premier Bob Carr, the Association says the joint funding commitment is a good start to help protect the social and economic well-being of farming communities that rely on groundwater for irrigation.

Chair of the Association's Conservation and Resource Management Committee, Rob Anderson says with interim groundwater plans set to commence on the 1 July this year, this announcement will go a long way to providing irrigators with investment and production certainty.

"This assistance will help allow groundwater irrigators to invest in water-saving technology, reduce existing debt levels, source water in the marketplace, and/or help farmers to diversify into other farming enterprises.

"For irrigators in the Upper and Lower Namoi, Lower Gwydir, Lower Macquarie, Lower Lachlan, Lower Murrumbidgee and Lower Murray groundwater systems, this will be a big step forward.

"The next step will be to ensure that this money goes directly to affected groundwater irrigators and not eroded away by government taxes.

"This financial package is not a handout. It is about farmers being provided assistance when losing a capital asset - that asset being a water licence".

Mr Anderson says any reduction in water licences should be treated by governments as a reduction in a capital asset, with no income tax applied to assistance payments.

Whilst the Australian Government will provide a capped \$55 million through its \$2 billion Australian Water Fund and the NSW Government will also provide \$55 million towards this package, groundwater licence holders have been asked to make a significant contribution of \$50 million.

"In the light of the worst drought in 100 years, expecting farming communities to contribute up to \$50 million to the groundwater assistance package is totally unrealistic.

"We look forward to working with the government to ensure this package provides the right outcomes to farmers and the environment," Mr Anderson concluded.

The Association thanks the former Deputy Prime Minister, John Anderson, and the NSW Minister for Natural Resources, Craig Knowles, who have both been working hard on this issue for several years.

Finding a better way

■ Researchers from the University of New England have joined with a key irrigation body to find more sustainable ways to irrigate farmland.

The University of New England has joined a key Co-operative Research Centre for Irrigation Futures (CRCIF) to find more sustainable ways of irrigating farmland.

The CRCIF now has a total of 13 core partners - including six universities - which have committed more than \$50 million to the CRCIF over the next seven years.

Of particular interest to the CRCIF are skills developed at UNE's Centre for Ecological Economics and Water Policy Research (CEEWPR), whose staff Dr John Wolfenden, said "a main project at the centre was to overcome many irrigators' resistance to more sustainable water use.

Over the years, the CEEWPR has played a key role in river restoration, flood management and sustainable transport infrastructures. In recent months, water and its uses has been very much in the public eye

The drought has really emphasised some of the problems of water resource use in Australia, but there are also longer term issues to do with sustainable water use."



it's time to
**clean
out**
your rural and
household
chemical clutter
the right way

AND the first 20 towns
are...

chemical collection

Northern Inland Regional Waste (NIRW) is working with the Department of Environment & Conservation (NSW) and your local council to provide drop off centres for old and leftover chemicals around the farm and home.

Drop off centres have been organised throughout the New England & North West region in the following towns:

Armidale
Barraba

In brief

New green group launched

TENTERFIELD has launched an environment group that has an evidence, choice and technology based approach.

The Australian Environmental Foundation (AEF) says it wants to bring a balanced, community conscious approach to green issues.

The AEF's first campaign aims to put evidence back into environmental education, "rather than just accepting the sometimes false ideology that is often taught in schools today".

The AEF's future campaigns include "proper" National Parks and Reserves management and good control of feral animals and weeds.

New fight against weeds

LANTANA, boneseed, rubber vine, alligator weed and willows are some of the weeds that will be targeted under the new Defeating the Weed Menace Program.

The Federal Government will invest \$1.82 million into 25 projects that will help manage and control a number of Australia's most significant weeds.

PETA visit concern

THE WoolProducers body is in "disbelief" that animal rights group PETA could soon visit Australia with the backing of the Australian Woolgrowers Association (AWGA).

PETA will reportedly be assessing Australian woolgrowers' animal rights performance.

"The concept of animal rights activists, particularly the radical group PETA, having any input into how sheep are cared for is totally unacceptable," WoolProducers chairman Robert Pietsch said.

Mulesing workshops

CONTRACTORS and farmers will be able to get up to speed with the latest mulesing techniques in workshops during the next few months.

The Livestock Contractors Association and the Kondinin Group will run the workshops in every state.

The program will cover hygiene, shear setting and shear sharpening and will focus on the most efficient and humane techniques.

TOPIC 4: KEY SAFETY MESSAGES (L4.AS4.1)

Name:

Class:

Learning Outcomes:

ACT NSW NT QLD SA TAS VIC WA

Tasks and indicators

Achieved

Demonstrates how different roles affect relationships, attitudes and behaviours

Identifies some of the consequences of injury and unsafe behaviours

Analyses various rules and codes of behaviour

ACTIVITIES:

1. INJURY SCENARIO

Harry (6 years) went to visit his neighbour Joe (12 years). Joe said - **"Come and have a ride on my Dad's quad"** (ATV, 4 wheel motorcycle). Harry was a bit unsure, but he thought... Joe is older than me and he should know what's right... Harry went for a ride as a passenger on the back of the quad. The quad hit a rock in the long grass and flipped over. Harry was not wearing a helmet. He hit his head on the ground and was pinned under the quadrunner. Joe was OK and went to get help.



Identify the stages in this story that resulted in Harry's injury. Place them in the flow chart. **What happened?**

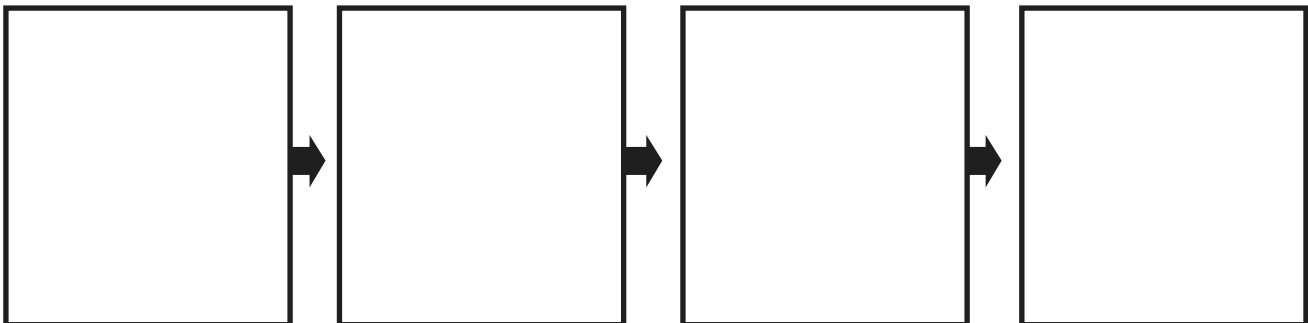

TOPIC 4: KEY SAFETY MESSAGES (L4.AS4.1) CONT...

Harry may have suffered a brain injury. Describe possible consequences of a brain injury for:

Harry

Harry's family

Harry's family has different safety rules than Joe's.

On Harry's own farm, his Dad follows the bike manual's safety instructions which say:

- No passengers on ATV's
- No child riders under 16 years

Harry knows the rules at his place, but he was influenced by Joe. He wasn't sure of what to do.

If you were Harry, what would you have said to Joe?

What should Joe have done before asking Harry to get on the quad?

Discuss reasons why families might have different safety rules.

Describe ways the story could have changed at each stage

Research: Find out about 'brain injury' and create a factsheet about it. Include on you factsheet:

- Common causes brain injury and examples of situations on farms
- Some consequences of serious brain injury
- How someone with a serious brain injury manages daily activities. **OR**
- Write you own ending to this story (1-2 pages), explaining what happened to Harry. Share your "ending" with the class.

TOPIC 5: LOOK, THINK, DO (L4.AS5.1)

Name:

Class:

Learning Outcomes: ACT NSW NT QLD SA TAS VIC WA

Tasks and indicators

Achieved

Uses problem solving skills to address farm injury risks

Identifies and assesses options for responding to unsafe situations

ACTIVITIES:

1.a LOOK...FOR HAZARDS AND UNSAFE PRACTICES.

Imagine you are Harry or Geena. Go on a 'safety walk' on the farm pictured on the folder cover or cd.

- Use the "Child safety on farms checklist" to help identify farm hazards and unsafe practices.
- Answer yes/no to the questions as you 'walk' and 'look'. Think about other possible hazards not listed or shown on the checklist, but that you are aware of.
- Based on your answers, make a list in your workbook of the hazards/ unsafe practices on Geena and Harry's farm.

1.b THINK...ABOUT THE RISK OF INJURY

Risk of injury will depend on how often someone does an unsafe activity and how badly hurt they might be. For example, if you run across a busy highway 20 times a day, there is a greater chance you will be runover, than someone who is three times your size and crosses the highway once/week.

Draw up a table like the one below with these headings. Complete the table below by adding the 'hazards/unsafe practices' from 1.a and describing how often and how severe an injury could be.

Hazard / unsafe practice	How often are children involved with this (eg. daily, weekly, monthly)	How serious is the injury (eg. causes death, serous illness visit to Doctor, time off school)

Based on the table, work out the most risky hazard or practice. Order your hazards 1 to.....

1.c DO...

Take the most risky hazard / practice and describe ways to reduce injury risk on Harry and Geena's farm. Suggest these under these headings:

- Safer places
- Safer design
- Safer practices
- Safer gear

Take the next hazard/practice do the same until you have made the farm a safer place to live and play.

TOPIC 5: FARM MACHINES AND VEHICLES (L4 ACTIVITY CARDS)

TRACTORS

Tractors play an important part on many farms, but they can be the cause of death or serious injury to adults and children on farms.

Hazards:

- Size, weight, loudness and fast moving / spinning parts.
- “High centre of gravity” which means they can sometimes rollover.

Risks:

Find out what these terms mean and how they can cause serious injury

- Tractor rollovers
- Power take-off injuries
- Tractor runovers

Safety actions:

There are different ways to reduce risk of injury from tractors and machines. These include creating safer places separated from machines (eg. safe play areas), or designing machines with safety features. People can also learn safe ways of operating machines through supervised training and following safety rules.

What is a R.O.P.S? Describe how it reduces the risk of a tractor rollover?

What is a P.T.O guard and what kinds of injury can it prevent?

Look at the picture top right. The shaded area shows the area protected by the roll-over protection structure. Why might it be unsafe safe a child to ride as a passenger like this?

It is hard for a driver or operator of a tractor to hear a child coming or see them playing near a working farm machine. Describe three ways to prevent people, especially children, from being runover by tractors and other machines.

Safety design features on tractors

There are features on some tractors which can help to reduce risk of injury. Find out about these safety features and label them on the diagram.

- Roll Over Protection Structure to protect operator if the tractor rolls over
- Seatbelt to keep operator within ROPS protection zone
- Weights to keep tractor more stable when pulling
- Skid resistant platform steps and pedals to prevent slips and falls
- Sunshield to reduce skin cancer risk
- Shield for fan and alternator to protect hands
- PTO cover to prevent clothing being caught and limbs being amputated
- Hazard warning decals to inform operators and others of dangers

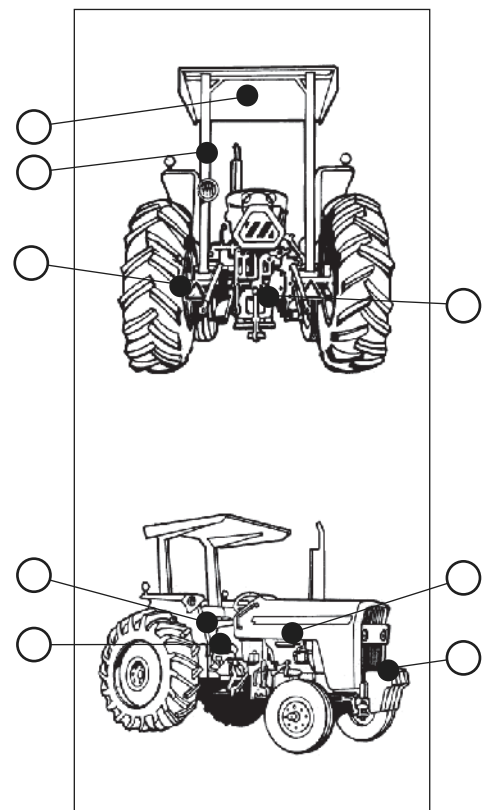
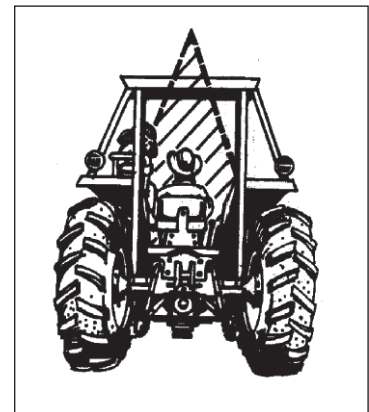

FARM BIKES

Fun, useful, but also a hazard

There are different types of farm bikes. Push-bikes, mountain bikes, two wheeled motorbikes and 4 wheel motorbikes (ATV's). In particular, ATV's are heavy and large and can crush the rider under them when they flip over.

Risks:

Motorbikes are the most common cause of injury for boys age 5-15 years on farms. Why?

Safety actions:

Many manufacturers have safety decals on their ATV's which warn people not to take passengers or let children on their machines. Design your own safety decal to represent the need for people to be training in riding motorcycle riding skills. All motorbike riders need training, supervision and good protective gear, especially a helmet. Some people don't like wearing helmets because they say they are too hot.

Find out the characteristics a helmet needs to meet the Australian Standards. Based on these, design a helmet that could be used in hot climates. Draw and diagram of a motorbike helmet and label its special features.

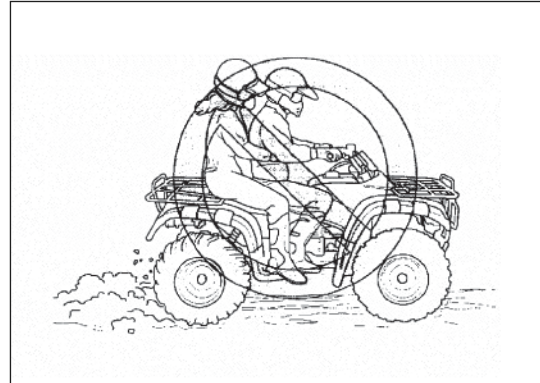

Figures: Future Farmers. A Rural Health & safety resource for high school students. 2001. Workcover NSW and ACAHS 2001

TOPIC 5: HORSES, WATER (L4 ACTIVITY CARDS) CONT...

HORSES

Hazards

"Everyone loves horses. How can you call a horse a hazard?" How would you answer this question?

Risks

Girls aged 10-15 years are at higher risk of injury from horses than boys of the same age. Discuss reasons for this injury fact. Develop arguments for and against the statement: **"Boys are better riders than girls"**

Safety actions:

Obtain an equestrian helmet, elastic sided riding boots, saddle, bridle and other items, with some safety information for a horse safety display. Demonstrate the different safety features of the gear.

Examine the poster with the slogan **"No helmet, no boots, no way"**. Make up a jingle based on the safety messages on the poster. Script a **"community service announcement"** around the jingle, promoting horse safety in a way that is particularly appealing to girls. Record it and ask the local radio station to play it.

WATER

Hazards

Review and list the range of water hazards found on farms and the features of each. Which water hazards are found in your area?

Risks

Toddlers are the most at risk of drowning on farms. Suggest 3 or more reasons why this is so. How high is this risk?

Discuss reasons there may be different water safety rules for different family members. Give reasons and practice explaining this in a role play to a younger brother/sister.

Safety Actions

Fenced safe play areas, close supervision and family rules help keep toddlers safe. But toddlers are also the ones least likely to understand or follow rules. So why bother with rules?

Find out if pool fences are required on farms by the council in your area.

Divide into groups and develop an arguments for and against these views, giving reasons.

- Fencing the pool will not prevent drowning on farms
- Safe play areas are only as safe as the person who shuts the gate.
- If everyone learnt to swim, there would be no problem

Discuss the steps involved in rescuing someone in trouble in the water.

Role play the best ways of doing this without placing yourself in danger.

TOPIC 6: PLAN AHEAD (L4.AS6.1)

Name:

Class:

Learning Outcomes: ACT NSW NT QLD SA TAS VIC WA

Tasks and indicators

Achieved

Plans a course of action based on assessment of information

Takes responsibility for their own safety and that of others

ACTIVITIES:

1. PLANNING FOR ACTION

On our safety walk we:

1. Identified hazards and unsafe practices with the help the CSOF checklist.

2. For each hazard, we thought of ways to prevent injuries

This is an example of what we did:

Example Hazard: Dam

How could an injury occur?

The dam has steep, muddy sides and deep water. Toddlers and young children could wander away, fall in the dam and drown.

Assess:

(how often, how serious, how old/experienced)

Often - go past it everyday – next to house

Serious - could drown and die

How old - big problem for toddlers who are little and don't understand rules much

Risk rating **HIGH** MEDIUM LOW

Safer places

create a fenced house yard with child resistant latches (better idea)

Safer design

no ideas

Safer practices

make dam 'out-of bounds' for children
hold onto toddlers hand when near water
always have an adult with children swimming

Safer gear

wear bright swimmers or clothing
wear hat and sunscreen
toddlers to use floaties
have a rope / buoy to throw to swimmers in trouble

3. NOW ITS TIME TO DRAW UP AN ACTION PLAN!

From OUR safety walk, the most important hazard to work on first is:

Based on our ideas, (eg. safer places..etc.) we have decided on this plan:

1. Actions for the most important hazard:

1. _____
2. _____
3. _____

Things we need to help us, things we have to do... When we will start..

2. Actions for the next most important hazard...(repeat steps above).

3. Then we will put our plan into action and see how it works. We might have to change things later.

TOPIC 6: PLAN AHEAD (L4.AS6.2)

Name:

Class:

Learning Outcomes: ACT NSW NT QLD SA TAS VIC WA

Tasks and indicators

Achieved

Uses maps and symbols to represent features of familiar local places

Identifies characteristics of emergency situations

Plans ways to take responsibility for their own and others safety

ACTIVITIES:

1. MAP OF OUR PLACE

Draw a map showing your house, your yard and/or your farm.

Use a key and symbols for important features like outside doors, roads and the “meeting place”. For example, your meeting place might be a tree near front gate. A ☆ might be a symbol for the tree on the map. Draw and label the symbol in the key. Include compass directions (NSEW) on you map.

2. EMERGENCY PLAN

With the help of your parents, complete details below for your own home / farm emergency plan.

Cut out the plan and paste it onto the other side of your map. Cover the page with plastic and place near the phone.

Make sure you can turn over to both sides.

CALL EMERGENCY 000

EXAMPLES OF EMERGENCIES:

OUR MEETING PLACE

For these emergencies, we have this plan:

HOUSE FIRE:

- Call out **HELP - FIRE**, to alert everyone
- Get out of the house, keep low to avoid smoke and leave by the nearest door or window
- Call **000** for **FIRE** on a mobile / neighbours phone
- Don't go back inside the house

SERIOUS INJURY: (eg.)

OTHER EMERGENCIES: (eg.)

L4 TOPIC 6: ACTION PLAN

EXAMPLE OF A SAFETY ACTION PLAN:

We found a number of hazards on our safety walk. We have assessed the risks.

The most important (highest risk) hazard we found: _____

OUR GOAL: To prevent injury from this hazard or behaviour.

Based on our ideas from brainstorming some solutions, (eg. safer places..etc.) we have decided:

1. Actions for _____, the most important hazard:

1. _____

2. _____

3. _____

Things we need to help us:

Things we have to do:

When we will start:

2. Actions for the next most important hazard (repeat steps above). _____

1. _____

2. _____

3. _____

Things we need to help us:

Things we have to do:

When we will start:

3. Then we will put our plan into action and see how it works. We might have to change things later.

MARVIN THE MARTIAN

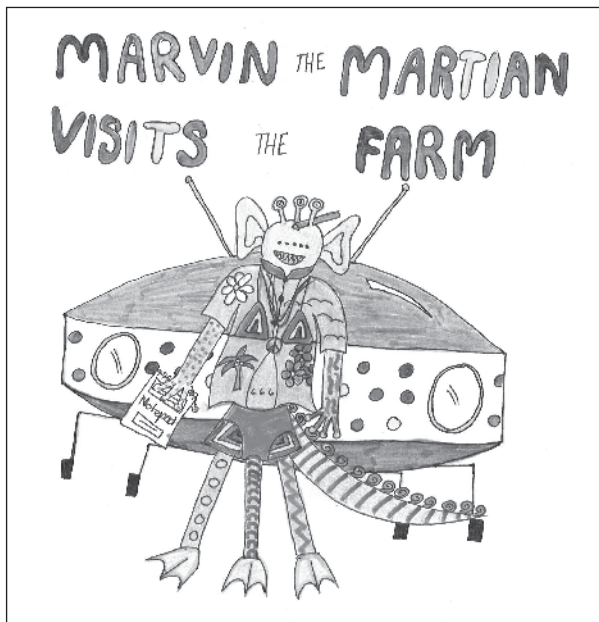

Marvin is one Cool Dude. He comes from MARS.

Marvin is on his first 'assignment' as a travel writer' as a popular Martian magazine. He is writing a feature on FAR AWAY PLACES.

People from MARS have come to Earth before. But they usually go to the cities... because they like the night-life. Martians usually blend in quite well in the city... No one notices them at all.

Marvin wants to get an 'angle' on his story, by visiting a farm too. Marvin is prepared. He bought some Earth clothes on mail order last week, so he would blend right in too...

What do you think? Will Marvin blend in? Does that matter? Why or why not?

Marvin has heard that the best way to get around in a farm or property, is in a ute. So he presses the "Converter" button on his space ship and... ZAP ...a blue and purple two toned spotted ute. Now he's REALLY going to blend in.

Is Marvin's vehicle going to be useful on a farm?

Marvin arrives at... yes...you guessed it. Geena and Harry's farm! (they are so popular, those two).

Marvin walks through the fence of the houseyard, leaving a big hole. They don't need fences and gates on Mars and Marvin doesn't even know what they are for....

Give one or two reasons why they mightn't need fences and gates on MARS.... What is a house yard for?

Marvin knocks on the door and says, "Well, howdy partners..." He heard humans say this on a satellite TV once.... "That must be how they speak on farms," Marvin thought to himself.

Is Marvin right? Do you think Marvin is "getting off on the right foot?" (He has three to choose from)

Harry comes to the door. His jaw nearly drops to the floor. "WOOOOOWWWWWW!!!" says Harry. "Geena, come and get a load of this!"...

What would your reaction be? What would you do if a Martian came to your door? Should they let Marvin inside? Would you?

Marvin is polite and introduces himself. Harry and Geena are polite too. Harry and Geena forget the rule about not letting strangers in. Marvin seems nice and looks so cool!

Marvin tells the children that he wants to find out about "Earth Farms", for his travel article. He wants to know all the tips for visitors... so that MORE visitors like him can come to Earth... FROM MARS!!!!

"What do you want to know? asks Geena. She begins to tell him that not all farms are the same. There are many different kinds of farms. Geena and Harry live on a "wheat / sheep" farm.

What products are produced on this type of farm? What activities might be involved over the year? What are some other kinds of farms?

Marvin asks them all sorts of questions. But Harry thinks it would be easier to just SHOW Marvin. So they go outside to take Marvin for a look around the farm.

Geena thinks to herself...."Ummmm, perhaps we should go and find Mum first" But Harry is already out the door and Geena doesn't want to miss out either.

How would you feel and what would you do?

L4 TOPIC 8: MARVIN THE MARTIAN (SHORT STORY) CONT...

GEENA AND HARRY, HEAD OFF TO SHOW MARVIN THE SIGHTS....

Just as well Marvin has NINE LIVES. He may need every one of them! Finish the story of Geena and Harry and Marvin's adventure. Include in the story:

- Where they went on the farm
- What they did
- Unsafe places and hazards they encountered.
- Safe actions of Geena and Harry...unsafe actions of Marvin... with Marvin being injured - but strangely cured each time, because of Marvin's **SPECIAL MARTIAN POWERS!**

Example...

Harry asked Marvin if he wanted to catch some Yabbies. Harry showed Marvin what a yabbie was and how good he was at catching them.

It was hot and he also wanted to go for a swim. Harry doesn't NORMALLY go to the dam without his Mum or Dad to watch him....but he thinks....Marvin is probably an adult, but it is a bit hard to tell.

Harry jumps into the water. SPLASH.

"Come on in, Marvin."

Marvin jumps in too. But Marvin forgets that on MARS, there IS no water. So he doesn't know how to swim.

"HELP!" Says Marvin in Martian language. Harry and Geena think he has a tummy ache or something.

"HELP!" says Marvin in Earth language. He slowly sinks into the goeey mud under his three feet. Sadly, Marvin drowns.

So that taught Harry to always remember safety rules about swimming in dams. Luckily for Marvin, he has another 8 lives.

(Adela, 12 years)

What is one thing you would like to do, if you had special Martian powers?