

*Aussie Pumps*

# BLASTER BLITZ

# 6

*Aussie Pumps*

WE'RE FOR AUSTRALIA

JULY 2021 Issue 1

FASTER | SMARTER | SAFER



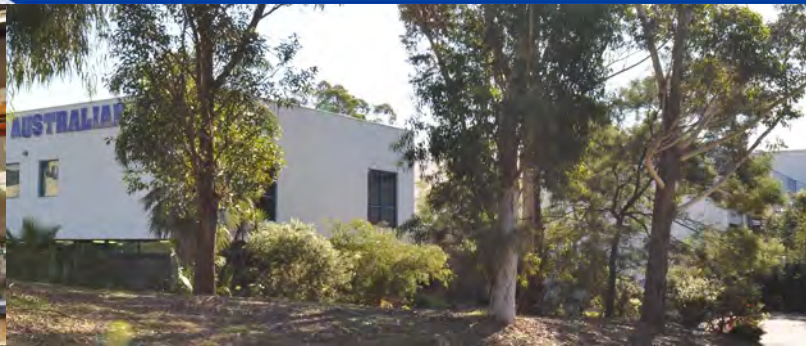
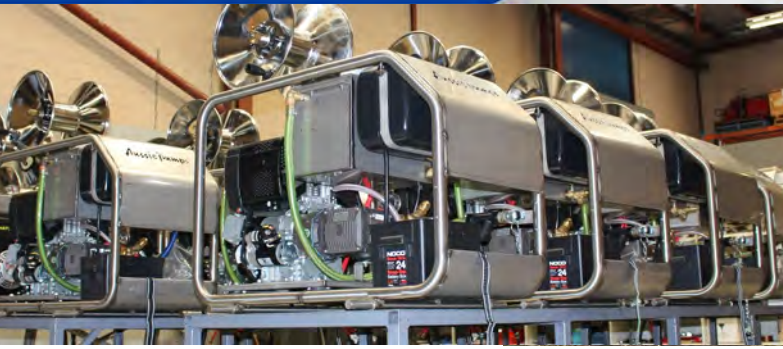

- ◆ Australia's leading manufacturer
- ◆ Production for over 20 years
- ◆ 2 1/2 acre works & HQ
- ◆ Proudly Australian
- ◆ ISO 9001 quality accredited
- ◆ Exporting worldwide



Scan & see the passion that drives our team



Members of Ausjet association



Quality ISO 9001 SAI GLOBAL

## AUSSIE PRO-OPERATOR ... PUTTING YOU FIRST!

- **FREE education program** about the implications for operators under the new AU/NZS 4233.01 Safety Standards
- **NEW advanced design blasters** to 5,000 psi that are **Class A compliant** to give maximum operator efficiency while maintaining the highest safety standards
- **Machines clearly identify** by their safety classification so operators make an informed choice
- **Safety training programs** for distributors, owners & operators on the machine selection, their safe use & maintenance
- **WORK SAFE** operator manuals that lead the industry
- **Comprehensive safety decals** on all machines to protect operators
- **Aussie Safety Protection kits** fitted to all Aussie blasters to protect against pressure spikes
- **A range of PPE** to protect operators of Class B machines to 500 bar (page 80-83)

### AUSTRALIAN MANDATORY SAFETY CLASSIFICATIONS

AS/NZS 4233.1:2013 ... recommended reading for all professional operators

Summarised below ....

#### CLASS A ... under 5,600 bar lpm

(multiply pressure in bar by flow)

Operators must be trained and assessed as competent in the following

- Danger awareness
- Site safety
- Machinery stop controls
- Hose & equipment inspection
- Personal protection equipment



#### CLASS B ... over 5,600 bar lpm

(multiply pressure in bar by flow)

Operators must be RTO trained and certified as competent in the following

- System operation and safety procedures.
- Pressurised water jets and hazards
- Controls and safe operation
- Component compatibility
- Hose inspection, application and fittings
- Nozzle selection and operation
- Personal protection equipment
- Equipment maintenance
- Body positioning during cleaning processes.



**AUSSIE PUMPS PUTS SAFETY FIRST TO ELIMINATE INJURIES & SAVE LIVES**

## COLD WATER BLASTERS

Selection guide ... page 5

 3,000 psi - 4,000 psi Commercial ... P6-7	 2,000 psi - 7,300 psi Industrial Petrol... P8-11	 2,000 psi - 7,300 psi Industrial/Mine Diesel P12-15	 4,300 psi - 7,300 psi Mine Spec ... P16-18	 Hire ready blasters <b>Hire Spec .... P18-21</b>
 PM groups ... P22	 Hydraulic drive... P23	 <b>Jetters... P24-31</b>	 Electric ... P32-36	

## HOT WATER & STEAM CLEANERS

Selection guide ... page 37

 Electric... P38-39	 Engine drive... P41-46	 Skid & trailer... P47-48	 Mine Spec... P49-50	 Clean' n Capture P51-54
---	---	---	--	--

## HIGH PRESSURE ACCESSORIES

from page 55

 Guns, lances & turbos ... P56-59	 Nozzles ... P60-61	 Engines & motors ... P62-63	 Unloaders ... P64	 Thermal Dumps, Safety Valves ... P65
 Couplings & swivels... P66-67	 Injectors, Gauges & filters ... P68	 Hot water boiler parts coils, solenoids, fuel pumps ... P69	 Hose ... P70-71	 Hose Reels ... P72-73
 Flat surface Cleaners ... P74-75	 Telewands & grit blast Kits ... P76	 Foamers, wheels, carts, tanks ... P77	 500 bar ... P78-79	 Safe Operator PPE ... P80

## BERTOLINI & UDOR HIGH PRESSURE PUMPS

from page 83

 Direct drive ... P84-85	 Heavy duty ... P86-87	 350-500 bar ... P88	 Ultra high Pressure ... P89	 High flow/Pressure ... P90
 SS process Pumps ... P91	 Motor Pumps ... P92	 System Requirements .. P93	 Udor diaphragm pumps ... P94	

## HYDROSTATIC TESTERS

from page 95

## WET/DRY VACS

from page 99

 High Pressure ... P96-97	 High flow ... P98	 Industrial wet/dry Vacs ... P99	 Drum Vacs ... P102	 Pressure Cleaner Trouble Shooting Guide ... P105
---	--	--	---	---



## AUSSIE SCUD ... EVOLUTION THROUGH INNOVATION

A 25 YEAR JOURNEY DRIVEN BY OUR PASSION  
TO GIVE CUSTOMERS THE BEST SOLUTIONS



The Aussie revolutionary NEW stainless steel frames .....  
Ergonomic, OH & S friendly, perfectly balanced.

**Our mission** is to produce products for the cleaning industry that excel in terms of performance and efficiency.

**The result** is the world's best machines, proudly built in Australia, for the toughest applications on **construction sites, shipyards** and mines.

Our range extends from compact, portable machines for 'Executive

**Tradies'** through to the **Aussie Mine Boss** extreme series.

We understand that professionals want **reliability, quality** without compromise, at a price that is **real value**.

**Time is your most valuable commodity.** Selecting the right size machine for the job will increase cleaning efficiency, **saving time, water & labour**.

Choose an Aussie ... it's a machine **you'll love** to use!



The past



**NOBODY** wants to take 5 hours when the job can be done in 1½ hours ... Buy the right machine for the job!



### COMMERCIAL PETROL DRIVE

P6-7

**3,000 psi - 4,000 psi Honda direct drive**

Tradies, cleaning contractors, schools, farm use, property maintenance, landscapers



### INDUSTRIAL PETROL DRIVE

P8-9

**3,000 psi - 5,000 psi Class A ... NO CERT REQUIRED Scud & Ultra, gearbox drive**

Cleaning contractors, construction, concrete & paint prep machinery wash-down, graffiti removal, councils



### HYDRO-BLASTERS PETROL DRIVE

P10-11

**5,000 psi—7,200 psi Class B**

Contract cleaning, shipyards, large machinery wash-down, rust removal, surface prep, concrete scoring & hydro-demolition



### INDUSTRIAL/MINE DIESEL DRIVE

P12-14

**3,000 psi - 7,300 psi trolley Class A & B**

Cleaning contractors, construction, large machinery wash-down, mine sites, council workshops



### MINE BOSS EXTREME SERIES

P15-18

**4,300 psi—7,300 psi, flows to 31 lpm, Skids & trailer mounts Class B**

Contract cleaning, shipyards, large machinery wash-down, mine sites



### HIRE SPEC BLASTERS (HOT & COLD)

P19-21

**1,400 psi—5,000 psi Class A ... NO CERT REQUIRED**

Hire ready machines



### PUMP MOTOR GROUPS

P22

'Big Berty' pumps with top quality engines & motors

### HYDRAULIC DRIVE BLASTERS

P23

**2,175 psi - 5,000 psi Class A ... NO CERT REQUIRED**

Mobile, flexible installations, machinery wash-down, vac trucks, drill rigs, concrete pumps



### DRAIN JETTERS & ACCESSORIES

P24-31

**4,000 psi - 5,000 psi Class A & B**

Aussie Cobra series ... world's best drain cleaners  
Trolley, cube & trailer mounted



### ELECTRIC DRIVE

P32-36

**2,000 psi - 5,000 psi Class A  
7,300 psi Class B**

Cleaning contractors, construction, shipyards, large machinery wash-down, mine sites, council workshops





COLD WATER ENGINE DRIVE

## 3,000 PSI POCKET ROCKET 4,785 PSI EWP WITH FREE TURBO TRADIE SPECIAL

**3,000 PSI**  
from **\$2,078**  
NEW  
STAINLESS  
STEEL FRAME

**FREE**  
Turbo lance  
valued at \$157

### AB30 POCKET ROCKET

- ◆ **Genuine Honda** with 3 year Honda GX engine warranty
- ◆ **"Big Bert" Bertolini triplex pump** with 4 year warranty
- ◆ **NEW Compact**, robust stainless steel frame with steel wheels & **FLAT FREE** tyres (10")
- ◆ **Pro accessories**, gun, Vario lance & double wire braid high pressure hose
- ◆ **Detergent injection ...** faster cleaning (not for use with 15m hose)
- ◆ **FREE ASP (Aussie Safety Protection) kit** ... protects against pressure spikes & extended by-pass running

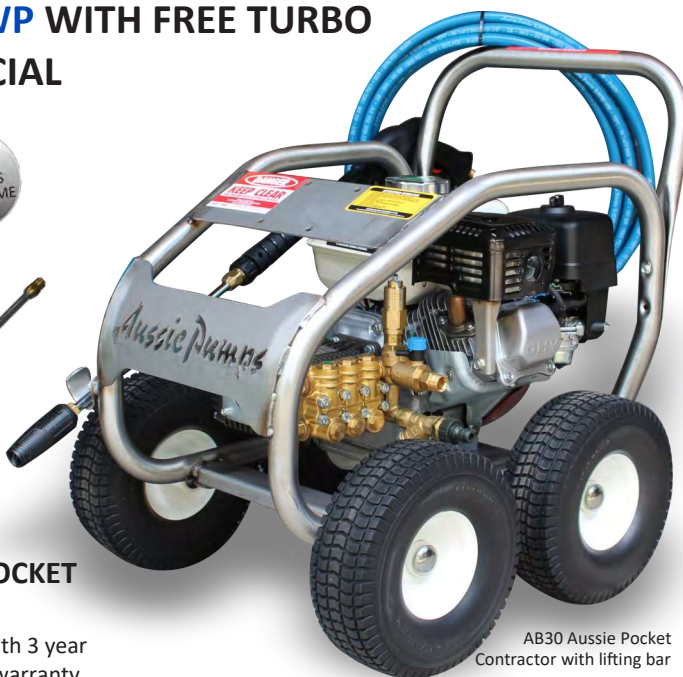

AB30 Aussie Pocket Contractor with lifting bar

#### AB30 CONTRACTOR VERSION

- ◆ **Includes lifting bar** for easy loading (ASS30LIFTBAR)
- ◆ **Heavy duty pro gun** with 700mm single lance (more suited to heavier work loads)

#### AB30 15M HOSE REEL VERSION

- ◆ **Fitted steel hose reel** with 15m double wire braid high pressure hose
- ◆ **FREE PRO-FOAMER** kit valued at \$148



**YANMAR**  
Diesel drive ...  
p12



	Pressure	EWP with turbo	Flow	Honda Engine	HP	Version	Stock code	List price
Scud AB30	3,000 psi (210 bar)	4,785 psi	10 lpm	GX200	6.5	Standard	ABSS30/GX200	\$2,078
						Contractor	ABSS30H/GX200	\$2,250
						Hose Reel	ABSS30/GX200HR	\$2,584

#### Pump details, weights & dimensions

	Bertolini Pump	Nozzle size	Version	Weight	Boxed dims mm
AB30	WBXG3025	030	Standard	45 kg	620 x 540 x 580
			Contractor	50 kg	620 x 540 x 580
			Hose Reel	55 kg	630 x 560 x 825

Scan to see it in action



#### Accessories supplied with machine

##### AB30 Standard & AB30 Hose reel version

Hose	AHW06M22X2X8	8m R2 3/8" with M22 couplings (NB not supplied with hose reel version)
Gun	M4021108007	AL13 gun
Lance	C4723.45.115	Vario Lance
Turbo	M4042100004	Turbo lance

Pump service kits ... p84-85

##### AB30 Contractor version

Hose	AHW06M22X2X8	8m R2 3/8" with M22 couplings
Gun	M4022209003	AL55 pro gun
Lance	C3905.14	700mm lance
Turbo	M4042100004	Turbo lance

### Optional accessories FASTER, SMARTER, SAFER

#### Tele-wand ... REACH FURTHER

p 76

Ideal for reaching eaves & washing windows, extends to 5.5m, includes FREE harness. Quik Tip nozzle sold separately.



AGPDLTG18	\$431
AGPDLTG18A Heavy duty	\$502
QT nozzle C915035Q	\$20

#### 15" FLAT SURFACE CLEANER

p 74

Clean flat surfaces three times faster, leaving a streak free finish. Steel deck.



FNA80166 (15")	\$225
700mm lance to suit	
FNA7103261	\$74

#### GUTTER CLEANER

p 77

##### DITCH THE LADDER

Unique design attaches to a lance & enables gutter cleaning. Can also be used with a turbo head. Inlet: 1/4 QC plug Outlet: 1/4" QC



AGPD20011		\$40
Quick Tip nozzle	C915035Q	\$20
70mm lance with QC	FNA7103261	\$74

#### NEW Foamer ... SPRAY FOAM FAST

p 77

##### LS3 foamer ...

Spray detergents, degreasers, disinfectants without chemicals going through the pump. Recommended for hoses in excess of 10m.



##### FREE with ABSC30/GX200HR

Hose reel version of AB30  
MPA25152612 \$148  
Requires coupling to fit to gun  
C1500.06 \$10

#### 4,000 psi Hose Reel Kit .. EASY FIT

p 72

Safer & smarter working, includes reel, 15m double wire braid hose, whip hose & mounting plate (not to be used in conjunction with lifting bar)



AD30001 (hose reel kit) \$565

#### Lifting bar .. EASY LOADING

Optional lift bar

ASS30LIFTBAR \$170



ABSS30/GX200 Standard version  
ABSS30H/GX200 Contractor version  
ABSS30/GX200HR Hose reel version





## NEW 4,000 PSI AB40 GT

6,485 PSI EWP WITH FREE TURBO

DIRECT DRIVE

**4,000 PSI**  
from **\$3,542**  
**NEW**  
STAINLESS  
STEEL FRAME

**FREE**

Turbo lance  
valued at \$262



NOW fitted with 13" wheels with flat free tyres

### SCUD AB40-GT

- ◆ **Genuine Honda 13HP** with 3 year Honda GX engine warranty
- ◆ **"Big Bert" Bertolini TMG triplex pump** with 4 year warranty
- ◆ **NEW Compact**, robust stainless steel frame with integrated hose reel mounting bar
- ◆ Steel wheels & **NEW FLAT FREE** tyres (13")
- ◆ **Pro accessories**, gun, dual lance & double wire braid high pressure hose
- ◆ **Detergent injection** ... faster cleaning (not for use with 30m hose)
- ◆ **FREE ASP (Aussie Safety Protection) kit** ... protects against pressure spikes & extended by-pass running
- ◆ **Optional lift bar** ASS40LIFTBAR \$230



### AB40-GT 30M HOSE REEL VERSION

- ◆ **Fitted steel hose reel** with 30m double wire braid high pressure hose



**YANMAR**  
Diesel drive  
... p12

	Pressure	EWP with turbo	Flow	Honda Engine	HP	Stock code	List price
<b>Scud AB40 GT</b>	4,000 psi (275 bar)	6,485 psi	13 lpm	GX390	13	Standard version ... ABSS40-GT/GX390	<b>\$3,542</b>
						Hose reel version ... ABSS40-GTGX390HR	<b>\$3,988</b>

Pump details, weights & dimensions

	Bertolini Pump	Nozzle size	Weight	Dimensions with skid (Lxwxh) mm (standard version)
Scud AB40 GT	TMG4035	030	75 kg	1100 x 800 x 950

Accessories supplied with machine

Hose	AHW06M22X2X10	10m R2 3/8" Aussie Blue-Pro non marking hose with M22 couplings (30m double wire braid hose supplied with hose reel version)
Gun	M4022209003	AL55 4,500 psi Pro Gun
Lance	C3924.01	700mm Dual Lance
Nozzle	C915030M C915500MSS	2 x Laser Cut (15° & detergent)
Turbo	CTN310-030	Turbo lance

Pump service kits ... p84-85

### Optional accessories FASTER, SMARTER, SAFER

#### Tele-wand ... REACH FURTHER p 76

Ideal for reaching eaves & washing windows, extends to 5.5m, includes FREE harness. Quik Tip nozzle sold separately.



AGPDLTG18	\$431
AGPDCLTG18A Heavy duty	\$502
QT nozzle C915030	\$20

#### CLEAN FLAT SURFACES FAST p 74

**SLASH CLEANING TIMES BY 75%**  
Clean flat surfaces four times faster, leaving a streak free finish. Standard nozzles included.



AGPDFSC20	20" Spinner	\$1,247
AGPDFSCS22Z	22" Cyclone	\$1,565

#### Extra length hose ... CONVENIENT p 70

Cleaning large plant?... reach further with these extra length **Aussie Blue-Pro** hoses, 5,800 psi rated, R2 wire braid hose, 3/8 female ends (M22 couplings sold separately)  
Note detergent injection will not work with longer hose, foamer required.



AHW06FB6FB6X20	(20m)	\$330
AHW06FB6FB6X30	(30m)	\$499
AHW06FB6FB6X50	(50m)	\$772
M212003540	(M22 QC)	\$21 (2 required)

#### Foam Jet ... SPRAY UP TO 3 STORIES p 77

Use with extra long hose to apply detergents, degreasers, disinfectants without chemicals going through the pump.



MTM140289	\$233
Requires coupling to fit to gun	
C1500.06	\$10

#### 4,000 psi Hose Reel Kit .. EASY FIT p 72

Safer & smarter working, includes reel, 30m double wire braid hose, whip hose & mounting plate.



ADHR40100D	(hose reel kit)	\$845
------------	-----------------	-------

Free Safety glasses with all Aussie blasters & jettors





## 2,000 - 4,000 PSI HONDA SCUD SLOW SPEED ... LONG LIFE



**4,000 PSI**  
from  
**\$4,186**  
**NEW**  
STAINLESS  
STEEL FRAME

### NEW

Scud 400 with  
30m hose & reel fitted  
(ABBSS400HR/GX390)

### NEW SUPER SCUD SERIES

- ◆ 'Big Bert' Bertolini slow speed triplex pump with 4 year warranty
- ◆ **NEW** Scud stainless steel frame & anti vib mounts, steel wheels with flat free tyres (13")
- ◆ Detergent injection ... faster cleaning
- ◆ Gearbox drive ... longer life, OH&S, dust free drive, 2:1 reduction
- ◆ **FREE ASP (Aussie Safety Protection) kit ...** protects operator & machine from pressure spikes & extended by-pass running
- ◆ **Pro accessories** including 10m hose, 4,500 psi pro gun & dual lance
- ◆ **Scud 400 option with hose reel fitted**
- ◆ Optional lift bar (ASS400LIFTBAR \$170)
- ◆ Optional Cobra Loc for permanent ute mounting (ACRADLECOBRA \$497)



COLD WATER ENGINE DRIVE

6

**CLASS A  
BLASTER**  
AS/NZS 4233.1

**BERTOLINI**  
pumps  
4 year warranty

POWERED BY  
**HONDA**  
**GX**  
Engine  
**3**  
YEAR  
WARRANTY

**YANMAR**  
Diesel drive ... p12

SCUD	Pressure	EWP with turbo	Flow	Honda Engine	HP	Version	Stock code	List price
350	3,000 psi (210 bar)	4,785 psi	15 lpm	GX390	13	Recoil	ABBSS350/GX390	\$3,980
						Electric start	ABBSS350/GX390E	\$4,430
351	2,600 psi (180 bar)	4,000 psi	21 lpm	GX390	13	Recoil	ABBSS351/GX390	\$4,360
						Electric start	ABBSS351/GX390E	\$4,720
400	4,000 psi (275 bar)	6,485 psi	15 lpm	GX390	13	Recoil	ABBSS400/GX390	\$4,186
						Recoil + reel	ABBSS400HR/GX390	\$5,390
						Electric start	ABBSS400/GX390E	\$4,688

Pump details, weights & dimensions

SCUD	Bertolini Pump	Nozzle size	Weight	Dimensions with skid (Lxwxh)
350	TTL1520	045	110kg	1100 x 800 x 950 mm
351	TTL2120	060	110kg	1100 x 800 x 950 mm
400	TTL1330	035	110kg	1100 x 800 x 950 mm

Accessories supplied with machine

Hose	AHW06M22X2X10 (AHW06M22X2X30)	10m R2 3/8" hose, M22 couplers (30m hose with hose reel version)
Gun	M4022209003	AL55 4,500 psi gun
Lance	C3924.01	700mm Dual Lance
Nozzle	C915__M C915500MSS	2 x Laser Cut (15° & detergent)

Pump service kits ... p86-87

**Aussie**  
**NO.1**  
**PRO CHOICE**  
SCUD 400

### Optional accessories FASTER, SMARTER, SAFER

#### Turbo Lance ... 60% MORE BITE p 59

Increase the effective working pressure (EWP) of your blaster without loading the pump!



CTN255-045	(Scud 350)	\$214
CTN255-060	(Scud 351)	\$214
CTN400-035	(Scud 400)	\$394

#### Tele-wand ... REACH further p 76

Ideal for reaching eaves & washing windows, extends to 5.5m, includes FREE harness. Quik Tip nozzle sold separately.



AGPDLTG18	\$431
AGPDLTG18A Heavy duty	\$502
QT nozzle C915__Q	\$20

(insert nozzle size)

#### CLEAN FLAT SURFACES FAST p 74

**SLASH CLEANING TIMES BY 75%**  
Clean flat surfaces four times faster, leaving a streak free finish. Standard nozzles included.



AGPDFSC20	20" Spinner	\$1,247
AGPDFSCS22Z	22" Cyclone	\$1,565

#### Foam Jet ... SPRAY UP TO 3 STORIES p 77

Use with extra long hose to apply detergents, degreasers, disinfectants with chemicals going through the pump.



MTM140289	\$233
Requires coupling to fit to gun	
C1500.06	\$10

#### Extra length hose ... CONVENIENT p 70

Cleaning large plant?... reach further with these extra length **Aussie Blue-Pro** hoses, 5,800 psi rated, R2 wire braid hose, 3/8 female ends



AHW06FB6FB6X20	(20m)	\$330
AHW06FB6FB6X30	(30m)	\$499
AHW06FB6FB6X50	(50m)	\$772
M212003540	(M22 QC)	\$21 (2 required)

#### 4,000 psi Hose Reel Kit .. EASY FIT p 72

Safer & smarter working, includes reel, 30m double wire braid hose, whip hose & mounting plate



For Scud 100 ... call Aussie  
ADHR40100D (hose reel kit) \$845  
AHRBARSSUNI (SS mounting bar) \$170

#### Drain Clearing Kit, SAFE & SIMPLE p 73

Includes Aussie Viper Mini Reel with 60 metres of 3/16" sewer hose. Full **Aussie Jettors Tool Box**, including quick coupler to fit to end of blaster high pressure hose. **Includes Safety Plate.**



ADRAINKIT \$3,285





## 4,000 PSI HONDA ... CLASS A SLOW SPEED | HUGE FLOW | REAL WHACK NO OPERATOR CERTIFICATION REQUIRED

4,000 PSI  
from  
**\$7,768**  
NEW  
STAINLESS  
STEEL FRAME



POWERED BY  
**HONDA**

### NEW ULTRA A

- ◆ **NEW Premium 'Big Bertie' heavy duty, slow speed triplex pump with 4 year warranty**
- ◆ **Stainless steel frame & anti vib mounts, steel wheels with flat free tyres (13")**
- ◆ **FREE ASP (Aussie Safety Protection) kit**
- ◆ **18 litre fuel tank**
- ◆ **Heavy duty gearbox drive provides OH&S safety benefits, minimal maintenance**
- ◆ **FREE ASP (Aussie Safety Protection) kit ... protects operator & machine from pressure spikes & extended by-pass running**
- ◆ **Pro accessories including 10m R2 wire braid hose, pro gun & dual stainless steel lance**
- ◆ **Hose reel version includes 30m high pressure hose on a fitted stainless steel reel**
- ◆ **Detergent injection ... faster cleaning**



	Pressure	EWP with turbo	Flow	Honda Engine	HP	Version	Stock code	List price
Ultra A	4,000 psi (275 bar)	6,485 psi	20 lpm	GX630	23	Standard	ABBSSULTRA/GX630	<b>\$7,768</b>
						Hose Reel	ABBSSULTA/GX630HR	<b>\$8,960</b>

#### Pump details, weight & dimensions

	Bertolini Pump	Nozzle size	Weight	Dimensions with skid (Lxwxh) mm
Ultra A	TTL 2028	050	135 kg	1100 x 800 x 1100

#### Accessories supplied with machine

	Accessories	Description
Hose	AHW06M22X2X10	10m R2 3/8" Aussie Blue-Pro non marking hose with M22 couplings (30m on hose reel version)
Gun	M4022209003	AL55 4,500 psi Pro Gun with melted handle
Lance	C3924.01	700mm Stainless Steel Dual Lance
Nozzle	C915050M C915500MSS	2 x Laser Cut (15° & detergent)

Pump service kits ... p86-87

**Aussie Hot Link** converts this machine into a hot water blaster ... p42



### Optional accessories FASTER, SMARTER, SAFER

#### TURBO LANCE ... 60% MORE BITE p 59

Increase the effective working pressure (EWP) of your blaster without loading the pump!



CTN400-050 **\$394**

#### Tele-wand ... REACH FURTHER p 76

Ideal for reaching eaves & washing windows, extends to 5.5m, includes FREE harness. Quik Tip nozzle sold separately.



AGPDLTG18 **\$431**  
AGPDCLTG18A Heavy duty **\$502**  
QT nozzle C915\_\_Q **\$20**  
(insert nozzle size)

#### CLEAN FLAT SURFACES FAST p 74

**SLASH CLEANING TIMES BY 75%**  
Clean flat surfaces four times faster, leaving a streak free finish. Standard nozzles included.



AGPDFSC20 20" Spinner **\$1,247**  
AGPDFSCS22Z 22" Cyclone **\$1,565**

#### Grit Blast Kit ... SURFACE PREP p 76

Remove paint & rust fast

MTM160172 **\$359**  
(head, probe & hose, NB nozzle & lance required)



#### Extra length hose ... CONVENIENT p 70

Cleaning large plant?... reach further with these extra length **Aussie Blue-Pro** hoses, 5,800 psi rated, R2 wire braid hose, 3/8 female ends (M22 couplings sold separately)



AHW06FB6FB6X20 (20m) **\$330**  
AHW06FB6FB6X30 (30m) **\$499**  
AHW06FB6FB6X50 (50m) **\$772**  
M212003540 (M22 QC) **\$21** (2 required)

#### 5,000 psi Stainless Steel Hose Reel p 73

5,000 psi rated, takes up to 80m of 3/8" hose, universal foot mount. **Fits to frame on petrol versions** (older models may need holes redrilled).



A4418SS-REEL (ss reel only) **\$890**  
AHW06FB6FB6X1 (1m whip hose) **\$31**  
M212003540 (3/8" M22 QC) **\$21** (3 required)  
AA-A-90-0606 (3/8" elbow) **\$22**  
C1500.49 (1/2" F M22) **\$17**

#### Drain Cleaning Kit, SAFE & SIMPLE p 73

Includes Aussie Viper Mini Reel with 60 metres of 3/16" sewer hose. Full **Aussie Jettors Tool Box**, including quick coupler to fit to end of blaster high pressure hose. **Includes Safety Plate.**



ADRAINKIT **\$3,285**

### 5,000 PSI HONDA ... CLASS A PETROL | SLOW SPEED | NO OPERATOR CERT REQUIRED

COLD WATER ENGINE DRIVE



5,000 PSI  
**\$8,698**

**NEW**  
STAINLESS  
STEEL FRAME

PREDATOR A

- ◆ 'Big Bert' slow speed triplex pump designed for continuous operation
- ◆ Heavy duty stainless steel frame, anti-vibration mounts, 13" steel wheels with flat free tyres .
- ◆ Reliable, powerful Honda engine (Vanguard option) with electric start
- ◆ Gearbox drive provides OH&S safety benefits, minimal maintenance.
- ◆ FREE ASP (Aussie Safety Protection) kit ... protects operator & machine from pressure spikes & extended by-pass running
- ◆ Heavy duty pro accessories including gun, single lance & 10m hp hose
- ◆ Diesel drive option p14

Scan & see Aussie Predator A demo



**CLASS A BLASTER**  
AS/NZS 4233.1

**BERTOLINI**  
pumps  
4 year warranty

POWERED by  
**HONDA**  
GX Engine  
3 YEAR WARRANTY

	Pressure	EWP with turbo	Flow	Honda Engine	HP	Stock code	List price
PREDATOR A	5,000 psi (350 bar)	8,500 psi	16 lpm	GX630	23	ABBSSPRED-A/GX630	<b>\$8,698</b>

Pump details, unit weight & dimensions

	Bertolini Pump	Nozzle size	Weight	Dimensions with skid (Lxwxh) mm
PREDATOR A	KTL1635	035	130kg	1100 x 800 x 1130

Accessories supplied with machine

Hose	AHW06FB6FB6X10	10m R2 3/8" Aussie Blue-Pro non marking hose with M22 couplings
Gun	MPA30450010	RL56 5,100 psi PA compensated spray gun
Lance	MPA40025800	800mm PA single lance
Nozzle	C915035M	Laser Cut (15°)

Pump service kits ... p86-87



**Aussie Pumps**  
SAFE OPERATOR

PPE to 500 bar ... p 80

### Optional accessories FASTER, SMARTER, SAFER

#### Turbo Gun Kit ... 60% MORE BITE p 59

Turbo lance/gun kit... Increase the effective working pressure of your blaster!



CTN400-035GLKM24

\$462

#### Grit Blast Kit ... SURFACE PREP p 76

Remove paint & rust fast (head, probe & hose, NB nozzle & lance require)



MTM160172

\$359

#### Extra length hose ... CONVENIENT p 70

Cleaning large plant?... reach further with these extra length Aussie Blue-Pro hoses, 5,800 psi rated R2 wire braid hose, 3/8 female ends (M24 couplings sold separately)



AHW06FB6FB6X20	(20m)	\$330
AHW06FB6FB6X30	(30m)	\$499
AHW06FB6FB6X50	(50m)	\$772
MPA26095050	(M24 QC)	\$137 (2 required)

#### 5,000 psi Stainless Steel Hose Reel p 73

5,000 psi rated, takes up to 80m of 3/8" hose, universal foot mount. Fits to frame on petrol versions only, otherwise wall mount.



A4418SS-REEL	(ss reel only)	\$890
AHW06FB6FB6X1	(1m whip hose)	\$31
AE-E-90-0808	(Elbow 1/2" FF)	\$30
AA-A-0608	(1/2" to 3/8" nipple)	\$8
AA-A-90-0606	(3/8" elbow)	\$22
MPA26065050	(M24 QC)	\$40 (2 required)

#### Drain Clearing Kit, SAFE & SIMPLE p 73

Includes Aussie Viper Mini Reel with 60 metres of 3/16" sewer hose. Full Aussie Jettors Tool Box, including quick coupler to fit to end of blaster high pressure hose. Includes Safety Plate.



ADRAINKIT \$3,285



# 7,300 PSI (500 BAR) PETROL VANGUARD | GEARBOX DRIVE | CLASS B



**RAPTOR**

- ♦ 'Big Bertie' heavy duty slow speed pumps designed for continuous operation ... Class B, operator RTO certification required
- ♦ Reliable, powerful engines (Vanguard petrol engines) with emergency stop
- ♦ Heavy duty stainless steel frame, anti-vib mounts
- ♦ 13" steel wheels with flat free tyres
- ♦ FREE ASP (Aussie Safety Protection) kit
- ♦ Double bearing gearbox drive ... OH&S safety benefits, minimal maintenance.
- ♦ 10 metres of 500 bar hose
- ♦ 500 bar accessories ... PA gun, 1050mm lance & ceramic nozzle
- ♦ 500 bar certified hose
- ♦ FREE hose restraint valued at \$130

**FREE** Aussie Safe Operator 500 bar Apron with every Raptor



Diesel drive option p15

	Pressure	EWP with turbo	Flow	Vanguard Engine	s/code	List price
<b>RAPTOR 18</b>	7,300 psi (500 bar)	12,000 psi	18 lpm	35HP	ABSSRAP/VAN18L	<b>\$12,868</b>

Pump details, weight & dimensions

	Bertolini Pump	Nozzle size	Weight	Dims with skid (Lxwxh)
<b>RAPTOR 18</b>	RA1850	030	135kg	1100 x 800 x 1000 mm

Accessories supplied with machine

Hose	A3641443109	10M 3/8" 500 bar
Gun/lance	MPA30540000	RL57 500 bar pro gun & 1050mm lance
Nozzle	M0124006210	Ceramic tip 500 bar nozzle 15°

Pump service kits ... p87-88



PPE to 500 bar ... p 80

### Optional accessories FASTER, SMARTER, SAFER

#### Turbo Master 500 ... MORE BITE p 79

Increase the effective working pressure (EWP) of your blaster without loading the pump!  
**500 bar (7,300 psi)** includes turbo head, gun, 800mm lance, nozzle & quick coupling nipple



CTN500-030GLK \$2,244

#### Foot Valve ... MORE CONTROL p 79

Stainless steel foot valve adds a second level of operator control, in addition to gun trigger, includes 3m whip hose  
 AST500-M24 \$975



#### Grit Blast Kit ... SURFACE PREP p 79

TPS 450, 500 bar (7,300 psi) c/w probe, plastic hose, lance, gun, nozzle & quick coupling nipple



TPS450/030GLK (insert nozzle size) \$1,559

#### 500 bar Hose Reels & Extra Length Hose p 73

500 bar reel, (7,300 psi) rated, takes up to 30m hose, universal foot mount.

HAR700 \$1,452  
 A3641443039 (2m whip hose, M24) \$440



3/8" R2 HP hose, 3/8M BSP ends, 150°C rated, for quick couplings refer p 67  
 A3641443209 (20m) \$976  
 A3641443309 (30m) \$1,246

#### Ceramic Nozzles ... LAST LONGER p 60

Aussie White Tip 500 bar 0° & 15°, nozzle material ceramic, inlet 1/4" NPT M ... \$142

Size	0° (pencil jet)	15° (fan)
030	M0124006200	M0124006210



## 2,000 - 4,000 PSI YANMAR

DIESEL | SLOW SPEED | LONG LIFE



FROM ONLY **\$4,920**  
**NEW**  
STAINLESS STEEL FRAME



COLD WATER ENGINE DRIVE

### SCUD YANMAR

- ♦ 'Big Bertie' slow speed pumps designed for continuous operation
- ♦ Industrial Yanmar LN series diesel engines
- ♦ NEW Scud stainless steel frame & anti vib mounts, steel wheels with flat free tyres (13")
- ♦ Gearbox drive
- ♦ FREE ASP (Aussie Safety Protection) kit including unloader, safety valve & thermal dump
- ♦ Detergent injection ... faster cleaning (not on Mine Spec version)
- ♦ Yanmar engine care kit ... see p 62

- #### Aussie Mine Spec Features:
- ♦ Emergency stop
  - ♦ Fire extinguisher
  - ♦ Dry cell battery with lockable battery isolation
  - ♦ Double insulated wire
  - ♦ Incorporated lifting bar/hose mounting bar
  - ♦ Single lance
  - ♦ Detergent injection option



SCUD	Pressure	EWP with turbo	Flow	Yanmar Engine	HP	Version	Stock code	List price
100 YDE	2,000 psi (140 bar)	2,600 psi	11 lpm	L48 recoil	4.8	Standard	ABSS100/L48	\$4,920
350 YDE	3,000 psi (210 bar)	4,785 psi	15 lpm	L100 e/start	10	Standard	ABBSS350/L100E	\$7,980
						Mine Spec	ABBSS350/L100EM	\$9,180
400 YDE	4,000 psi (275 bar)	6,485 psi	13 lpm	L100 e/start	10	Standard	ABBSS400/L100E	\$8,480
						Mine Spec	ABBSS400/L100EM	\$9,688

Pump details, weights & dimensions

SCUD	Bertolini Pump	Nozzle size	Weight	Dimensions with skid (Lxwxh)
100 YDE	WBL1114	-	50kg	620x540x580 mm
350 YDE	TTL1520	045	160kg	1100x800x950 mm
400 YDE	TTL1330	030	160kg	1100x800x950 mm



Accessories supplied with machine

Scud 100			Scud 350, 400 YDE Standard		Scud 350, 400 YDE Mine Spec	
Hose	AHW06M22X2X8	8m R2	AHW06M22X2X10	10m R2	AHW06M22X2X10	10m R2
Gun	M4021108007	AL13	M4022209003	AL55	CGPDG5010	Aussie Spray Gun
Lance	C4723.45.115	Vario	C3924.01	700mm Dual	C3905.15	900mm Single
Nozzle	-	-	C915__M	15° & detergent	C915__M	15°
Pump service kits ...	p85	-	Pump service kits ...	p86-87	-	-

### Optional accessories FASTER, SMARTER, SAFER

#### Turbo Lance ... 60% MORE BITE p 59

Increase the effective working pressure (EWP) of your blaster without loading the pump!



M4042100004	(Scud 100 YDE)	\$157
CTN255-045	(Scud 350 YDE)	\$214
CTN400-030	(Scud 400 YDE)	\$394
CTN400-__GLK	(Scud Mine Spec)	\$430

#### Tele-wand ... REACH FURTHER p 76

Ideal for reaching eaves & washing windows, extends to 5.5m, includes FREE harness. Quik Tip nozzle sold separately.



AGPDFLTG18		\$431
AGPDFLTG18A	Heavy duty	\$502
QT nozzle C915__Q		\$20

(insert nozzle size)

#### CLEAN FLAT SURFACES FAST p 74

##### SLASH CLEANING TIMES BY 75%

Clean flat surfaces four times faster, leaving a streak free finish. Standard nozzles included.



AGPDFSC20	20" Spinner	\$1,247
AGPDFSCS22Z	22" Cyclone	\$1,565

#### Grit Blast Kit ... SURFACE PREP p 76

Remove paint & rust fast

M202903460	(to 3,000 psi)	\$233
(head, lance, nozzle, probe & hose)		
MTM160172	(4,000 psi)	\$359
(head, probe & hose, NB nozzle & lance required)		



#### Extra length hose ... CONVENIENT p 70

Cleaning large plant?...

reach further with these extra length Aussie Blue-Pro hoses, 5,800 psi rated, R2 wire braid hose, 3/8 female ends (M22 & M24 couplings sold separately)



AHW06FB6FB6X20	(20m)	\$330
AHW06FB6FB6X30	(30m)	\$499
AHW06FB6FB6X50	(50m)	\$772
M212003540	(M22 QC)	\$21 (2 required)

#### 4,000 psi Hose Reel Kit .. EASY FIT p 72

Safer & smarter working, includes reel, 30m double wire braid hose, whip hose & mounting plate



For Scud 100 ... call Aussie

ADHR40100D	(hose reel kit)	\$845
AHRPLATEL100SS	(mounting bar for standard frame)	\$211

#### Drain Cleaning Kit, SAFE & SIMPLE p 73

Includes Aussie Viper Mini Reel with 60 metres of 3/16" sewer hose. Full Aussie Jetters Tool Box, including quick coupler to fit to end of blaster high pressure hose. Includes Safety Plate.



ADRAINKIT	\$3,285
-----------	---------



### NEW 4,000 PSI ATLAS

HATZ | SUPER HEAVY DUTY

4,000 PSI  
\$16,420  
NEW  
STAINLESS  
STEEL FRAME



ATLAS 400

- ◆ 'Big Bertie' slow speed pumps designed for continuous operation
- ◆ Industrial Hatz B series diesel with DSE engine control panel & 21 litre fuel tank
- ◆ NEW Scud stainless steel frame & anti vib mounts, steel wheels with pneumatic tyres
- ◆ Gearbox drive provides OH&S safety benefits, minimal maintenance
- ◆ 30 litre stainless steel break tank
- ◆ Stainless steel reel with 30m Aussie Blue-Pro hose
- ◆ FREE ASP (Aussie Safety Protection) kit including unloader, safety valve & thermal dump
- ◆ Detergent injection ... faster cleaning
- ◆ Hatz engine care kit ... see p 62

#### Aussie Mine Spec Features:

- ◆ Emergency stop
- ◆ Fire extinguisher
- ◆ Dry cell battery with lockable battery isolation
- ◆ Double insulated wire
- ◆ Lifting bar/hose mounting bar



Honda petrol drive ... p9



	Pressure	EWP with turbo	Flow	Hatz Engine	HP	Stock code	List price
Atlas 400	4,000 psi (275 bar)	6,485 psi	15 lpm	1B50E e/start	11	ABBSS400/1B50EMS	\$16,420

Pump details, weight & dimensions

	Bertolini Pump	Nozzle size	Weight	Dimensions with skid (Lxwxh) mm
Atlas 400	TTL1530	035	220 kg	1150 x 800 x 1650

Accessories supplied with machine

Hose	AHW06M22X2X30	30m R2 3/8" Aussie Blue-Pro non marking hose with M22 couplings
Gun	CGPDG5010	Aussie Blue-Pro Gun
Lance	C3905.15	900mm Stainless Steel Dual Lance
Nozzle	C915040M	Laser Cut (15°)

Pump service kits ... p86-87

### Optional accessories FASTER, SMARTER, SAFER

#### Turbo Kit ... 60% MORE BITE p 59

Turbo lance/gun kit.... Increase the effective working pressure of your blaster!



CTN400-035GLK \$430

#### Tele-wand ... REACH FURTHER p 76

Ideal for reaching eaves & washing windows, extends to 5.5m, includes FREE harness. Quik Tip nozzle sold separately.



AGPDLTG18 \$431  
AGPDCLTG18A Heavy duty \$502  
QT nozzle C915\_\_Q \$20  
(insert nozzle size)

#### CLEAN FLAT SURFACES FAST p 74

SLASH CLEANING TIMES BY 75%  
Clean flat surfaces four times faster, leaving a streak free finish. Standard nozzles included.

AGPDFSC20 20" Spinner \$1,247  
AGPDFSCS22Z 22" Cyclone \$1,565



#### Grit Blast Kit ... SURFACE PREP p 76

Remove paint & rust fast

M202903460 (to 3,000 psi) \$233  
(head, lance, nozzle, probe & hose)  
MTM160172 (4,000 psi) \$359  
(head, probe & hose,  
NB nozzle & lance required)



#### Extra length hose ... CONVENIENT p 70

Cleaning large plant?... reach further with these extra length Aussie Blue-Pro hoses, 5,800 psi rated, R2 wire braid hose, 3/8 female ends (M22 & M24 couplings sold separately)



AHW06FB6FB6X20 (20m) \$330  
AHW06FB6FB6X30 (30m) \$499  
AHW06FB6FB6X50 (50m) \$772  
M212003540 (M22 QC) \$21 (2 required)

#### Drain Clearing Kit, SAFE & SIMPLE p 73

Includes Aussie Viper Mini Reel with 60 metres of 3/16" sewer hose. Full Aussie Jettors Tool Box, including quick coupler to fit to end of blaster high pressure hose. Includes Safety Plate.



ADRAINKIT \$3,285

COLD WATER ENGINE DRIVE

6

### 5,000 PSI DIESEL DIESEL | GEARBOX DRIVE CLASS A .. NO OPERATOR CERT REQUIRED



5,000 PSI  
from  
**\$15,260**

**NEW**  
STAINLESS  
STEEL FRAME

**PREDATOR A KDE**  
Shown here with hose reels fitted in  
place of lifting bar

- ◆ **NEW Premium 'Big Berty' pump** designed for continuous operation
- ◆ **Heavy duty stainless steel frame**, anti-vibration mounts
- ◆ **16" steel wheels** with pneumatic tyres
- ◆ **Reliable, powerful Kohler** air cooled diesel engine
- ◆ **FREE ASP (Aussie Safety Protection) kit** ... protects operator & machine from pressure spikes & extended by-pass running
- ◆ **Gearbox drive** provides OH&S safety benefits, minimal maintenance
- ◆ **Heavy duty pro accessories** ... gun, single lance & 10m hp hose

#### Aussie Mine Spec Features:

- ◆ Emergency stop
- ◆ Fire extinguisher
- ◆ Dry cell battery with lockable battery isolation
- ◆ Double insulated wire
- ◆ Lifting bar (ASSPREDLIFTBAR \$252)

Honda petrol drive ... p10



	Pressure	EWP with turbo	Flow	Kohler Engine	HP	Version	Stock code	List price
<b>PREDATOR A KDE</b>	5,000 psi (350 bar)	8,500 psi	16 lpm	KD477	23	Standard	ABSSPRED-A/KDE	<b>\$15,260</b>
						Mine Boss	ABBSSPRED-A/KDMS	<b>\$19,426</b>

Pump details, weight & dimensions

	Bertolini Pump	Nozzle size	Weight	Dimensions with skid (Lxwxh)
<b>PREDATOR A KDE</b>	KTL1635	035	250kg	1250 x 800 x 1130 mm

Accessories supplied with machine

Hose	AHW06FB6FB6X10	10m R2 3/8" Aussie Blue-Pro non marking hose with M22 couplings
Gun	MPA30450010	RL56 5,100 psi PA compensated spray gun
Lance	MPA40025800	800mm PA single lance
Nozzle	C915035M	Laser Cut (15°)

Pump service kits ... p86-87



**Aussie Pumps**  
SAFE OPERATOR

PPE to 500 bar ... p 80

### Optional accessories FASTER, SMARTER, SAFER

**Turbo Lance Kit ... 60% MORE BITE** p 59

Turbo lance/gun kit... Increase the effective working pressure of your blaster!



CTN400-035GLKM24 \$441

**Grit Blast Kit ... SURFACE PREP** p 76

Remove paint & rust fast (head, probe & hose, NB nozzle & lance required)



MTM160172 \$359

**Extra length hose ... CONVENIENT** p 70

Cleaning large plant?... reach further with these extra length Aussie Blue-Pro hoses, 5,800 psi rated, R2 wire braid hose, 3/8 female ends (M24 couplings sold separately)



AHW06FB6FB6X20	(20m)	<b>\$330</b>
AHW06FB6FB6X30	(30m)	<b>\$499</b>
AHW06FB6FB6X50	(50m)	<b>\$772</b>
MPA26065050	(M24 QC)	<b>\$40</b> (2 required)

**5,000 psi Stainless Steel Hose Reel** p 73

5,000 psi rated, takes up to 80m of 3/8" hose, universal foot mount. Fits to frame on petrol versions only, otherwise wall mount.



A4418SS-REEL	(ss reel only)	<b>\$890</b>
AHW06FB6FB6X1	(1m whip hose)	<b>\$31</b>
AE-E-90-0808	(Elbow 1/2" FF)	<b>\$30</b>
AA-A-0608	(1/2" to 3/8" nipple)	<b>\$8</b>
AA-A-90-0606	(3/8" elbow)	<b>\$22</b>
MPA26065050	(M24 QC)	<b>\$40</b> (2 required)
AHRSCPRED/KOH	mounting bar	<b>\$180</b>

**Drain Cleaning Kit ... SAFE & SIMPLE** p 73

Includes Aussie Viper Mini Reel with 60 metres of 3/16" sewer hose. Full Aussie Jetters Tool Box, including quick coupler to fit to end of blaster high pressure hose. Includes Safety Plate.



ADRAINKIT \$3,285



### 7,300 PSI (500 BAR) DIESEL

GEARBOX DRIVE | CLASS B (OPERATOR RTO CERT REQUIRED)



**7,300 PSI**  
from  
**\$21,920**  
**NEW**  
STAINLESS  
STEEL FRAME

**FREE**  
Aussie Safe Operator  
500 bar Apron with  
every Raptor



Honda petrol drive ... p11

#### RAPTOR DIESEL

- ♦ 'Big Bertie' slow speed pumps designed for continuous operation
- ♦ Kohler industrial diesel engines with **emergency stop**
- ♦ **Heavy duty stainless steel frame**, anti-vib mounts
- ♦ **16" steel wheels** with pneumatic tyres
- ♦ **FREE ASP (Aussie Safety Protection) kit ...** protects operator & machine from pressure spikes & extended by-pass running
- ♦ 10 metres of 500 bar hose
- ♦ **500 bar accessories ...** PA gun, 1050mm lance & ceramic nozzle
- ♦ **500 bar certified hose**
- ♦ **FREE hose restraint** valued at \$130
- ♦ **Aussie Mine spec includes**
  - ♦ Emergency stop
  - ♦ Fire extinguisher (2 Kg)
  - ♦ Dual pole battery isolator
  - ♦ High-viz class A reflective frame markings
  - ♦ Double insulated wiring
  - ♦ Lifting bar (ASSPREDLIFTBAR \$252)

	Pressure	EWP with turbo	Flow	Kohler Engine	HP	Version	Stock code	List price
<b>RAPTOR 16 KOH</b>	7,300 psi (500 bar)	12,000 psi	16 lpm	KD477	23	Standard	ABRAPK23H16/500	<b>\$21,920</b>
						Mine Spec	ABRAPK23H16/500MS	<b>\$24,846</b>

#### Pump details, weight & dimensions

	Bertolini Pump	Nozzle size	Weight	Dimensions with skid (Lxwxh) mm
<b>RAPTOR 16 KOH</b>	RA1650	030	250kg	1250 x 1200 x 1500

#### Accessories supplied with machine

Hose	A3641443109	10M 3/8" 500 bar
Gun/lance	MPA30540000	RL57 500 bar pro gun & 1050mm lance
Nozzle	M0124006210	Ceramic tip 500 bar nozzle 15°

Pump service kits ... p87-88



PPE to 500 bar ... p 80

#### Optional accessories FASTER, SMARTER, SAFER

##### Turbo Master 500 .... MORE BITE p 79

Increase the effective working pressure (EWP) of your blaster without loading the pump!  
**500 bar (7,300 psi)** includes turbo head, gun, 800mm lance, nozzle & quick coupling nipple



CTN500-030 GLK **\$2,244**  
(insert nozzle size)

##### Foot Valve ... MORE CONTROL p 79

Stainless steel foot valve adds a second level of operator control, in addition to gun trigger, includes 3m whip hose  
AST500-M24 **\$975**



##### Grit Blast Kit ... SURFACE PREP p 79

TPS 450, 500 bar (7,300 psi) c/w probe, plastic hose, lance, gun, nozzle & quick coupling nipple



TPS450/030 GLK  
(insert nozzle size) **\$1,559**

##### 500 Bar Hose Reels & Hose p 73

500 bar reel, (7,300 psi) rated, takes up to 30m hose, universal foot mount. Does not fit onto frame, wall mount only.

HAR700 **\$1,452**  
A3641443039 (2m whip hose, M24) **\$440**



3/8" R2 HP hose, 3/8M BSP ends, 150°C rated, for quick couplings refer p 67  
A3641443209 (20m) **\$976**  
A3641443309 (30m) **\$1,246**  
AHRSPRED/KOH mounting bar **\$180**

##### Ceramic Nozzles ... LAST LONGER p 60

**Aussie White Tip** 500 bar 0° & 15°, nozzle, ceramic insert , inlet 1/4" NPT M ... **\$142**

Size	0° (pencil jet)	15° (fan)
030	M0124006200	M0124006210



COLD WATER MINE SPEC UNITS

6



## 4,300 - 5,000 PSI MINE SPEC EXTREME CLASS B ... OPERATOR CERTIFICATION REQUIRED



### PYTHON & PREDATOR

- ♦ 'Big Berty' slow speed pumps designed for continuous operation
- ♦ Heavy duty gal frame skid base with multiple fork lifting points & integrated bunding
- ♦ Reliable, water cooled, multi cylinder, Yanmar engine producing 24kW at 2300 rpm
- ♦ Integrated control panel including full engine protection & hour meter.
- ♦ 50 litre fuel tank ... runs for approx. 8 hrs.
- ♦ Engine governed to 2,400 rpm max
- ♦ 60 litre stainless steel break tank with low water shutdown
- ♦ FREE ASP (Aussie Safety Protection) kit
- ♦ Stainless steel hose reel with 30 metres of R2 double wire braid 400 bar rated hose. (Manual Recoil reel option, \$2,850 extra)
- ♦ FREE hose restraint worth \$130

#### Aussie Mine spec includes

- ♦ Emergency stop
- ♦ Bunded frame
- ♦ Fire extinguisher (2 Kg)
- ♦ Dual pole battery isolator
- ♦ High-viz class A reflective frame markings
- ♦ Flashing safety beacon
- ♦ Double insulated wiring



FREE ASP (Aussie Safety Protection) kit



	Pressure	EWP with turbo	Flow	Yanmar Engine	Stock code	List price
<b>Python MS</b>	4,300 psi (300 bar)	6,485 psi	31 lpm	3 TNV88	ABPYTHON18-3TNV	<b>\$29,403</b>
<b>Predator + MS</b>	5,000 psi (350 bar)	8,500 psi	25 lpm	3 TNV88	ABPRED+3TNV	<b>\$29,866</b>

Pump details, weight & dimensions

	Bertolini Pump	Nozzle size	Weight	Dims with skid (Lxwxh) mm
<b>Python MS</b>	Premium RAS4482	070	565kg	1400x1400x1250
<b>Predator + MS</b>	Premium RAL2535	045	560kg	1400x1400x1250

Accessories supplied with machine

Hose	AHW06FB6FB6X30	30m R2 3/8" Aussie Blue-Pro hose with M22 couplings
Gun	AGPDG5010	5,000 psi pro gun
Lance	C3905.15	900mm single lance
Nozzle	C915 __ _M	Laser Cut (15°)

Pump service kits ... p87-88

### Optional accessories FASTER, SMARTER, SAFER

#### Turbo Lance Kit ... 60% MORE BITE p 59

Turbo lance/gun kit... Increase the effective working pressure of your blaster!



CTN400-045GLKM24	\$441
CTN400-075GLK	\$430

#### Grit Blast Kit ... SURFACE PREP p 76

Remove paint & rust fast  
(head, probe & hose, NB nozzle & lance required)



MTM160172	\$359
-----------	-------

#### Foot Valve ... MORE CONTROL p 30

350 BAR foot valve adds a second level of operator control, in addition to gun trigger,



AST350-2605	\$594
AHW06FB6FB6X2 (whip hose)	\$45
C1500.05 (1/4" F x M22 nipple)	\$10
C1500.24 (3/8" M x M22 nipple)	\$10
CD10030 (M22 couplings-2 required)	\$12

#### 500 Bar Personal Protective Gear p 80



- ♦ Overalls
- ♦ Aprons
- ♦ Jackets
- ♦ Gloves
- ♦ Trousers
- ♦ Boots



#### Drain Clearing Kit, SAFE & SIMPLE p 73

Includes Aussie Viper Mini Reel with 60 metres of 3/16" sewer hose. Full Aussie Jettors Tool Box, including quick coupler to fit to end of blaster high pressure hose. Includes Safety Plate.

ADRAINKIT	\$3,285
-----------	---------







## 7,300 PSI MINE SPEC EXTREME RAPTOR MAXI'S .... CONTINUOUS DUTY CLASS B ... OPERATOR CERTIFICATION REQUIRED



### RAPTOR MAXI

- ◆ 'Big Bert' slow speed pumps designed for continuous operation ... 4 year warranty
- ◆ Heavy duty gal frame skid base with multiple fork lifting points & integrated bunding
- ◆ Reliable, water cooled, multi cylinder Yanmar engine
- ◆ Integrated control panel including full engine protection & hour meter.
- ◆ 50 litre fuel tank ... runs for approx. 8 hrs.
- ◆ Engine governed to 2,400 rpm max
- ◆ 60 litre stainless steel break tank with low water shutdown
- ◆ FREE ASP (Aussie Safety Protection) kit
- ◆ 30 metres of R2 double wire braid 500 bar rated, certified hose on stainless steel hose reel (Manual Recoil 10,000 psi rated reel option, \$3,450 extra)
- ◆ FREE hose restraint valued at \$130
- ◆ Aussie Mine spec includes
  - ◆ Emergency stop
  - ◆ Bunded frame
  - ◆ Fire extinguisher (2 Kg)
  - ◆ Dual pole battery isolator
  - ◆ High-viz class A reflective frame markings
  - ◆ Flashing safety beacon
  - ◆ Double insulated wiring



**FREE**  
Aussie Safe Operator  
500 bar Apron with  
every Raptor



**BERTOLINI**  
pumps  
4 year warranty



RAPTOR	Pressure	EWP with turbo	Flow	Yanmar Engine	Stock code	List price
MAXI 18	7,300 psi (500 bar)	12,000 psi	18 lpm	3 TNV88 24kW @ 2300rpm	ABRAPTOR18-3TNV	<b>\$31,370</b>
MAXI 21	7,300 psi (500 bar)	12,000 psi	21 lpm	3 TNV84T 26kW @ 2300rpm	ABRAPTOR21-ETNV	<b>\$34,228</b>
MAXI 24	7,300 psi (500 bar)	12,000 psi	24 lpm	4 TNV88 30kW @ 2300rpm	ABRAPTOR24-4TNV88	<b>\$38,618</b>

	Bertolini Pump	Nozzle size	Weight	Dims with skid (Lxwxh)
MAXI 18	RA1850	030	565kg	1400x1400x1250mm
MAXI 21	RA2150	035	590kg	1400x1400x1250mm
MAXI 24	RA2150	040	590kg	1400x1400x1250mm

Accessories supplied with machine

Hose	A3641443109	10M 3/8" 500 bar
Gun/lance	MPA30540000	RL57 500 bar pro gun & 1050mm lance
Nozzle	See nozzle chart	Ceramic tip 500 bar nozzle 15°

Pump service kits ... p87-88



### 500 BAR accessories for FASTER, SMARTER, SAFER cleaning

#### Turbo Master 500 .... MORE BITE p 79

Increase the effective working pressure (EWP) of your blaster without loading the pump!

**500 bar (7,300 psi)** includes turbo head, gun, 800mm lance, nozzle & quick coupling nipple



CTN500-\_\_\_GLK **\$2,244**  
(insert nozzle size)

#### Foot Valve ... MORE CONTROL p79

Stainless steel foot valve adds a second level of operator control, in addition to gun trigger, includes 3m whip hose  
AST500-M24 **\$975**



#### Grit Blast Kit ... SURFACE PREP p 79

TPS 450, 500 bar (7,300 psi) c/w probe, plastic hose, lance, gun, nozzle & quick coupling nipple



TPS450/\_\_\_GLK  
(insert nozzle size) **\$1,559**

#### Personal Protective Gear 500 bar p 80



- ◆ Overalls
- ◆ Aprons
- ◆ Jackets
- ◆ Gloves
- ◆ Trousers
- ◆ Boots



#### Ceramic Nozzles ... LAST LONGER p 60

**Aussie White Tip** 500 bar 0° & 15°, nozzle material ceramic, inlet 1/4" NPT  
M ... **\$142**



Size	0° (pencil jet)	15° (fan)
030	M0124006200	M0124006210
035	M0124006300	M0124006310
040	M0124006400	M0124006410



COLD WATER MINE SPEC UNITS

6



### BUILT TO A HIRE SPEC

Heavy duty machines specifically designed for the hire industry. Robust fittings & low maintenance components make them reliable & simple to use.

#### ELECTRIC DRIVE



**BERTOLINI**  
pumps  
4 year warranty

- ◆ 'Big Bertey' triplex brass pump
- ◆ IP 56 4 pole electric motor (1450 rpm)
- ◆ Compact "car boot" style gal frame, solid rubber wheels
- ◆ Heavy duty on/off switch with motor protection,
- ◆ Heavy duty unloader valve
- ◆ Stainless steel 900 mm single lance
- ◆ 4,000 psi rated hand gun.
- ◆ 10 metres of HP hose with pigtail wrap
- ◆ Hydrotester option

BB100E

#### Specifications

	Pressure	EWP with turbo	Flow	Motor	Pump	Nozzle size	Weight	Boxed dimensions (Lxwxh) mm
BB100 Electric	1,400 psi (100 bar)	1,820 psi	11 lpm	240V 2.2KW 4 pole	WBL1114	035	55kg	680 x 400 x 340

#### Stock codes & prices

BB100 Electric	ABB100EH/2.2KW	<b>\$2,439</b>
----------------	----------------	----------------

#### Accessories supplied with machine (with replacement price)

Gun/lance/nozzle kit	APROGUN-900-035	<b>\$175</b>
Hose kit	AKENNHOSKIT1	<b>\$382</b>

#### ENGINE DRIVE

- ◆ 'Big Bertey' triplex brass pump
- ◆ Industrial Honda petrol or Yanmar diesel
- ◆ Gearbox drive for extra long life
- ◆ NEW stainless steel frame with lifting bar
- ◆ ASP Safety Pack including safety valve, thermal dump valve & heavy duty unloader valve
- ◆ Stainless steel 900 mm single lance
- ◆ 4,000 psi rated hand gun
- ◆ Combine with an optional Aussie drain cleaning kit to enable this blaster to be used as a jetter ... p73

**BERTOLINI**  
pumps  
4 year warranty

**NEW**  
STAINLESS  
STEEL FRAME

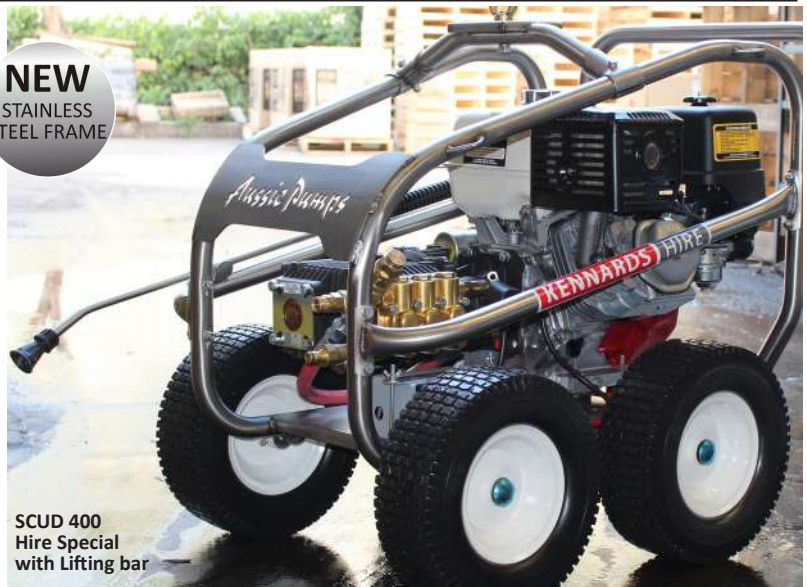

SCUD 400  
Hire Special  
with Lifting bar

#### Specifications

	Pressure	EWP with turbo	Flow	Engine	Pump	Nozzle size	Weight	Boxed dim (Lxwxh) mm
BB100 Honda	2,000 psi (140 bar)	2,600 psi	11 lpm	Honda GX200 recoil start	WBL1114	035	45 kg	580 x 430 x 550
Scud AB30 Honda Hire Spec	3,000 psi (210 bar)	4,785 psi	10 lpm	Honda GX200 recoil start	WBXG3025	030	45 kg	620 x 540 x 580
Scud 400 Honda Hire spec	4,000 psi (275 bar)	6,485 psi	15 lpm	Honda GX390 electric start	TTL1330	035	115 kg	1100 x 800 x 950
Scud 400 Yanmar Hire spec	4,000 psi (275 bar)	6,485 psi	13 lpm	Yanmar L100 electric start	TTL1330	035	160 kg	1100 x 800 x 950

#### Stock codes & prices

BB100 Honda (gal frame)	ABB100K/GX200	<b>\$2,659</b>
Scud AB30 Honda Hire Spec (ss frame)	ABSS30H/GX200	<b>\$2,250</b>
Scud 400 Honda Hire spec (ss frame)	ABBSS400KGX390E	<b>\$4,786</b>
Scud 400 Yanmar Hire spec (ss frame)	ABBSS400H/L100E	<b>\$8,642</b>

#### Accessories supplied with machine (with replacement price)

Gun/lance/nozzle kit (BB100/AB30/Scud 400)	APROGUN-900-035	<b>\$175</b>
Aussie BluePro 10m hose with pigtail wrap (BB100/Scud 400)	AKENNHOSKIT1	<b>\$382</b>
Aussie BluePro 8m hose (AB30)	AHW06M22X2X8	<b>\$142</b>



BB100H  
(4 wheel frame option)



Scud AB30 Hire



### INDUSTRIAL COLD WATER HIRE UNITS

#### Aussie Ultra & Predator A Class A blasters ....

#### NO OPERATOR CERTIFICATION REQUIRED

- ◆ 'Big Bertie' triplex, heavy duty, slow speed, brass pump
- ◆ Industrial Honda petrol or Kohler diesel
- ◆ Gearbox drive for extra long life
- ◆ NEW stainless steel frame with lifting bar/hose reel bar
- ◆ ASP Safety Pack including safety valve, thermal dump valve & heavy duty unloader valve
- ◆ Stainless steel 900 mm single lance
- ◆ 4,000 psi rated hand gun
- ◆ Mine Boss options
- ◆ Fitted hose reel options



#### Honda Petrol

Aussie Ultra A ... 4,000 psi | 20 lpm | GX630 .... Page 9

Aussie Predator A ... 5,000 psi | 16 lpm | GX630 .... Page 10

#### Diesel

Aussie Predator A ... 5,000 psi | 16 lpm | KD477 .... Page 14

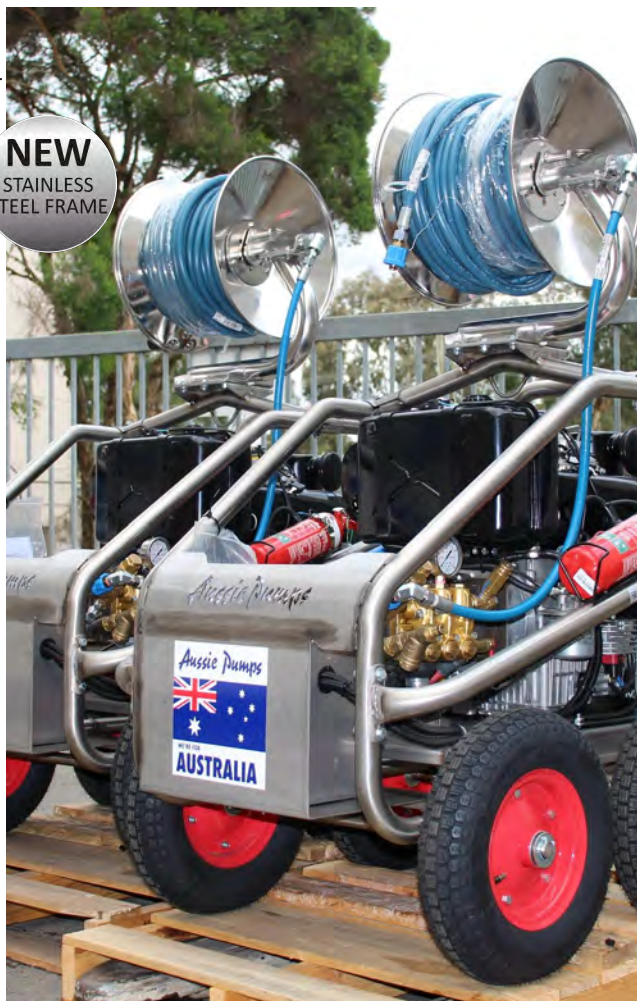

HIRE SPEC

### DOCKYARD SPECIALIST .... AUSSIE ATLAS

#### HARD WORKING AUSSIES FOR MINE SITES & SHIPYARDS

- ◆ 'Big Bertie' slow speed pumps designed for continuous operation
  - ◆ Industrial Hatz B series diesel with DSE engine control panel
  - ◆ NEW Scud stainless steel frame & anti vib mounts, steel wheels with pneumatic tyres
  - ◆ Gearbox drive
  - ◆ Stainless steel break tank
  - ◆ Stainless steel reel with 30m Aussie Blue-Pro hose
  - ◆ FREE ASP (Aussie Safety Protection) kit including unloader, safety valve & thermal dump
- Aussie Mine Spec Features:**
- ◆ Emergency stop
  - ◆ Fire extinguisher
  - ◆ Dry cell battery with lockable battery isolation
  - ◆ Double insulated wire
  - ◆ Lifting bar/hose mounting bar



6

	Pressure	EWP with turbo	Flow	Engine	Pump	Nozzle size	Weight	Dimensions with skid (Lxwxh) mm
<b>Atlas 400</b>	4,000 psi (275 bar)	6,485 psi	15 lpm	Hatz 1B50E	TTL1530	035	220 kg	1150 x 800 x 1650

Stock code & pricing

<b>Atlas 400</b>	Electric start	ABBSS400/1B50EMS	<b>\$16,420</b>
------------------	----------------	------------------	-----------------

Accessories supplied with machine

Hose	AHW06M22X2X30	30m R2 3/8" Aussie Blue-Pro hose
Gun	CGPDG5010	Aussie Blue-Pro Gun
Lance	C3905.15	900mm Stainless Steel Dual Lance
Nozzle	C915040M	Laser Cut (15°)



## HIRE A JETTER ... IT'S EASY

OPERATOR CERTIFICATION NOT REQUIRED



**COBRA A**

**NEW**  
STAINLESS  
STEEL FRAME

Drains to  
150mm  
**6"**



**CLASS A BLASTER**  
AS/NZS 4233.1

- ◆ "Big Berty" Bertolini heavy duty pump designed for continuous service
- ◆ Genuine Honda electric start industrial twin cylinder engine
- ◆ 30 litre stainless steel break tank with cut off float and low water cut out pump protection
- ◆ NEW stainless steel frame designed to fit through doorways
- ◆ 12 litre fuel tank
- ◆ FREE ASP (Aussie safety protection) kit
- ◆ NEW 5,000 psi rated steel hose reel
- ◆ 60 m 3/4" R8 high quality sewer hose
- ◆ FREE 7 piece Aussie Jetters Nozzle box

Specifications

	Pressure	EWP with turbo	Flow	Engine	Clears drains to	Pump	Nozzle size	Weight	Unit Dim (Lxwxh) mm
<b>Cobra A</b>	4,000 psi (275 bar)	6,485 psi	20 lpm	Honda E/S GX630	6" (150mm)	TTL2028	050	130 kg	900x600x1330

Stock codes & prices

<b>Cobra A</b>	ABSSCOBRA-A	<b>\$9,482</b>
----------------	-------------	----------------

Replacement accessories

Hose	AHOSE RF8-60M	60M R8 3/4" sewer hose
Gun	CGPDG5010	5,000 psi pro gun
Lance	C3905.15	900mm single lance
Nozzle	AD NOZZLE BOX	Full 7 piece nozzle box

Optional accessories

### Viper Mini Reel ... REMOTE CONTROL

Leave your jetter in the ute & extend your reach to 120m (60m on jetter & 60m on mini reel)

- Stainless steel stand/handle
- Integrated on/off valve that allows remote control of jetter
- 60m of Redflex 3/16" sewer hose
- Three nozzle holders
- Pressure gauge



AMINIREEL/WHOSE

\$2,040

## CLEANING ACCESSORIES FOR FASTER, BETTER RESULTS

VALUE ADD EVERY HIRE

### AUSSIE 5,000 PSI PRO-GUN KIT—SINGLE

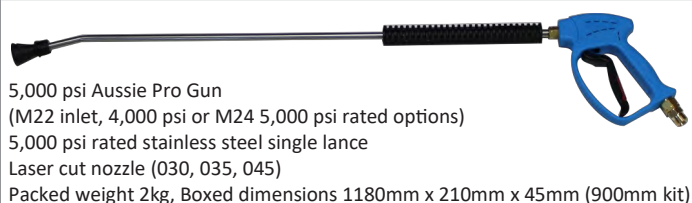

5,000 psi Aussie Pro Gun (M22 inlet, 4,000 psi or M24 5,000 psi rated options)  
5,000 psi rated stainless steel single lance  
Laser cut nozzle (030, 035, 045)  
Packed weight 2kg, Boxed dimensions 1180mm x 210mm x 45mm (900mm kit)

	lance	nozzle	single buy	10 pack buy (each)
APROGUN-900-030	900mm	030	<b>\$175</b>	\$131
APROGUN-900-035	900mm	035	<b>\$175</b>	\$131
APGUN-900-035M24	900mm	035	<b>\$186</b>	\$140
APROGUN-900-045	900mm	045	<b>\$175</b>	\$131
APGUN-900-045M24	900mm	045	<b>\$186</b>	\$140
APROGUN-1200-035	1200mm	035	<b>\$188</b>	\$141
APROGUN-1200-045	1200mm	045	<b>\$188</b>	\$141

### Aussie Drain Cleaning Kit

Convert your pressure washer to a drain cleaning jetter.  
Includes Aussie Viper Mini Reel with 60 metres of 3/16" sewer hose. Full Aussie Jetters Tool Box, including quick coupler to fit to end of blaster high pressure hose and safety plate.  
ADRAINKIT **\$3,338**



### PRO TURBO GUN KITS ... FAST CHANGEOVER



**Up to 3,500 psi, boosts EWP to max 4,785 psi\* (All Brands)**  
CTN255-030GLK suits AB30 (M22) **\$309**  
**Up to 5,000 psi, boosts EWP to max 8,500 psi\* (All Brands)**  
CTN400-035GLK suits Scud 400, Atlas (M22) **\$430**  
CTN400-050GLK suits Ultra A, Mon 400M (M22) **\$430**  
CTN400-035GLKM24 Pred A, Hurricane (M24) **\$441**  
CTN400-045GLKM24 Pred A diesel (M24) **\$441**  
**Call for bulk pricing** (\*dependant on pump capability)

### VALUE ADD EVERY HIRE

Aussie HP accessories save water, save time & save labour.

Hose reels .... P 72  
Trolley hose reels ... p 72  
Telewands ... p 76  
Flat surface cleaners ... p 74

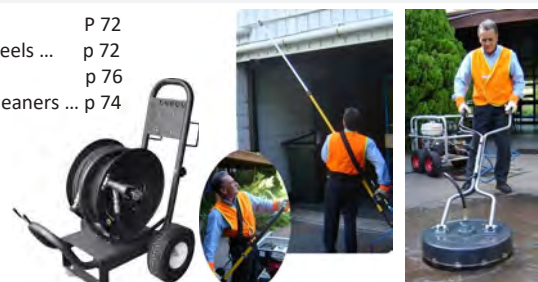



## HOT WATER ELECTRIC ... NEW AUSSIE SIZZLER .... HOT WASH

**STAINLESS STEEL**



Shown with optional protective cage

- ◆ Heavy duty triplex brass pump
- ◆ Slow speed 4 pole motor with thermal cut out
- ◆ Double loop mild steel coil
- ◆ Max temp set to 80°C
- ◆ Four wheels for mobility
- ◆ 18 litre diesel fuel tank
- ◆ Delayed Total Stop for auto shut down of machine when gun not in use.
- ◆ 10 metres of HP hose
- ◆ Pro gun with stainless steel lance & laser cut nozzle
- ◆ Optional protective stainless steel cage with lifting bar ... AFRAMES/SIZZLER ... \$743

### Specifications

	Pressure	EWP with turbo	Flow	Motor	Pump	Nozzle size	Weight	Unit dimensions (Lxwxh) mm
<b>Aussie Sizzler</b>	1,800 psi (130 bar)	3,100 psi	10 lpm	240v, 2.7kW, 4 pole	Interpump	035	100 kg	820 x 630 x 870

### Stock codes & prices

<b>Aussie Sizzler</b>	FS-D1310P4M	<b>\$4,773</b>
-----------------------	-------------	----------------

Industrial steam cleaners also available ... pages 39-40

### Accessories supplied with machine (with replacement price)

Gun/lance/nozzle kit	APOGUN-1200-045	<b>\$188</b>
Hose kit (10m hot water rated)	AKENHOSEKIT2	<b>\$236</b>

## HOT WATER HONDA ... AUSSIE HEATWAVE ... MOBILE STEAM CLEANER



- ◆ Compact, portable hot water pressure washer, just connect to the tap.
- ◆ 12 volt, diesel fired burner
- ◆ Honda GX390 petrol engine
- ◆ Spiralast coil with lifetime warranty
- ◆ Flat free tyres on steel wheels
- ◆ Stainless steel frame with integrated handle
- ◆ Direct drive industrial triplex pump
- ◆ Integrated burst disc and safety relief valve
- ◆ Hose & pro accessories
- ◆ Battery ordered separately

### Specifications

	Safety Class	Pressure	Flow	Max Temp	Honda Engine	Pump	Weight	Dimensions (LxWxH) m
<b>Aussie Heatwave</b>	A	4,000 psi (275 bar)	13 lpm	130°C	GX390 e/start	AR triplex (3200 rpm)	165 kg	1.2x0.7x0.9

### Stock codes & pricing

<b>Aussie Heatwave</b>	HSM40004HH	<b>\$10,820</b>
------------------------	------------	-----------------

### Accessories supplied with machine

Hose	AHW06M22X2X15	15m R2 3/8"
Gun	CGPDG5010	5,000 psi pro gun
Lance	C3924.01	700mm dual lance
Nozzle	C915__ _Q	Quick tip nozzle

## AUSSIE INDUSTRIAL WET/DRY VACS ... HIRE HEROS

- ◆ Impact resist polypropylene barrel
- ◆ Heavy duty wheel kit
- ◆ Professional 40mm accessory kit
- ◆ Unique Aussie Microweb ... 99.9% filtration, reusable filter
- ◆ 7 metre durable power cable

**FREE**  
Microweb filter  
...99.9% filtration



Model	S/code	Capacity	Motor	Water lift	Air Flow	
<b>VC61</b>	VC61	50 litres	1 x 1200 watt, 10 amp plug	2200 mm	70 l/s	<b>\$754</b>
<b>VC72</b>	VC72	75 litres	2 x 1200 watt, 10 amp plug	2400 mm	119 l/s	<b>\$933</b>
<b>VC73</b>	VC73	75 litres	3 x 1200 watt, 15 amp plug	2600 mm	181 l/s	<b>\$1,078</b>

Check out the full range including Jumbos & pump out vacs .... Page 99 onwards



HIRE SPEC

6



## PUMP MOTOR GROUPS

Build your own truck, ute or trailer mounted high pressure water blaster or drain cleaning jetter.

- ◆ 'Big Berty' Bertolini triplex pump
- ◆ Unloader
- ◆ Safety valve
- ◆ Pressure gauge
- ◆ Heavy duty inlet filter
- ◆ High pressure gun & lance

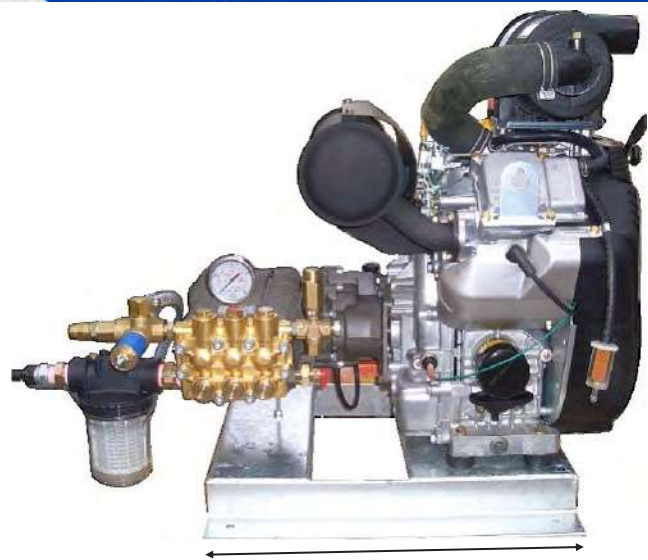

Supplied on gal base

Dimensions of gal base  
540mm (W) x 550mm (L)

### PETROL

Model	Stock code	Safety Class	Pump model	Engine	Pump Pressure (psi)	Flow (lpm)	Weight (kg)	List Price
BB100 PM	ABB100GX200NF	A	WBL1114	Honda GX200	2,000 (140 bar)	11	45	<b>\$1,840</b>
BB350 PM	ABB350/GX390NF	A	TTL1520	Honda GX390	3,000 (210 bar)	15	90	<b>\$3,128</b>
BB400 PM	ABB400/GX390PM	A	TTL1330	Honda GX390	4,000 (275 bar)	15	90	<b>\$3,692</b>
ULTRA PM*	ABBULTRA(PM)	A	TTK2130	Honda GX630	4,300 (300 bar)	20	110	<b>\$6,180</b>
PYTHON PM*	ABBPYTHON(PM)	B	Premium RAS4482	Vanguard 31HP	4,300 (300 bar)	31	90	<b>\$8,172</b>
PREDATOR A PM	ABPREDATOR+N/F	A	KTL1635	Honda GX630	5,000 (350 bar)	20	120	<b>\$6,972</b>
PREDATOR + PM*	ABPRED+VANPMG	B	Premium RAL2535	Vanguard 27HP	5,000 (350 bar)	25	120	<b>\$7,693</b>
RAPTOR 18 PM*	ABRAPTORSC18PM	B	RA1850	Vanguard 35HP	7,300 (500 bar)	18	128	<b>\$10,664</b>



### DIESEL

Model	Stock code	Safety Class	Pump model	Engine	Pump Pressure (psi)	Flow (lpm)	Weight (kg)	List Price
BB100 DPM	ABB100/L48ENF	A	WBL1114	Yanmar L48E	2,000 (140 bar)	11	65	<b>\$4,205</b>
BB350 DPM	ABB350/L100ENF	A	TTL1520	Yanmar L100E	3,000 (210 bar)	15	115	<b>\$6,935</b>
BB400 DPM	ABB400/L100ENF	A	TTL1330	Yanmar L100E	4,000 (275 bar)	15	115	<b>\$7,280</b>
PREDATOR A DPM	ABPREDKDEPMG	A	KTL1635	Kohler KD477 23HP	5,000 (350 bar)	20	250	<b>\$11,693</b>
RAPTOR 16 DPM*	ABRAPTORSC16DPM	B	RA1650	Kohler KD477 23HP	7,300 (500 bar)	16	250	<b>\$13,937</b>

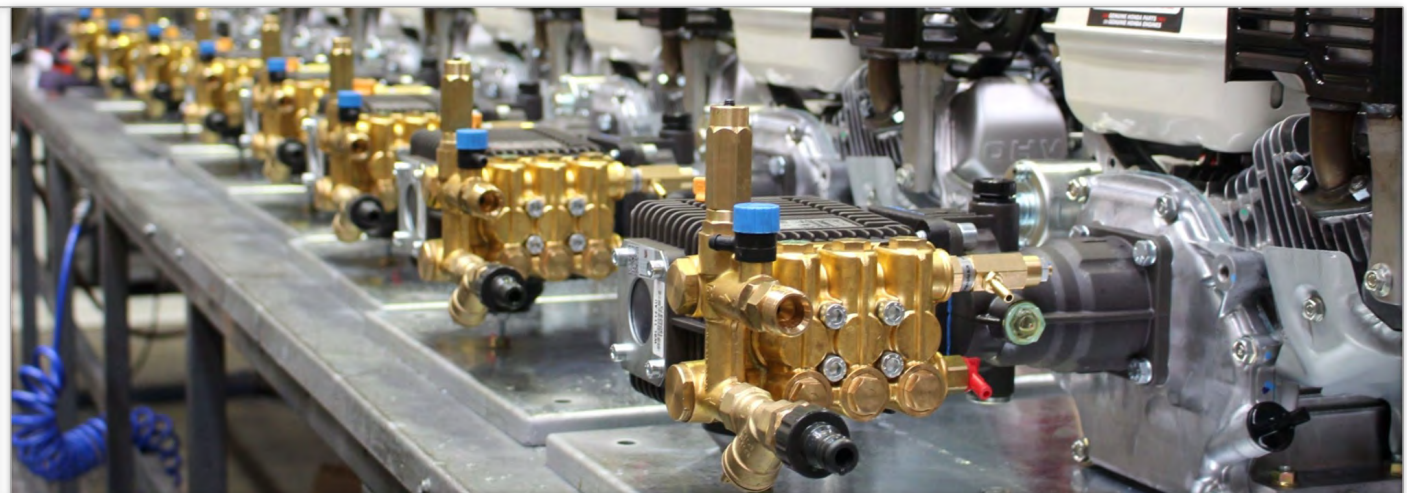



### 3,000 - 5,000 PSI

mobile, flexible installations, trenchless excavation



**BERTOLINI**  
pumps  
4 year warranty

**CLASS A BLASTER**  
AS/NZS 4233.1  
No RTO certification required for operators

#### HYDRAULIC DRIVE ... CLASS A

Hydraulic drive high pressure blasters for mobile applications, i.e. truck mounting for on-site cleaning, hydraulic concrete pumps, garbage trucks, drillers, marine applications, non destructive digging.

Non fumes, no sparks, unlimited power!

- ◆ "Big Berty" Bertolini pump ... **4 YEAR WARRANTY**
- ◆ **Top quality hydraulic motor**

- ◆ **FREE ASP (Aussie Safety Protection) kit**, includes unloader & safety valve. Protects operator & machine against pressure spikes
- ◆ **FREE heavy duty, brass inlet strainer**
- ◆ **FREE wash down kit** including gun, lance & 10m hose
- ◆ **Optional 30 metre hose reel kit** (see below)

Hydraulic drive range to 7,300 psi available ... call for more options.

#### Specifications

	Pump Pressure	Turbo EWP	Flow	Motor	Rqd Hyd Pressure	Rqd Hyd Flow	Pump	Nozzle size	Weight
THY2715/HYD	2,175 psi (150 bar)	3,500 psi	27 lpm	Salami	1450 psi	38 lpm	THY2715	035	15 kg
WHY1520/HYD	3,000 psi (200 bar)	4,785 psi	15 lpm	Salami	1160 psi	38 lpm	WHY1520	035	12 kg
TTL1330/HYD	4,300 psi (300 bar)	7,000 psi	13 lpm	Casappa PLM 30 22	2900 psi	38 lpm	TTL1330	035	35 kg
TTL2028/HYD	4,000 psi (275 bar)	6,485 psi	20 lpm	Casappa PLM 30 34	2900 psi	60 lpm	TTL2028	050	40 kg
KTL1635/HYD	5,000 psi (350 bar)	8,500 psi	16 lpm	Casappa PLM 30 34	2900 psi	60 lpm	KTL1635	035	40 kg

#### Stock codes & pricing

THY2715/HYD	BTHY2715/HYDKIT	<b>\$2,475</b>
WHY1520/HYD	BWHY1520HYD-KIT	<b>\$2,580</b>
TTL1330/HYD	BTTL1330/HYDKIT	<b>\$3,940</b>
TTL2028/HYD	BTTL2028/HYDKIT	<b>\$4,635</b>
KTL1635/HYD	BKTL1635/HYDKIT	<b>\$5,240</b>



Note: requires installation by a qualified hydraulics engineer .... over speeding will cause pump damage

#### Accessories supplied with machine

	Up to 4,000 psi		Over 4,000 psi	
Hose	AHW06M22X2X10	10m R2 3/8"	AHW06M22X2X10	10m R2 3/8"
Gun	M4022209003	AL55 4,500 psi Pro Gun	MPA30450010	RL56 5,100 psi PA gun
Lance	C3924.01	700mm Dual Lance	MPA40025800	800mm PA single lance
Nozzle	C915035M C915500MSS	2 x Laser Cut (15" & detergent)	C915045M	Laser cut nozzle

#### Optional accessories FASTER, SMARTER, SAFER

##### Turbo Lance ... 60% MORE BITE p 59

Increase the effective working pressure (EWP) of your blaster without loading the pump!



M4042100004	(up to 3,000 psi)	<b>\$157</b>
CTN310-___	(up to 4,000 psi)	<b>\$262</b>
CTN400-___	(up to 5,000 psi)	<b>\$394</b>

##### Tele-wand ... REACH further p 76

Ideal for reaching eaves & washing windows, extends to 5.5m, includes FREE harness. Quik Tip nozzle sold separately.



AGPDLTG18	<b>\$431</b>
AGPDLTG18A Heavy duty	<b>\$502</b>
QT nozzle C915___Q	<b>\$20</b>

(insert nozzle size)

##### CLEAN FLAT SURFACES FAST p 74

**SLASH CLEANING TIMES BY 75%**  
Clean flat surfaces four times faster, leaving a streak free finish. Standard nozzles included.



AGPDFSC20	20" Spinner	<b>\$1,247</b>
AGPDFSCS22Z	22" Cyclone	<b>\$1,565</b>

##### Trenchless Excavation ... TURBO HEADS TO 500 BAR p 59

Guns/lances & couplings for No dig excavations ... p56 onwards

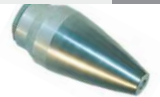

##### Extra length hose ... CONVENIENT p 70

Cleaning large plant?... reach further with these extra length **Aussie Blue-Pro** hoses, 5,800 psi rated, R2 wire braid hose, 3/8 female ends (M22 & M24 couplings sold separately)



AHW06FB6FB6X20	(20m)	<b>\$330</b>
AHW06FB6FB6X30	(30m)	<b>\$499</b>
AHW06FB6FB6X50	(50m)	<b>\$772</b>
M212003540	(M22 QC)	<b>\$21 (2 required)</b>
MPA26065050	(M24 QC)	<b>\$40 (2 required)</b>

##### 4,000 psi Hose Reel Kit .. EASY FIT p 72

Safer & smarter working, includes reel, 30m double wire braid hose, whip hose & mounting plate



ADHR40100D	(hose reel kit)	<b>\$845</b>
------------	-----------------	--------------

##### Drain Clearing Kit, SAFE & SIMPLE p 73

Includes **Aussie Viper Mini Reel** with 60 metres of 3/16" sewer hose. Full **Aussie Jettors Tool Box**, including quick coupler to fit to end of blaster high pressure hose. **Includes Safety Plate.**



ADRAINKIT	<b>\$3,285</b>
-----------	----------------



# AUSSIE JETTERS

drain cleaning revolution

DRAIN CLEANING JETTERS

6



## PLUMBERS TELL US IT'S THE END OF THE EEL

Jetters are more capable, faster & do a better job than mechanical drain cleaning machines.

- ☑ 60m reach
- ☑ Clear blockages with minutes
- ☑ Wash & flush as they clear

SMART PLUMBERS USE JETTERS



### HONDA JETTERS CLASS A

OPERATOR CERTIFICATION NOT REQUIRED

#### COBRA A SERIES

4,000 PSI  
**\$9,482**



FREE SAFETY PLATE  
(valued at \$225)



**CLASS A  
BLASTER**  
AS/NZS 4233.1



King Cobra A  
cube frame



**BERTOLINI**  
pumps  
4 year warranty



King Cobra A  
trolley frame



Optional accessories  
**FASTER, SMARTER, SAFER**

#### Viper Mini Reel ... REMOTE CONTROL

Leave your jetter in the ute & extend your reach to 120m (60m on jetter & 60m on mini reel)

- Stainless steel stand/handle
- Integrated on/off valve that allows remote control of jetter
- 60m of Redflex 3/16" sewer hose
- Three nozzle holders
- Pressure gauge



AMINIREEL/WHOSE **\$2,040**

#### Aussie Super Worm Hose (15 metres)

3/4", 5,000 psi rated, super flexible sewer hose, ideal for small drains and tight bends.

Complete with compressor nozzle & quick fit tail. (1/8 BSP M ends)



AHOSE8 1/8 15M **\$436**

#### SECURE YOUR JETTER ... COBRA LOC

Heavy duty galvanised steel  
Easy bolt down to vehicle  
Secures Cobra jetter in transit  
Eliminates frame stress  
Facilitates quick release for jetter maintenance  
Pad lockable



ACRADLECOBRA  
**\$497**



POWERED by  
**HONDA**

- ♦ "Big Berty" Bertolini heavy duty pump designed for continuous service
- ♦ Genuine Honda electric start industrial twin cylinder engine
- ♦ 30 litre stainless steel break tank with cut off float and low water cut out pump protection
- ♦ NEW stainless steel trolley frame designed to fit through doorways
- ♦ NEW stainless steel Cube version, smaller footprint, for permanent mounting on a ute ... comes complete with Cobra Loc. (no wheels)
- ♦ 12 litre fuel tank
- ♦ FREE ASP (Aussie safety protection) kit
- ♦ NEW 5,000 psi rated steel hose reel
- ♦ 60 m 3/4" R8 high quality sewer hose
- ♦ FREE 7 piece Aussie Jettors Nozzle box
- ♦ FREE Safety eyewear

Specifications

	Pressure	EWP with turbo	Flow lpm	Engine	Clears drains to	Pump	Nozzle size	Weight
<b>Cobra A</b>	4,000 psi (275 bar)	6,485 psi	20	Honda E/S GX630	6" (150mm)	TTL2028	050	130 kg
<b>King Cobra A</b>	5,000 psi (350 bar)	8,500 psi	16	Honda E/S GX630	7" (180mm)	KTL1635	035	130 kg

	Trolley			Cube		
	Unit	Dim (Lxwxh) mm	Price	Unit	Dim (Lxwxh) mm	Price
<b>Cobra A</b>	ABSSCOBRA-A	900x600x1330	<b>\$9,482</b>	ABSSCOBRA-A-CUBE	850x563x1230	<b>\$9,482</b>
<b>King Cobra A</b>	ABSSCOBRAK-A	900x600x1330	<b>\$10,460</b>	ABSSCOBRAK-A-CUBE	850x563x1230	<b>\$10,460</b>

Accessories supplied with machine

Hose	AHOSE RF8-60M	60M R8 3/4" sewer hose
Gun	CGPDG5010	5,000 psi pro gun
Lance	C3905.15	900mm single lance
Nozzle	AD NOZZLE BOX	Full 7 piece nozzle box
Safety plate	AD MSP	Covers drain entrance

Click or scan QR code for Aussie Jetter handover video



# HONDA JETTERS ... CLASS B

**RTO CERTIFICATION REQUIRED**

## COBRA B SERIES

- Genuine **Honda** electric start industrial twin cylinder engine with emergency stop fitted
- **"Big Bert"** Bertolini heavy duty pump designed for continuous service
- **NEW stainless steel frame** designed to fit through doorways
- **Cube version**, smaller footprint, for permanent mounting on a ute ... comes complete with Cobra Loc. (no wheels)
- **30 litre stainless steel break tank** with cut off float and low water cut out pump protection
- **12 litre fuel tank**
- **FREE ASP** (Aussie safety protection) kit
- **FREE hose restraint & safety plate**
- **5,000 psi** rated steel hose reel
- **60 m 3/4" R8** high quality sewer hose
- **FREE 7 piece Jetters Nozzle box**
- **FREE Safety eyewear**



Emergency stop fitted standard on all Class B jetters

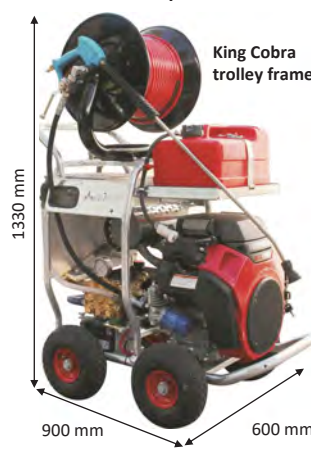

6



Specifications

	Pressure	EWP with turbo	Flow lpm	Engine	Clears drains to	Pump	Nozzle size	Weight
<b>King Cobra</b>	5,000 psi (350 bar)	8,500 psi	20	Honda E/S GX690	7" (180mm)	Premium RAL2035	045	135 kg
<b>NEW King Cobra I</b>	5,000 psi (350 bar)	8,500 psi	25	Honda E/S EIGX800	8" (200mm)	Premium RAL2535	055	150 kg

Frame options

			Unit Dim (Lxwxh) mm	
<b>King Cobra</b>	ABSSCOBRAKINGMK2	Trolley frame	900x600x1330	<b>\$11,395</b>
	ABSSCOBRAKINGCUBE	Cube Frame	850x563x1230	<b>\$11,395</b>
<b>King Cobra I</b>	ABSSCOBRA-K-I-CUBE	Cube Frame	tba	<b>\$12,895</b>

Accessories supplied with machine

Hose	AHOSE RF8-60M	60M R8 3/4" sewer hose
Gun	CGPDG5010	5,000 psi pro gun
Lance	C3905.15	900mm single lance
Nozzle	AD NOZZLE BOX	Full 7 piece jetters nozzle box
Safety plate	AD MSP	Covers drain entrance
Hose restraint	AD HRSS8	Suits 1/4" hose

Click or scan QR code for Aussie Jetter handover video



Pump service kits ... p87 - 88

### Optional accessories FASTER, SMARTER, SAFER

#### Viper Mini Reel ... REMOTE CONTROL

Leave your jetter in the ute & extend your reach to 120m (60m on jetter & 60m on mini reel)

- Stainless steel stand/handle
- Integrated on/off valve that allows remote control of jetter
- 60m of Redflex 3/16" sewer hose
- Three nozzle holders
- Pressure gauge



AMINIREEL/WHOSE **\$2,040**

#### Aussie Super Worm Hose (15 metres)

3/4", 5,000 psi rated, super flexible sewer hose, ideal for small drains and tight bends. Complete with compressor nozzle & quick fit tail. (1/8 BSP M ends)



AHOSE8 1/8 15M **\$436**

#### SECURE YOUR JETTER ... COBRA LOC

Heavy duty galvanised steel Easy bolt down to vehicle Secures Cobra jetter in transit Eliminates frame stress Facilitates quick release for jetter maintenance Pad lockable



ACRADLECOBRA **\$497**



#### FOOT VALVE ... MORE CONTROL

350 bar foot valve adds a second level of operator control, in addition to gun trigger (complies with new safety standards for Class B machines)



AST350-2605	(foot valve)	<b>\$625</b>
AD MFVPH	(whip hose kit)	<b>\$188</b>
AD HT12-M	(QC plug)	<b>\$34</b>
C20024550	(SS QC)	<b>\$67</b>

#### LOW PRESSURE REEL WITH SUPPLY HOSE

Top quality low pressure steel reel with 30m of 3/4" supply hose

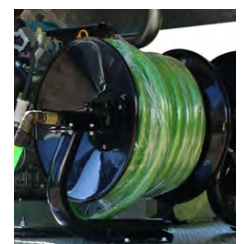

A4418-LP ASSY **\$906**

### VANGUARD JETTERS

CLASS B .... RTO CERTIFICATION REQUIRED



#### COBRA VANGUARD SERIES

- Genuine industrial twin Vanguard petrol engine with emergency stop fitted
- "Big Bert" Bertolini heavy duty triplex pump
- 30 litre stainless steel break tank with cut off float and low water cut out pump protection
- Stainless steel frame with anti-vibration mounts with 10" pneumatic wheels with sealed bearings
- 5,000 psi rated hose reel with 60m 3/4" R8 high quality sewer hose
- ASP (Aussie Safety Protection) including unloader valve & safety valve.
- FREE 7 piece Jetters Nozzle box
- FREE hose restraint & safety plate
- FREE Safety eyewear
- Cube options available ... call for details



Emergency stop fitted

Specifications

	Pressure	EWP with turbo	Flow lpm	Engine	Clears drains to	Pump	Nozzle size	Weight
<b>King Cobra Vanguard</b>	5,000 psi (350 bar)	8,500 psi	25	Vanguard 27 HP electric start	8" (200mm)	Premium RAL2535	055	140 kg
<b>Python Vanguard</b>	4,300 psi (300 bar)	6,785 psi	31	Vanguard 31 HP electric start	9" (230mm)	Premium RAS4482	070	150 kg

Stock codes & pricing

	Unit Dimensions (Lxwxh) mm		
<b>King Cobra Vanguard</b>	ABSSCOBRAKVAN	Stainless Steel Frame	1020 x 600 x 1330 <b>\$11,584</b>
<b>Python Vanguard</b>	ABSSPYTHON	Stainless Steel Frame	1020 x 600 x 1330 <b>\$12,919</b>

Accessories supplied with machine

King Cobra			Python ... BIG FLOW, BIG HOSE		
Hose (60M)	AHOSE RF8-60M	3/4" sewer hose	AHOSE8 3/8 60M	3/8" sewer hose	
Gun	CGPDG5010	5,000 psi pro gun	CGPDG5010	5,000 psi pro gun	
Lance	C3905.15	900mm single lance	C3905.15	900mm single lance	
Nozzle	AD NOZZLE BOX	Full 7 piece jetters nozzle box	AD NOZZLE BOX AD BT6R1F10 AD SD6R1F10	Full 7 piece nozzle box Bandit 3/8" Nozzle Screwdriver 3/8" nozzle	
Safety plate	AD MSP	Covers drain entrance	AD MSP	Covers drain entrance	
Hose restraint	AD HRSS8	Suits 1/4" hose	AD HRSS10	Suits 3/8" hose	

Pump service kits ... p87 - 88

#### Optional accessories FASTER, SMARTER, SAFER

##### Viper Mini Reel ... REMOTE CONTROL

Leave your jetter in the ute & extend your reach to 120m (60m on jetter & 60m on mini reel)

- Stainless steel stand/handle
- Integrated on/off valve that allows remote control of jetter
- 60m of Redflex 3/16" sewer hose
- Three nozzle holders
- Pressure gauge



AMINIREEL/WHOSE (suits King Cobra) **\$2,040**

AMINIREELWH1/4" (suits Python) **\$2,153**

##### Aussie Super Worm Hose (15 metres)

3/4", 5,000 psi rated, super flexible sewer hose, ideal for small drains and tight bends.

Complete with compressor nozzle & quick fit tail. (1/8 BSP M ends)



AHOSE8 1/8 15M

**\$436**

##### SECURE YOUR JETTER ... COBRA LOC

Heavy duty galvanised steel  
Easy bolt down to vehicle  
Secures Cobra jetter in transit  
Eliminates frame stress  
Facilitates quick release for jetter maintenance  
Pad lockable



ACRADLECOBRA

**\$497**

##### FOOT VALVE ... MORE CONTROL

350 bar foot valve adds a second level of operator control, in addition to gun trigger (complies with new safety standards for Class B machines)



AST350-2605	(foot valve)	<b>\$625</b>
AD MFVPH	(whip hose kit)	<b>\$188</b>
AD HT12-M	(QC plug)	<b>\$34</b>
C20024550	(SS QC)	<b>\$67</b>

##### LOW PRESSURE REEL WITH SUPPLY HOSE

Top quality low pressure steel reel with 30m of 3/4" supply hose



A4418-LP ASSY **\$906**



Click or scan QR code for Aussie Jetter handover video

### COBRA TRAILER JETTS ... READY, SET, JET (CLASS A & B OPTIONS)

DRAIN CLEANING JETTERS



**Drains to 230mm 9"**

Trailer Jett shown with optional gal roof



Professional, self contained, trailer or skid mounted high pressure water jetting systems, ideal for cleaning drains up to 9 inches. Can also double as a high pressure, high flow water blaster.

- ◆ 'Big Bertie' heavy duty triplex pump
- ◆ Industrial Honda or Vanguard twin cylinder engine with Emergency stop fitted
- ◆ 200 litre Rapid Spray poly tank, UV resistant
- ◆ Low pressure supply hose reel with 30m of 3/4" low pressure hose
- ◆ 60m of high quality 5,000psi rated jetting hose, fitted to steel hose reel for jetting straight off trailer
- ◆ Full 7 piece nozzle kit including Aussie Turbo Root Mulcher nozzle
- ◆ Aussie Viper Mini Reel with 60m of 3/16" Redflex sewer hose
- ◆ FREE hose restraint & safety plate
- ◆ FREE Safety eyewear

Call for details of diesel powered options.

Trailer specs ...

Heavy duty Australian made hot dipped galvanised single axle trailer ...

- ◆ New tyres & wheels (spare included)
- ◆ Heavy duty jockey wheel,
- ◆ VIN number & blue slip ready for registration
- ◆ Heavy duty lockable toolbox
- ◆ Optional gal roof for weather protection (+\$1,362<sup>+GST</sup>)

6

Specifications

	Safety Class	Pressure	EWP with turbo	Flow	Engine	Clears drains to	Pump	Nozzle size
King Cobra A	A	5,000 psi (350 bar)	8,500 psi	16 lpm	Honda GX630 electric start	6" (150mm)	KTL1635	035
King Cobra	B	5,000 psi (350 bar)	8,500 psi	20 lpm	Honda GX690 electric start	7" (180mm)	KTL2035	045
<b>NEW</b> King Cobra I	B	5,000 psi (350 bar)	8,500 psi	25 lpm	Honda IGX800 electric start	8" (200mm)	Premium RAL2535	055
King Cobra Vanguard	B	5,000 psi (350 bar)	8,500 psi	25 lpm	Vanguard 27 HP electric start	8" (200mm)	Premium RAL2535	055
Python Vanguard	B	4,300 psi (300 bar)	6,785 psi	31 lpm	Vanguard 31 HP electric start	9" (230mm)	Premium RAS4482	070

Pricing

	Trailer mount (approx. weight 550kg)			Skid Mount		
		Dimensions			Dimensions	
King Cobra A	ABBCOBRACING-A-T	3.8m x 1.7m x 1.5m	\$19,215	ABBCOBRACING-A-S	3m x 1.25m	\$17,035
King Cobra	ABBCOBRACINGTR	3.8m x 1.7m x 1.5m	\$20,560	ABBCOBRACKINGSM	3m x 1.25m	\$18,227
King Cobra I	ABBCOBRA-K-I-TR	3.8m x 1.7m x 1.5m	\$21,473	ABBCOBRA-K-I-SM	3m x 1.25m	\$18,988
King Cobra Vanguard	ABBCOBRACINGVTR	3.8m x 1.7m x 1.5m	\$21,473	ABBCOBRACKINGVSM	3m x 1.25m	\$18,988
Python Vanguard	ABBPYTHONTR	3.8m x 1.7m x 1.5m	\$27,758	ABBPYTHONSM	3m x 1.25m	\$25,239

Accessories supplied with machine

King Cobra			Python ... BIG FLOW, BIG HOSE		
Hose (60M)	AHOSE RF8-60M	3/4" sewer hose	AHOSER8 3/8 60M	3/8" sewer hose	
Gun	CGPDG5010	5,000 psi pro gun	CGPDG5010	5,000 psi pro gun	
Lance	C3905.15	900mm single lance	C3905.15	900mm single lance	
Mini Reel	AMINIREEL/WHOSE	60M 3/16" sewer hose on a Remote Mini Reel	AMINIREEL/WHOSE	60M 1/4" sewer hose on a Remote Mini Reel	
Nozzle	AD NOZZLE BOX	Full 7 piece jettors nozzle box	AD NOZZLE BOX AD BT6R1F10 AD SD6R1F10	Full 7 piece nozzle box Bandit 3/8" Nozzle Screwdriver 3/8" nozzle	
Safety plate	AD MSP	Covers drain entrance	AD MSP	Covers drain entrance	
Hose restraint (Class B only)	AD HRSS8	Suits 1/4" hose	AD HRSS10	Suits 3/8" hose	



Click or scan QR code for Aussie Jetter handover video

### HOT WATER JETTERS ... CLEAR GREASE LINES WITH EASE!

**NEW**

- ◆ **Heavy duty** triplex pump (1 year warranty)
- ◆ **Adjustable temperature** up to 130° C, steam melts grease without using chemicals.
- ◆ **Spiralast coil** with lifetime warranty
- ◆ Water tight electrical box with battery. (Battery not included)
- ◆ **COMPACT**, robust "Pro-TECT" steel frame with built-in lifting eyes for transportation
- ◆ Stainless steel panels and boiler cover.
- ◆ Full 7 piece nozzle kit (Mustang) including Aussie Turbo Root Mulcher nozzle
- ◆ Aussie Viper Mini Reel with 60m of 3/16" Redflex sewer hose
- ◆ Skid mount option with 700 litre water tank & hose reels
- ◆ Safety Plate & safety eye wear included



**CLASS A BLASTER**  
AS/NZS 4233.1

HSS40005HH



Includes Viper Mini Reel

#### Specifications

	Safety Class	Pressure	EWP with turbo	Flow	Max Temp	Engine	Clears drains to	Pump	Weight
<b>NEW HSS40005HH</b>	A	4,000 psi (275 bar)	6,485 psi	18 lpm	130°C	Honda GX630	6" (150mm)	General Pump EZ4040G	204 kg

#### Stock codes & prices

		Unit Dimensions (Lxwxh) m	
<b>HSS40005HH</b>	HSS40005HHJ	1.2x0.66x1.02	<b>\$20,492</b>

#### Accessories supplied with machine

Hose	AHW06M22X2X10	10m R2 3/8"
Gun	CGPDG5010	5,000 psi pro gun
Lance	C3905.15	900mm single lance
Mini Reel	AMINIREEL/WHOSE	60M 3/16" sewer hose on a Remote Mini Reel
Nozzle	AD NOZZLE BOX	Full 7 piece jetters nozzle box

### BUDGET MINI JETTERS ... SUPER CONVENIENT

- ◆ **2,175 psi** max pump pressure
- ◆ **3,400 psi** effective working pressure with Aussie Turbo Master turbo lance
- ◆ **Compact** design
- ◆ **Heavy duty 4 pole**, slow speed motor
- ◆ **Brass** head triplex pump
- ◆ **Pro gun** & Vario lance
- ◆ **Normal 10 amp** plug, 240 volt
- ◆ **FREE turbo lance** ... maximise your effective working pressure for fast results
- ◆ Includes 15m Aussie Super Worm flexible sewer hose & drain cleaning nozzle
- ◆ Optional heavy duty trolley kit ...  
AGP2100436 trolley \$218  
F43146 mounting kit \$17

**CLASS A BLASTER**  
AS/NZS 4233.1

#### Specifications

	Safety Class	Pump Pressure	EWP with turbo	Flow	Motor	Clears drains to	Pump	Weight
<b>Black Box with Drain Cleaning kit</b>	A	1,800 psi (124 bar)	3,400 psi	8 lpm	240v 2.6kW 4 pole	Small drains	Triplex	30 kg

#### Stock codes & pricing

	Stock codes to use	Unit Dimensions (Lxwxh) mm	
Black Box with 15m Super Worm jetting hose (& couplings)	FKB8.15 AHOSE R8 1/8_15M C1500.06 AD QR8BR2	390 x 240 x 230	<b>\$1,588</b>

#### Accessories supplied with machine

Hose	AHW06M22X2X8	8M R2 hose
Sewer hose	AHOSE R8 1/8 15M	15M R8 sewer hose with nozzle
Gun	M4021108007	AL13 pro gun
Lance	C4723.45.115	Vario lance
Turbo	M4042100004	Turbo lance
Pump service kits ... p34		



### JETTING ESSENTIALS ... ADD THEM TO YOUR LIST!

#### SECURE YOUR JETTER ... Aussie Cobra Loc

Heavy duty galvanised steel

- Easy bolt down to vehicle
- Secures Cobra jetter in transit
- Eliminates frame stress
- Facilitates quick release for jetter maintenance
- Pad lockable

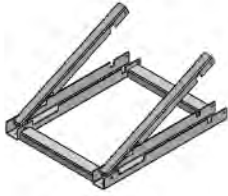

ACRADLECOBRA \$497



#### DOUBLE STACKER HOSE REEL KITS Simply to ute mount



Heavy duty powder coated steel double stacker hose reel

1. Low pressure steel reel with 30m of 3/4" supply hose
2. 5,000 psi rated reel with 60m of sewer hose.

(requires joining hoses & couplings)  
AD ARS-DSC \$2,690

Dual Stacker without hose  
AD ARS-DCNH \$1,539

Low pressure steel reel with 30m of 3/4" supply hose  
A4418-LP ASSY \$906

Bare hose reel with 5,000 psi swivel (no hose)  
A4418-REEL \$680

#### FOOT VALVE Essential for Class B safety

350 BAR foot valve adds a second level of operator control, in addition to gun trigger



AST350-2605	(foot valve)	\$625
AD MFVPH	(whip hose kit)	\$188
AD HT12-M	(QC plug)	\$34
C20024550	(SS QC)	\$67

#### AUSSIE SAFETY EYEWEAR

Aussie tinted safety glasses (ANSI Z87.1) equivalent to AS/NZS 1337



AP-SAFETYGLASSES \$10

#### SAFETY PLATE

Designed to make jetting safer & easier. Prevents operator injuries caused by jetting nozzle accidentally returning out of the drain.



AD MSP \$225

#### AUSSIE COBRA CLASS B SAFETY PACK

- Safety plate
- 500 bar safety gloves
- Foot valve with whip hose
- 500 bar hose shroud
- Hose restraint



ACOBRA SAFEKIT2 \$1,385

#### 500 BAR SAFETY GEAR (more p80)

Aussie Jet Stop boots  
ATST5652025xx \$524  
(xx = size 42-48)



Safety gloves  
ATSTP5600025xxS \$215  
(xx = size 8 or 11)



Hose Shroud  
ATST56600455920 \$252



#### AUSSIE VIPER MINI REEL ... Remote control of jetter



**BEST BUY**

Leave your jetter in the ute & extend your reach to 120m (60m on jetter & 60m on mini reel)

- Stainless steel stand/handle
- Integrated on/off valve that allows remote control of jetter
- 60m of Redflex 3/16" sewer hose or 1/4" sewer hose
- 3 nozzle holders
- Pressure gauge



AMINIREEL/WHOSE (Cobra & King Cobra) \$2,040  
AMINIREELWH1/4" (Python) \$2,153

Replacement parts

Swivel	AD MRSB	\$169
Repair kit (circlip & o-rings)	AD MNRRK	\$40
3/8" Ball valve (with handle)	MTM00089502	\$71
Ball valve extended handle only	AD BVH	\$48
Locking pin & spring	AD MNR PL	\$31

#### AUSSIE HOT LINK Converts a jetter into a hot jetter



- Suits any cold water pressure cleaner to 4,000 psi with flows to 20 lpm
- 12 volt diesel fired burner
- Built-in diesel fuel tank (11 litres).
- Flow switch control
- Requires 14 amp charge circuit
- Integrated burst disc and safety relief valve
- 2.7 metres of 5,000 psi hose
- Stainless steel frame with stainless steel boiler housing and powder coated steel chassis
- Requires a 12 volt power source

HCPHL5DC \$4,690

#### DRAIN CLEANING JETTER NOZZLE BOX Clear a full range of chokes

- Predator Penetrator Nozzle Complete
- Negotiator Invader Nozzle Complete
- Compressor Invader Nozzle with Adapter,
- Turbo Root Mulching Nozzle reverse spinning nozzle
- Nozzle Tip Cleaner
- Spare 1/4" coupler
- 3/16" allen key



GENUINE MUSTANG NOZZLES ... Australian Made



AD NOZZLE BOX \$976

Want to convert a high pressure cleaner into a jetter? See our Drain Cleaning Kit p73

DRAIN CLEANING JETTERS

6

# CLEAR IT FASTER ... REPLACE WORN NOZZLES

### PREDATOR PENETRATOR

**3 rear jets & 1 forward jet**  
It's used for general drain cleaning. The long pointed nose penetrates deep into a choke, blasting out the debris. (5,000 psi rated)  
Includes cowl & tail, use with 1/4" coupler  
AD P3R1FC **\$187**



### NEGOTIATOR INVADER

**6 rear jets & 1 forward jet** It's used for tight bends and traps. It is a good multi-purpose nozzle. (5,000 psi rated)  
Includes cowl & tail, use with 1/4" coupler  
AD N6R1FC **\$181**



### COMPRESSOR INVADER

**6 rear jets & 1 forward jet**  
Small nozzle that assists with blockages in smaller pipes. (5,000 psi rated)  
Includes cowl & tail, use with 1/4" coupler  
AD C6R1FC **\$159**



### BEAVER COMPLETE

**2 forward jets & 6 rear jets** The 2 forward jets bore deep into the choke. Ideal for dry paper chokes. (5,000 psi rated)  
Includes cowl & tail, use with 1/4" coupler  
AD BV6R2FC **\$202**



### ROOT RAT

**1 front jet & 6 rear jets**  
(3 behind the tip of the nozzle at 45° and 3 at the rear of the nozzle at 30°) Quickly penetrates chokes. (5,000 psi rated)  
Includes cowl & tail, use with 1/4" coupler  
AD RR6R1FC **\$205**



### BULLET

**1 front jet & 6 rear jets**  
It's used for tight root blockages. Although it is very effective, only use on difficult chokes as it has a habit of leaving the drain. (5,000 psi rated)  
Includes cowl & tail, use with 1/4" coupler  
AD B6R1FC **\$188**



### BANDIT (3/8")

**1 front jet & 6 rear jets**  
Designed to enter a blockage quickly and with max thrust. Suits Python jetter.  
AD BT6R1F10 **\$150**



### SCREWDRIVER (3/8")

**1 front jet & 6 rear jets**  
Designed to get through the toughest root blockages. Suits Python jetter.  
AD SD6R1F10 **\$152**



### EXTENSION BARS (for larger drains)

Designed to extend the length of a the nozzle to prevent them turning around in a pipe.



100mm	AD EXT100	\$173
150mm	AD EXT150	\$173
250mm	AD EXT250	\$195
350mm	AD EXT350	\$195

### TURBO ROOT MULCHER (drains to 6")

**Rotating rear jet**  
Used after a penetrator style nozzle has broken through the blockage. Quickly strips tree roots, grease & debris from the drain.



AD RR8TCF **\$381**

#### Replacement parts

1. Brass turbo	CTN255-055H	\$173
2. End bend	AD SS8TM	\$209
3. Male plug	AD HT8MSF	\$35

Use with extension bars for larger drains.

### DOUBLE TURBO ROOT MULCHER (for larger drains to 24")

The Double Turbo Root Mulcher nozzle has the power of 2 turbines so large pipes can be cleaned. This gives a standard jetter the power effectiveness of a larger machine without the extra cost.



AD RRDB **\$567**

#### Replacement parts

1. Brass turbo	CTN255-055H	\$173
2. End bend	AD RRDBBASE	\$321
3. Male tail	AD HT12-M	\$34

Use with extension bars for larger drains.

### COUPLERS, TAILS, CONES & ACCESSORIES

Couplers	1/4" brass	AD QR8BR2	\$45
	1/4" ss	C200245500	\$67
Tail	1/8" female	AD HT4	\$31
	1/8" male	AD HT4M	\$31
	1/4" female	AD HT8F	\$31
	1/4" male	AD HT8M	\$31
	3/8" male	AD HT12-M	\$34
Cone	1/8" plastic	AD PC4	\$22
	1/4" plastic	AD PC8	\$25
Tip cleaner		AD TC	\$22



### NEW HOSE RESTRAINT



Stainless steel **hose restraint** sock with carabiner & bracket. Connects between hose and gun or mini reel couplings. Use to restrain the hose in the event of a coupling failure.  
**Required with Class B machines** under AS/NZS4233.1

AD HRSS10 (3/8" thermoplastic hose)	<b>\$130</b>
AD HRSS8 (1/4" thermoplastic hose)	<b>\$103</b>
AHRANCHORPLATE	<b>\$8</b>
(attaches restraint to gun/lance or mini reel)	

### AUSSIE REDFLEX SEWER HOSE

The super strong thermoplastic coating means the hose is stiffer but harder wearing. (5,000 psi 1/4 BSP M ends)

- ◆ 1/4" for general drain clearing (60m)  
AHOSE RF8-60M **\$837**
- ◆ 3/16" for gullies & tight corners (60m)  
AHOSE RF6-60M **\$766**
- ◆ 3/8" for high flow jettors (60m) (3/8" M ends)  
AHOSE8 3/8 60M **\$1,019**



### AUSSIE SUPER WORM HOSE (15M)

1/2", 5,000 psi rated, super flexible sewer hose, ideal for small drains and tight bends.

Complete with compressor nozzle & quick fit tail.  
(1/8 BSP M ends)

AHOSE8 1/8 15M **\$436**





**SINGLE PHASE ELECTRIC**  
(6-20 hrs per week)

## POWERFUL | PORTABLE | PROFESSIONAL

NO FUEL, NO FUSS ... JUST PLUG & GO



FROM ONLY  
**\$1,139**

COLD WATER ELECTRIC DRIVE



**CLASS A BLASTER**  
AS/NZS 4233.1

No RTO certification required for operators

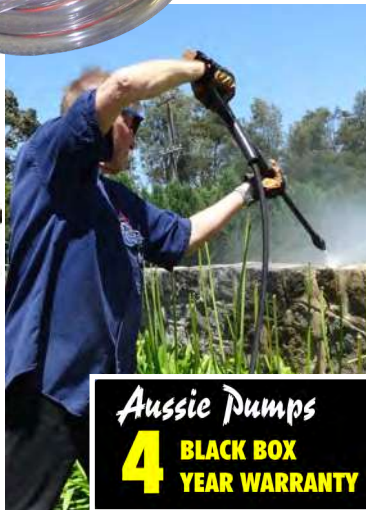

**Aussie Pumps**  
**4 BLACK BOX**  
**YEAR WARRANTY**

### BLACK BOX

- 2,175 psi max pump pressure
- 3,400 psi effective working pressure with Aussie Turbo Master turbo lance
- Compact design
- Heavy duty 4 pole, slow speed motor
- Brass head triplex pump
- Pro gun & Vario lance
- Normal 10 amp plug, 240 volt
- **FREE turbo lance** ... maximise effective working pressure for fast results
- 8m rubber wire braid professional HP hose
- **Thermal dump** to protect pump from extended by-pass running
- **Detergent injection** (not for use with 15m hose)
- Optional heavy duty trolley (supplied flat pack) and hose reel

#### Specifications

	Pump Pressure	Max rated pressure	EWP with turbo	Flow	Motor	Pump	Weight	Unit Dimensions (Lxwxh) mm
<b>Black Box</b>	1,800 psi (124 bar)	2,175 (140 bar)	3,400 psi	8 lpm	240v 2.6kW 4 pole	Triplex	30 kg	390 x 240 x 230

#### Options ... stock codes & pricing

<b>Black Box</b>	FKB8.15	<b>\$1,139</b>
<b>Black Box with Smart Cart</b>	FKB8.15TR	<b>\$1,424</b>
<b>Black Box with Smart Cart &amp; 15m hose reel</b>	FKB8.15TRHR	<b>\$2,007</b>

#### For replacement accessories use these codes ...

Hose	AHW06M22X28	8M R2 hose
Gun	M4021108007	AL13 pro gun
Lance	C4723.45.115	Vario lance
Turbo	M4042100004	Turbo lance

### Optional accessories FASTER, SMARTER, SAFER

#### Aussie Black Box with Smart Cart

**GO MOBILE ... EASY FIT TROLLEY**  
Strong & robust trolley, 10" flat free tyres, accessories holder, steel frame . (assembly required)

Black Box with trolley  
FKB8.15TR **\$1,424**



Trolley only AGP2100436 **\$236**  
BB mounting kit F43146 **\$17**

#### Black Box with Smart Cart & Reel

Aussie Black box fully optioned with trolley and 15m hose reel. Supplied with all fittings required .(assembly required)

Black Box with trolley & reel  
FKB8.15TRHR **\$2,007**



#### 15" flat surface cleaner ... SMART p 74

Clean flat surfaces three times faster, leaving a streak free finish. Steel deck.

FNA80166 (15") **\$225**  
700mm lance to suit  
FNA7103261 **\$74**



#### Drain jetting, FAST & CONVENIENT p 31

Clear drains fast with a super flexible 1/8" 15m sewer hose. Includes jetting nozzle. Couplings required (see below)

AHOSER8 1/8 15M **\$436**  
C200245500 (Quick coupler) **\$62**  
C1500.06 (M22 coupling) **\$10**



#### NEW Foamer ... SPRAY FOAM FAST p 77

LS3 foamer ...  
Spray detergents, degreasers, disinfectants without chemicals going through the pump

MPA25152612 **\$148**  
Requires coupling to fit to gun  
C1500.06 **\$10**



#### Replacement Pump kits

FAR1864	Valve kit	\$78
FAR1865	Oil seal kit	\$48
FAR1866	Water seal kit	\$120
FAR2040	O-ring kit	\$20
FAR1279225	Unloader valve	\$278





## SINGLE PHASE ... BUILT TOUGH

Fast | Effective | Simple to use

**2,000 PSI**  
**\$2,500**  
**NEW**  
STAINLESS  
STEEL FRAME



### MONSOON 140

- ◆ 'Big Bertey' heavy duty triplex pump
- ◆ Heavy duty on-off switch with motor protection. Includes circuit breaker with thermal trip & short circuit protection in IP 65 enclosure with padlocking control.
- ◆ Heavy duty 4 pole, single phase slow speed motor with 15 amp plug
- ◆ Robust stainless steel frame & anti vib mounts
- ◆ Steel wheels with flat free tyres
- ◆ FREE ASP (Aussie safety protection kit) ... Protects pump from pressure spikes and excess by-pass running
- ◆ Detergent injection
- ◆ Pro accessories
- ◆ Optional Total Stop

**BERTOLINI**  
pumps  
4 year warranty

**CLASS A BLASTER**  
AS/NZS 4233.1  
No RTO certification required for operators

#### Specifications

	Pump Pressure	EWP with turbo	Flow	Motor	Pump	Nozzle size	Stock code	List price
<b>Monsoon Scud 140</b>	2,000 psi (140 bar)	3,400 psi	9 lpm	240v 2.2kW	WBL917	035	ABMONSS140	<b>\$2,500</b>

#### Unit weight & dimensions

	Weight	Freight Dimensions (Lxwxh) mm
<b>Monsoon Scud 140</b>	52 kg	680x580x550

#### Accessories supplied with machine

Hose	AHW06M22X2X8	8M R2 hose
Gun	M4021108007	AL13 pro gun
Lance	C4723.45.115	Vario lance

Pump service kits ... p84 - 85

### Optional accessories FASTER, SMARTER, SAFER

#### Turbo Lance ... 60% MORE BITE p 59

Increase the effective working pressure (EWP) of your blaster without loading the pump!

  
CTN255-035 \$214

#### 4,000 psi Hose Reel Kit .. EASY FIT p 72

Safer & smarter working, includes reel, double wire braid hose, whip hose & mounting plate

AD30001 (15m hose)	\$565
Mounting bar to suit frame	
AHRBARSSMONSML	\$159



#### Aussie Spinner ... FLAT SURFACES p 74

SLASH CLEANING TIMES BY 75%  
20" flat surface cleaner  
Clean flat surfaces four times faster, leaving a streak free finish .... suits AB40 (standard nozzles included)

AGPDFSC20 (20")	\$1,247
-----------------	---------



#### Drain jetting, FAST & CONVENIENT p 31

Clear drains fast with a super flexible 1/8" 15m sewer hose. Includes jetting nozzle. Couplings required (see below)

AHOSER8 1/8 15M	\$436
C200245500 (Quick coupler)	\$62
C1500.06 (M22 coupling)	\$10



#### Tele-wand ... REACH FURTHER p 76

Ideal for reaching eaves & washing windows, extends to 5.5m, includes FREE harness. Quik Tip nozzle sold separately.

AGPDLTG18	\$431
Quik Tip nozzle C915035Q	\$20



#### NEW Foamer ... SPRAY FOAM FAST p 77

LS3 foamer ...  
Spray detergents, degreasers, disinfectants without chemicals going through the pump

MPA25152612	\$148
Requires coupling to fit to gun	
C1500.06	\$10



COLD WATER ELECTRIC DRIVE

6



**INDUSTRIAL 3 PHASE**  
(20 + hrs per week)

## 3,000 - 4,000 PSI ELECTRIC HEAVY DUTY | RELIABLE | CLASS A

**3,000 PSI**  
**\$3,592**  
**NEW**  
STAINLESS  
STEEL FRAME

COLD WATER ELECTRIC DRIVE



Monsoon 300

**CLASS A  
BLASTER**  
AS/NZS 4233.1

No RTO certification required for operators

### MONSOON SCUD SERIES

- ◆ 'Big Berty' heavy duty triplex pump
- ◆ Heavy duty 4 pole IP55 rated slow speed motor
- ◆ Heavy duty on-off switch with motor protection. Includes circuit breaker with thermal trip & short circuit protection in IP 65 enclosure with padlocking control.
- ◆ **NEW stainless steel frame** & anti vib mounts
- ◆ Heavy duty on-off switch with overload protection
- ◆ **FREE ASP** (Aussie safety protection kit) .. Protects pump from pressure spikes and excess by-pass running
- ◆ **Steel wheels** with flat free tyres
- ◆ Detergent injection
- ◆ Easy fit 30 m hose reel option
- ◆ Pro accessories
- ◆ 3 phase plug not supplied
- ◆ Optional Total Stop



#### Specifications

	Pump Pressure	EWP with turbo	Flow	Motor	Pump	Nozzle size	Stock code	List price
<b>Monsoon Scud 200</b>	3,000 psi (200 bar)	4,785 psi	15 lpm	415v 5.5kW 4 pole	TTL1520	045	ABMONSS200	<b>\$3,592</b>
<b>Monsoon Scud 300</b>	3,000 psi (200 bar)	4,785 psi	21 lpm	415v 7.5kW 4 pole	TTL2120	065	ABMONSS300	<b>\$4,283</b>
<b>Monsoon Scud 400</b>	4,300 psi (300 bar)	6,785 psi	13 lpm	415v 7.5kW 4 pole	TTL1330	035	ABMONSS400	<b>\$4,964</b>
<b>Monsoon Scud 400 Maxi</b>	4,000 psi (275 bar)	6,485 psi	20 lpm	415v 11kW 4 pole	TTL2028	050	ABMONSS400-A	<b>\$6,706</b>

#### Unit weights & dimensions

	Weight	Freight Dim (Lxwxh) mm
<b>Monsoon Scud 200</b>	70 kg	700x580x550
<b>Monsoon Scud 300</b>	90 kg	1100x800x750
<b>Monsoon Scud 400</b>	90 kg	1100x800x750
<b>Monsoon Scud 400 Maxi A</b>	120 kg	1100x800x750

#### Accessories supplied with machine

Hose	AHW06M22X2X10	10m R2 3/8" with couplings
Gun	M4022209003	AL55 4,500 psi Pro Gun
Lance	C3924.01	700mm Stainless Steel Dual Lance
Nozzle	C915_M C915500MSS	2 x Laser Cut (15° & detergent)

Pump service kits ... p86 - 87

### Optional accessories FASTER, SMARTER, SAFER

#### Turbo Lance ... 60% MORE BITE p 59

Increase the effective working pressure (EWP) of your blaster without loading the pump!



CTN255--_ _ _ _	(Mon 200 & 300)	\$214
CTN310--_ _ _ _	(Mon 400 & Mon 400 M)	\$262

(insert nozzle size)

#### Tele-wand ... REACH further p 76

Ideal for reaching eaves & washing windows, extends to 5.5m, includes FREE harness. Quik Tip nozzle sold separately.



AGPDLTG18	\$431
AGPDCLTG18A Heavy duty	\$502
QT nozzle C915__ _Q	\$20

(insert nozzle size)

#### CLEAN FLAT SURFACES FAST p 74

##### SLASH CLEANING TIMES BY 75%

Clean flat surfaces four times faster, leaving a streak free finish. Standard nozzles included.



AGPDFSC20	20" Spinner	\$1,247
AGPDFSCS22Z	22" Cyclone	\$1,565

#### Grit Blast Kit ... SURFACE PREP p 56

Remove paint & rust fast

M202903460	(Mon 200 & 300)	\$233
(head, lance, nozzle, probe & hose)		
MTM160172	(Mon 400)	\$359
(head, probe & hose, NB nozzle & lance required)		



#### Extra length hose ... CONVENIENT p 70

Cleaning large plant?... reach further with these extra length Aussie Blue-Pro hoses, 5,800 psi rated, R2 wire braid hose, 3/8 female ends (M22 & M24 couplings sold separately)



AHW06FB6FB6X20 (20m)	\$330
AHW06FB6FB6X30 (30m)	\$499
AHW06FB6FB6X50 (50m)	\$772
M212003540 (M22 QC)	\$21 (2 required)

#### 4,000 psi Hose Reel Kit .. EASY FIT p 72

Safer & smarter working, includes reel, 30m double wire braid hose, whip hose & mounting plate



ADHR40100D	(hose reel kit)	\$845
mounting bar		
AHRPLATEMONLRG		\$140

#### Drain Clearing Kit, SAFE & SIMPLE p 73

Includes Aussie Viper Mini Reel with 60 metres of 3/16" sewer hose. Full Aussie Jetters Tool Box, including quick coupler to fit to end of blaster high pressure hose. Includes Safety Plate.



ADRAINKIT	\$3,285
-----------	---------



**HYDRO-BLASTERS**  
(20+ hrs per week)

## 4,000 PSI & 5,000 PSI CLASS A ELECTRIC (NO RTO CERT REQUIRED)

**4,000 PSI**  
**\$7,840**  
**NEW**  
STAINLESS  
STEEL FRAME



Hurricane standard

### MONSOON 400M A & HURRICANE

- ♦ **'Big Berty'** heavy duty pumps designed for long, continuous operation at extremely high pressures.
  - ♦ **Heavy duty** on-off switch with motor protection. Includes circuit breaker with thermal trip & short circuit protection in IP 65 enclosure with padlocking control.
  - ♦ **Heavy duty, 4 pole, three phase** IP55 rated slow speed motor
  - ♦ **NEW Heavy duty stainless steel frame** with anti-vibration dampeners, big flat free tyres & steel wheels.
  - ♦ **FREE ASP** (Aussie Safety Protection) kit ... Protects pump from pressure spikes and excess by-pass running
  - ♦ Easy fit hose reel option
  - ♦ Pro accessories
  - ♦ 3 phase plug not supplied
- Aussie Mine Spec Versions include:**
- ♦ Emergency stop
  - ♦ Double insulated wire
  - ♦ Lifting bar



**BERTOLINI**  
pumps  
**4 year warranty**



**CLASS A BLASTER**  
AS/NZS 4233.1  
No RTO certification required for operators

#### Specifications

	Pump Pressure	EWP with turbo	Flow	415v Motor	Pump	Nozzle size	Stock code	List price
<b>Hurricane A</b>	5,000 psi (350 bar)	8,500 psi	16 lpm	12.5kW	KTL1635	035	ABHURRICANESS	<b>\$7,940</b>

#### NEW Mine Spec Versions

<b>Monsoon 400 Maxi A MS</b>	4,000 psi (275 bar)	6,485 psi	20 lpm	11kW	TTL2028	050	ABMONSS400MMS	<b>\$7,840</b>
<b>Hurricane A MS</b>	5,000 psi (350 bar)	8,500 psi	16 lpm	12.5kW	KTL1635	035	ABHURRICANESSMS	<b>\$8,720</b>

#### Unit weight & dimensions

	Weight	Freight Dim (Lxwxh) mm
<b>Monsoon 400 Maxi A</b>	120 kg	1100x800x750
<b>Hurricane A</b>	145 kg	1100x800x450

#### Accessories supplied with Hurricane

Hose	AHW06FB6FB6X10	10m R2 3/8"
Gun	MPA30450010	RL 56 5,000 psi pro gun
Lance	MPA40025800	800mm single lance
Nozzle	C915035M	Laser cut nozzle

Pump service kits ... p86 - 87

### Optional accessories FASTER, SMARTER, SAFER

#### Turbo Lance ... 60% MORE BITE p 59

Turbo lance/gun kit... Increase the effective working pressure of your blaster!



CTN400-050GLK \$430  
CTN400-035GLKM24 \$441

#### Grit Blast Kit ... SURFACE PREP p 76

Remove paint & rust fast (head, probe & hose, NB nozzle & lance required)



MTM160172 \$359

#### CLEAN FLAT SURFACES EXTRA FAST p 75

##### SLASH CLEANING TIMES

Aussie 28" stainless steel 5,000 psi flat surface cleaner. Clean large areas with less water, less effort with a streak free finish.



HANT28 \$2,607  
HANT4C (Multi-twister) \$3,258

#### Extra length hose ... CONVENIENT p 70

Cleaning large plant?... reach further with these extra length Aussie Blue-Pro hoses, 5,800 psi rated, R2 wire braid hose, 3/8 female ends (M24 couplings sold separately)



AHW06FB6FB6X20 (20m) \$330  
AHW06FB6FB6X30 (30m) \$499  
AHW06FB6FB6X50 (50m) \$772  
M212003540 (M22 QC) \$21 (2 required)  
MPA26065050 (M24 QC) \$40 (2 required)

#### 5,000 psi Stainless Steel Hose Reel p73

5,000 psi rated, takes up to 80m of 3/8" hose, universal foot mount. Fits to frame on petrol versions only, otherwise wall mount.



A4418SS-REEL (ss reel only) \$890  
AHW06FB6FB6X1 (1m whip hose) \$31  
AE-E-90-0808 (Elbow 1/2" FF) \$30  
AA-A-0608 (1/2" to 3/8" nipple) \$8  
AA-A-90-0606 (3/8" elbow) \$22  
MPA26065050 (M24 QC) \$40 (2 required)  
AHRPLATEMONLRG mounting bar \$140

#### Drain Clearing Kit, SAFE & SIMPLE p 73

Includes Aussie Viper Mini Reel with 60 metres of 3/16" sewer hose. Full Aussie Jetters Tool Box, including quick coupler to fit to end of blaster high pressure hose. Includes Safety Plate.



ADRAINKIT \$3,285



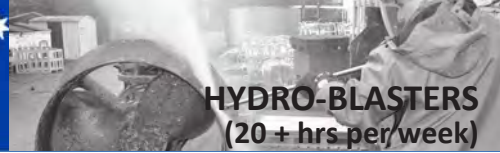

**HYDRO-BLASTERS**  
(20+ hrs per week)

## 7,300 PSI RAPTOR (CLASS B)

UNLEASH THE POWER!

7,300 PSI  
**\$11,270**  
NEW  
STAINLESS  
STEEL FRAME



**DOUBLE FLANGE MOTOR DRIVE**

### MONSOON RAPTOR

- ◆ 'Big Bertie' heavy duty pumps designed for long, continuous operation at extremely high pressures (\* Not Raptor 12).
- ◆ Heavy duty on-off switch with motor protection. Includes circuit breaker with thermal trip & short circuit protection in IP 65 enclosure with padlocking control.
- ◆ Heavy duty stainless steel frame with anti-vibration dampeners, 13" flat free tyres & steel wheels.
- ◆ Heavy duty 4 pole three phase IP55 rated slow speed motor
- ◆ Double flange motor drive (\* Not Raptor 12).
- ◆ FREE ASP (Aussie Safety Protection) kit ...Protects pump from pressure spikes and excess by-pass running
- ◆ Emergency stop
- ◆ FREE hose restraint valued at \$130
- ◆ 10 metres of 500 bar hose
- ◆ PA gun and 1050mm lance
- ◆ Class B machine requires operator RTO certification



**FREE**  
Aussie Safe Operator  
500 BAR Apron with  
every Raptor



Scan to see Raptor demo



### Optional 500 BAR accessories FASTER, SMARTER, SAFER

#### Turbo Master 500 ... MORE BITE p 79

Increase the effective working pressure (EWP) of your blaster without loading the pump!  
500 bar (7,300 psi) includes turbo head, gun, 800mm lance, nozzle & quick coupling nipple



CTN500-\_\_\_ GLK \$2,244  
(insert nozzle size)

#### Foot Valve ... MORE CONTROL p 79

Stainless steel foot valve adds a second level of operator control, in addition to gun trigger, includes 3m whip hose  
AST500-M24 \$975



#### Grit Blast Kit ... SURFACE PREP p 79

TPS 450, 500 bar (7,300 psi) c/w probe, plastic hose, lance, gun, nozzle & quick coupling nipple



TPS450/\_\_\_ GLK \$1,559  
(insert nozzle size)

#### 500 bar Hose Reels & Extra Length Hose p 73

500 bar reel, (7,300 psi) rated, takes up to 30m hose, universal foot mount. Does not fit onto frame, wall mount only.  
HAR700 \$1,452



3/8" R2 HP hose, 3/8M BSP ends, 150°C rated, for quick couplings refer p 65  
A3641443209 (20m) \$976  
A3641443309 (30m) \$1,246

#### Ceramic Nozzles ... LAST LONGER p 60

Aussie White Tip 500 bar 0° & 15°, nozzle, ceramic insert, inlet 1/4" NPT M ... \$142



Size	0° (pencil jet)	15° (fan)
025	M0124006100	M0124006110
030	M0124006200	M0124006210
035	M0124003600	M0124006310



#### Specifications

	Pump Pressure	EWP with turbo	Flow	415v Motor	Pump	Nozzle size	Stock code	List price
<b>Raptor 12</b>	7,300 psi (500 bar)	12,000 psi	12 lpm	12.5kW	Udor GHC12/50	020	ABRAPTOR/12EMOT	<b>\$11,270</b>
<b>Raptor 16</b>	7,300 psi (500 bar)	12,000 psi	16 lpm	18.5kW	Bertolini RA1650	030	ABRAPTOR-16MOT	<b>\$16,620</b>
<b>Raptor 21</b>	7,300 psi (500 bar)	12,000 psi	21 lpm	21kW	Bertolini RA2150	035	ABRAPTOR/21EMOT	<b>\$23,142</b>

#### Unit weights & dimensions

	Weight	Freight Dim (Lxwxh) mm
<b>Raptor 12</b>	130 kg	1100x800x1000
<b>Raptor 16</b>	185 kg	1100x800x1000
<b>Raptor 21</b>	220 kg	1100x800x1000



**Aussie Pumps**  
**SAFE OPERATOR**

PPE to 500 bar ... p 80

#### Accessories supplied with machine

Hose	A3641443109	10M 3/8" 500 bar
Gun/lance	MPA30540000	RLS7 500 bar pro gun & 1050mm lance
Nozzle	See chart	Ceramic tip 500 bar nozzle 15°

Pump service kits ... p87-88





STEAM CLEANERS

6

**ELECTRIC DRIVE P39-41**

**1,500 psi - 4,000 psi single & three phase**

Cleaning contractors, farmers, workshops, vehicle detailing, transport depots, machinery wash-down, council workshops



**PORTABLE ENGINE DRIVE P42**

**4,000 psi Hot Link & Heatwave**

Cleaning contractors, schools, hospitals, hire companies, farmers



**INDUSTRIAL ENGINE DRIVE P43-45**

**4,000 psi - 5,000 psi Hydrotek series**

Contract cleaning, shipyards, large machinery wash-down, graffiti removal, amenities cleaning, council workshops



**HYDRO-HUSH SILENCED STEAMER P46**

**4,000 psi, 75 dBA, 12v & 110v**

Council workshops, cleaning contractors, car-parks, nightwork street scapes, mine sites



**SKID & TRAILER MOUNTED HYDROTEKS P47-48**

**4,000 psi - 5,000 psi Hydrotek series**

Contract cleaning, shipyards, large machinery wash-down, graffiti removal, amenities cleaning, council workshops



**MINE SPEC HYDROTEKS P49-50**

**4,000 psi - 5,000 psi Hydrotek series**

Big machinery washdown, shipyards & mine sites



**CLEAN & CAPTURE ... HYDRO-LOOP P51-54**

EPA compliant ... no wastewater enters drain  
Fast, environmentally friendly, clean & green.

Contract cleaning, shipyards, large machinery wash-down, graffiti removal, amenities cleaning, council workshops





Aussie Super Indy

Aussie Sizzler

## ELECTRIC DRIVE HOT WASH & STEAM CLEANERS BUILT TO ENDURE AUSTRALIAN CONDITIONS

6

High pressure steam cleaners not only clean effectively, but steam kills micro-organisms within seconds without the use of chemical disinfectants.

Aussie Pumps has developed a range of hot wash & steam cleaners **specifically for Australian conditions**.

These machines are designed particularly with primary producers and earthmoving contractors in mind. A step up from European models, they feature triplex pumps, **4 pole motors**, steel chassis with 4 wheels, stainless steel covers and are made to last.

Cleaning with hot water is faster, uses less chemicals & offers a more hygienic result than using cold water.

The **Aussie Sizzler** .... Hot wash, single phase, temperatures to 80°C mean this simple unit delivers on performance & longevity.

The **Aussie Super Indy** range includes single and three phase steamers delivering steam up to 120°C and pressures to 3,000 psi.

The **Aussie Admiral range** ... the ultimate in hard working steam cleaners for high demand wash bays, with pressures as high as 4,000 psi for faster cleaning and temperatures to 130°C.

DON'T DREAM ... **STEP UP TO STEAM!**

## NEW AUSSIE SIZZLER HOT WASH COMPACT | SIMPLE TO USE | BUILT TOUGH



Aussie Sizzler  
(shown with optional protective cage)

### SAVE TIME & CLEAN CHEMICAL FREE, WITH AUSSIE'S NEW COMPACT, HOT WATER BLASTER

- ◆ **Heavy duty, high efficiency triplex pump** with brass head & independent brass unloader (1 year pump warranty)
- ◆ **Adjustable temperature to 80°C**
- ◆ **4 pole slow speed**, air cooled motor with thermal cut-out (10 amp plug fitted)
- ◆ **Stainless steel cover** for protection
- ◆ **Double loop mild steel coil**
- ◆ **Low maintenance stainless steel boiler**, high efficiency with low diesel consumption (3.2 kg/h at full temp)
- ◆ Cover lifts off for **easy access** to internals for maintenance and service.
- ◆ **Steel chassis** with four large wheels for manoeuvrability
- ◆ New accessories **storage holder**
- ◆ **18 litre diesel tank** (high density polyethylene)
- ◆ **Multifunction safety control ...**
  - ◆ **Delayed Total Stop ...** stops machine 30 seconds after the gun trigger closes ... SAVES FUEL
  - ◆ **Micro-leak detection ...** Stops the machine in case of leaks in hydraulic circuit
  - ◆ **Nozzle clogged control ...** Stops the machine if the nozzle in the end of the lance is blocked
  - ◆ **Flooding prevention system**
  - ◆ **Intelligent Auto Switch Off ...** Switches off machine after 20 minutes of non use.
  - ◆ **Dry running Protection ...** stops the machine when no water is supplied.
  - ◆ **Ignition boiler delay ...** Ensures low fume emissions when boiler starts up.
- ◆ Optional **stainless steel protective roll frame & lifting bar** (as shown in image)

#### Specifications

	Pressure	EWP with turbo	Flow	Max Temp	Motor	Pump	Nozzle size	Weight	Unit dimensions (Lxwxh) mm
<b>Aussie Sizzler</b>	1,800 psi (130 bar)	3,100 psi	10 lpm	80°C	240v, 2.7kW, 4 pole	Interpump	035	100 kg	820 x 630 x 870

#### Stock codes & prices

<b>Aussie Sizzler</b>	FS-D1310P4M	<b>\$4,773</b>
SS Protective frame	AFRAMES/SIZZLER	<b>\$743</b>

#### Accessories supplied with machine

Hose	AHW06M22X2X8	8m R2 3/8
Gun	M4022209003	AL55 4,500 psi Pro Gun
Lance	C3905.14	700mm single lance
Nozzle	C915035M	Laser Cut (15°)

### Optional accessories FASTER, SMARTER, SAFER

#### Turbo Lance .... 60% MORE BITE p 59

Increase the effective working pressure (EWP) of your blaster without loading the pump!



CTN255-035 \$214

#### CLEAN FLAT SURFACES FAST p 74

**SLASH CLEANING TIMES BY 75%**  
Clean flat surfaces four times faster, leaving a streak free finish. Standard nozzles included.

AGPDFSCS22Z \$1,565  
(22" Cyclone, stainless steel)



#### 5,000 psi Stainless Steel Hose Reel p 73

Store extra length hoses, suited for hot water hose up to 5,000 psi, must be wall mounted.

HAR150 (ss reel only) \$660  
HAR151 (holds up to 75m) \$831  
AHW06FB6FB6X2 (2m whip hose) \$45  
MPA13.5051.51 (3/8" nipple) \$44  
M212003540 (M22 QC) \$21



Fits through standard doorway even with protective frame



## 1,500 PSI & 3,000 PSI ... DESIGNED TOUGH FOR AUSSIE CONDITIONS



STEAM CLEANERS

6

### SUPER INDY SERIES

- ♦ **Slow speed**, 4 pole, IP56 motor (1400 rpm) for reliable long life performance.
- ♦ **Heavy duty slow speed triplex pump** with brass head & ceramic pistons (1 year warranty)
- ♦ **Mild steel heavy duty coil** with **2 year coil warranty**
- ♦ **Stainless steel coil** option with 3 year coil warranty
- ♦ **18 litre diesel fuel tank**
- ♦ High pressure detergent injection
- ♦ Stainless steel cover, 250mm wheels & heavy duty steel chassis with bumper
- ♦ **Flexible coupling** between motor and pump for a smoother, cooler drive
- ♦ **Low water cut-out** warning light control, prevents damage to machine
- ♦ **Low fuel sensor & warning light**
- ♦ **Timed Total Stop**—auto shut down
- ♦ **Safety thermostat** to protect pump
- ♦ **Micro-leak detection** with warning light
- ♦ **15 amp plug** fitted on single phase unit. No plug supplied on three phase unit
- ♦ **Class A ...** no operator certification required

#### Specifications

Super Indy Mk 3	Pressure	EWP with turbo	Flow	Max Temp	4 pole Motor	Pump	Nozzle size	Weight	Freight Dim (LxWxH)
Single phase	1,500 psi (100 bar)	2,600 psi	12 lpm	120°C	240v 2.2kW 15 amp plug	Interpump EL1713DX	055	120kg	1070 x 740 x 920 mm
Three phase	3,000 psi (200 bar)	4,785 psi	16 lpm	120°C	415v 5.5kW	Interpump WS151DX	045	190kg	1070 x 740 x 920 mm

#### Coil options

	Mild steel coil		Stainless steel coil	
Super Indy Mk 3 Single phase	FS/INDD51012MV3 (IDAC40280)	<b>\$5,984</b>	FS/INDDX1012MV3 (IDAC40281)	<b>\$6,898</b>
Super Indy Mk 3 Three phase	FS/INDD52016TV3 (IDAC40282)	<b>\$6,818</b>	FS/IND3DX2016T (IDAC40283)	<b>\$7,848</b>

#### Replacement accessories

Hose	AHW06M22X2X8	8m R2 3/8
Gun	M4022209003	AL55 4,500 psi Pro Gun
Lance	C3905.14	700mm single lance
Nozzle	C915 ___M	Laser Cut (15°)



### Optional accessories FASTER, SMARTER, SAFER

#### Turbo Kit .... 60% MORE BITE

p 59

Increase the effective working pressure (EWP) of your blaster without loading the pump!



CTN255-\_\_\_ (insert nozzle size) \$214

#### CLEAN FLAT SURFACES FAST

p 75

##### SLASH CLEANING TIMES BY 75%

##### Stainless steel flat surface cleaners

Clean four times faster, leaving a streak free finish. Standard nozzles included

AGPDFSC22Z

(22" Cyclone, 80°C max) **\$1,565**

HANT28

(28" Twister, 120°C max) **\$2,413**



#### Extra length hose ... CONVENIENT

p 70

Cleaning large plant?...

reach further with these extra length

**Aussie Blue-Pro hoses**, 5,800 psi rated, R2 wire braid hose, 3/8 female ends (M22 couplings sold separately)



AHW06FB6FB6X10 (10m) **\$199**

AHW06FB6FB6X20 (20m) **\$330**

AHW06FB6FB6X30 (30m) **\$499**

AHW06FB6FB6X50 (50m) **\$772**

M212003540 (M22 QC) **\$21** (2 required)

#### 5,000 psi Stainless Steel Hose Reel

p 73

Store extra length hoses, suited for hot water hose up to 5,000 psi, must be wall mounted.



HAR150 (ss reel only) **\$660**

HAR151 (holds up to 75m) **\$831**

AHW06FB6FB6X2 (2m whip hose) **\$45**

MPA13.5051.51 (3/8" nipple) **\$44**

M212003540 (M22 QC) **\$21**

#### Wet/Dry Vacs ... SUPER SUCKERS

p 99

Pick up waste water or use for vehicle detailing

VF13 10 litres **\$430**

VC44 30 litres **\$504**

VC61 50 litres **\$754**

VC72 75 litres **\$933**







## 3,000 PSI & 4,000 PSI ... SUPER HEAVY DUTY SERIES



ADMIRAL SERIES

- ♦ Slow speed, 4 pole, IP56 motor (1400 rpm) for reliable long life performance
- ♦ Heavy duty slow speed triplex pump with brass head & ceramic pistons
- ♦ **Mild steel heavy duty coil** with 2 year coil warranty
- ♦ **Stainless steel coil option** with 3 year coil warranty
- ♦ 18 litre diesel fuel tank
- ♦ High pressure detergent injection
- ♦ Stainless steel cover, 250mm wheels & heavy duty steel chassis with bumper
- ♦ Flexible coupling between motor and pump for a smoother, cooler drive.
- ♦ Low water cut-out warning light control, prevents damage to machine
- ♦ Low fuel sensor & warning light
- ♦ Timed Total Stop—auto shut down
- ♦ Safety thermostat to protect pump
- ♦ Micro-leak detection with warning light
- ♦ No plug supplied
- ♦ Class A ... no operator certification required

Specifications

	Pressure	EWP with turbo	Flow	Max Temp	4 pole Motor	Pump	Nozzle size	Weight	Freight Dim (lwxwxh)
<b>Admiral Mk 3</b>	3,000 psi (200 bar)	4,785 psi	19 lpm	130°C	415v 6.6kW	Interpump WS102DX	065	220kg	1070 x 740 x 920 mm
<b>Admiral 4000</b>	4,000 psi (275 bar)	6,485 psi	15 lpm	130°C	415v 6.6kW	Interpump WS251DX	040	190kg	1070 x 740 x 920 mm

Coil options

	Mild steel coil	Stainless steel coil
<b>Admiral Mk 3</b>	FHD191 ADMIRAL IDAC40566 <b>\$7,940</b>	FHD190ADMIRALSS IDAC40571 <b>\$8,945</b>
<b>Admiral 4000</b>	FHD275ADMIRAL IDAC40648 <b>\$8,945</b>	

Accessories supplied with machine

Hose	AHW06M22X2X8	8m R2 3/8
Gun	M4022209003	AL55 4,500 psi Pro Gun
Lance	C3905.14	700mm single lance
Nozzle	C915 ___M	Laser Cut (15°)



### Optional accessories FASTER, SMARTER, SAFER

#### Turbo Kit ... 60% MORE BITE p 59

Increase the effective working pressure (EWP) of your blaster without loading the pump!



CTN310-\_\_\_ (insert nozzle size) \$262

#### CLEAN FLAT SURFACES FAST p 75

##### SLASH CLEANING TIMES BY 75%

##### Stainless steel flat surface cleaners

Clean four times faster, leaving a streak free finish. Standard nozzles included

AGPDFSC22Z \$1,565

(22" Cyclone 80°C max)

HANT28 \$2,413

(28" Twister 120°C max)



#### Extra length hose ... CONVENIENT p 70

Cleaning large plant?...

reach further with these extra length

**Aussie Blue-Pro hoses**, 5,800 psi rated,

R2 wire braid hose, 3/8 female ends

(M22 couplings sold separately)



AHW06FB6FB6X10 (10m) \$199

AHW06FB6FB6X20 (20m) \$330

AHW06FB6FB6X30 (30m) \$499

AHW06FB6FB6X50 (50m) \$772

M212003540 (M22 QC) \$21 (2 required)

#### 5,000 psi Stainless Steel Hose Reel p 73

Store extra length hoses, suited for hot water hose up to 5,000 psi, must be wall mounted.



HAR150 (ss reel only) \$660

HAR151 (holds up to 75m) \$831

AHW06FB6FB6X2 (2m whip hose) \$45

MPA13.5051.51 (3/8" nipple) \$44

M212003540 (M22 QC) \$21

#### Wet/Dry Vacs ... SUPER SUCKERS p 99

Pick up waste water or use for vehicle detailing



VF13 10 litres \$430

VC44 30 litres \$504

VC61 50 litres \$754

VC72 75 litres \$933

#### Drain Cleaning Kit, SAFE & SIMPLE p 73

Includes Aussie Viper Mini Reel

with 60 metres of 3/16" sewer

hose. Full Aussie Jetters Tool Box,

including quick coupler to fit to

end of blaster high pressure hose.

Includes Safety Plate.



ADRAINKIT \$3,285

## 4,000 PSI HEATWAVE HONDA MOBILE STEAM CLEANER

130°C  
\$10,820



- ◆ Compact, portable hot water pressure washer, just connect to the tap.
- ◆ 12 volt, diesel fired burner
- ◆ Honda GX390 petrol engine
- ◆ Spiralast coil with lifetime warranty
- ◆ Flat free tyres on steel wheels
- ◆ Stainless steel frame with integrated handle
- ◆ Direct drive industrial triplex pump
- ◆ Integrated burst disc and safety relief valve
- ◆ Hose & pro accessories
- ◆ Battery ordered separately

### Specifications

	Safety Class	Pressure	Flow	Max Temp	Honda Engine	Pump	Weight	Dimensions (LxWxH) m
Aussie Heatwave	A	4,000 psi (275 bar)	13 lpm	130°C	GX390 e/start	GP triplex (3200 rpm)	165 kg	1.2x0.7x0.9

### Stock codes & pricing

Aussie Heatwave	HSM40004HG	<b>\$10,820</b>
-----------------	------------	-----------------

### Accessories supplied with machine

Hose	AHW06M22X2X15	15m R2 3/8"
Gun	CGPDG5010	5,000 psi pro gun
Lance	C3905.16 CD10073	1200mm single lance QC for nozzle
Nozzle	C915___Q	Quick tip nozzle

## 6 HOT LINK ... 12V DIESEL FIRED BURNER CONVERTS A COLD WATER BLASTER INTO A HOT WATER UNIT

- ◆ Suits any cold water pressure cleaner to 4,000 psi with flows to 20 lpm
- ◆ 12 volt diesel fired burner
- ◆ Built-in diesel fuel tank (11 litres).
- ◆ Flow switch control
- ◆ Requires 14 amp charge circuit
- ◆ Integrated burst disc and safety relief valve
- ◆ 2.7 metres of 5,000 psi hose
- ◆ Stainless steel frame with stainless steel boiler housing and powder coated steel chassis
- ◆ Requires a 12 volt power source

99°C  
\$4,690



### Specifications

	s/code	Safety Class	Max Pump Pressure	Max Flow	Max Temp	Weight	Dimensions (LxWxH) m	
Hot Link	HCPHL5DC	A	4,000 psi (275 bar)	20 lpm	99°C	127 kg	0.91 x 0.43 x 0.83	<b>\$4,690</b>

## Optional accessories FASTER, SMARTER, SAFER

### Turbo Kit .... 60% MORE BITE p 59

Turbo lance/gun kit.... Increase the effective working pressure of your blaster!



CTN400-\_\_\_GLK (insert nozzle size) \$430

### CLEAN FLAT SURFACES FAST p 75

SLASH CLEANING TIMES BY 75%  
Stainless steel flat surface cleaners  
Clean four times faster, leaving a streak free finish. Standard nozzles included



AGPDFSC22Z \$1,565

(22" Cyclone 80°C max)

HANT28 \$2,413

(28" Twister 120°C max)

### Extra length hose ... CONVENIENT p 70

Cleaning large plant?... reach further with these extra length Aussie Blue-Pro hoses, 5,800 psi rated, R2 wire braid hose, 3/8 female ends (M22 couplings sold separately)



AHW06FB6FB6X10 (10m) \$199

AHW06FB6FB6X20 (20m) \$330

AHW06FB6FB6X30 (30m) \$499

AHW06FB6FB6X50 (50m) \$772

M212003540 (M22 QC) \$21 (2 required)

### 5,000 psi Stainless Steel Hose Reel p 73

Store extra length hoses, suited for hot water hose up to 5,000 psi, must be wall mounted.



HAR150 (ss reel only) \$660

HAR151 (holds up to 75m) \$831

AHW06FB6FB6X2 (2m whip hose) \$45

MPA13.5051.51 (3/8" nipple) \$44

M212003540 (M22 QC) \$21

### Drain Clearing Kit, SAFE & SIMPLE p 73

Includes Aussie Viper Mini Reel with 60 metres of 3/16" sewer hose. Full Aussie Jetters Tool Box, including quick coupler to fit to end of blaster high pressure hose. Includes Safety Plate.



ADRAINKIT \$3,285

### Grit Blast Kit ... SURFACE PREP p 79

Remove paint & rust fast



FLCPR53825 \$208



**AUSSIE HYDROTEK**  
**BRILLIANT DESIGN ...**  
**TOUGH ON GRIME**

STEAM CLEANERS

### NEW HYDRO-HUSH EASY ON THE EARS

**75dBA**

PAGE 46

The Aussie Hydroteks are compact, high pressure, mobile steam cleaners with serious cleaning power. They are designed to perform heavy duty cleaning without needing any outside electrical power.

An invaluable tool for councils, property management companies, service companies, mechanics or anyone requiring a mobile cleaning solution for dirt, grease and grime.

#### Key features

- Industrial petrol/diesel engines
- Heavy duty triplex pump
- Rugged 'Pro-Tect-It' frame with stainless steel panels for corrosion resistance
- 12v or 110v low voltage diesel fired burner system
- Available skid mounted, trailer mounted
- Clean & capture system option
- Mine spec versions ... super tough



Aussie Hydrotek JAWS ... p48 & 50



Aussie Hydro-Loop Clean & Capture ... p51





## AUSSIE HYDROTEK ... PETROL BRILLIANT DESIGN, TOUGH ON GRIME



HSS40005HH



HYDRO TEK.US



- ◆ **Heavy duty** triplex pump with brass pump head
- ◆ **Adjustable temperature** up to 130°C, steam melts grease without using chemicals.
- ◆ **Water tight electrical box** with battery.
- ◆ **Robust "Pro-TECT"** steel frame with built-in lifting eyes for transportation.
- ◆ **Stainless steel panels** and boiler cover.
- ◆ **#Two gun operation** available on AF versions (reduces flow to 10 lpm per gun)
- ◆ Battery ordered separately

### Specifications

	Safety Class	Pressure	EWP with turbo	Flow	Max Temp	Engine	Pump	Nozzle size	Loop option
COMMERCIAL SERIES ... up to 20 hrs per week, <b>12v low voltage</b> burner									
HSS40005HH	A	4,000 psi (275 bar)	6,485 psi	18 lpm	130°C	Honda GX630	AR	045 (15°, 40°) 035 (25° steam)	No
INDUSTRIAL SERIES ... over 20 hrs per week, <b>110v burner</b> with on-board generator									
HSC40005HAF#	A	4,000 psi (275 bar)	6,485 psi	20 lpm	130°C	Honda GX630	Bertolini	025,035,045,050 (all 15°)	Yes

### Stock codes & pricing

Weight & Dimensions (LxWxH) m				
HSS40005HH	HSS40005HH	204 kg	1.2x0.66x1.02	<b>\$17,480</b>
HSC40005HAF#	HSC40005HAF	306 kg	1.3x0.9x1.0	<b>\$20,025</b>

### Accessories supplied with machine

Hose	AHW06M22X2X15	15m R2 3/8"
Gun	CGPDG5010	5,000 psi pro gun
Lance	C3905.16 + CD10073	1200mm single lance
Nozzle	C915__Q	Quick tip nozzle

### Optional accessories FASTER, SMARTER, SAFER

#### Turbo Kit .... 60% MORE BITE p 59

Turbo lance/gun kit... Increase the effective working pressure of your blaster!



CTN400-\_\_GLK (insert nozzle size) **\$430**

#### CLEAN FLAT SURFACES FAST p 75

**SLASH CLEANING TIMES BY 75%**  
Stainless steel flat surface cleaners  
Clean four times faster, leaving a streak free finish. Standard nozzles included



AGPDFSC22Z **\$1,565**  
(22" Cyclone 80°C max)  
HANT28 **\$2,413**  
(28" Twister 120°C max)

#### Extra length hose ... CONVENIENT p 70

Cleaning large plant?... reach further with these extra length **Aussie Blue-Pro hoses**, 5,800 psi rated, R2 wire braid hose, 3/8 female ends (M22 couplings sold separately)



AHW06FB6FB6X10 (10m) **\$199**  
AHW06FB6FB6X20 (20m) **\$330**  
AHW06FB6FB6X30 (30m) **\$499**  
AHW06FB6FB6X50 (50m) **\$772**  
M212003540 (M22 QC) **\$21** (2 required)

#### 5,000 psi Stainless Steel Hose Reel p 73

Store extra length hoses, suited for hot water hose up to 5,000 psi, must be wall mounted.



HAR150 (ss reel only) **\$660**  
HAR151 (holds up to 75m) **\$830**  
AHW06FB6FB6X2 (2m whip hose) **\$45**  
MPA13.5051.51 (3/8" nipple) **\$44**  
M212003540 (M22 QC) **\$21**

#### Drain Clearing Kit, SAFE & SIMPLE p 73

Includes **Aussie Viper Mini Reel** with 60 metres of 3/16" sewer hose. Full **Aussie Jettors Tool Box**, including quick coupler to fit to end of blaster high pressure hose. **Includes Safety Plate.**



ADRAINKIT **\$3,285**





## AUSSIE HYDROTEK ... DIESEL BRILLIANT DESIGN, TOUGH ON GRIME

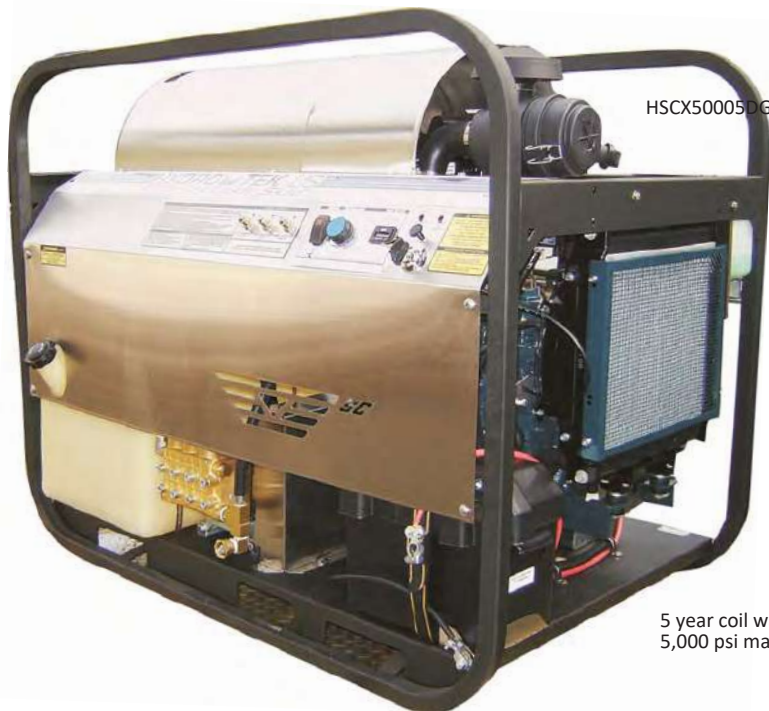

HSCX50005DG

5 year coil warranty on  
5,000 psi machines

- ◆ Heavy duty triplex pump with brass pump head
- ◆ Adjustable temperature up to 130°C, steam melts grease without using chemicals
- ◆ Water tight electrical box with battery
- ◆ Robust "Pro-protect" steel frame with built-in lifting eyes for transportation
- ◆ Stainless steel panels and boiler cover
- ◆ #Two gun operation available on AF versions (reduces flow to 10 lpm per gun)



see p 47- 48

### Specifications

	Safety Class	Pressure	EWP with turbo	Flow lpm	Burner voltage	Engine	Pump	Nozzle size	Loop option
HSCX40005DB12	A	4,000 psi (275 bar)	6,485 psi	20	12v	Kubota 17HP	Interpump TSF 1819	050 (Q type, 15°, 25°, 40°)	No
HSCX40005DG	A	4,000 psi (275 bar)	6,485 psi	20	110v	Kubota 17HP	Interpump TSF 1819	050 (Q type, 15°, 25°, 40°)	Yes
HSCX50005DG	B	5,000 psi (350 bar)	8,500 psi	18	110v	Kubota 17HP	Interpump TSF 1821	040 (M, 15°, 25°, 40°)	Yes

### Stock codes & pricing

		Weight & Dimensions (LxWxH) m		
HSCX40005DB12	HSCX40005DB12	310 kg	1.3 x 0.82 x 1.2	<b>\$28,933</b>
HSCX40005DG	HSCX40005DG	310 kg	1.3 x 0.82 x 1.2	<b>\$30,177</b>
HSCX50005DG*	HSCX50005DG	395 kg	1.3 x 0.9 x 1.0	<b>\$32,830</b>

\*



Class B machines supplied with emergency stop & FREE hose restraint

### Accessories supplied with machine

Hose	AHW06M22X2X15	15m R2 3/8"
Gun	CGPDG5010	5,000 psi pro gun
Lance	C3905.16 + CD10073	1200mm single lance



PPE to 500 bar ... p 80

### Optional accessories FASTER, SMARTER, SAFER

#### Turbo Kit .... 60% MORE BITE

p 59

Turbo lance/gun kit.... Increase the effective working pressure of your blaster!



CTN400-__GLK	(insert nozzle size)	<b>\$430</b>
CTN400-__GLKM24	(insert nozzle size)	<b>\$441</b>

#### CLEAN FLAT SURFACES FAST

p 75

##### SLASH CLEANING TIMES BY 75%

##### Stainless steel flat surface cleaners

Clean four times faster, leaving a streak free finish. Standard nozzles included



AGPDFSC22Z	<b>\$1,565</b>
(22" Cyclone 80°C max)	
HANT28	<b>\$2,413</b>
(28" Twister 120°C max)	

#### Extra length hose ... CONVENIENT

p 70

Cleaning large plant?... reach further with these extra length

Aussie Blue-Pro hoses, 5,800 psi rated, R2 wire braid hose, 3/8 female ends (M22 & M24 couplings sold separately)



AHW06FB6FB6X10 (10m)	<b>\$199</b>
AHW06FB6FB6X20 (20m)	<b>\$330</b>
AHW06FB6FB6X30 (30m)	<b>\$499</b>
AHW06FB6FB6X50 (50m)	<b>\$772</b>
M212003540 (M22 QC)	<b>\$21</b> (2 required)
MPA26065050 (M24 QC)	<b>\$40</b> (2 required)

#### 5,000 psi Stainless Steel Hose Reel

p 73

Store extra length hoses, suited for hot water hose up to 5,000 psi, must be wall mounted.



HAR150	(ss reel only)	<b>\$660</b>
HAR151	(holds up to 75m)	<b>\$831</b>
AHW06FB6FB6X2 (2m whip hose)		<b>\$45</b>
MPA13.5051.51 (3/8" nipple)		<b>\$44</b>
M212003540 (M22 QC)		<b>\$21</b>
MPA26065050 (M24 QC)		<b>\$40</b>

#### Drain Cleaning Kit, SAFE & SIMPLE

p 73

Includes Aussie Viper Mini Reel with 60 metres of 3/16" sewer hose. Full Aussie Jettors Tool Box, including quick coupler to fit to end of blaster high pressure hose. Includes Safety Plate.



ADRAINKIT **\$3,285**





### NEW AUSSIE HYDRO-TEK HYDRO-HUSH

Cleaning while the city sleeps



STEAM CLEANERS

- ◆ **Kubota diesel engine** with low oil/Hi temp cut out, silenced muffler with spark arrester & emergency stop
- ◆ Noise readings **75dBA** at 7m
- ◆ **4,000 psi heavy duty pump**
- ◆ **12v & 110v diesel fired burner systems**
- ◆ **Noise shielding**, insulated panels
- ◆ **Extra large built-in diesel fuel tank** for extended running (136L)
- ◆ **Water tight electrical box** with battery
- ◆ **Robust "Pro-ect" stainless steel frame** with built-in lifting eyes for transportation.
- ◆ **Lifetime warranty** on coil
- ◆ **Stainless steel panels & boiler cover**

#### Trailer Spec ...

Heavy duty Australian made flat bed trailer (Single axle on HSS units & tandem axle on HSC units)

- ◆ **Hot dipped galvanised finish**
- ◆ **New wheels & tyres & wheels**
- ◆ **Fitted with brakes**
- ◆ **Heavy duty tool box** for storage of wash down accessories ... HSC units only.
- ◆ Trailer provided with on road NSW **blue slip ready for registration.**

#### Specifications

	Safety Class	Pressure	EWP with turbo	Flow	Max °C	Burner voltage	Engine	Pump	Nozzle size	Loop option
HSCX40005D12-HUSH	A	4,000 psi (275 bar)	6,485 psi	20 lpm	121	12v	Kubota 20HP	Interpump TSF 1819	050 (Q type, 15°,25°,40°)	No
HSCX40005D-HUSH	A	4,000 psi (275 bar)	6,485 psi	20 lpm	121	110v	Kubota 20HP	Interpump TSF 1819	050 (Q type, 15°,25°,40°)	Yes

#### Stock codes & pricing

	Hydrotek Unit only			Skid mount version (Hydrotek + 1,000L tank & double stacker hose reels)			Trailer mount version (Hydrotek + 1,000L tank & double stacker hose reels)		
		Dim (LxWxH) m			Dim (LxWxH) m			Dim (LxWxH) m	
HSCX40005D12-HUSH	HSCX40005DB12SI	1.3 x 0.82 x 1.2	<b>\$37,999</b>	HSCX40005DSM	2.03 x 1.3 x 1.2	<b>\$47,655</b>	HSCX40005DJAW	3.8 x 2.3 x 1.7	<b>\$54,780</b>
HSCX40005D-HUSH	HSCX40005DBSI	1.3 x 0.82 x 1.2	<b>\$39,980</b>	HSCX40005D12SM	2.03 x 1.3 x 1.2	<b>\$49,064</b>	HSCX40005D12JAW	3.8 x 2.3 x 1.7	<b>\$58,970</b>

#### Accessories supplied with machine

Hose	AHW06M22X2X15	15m R2 3/8"
Gun	CGPDG5010	5,000 psi pro gun
Lance	C3905.16 + CD10073	1200mm single lance

#### Optional accessories FASTER, SMARTER, SAFER

##### Turbo Lance Kit .... 60% MORE BITE p 59

Turbo lance/gun kit.... Increase the effective working pressure of your blaster!

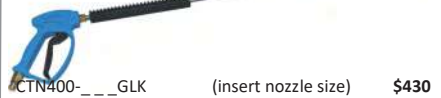

##### CLEAN FLAT SURFACES EXTRA FAST p 75

**SLASH CLEANING TIMES BY 75%**  
Stainless steel flat surface cleaners  
Clean four times faster, leaving a streak free finish. Standard nozzles included



- AGPDFSC22Z **\$1,565**  
(22" Cyclone 80°C max)
- HANT28 **\$2,413**  
(28" Twister 120°C max)

##### Drain Cleaning Kit, SAFE & SIMPLE p 73

Includes **Aussie Viper Mini Reel** with 60 metres of 3/16" sewer hose. Full **Aussie Jettors Tool Box**, including quick coupler to fit to end of blaster high pressure hose. Includes **Safety Plate**.



ADRAINKIT **\$3,285**



SKID MOUNT VERSION



TRAILER MOUNT VERSION

### HYDRO-TEK MOBI STEAM BLASTERS

The **Hydrotek series** are high pressure, mobile steam cleaners with serious cleaning power. They are self contained so no external power or water source is required.



HSC40005HAF skid mount

A skid mounted mobile steam cleaner with it's own water supply that is ideal for on site cleaning for plant and equipment!

- ◆ Aussie Hydrotek self contained steam cleaner
- ◆ 1,000L water tank with float, drain valve, low level cut out sensor, lid with strainer and level indicator (Additional sizes available.)
- ◆ Heavy duty skid base with anti-vibration dampeners and lifting points (cube mounted option available)
- ◆ Double stacker hose reel (supplied separately)
- ◆ High pressure reel and base mount with 30 metres of 3/8" R2 high pressure outlet hose and screw quick couplings
- ◆ Low pressure reel and 30 metres 3/4" heavy duty reinforced supply hose
- ◆ \*Two gun operation available on selected models

Specifications

	Safety Class	Pressure	EWP with turbo	Flow	Max Temp	Burner voltage	Engine	Pump	Nozzle size
<b>PETROL POWERED</b>									
HSS40005HH	A	4,000 psi (275 bar)	6,485 psi	18 lpm	130°C	12v	Honda GX630	AR	045 (15°, 40°) 035 (25° steam)
HSC40005HAF#	A	4,000 psi (275 bar)	6,485 psi	20 lpm	130°C	110v	Honda GX630	Bertolini	025,035,045, 050 (all 15°)
<b>DIESEL POWERED</b>									
HSCX40005DB12	A	4,000 psi (275 bar)	6,485 psi	20 lpm	130°C	12v	Kubota 17HP	Interpump TSF 1819	050 (Q type, 15°, 25°, 40°)
HSCX40005DG	A	4,000 psi (275 bar)	6,485 psi	20 lpm	130°C	110v	Kubota 17HP	Interpump TSF 1819	050 (Q type, 15°, 25°, 40°)

Stock codes & pricing

		Weight & Dimensions (LxWxH) m		
HSS40005HH	HSS40005HHSM	1150 kg	2.03 x 1.3 x 1.2	<b>\$25,988</b>
HSC40005HAF#	HSC40005HAFSM	1250 kg	2.03 x 1.3 x 1.2	<b>\$28,554</b>
HSCX40005DB12	HSCX40005DB12SM	1300 kg	2.03 x 1.3 x 1.2	<b>\$33,051</b>
HSCX40005DG	HSCX40005DGSM	1300 kg	2.03 x 1.3 x 1.2	<b>\$37,628</b>



Accessories supplied with machine

Hose	AHW06M22X2X10	10m R2 3/8"
Gun	CGPDG5010	5,000 psi pro gun
Lance	C3905.16 + CD10073	1200mm single lance

SEE PAGE 46 FOR  
HYDRO-HUSH  
VERSION ... 75dBA

#### Optional accessories FASTER, SMARTER, SAFER

**Turbo Kit .... 60% MORE BITE** p 59

Turbo lance/gun kit.... Increase the effective working pressure of your blaster!



CTN400-\_\_GLK (insert nozzle size) \$430

**CLEAN FLAT SURFACES FAST** p 75

**SLASH CLEANING TIMES BY 75%**  
Stainless steel flat surface cleaners  
Clean four times faster, leaving a streak free finish. Standard nozzles included

- AGPDFSC22Z \$1,565 (22" Cyclone 80°C max)
- HANT28 \$2,413 (28" Twister 120°C max)



**Drain Cleaning Kit, SAFE & SIMPLE** p 73

Includes Aussie Viper Mini Reel with 60 metres of 3/16" sewer hose. Full Aussie Jetters Tool Box, including quick coupler to fit to end of blaster high pressure hose and safety plate.



ADRAINKIT \$3,285





COMMERCIAL/INDUSTRIAL  
TRAILER MOUNTED



## HYDROTEK JAW SYSTEMS ... JUST ADD WATER MOBILE CLEANING POWER

Heavy duty self contained systems with integrated water tank ... truly independent cleaning for professional cleaning contractors. Ideal for urban graffiti removal or remote cleaning applications

- ◆ **Hydrotek self contained steam cleaner** ... Diesel or petrol powered with diesel fired burner.
  - ◆ **Poly impact resistant water tank** with position locking lid & water filter (larger tanks available on request)
  - ◆ **20" Aussie Spinner** flat surface cleaner
  - ◆ **Heavy duty stainless steel hose reel** with 30 m high pressure hose
  - ◆ **Low pressure hose reel** with 30 metres of low pressure supply hose
  - ◆ **Hand gun** with stainless steel 700mm dual lance & nozzle kit (except on machines fitted for dual gun operation)
  - ◆ **"Two gun operation** available on selected models (reduces flow to 10 lpm per gun)
  - ◆ **Tool box options**
- Trailer Spec ...**  
Heavy duty Australian made flat bed trailer (Single axle on HSS units & tandem axle on HSC units)
- ◆ **Hot dipped galvanised** finish
  - ◆ **New wheels & tyres & wheels**
  - ◆ **Fitted with brakes**
  - ◆ **Heavy duty tool box** for storage of wash down accessories ... HSC units only.
  - ◆ Trailer provided with on road NSW **blue slip** ready for registration.



Optional hose reel for two gun set-up



### Optional accessories FASTER, SMARTER, SAFER

#### Turbo Lance Kit ... 60% MORE BITE p 59

Turbo lance/gun kit... Increase the effective working pressure of your blaster!



CTN400-\_\_GLK (insert nozzle size) \$430

#### CLEAN FLAT SURFACES EXTRA FAST p 75

**SLASH CLEANING TIMES BY 75%**  
**Stainless steel flat surface cleaners**  
Clean four times faster, leaving a streak free finish. Standard nozzles included



AGPDFSC22Z \$1,565  
(22" Cyclone 80°C max)  
HANT28 \$2,413  
(28" Twister 120°C max)

#### Drain Cleaning Kit, SAFE & SIMPLE p 73

Includes Aussie Viper Mini Reel with 60 metres of 3/16" sewer hose. Full Aussie Jetters Tool Box, including quick coupler to fit to end of blaster high pressure hose. Includes Safety Plate.



ADRAINKIT \$3,285

### Specifications

	Safety Class	Pressure	EWP / turbo	Flow	Max Temp	Burner voltage	Engine	Pump	Nozzle size
<b>PETROL POWERED</b>									
HSS40005HH	A	4,000 psi (275 bar)	6,485 psi	18 lpm	130°C	12v	Honda GX630	AR	045 (15°, 40°) 035 (25° steam)
HSC40005HAF#	A	4,000 psi (275 bar)	6,485 psi	20 lpm	130°C	110v	Honda GX630	Bertolini	025,035,045,050 (all 15°)
<b>DIESEL POWERED</b>									
HSCX40005DB12	A	4,000 psi (275 bar)	6,485 psi	20 lpm	130°C	12v	Kubota 17HP	Interpump TSF 1819	050 (Q type, 15°, 25°, 40°)
HSCX40005DG	A	4,000 psi (275 bar)	6,485 psi	20 lpm	130°C	110v	Kubota 17HP	Interpump TSF 1819	050 (Q type, 15°, 25°, 40°)

### Stock codes & pricing

		Dimensions (LxWxH) m	
HSS40005HH	HSS40005HHJAW	4 x 2 x 1.8	<b>\$33,988</b>
HSC40005HAF	HSC40005HAFJAW	4 x 2 x 1.8	<b>\$36,547</b>
HSCX40005DB12	HSCX40005DB12JAW	4 x 2 x 1.8	<b>\$40,796</b>
HSCX40005DG	HSCX40005DGJAW	4 x 2 x 1.8	<b>\$49,404</b>



see p 49- 50

SEE PAGE 46 FOR  
HYDRO-HUSH  
VERSION ... 75dBA

### Accessories supplied with machine

Hose	AHW06M22X2X30	30m R2 3/8"
Gun	CGPDG5010	5,000 psi pro gun
Lance	C3905.16 + CD10073	1200mm single lance





## HYDROTEK MINE SPEC SERIES

.. mobile steam cleaning



Shown with optional hose reels



- Aussie Mine spec includes**
- ◆ Emergency stop
  - ◆ Fire extinguisher (2 Kg)
  - ◆ Lockable battery isolator



The HSCX series "Hammerhead" are diesel powered hot water mobile wash units with serious cleaning power.

They are engineered for performance, durability and corrosion resistance.

- ◆ **Powerful Kubota diesel**, multi cylinder engine
- ◆ **Heavy duty triplex pump** with nickel plated pump head

- ◆ **Stainless steel protection panels & boiler cover**
- ◆ **Diesel powered burner** with variable temperature control
- ◆ **Built-in diesel fuel tank.** (68 L)
- ◆ **Water tight electrical box** with battery
- ◆ 4,000 psi machines ... Lifetime warranty  
5,000 psi machines ... 5 year coil warranty

Specifications

	Safety Class	Pressure	EWP with turbo	Flow	Max Temp	Burner voltage	Engine	Pump	Nozzle size
<b>DIESEL POWERED</b>									
HSCX40005D12	A	4,000 psi (275 bar)	6,485 psi	20 lpm	130° C	12v	Kubota 17HP	Interpump TSF 1819	050 (Q type, 15°,25°,40°)
HSC50005D*	B	5,000 psi (350 bar)	8,500 psi	18 lpm	130° C	110v	Kubota 20HP	Interpump TSF 1821	040 (M type, 15°,25°,40°)

Stock codes & pricing

		Weight	Dimensions (LxWxH) m	
HSCX40005D12	HSCX40005D12MS	270 kg	1.3x0.86x1.0	<b>\$34,339</b>
HSC50005D*	HSC50005DMS*	294 kg	1.4x0.86x1.0	<b>\$37,743</b>

Accessories supplied with machine

Hose	AHW06M22X2X10	15m R2 3/8"
Gun	CGPDG5010	5,000 psi pro gun
Lance	C3905.16 + CD10073	1200mm single lance



Class B machines supplied with emergency stop & FREE hose restraint

Optional accessories

**FASTER, SMARTER, SAFER**

**Turbo Kit ... 60% MORE BITE** p 59

Turbo lance/gun kit... Increase the effective working pressure of your blaster!



- CTN400-\_\_\_GLK (insert nozzle size) \$430
- CTN400-\_\_\_GLKM24 (insert nozzle size) \$441

**CLEAN FLAT SURFACES FAST** p 75

**SLASH CLEANING TIMES BY 75%**  
Stainless steel flat surface cleaners  
Clean four times faster, leaving a streak free finish. Standard nozzles included

- AGPDFSC22Z \$1,565 (22" Cyclone 80°C max)
- HANT28 \$2,413 (28" Twister 120°C max)



**Extra length hose ... CONVENIENT** p 70

Cleaning large plant?... reach further with these extra length Aussie Blue-Pro hoses, 5,800 psi rated, R2 wire braid hose, 3/8 female ends (M22 & M24 couplings sold separately)

- AHW06FB6FB6X10 (10m) \$199
- AHW06FB6FB6X20 (20m) \$330
- AHW06FB6FB6X30 (30m) \$499
- AHW06FB6FB6X50 (50m) \$772
- M212003540 (M22 QC) \$21 (2 required)
- MPA26065050 (M24 QC) \$40 (2 required)



**5,000 psi Stainless Steel Hose Reel** p 73

Store extra length hoses, suited for hot water hose up to 5,000 psi, must be wall or trailer mounted.

- HAR150 (ss reel only) \$660
- HAR151 (holds up to 75m) \$831
- AHW06FB6FB6X2 (2m whip hose) \$45
- MPA13.5051.51 (3/8" nipple) \$44
- M212003540 (M22 QC) \$21
- MPA26065050 (M24 QC) \$40



**Drain Cleaning Kit, SAFE & SIMPLE** p 73

Includes Aussie Viper Mini Reel with 60 metres of 3/16" sewer hose. Full Aussie Jetters Tool Box, including quick coupler to fit to end of blaster high pressure hose. Includes Safety Plate.



ADRAINKIT \$3,285

**Personal Protective Gear 500 bar** p 80



- ◆ Overalls
- ◆ Aprons
- ◆ Jackets
- ◆ Gloves
- ◆ Trousers
- ◆ Boots



MINE SPEC STEAM CLEANERS

6



## MINE SPEC STEAM CLEANERS

### SKID MOUNT



This version shows side mounted reels

### TRAILER MOUNT



Super heavy duty site trailer

A skid or trailer mounted Mine Spec series mobile steam cleaner with it's own water supply. Ideal for on site cleaning!

#### Aussie Mine Spec Skid/Trailer mount details

- ◆ Aussie Hydrotek self contained steam cleaner
- ◆ 1,000L water tank with float, drain valve, low level cut out sensor, lid with strainer and level indicator (Additional sizes available.)
- ◆ Heavy duty skid base or trailer with anti-vibration dampeners and lifting points (cube mounted option available)
- ◆ Double stacker unit (supplied separately) with
  - ◆ High pressure reel and base mount with 30 metres of 3/8" R2 high pressure outlet hose and screw quick couplings
  - ◆ low pressure reel and 30 metres 3/4" heavy duty reinforced supply hose

#### # Aussie Mine Spec trailer specs ...

- Heavy duty tandem axle trailer
- ◆ Hot dipped galvanised finish
  - ◆ New 15" 6 stud Land Cruiser pattern wheels
  - ◆ New 31.5 mud pattern tyres
  - ◆ Extra wide mudguards to suit
  - ◆ AL-KO Ring coupling with hand brake plate
  - ◆ Supplied with Brakes
  - ◆ Heavy Duty tool box for wash down accessories
  - ◆ Vin numbered , weighed and blue slipped ready for Registration

#### Optional Extreme Series trailer ... +\$9,880

4.5 Tonne GVM Australian made tandem axle flat bed trailer will be provided with the following specifications:-

- ◆ Hot dipped galvanised finish
- ◆ Tandem AL-KO 2.5 tonne IRS torsion tube suspended axles fitted with 6 stud hubs & 3,000 kg bearing sets
- ◆ Four 15" white spoke wheels with off road mud pattern tyres & checker plate mudguards
- ◆ Heavy duty landing leg & two stabilizer legs
- ◆ Hitch attach options
- ◆ Checker plate front and rear mount decks
- ◆ Electric brakes standard, other options available

#### Aussie Mine spec includes

- ◆ Emergency stop
- ◆ Fire extinguisher (2 Kg)
- ◆ Lockable battery isolator



#### Specifications

	Safety Class	Pressure	EWP with turbo	Flow	Max Temp	Burner voltage	Engine	Pump	Nozzle size
<b>DIESEL POWERED</b>									
HSCX40005D12	A	4,000 psi (275 bar)	6,485 psi	20 lpm	130°C	12v	Kubota 17HP	Interpump TSF 1819	050 (Q type, 15°,25°,40°)
HSC50005D*	B	5,000 psi (350 bar)	8,500 psi	18 lpm	130°C	110v	Kubota 20HP	Interpump TSF 1821	040 (M type, 15°,25°,40°)



Class B machines supplied with emergency stop & FREE hose restraint

#### Stock codes & pricing

		Skid mount version (Hydrotek + 1,000L tank & double stacker hose reels)			Trailer mount version (Hydrotek + 1,000L tank & double stacker hose reels)		
		Weight	Dim (LxWxH) m		Dim (LxWxH) m		
HSCX40005D12	HSCX40005D12MSM	420 kg	2.03 x 1.3 x 1.2	<b>\$39,077</b>	HSCX40005D12MTR	4 x 2 x 1.8	<b>#\$51,152</b>
HSC50005D*	HSC50005DMSM	480 kg	2.03 x 1.3 x 1.2	<b>\$44,252</b>	HSC50005DMTR	4 x 2 x 1.8	<b>#\$53,820</b>

#### Accessories supplied with machine

Hose	AHW06M22X2X30	30m R2 3/8"
Gun	CGPDG5010	5,000 psi pro gun
Lance	C3905.16 + CD10073	1200mm single lance



# AUSSIE HYDRO-LOOP

YOUR TURN ... LIVE THE DREAM!



STEAM CLEANERS

5

NEW HYDRO-HUSH LOOP  
Clean while the city sleeps



EPA COMPLIANT  
CLEAN & CAPTURE SYSTEM



## HYDRO-LOOP...IT'S CLEAN & GREEN



The **Hydro-Loop system** means fast, efficient cleaning, with a unique 'Clean and Capture' system. You can comply with EPA regulations.

That's right...the site is not contaminated, but left in pristine condition! This is not just a machine ... it's a business opportunity without the ties of a franchise.

You have the support of **Aussie's** marketing machine and the freedom to build your business, your way.

You set your own price, work your own hours and keep all your profits.

Successful **Aussie Hydro-Loop Club** members are motivated, and have the drive to generate work from car parks, shopping centres, service stations and property managers.

### What is the Aussie Hydro-Loop?

It's a self contained, trailer mounted, hot-water pressure washer with built in recovery unit, filters and tank. These units combine the cleaning power of high pressure and steam with a vacuum filtration system that collects the waste water, preventing it from entering storm drains.

The wastewater is collected via either the **Hydro Twister** flat surface cleaner or a Scupper placed at a dammed drain point. The water is then filtered through 5 stages and returned to the supply tank for reuse.

System features ....

- ◆ **Aussie Hydrotek** engine drive industrial steam cleaner
- ◆ **Vacuum filtration system** with two stage motor, and two replaceable cartridge filters
- ◆ **1,000 litre poly impact resistant water tank** (750 litres on Junior)
- ◆ **Double axle trailer** with swivel jockey wheel and spare (registration approval pending). Junior version is mounted on a single axle trailer.
- ◆ **Double stacker hose reels** (US made) ...
  - ◆ One stainless steel reel with 30m of high pressure hose
  - ◆ One hose reel with 30 metres of low pressure garden hose.
- ◆ **Heavy duty 5,000 psi** rated hand gun
- ◆ **Stainless steel 1200mm single lance** with "Snap-On" nozzle kit
- ◆ **24.5" heavy duty Twister Vac** rotary floor cleaner (Option on Junior Loop)
- ◆ **1½" mesh strainer** with bleed valve, 60 micron
- ◆ **1.8m rubber, sand filled boom**, 3m sand dam tubes, sand not included
- ◆ **50mm x 15m spiral vacuum hose** with scupper attachment (galvanised vac hose reel on Maxi)

STEAM CLEANERS

5





### HYDRO-LOOP JUNIOR

Extra mobile, for fast set up & cleaning



Demo online  
**You Tube**

- ◆ Aussie Hydrotek engine drive industrial steam cleaner
- ◆ Vacuum filtration system with two stage motor, and two replaceable cartridge filters (NEW AZV88)
- ◆ 750 litre poly impact resistant water tank
- ◆ Single axle trailer
- ◆ A stainless steel high pressure hose reel
- ◆ Package includes containment berms, scupper & vacuum hose
- ◆ **Optional 24.5" heavy duty Twister Vac rotary floor cleaner to clean & recover wastewater**

Specifications

	Safety Class	Pressure	EWP with turbo	Flow	Max Temp	Engine
HSC40005HAF#	A	4,000 psi (275 bar)	6,485 psi	20 lpm	130°C	Honda GX630

Stock codes & pricing

		Dimensions (LxWxH) m		
HSC40005HAF#	HSC40005HAFVRJN	3.7 x 2 x 1.8		<b>\$36,850</b>

### HYDRO-LOOP MAXI

Heavy duty systems suited to large jobs



Specifications

	Safety Class	Pressure	EWP with turbo	Flow	Max Temp	Engine	Pump
<b>Petrol version</b>							
HSC40005HAF#	A	4,000 psi (275 bar)	6,485 psi	20 lpm	130°C	Honda GX630	Bertolini TTK 2130
<b>Diesel versions</b>							
HSCX40005DG	A	4,000 psi (275 bar)	6,485 psi	20 lpm	130°C	Kubota 17HP	Interpump TSF 1819
HSCX40005D-HUSH	A	4,000 psi (275 bar)	6,485 psi	20 lpm	130°C	Kubota 20HP	Interpump TSF 1819

Stock codes & pricing

		Dimensions (LxWxH) m		
HSC40005HAF#	HSC40005HAFVR	4 x 2 x 1.8		<b>\$46,488</b>
HSCX40005DG	HSCX40005DGVR	4 x 2 x 1.8		<b>\$61,440</b>
HSCX40005D-HUSH	HSCX40005D-HVR	4 x 2 x 1.8		<b>\$72,103</b>

**NEW HYDRO-HUSH LOOP**  
Clean while the city sleeps



- ◆ Aussie Hydrotek engine drive industrial steam cleaner
- ◆ Vacuum filtration system with two stage motor, and two replaceable cartridge filters (NEW AZV88 ... more power for longer recovery lengths)
- ◆ 1000 litre poly impact resistant water tank
- ◆ Dual axle heavy duty trailer with tool box
- ◆ Two stainless steel hose reels; one with 30m of high pressure hose, and the other with 30 metres of low pressure supply hose
- ◆ 24.5" heavy duty Twister Vac rotary floor cleaner to clean & recover wastewater
- ◆ More Hydrotek options available ... call Aussie for more details

### FOR TRUCK OR TRAILER MOUNTING .... GET WITH THE EPA REGS!

You can build your own EPA compliant, environmentally friendly clean and capture system.

You'll need a top quality Hydrotek steam cleaner with onboard generator and a vacuum assisted recover/filtration unit. Choose one of our compatible HSC series Hydrotek systems from p 42-43.



#### Hydro-Loop component checklist...

		Price	tick box if required	
1.	HSC Hydrotek (see p 42-43 ... petrol or diesel)	\$	<input type="checkbox"/>	
	Model	Fill in required model & price		
2.	Water tank/skid set			
	HT270T	1,000 litre tank with support straps	\$2,191	<input type="checkbox"/>
3.	Vac recovery system			
	HAZV88	includes filtration system & 15 metres of vac hose	\$10,146	<input type="checkbox"/>
4.	24.5" ss flat surface cleaner			
	HANTV5	with vac recovery port	\$3,875	<input type="checkbox"/>
5.	High pressure hose reels & hose			
A.	HAR150 + AHW06K2414X2X30	5,000 psi stainless steel hot water reel with 30m non marking hot water high pressure hose	\$1,344	<input type="checkbox"/>
or B.	HAR151 + AHW06K2414X2X50	5,000 psi stainless steel hot water reel with 50m non marking hot water high pressure hose	\$1,772	<input type="checkbox"/>
NB.	FREE whip hose supplied with all orders for complete system, customer to specify length (max 3m)			
6.	Basic plumbing kit			
		including suction filter & couplings, details available on request	\$1,200	<input type="checkbox"/>
7.	Stand-by filter kit			
	HASF01	additional set of filters ready to swap in as required	\$637	<input type="checkbox"/>
		Total cost of selected kit	\$	+GST

FREE installation guidelines, footprint & recommended trailer spec available, suitable for installation by any competent engineering workshop

#### REPLACEMENT FILTERS & BERMS FOR RECOVERY UNIT

Part Number	Description	Price
HVFH07	Cartridge, 4.5" x 20", pleated polyester, 20 micron	\$105
HVFH10	Cartridge 4.5" x 20", 10 micron, pleated carbon	\$177
HVFH25	Cartridge, 4.5" x 20", string wound, 20 micron	\$56
HVFH50	Cartridge 4.5" x 20", string wound, 50 micron	\$56
HVB040	Oil skimmer bag	\$154
HVFB41	Duo flow dirt bag	\$93
HVFB05	Bag filter 7 x 32 - 5 micro (fits on tank lid)	\$46
HVFB85	Capture strainer bag, 800 micron (optional - for recovery only mode)	\$21
HASF01	Filter start up pack, complete series of filters	\$637
HMEV15	Vacuum motor 115v AC	\$428
HPS120	Transfer pump 12v	\$738
HDHV20	Vacuum hose 15 metres x 2"	Poa
HZMAT6	Sand berm 10' - sand not included	\$112
HATP75	Vacuum scupper pick up device 12"	\$341
HZMAT7	Deluxe sand berm 6' - sand not included	\$335
HATP40	Hydro vacuum arch, 6' ground pick device	poa



Always be armed with an extra filters for fast change out when on site.



The HVFB41 duo-flow dirt bag works as you debris catcher when recovering and processing. Switch to HVFB85 strainer bag when capture pump only is used.



HZMAT7 Deluxe berm for water retention and recovery using HATP75 (scupper)

**HASF01 Start up filter kit contains:** **\$637 SAVE 10%**  
 2 x HVFH07 Pleated cartridge filter 4.5" x 20", 20 microns  
 1 x HVF10 Carbon cartridge filter 4.5" x 20", 10 microns  
 1 x HVFB05 One bag filter for water tank - 7 x 32 - 5 microns  
 3 x HVFB41 Duo flow dirt bag, 400 micron mesh top, 100 micron bottom mesh bag



**GUNS & LANCES**

p56



**TURBOS**

p58



**NOZZLES**

p60



**MOTORS, ENGINES & SERVICE KITS**

p62



**UNLOADERS, THERMAL DUMP SAFETY VALVES**

p64



**COUPLINGS, SWIVELS, GAUGES, INJECTORS, FILTERS**

p66



**HOT WATER BOILER PARTS**

p68

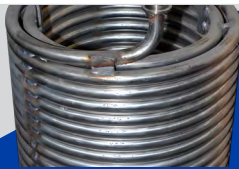

**HOSE & HOSE REELS**

p72



**ACCESSORIES GRIT BLAST KITS, FOAMERS, TELEWANDS, SPINNERS, CARTS, WHEELS**

p74



**500 BAR ACCESSORIES**

p78



**500 BAR PPE**

p80



## TRUST AN AUSSIE TO CLEAN FASTER & SAFER



### AUSSIE TOP GUNS ... COMPLETE PRO GUN/LANCE KITS

SAVE MONEY, SAVE TIME ... HAPPINESS IS THE FEEL OF A NEW GUN

HIGH PRESSURE ACCESSORIES



#### AUSSIE 4,000 PSI PRO-GUN KIT—DUAL



- 5,000 psi Aussie Pro Gun (M22 inlet)
  - 4,000 psi stainless steel dual lance (1019mm)
  - 2 x Laser cut nozzles (including one detergent, low pressure nozzle)
- |                  | nozzle | single buy   | 10 pack buy (each) |
|------------------|--------|--------------|--------------------|
| APROGUN-DUAL-035 | 035    | <b>\$310</b> | \$233              |
| APROGUN-DUAL-045 | 045    | <b>\$310</b> | \$233              |

#### AUSSIE 5,000 PSI PRO-GUN KIT—SINGLE



- 5,000 psi Aussie Pro Gun (M22 inlet, 4,000 psi or M24 5,000 psi rated options)
- 5,000 psi rated stainless steel single lance
- Laser cut nozzle (030, 035, 045)
- Packed weight 2kg
- Boxed dimensions 1180mm x 210mm x 45mm (900mm kit)

	lance	nozzle	single buy	10 pack buy (each)
APROGUN-900-030	900mm	030	<b>\$175</b>	\$131
APROGUN-900-035	900mm	035	<b>\$175</b>	\$131
APGUN-900-035M24	900mm	035	<b>\$186</b>	\$140
APROGUN-900-045	900mm	045	<b>\$175</b>	\$131
APGUN-900-045M24	900mm	045	<b>\$186</b>	\$140
APROGUN-1200-035	1200mm	035	<b>\$188</b>	\$141
APROGUN-1200-045	1200mm	045	<b>\$188</b>	\$141

#### PA 5,000 PSI PRO-GUN KIT



- 5,100 psi RL56 Spray Gun (Inlet: 3/8" BSP F)
- 5,000 psi rated 800mm stainless steel single lance with melted handle
- Laser cut nozzle & nipple to connect hose sold separately

MPA3045600	gun/lance kit	<b>\$213</b>
MPA13.5050.51	nipple	\$37
C915 ___ M	nozzle	\$22



#### NEW PA 500 BAR PRO-GUN KIT



- RL 57 7,250 psi (500 bar), 28 lpm, 160°C, permissible pressure 8,000 psi (Inlet 3/8" BSP F)
- 5,800 psi (400 bar) 1050mm lance with melted handle, permissible pressure 6,400 psi, 160°C, Outlet 1/4" NPT F
- Ceramic nozzle sold separately (page 60)

MPA30473000 gun/lance kit **\$621**



**WARNING ... LEAKING GUNS ARE DANGEROUS!**



### GREAT RANGE, HUGE STOCKS, EXCEPTIONAL PRICES

▲ ◆ ● ◆ ■ Match the symbols for best compatibility between gun, lance, turbo and hose

#### HOBBY GUN UPGRADE KIT

(Pro kit for hobby machines)

Hobby gun kit complete with AL13 gun, Vario lance & 8 metres of wire braid pro high pressure hose Includes 14mm to 15mm coupling adaptor



AGPDGLNH120

\$151

#### NEW COMMERCIAL AL13

(Aussie Cougar & AB22, AB30)



BEST BUY ▲

AL13 (with M22 inlet)

3,340 psi (230 bar), 30 lpm, 60°C

Permissible pressure 3,700 psi

Inlet M22 QC M

Outlet M22 QC F

300mm lance extension with user friendly grip

Use with vario lance or single lance



M4021108007

\$66

#### NEW PROFESSIONAL AL55

(all Aussie 3,000 & 4,000 psi blasters & steam cleaners) ◆

AL55 (with M22 & swivel)

4,500 psi (310 bar), 45 lpm, 160°C

Permissible pressure 5,075 psi

Inlet M22 QC M

Outlet M22 QC F



300mm lance extension, use with single or double lance

M4022209003

\$89

AGP100882 o-ring (suits couplings with back-up ring) \$0.38

C01177407600 back up ring (suits couplings with back-up ring) \$5



#### INDUSTRIAL VEGA + EXTENSION

PA VEGA gun & S3 extension ●

4,500 psi (310 bar), 40 lpm, 160°C

Permissible pressure 5,100 psi, 1.1kg

370mm melted handle, stainless steel pipe

Inlet 3/8" BSP M (with swivel)

Outlet M22 QC F

MPA30208300

\$157

(25 pack bulk buy ... call for details)



#### INDUSTRIAL SPRAY GUN

(all Aussie 5,000 psi blasters & steam cleaners) ◆

DG5010

5,000 psi (350 bar), 40 lpm, 160°C

Inlet 3/8" G F

Outlet 1/4" G F

Use with extended double lance or

extended single lance

CGPDG5010

\$85

(20 pack bulk buy ... call for details)

Replacement safety clip AGP2660026 \$8



BEST BUY



#### INDUSTRIAL SPRAY GUN

(with swivel) ◆



BEST BUY

RL37 with swivel

4,500 psi (310 bar), 40 lpm, 160°C

Permissible pressure 5,000 psi, 564 gms

Inlet 3/8" BSP F (with swivel)

Outlet 1/4" BSP F

Use with extended double lance

or extended single lance

MPA30122000

\$93

(15 pack bulk buy ... call for details)



#### INDUSTRIAL RL56 COMPENSATED

Spray Gun (used on Aussie Predators & Hurricanes) ◆

5,100 psi (350 bar), 30 lpm, 160°C

Permissible pressure 5,650 psi, 672gms

Inlet 3/8" BSP F

Outlet 1/4" BSP F

MPA30450010

\$132

(8 pack bulk buy ... call for details)



#### 8,000 PSI RL 84 SPRAY GUN

(all Aussie Raptor Hydro-blasters) ■

7,300 psi (500 bar), 80 lpm, 100°C, 1.3kg

Permissible pressure 8,100 psi

Inlet 1/2" BSP F

Outlet 1/2" BSP F

Use P/A single lance

MPA30540000

\$449

(300mm shoulder rest MPA30506000 \$53)



## A LANCE FOR ALL OCCASSIONS

▲ ◆ ● ◆ ■ Match the symbols for best compatibility between gun, lance, turbo and hose

HIGH PRESSURE ACCESSORIES

### T10 VARIO ZOOM NOZZLE & LANCE ▲



**3,000 psi (200 bar)**, 30 lpm, 60°C, Permissible pressure 3,200 psi

Length 585mm

Inlet M22

Use with AL13

C4723.45.115 \$89



### LANCE EXTENSION ▲ ◆ ● ◆



Stainless steel extension with melted handle

**4,000 psi (275 bar)**, permissible pressure 5,000 psi,

40 lpm, 150°C, Inlet ¼" G M, Outlet ¼" G M

(If used with AL13 or AL55 gun requires nipple C1500.05 \$9)

300 mm C3804.00 \$40

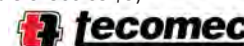

### STAINLESS SINGLE LANCE ▲ ◆ ● ◆

with melted handle, tip protector & nozzle holder



(If used with AL13 or AL55 gun requires nipple C1500.05 \$9)

**4,500 psi (310 bar)**, permissible pressure 5,075 psi,

40 lpm, 150°C, Inlet ¼" G M, Outlet ¼" NPT F

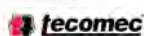

400 mm	C3930.00	\$40	1200 mm	C3905.16	\$69
700 mm	C3905.14	\$46	1500 mm	C3905.17	\$83
900 mm	C3905.15	\$54	2000 mm	C3905.19	\$100

Requires M series nozzle, sold separately, p60

To use with Q series (Quik Tip) nozzles add fixed QC (CD10073 \$26)

Replacement nozzle protector C3718.02 \$9

### SINGLE LANCE WITH QC ▲ ◆ ● ◆

Convenient nozzle changeover



**4,000 psi (275 bar)**, 40 lpm, 60°C

Inlet M22 M

Outlet QC

400 mm	FNA7103550	\$48
700 mm	FNA7103261	\$74

Requires Q series nozzle, sold separately, p60

### STAINLESS DOUBLE LANCE ▲ ◆ ●

Infinite pressure control with the twist of the wrist

Heavy duty, stainless steel double lance, suits all pro guns

**3,625 psi (250 bar)**, 40 lpm, 150°C, permissible pressure 4,060 psi

Length 684mm  
Inlet M22 M  
Outlet 2x¼" NPT F  
S/code: C3924.01  
**\$105**



Require two M series nozzles, sold separately, p60



### PA EXTENDED SINGLE LANCE ◆

with melted handle and protector



**5,000 psi (350 bar)**, 30 lpm, 160°C,  
permissible pressure 5,650 psi (390 bar),

Inlet ¼" BSP M

Outlet ¼" NPT F

800 mm	MPA40025800	\$110
1050 mm	MPA40026100	\$132

Requires M series nozzle, sold separately, p60  
(8 pack bulk buy ... call for details)



### STAINLESS DOUBLE LANCE with extension ◆

Heavy duty, stainless steel double lance, suits all pro guns

**3,625 psi (250 bar)**, 40 lpm, 150°C, permissible pressure 4,060 psi

Length 1019mm  
Inlet ¼" G M  
Outlet 2 x ¼" NPT F  
S/code: C3916.03  
**\$168**



Require two M series nozzles, sold separately, p60

### RL 800 500 BAR PA SINGLE S/S LANCE ■

Suits RL84, **7,300 psi (500 bar)**,

Permissible pressure 8,100 psi, 200 lpm,  
43°C, Inlet ½" BSP M, Outlet ¼" NPT F

400mm	MPA30500040	\$226
800mm	MPA30500080	\$291
1250mm	MPA30500092	\$418

Requires M series nozzle, sold separately, p60





### SAVE WATER & CUT TIMES ... TURBO BOOST

Aussie turbos use the water's velocity to increase the effective working pressure (EWP). Let Aussie Turbomaster do the work for you!

#### AUSSIE TURBOMASTER ▲



Commercial series (220 bar)  
**3,200 psi, 60 lpm**, EWP up to 4,500 psi, 500mm, M22 inlet  
 Nozzle size: 030  
 Suits: Cougar, AB30, F140, Black Box, Scud 100  
 M404210004 lance & head **\$157**

#### AUSSIE TURBOMASTER 255 ▲ ◇



Professional series, 500mm lance & head  
**3,700 psi (255 bar) 40 lpm**, EWP up to 4,785 psi, 300  
 Max temp: 90°C Inlet (lance) M22 x 1.5 M Weight: 450 gms

CTN255-\_\_\_ lance & head **\$214**  
 Sizes available ... 030, 035, 045, 050

#### AUSSIE TURBOMASTER 310 ◇ ●



Professional series, 500mm lance & head  
**4,400 psi (310 bar) 24 lpm**, EWP up to 6,294 psi  
 Max temp: 90°C Inlet (lance) M22 x 1.5 M Weight: 600 gms

CTN310-\_\_\_ lance & head **\$262**  
 Sizes available ... 030, 035, 045

#### AUSSIE TURBOMASTER 400 ◇ ●



Professional series, 500mm lance & head  
**5,800 psi (400 bar) 40 lpm**, EWP up to 8,500 psi  
 Max temp: 90°C Inlet (lance) M22 x 1.5 M Weight: 900 gms

CTN400-\_\_\_ lance & head **\$394**  
 Sizes available ... 030, 035, 045, 050, 055, 075

#### PRO TURBO GUN KITS ... FAST, TOOL FREE CHANGEOVER

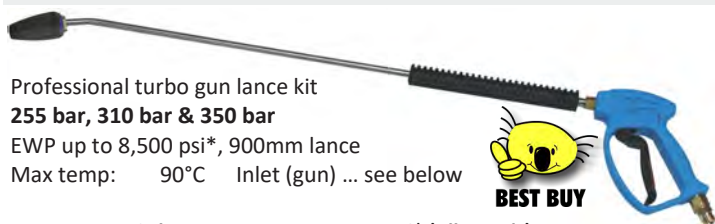

Professional turbo gun lance kit  
**255 bar, 310 bar & 350 bar**  
 EWP up to 8,500 psi\*, 900mm lance  
 Max temp: 90°C Inlet (gun) ... see below



**Up to 3,500 psi, boosts EWP to max 4,785 psi\* (All Brands)**  
 CTN255-030GLK suits AB30 (M22) **\$309**  
 CTN255-045GLK suits Scud 350 (M22) **\$309**  
**Up to 4,400 psi, boosts EWP to max 6,295 psi\* (All Brands)**  
 CTN310-030GLK suits AB40 (M22) **\$335**  
**Up to 5,000 psi, boosts EWP to max 8,500 psi\* (All Brands)**  
 CTN400-035GLK suits Scud 400, Atlas (M22) **\$430**  
 CTN400-050GLK suits Ultra A, Mon 400M (M22) **\$430**  
 CTN400-035GLKM24 Pred A, Hurricane (M24) **\$441**  
 CTN400-040GLKM24 HSC 5,000 psi (M24) **\$441**  
 CTN400-045GLKM24 Pred A diesel (M24) **\$441**  
 Call for bulk pricing (\*dependant on pump capability)

#### 500 BAR TURBO GUN KIT



**7,300 psi, 500 bar, 40 lpm**, EWP up to 12,000 psi  
 RL 57 spray gun with 1050mm lance, gun, with QC M24 nipple & 500 bar turbo head.

CTN500-020GLK suits Raptor 12 **\$2,244**  
 CTN500-030GLK suits Raptor 16,18 **\$2,244**  
 sCTN500-030GLK suits Raptor 16,18 **\$2,244**

#### AUSSIE TURBOMASTER HEADS

**Semi pro series**  
**3,400 psi (234 bar)**  
 EWP up to 4,785 psi  
 Max temp: 90°C  
 Inlet QC plug



FNA40143 **\$94**

**Professional series** ▲ ◇  
**3,700 psi (255 bar)**  
 EWP up to 4,785 psi  
 Max temp: 90°C  
 Inlet 1/4" F  
 Weight 300 gms



CTN255-\_\_\_H **\$173**  
 Sizes available ...  
 020, 025, 030, 035, 040, 045,  
 050, 055, 060, 065, 070, 075,  
 100, 150  
**Repair kit**  
 CTN255-\_\_\_REP **\$111**

**Professional series** ◇ ●  
**4,400 psi (310 bar)**  
 EWP to 6,294 psi  
 Max temp: 90°C  
 Inlet 1/4" F  
 Weight 450 gms



CTN310-\_\_\_H **\$222**  
 Sizes available ...  
 030, 035, 045  
**Repair kit**  
 CTN310-\_\_\_REP **\$121**

**Professional series** ◇ ●  
**5,800 psi (400 bar)**  
 EWP to 8,500 psi  
 Max temp: 90°C  
 Inlet 1/4" F  
 Weight 750 gms



CTN400-\_\_\_H **\$322**  
 Sizes available ...  
 030, 035, 040, 045, 050, 055,  
 060, 065, 070, 075, 080, 085  
**Repair kit**  
 CTN400-\_\_\_REP **\$145**

**500 bar series** ■  
**7,300 psi, 500 bar**  
 EWP to 12,000 psi  
 Max temp: 90°C  
 Inlet 1/4" F  
 Weight 700 gms



CTN500-\_\_\_H **\$1,684**  
 Sizes available ...  
 020, 025, 030, 035, 040, 045,  
 050, 055, 060, 065, 070, 075,  
 080  
**Repair kit**  
 CTN500-\_\_\_REP **\$1,122**

HIGH PRESSURE ACCESSORIES

6

### HIGH PRESSURE NOZZLES CHANGE THAT NOZZLE

Worn nozzles cause loss of pressure & can lead to machine failure. Nozzles should be changed on a regular basis.

Drain cleaning nozzles ... see p 30



#### SINGLE BUY NOZZLES

Look up size & angle of required nozzle in selection table then add a 'M' for a Laser Cut nozzle or 'Q' for a Quik Tip nozzle

##### Laser Cut (Inlet: 1/4" NPT)



Add 'M' to code (eg C900080M) **BEST BUY** \$22  
(NOT AVAILABLE IN 40°)

Detergent Nozzle C915500MSS \$22

##### Quik Tip



Add 'Q' to code (eg C900080Q) \$20

Detergent Nozzle (Black 65°) C965400Q \$20

#### LASER CUT 'M' SERIES NOZZLE 5 PACKS

S/code	Qty in pack	Tip angle	
C915__M-P1	5	15	\$96
Packs available for sizes 020 to 065			
C915500MSS-P1	5	Detergent	\$96



**BEST BUY**

#### QUIK TIP 'Q' SERIES NOZZLE 5 PACKS

S/code	Qty in pack	Nozzle size	
C105082Q	5	030	\$74
C105083Q	5	035	\$74
C105084Q	5	040	\$74
C105085Q	5	045	\$74
C105087Q	5	055	\$74



**BEST BUY**

Tip: Use a fixed quick coupler to connect a Q series nozzle to a lance with a 1/4" NPT female outlet (see below)

Quik Tip (Q) nozzles 5 pack...



#### Quik Tip 'Q' Series Colour Guide

Red ... 0°

Pencil jet for maximum effect



Yellow ... 15°

Cleaning heavily stained areas



Green ... 25°

General purpose nozzle for larger areas



White ... 40°

Lightly stained flat surfaces



Black ... 65°

Low pressure detergent nozzle



#### GP FIXED QUICK COUPLING

Max pressure 6,000 psi (410 bar), stainless steel quick connect couplers to connect Aussie Quik Tip nozzles to end of lance

	S/code	Inlet	Outlet	
A	CD10072	1/4" QC	1/4 G - F	\$25
B	CD10073	1/4" QC	1/4 G - M	\$25



(A) (B)

#### AUSSIE WHITE TIP ... 500 bar

Ceramic Tipped Nozzles .... SAFER, LONGER LASTING

500 bar 0° & 15°, nozzle material ceramic, inlet 1/4" NPT M ... \$142 each

Size	0° (pencil jet)	15° (fan)
025	M0124006100	M0124006110
030	M0124006200	M0124006210
035	M0124006300	M0124006310
040	M0124006400	M0124006410
045	M0124006500	M0124006510
050	M0124006600	M0124006610



HIGH PRESSURE ACCESSORIES

6

**Change your nozzle regularly;** nozzles wear with use and can cause your pump and system to fail.

Correct nozzle sizing is essential for your machine's correct performance.

### How to Read the Chart

1. Main chart area is flow in litres per minute.
2. Look up the pump psi in the heading and read down that column to the approximate flow. Read off the MEG size in the row heading.
3. Drop one size because calculation should always be made using 93% of pump flow.

MEG	Sizing for vario & grit-blast heads	Flow in l/min at the indicated pressures																									
		20 BAR	30 BAR	40 BAR	50 BAR	60 BAR	70 BAR	80 BAR	90 BAR	100 BAR	110 BAR	120 BAR	130 BAR	140 BAR	150 BAR	160 BAR	180 BAR	200 BAR	220 BAR	250 BAR	280 BAR	310 BAR	340 BAR	370 BAR	400 BAR	450 BAR	500 BAR
		290 psi	435 psi	580 psi	725 psi	870 psi	1015 psi	1160 psi	1305 psi	1450 psi	1595 psi	1740 psi	1885 psi	2030 psi	2175 psi	2320 psi	2610 psi	2900 psi	3190 psi	3625 psi	4060 psi	4560 psi	5000 psi	5440 psi	5880 psi	6525 psi	7250 psi
020	0,99	2	2,5	2,8	3,2	3,5	3,7	4	4,2	4,5	4,7	4,9	5,1	5,3	5,5	5,7	6	6,4	6,7	7,6	7,7	8,1	8,2	8,8	9,2	9,8	10,3
025	1,00	2,5	3,1	3,5	4	4,3	4,7	5	5,3	5,6	5,9	6,1	6,4	6,6	6,9	7,1	7,5	7,9	8,3	8,9	9,4	9,9	10,3	10,8	11,2	11,9	12,5
030	1,09	3,1	3,7	4,3	4,8	5,3	5,7	6,1	6,3	6,8	7,2	7,4	7,7	8	8,3	8,7	9,2	9,6	10	10,8	11,4	12	12,5	13,1	13,6	14,4	15,2
035	1,15	3,6	4,4	5,1	5,6	6,2	6,7	7,3	7,7	8,1	8,4	8,8	9,2	9,6	9,9	10,4	10,9	11,4	12	12,6	13,4	14,1	14,8	15,4	16,0	17,0	17,9
040	1,19	4,2	5,2	5,9	6,6	7,3	7,8	8,4	8,9	9,4	9,8	10,3	10,7	11,1	11,5	11,9	12,4	13,2	14,1	14,1	14,7	16,0	16,9	17,5	18,2	19,3	20,3
045	1,27	4,5	5,5	6,4	7,1	7,8	8,4	9	9,6	10,2	10,6	11,2	11,6	11,8	12,5	12,6	13,2	14,4	15	16,3	17,2	18,1	19,0	19,5	20,6	21,8	23,0
050	1,35	5	6,2	7,1	8	8,7	9,4	10	10,7	11,3	11,7	12,1	12,9	13,4	13,8	14,3	15,1	15,9	16,9	17,9	18,9	19,9	20,9	21,8	22,7	24,2	25,5
055	1,4	5,6	6,8	7,8	8,7	9,6	10,3	11,1	11,8	12,4	13	13,5	14,1	14,7	15,2	15,7	16,4	17,5	18,6	19,8	20,9	22,0	23,0	24,0	25,0	26,5	28,0
060	1,47	6	7,4	8,6	9,6	10,4	11,3	12,1	12,8	13,6	14,2	14,9	15,5	16	16,6	17,2	18	19,2	20,4	21,5	22,9	24,1	25,3	26,4	27,4	29,1	30,6
065	1,52	6,6	8	9,3	10,4	11,3	12,3	13,2	14	14,7	15,5	16,1	16,7	17,4	18	18,6	19,4	20,7	22	22,9	24,8	26,1	27,3	28,5	29,6	31,4	33,1
070	1,6	7,1	8,6	10	11,2	12,2	13,2	14,1	15	15,8	16,6	17,3	18	18,7	19,3	20,1	21,3	22,3	23,7	25,3	26,8	28,2	29,5	30,8	32,0	33,9	35,8
075	1,65	7,6	9,3	10,7	12	13,1	14,2	15,2	16,1	16,9	17,7	18,5	19,2	20	20,7	21,4	22,6	23,8	25,3	27,0	28,6	30,1	31,5	32,9	34,2	36,2	38,2
080	1,7	8	9,8	11,3	12,7	14	11,1	16,1	17,1	18	18,9	19,7	20,5	21,3	22	22,8	23,8	25,4	27	28,8	30,5	32,0	33,6	35,0	36,4	36,8	40,7
085	1,75	8,5	10,4	12,1	13,5	14,8	16	17,1	18,1	19,1	20	20,9	21,7	22,5	23,4	24	25,5	27	28,2	30,7	32,5	34,2	35,8	37,3	38,8	41,2	43,4
090	1,8	9,8	11,5	13,3	14,8	16,3	17,6	18,8	19,9	21,0	22,0	23,0	23,9	24,8	25,7	26,6	28,2	29,7	31,1	33,2	33,5	37,0	38,7	40,4	42,0	44,5	47,0
095	1,85	9,7	11,9	13,4	15,4	16,8	18,1	19,4	20,0	21,7	22,7	23,8	24,7	25,9	26,9	27,8	29,5	31,1	32,6	34,8	36,8	38,7	40,6	42,3	44,0	46,7	49,2
100	1,9	10	12,3	14,2	16,0	17,8	19,2	20,6	21,8	23,0	24,1	25,2	26,2	27,2	28,2	29,1	30,9	32,5	34,1	35,4	38,5	40,5	42,4	44,2	46,0	48,8	51,4
110	1,98	11,1	13,6	15,7	17,6	19,3	20,8	22,2	23,6	24,9	26,2	27,4	28,5	29,6	30,6	31,6	33,5	35,4	37,1	39,5	41,8	44,0	46,1	48,1	50,0	53,0	55,9
120	2,08	12,1	14,8	17,2	19,2	21,0	22,7	24,3	25,8	27,1	28,1	29,4	30,6	31,8	32,9	34,0	36,0	38,0	39,8	42,4	45,0	47,6	50,2	51,9	54,0	57,3	60,4
125	2,13	12,7	15,6	18,0	20,1	22,0	23,8	25,5	27,0	28,5	29,5	30,8	32,1	33,3	34,5	35,6	37,8	39,8	41,8	44,5	46,9	49,3	51,6	53,9	56,0	59,4	62,6
130	2,16	13,2	16,1	18,6	20,8	22,8	24,6	26,3	27,9	29,4	30,8	32,2	33,5	34,8	36,0	37,2	38,9	42,5	44,5	47,4	50,2	52,8	55,3	57,7	60,0	63,6	67,1
140	2,26	14,2	17,4	20,0	22,4	24,5	26,5	28,4	30,1	31,7	33,2	34,7	36,1	37,5	38,8	40,1	42,5	44,8	47,0	50,1	53,2	56,3	59,4	61,7	64,4	67,9	71,6
150	2,34	15,1	18,5	21,3	23,9	26,1	28,3	30,2	32,1	33,8	35,6	37,2	38,7	40,2	41,6	43,0	45,6	48,0	50,4	53,7	57,0	59,9	62,7	65,4	68,0	72,1	76,0
160	2,41	16,2	19,8	22,9	25,6	28,0	30,3	32,4	34,4	36,2	37,8	39,5	41,1	42,7	44,2	45,6	48,4	51,0	53,5	57,0	60,2	63,4	66,4	69,2	72,0	76,4	80,5
180	2,54	18,2	22,3	25,7	29,0	31,8	34,3	36,7	38,6	41,0	43,0	44,9	46,7	48,5	50,2	51,9	55,0	58,0	60,8	64,8	68,6	72,2	75,6	78,9	82,0	87,0	91,7
200	2,69	20,1	24,7	28,5	32,5	35,6	38,5	41,1	43,6	46,0	48,2	50,4	52,4	54,4	56,3	58,2	61,7	65,1	68,2	72,7	77,0	81,0	84,8	88,5	92,0	97,6	102,9
250	2,99	25,2	30,9	35,7	39,8	43,6	47,1	50,4	53,4	56,4	59,1	61,8	64,3	67,0	69,1	71,3	75,1	79,8	84,0	89,3	94,6	99,9	105,2	109,8	114,1	120,9	127,5



### YANMAR ENGINES & ACCESSORIES

Model	Stock Code	Description	List Price
Yanmar (L-N series)			
L48N recoil start	EL48N5-MTMYI	4.8HP, 3/4" keyway shaft, recoil	\$2,220
L48N electric start	EL48N5-METMYI	4.8HP, 3/4" keyway shaft, electric	\$2,870
L48N recoil start	EL48N5-PTMYI	4.8HP, 3/4" pump shaft (threaded), recoil	\$2,220
L48N electric start	EL48N5-PETMYI	4.8HP, 3/4" pump shaft (threaded), electric	\$2,870
L70N recoil start	EL70N5-MTMYI	7HP, 1" keyway shaft, recoil	\$2,830
L70N electric start	EL70N5-METMYI	7HP, 1" keyway shaft, electric	\$3,480
L70N electric start	EL70N5-PEATMYI	7HP, 3/4" pump shaft (threaded), electric	\$3,480
L70N electric start	EL70N5-PETMYI	7HP, 1" pump shaft (threaded), electric	\$3,480
L100N electric start	EL100N5-METMYI	10HP, 1" keyway shaft, electric	\$3,990
Engine Care Kits			
L48N	EAPFKL48N	Includes air filter element, fuel filter element, oil filter strainer, fuel filter strainer, 1 litre of SAE40 oil	\$166
L70N & L100N	EAPFKL100N	Includes air filter element, fuel filter element, oil filter strainer, fuel filter strainer, 2 litres of SAE40 oil	\$195



Yanmar engine care kit

HIGH PRESSURE ACCESSORIES

	PE-Nano	PE-Manual	PE-Auto
Keyless Start & Stop	Yes	Yes	Yes
Tachometer	Yes	Yes	Yes
Hourmeter	Yes	Yes	Yes
Low Oil Pressure Protection	Yes	Yes	Yes
Battery Monitoring	Yes	Yes	Yes
99hr Run Timer		Yes	Yes
Fault Indicator	Yes	Yes	Yes
Fault Error Log	Yes	Yes	Yes
2 Wire Start/Stop		Yes	Yes
Twin Float Start/Stop		Yes	Yes
Loss of Prime			Yes
7 Day Repeatable Start/Stop Timer			Yes
Daily Start/Stop Timer (Mon-Sun)			Yes
<b>List price</b>	<b>\$1,710</b>	<b>\$2,850</b>	<b>\$3,591</b>

Yanmar engine protection kits for L series engines



#### OPTIONAL EXTRAS

Remote Stop (E-stop) (must be bought with PE panel)	\$427	\$427	\$427
Remote 3/4G Monitoring & Control Telemetry Package			\$5,719 (includes PE Auto)
Transducer for pump Pressure & Protection		\$427	\$427
8 pin customer plug for auto start connection		\$120	\$120



### ENGINE FUEL CONSUMPTION RATES

#### Honda

	fuel tank size (l)	Fuel consumption at 3600 rpm (lph)	Approx. running time (hours)
GX120	2	1	2.00
GX160	3.1	1.4	2.21
GX200	3.1	1.7	1.82
GX240	5.3	2.1	2.52
GX270	5.3	2.5	2.12
GX390	6.1	3.7	1.65

Running times are calculated from engine manufacturers figures and are based on 100%.

Times will vary depending on site conditions.

**RECOMMENDED ENGINE OIL ... SAE 10W-30**

#### Yanmar

	fuel tank size (l)	Fuel consumption at 3600 rpm (lph)	Approx. running time (hours)	Fuel consumption at 3000 rpm (lph)	Approx. running time (hours)
L48	2.4	1.2	2.00	1.05	2.29
L70	3.3	1.7	1.94	1.55	2.13
L100	5.4	2.5	2.16	2.2	2.45

#### Hatz

	fuel tank size (l)	Fuel consumption at 3600 rpm (lph)	Approx. running time (hours)	Fuel consumption at 3000 rpm (lph)	Approx. running time (hours)
1B20	3	1.05	2.86	0.9	3.33
1B30E	5	1.68	2.98	1.45	3.45
1B40E	5	2.35	2.13	1.95	2.56
1B50E	5	2.54	1.97	2.05	2.44

### HATZ DIESEL ENGINES & ACCESSORIES

Model	S/code	Description	
<b>Hatz (B series)</b>			
1B20	E1B20	4.2HP recoil start	\$1,820
1B30E	E1B30E	6.4HP electric start	\$2,732
1B40E	E1B40E	9HP electric start	\$3,694
1B50E	E1B50E	11HP electric start	\$4,147

#### Hatz Engine Service Kits

Service kit includes air filter, fuel filter, head gasket, O-rings & engine oil

1B20	EH85280455	Includes air filter, fuel filter, head gasket, o-rings, 1 litre of 15W-40 oil	\$177
1B30E	EH85280456	Includes air filter, fuel filter, head gasket, o-rings, 1 litre of 15W-40 oil	\$184
1B40E/1B50E	EH85280457	Includes air filter, fuel filter, head gasket, o-rings, 2 litres of 15W-40 oil	\$212



### GREAT RANGE, HUGE STOCKS, EXCEPTIONAL PRICES

#### MONSOON ELECTRIC MOTORS ... HOLLOW SHAFT



Suit direct coupling to most pump models, four pole 1450 rpm, 50Hz, slow speed IP56 spray protection. As used in the Aussie Monsoon series.

- ◆ Quality Italian made
- ◆ 12 months warranty
- ◆ Easy fit & compact

\*c/w 16 amp capacitor

HIGH PRESSURE ACCESSORIES

6

S/code	kW	HP	Motor	Shaft mm		Suits	
A140060M001	2.2	3	1 phase, 240V	24	*IP56	WEL/WBL	\$588
A140060T001	5.5	7.5	3 phase, 415V	24	IP56	TTV/TTL	\$788
A140060T002	7.5	10	3 phase, 415V	24	IP56	TTV/TTL	\$1,425
A140060T004	7.5	10	3 phase, 415V	30	IP56	KT/KTV	\$1,425
A140060T025	11	15	3 phase, 415V	24	IP56	TTL/TTK	\$1,680
A140060T003	11	15	3 phase, 415V	30	IP56	KT/KTV	\$1,680
A140060T020	12.5	17	3 phase, 415V	24	IP56	KTL	\$1,820
A140060T024	12.5	17	3 phase, 415V	24	IP56	KT/KTV/HDS	\$1,820
A140060T009	12.5	17	3 phase, 415V	30	IP56	TTK/RA	\$1,820
A140060T026	15	20	3 phase, 415V	24	IP56	RA/RAL/RAS	\$2,486



### GREAT RANGE, HUGE STOCKS, EXCEPTIONAL PRICES

HIGH PRESSURE ACCESSORIES

6

#### BERTOLINI APR I20

**2,000 psi** (140 bar), 15 lpm, 60°C  
 Inlet ½" BSP M  
 Outlet M22x1.5 M  
 Bypass Internal (2 x ⅜")  
 Weight 900 gms



**Detergent injection**  
 BAPRI20ADJ **\$205**  
**No Detergent injection**  
 BAPRI 20 **\$205**

Repair kit ... BAPRI20REP **\$88**  
**Banjo Bolts** to suit  
 Outlet ... ⅜" ... B050157532 \$26  
 Inlet ... ⅜" ... B050156532 \$38  
 O-rings to suit ⅜" bolt (2 required) B803181202 \$3

#### BERTOLINI APR I35

(used on AB30)

**3,500 psi** (240 bar), 15 lpm, 60°C  
 Inlet ½" BSP M  
 Outlet M22x1.5 M  
 Bypass Internal (2 x ⅜")  
 Weight 1.2kg



**Detergent injection**  
 BAPRI-35ADJ **\$220**

**Banjo Bolts** to suit  
 Outlet ... ⅜" ... B050157532 \$26  
 Inlet ... ⅜" ... B050156532 \$38  
 O-rings to suit ⅜" bolt (2 required per bolt)  
 B803181202 \$3

#### VRF2

(used on Super Indys)

**3,190 psi** (220 bar) rated pressure  
 3,625 psi permissible pressure  
 30 lpm, 90°C  
 Outlet ⅜" BSP F  
 M4072401001 **\$119**



**Banjo Bolts** to suit  
 IP W151 or above valve  
 By pass G ⅜" & G ½"

M4073900000 **\$83**

#### BERTOLINI APR I40

(Suits Stella 200, AB40)

**4,000 psi** (275 bar), 21 lpm, 60°C  
 Inlet ½" BSP M  
 Outlet M22x1.5 M  
 Bypass Internal (½", ⅜")  
 Weight 1.2kg  
**Detergent injection**  
 BAPRI 40ADJ **\$253**



**Banjo Bolts** to suit  
 Outlet ... ⅜" ... B050157532 \$26  
 O-rings to suit ⅜" (2 required) B803181202 \$3  
 Inlet ... ½" ... B050158532 \$26  
 O-rings to suit ½" bolt (2 required) B803198002 \$2

#### VRT3 MULTIFUNCTION

inc safety valve, thermal dump & injector

**4,060 psi** (280 bar) rated pressure  
 4,500 (310 bar) permissible pressure,  
 30 lpm, thermal dump activates at 56°C  
 Inlet ⅜" BSP M  
 Outlet ⅜" BSP M  
 Bypass ⅜" BSP F  
 Weight 970 gms



M4072000019 **\$169**



#### 4,000 PSI VRF2

(used on Admirals)

**4,060 psi** (280 bar) rated pressure  
 4,500 psi permissible pressure  
 30 lpm, 90°C  
 Outlet ⅜" BSP F  
 Weight 545gms



M4072401000 **\$181**

**Banjo Bolts** to suit  
 By pass G ⅜" & G ½"

M4073900000 **\$83**

#### VRT3-310 (suits Hydrotek units including Heatwave)



**4,500 psi** (310 bar) rated pressure  
 Flows to 40 lpm  
 Inlet ⅜" NPT F  
 Outlet ⅜" NPT F  
 Bypass ⅜" NPT F



HUU323 **\$284**

#### VRT3 (suits Stella 100 & some Scuds)

**3,200 psi** (220 bar) rated pressure  
 3,630 (250 bar) permissible pressure,  
 30 lpm, with gauge port, blue spring  
 Inlet ⅜" BSP F  
 Outlet ⅜" BSP F  
 Bypass ⅜" BSP F  
 Weight 790 gms



M215010400 **\$144**



#### VRT100

(replaces 80/280 on large flow machines)

**4,640 psi** (320 bar),  
 5,075 psi permissible pressure  
 100 lpm, 90°C  
 Inlet ½" BSP F  
 Outlet ½" BSP F  
 Bypass 2 x ½" BSP F  
 Weight 1.17kg



M4072000033 **\$269**



#### VB350 (used on Scuds)

**5,000 psi** (350 bar), 40 lpm, 90°C  
 5,650 psi permissible pressure  
 Inlet ⅜" BSP M  
 Outlet ⅜" BSP F  
 Bypass ½" BSP F  
 Weight 920 gms  
 BVB350 **\$273**  
 (5 pack bulk buy ... \$232 each)



#### VB53 (AISI 303) (used on Raptors)

**8,000 psi** (550 bar), 80 lpm, 90°C  
 Inlet ½" BSP F  
 Outlet ½" BSP F  
 Bypass ½" BSP F  
 Weight 1.03kg  
 BVB53 **\$1,121**



#### VB60/600 ZERO

**8,700 psi** (600 bar)  
 permissible pressure,  
 60 lpm, 60°C  
 Inlet ½" BSP F  
 Outlet ½" BSP F  
 Bypass ½" BSP F  
 MPA60260000 **\$1,309**





### ACCESSORIES UP TO 600 BAR (8,700 PSI)

HIGH PRESSURE ACCESSORIES

6

#### VB200/280

**4,060 psi (280 bar)** rated pressure  
4,500 (310 bar) permissible pressure,  
200 lpm, 90°C  
Inlet 3/8" BSP F  
Outlet 3/8" BSP F  
Bypass 3/8" BSP F  
Weight 3.48kg

MPA60430000

\$996



#### K1 (INTERPUMP)

**3,625 psi (250 bar)** rated pressure  
41 lpm, 90°C  
Inlet 3/8" BSP F  
Outlet 3/8" BSP M  
Bypass 1/2" BSP M

BIZK1

\$300



#### K7 (INTERPUMP)

**3,000 psi (210 bar)** rated pressure  
41 lpm, 90°C  
Inlet 3/8" BSP F  
Outlet 3/8" BSP M  
Bypass 1/2" BSP F

BIZK70

\$315



#### Thermal Dump Valves

#### THERMAL DUMP VALVES

Dumps water at pre-determined temperature to protect pump when on bypass. Dump temp 63°C, max pressure 145 psi, hose barb 7mm (15 pack bulk buy ... call for details)



Inlet

MPA60063000	1/4" BSP M	\$40
MPA60063050	3/8" BSP M	\$40
MPA60063070	1/2" BSP M	\$40
AGP100558	1/2" MPT (AB42)	\$32

#### Safety Valves

Protects pump and unloader from pressure spikes (not pre-set).

#### MG1000

**3,600 psi (250 bar),**  
30 lpm, 90°C  
Inlet: 3/8" BSP M

MTM00033003

\$48



#### VS240

**3,500 psi (240 bar)**  
4,200 psi permissible pressure  
24 lpm, 60°C  
Inlet 3/8" BSP M

MPA60156000

\$71

(15 pack bulk buy ... call for details)



#### VS350

**5,000 psi (350 bar),** 25 lpm, 90°C  
5,650 psi permissible pressure  
Inlet: 3/8" BSP F  
Bypass: 3/8" BSP F  
Weight: 480 gms

MPA60058000

\$112

(5 pack bulk buy ... \$88)



#### HYDROTEK BURST DISK & PRESSURE RELEASE VALVE

**8,000 psi (550 bar)**  
Inlet: 3/8" MPT

HUPB85

\$120

**4,800 psi (310 bar)**  
Inlet: 3/8" MPT

HUPD45

\$97



#### VS500

**7,300 psi (500 bar),** 80 lpm, 90°C  
8,100 psi permissible pressure  
Inlet: 1/2" BSP M  
Bypass: 3/8" BSP F  
Weight 1.46kg

MPA60520000

\$523



#### VS660

**9,500 psi (660 bar),**  
10,450 psi permissible pressure  
60 lpm, 90°C  
Inlet: 3/8" BSP F  
Bypass: 1/2" BSP F  
Weight 1.84 kg

MPA60064500

\$1,092



#### VS1500

**1,500psi (105 bar),** 180lpm,  
60°C, suits C3006 series  
Inlet G 3/4"  
Bypass G 1" M

BVS1500 REG

\$489



#### VS450-300

**4,350 psi (300 bar),** 450 lpm, 90°C  
4,800 psi permissible pressure  
Inlet: 1 1/4" BSP F  
Bypass: 1 1/4" BSP F

MPA60413000

\$1,358



## GREAT RANGE, HUGE STOCKS, EXCEPTIONAL PRICES

HIGH PRESSURE ACCESSORIES

### FIXED QC REDUCERS (M22)

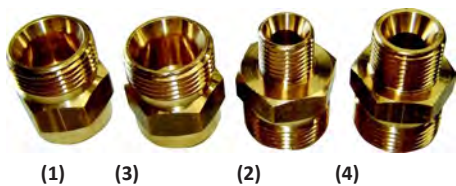

Max pressure 4,000 psi (275 bar), max flow 30 lpm, max temp 150°C (Long thread)  
Outlet: M22x1.5

S/code	Inlet	Single buy	25 pack buy (SAVE 25%)
1 C1500.05	¼ G- F	\$10	\$188 (\$7.52 each)
2 C1500.06	¼ G- M	\$10	\$188 (\$7.52 each)
3 C1500.180	¾ G- F	\$10	\$188 (\$7.52 each)
4 C1500.24	¾ G- M	\$10	\$188 (\$7.52 each)
M212003660 (short thread)	M22 M	\$15	\$282 (\$11.28 each)



### QUICK COUPLINGS (M22)



Max pressure 4,000 psi (275 bar), max flow 30 lpm, max temp 150°C (short thread)  
Outlet: M22x1.5

S/code	Inlet	Single buy	25 pack buy (SAVE 25%)
★ M212003550	1 ¼ G- M	\$21	\$394 (\$16 each)
★ M212003530	2 ¼ G- F	\$21	\$394 (\$16 each)
★ M212003540 (MPA26025050)	1 ¾ G- M	\$21	\$394 (\$16 each)
★ M212003520	2 ¾ G- F	\$21	\$394 (\$16 each)

(note some versions come with back-up ring)



### REPLACEMENT O-RINGS

Suit 1/4" snap couplings

- ★ AGP100882 (single o-ring) \$0.38
- ★ AGP100882-25 (25 pack) \$9
- ★ AGP100882-100 (100 pack) \$32

After turning off your pressure cleaner, release the pressure in the hose by pulling the gun trigger **before** uncoupling accessories ... this will extend the life of the coupling o-rings



Do not use plumbers tape on quick couplings because eventually the thread will jam. **If the coupling is leaking replace the o-ring.**



### ¼" SS GP QCS & PLUGS



Max pressure 6,000 psi (410 bar), stainless steel quick connect couplers and plugs, max temp 80°C



S/code	Inlet	Outlet	
★ 1 CD10072	¼" QC	¼ G- F	\$25
★ 2 CD10073	¼" QC	¼ G- M	\$25
3 CD10076	¼" QC	¼ G- F	\$12
4 CD10077	¼" QC	¼ G- M	\$12

### ⅜" SS GP QCS & PLUGS



Max pressure 5,000 psi (350 bar), Stainless steel quick connect couplers & plugs, max temp 80°C



S/code	Inlet	Outlet	
1 CD10074	¾ QC	¾ G- F	\$37
2 CD10075	¾ QC	¾ G- M	\$37
3 CD10078	¾ QC	¾ G- F	\$18
4 CD10079	¾ QC	¾ G- M	\$18

### REPLACEMENT O-RINGS

Suit 1/4" snap couplings

- ★ AGP100882 (single o-ring) \$0.38
- ★ AGP100882-25 (25 pack) \$9
- ★ AGP100882-100 (100 pack) \$32

Suit 3/8" snap couplings

- AGP100881 (single o-ring) \$0.38
- AGP100881-25 (25 pack) \$9
- AGP100881-100 (100 pack) \$32

Use couplings and nipples from the same manufacturer to minimize the risk of leaks

Ensure the couplings are grit free before connecting to extend life of o-ring

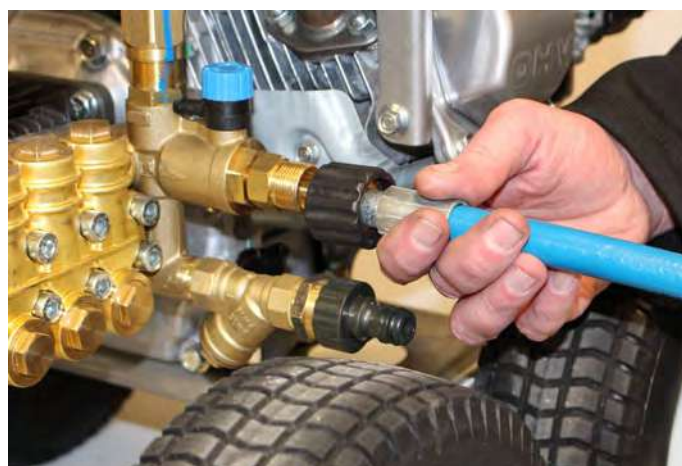
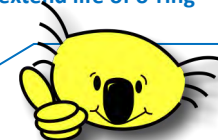

#### Aussie Quick couplers

- ✓ No tools needed
- ✓ Indispensable
- ✓ Convenient
- ✓ Low cost



### SWIVELS, COUPLINGS & NIPPLES TO 600 BAR

#### HIGH PRESSURE NIPPLES ... 4000 PSI / 7300 PSI



**4,300 psi, 300 bar Brass** high pressure nipples, must be used with sealing washers

**7,300 psi, 500 bar stainless steel** high pressure nipples, must be used with sealing washers

S/code	Inlet	Outlet	
MTM35.0070	¼"	¼"	\$10
MTM35.0247	¾"	¾"	\$15

S/code	Inlet	Outlet	
MPA13.5050.51	¼"	¼"	\$37
A MPA13.5051.51	¾"	¾"	\$44
B MPA13.5061.51	¾"	½"	\$51
MPA13.5052.51	½"	½"	\$39

#### SEALING WASHERS

Copper washers

S/code	Size	
MTM39.0276	¼"	\$0.65
MTM39.0277	¾"	\$0.76



Steel washer with rubber insert

S/code	Size	
MTM39.0280	¼"	\$2
MTM39.0281	¾"	\$2
C7888812	½"	\$4



#### PA AR8 350 BAR QC (M24)



Max pressure 5,000 psi (350 bar), max flow 30 lpm (10 pack bulk buy ... call for details)

S/code	Inlet	Outlet	
B MPA26065030	¼ BSP M	M24 F	\$40
B MPA26065050	¾ BSP M	M24 F	\$40
A MPA26063020	¼ BSP F	M24 M	\$21
A MPA26063040	¾ BSP F	M24 M	\$21
A MPA26063050	¾ BSP M	M24 M	\$21

#### PA AR9 600 BAR QC (M24)



Max pressure 8,700 psi (600 bar), max flow 80 lpm, 160°C (10 pack bulk buy ... call for details)

S/code	Inlet	Outlet	
A MPA26094040	¾ F	M24 M	\$58
A MPA26094050	¾ M	M24 M	\$58
A MPA26094070	½ M	M24 M	\$58
B MPA26095050	¾ M	M24 QC	\$137
B MPA26095040	¾ F	M24 QC	\$137
B MPA26095070	½ M	M24 QC	\$137

#### RECOMMENDED SEALANT

Loxal sealant for high pressure joints, 250ml bottles

S/code	Strength	
MTM22.0094	Thread locking (Loxal 54.03)	\$131
MTM22.0095	Permanent (Loxal 83.54)	\$134

Bulk pricing available



**BEST BUY**



#### PA SWIVELS

**3,650 psi (250 bar)**

max permissible pressure 4,050 psi  
40 lpm, 160°C

Inlet ¾ BSP M tapers 60°  
Outlet ¾ BSP F

MPA26105000 **\$33**



**5,100 psi (350 bar)**

max permissible pressure 5,650 psi  
40 lpm, 160°C

Inlet ¾ BSP M  
Outlet ¾ BSP F

MPA26106100 **\$85**

(10 pack bulk buy ... call for details)



#### SW 90 - 90° SWIVEL

**3,625 psi (250 bar)**

max permissible pressure 4,050 psi  
40 lpm, 160°C

S/code	Inlet	Outlet	
MPA26130020	¼ BSP M	¼ BSP F	\$144
MPA26130040	¾ BSP M	¾ BSP F	\$151
MPA26130042	¾ BSP M	¼ BSP F	\$158
Repair kit	MPA26130524		\$37

#### SW 600 STAINLESS STEEL

**8,700 psi (600 bar)**

max permissible pressure 9,570 psi  
60 lpm, 100°C

Inlet ¾" BSP F  
Nozzle ¾" BSP M

MPA30584000 **\$539**





## GREAT RANGE, HUGE STOCKS, EXCEPTIONAL PRICES

HIGH PRESSURE ACCESSORIES

### DETERGENT INJECTORS

**Stainless steel chemical injector**

5,100 psi (350 bar), 90°C

Hose barb 7mm  
Inlet 3/8 BSP M  
Outlet 3/8 BSP M  
Flow 30 lpm

MPA21011921 \$165



**Flush injection system  
after using detergent to  
prevent clogging**



**Complete detergent injector kit**

4,060 psi (280 bar), 150°C

Inlet M22x1.5 F  
Outlet M22x1.5 M

FZX1763 11-15 lpm \$73  
C0501.05 replacement filter \$5



### HIGH PRESSURE GAUGES

1/4" NPT inlet

- High quality
- Easy read



S/code		
AGCDR0102	6,000 psi (415 bar)	\$51
AGAUGE700BAR	10,000 psi (700 bar)	\$77
AGAUGE1000BAR	14,503 psi (1,000 bar)	\$358
B069870973	Pump valve cap to take gauge	\$28

#### Test Kits

Aussie pressure test set includes gauge and fittings for testing pump output pressure & Bertolini Pump Maintenance Guide



300 bar .... ATESTSET \$106  
350 bar ... ATESTSET-350BAR \$133

## PUMP PROTECTION TO EXTEND MACHINE LIFE

### INLET STRAINER

145 psi (10 bar),  
30 lpm, 40°C  
Inlet 1/2" BSP F  
80 mesh



**Outlet**

MPA28030020 1/2" BSP F \$49  
MPA28030000 1/2" BSP M \$49

### BRASS STRAINER

50 mesh strainer  
Inlet BSP F  
Outlet BSP F



**Inlet/Outlet**

AY STRAINER-200 1/2" \$29  
AY STRAINER3/4 3/4" \$34  
AYSTRAINER1" 1" \$40

### 5" CARTRIDGE FILTER



60 micron filters  
(cartridge element not included)

Inlet 1" BSP F  
Outlet 1" BSP F

C73429011 \$59

Cartridge element C73429300 \$18  
Mounting bracket C73269098 \$21

### IN-LINE PUMP SAVER

with low pressure hose fitting and 3/4M



**Outlet**

MPA28030020P 3/4" BSP F \$70

### SUCTION FILTER

80 mesh filter  
145 psi (10 bar),  
55 lpm, 40°C



**Inlet/Outlet**

M8105038 1/2" BSP F \$32  
M8105042 3/4" BSP F \$32

### PLASTIC Y STRAINER

145 psi (10 bar)  
80 lpm, 40°C  
Inlet 3/4" BSP F  
80 mesh



**Outlet**

MPA28015000 3/4" BSP F \$70

### FLOATS (used in Jetter break tanks)

145 psi (10 bar)  
60°C  
Inlet 3/4" BSP M



MTM22.0001 \$45



### BALL VALVES (TO 500 BAR)

Max temp 80°C, max pressure 7,000 psi



S/code	Inlet	Outlet	
MTM00089501	1/4" BSP F	1/4" BSP F	\$61
MTM00089502	3/8" BSP F	3/8" BSP F	\$71
MTM00089503	1/2" BSP F	1/2" BSP F	\$77

## HOT WATER & STEAM CLEANER PARTS

### FUEL PUMPS, ELECTRODES, THERMOSTATS, SOLENOID COILS , NOZZLES, TRANSFORMERS



Suits	Fuel Pumps		Solenoid coils		Electrodes			Thermostats	
Stella 100/200	FCDR.1603	\$339	FCDR1483	\$72	FTX0003	(pair)	\$52	FPG.0001	\$165
Sizzler	FPPGS40004	\$322	FMEBE43704	\$62	FMECA18232	(need 2 per machine)	\$49	FMETK40014 (154°C) FMETK34839 (65°C)	\$70 \$114
Super Indy, TK (Top Pro), HD190 Admiral, HD275 Admiral	FPPGS40005	\$414	FMEBE43704	\$62	FMECA12525	(need 2 per machine)	\$101	FMETK40011 (150°C) FMETK40007 (65°C)	\$139 \$141
Hydrotek (110v)	HBPA10	\$264	HBPV14	\$51	HBME10	(pair)	\$71	HECH55	\$159
Hydrotek (12v)	HBPA15 (with solenoid)	\$399	HBPV15	\$58	HBME10	(pair)	\$71	HECH50	\$188
Heatwave	HBPA15 (with solenoid)	\$399			HBME10	(pair)	\$71	HECH50	\$188

### FUEL NOZZLES, TRANSFORMERS, IGNITORS, PCB BOARDS



Suits	Burner nozzles		Transformers & Ignitors		PCB boards		
Stella 100/200	FDA030H6928	\$52	FZX0461	\$243	-		
Sizzler	FUGBR18630	\$90	FMETR88630	\$215	FMECE40049	Total Stop (EC1)	\$270
Super Indy Mk 2/3,	FUGBR22576	\$110	FMETR88630	\$215	FMECE48676 FMECE40004	Total Stop (EC) Low water cut out (EC2)	\$288 \$338
HD190 Admiral, HD275 Admiral	FUGBR31344	\$110	FMETR88630	\$215	FMECE48676 FMECE40004	Total Stop (EC) Low water cut out (EC2)	\$288 \$338
Heatwave	HBZ175	\$32	HBMT12 (Power light ignitor)	\$451	-		
Hydrotek (110v)	HBZ (insert size of nozzle)	poa	HBMT14 (110v ignitor)	\$621	-		
Hydrotek (12v)					-		

### HOT WATER COILS FOR AUSSIE HOT WATER/STEAM CLEANERS ... GREAT LOW PRICES



S/code	Suits		
FTX01259	Stella 100 & 200	Mild steel coil	\$1,408
FTX0125955		Stainless steel coil	\$2,394
FLAGR40031 (NEW)	Sizzler	Mild steel coil	\$1,543
FLAFN40469 (NEW)	Super Indy Single phase	Mild steel coil DS1012 Mk 2 & Mk3	\$1,468
FLAFN40891		Stainless steel coil DX1012M Mk 3	\$1,705
FLAFN40044 (NEW)	Super Indy Three phase Super Indy	Mild steel coil DS2016 Mk 2 & Mk 3	\$1,543
FLAFN47175		Stainless steel coil DX2106T Mk 3	\$2,815
FLAFN38136	Admiral Mk 2	Double mild steel coil (IDAC88458)	\$2,111
FLAFN43585		Stainless steel coil (IDAC40336)	\$3,863
FLAFN40464	Admiral 4000 Admiral Mk3	Double mild steel coil (IDAC40648) & (IDAC40566)	\$2,217
FLAFN46850	Admiral Mk 3	Stainless steel coil (IDAC40571)	\$4,163
HBC144	Hydrotek Heatwave	coil	\$1,751
HBC480	Hydrotek 3,000-4,000 psi	coil (pre 2013)	\$2,724
HBC580	Hydrotek 5,000 psi	coil (pre 2013)	\$5,920
HBC225	Hydrotek for SC series, 2013 onwards	complete coil wrap assembly	\$4,183
HBC484	Hydrotek for SC series, 2013 onwards	complete coil only	\$3,114

### TOP QUALITY HP HOSE AT VALUE PACKED PRICES

#### HIGH PRESSURE CLEANING HOSES ... GREAT PRICES

Super high quality Aussie Pump high pressure hose range rated up to 600 bar, 8,700 psi



Check condition of hoses daily & replace regularly.  
Most water blasting injuries are caused by worn or damaged hoses.

HIGH PRESSURE ACCESSORIES

#### WHIP HOSES

##### CONNECTING HOSE REELS TO MACHINES

3/8" R2 wire braid hose  
5,800 psi (400 bar) & hot water  
(with female 3/8" ends)



Length	S/code	
1m	AHW06FB6FB6X1	\$31
2m	AHW06FB6FB6X2	\$45
3m	AHW06FB6FB6X3	\$62
4m	AHW06FB6FB6X4	\$77

#### AUSSIE BLUE-PRO M22 ENDS

3/8" R2 (double wire braid hose) to 5,800 psi (400 bar) with M22 swaged couplings.  
Suits both cold & hot water machines.

Non marking hose, suits all brands of professional pressure cleaners

- 5,800 psi rated hose
- Max water temp 155°C
- Suit all Class A professional blasters to 4,000 psi
- M22 couplings crimped (4,000 psi rated)



8m	AHW06M22X2X8	\$142
10m	AHW06M22X2X10	\$177

#### HOBBY GUN/LANCE HOSE UPGRADE KIT

Hobby gun kit complete with AL13 gun, Vario lance & 8 metres of wire braid pro high pressure hose  
Includes 14mm to 15mm coupling adaptor

AGPDGLNH120 \$151



#### AUSSIE BLUE-PRO FEMALE ENDS

3/8" R2 (double wire braid hose) to 5,800 psi (400 bar) with female swaged ends.

Suits both cold & hot water machines  
Non marking hose, suits all brands of professional pressure cleaners

- 5,800 psi rated hose
- Max water temp 155°C
- 3/8" F ends (couplings ordered separately)
- Suit all Class A blasters to 5,000 psi professional blasters



2m	AHW06FB6FB6X2	\$45
10m	AHW06FB6FB6X10	\$199
20m	AHW06FB6FB6X20	\$330
30m	AHW06FB6FB6X30	\$499
50m	AHW06FB6FB6X50	\$772
100m	AHW06FB6FB6X100	\$1,534

#### PIGTAIL WRAPPED, COLD WATER HOSE

3/8" R2 (DOUBLE wire braid hose) to 4,785 psi (330 bar)  
4,785 psi black hose, pigtail wrapped for extra hose protection against abrasion from dragging on rough surfaces and general ware.



3/8" FEMALE ENDS (see couplings below)

10m	AR206FB6FB6PT10	\$285
30m	AR206FB6FB6PT30	\$777

M22 couplings swaged on

10m	AKENNHOSSEKIT1	\$327
-----	----------------	-------



DAMAGED & WORN HOSE CAN CAUSE SERIOUS INJURIES!



Check your hose daily for abrasion and replace at the first sign of wear.

#### DON'T FORGET COUPLINGS



M22 QC (4,000 psi)

M24 QC (5,000 psi)

#### Couplings, & associated o-rings, for hoses

M212003540 (QC M22) 2 required	\$21 each
AGP100882 (o-ring for M22 coupling)	\$0.40 each
MPA26065050 (QC M24) 2 required	\$40 each



Under AS/NZ 4233.2:2103 ,Section 6 paras 6.4.2 & 6.4.3 cover marking of hoses assemblies, hoses used on Class B machines must be certified.

### 5,000 PSI AUSSIE BLUE-PRO CLASS B CERTIFIED

Certified Aussie Blue-Pro hose 3/8" R2 (double wire braid hose) to 5,800 psi (400 bar) with female swaged ends.

Suits both cold & hot water machines

Non marking hose, suits all brands of professional pressure cleaners

- Suit all **Class B** blasters to 5,000 psi professional blasters
- **Individual hose test certificate**
- 5,800 psi rated hose
- Max water temp 155°C
- 3/8" F ends

2m	AHW06FB6FB6X2C	\$115
10m	AHW06FB6FB6X10C	\$269
20m	AHW06FB6FB6X20C	\$400
30m	AHW06FB6FB6X30C	\$570
50m	AHW06FB6FB6X50C	\$842
100m	AHW06FB6FB6X100C	\$1,604



### SPECIALIST SEWER CLEANING HOSE

More flexible, hard wearing, smaller diameter, extra long lengths

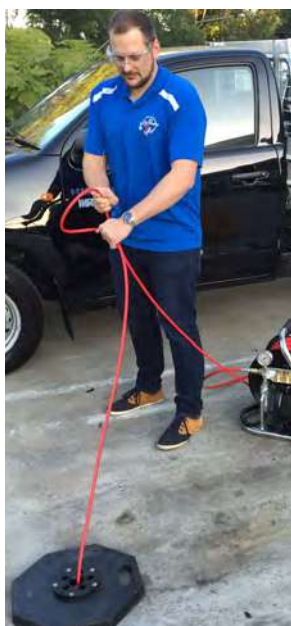

### 7,300 PSI (500 BAR) ULTRA HIGH PRESSURE HOSE

3/8" R2 wire braid hose, 3/8 M BSP ends, 150°C rated, for Quick Couplings refer p 54

- 7,300 psi rated (500 bar)
- Max water temp 150°C,
- 3/8" M ends
- **Individual hose test certificate**
- suit all Aussie Raptors & other 500 bar blasters

Additional coupler may be required to fit replacement hose to gun (refer p65 .... AR9 500 bar couplings)

10m	A3641443109	\$666
20m	A3641443209	\$976
30m	A3641443309	\$1,246



### AUSSIE REDFLEX SEWER HOSE

The super strong thermoplastic coating means the hose is stiffer but harder wearing. (5,000 psi ,1/4 BSP M ends)

- 1/4" for general drain clearing (60m)  
AHOSE RF8-60M **\$837**
- 3/16" for gullies & tight corners (60m)  
AHOSE RF6-60M **\$766**
- 3/8" for large flow machines (60m) (3/8" M ends)  
AHOSE8 3/8 60M **\$1,019**



### 8,700 PSI (600 BAR) ULTRA HIGH PRESSURE HOSE

R2 wire braid hose, M24 couplings, 150°C rated,

- 8,700 psi rated (600 bar)
- **Individual hose test certificate**



10m	A3686976109	poa
20m	A3686976209	\$1,132
30m	A3686976309	\$1,450

### NEW HOSE RESTRAINT

Stainless steel hose restraint sock with carabiner & bracket. Connects between hose and gun or mini reel couplings. Use to restrain the hose in the event of a coupling failure . Required with Class B machines under AS/NZS4233.1



- AD HRSS10 (3/8" thermoplastic hose) **\$130**
- AD HRSS8 (1/4" thermoplastic hose) **\$103**
- AHRANCHORPLATE **\$8**  
(attaches restraint to gun/lance or mini reel)

### AUSSIE SUPER WORM HOSE (15 METRES)

1/8", 5,000 psi rated, super flexible sewer hose, ideal for small drains and tight bends. Complete with compressor nozzle & quick fit tail.

AHOSE8 1/8 15M **NOW \$436**



### WORK SAFE ... REMOVE TRIP HAZARDS & EXTEND HOSE LIFE

HIGH PRESSURE ACCESSORIES

#### AUSSIE 'REEL MATE' HOSE REEL KITS WITH HOSE .... GREAT VALUE

The best value when you're buying both reel & hose!  
Includes hose reel, R2 double braid hp hose, whip hose & mount.  
Mount to machine frame, truck bed or wall ... IT'S EASY!



Model	Reel mate 3,500	Reel Mate 4,000
S/code	AD30001	ADHR40100D
Pressure rating	3,500 psi (240 bar)	4,000 psi (275 bar)
Hose length	15m	30m
Hose type	R2 5/16"	R2 3/8"
Whip hose	0.25m	1.4m
Inlet	M22 F QC	M22 F QC
Outlet	M22 F QC	M22 F QC
Foot print suits Scuds	✓	✓
Weight	12 kg	25 kg
Boxed dimensions LxWxH	300 x 290 x 340mm	400 x 350 x 450mm
	<b>\$565</b>	<b>\$845</b>

Replacement swivel	AGP100887	\$86	AGP2103051	\$101
Repair kit	AGP2100278	\$27	AGP2100278	\$27
QC nipple to connect to gun	C1500.24	\$10	C1500.24	\$10
Replacement handle	AGP100056	\$15	AGP100056	\$15
Replacement hose	AHW06M22X2X15	\$320	AHW06M22X2X30	\$541

#### AUSSIE HOSE REELS ...

Extend hose life & improve safety ... store extra long hose lengths (hose sold separately).  
Whip hose included.



Model	Reel 5030	Reel 5045
S/code	ADHR50100D	ADHR50150D
Pressure rating	5,000 psi (350 bar)	5,000 psi (350 bar)
Hose capacity	30m	50m
Inlet	3/8" M swivel	3/8" M swivel
Outlet	3/8" NPT F	3/8" NPT F
Footprint suits Scud frames	✓	✓
Weight	8 kg	8 kg
Boxed dimensions LxWxH	390 x 330 420mm	390 x 330 420
	<b>\$452</b>	<b>\$477</b>

Replacement swivel	AGP2103051	\$101	AGP2103051	\$101
Repair kit	AGP2100278	\$27	AGP2100278	\$27
Replacement handle	AGP100056	\$15	AGP100056	\$15

Additional couplings may be required

#### HOSE REEL CARTS ... GO MOBILE

Available with 15m or 30m hose reel kits.  
Assembly of cart and mounting of hose reel required

Model	Reel Cart 3,500	Reel Cart 4,000
S/codes	AD30001 (reel) AGP2100436 (cart)	ADHR40100D (reel) AGP2100436 (cart)
Pressure rating	3,500 psi (240 bar)	4,000 psi (275 bar)
Hose length	15m	30m
Hose type	R2 5/16"	R2 3/8"
Whip hose	0.25m	1.4m
	<b>\$800</b>	<b>\$1,081</b>



Smart Cart with 30m hose reel kit



Smart Cart with 15m hose reel kit (shown with Aussie Black Box fitted, refer p 32)

#### NEW AUSSIE RETRACTABLE HOSE REEL KITS ... CONVENIENT & SAFER (5,000 psi)

Wash bay essential ... INDUSTRIAL



Includes 20 metre 400 bar high pressure hose with M22 coupling.  
Made in USA.

A76000HP106-20

**\$1,906**



More options available ... call for details

#### 5,000 PSI HEAVY DUTY HOSE REEL ... 4418

Takes up to 80m of 3/8" 5,000 psi hose

- ◆ Locking pin
- ◆ Friction brake
- ◆ Heavy duty mounting plate
- ◆ 5,000 psi hose and whip hose sold separately
- ◆ 1/2" M inlet and 3/8" outlet

A4418-REEL

**\$680**



Whip hose (2m)	5,000 psi cold/hot water	AHW06FB6FB6X2	\$45
Replacement swivel	1/2" x 3/8"	AD MNRS4418	\$171
Swivel repair kit		AD MNRRK	\$40
Replacement handle		A2589	\$44



### STAINLESS STEEL REELS .... HOT WATER RATED

The Hydrotek hose reels are made with rust-proof stainless & zinc plated steel to withstand harsh environments. 304 stainless steel hose reel, **rated to 120°C**, for use with hot water pressure cleaners.



Model	Hydrotek Reel 150	Hydrotek Reel 151	Hydrotek Reel 152	Hydrotek Reel 700	Hydrotek Reel 425 (pivoting reel)	Double Stack Hydrotek Reel 325 (two reels + frame)
S/code	HAR150	HAR151	HAR152	HAR700	HAR425	HAR325
Pressure rating	5,000 psi (350 bar)	5,000 psi (350 bar)	Low pressure	7,300 psi (500 bar)	5,000 psi (350 bar)	5,000 psi (350 bar)
Hose capacity	30m	75m	25m ( of 3/4" hose)	30m	45m	75m (each)
Inlet	3/8" F	3/8" F	3/8" F	3/8" F	3/8" F	3/8" F
Outlet	3/8" F	3/8" F	3/8" F	3/8" F	3/8" F	3/8" F
Footprint suits Scud frames	✓	x	x	x	x	x
Weight	12 kg	12 kg	12 kg	12 kg	12 kg	45 kg
Boxed dimensions LxWxH (mm)	470 x 470 x 480	470 x 470 x 480	470 x 470 x 480	470 x 470 x 480		
	<b>\$660</b>	<b>\$831</b>	<b>\$550</b>	<b>\$1,452</b>	<b>\$899</b>	<b>\$1,704</b>
Whip hose	Refer p 60, specify fittings required when ordering					
Replacement swivel	HDR058 \$180	HDR058 \$180			HDR058 \$180	HDR058 \$180
Swivel Repair kit	HDR059 \$40	HDR059 \$40			HDR059 \$40	HDR059 \$40

**500 BAR**



**HAR150 ...** friction brake with infinite drag settings to prevent free-spooling.



**HAR151 ... 5,000 psi swivel** locking pin & super heavy duty mounting plate



**HAR425...** Pivoting reel, for machine or wall mounting, friction brake, 360° rotation (gun & hose sold separately)



**SAVE SPACE ... HAR325** 2 reels, double stacked, one HAR151 + one low pressure supply reel with capacity for 45m low pressure hose



HYDRO TEK.US



Hose reels extend hose life & add safety & convenience.

### 5,000 PSI STAINLESS STEEL HOSE REEL ... 4418 SS

Takes up to 80m of 3/8" 5,000 psi hose

- ◆ Locking pin
- ◆ Friction brake
- ◆ Heavy duty mounting plate
- ◆ 1/2" M inlet and 3/8" outlet
- ◆ 5,000 psi hose & whip hose sold separately

A4418SS-REEL **\$890**



### AUSSIE DRAIN CLEANING KIT

Convert your pressure washer to a drain cleaning jetter. Includes Aussie Viper Mini Reel with 60 metres of 3/16" sewer hose. Full Aussie Jetters Tool Box, including quick coupler to fit to end of blaster high pressure hose and safety plate.

ADRAINKIT **\$3,338**



More drain jetting accessories p 30

HIGH PRESSURE ACCESSORIES

6



### CUT CLEANING TIMES UP TO 75% & SAVE WATER

#### FLAT SURFACE CLEANERS

Fast, streak free cleaning ... ideal for large flat areas.

High pressure flat surface cleaners 'float on water'. These spinners are designed to operate from any electric or engine drive pressure cleaner giving a streak free finish.

- ◆ Cut cleaning times up 75%
- ◆ Use less water, save fuel, cut machine wear
- ◆ Eliminate overspray

Match nozzle size to your machine

Size your nozzle requirement using the pressure and flow of your blaster (see nozzle selection table p 61)

Divide nozzle size required by number of nozzles in spinner.

Order new nozzles if required.

HIGH PRESSURE ACCESSORIES

6



Quick connects to gun, lance or telewand

**Aussie 15" Spinner**  
Suits horizontal or vertical cleaning

Model	<b>15" Semi Pro Spinner</b>
S/code	FNA80166
Max pressure	3,600 psi
Max temp	60°C
Max flow rate	11 lpm
Inlet with 90° swivel	1/4" QC plug
Boxed measurements	380 x 390 x 160mm
Weight	2.2 kg
Cleaning speed	10m <sup>2</sup> per min
No of nozzles	2
	<b>\$225</b>

NOTE:  
700mm lance with quick coupler, sold separately



**20" Spinner**

Model	<b>20" Spinner</b>
S/code	AGPDFSC20
Max pressure	4,000 psi (275 bar)
Max temp	80°C
Max flow rate	30 lpm
Inlet	3/8" NPT-F (M22 nipple C1500.24 & CD10079 QC plug included)
Boxed measurements	900 x 560 x 340 mm
Weight	9 kg
Cleaning speed	20m <sup>2</sup> per min
No of nozzles	2 x 020
	<b>\$1,247</b>

Replacement parts		
Gun	AGPDCG4000FSC	\$110
Rotary swivel	AGP2103220	\$431
Swivel repair kit (major)	AGP2100372	\$254
Swivel repair kit (minor)	AGP2100203	\$67
Nylon brush skirt	AGP2660059	\$179
Rotary arm	AGP2530009	\$96
Plastic deck	AGP2660045	\$189
Nozzles (each)	C925020M	\$22



**22" Cyclone**

Model	<b>22" Cyclone</b>
S/code	AGPDFSCS22Z
Max pressure	4,000 psi (275 bar)
Max temp	80°C
Max flow rate	30 lpm
Inlet	3/8" NPT-F (M22 nipple C1500.24 & CD10079 QC plug included)
Boxed measurements	900 x 580 x 340 mm
Weight	11 kg
Cleaning speed	25m <sup>2</sup> per min
No of nozzles	3 x 020
	<b>\$1,565</b>

Replacement parts		
Gun	AGPDCG4000FSC	\$110
Rotary swivel	AGP2103220	\$431
Swivel repair kit (major)	AGP2100372	\$254
Swivel repair kit (minor)	AGP2100203	\$67
Nylon brush skirt	AGP2103223	\$179
Rotary arm	AGP2103224	\$96
Caster (x1)	AGP2103228	\$31
Nozzles (each)	C925020M	\$22



### FASTER, SMARTER CLEANING



28" Hydro Twister



Twister Vac  
(hose not included)

#### NEW Contractor Multi Twister ...

4 easy to select functions in one tool

1. 28" flat surface cleaner
  2. Gum spotter nozzle
  3. Water broom for quick rinse
  4. NEW! Edging tool
- Quick connect fittings for fast changeover
  - Gum spot nozzle, under deck .... prevents overspray
  - The edging tool ... cleans the strip along the edge of walls, pillars, or buildings
  - Rear casters lock to clean in a straight line
  - Rear splash guard keeps operator dry



Dual gun operation

Model	<b>28" Hydro Twister</b>
S/code	HANT28
Max pressure	4,000 psi (275 bar)
Max temp	120°C
Max flow rate	35 lpm
Inlet	M22 male
Boxed measurements	1350 x 720 x 160 mm
Weight	15 kg
Cleaning speed	35m <sup>2</sup> per min
No of nozzles	2 x 027
	<b>\$2,607</b>

Replacement parts

Rotary swivel	HVAM04	\$449
Swivel repair kit (major)	HVAM00	\$239
Rotary arm	HVAM25	\$226
Caster (x1)	HHT300	\$29
Nozzles (each)	HNM270	\$17

Model	<b>24.5" Twister Vac</b>
S/code	HANTV5
Max pressure	4,000 psi (275 bar)
Max temp	93°C
Max flow rate	25 lpm
Inlet	M22 male
Boxed measurements	1360 x 720 x 160mm
Weight	15 kg
Cleaning speed	25m <sup>2</sup> per min
No of nozzles	2 x 030
	<b>\$4,167</b>

Replacement parts

Rotary swivel	HVAM04	\$449
Swivel repair kit (major)	HVAM00	\$239
Nylon brush set	HHLH97	\$150
Rotary arm	HVAM24	\$289
Caster (x1)	HHT300	\$29
Nozzles (each)	HNM270	\$17

Model	<b>28" Multi Twister</b>
S/code	HANT4C
Max pressure	4,000 psi (275 bar)
Max temp	120 °C
Max Flow rate	21 lpm
Inlet	M22 male
Boxed measurements	1350 x 720 x 160mm
Weight	15 kg
Cleaning speed	35m <sup>2</sup> per min
No of nozzles	2 X 027
	<b>\$3,258</b>

Replacement parts

Rotary swivel	HVAM04	\$449
Swivel repair kit (major)	HVAM00	\$239
Nylon brush skirt	HHLH72	\$150
Rotary arm	HNSB02	\$237
Caster (x1)	HHT300	\$29
Nozzles (require two of each)	HNM202	\$17
	HNM102	\$17

HIGH PRESSURE ACCESSORIES

6



HIGH PRESSURE ACCESSORIES

### AUSSIE TELE-WAND ...

19' (5.5m) telescopic Tele-wand, great for washing under eaves or windows, includes **FREE** harness kit valued at \$44



**EXTENDS TO 5 METRES**



Replacement parts

Gun	AGPDCG4000TS	\$112
Harness kit	AGPD20015	\$44

#### COMMERCIAL

**4,000 psi** (275 bar), 1/4" QC outlet  
 Retracted length 2.3m  
**Extends to 5.5m**  
 40 lpm, 90°C,  
 Fibreglass outer poles  
 Inlet ... 3/8" NPT-F  
 (M22 nipple C1500.24  
 & CD10079 QC plug included)

AGPDLTG18 \$431

**NB: Requires Quik Tip nozzle, sold separately (see p 60)**



Shipping weight 5kg  
 Boxed dimensions (mm):  
 2090 x 180 x 70

#### INDUSTRIAL

**4,000 psi** (275 bar), 1/4" QC outlet  
 Retracted length 2.3m  
**Extends to 5.5m**  
 40 lpm, 90°C,  
 Aluminium outer poles  
 Inlet ... 3/8" NPT-F  
 (M22 nipple C1500.24  
 & CD10079 QC plug included)

AGPDCLTG18A \$502

**NB: Requires Quik Tip nozzle, sold separately (see p 60)**



Shipping weight 5kg  
 Boxed dimensions (mm):  
 2090 x 180 x 70

### GRIT BLAST KITS ... REMOVE PAINT OR RUST FASTER

#### PROFESSIONAL GRIT BLAST KITS

6

**TS 33 3,200 psi** (220 bar),  
 Permissible pressure 3,625 psi  
 Tungsten carbide tip,  
 500mm zinc probe, 6m hose, 400mm lance  
 with M22 coupling & 035 nozzle

M202903460 \$233



**5,000 psi** (350 bar) professional,  
 (nozzle not included, use 0° nozzle)  
 8 metres of nylon braided hose & sand  
 probe  
 Inlet 1/4" BSP F  
 (note additional couplings & lance may be  
 required)

MTM160172 \$359



#### 500 BAR GRIT BLASTER

TPS 450 Kit (**500 Bar, 7,300 PSI**) grit blast  
 kit, c/w probe, plastic hose, 800mm lance,  
 gun, nozzle & nipple for quick coupling

S/code	
TPS450/___GLK (specify nozzle size required)	\$1,559

#### REPLACEMENT PARTS ...

C4700.18 Head only	\$651
C4604.04 Hose barb	\$130
Repair kit for head (C650419)	\$315



#### TS12 SAND BLASTER

**500 Bar, 7,300 PSI** grit blast head with a flat  
 spray pattern ,80 lpm, 90°C  
 Inlet 1/4" BSP F  
 Nozzle 1/4" NPT M (15°)

S/code	
MPA25.0450.00 Head only	\$881
MPA25.0300.20 Hose barb	\$130





## FOAMERS

Spray detergents, degreasers disinfectants without chemicals going through the pump.

### 2,600 psi (180 bar) LS3

max permissible pressure  
12 lpm, 60°C, 1 litre capacity  
Inlet ¼" BSP F  
Nozzle 1.25mm



### MPA25152612 \$148

(requires C1500.06 coupling to fit to gun, \$10, p66)



### 3,200 psi (220 bar) LS12

max permissible pressure  
25 lpm, 60°C, 2 litre capacity  
Inlet ¼" BSP F  
Nozzle 1.5mm

### MPA25184215 \$187

(requires C1500.06 coupling to fit to gun, \$10, p66)



## FOAM JET KIT

Can shoot detergent up to 3 stories.

5,000 psi (350 bar) max pressure  
21 lpm, 60°C, 10m of inlet hose,  
Inlet ¼" BSP F  
Nozzle 3 nozzles, 1.25,  
1.5 & 1.7mm

### MTM140289 \$233



## GUTTER CLEANER

### DITCH THE LADDER

Unique design attaches in place of a Quik Tip nozzle and enables gutter cleaning with a normal lance.

Can also be used with a turbo head. (Quik Tip nozzle sold separately p60)

Inlet: QC Outlet: 1/4" M tale

### AGPD20011 \$40

(fixes to a lance with QC ...

FNA7103261 \$74)

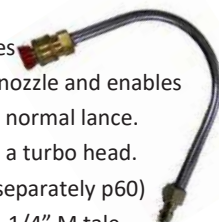

## ACID VENTURI

Clean brickwork fast!

Inlet: ¼ BSP M

Ratio 6:1

Hose barb 7mm

CGMA025 \$67



## WHEELS ... TOP QUALITY STEEL WHEELS WITH PNEUMATIC & FLAT FREE TYRES



A

B

C

D

E

S/code	Size	Suits	Axle size	
A A400015	10"	AB Scud 30/40 & Monsoon 140/200 flat free	16mm (5/8")	\$40
B A400016-HD	13"	Scud 350-400, Ultra & Predator, flat free for diesel powered units	16mm (5/8")	\$69
ACAP16MM		Wheel cap	16mm (5/8")	\$2
C HAHS10	10"	Hydrotek wheel kit (4 wheels & axle kit), suits HSS series only	19mm (3/4")	\$281
D AWHEELCOBRA	10"	Cobra/King Cobra	19mm (3/4")	\$97
E AWHEELDIESEL	16"	Diesel Raptors & Predators	25mm (1")	\$111

## NEW AUSSIE SMART CART

Strong & robust universal trolley

- ♦ 10" flat free wheels
- ♦ Suits mounting of pumps, pressure cleaners, generators and hose reels
- ♦ Suits up to 7HP engines
- ♦ Base 37cm long x 27cm

AGP2100436

\$236



6

## NEW MISTING LANCE

Generate a fine misting spray to dampen down dust on construction sites.

Double CTN255 turbo heads (3,785 psi, 255 bar), German made 900mm steel lance, M22 nipple

CTN255-030TWINML \$585



### 500 BAR GUN LANCE KIT



- RL 57 7,250 psi (500 bar), 28 lpm, 160°C, permissible pressure 8,000 psi (Inlet 3/8" BSP F)
- 5,800 psi (400 bar) 1050mm lance with melted handle, permissible pressure 6,400 psi, 160°C, Outlet 1/4" NPT F
- Ceramic nozzle or turbo head sold separately

MPA30473000 gun/lance kit **\$621**



### 8,000 psi SPRAY Gun (all Aussie Raptors)

**RL84**  
7,300 psi(500 bar), 80 lpm, 100°C  
Permissible pressure 8,100 psi

Inlet 1/2" BSP F  
Outlet 1/2" BSP F

Use P/A single lance  
MPA30540000 **\$510**  
(300mm shoulder rest MPA30501921 \$54)



### RL 800 500 BAR PA SINGLE S/S LANCE

Suits RL84, 7,300 psi (500 bar),  
Permissible pressure 8,100 psi, 200 lpm,  
43°C, Inlet 1/2" BSP M, Outlet 1/4" NPT F

**400mm** MPA30500040 **\$226**  
**800mm** MPA30500080 **\$267**  
**1250mm** MPA30500092 **\$418**

Requires ceramic tip nozzle sold separately



### TURBO HEADS

**500 bar series**  
7,200 psi, 500 bar, 40 lpm  
EWP up to 12,000 psi  
Max temp: 90°C  
Inlet 1/4" F



CTN500-020H **\$1,684** (Raptor 12)  
CTN500-025H **\$1,684** (Raptor 16)  
CTN500-030H **\$1,684** (Raptor 18)  
CTN500-035H **\$1,684** (Raptor 21)

More sizes available

**Repair kit**  
CTN500-\_\_REP **\$1,222**

### 500 BAR CERAMIC TIP NOZZLES

**Aussie White Tip** 500 bar 0° & 15° nozzles,  
nozzle material ceramic,  
inlet 1/4" NPT M ...  
**\$142** each



Size	0° (pencil jet)	15° (fan)
025	M0124006100	M0124006110
030	M0124006200	M0124006210
035	M0124006300	M0124006310
040	M0124006400	M0124006410
045	M0124006500	M0124006510
050	M0124006600	M0124006610

### PA AR9 QC (M24)

Max pressure 8,700  
psi (600 bar), max flow  
80 lpm, 160°C



	S/code	Inlet	Outlet	
A	MPA26094040	3/8" F	M24 M	\$58
A	MPA26094050	3/8" M	M24 M	\$58
A	MPA26094070	1/2" M	M24 M	\$58
B	MPA26095050	3/8" M	M24 QC	\$137
B	MPA26095070	1/2" M	M24 QC	\$137

### UNLOADER VB53 (Aisi 303)

**8,000 psi** (550 bar), 80 lpm, 90°C  
Inlet 1/2" BSP F  
Outlet 1/2" BSP F  
Bypass 1/2" BSP F



BVB53 **\$1,122**



### UNLOADER VB60/600 ZERO

**8,700 psi** (600 bar) permissible pressure, 60  
lpm, 60°C  
Inlet 1/2" BSP F  
Outlet 1/2" BSP F  
Bypass 1/2" BSP F



MPA60260000 **\$1,309**

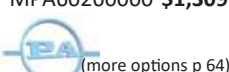

### SAFETY VALVE VS500

**7,300 psi(500 bar)**, 80 lpm, 90°C  
8,100 psi permissible pressure  
Inlet: 1/2" BSP M  
Bypass: 3/8" BSP F



MPA60520000 **\$523**



### 7,300 PSI HOSE ... BLASTERS UP TO 500 BAR

	Length	S/code	
<b>7,300 psi (500 bar)</b>	10m	A3641443109	<b>\$666</b> 3/8" R2 wire braid hose,
	20m	A3641443209	<b>\$976</b> 3/8 M BSP ends, 150°C
	30m	A3641443309	<b>\$1,246</b> rated, certified for Class B

### HOSE RESTRAINTS ... OH&S REQUIREMENT

All class B machines must have a hose restraint to comply with the Australian safety standard. Hose ruptures account for 90% of operator injuries, protect your operators!



AD HRSS10 (3/8" thermoplastic hose) **\$130**  
AD HRSS8 (1/4" thermoplastic hose) **\$103**



### ST 500 FOOT VALVES & WHIP HOSE



Stainless steel housing, & valve,  
rubber feet, includes 3m whip hose  
max 500 bar, 40 lpm, 150°C  
Inlet M24 M  
Outlet M24 M

AST500-M24 **\$975**

**350 BAR** (40lpm max flow)  
AST350-2605 **\$578**



Replacement 500 bar whip hose, 3m  
Inlet M24 F  
Outlet M24 F

A3641443039 **\$440**



### 500 BAR HYDRO-BLASTERS ...

Petrol .... p16  
Diesel .... p17  
Electric .... P36



HIGH PRESSURE ACCESSORIES

### GRIT BLAST KITS ... REMOVE PAINT OR RUST FASTER

#### 500 BAR GRIT BLASTER

TPS 450 Kit (500 Bar, 7,300 PSI) grit blast kit,  
c/w probe, plastic hose, 800mm lance, gun,  
nozzle & nipple for quick coupling

S/code	
TPS450/___GLK (specify nozzle size required)	<b>\$1,559</b>

#### REPLACEMENT PARTS ...

C4700.18 ...Head only	<b>\$651</b>
C4604.04 ... Hose barb	<b>\$130</b>
Repair kit for head (C650419)	<b>\$315</b>



#### COMPLETE TURBO KITS

#### 500 BAR TURBO KIT

500 bar (7,300 psi) includes turbo head, gun, 800mm lance, nozzle & quick coupling nipple



CTN500-\_\_\_GLK **\$2,244**  
(insert nozzle size)

#### TS12 SAND BLASTER

500 Bar, 7,300 PSI grit blast head with a flat  
spray pattern ,80 lpm, 90°C  
Inlet ¼" BSP F  
Nozzle ¼" Npt M (15°)

S/code	
MPA25.0450.00 Head only	<b>\$881</b>
MPA25.0300.20 Hose barb	<b>\$130</b>



PPE to 500 BAR  
pages 80-81

6

#### AUSSIE SAFE-OPERATOR SAFETY AWARENESS TRAINING ...

Aussie run essential operator safety awareness courses to train operators in the safe use of our class B hydro-blasters



### STAY SAFE ... PERSONAL PROTECTION UP TO 500 BAR

#### Aussie Pumps SAFE OPERATOR

##### 500 BAR HOSE SHROUDS



Hose ruptures account for 90% of operator injuries.

The hose shroud is placed on the hose at the connection to the gun. This provides effective protection for the operator as it has been tested for 500 bar / 7500 psi. An adjustable strap holds the hose shroud securely in place.

Length: 750 mm  
Diameter: 41 mm  
Weight: 0.2 kg  
ATST56600455920 **\$252**



**PROTECTION LEVEL 5/5/2**

ROTOR 500 bar/7500 psi  
 FLAT 500 bar/7500 psi  
 SINGLE 200 bar/3000 psi

CE 89/686/EEC

##### Comfort, Function and Safety - Pro Operator

Dyneema® is the world's strongest fibre.

(15 times stronger than steel on a weight for weight basis). This makes it possible to offer high levels of protection against water jetting hazards even with lightweight fabric. Being much thinner and more flexible than traditional materials, such as leather, cotton and metals, products made with Dyneema® fibre will be very comfortable. Employees will appreciate this comfort, combined with higher protection, and consequently are more likely to wear them at all times.

Dyneema® is a registered trademark of Royal DSM N.V

##### APRON

The full area of the Apron has built-in protection. Good alternative protection in warm environments.

- ◆ Adjustable neckband .. adjusts position of apron
- ◆ Adjustable waistband ... takes weight off the neck

- ◆ Easy to put on & take off
- ◆ Recommended for work on flat surfaces
- ◆ One size
- ◆ Weight 0.7 kg

ATSTP5623025 **\$573**



##### GLOVES

Pack of 12 pairs of gloves, Size 8 or 11

ATSTP5600025/xx (xx = size) **\$2,063**

Individual pairs of gloves, size 8 or 11

ATSTP5600025xxS (xx = size) **\$215**



##### HEAD PROTECTION .. 3,000 BAR

Helmet with safety visor & hearing protectors.

- ◆ Comfortable
- ◆ Adjustable fit
- ◆ Replaceable visor that can be set in folded up position
- ◆ 3 point chin strap

- ◆ Adjustable hearing protectors for optimum protection & comfort
- ◆ Weight 0.85kg
- ◆ Temp range -30°C to 150°C

ATST51K0216890 **\$576**



##### AUSSIE STOP-JET BOOTS ... CE CERTIFIED TO 500 BAR

Designed for comfort, performance and grip. Completely vulcanised rubber boots fitted with steel toecaps and sole inserts. Black areas on uppers indicate areas that withstand high pressure water jets up to 500 bar.

- ◆ Adjustable top strap
- ◆ Waterproof
- ◆ Textile inner lining for comfort
- ◆ Easy to pull on
- ◆ Sizes 42-48



ATST5652025xx **\$524**

Prot. Level	Pressure bar (psi)	Flow (l/m)	Nozzle type	Dist. (mm)	Speed (m/s)	Result
5/5/3	500 (7500)	16.9	Rotary jet	75	0.5	No penetration
5/5/3	500 (7500)	16.9	15° fan jet	75	0.5	No penetration
5/5/3	300 (4,350)	13.1	Pencil jet	75	0.5	No penetration

Conversion table for shoe sizes

EUR	US	UK
42	9	8
43	9½	9
44	10½	10
45	11½	11
46	12	11½
47	13	12½
48	13½	13½

500 BAR PROTECTIVE CLOTHING

6





### OVERALL WITH HOOD

3-layer functional overall which is CE certified for protection against water jets to 500 bar. Excellent for the toughest conditions! Lined for high comfort. Waterproof and dirt repellent outside.

Weight 2.5 kg / 5.5 lbs. (Overall size L).  
**Sizes XS–3XL**

ATSTP5640025xxx (xxx = size) **\$1,763**

Hi-vis option...  
 ATHV5640025xxx (xxx =size) **\$1,953**

- ◆ Detachable hood with 3 adjustments
- ◆ 2 pockets with water proof zippers
- ◆ Inside are cuffs ... prevent leakage
- ◆ Elasticated waist
- ◆ Zippers at bottom of legs
- ◆ Water proof front zipper with overlapping flap
- ◆ Knife pocket on right leg
- ◆ Pockets for knee pads
- ◆ ID pocket
- ◆ Reinforced knees
- ◆ Adjustable cuffs
- ◆ Ventilation zips in armpits

### HI VIS VEST

Comfortable vest with protection on both the front and back. Water & dirt repellent outside

- ◆ Protection all around the vest
- ◆ Good for warm environment
- ◆ Special pocket for phone

Weight 1 kg / 2.2 lbs. (Overall size L).  
**Sizes S–3XL**

ATST5620025HVVxx (xx =size) **\$1,328**



### JACKET WITH HOOD

3-layer functional jacket which is CE certified for protection against water jets to 500 bar. Very comfortable and flexible . Lined for high comfort. Waterproof and dirt repellent outside. Thoughtful details such as opening ventilation in the armpit, comfortable cuffs and adjustable hood.

Weight 1.6 kg / 3.5 lbs. (Jacket size L).  
**Sizes XS–3XL**

ATSTP5622025xxx (xxx =size) **\$1,154**

Hi-vis option...  
 ATHV5622025xxx (xxx =size) **\$1,301**



### TROUSERS

3-layer functional trousers which are CE certified for protection against High Pressure Cleaning. Very easy to put on and off. Adjustable elastic waist for perfect fit. Waterproof and dirt repellent outside. Practical details such as knife pocket, leg pocket and dual loops for belt. Zippers down on the legs allows them to widen to facilitate donning the boots.

Weight 1.3 kg / 2.9 lbs. (Trousers size L).  
**Sizes XS–3XL**

ATSTP5632025xxx (xxx = size) **\$881**

Hi-vis option...  
 ATHV5632025xxx (xxx =size) **\$1,029**



Jacket, Trousers, & Overall	Height (cm)	Chest (cm)
<b>XS</b>	<b>160-167 (5'3"-5'6")</b>	<b>84 (33")</b>
<b>S</b>	<b>168-175 (5'6"-5'9")</b>	<b>92 (36")</b>
<b>M</b>	<b>176-180 (5'9"-5'11")</b>	<b>100 (39")</b>
<b>L</b>	<b>181-186 (5'11"-6'1")</b>	<b>108 (43")</b>
<b>XL</b>	<b>187-192 (6'2"-6'4")</b>	<b>116 (46")</b>
<b>2XL</b>	<b>193-200 (6'4"-6'7")</b>	<b>124 (49")</b>
<b>3XL</b>	<b>201-206 (6'7"-6'9")</b>	<b>132 (52")</b>

### SAFE OPERATOR TRAINING

**New Australian Standards** on the use of high pressure water jetting systems (AS:NZS4233.1-2013) states that operators of Class A pressure cleaners, typically to 4,000 psi, must be trained in identifying risk and the safe use of the equipment.

For Class B machines, 5,000 psi and above, or high flow blasters, operators must undergo formal training in high pressure jetting and be certified.

Aussie Pumps run safety training courses with a huge emphasis on safety awareness. The training program details, in a very down to earth way, the value of using indispensable labour saving equipment, without running the risk of disablement or injury.

Call Aussie Pumps for more details of the **FREE** courses.



### STAY COOL ... REDUCE THE RISK OF HEAT STRESS

#### DURATION?

Lasts for 90 minutes in a 60°C/140°F environment, or 4 hours at 45°C/113°F normal work.

#### RE-CHARGE?

Re-charges in 4 hours in room temperature (20°C/68°F), or 10-15 mins in a fridge.

#### WHAT ABOUT THE ELEMENTS?

Consist of a non toxic, non flammable blend of salts which is known to be the most effective ingredients for this temperature range. Can be used and re-charged over and over again. Guaranteed for 1000 cycles, if properly maintained. TEMPTECH elements within the vest can be replaced if damaged.

#### MULTI

Cooling Vest Multi has 20 TEMPTECH elements that provide effective heat absorption. Also available in flame retardant material if required.

Recommended to use tight to the body, with a T-shirt underneath, and a covering garment on top.

Weight 2,1 kg.

Size S/M-4XL/5XL

S/code: ATSTC3010P028xx (xx=size code)

**\$598**

20 additional TEMPTECH elements

S/code: ATSTC3090P28020

**\$380**

#### Flame retardant option

Size S/M-4XL/5XL

S/code:

ATSTC3026P028xx

(xx=size code)

**\$677**



#### FLEXI

Cooling Vest Flexi is designed to be smooth and easy to put on. It closes with velcros at the shoulders and sides. The Flexi vest has 16 TEMPTECH elements that absorb excessive heat. Also available in fire-resistant Nomex material. Recommended to use tight to the body, with a T-shirt underneath, and a covering garment.

Weight 1.6 kg.

One size fits all.

S/code: ATSTC3000P02801

**\$490**

16 additional TEMPTECH elements

S/code: ATSTC3090P28016

**\$304**

#### Fire resistant (Nomex) option

S/code: ATSTC3008P02801

**\$869**



500 BAR PROTECTIVE CLOTHING

6

Vest type	Polyester	Flame retardant	Nomex
Flexi	Standard	No	Option
MULTI	Standard	Option	No

#### HOW IT WORKS

Through our unique concept - using TEMPTECH elements with a 28°C transition temperature - we utilize this fact of nature to store energy, and absorb excessive heat.

Everybody knows that ice melts at temperatures above 0°C but not everybody knows that the moment of transition from solid to liquid uses up to 50 times more energy compared to a rise of 1°C when an object already is in either liquid or solid condition.

The TEMPTECH element recharges in normal room temperature (20°) in about 4 hours - faster if in a cooler environment – and is guaranteed to last more than 1000 cycles.

#### Applications

- ◆ Water jetting
- ◆ Fire & Rescue services
- ◆ Mining
- ◆ Police
- ◆ Athletes
- ◆ Oil platforms
- ◆ Chemical industry
- ◆ Steel industry
- ◆ Refineries
- ◆ Nuclear plants
- ◆ Paper mills
- ◆ Military services
- ◆ Hazmat
- ◆ Diving
- ◆ Road workers



Size table (cm)	Chest	Size code
S-M	84-100	20
L-XL	100-116	24
2XL-3XL	116-132	26
4XL-5XL	132-148	28



### NEW PREMIUM MODELS

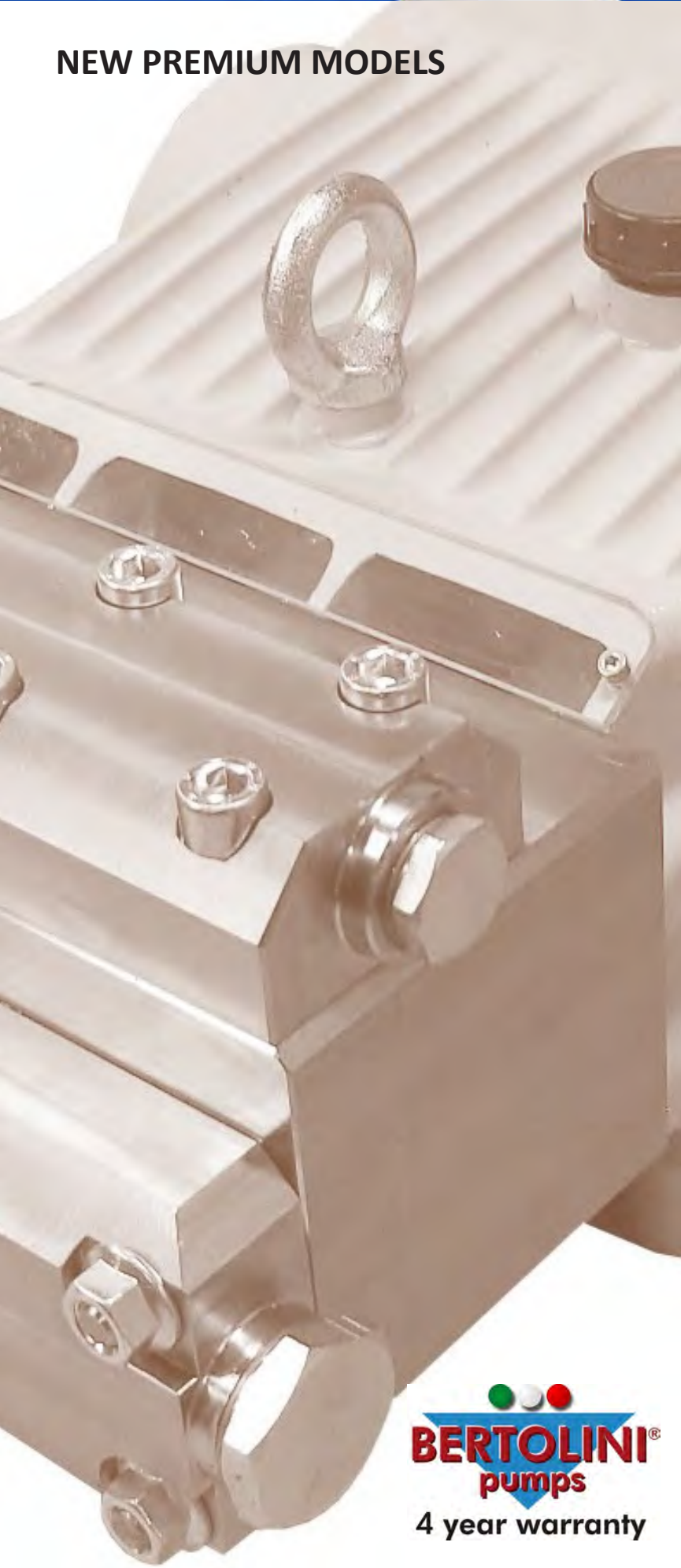

**BERTOLINI**  
**DIRECT DRIVE**  
FS, WBG, TWGS, TMG, WBL

p84



**BERTOLINI**  
**HEAVY DUTY**  
**140 - 300 BAR**  
WBL, TTL, TTK

p86



**BERTOLINI**  
**HEAVY DUTY**  
**350 - 500 BAR**  
RAS, RAL, RA

p88



**BERTOLINI**  
**ULTRA HIGH**  
**PRESSURE**  
CAX

p89



**BERTOLINI**  
**HIGH FLOW/  
PRESSURE**  
CX

p90



**BERTOLINI**  
**STAINLESS STEEL**  
**PROCESS PUMPS**  
TAM, KA

p91



**BERTOLINI**  
**MOTOR PUMPS**  
CK, C3006

p92



**TECH TALK**  
SYSTEM REQUIREMENTS

p93

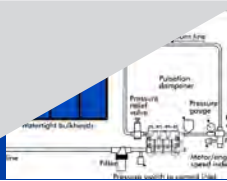

**UDOR DIAPHRAGM**  
**PUMPS**  
ZETA, KAPPA, DELTA

p94



**BERTOLINI**  
**pumps**  
4 year warranty

### Cougar Axial Pump



Got a third world pump that's failed?

Upgrade with this **great value** axial pump that suits Honda 5.5HP engines



Model	COUGAR PUMP (F520002-AAA)
S/code	F90029
Pump type	Axial
Pump pressure	3,100 psi (210 bar)
Flow	9 lpm
Suits Engine	Honda GC160/GC190 GX160/GX200 or equivalent 3/4" keyed shaft
Required HP	5.5
Pump speed	3200 rpm
Used on	Cougar Mk 2/3
Shaft diameter	Hollow 3/4"
Max temp	60°C
Weight	2 kg
	<b>\$415</b>

## BERTOLINI PUMPS

### DIRECT DRIVE FOR ENGINE MOUNTING

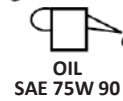

Model	WBXG 3025	TMG 4035
S/code	BWBXG3025	BTMG4035
Pump type	Triplex	Triplex
Pump pressure	3,000 psi (200 bar)	4,000 psi (280 bar)
Flow	10 lpm	13 lpm
Suits engine (or equivalent)	Honda GX200 3/4" keyed shaft	Honda GX390 1" keyed shaft
Required HP	6.5HP	13HP
Pump speed	3450 rpm	3450 rpm
Used on	Scud AB30	Scud AB40
Interchanges with Interpump	TT1511 C3/4"	WW 964
Shaft diameter	Hollow 3/4"	Hollow 1"
Max temp	60°C	60°C
Recommended nozzle size	035	030
Weight	6	10.8
Dimensions	206 x 199 x 131	252 x 249 x 149
	<b>\$821</b>	<b>\$997</b>

### REPLACEMENT PUMP KITS ... IT'S EASY TO REPLACE A WORN OUT PUMP OR UPGRADE TO BERTOLINI

Smart replacement options, easy & cost effective. Kits (**supplied unassembled**) include ....

Bertolini pump, unloader valve, safety valve, thermal dump and pressure gauge (where indicated). Full instructions included.

**SAVE 10% on buying parts individually!**

#### Direct engine drive pump kits

Pump Model	S/code	Unloader	Safety valve	Thermal Dump	
WBXG3025#	BWBXG3025KIT	BAPR-I-35ADJ	MTM00033003	MPA60063050	<b>\$1,016</b>
TMG4035#	BTMG4035KIT	BAPRI 40ADJ	MTM00033003	MPA60063070	<b>\$1,204</b>

#### Electric drive pump kits

Pump Model	S/code	Unloader	Safety valve	Thermal Dump	Pressure Gauge	
WBL917	BWBL917KIT	BAPRI20ADJ	-	MPA60063050	AGCDR0102	<b>\$823</b>

#### Small Hydraulic drive pump kits

Pump Model	S/code	Unloader	Safety valve	Thermal Dump	Pressure Gauge	
THY2715	BTHY2715KIT	BAPR-I-35ADJ	MTM00033003	MPA60063070	AGCDR0102	<b>\$1,676</b>
WHY1520	BWHY1520KIT	BAPR-I-35ADJ	MTM00033003	MPA60063050	AGCDR0102	<b>\$1,214</b>

**NOTE** Aussie Pumps strongly recommends **replacing the nozzle in the lance when purchasing a replacement pump kit. Purchase a 5 pack of nozzles with your pump kit and get a 10% discount!** (p60 for details)

**NOTE:** kits marked # **do not** contain a pressure gauge. A gauge is required during set-up of the unloader and safety valve. Purchase of a test kit for this procedure is therefore recommended.  
**A Test Kit**

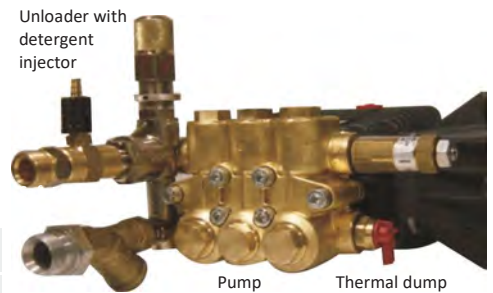

**ASP (Aussie Safety Protection)** kits, include thermal dump valve & safety valve. Protects operator & machine against excessive bypass & pressure spikes.

Aussie pressure test set includes gauge and fittings for testing pump output pressure and Bertolini Pump Selection Guide  
ATESTSET **\$106**



HIGH PRESSURE PUMPS

6

### BERTOLINI PUMPS

#### WBL SERIES ... SLOW SPEED SUIT ELECTRIC MOTOR MOUNTING OR GEARBOX DRIVE



- ◆ **Super Cool Fin System** ... die cast alloy crankcase, ribbed for efficient cooling, with high thermal conductivity
- ◆ **Premium oversized bearings**
- ◆ **Forged steel crankshaft** for coupling to motor/engine
- ◆ **Large stainless steel plunger rods** that have undergone a special nitrating treatment. As a result the rods are harder and smoother for longer seal life.
- ◆ **Oversized aluminium con rods** for max strength
- ◆ **Rapid action**, mirror finish stainless steel 316 check valves for corrosion resistance
- ◆ **High quality pistons** for long life



**4 year warranty**



#### ELECTRIC MOTOR VERSION 24mm pump shaft

Model	WBL 917
S/code	BWBL917
Pump type	Triplex
Pump pressure	2,000 psi (140 bar)
Flow	9 lpm
Motor	4 pole
Required kW	2.2kW
Pump speed	1450 rpm
Used on	Monsoon 140
Max temp	60°C
Recommended nozzle size	035
Weight	5.8
Dimensions	206.7 x 154.5 x 131mm
	<b>\$648</b>

#### KEYED SHAFT FOR GEARBOX 24mm pump shaft

Model	WBL 1114
S/code	BWBL1114
Pump type	Triplex
Pump pressure	2,000 psi (140 bar)
Flow	11 lpm
Suits engine (or equivalent)	Honda GX 160 3/4" keyed shaft
Required HP	5.5
Pump speed	1450 rpm
Used on	BB100EY
Max temp	60°C
Recommended nozzle size	035
Weight	5.8
Dimensions	206.7 x 154.5 x 131mm
	<b>\$900</b>

Gearbox reqd **\$543** (B318699973)  
For pump kits & gearbox see page 86



HIGH PRESSURE PUMPS

6

### DIRECT DRIVE & SMALL SLOW SPEED BERTOLINI PUMP SERVICE PARTS

PUMP MODEL

	Part No.	Description	WEL 744 WEL 733	WBL 1114	WBL 917 WBL 1111	WS 899G	WBG 2030	WHY 1520	THY 2715	TWSG 3013 TWSG 3016	WBXG 3025	TMG 4035	
Valve Kit	BKIT1	(15 pieces)	✓			✓				✓			\$108
	BKIT123	(15 pieces)							✓			✓	\$128
	BKIT141	(12 pieces)		✓	✓		✓	✓			✓		\$49
Valve cap kit	BKIT166	(12 pieces)		✓	✓		✓	✓			✓		\$159
	BKIT3	(12 pieces)	✓			✓							\$72
	BKIT18	(12 pieces)								✓			\$181
	BKIT67	(12 pieces)							✓			✓	\$142
Minor Seal Kit	BKIT12	(15 pieces)	✓	✓	✓			✓					\$152
	BKIT60	(12 pieces)				✓							\$116
	BKIT21	(15 pieces)								✓			\$222
	BKIT73	(15 pieces)					✓				✓		\$116
	BKIT74	(15 pieces)										✓	\$115
	BKIT177	(18 pieces)							✓				tba
Major Seal Kit	BKIT10	(18 pieces)	✓										\$236
	BKIT70	(21 pieces)		✓	✓			✓					\$195
	BKIT61	(18 pieces)				✓							\$251
	BKIT20	(21 pieces)								✓			\$323
	BKIT68	(21 pieces)					✓				✓		\$251
	BKIT69	(21 pieces)										✓	\$237
	BKIT176	(24 pieces)							✓				tba
Oil Seal Kit	BKIT14	(3 pieces)								✓			\$41
	BKIT64	(3 pieces)	✓					✓			✓		\$44
	BKIT65	(3 pieces)										✓	\$50
Full oil seal & sight glass kit	BKIT78	(9 pieces)										✓	\$71
	BKIT82	(8 pieces)					✓	✓					\$72
	BKIT83	(8 pieces)		✓	✓								\$72
	BKIT169	(8 pieces)									✓		\$66
	BKIT189	(9 pieces)							✓				tba
Piston	B050010182	18mm	✓	✓	✓			✓		✓			\$108
	B040010182	15mm				✓					✓		\$81
	B070007182	15mm										✓	\$94
	B080070182	20mm							✓				\$198
Sight Glass	B853505002	3/8" threaded	✓			✓				✓			\$17
	B040120322	Clip On						✓			✓		\$8
Breather Plugs	B852570002	3/8" Yellow	✓			✓				✓			\$15
	B049832973	1/2" Orange	✓			✓			✓		✓		\$15
Gearbox	B318699973	Ø 24mm/ 3/4" Shaft	✓	✓									\$543



## BERTOLINI PUMPS

### HEAVY DUTY, SLOW SPEED (1450 RPM) PUMPS FOR ENGINE MOUNTING



- ◆ **Intelligent packing seal system;**
  - ◇ High pressure seal self lubricating with variable expansion dependant on pressure
  - ◇ Anti extrusion ring made of PTFE & graphite protects pistons, precision engineered fit
  - ◇ Low pressure seal reduces friction on pistons
- ◆ **Stainless steel Tenifer treated piston rod, hardened and polished ... extremely wear resistant**
- ◆ **Valve caps are designed to eliminate water under pressure in threads ... torque reduced by 40%, therefore easy to remove without risk of damage**
- ◆ **Super Cool Fin System ... die cast alloy crankcase, ribbed for efficient cooling, with high thermal conductivity**
- ◆ **Hardened surface of piston guides ensure smooth operation**
- ◆ **Special Easylube gear oil used for break in period of pump**

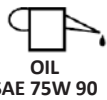

HIGH PRESSURE PUMPS

### TTL SERIES

24mm pump shaft	NEW			
Model	TTL 1520	TTL 2120	TTL2028	TTL 1330
S/code	BTTL1520	BTTL2120	BTTL2028	BTTL1330
Safety classification	Class A	Class A	Class A	Class A
Pump pressure	3,045 psi (200 bar)	3,045 psi (200 bar)	4,000 psi (280 bar)	4,350 psi (300 bar)
Flow	15 lpm	21 lpm	20 lpm	13 lpm
Suits engine (or equivalent)	Honda GX390	Honda GX390	Honda GX630	Honda GX390
Required HP	13 HP	13 HP	23 HP	13 HP
Pump speed (rpm)	1450			
Replacement for	TTV2015	TTV2021	KTV4040*	
Used on	Scud 350	Scud 351	Ultra A/ Cobra A	Scud 400
Interchanges with Interpump	WS 201	WS202		
Max temp	74°C (85°C with hot seals fitted)			
Recommended nozzle size	045	060	050	035
Weight	14.2 kg	14.2 kg	14.2 kg	14.2 kg
Dimensions	272 x 192 x 146			
	<b>\$1,536</b>	<b>\$1,650</b>	<b>\$1,846</b>	<b>\$1,775</b>

Gearbox reqd RTI 121 HP8-18 (B318870973) \$863

\* these old style pumps have a 30mm shaft, if upgrading to a TTL or TTK the gearbox will also need to be changed

### TTK SERIES NEW KTL SERIES

24mm pump shaft		24mm pump shaft		
Model	TTK 3021	TTK 2130	KTL 1635	KTL 2035
S/code	BTTK3021	BTTK2130	BKTL1635	BKTL2035
Safety classification	Class B	Class B	Class A	Class B
Pump pressure	3,045 (210 bar)	4,350 (300 bar)	5,000 (350 bar)	5,000 (350 bar)
Flow	29 lpm	21 lpm	16 lpm	20 lpm
Suits engine (or equivalent)	Honda GX630	Honda GX630	Honda GX630	Honda GX630
Required HP	23 HP	23 HP	23 HP	23 HP
Pump speed (rpm)	1450		1450	
Replacement for	KKV2028*	KTV3021*		
Used on	Monsoon 300	Ultra/Cobra	King Cobra A	
Interchanges with Interpump	W 2030	W 3021		
Max temp	74°C (85°C with hot seals fitted)		74°C (85°C with hot seals fitted)	
Recommended nozzle size	055	055	035	045
Weight	15.7 kg	15.7 kg	15.7 kg	15.7 kg
Dimensions	302.6 x 192 x 146		302.6 x 192 x 146	
	<b>\$2,119</b>	<b>\$2,119</b>	<b>\$2,246</b>	<b>\$2,246</b>

RTI 121 HP7-18 (B319110973) \$863 (used with GX630)  
RTI 121 HP20+ (B319111973) \$912 (used with GX690)

6

### REPLACEMENT PUMP KITS ... SAVE 10%

#### SMART REPLACEMENT OPTIONS, EASY & COST EFFECTIVE

Kits (supplied unassembled) include Bertolini pump, unloader valve, safety valve, thermal dump and pressure gauge. Full instructions included.

Pump Model	S/code	Unloader valve	Safety valve	Thermal dump Valve	Pressure gauge	
WBL1114	BWBL1114KIT	BAPRI20ADJ	MTM00033003	MPA60063050	-	<b>\$1,074</b>
TTL1520	BTTL1520KIT	M215010400	MTM00033003	MPA60063070	AGCDR0102	<b>\$1,659</b>
TTL2120	BTTL2120KIT	M215010400	MTM00033003	MPA60063070	AGCDR0102	<b>\$1,761</b>
TTL1330	BTTL1330KIT	BVB350	MPA60156000	MPA60063070	AGCDR0102	<b>\$1,987</b>
TTL2028	BTTL2028KIT	BVB350	MPA60156000	MPA60063070	AGCDR0102	<b>\$2,051</b>
TTK3021	BTTK3021KIT	M215010400	MPA60156000	MPA60063070	AGCDR0102	<b>\$2,205</b>
TTK2130	BTTK2130KIT	BVB350	MPA60156000	MPA60063070	AGCDR0102	<b>\$2,298</b>
KTL1635	BKTL1635KIT	BVB350	MPA60058000	MPA60063070	AGCDR0102	<b>\$2,448</b>
KTL2035	BKTL2035KIT	BVB350	MPA60058000	MPA60063070	AGCDR0102	<b>\$2,448</b>

ASP (Aussie Safety Protection) kits, include thermal dump valve & safety valve. Protects operator & machine against excessive bypass & pressure spikes.

NOTE Aussie Pumps strongly recommends replacing the nozzle in the lance when purchasing a replacement pump kit. Purchase a 5 pack of nozzles with your pump kit and get a 10% discount! (p60 for details)

### BERTOLINI GEARBOXES

#### FOR PETROL/DIESEL ENGINES SAE FLANGE

Model	S/code	PTO Engine	Pump Shaft (mm)	Suits Pump models	
RTI 126 HP3-5	B318699973	¾"	24	WEL,TW, KWE, WBL	<b>\$543</b>
RTI 121 HP8-18	B318870973	1"	24	TTV, TTL	<b>\$863</b>
RTI 121 HP7-18	B319110973	1"	24	TTK, KTL, KKL	<b>\$863</b>
RTI 121 HP8-18	B318855973	1"	30	KTV, KKV	<b>\$863</b>
RTI 121 HP20+	B319111973	1 1/8"	24	KTL	<b>\$912</b>

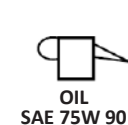

Larger gearboxes listed on page 86



### HEAVY DUTY SLOW SPEED BERTOLINI PUMP SERVICE PARTS

Example Bertolini Pump Breakdown  
TTL 300 series

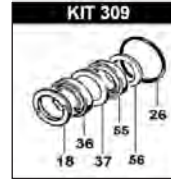
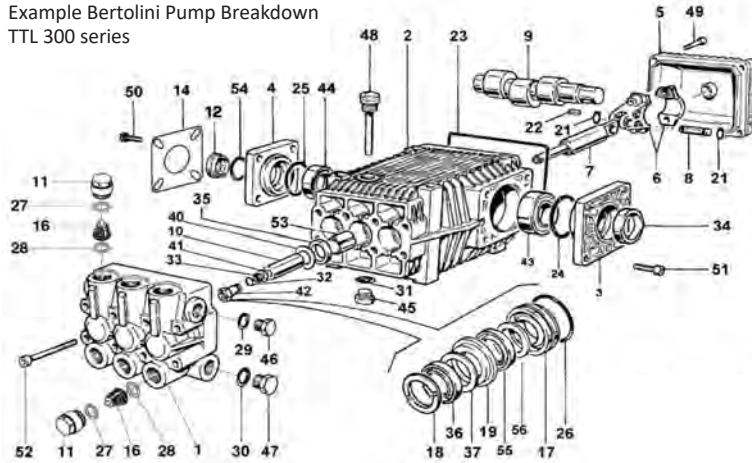

Minor seal kit  
HW = hot water seals up to 85°C

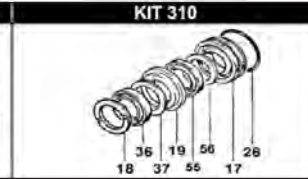

Major seal kit



Oil seal kit

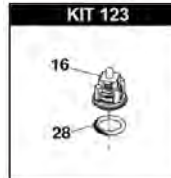

Valve kit



Full oil seal & sight glass kit

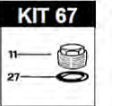

Valve cap kit

PUMP MODEL

	Part No.	Quantity	TTV 2015 TTV 2021	KTV 3015 TV 3021 KTV 4040	KKV 2028	HDS 5057	TTL 1520 TTL 2120	TTL 1330 TTL 1530	TTL 2030 TTL 2028	TTK 3021	TTK 2130 (4365)	KTL 1635 KTL 2035	RAL 2035	NEW RAL 2035-P 2535-P	RAS 4482	NEW RAS 4482 Premium	RA 316		
Valve Kit	BKIT123	12 pieces	✓	✓			✓	✓	✓		✓	✓	✓	✓				\$128 (\$179)	
	BKIT249 - HW	12 pieces			✓													\$216	
	BKIT40	12 pieces				✓												\$144	
	BKIT93	12 pieces				✓												\$194 (\$312)	
	BKIT148 BKIT253 - HW	12 pieces								✓						✓	✓	\$267	
Valve cap kit	BKIT209	18 pieces															✓	\$142	
	BKIT67	12 pieces	✓	✓			✓	✓	✓	✓	✓	✓	✓	✓	✓	✓		\$205	
	BKIT132	12 pieces			✓													\$470	
Minor Seal Kit	BKIT211	18 pieces															✓	\$224 (\$844)	
	BKIT89	18 pieces (BKIT311 s/no 15070568 up)	✓	✓			✓				✓							\$256 (\$1237)	
	BKIT200 - HW	18 pieces			✓					✓								\$220 (\$844)	
	BKIT90 BKIT201 - HW	18 pieces				✓												\$220 (\$844)	
	BKIT95	18 pieces (BKIT309 s/no 15070568 up)				✓		✓	✓									\$229	
	BKIT199 - HW	18 pieces																\$331	
	BKIT309	18 pieces										✓						\$229	
	BKIT153	19 pieces												✓				\$310	
Major Seal Kit	BKIT283	19 pieces														✓		\$310	
	BKIT164	19 pieces											✓					\$518	
	BKIT271 BKIT219 - HW	19 pieces												✓				\$310	
	BKIT227	13 pieces (BKIT277 premium series)															✓	\$1,005	
	BKIT86	24 pieces (BKIT312 s/no 15070568 up)	✓	✓			✓				✓							\$417	
	BKIT87	24 pieces			✓					✓								\$409	
	BKIT96	24 pieces (BKIT310 s/no 15070568 up)				✓		✓	✓									\$436	
Oil Seal Kit	BKIT310	24 pieces										✓						\$436	
	BKIT152	25 pieces														✓		\$310	
	BKIT282	25 pieces														✓		\$310	
	BKIT165	25 pieces											✓					\$518	
	BKIT270	25 pieces												✓				\$310	
Full oil seal & sight glass kit	BKIT228	19 pieces (BKIT276 premium series)															✓	\$1,005	
	BKIT37	3 pieces	✓	✓	✓	✓	✓	✓	✓	✓	✓	✓	✓	✓	✓	✓	✓	\$53	
	BKIT146	3 pieces											✓	✓	✓	✓	✓	\$65	
	BKIT127	10 pieces	✓				✓	✓	✓									\$127	
Piston	BKIT98	9 pieces		✓	✓	✓	✓	✓	✓	✓	✓	✓						\$119	
	BKIT147	11 pieces											✓	✓	✓	✓		\$118	
	BKIT210	10 pieces															✓	\$99	
	B060009182	20mm	✓	✓			✓				✓							\$116	
Sight Glass & o-ring	B060010182	22mm			✓					✓								\$144	
	B060055182	18mm				✓				✓		✓						\$174	
	B080070182	20mm											✓	✓	✓	✓	✓	\$198	
	B853515502	¾ threaded (with o-ring)		✓	✓	✓	✓	✓	✓	✓	✓	✓	✓	✓	✓	✓	✓	✓	\$22
Oil Breather	B060059322	Clip On	✓				✓	✓	✓	✓	✓	✓	✓	✓	✓	✓	✓	✓	\$33
	B060020322		✓	✓	✓	✓	✓	✓	✓	✓	✓	✓	✓	✓	✓	✓	✓	✓	\$15
Gearbox	B318870973	∅ 24mm/ 1" Shaft	✓				✓	✓	✓									\$863	
	B319110973	∅ 24mm/ 1" Shaft								✓	✓	✓						\$863	
	B319111973	∅ 24mm/ 1 1/8" Shaft										✓						\$912	
	B318855973	∅ 30mm/ 1" Shaft		✓	✓													\$863	
	B318880973	∅ 30mm/ 1 1/8" Shaft					✓							✓	✓	✓	✓	\$912	

HIGH PRESSURE PUMPS

6



## BERTOLINI PUMPS ... NEW PREMIUM SERIES HEAVY DUTY PUMPS FOR ENGINE MOUNTING, TO 7,300 PSI

Outstanding build quality and innovative design features provide efficient operation, easy maintenance and pump long life. Ideal for industrial and continuous running applications.



**BERTOLINI**  
pumps  
4 year warranty

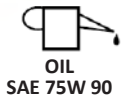

HIGH PRESSURE PUMPS

### RAS SERIES 30mm pump shaft

Model	RAS 4482-P NEW PREMIUM SERIES
S/code	BRAS4482
Pump pressure	4,300 psi (300 bar)
Flow	31 lpm
Suits engine (or equivalent)	31HP Vanguard
Pump speed	1725 rpm
Replacement for	
Used on	Python
Equivalent to Interpump	-
Shaft diameter	30mm
Max temp	74°C
Recommended nozzle size	070
Weight	18.5 kg
Dimensions LxWxH (mm)	324 x 281 x 228
	<b>\$2,596</b>

### RAL SERIES 30mm pump shaft

RAL 2035-P NEW PREMIUM SERIES	RAL 2535-P NEW PREMIUM SERIES
BRAL2035	BRAL2535
5,075 psi (350 bar)	5,075 psi (350 bar)
20 lpm	25 lpm
Honda GX690 or 27HP Vanguard	27HP Vanguard
1450 rpm	
HDS5057	
Predator W 3521	Predator Plus WW 3025
30mm	30mm
74°C (85°C with hot seals fitted)	
045	055
18.5 kg	18.5 kg
324 x 281 x 228	
<b>\$2,352</b>	<b>\$2,477</b>

### RA 316 series 30mm pump shaft

Model	RA 1650	RA 1850	RA 2150	RA 2450
S/code	BRA1650	BRA1850	BRA2150	BRA2450
Pump pressure	7,250 psi (500 bar)			
Flow	16 lpm	18 lpm	21 lpm	24 lpm
Required HP	20.7 (15.4 kW)	23 (17.3kW)	28 (21kW)	31 (23.4kW)
Pump speed	1450			
Shaft diameter	30mm			
Max temp	74°C			
Recommended nozzle size	025	030	035	040
Weight	20.8 kg			
Dimensions LxWxH (mm)	321 x 282 x 228			
	<b>\$3,558</b>	<b>\$3,558</b>	<b>\$3,558</b>	<b>\$3,558</b>

Bertolini Slow Speed Pump Parts Kits  
... see p 87

## 6

### REPLACEMENT PUMP KITS ... SAVE 10% SMART REPLACEMENT OPTIONS, EASY & COST EFFECTIVE

Kit (unassembled) includes Bertolini pump, unloader valve, safety valve, thermal dump and pressure gauge.

Pump Model	S/code	Unloader valve	Safety valve	Thermal dump Valve	Pressure gauge	
RAL2035	BRAL2035KIT	BVB350	MPA60058000	MPA60063070	AGCDR0102	<b>\$2,544</b>
RAL2535	BRAL2535KIT	BVB350	MPA60058000	MPA60063070	AGCDR0102	<b>\$2,429</b>
RAS4482	BRAS4482KIT	BVB350	MPA60058000	MPA60063070	AGCDR0102	<b>\$2,763</b>

### BERTOLINI GEARBOXES

FOR PETROL/DIESEL ENGINES SAE FLANGE

Model	S/code	PTO Engine	Pump Shaft (mm)	Suits Pump models	
RTI 121 HP20	B318880973	1 1/8"	30	RAL, RAS, RA, HD	<b>\$912</b>
RTI 123 HP35	B319219973	1 1/8"	30	RA RB	<b>\$977</b>

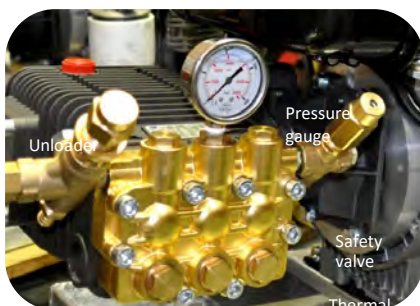

**ASP (Aussie Safety Protection)** kits, includes thermal dump valve & safety valve. Protects operator & machine against excessive bypass & pressure spikes.

**NOTE** Aussie Pumps strongly recommends replacing the nozzle in the lance when purchasing a replacement pump kit. Purchase a 5 pack of nozzles with your pump kit and get a **10% discount!** (p60 for details)

### NEW HEAVY DUTY RTI 123 GEARBOX

- low power absorption
- high efficiency
- double bearings



Smaller gearboxes listed on page 84







## BERTOLINI PUMPS

### ULTRA HIGH PRESSURE PUMPS TO 10,875 PSI

Designed for ultra high pressure applications in heavy industry

#### CAX SERIES

40mm pump shaft

- ◆ 316 stainless steel pump head, valve caps, piston bolt & screws
- ◆ High temperature packing system with 316 ss intermediate ring, ss retainer & PTFE anti-extrusion ring
- ◆ Rapid action check valves with spring, poppet & seat made of 316 ss
- ◆ Compact design, easy to install
- ◆ Strong, state of the art components
- ◆ Suit reverse osmosis, desalination, food processing pharmaceutical & chemical industries

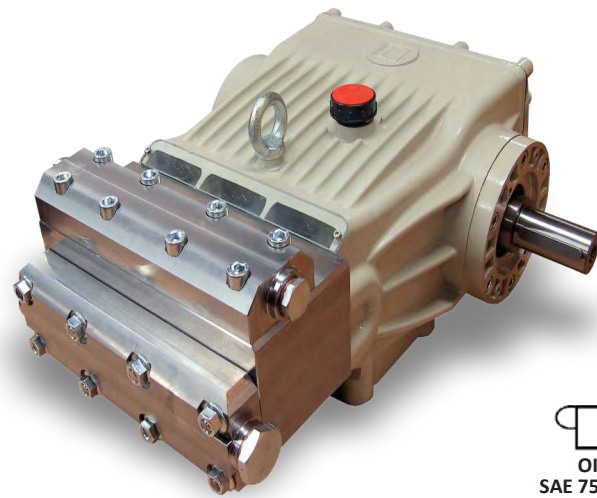

4 year warranty

Model	CAX 3060	CAX 2475
S/code	BCAX3060	BCAX2475
Pump pressure	8,700 psi (600 bar)	10,875 psi (750 bar)
Flow	31 lpm	25 lpm
Required HP		50 (37.3kW)
Pump speed		1000 rpm
Shaft diameter		40mm
Max temp		60°C
Weight		87.9 kg
Dimensions LxWxH (mm)		572 x 465 x 288
	<b>\$14,979</b>	<b>\$14,979</b>

## BERTOLINI PUMPS HIGH FLOW PUMPS TO 144 LPM

#### CPQ SERIES



**NEW**

- ◆ Forged brass head
- ◆ Stainless steel check valves
- ◆ Highly polished solid ceramic pistons, reduce friction & prolong seal life
- ◆ Patented du-dry plunger rod bushing, PTFE coated, reduces friction for smooth operation
- ◆ Compact diecast aluminium crankcase for high strength and anodized for corrosion resistance
- ◆ Premium oversized tapered roller bearings designed for heavier loads & extended operations

Model	CPQ9020	CPQ1316	CPQ1413	CPQ1613
S/code	BCPQ9020	BCPQ1316	BCPQ1413	BCPQ1613
Pump pressure	2,900 psi (200 bar)	2,320 psi (160 bar)	1,885 psi (130 bar)	1,885 psi (130 bar)
Flow	87 lpm	125 lpm	140 lpm	144 lpm
Required HP	45.7 (34.1kW)	52.6 (39.2kW)	48 (35.8kW)	52.8 (39.4kW)
Pump speed			1000 rpm	
Shaft diameter	30mm	36mm	40mm	40mm
Max temp			60°C	
Weight			55 kg	
Dimensions LxWxH			449 x 372x 240 mm	
	<b>\$5,101</b>	<b>\$5,321</b>	<b>\$5,539</b>	<b>\$5,539</b>

#### RD SERIES



Model	RD 7515
S/code	BRD7515
Pump pressure	2,175 psi (150 bar)
Flow	73lpm
Required HP	30 (22.1kW)
Pump speed	1450 rpm
Shaft diameter	30mm
Max temp	74°C
Weight	20.5 kg
Dimensions LxWxH	340 x 280 x 178 mm
	<b>\$2,407</b>

### BERTOLINI PUMPS HIGH FLOW TRIPLEX PUMPS



- ◆ Double diameter stainless steel piston guide with a radial ring that doesn't come into contact with the moving rod thus eliminating wear and improving lubrication
- ◆ Patented du-dry plunger rod bushing, PTFE coated, reduces friction for smooth operation
- ◆ Premium oversized tapered roller bearings designed for heavier loads & extended operations
- ◆ Compact diecast aluminium crankcase for high strength and anodized for corrosion resistance
- ◆ Forged brass head
- ◆ Double "V" packing self-lubricating elastomer sealing system for maximum seal life.
- ◆ Rapid action check valves with 316 stainless steel spring, poppet & seat.
- ◆ Interlocking "self-aligning" connecting rods capable of high loads made of two parts to facilitate installation and removal. It reduces friction and wear due to overheating.

#### CX SERIES

**NEW 4 year warranty**

Model	CX 1025	CX 1515	CX 1715
S/code	BCX1025	BCX1515	BCX1715
Pump pressure	3,600 psi (250 bar)	2,175 psi (150 bar)	2,175 psi (150 bar)
Flow	97 lpm	153 lpm	173 lpm
Required kW (electric)	48	45	51
Pump speed	1000 rpm		
Shaft diameter	40mm		
Max temp	60°C		
Weight	83 kg		
Dimensions LxWxH	537 x 465 x 294 mm		
	<b>\$9,138</b>	<b>\$9,138</b>	<b>\$9,138</b>



HIGH PRESSURE PUMPS

For full line-up check online .... [aussiepumps.com.au](http://aussiepumps.com.au)

## 6

### BERTOLINI GEARBOXES .... FOR PETROL / DIESEL ENGINES SAE FLANGE

Model	PTO Engine	Pump Shaft (mm)	S/code	Suits Pump models	
RTI 126 HP3-5	3/4"	24	B318699973	WEL,TW,KWE, WBL	<b>\$543</b>
RTI 121 HP8-18	1"	24	B318870973	TTV, TTL	<b>\$863</b>
RTI 121 HP7-18	1"	24	B319110973	TTK, KTL, KKL	<b>\$863</b>
RTI 121 HP8-18	1"	30	B318855973	KTV, KKV	<b>\$863</b>
RTI 121 HP20+	1 1/8"	24	B319111973	KTL	<b>\$912</b>
RTI 121 HP20	1 1/8"	30	B318880973	RAL,RAL-H,RAS,RAS-H, HD	<b>\$912</b>
RTI 123 HP35 (NEW)	1 1/8"	30	B319219973	RA RB	<b>\$977</b>
RTA 126 HP5	3/4"		B318701973	C35	<b>\$495</b>
RTA 160 HP7-10	1"		B318720973	C53	<b>\$674</b>
RTA 153 HP10-18	1"		B318642973	C63-73PR	<b>\$1,651</b>
RTA 162 HP10-18	1"		B318644973	C63-73PR	<b>\$1,704</b>

### BERTOLINI STAINLESS STEEL PROCESS PUMPS

- ◆ 316 stainless steel pump head, valve caps, piston bolt & screws
- ◆ High temperature packing system with 316 ss intermediate ring, ss retainer & PTFE anti-extrusion ring (TAM series)
- ◆ Rapid action check valves with spring, poppet & seat made of 316 ss
- ◆ Compact design, easy to install
- ◆ Strong, state of the art components
- ◆ Suit reverse osmosis, desalination, food processing pharmaceutical & chemical industries

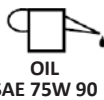

#### TAM SERIES 24 mm pump shaft



Model	TAM 1215	TAM 1315	TAM 1515	TAM 1715	TAM 2015
S/code	BTAM 1215	BTAM 1315	BTAM 1515	BTAM 1715	BTAM 2015
Pump type	Triplex				
Pump pressure	2,175 psi (150 bar)				
Flow	12 lpm	13 lpm	15 lpm	17 lpm	20 lpm
Required HP	4.6	5.1	5.9	6.6	7.7
Required kW	3.4	3.8	4.4	4.9	5.7
Pump speed	1450 rpm				
Shaft diameter	24mm				
Max temp	85°C				
Weight	10.6				
Dimensions LxWxH	252 x 187.5 x 127 mm				
	<b>\$3,380</b>	<b>\$3,380</b>	<b>\$3,460</b>	<b>\$3,601</b>	<b>\$3,601</b>

#### KA SERIES 24 mm pump shaft



Model	KA 2815	KA 3215	KA 3815	KA 4215
S/code	BKA 2815	BKA 3215	BKA 3815	BKA 4215
Pump pressure	2,175 psi (150 bar)			
Flow	28.6 lpm	32.5 lpm	37.7 lpm	41.6 lpm
Required HP	11.3	12.8	14.9	16.4
Required kW	8.4	9.6	11.1	12.3
Pump speed	1450 rpm			
Shaft diameter	24mm			
Max temp	74°C (85°C with hot seals fitted)			
Weight	19.3			
Dimensions LxWxH	<b>318 x 192 x 146 mm</b>			
	<b>\$4,508</b>	<b>\$4,673</b>	<b>\$4,761</b>	<b>\$4,795</b>





## BERTOLINI MOTOR PUMPS

- ◆ Efficient 4 pole, three phase motors
- ◆ High quality flexible coupling made of cast iron .. Absorb vibrations from motor
- ◆ Heavy duty pumps for continuous use applications
- ◆ Pressure regulation valve with automatic bypass
- ◆ Strong, heavy duty steel welded frame with lifting eyes
- ◆ Steel coupling guard for maximum protection
- ◆ Glycerine filled pressure gauge with stainless steel case
- ◆ Pre-charged pulsation dampener on pump discharge for smooth operation
- ◆ 80 mesh filtration inlet strainer
- ◆ Anti vibration mounts under frame
- ◆ NB: No switch supplied

### CK SERIES

Inlet	Diameter	1¼" BSP (40mm)
	Min pressure	-3 psi
	Max pressure	87 psi
	Max temp	60°C (85°C with hot seals fitted)
Outlet	Diameter	¾" BSP
	Valve - Out	1" BSP
	By pass	1" BSP
Base	Dimensions (mm)	1230 x 640
	Weight	65 kg



HIGH PRESSURE PUMPS

6

MOTOR PUMP UNIT	Pump	Three phase motor				RPM	bar	PSI	Flow lpm	Weight (kg)	POA
		50hZ- 400V	KW	Amps							
73.9203.97.3	CK 2216	160L 4 POLE	15	29.5	1450	100	1450	63	270		
73.9206.97.3	CK 2216	180L 4 POLE	22	42	1450	150	2175	63	326		
73.9204.97.3	CK 2220	180M 4 POLE	18.5	35	1450	100	1450	80	312		
73.9207.97.3	CK 2220	200L 4 POLE	30	56.6	1450	150	2175	80	382		
73.9205.97.3	CKL 2226	180L 4 POLE	22	42	1450	100	1450	97	326		
73.9208.97.3	CKL 2226	200L 4 POLE	30	56.6	1450	150	2175	97	382		
73.9209.97.3	CKL 2233	200L 4 POLE	30	56.6	1450	120	1740	126	382		
73.9200.97.3	CK 1224	200L 6 POLE	18.5	37.3	975	80	1160	97	371		
73.9201.97.3	CK 1229	200L 6 POLE	22	43.9	975	80	1160	124	380		
73.9202.97.3	CK 1235	200L 6 POLE	22	43.9	975	70	1015	150	380		



### C3006 SERIES

Inlet	Diameter	1¼" BSP
	Min pressure	-3 psi
	Max pressure	87 psi
	Max temp	60°C
Outlet	Diameter	¾" BSP
	Valve - Out	1" BSP (1¼" BSP - C1258)
	By pass	1" BSP (1½" BSP - C1258)
Base	Dimensions (mm)	200 L : 1230 x 640 225M & 250M: 1370 x 640
	Weight	70 kg



MOTOR PUMP UNIT	Pump	Three phase motor				RPM	bar	PSI	Flow lpm	Weight (kg)	POA
		50hZ- 400V	KW	Amps							
76.9202.97.3	C 1538	200L 4 POLE	30	56.6	1450	100	1450	151	410		
76.9200.97.3	C 1248	225M 6 POLE	30	58.9	975	80	1160	192	475		
76.9201.97.3	C 1258	250M 6 POLE	37	69.3	975	70	1015	245	591		



## ENERGY SAVING / PUMP CORRECT USE

It is quite normal that the pump flow is oversized in comparison with the application.

Ideally, the water recirculated through the regulating valve should not exceed 10-15% of the pump flow.

If it exceeds this, besides being inefficient, the recirculating water will heat up causing stress on seals and valves, and increasing the risk of cavitation in the pump. It is therefore recommended that the pump capacity is reduced to the actual system needs by moderating the pump R.P.M.

### FAQ

**Question:** How much you must reduce the pump R.P.M. in order to get a lower capacity?

**Answer:** Required R.P.M. =  $\frac{\text{Expected capacity} \times \text{Max R.P.M. allowed}}{\text{Max allowed capacity}}$

**Question:** What diameter engine/motor pulley is required to achieve these R.P.M.?

**Answer:** External diameter of the engine/ motor pulley =  $\frac{\text{External diameter of the pumps pulley} \times \text{R.P.M. pump}}{\text{R.P.M. motor/engine}}$

**Question:** What if it is not possible to replace the engine/motor pulley?

**Answer:** External diameter of the pump pulley =  $\frac{\text{External diameter engine/motor pulley} \times \text{R.P.M engine/motor}}{\text{Pump R.P.M.}}$

**Question:** If the engine/motor is running at lower R.P.M. than the max. R.P.M indicated in the label, what is the max capacity achievable?

**Answer:** Achievable max capacity =  $\frac{\text{Engine /Motor R.P.M:} \times \text{Max capacity indicated in the label}}{\text{Max. R.P.M. indicated in the label}}$

**Question:** What is the approximate power required to achieve the max performances allowed?

**Answer:** Required power ( electric motors HP) =  $\frac{\text{Max capacity (L/min)} \times \text{Max pressure (bar)}}{385}$

Required power (petrol/diesel engines HP) = electric motors HP x 1.3

## TYPICAL PUMP INSTALLATION

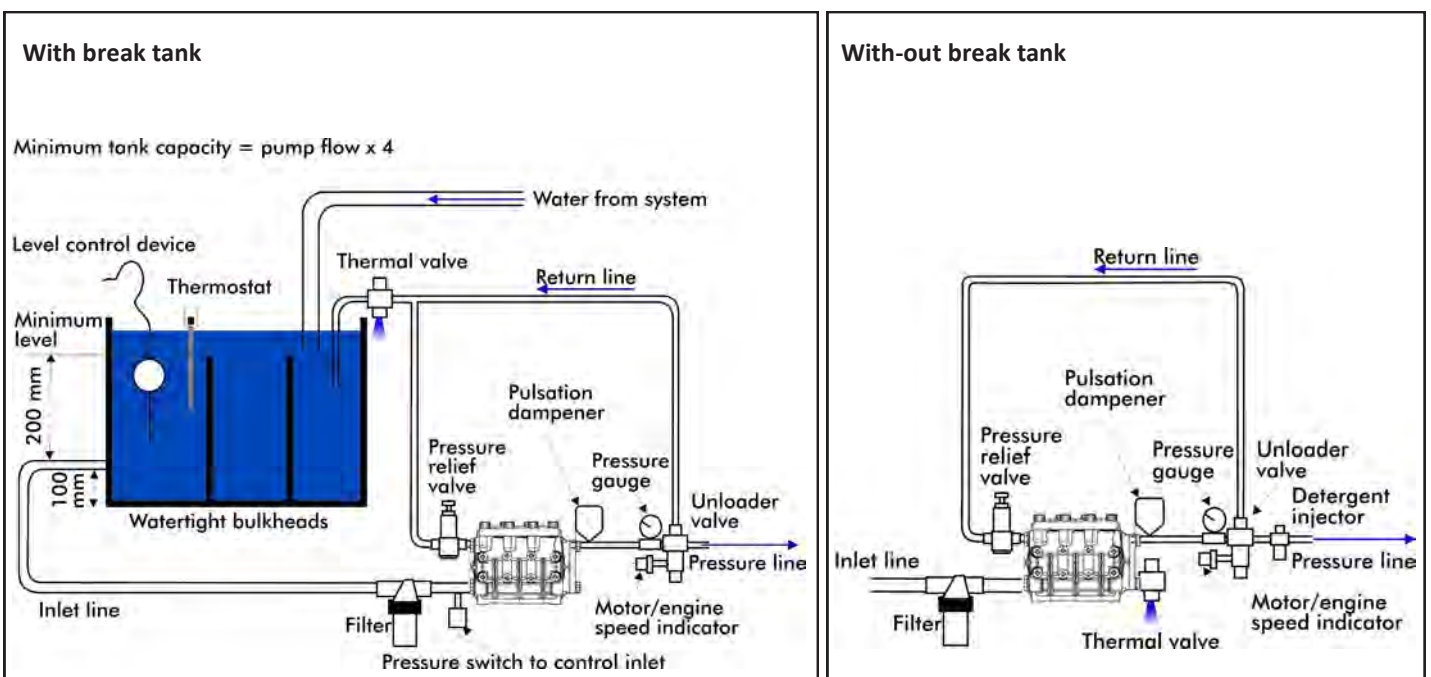



KAPPA 43



DELTA 75

Top quality Udor diaphragm pumps designed for long, trouble free life in ag spray applications. Pumps offer limited self priming from 1 1/2 m.

Designed for mounting on petrol or diesel engines.

- Broad acre spraying
- High pressure water transfer
- Spot spraying
- Machine wash down
- Sheep jetting
- Golf and turf
- Sugar cane
- Vegetable
- Viticulture
- Olives
- Cotton

- Positive displacement diaphragm design
- Large capacity oil bath in crankcase
- Compatible with most fluids including liquid fertilizers
- Handles fluids to 60 degrees F (15 degrees C)
- Multiple diaphragm design
- Interchanges with other brands

- ⇒ Delivers consistent flow right through the pressure range
- ⇒ Cool running, reliable
- ⇒ Super versatile
- ⇒ Compatible with high temperature applications
- ⇒ Smooth running
- ⇒ Permits easy upgrade

### 6 PUMP KITS ... FOR ENGINE DRIVE APPLICATIONS All kits include pump & gearbox, control units not included

Model	Stock Code	No of diaphr.	Flow (l/m)	Bar	PSI	Suits engine	HP	kW	kg	RPM	Recommended control unit (sold separately)	
KAPPA 43	SKAPPA43ASSY	3	44	40	568	3/4" keyed Q shaft Honda GX200 (Yanmar L48)	4.2	3.1	10	550	SDS3/40 (\$372)	<b>\$2,103</b>
DELTA 75	SDELTA75ASSY	3	75	40	568	1" keyed Q shaft Honda GX270 (Yanmar L100)	7.7	5.7	19	550	SDS3/40 (\$372)	<b>\$3,827</b>
DELTA 125	SDELTA125ASSY	5	125	40	568	1" keyed Q shaft Honda GX390 (Yanmar L100)	12.3	9	27	550	VRG150 (\$549)	<b>\$4,620</b>
DELTA 151	SKDELTA151ASSY	4	153	50	710	Honda GX690 (Kohler 23HP)	19.5	14.3	36	550	VRG150 (\$549)	<b>\$6,498</b>

Replacement gearboxes

S160-3/4" VAZ	S160 Gearbox for Zeta 85	SGEARREDS160VAZ	<b>\$883</b>
S160-3/4" GR	S160 Gearbox for Kappa 43	S4425507175	<b>\$883</b>
M164-1"VA	Gearbox for Delta 75	S5033A4	<b>\$1,064</b>
M164-1"VA	Gearbox for Delta 125	S5033A4	<b>\$1,064</b>
M162-1"VA	Gearbox for Kappa 151	S442285034B5	<b>\$1,791</b>



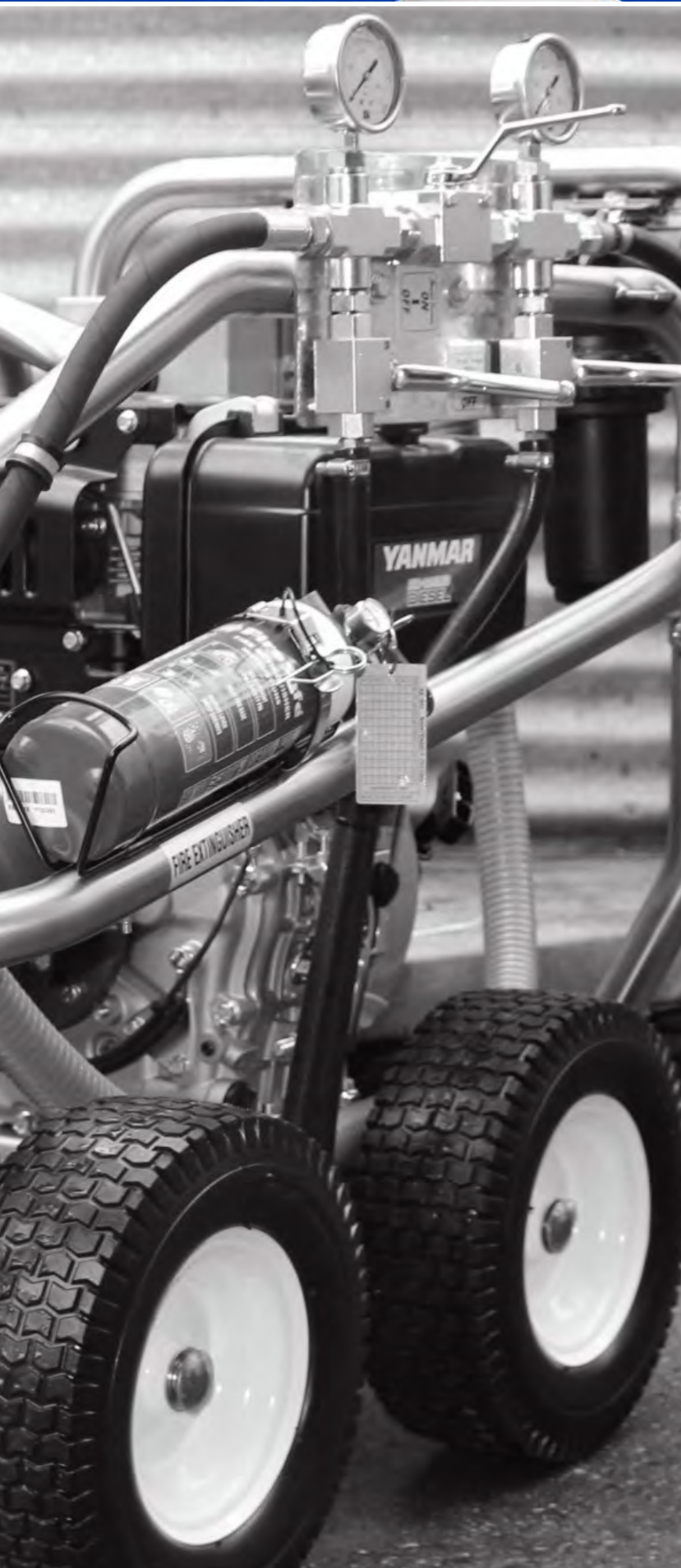

### HIGH PRESSURE

**Petrol drive**  
100 bar - 500 bar,  
Flows to 21 lpm

p96



### HIGH PRESSURE

**Diesel drive**  
140 bar - 500 bar,  
Flows to 21 lpm

p97



### HIGH PRESSURE

**Mine spec**  
200 bar - 500 bar,  
Flows to 21 lpm

p97



### HIGH FLOW

**Petrol, diesel & mine spec**  
20 bar - 40 bar,  
Flows to 125 lpm

p98



### HIGH PRESSURE HYDROSTATIC TESTERS

**NEW**  
STAINLESS  
STEEL FRAME



Scud 400 HTP with Optional hose reel



Super high pressure hydrostatic testers driven by petrol & diesel engines. Machines come in sturdy ergonomic frame, four wheel trolleys with big flat free tyres.

- Leak detection in water pipelines
- Hydrostatic testing of boilers
- Hydrostatic testing of pressure vessels
- Oil or gas pipeline testing
- Hydrostatic testing of pumps, valves or fire mains

**Benefits:**

- » Can handle wide range of tests
- » Fast pump up to pressure
- » Easy to service
- » Easy to check for leaks
- » Adjust to required pressure
- » No exposed moving parts, safer
- » Easy to move on site



- Super high pressures to 500 bar (7,300 psi)
- Big flows to 20 lpm
- Simple piston pump design
- Double pressure gauge with lock of valve
- Integrated control valve
- Gearbox drive
- Stainless steel frame trolley with four big flat free tyres (pneumatic on larger diesel units)
- Electric drive available on request

\* electric start option available

**PETROL DRIVE**

Model	S/code	Pump Pressure (psi)	Pump model	Flow rate (lpm)	Engine	Pump (rpm)	Box Size (LxWxH) mm	Wt (kg)	
BB100 HTP*	ABB100KGX200HTP	2,000 (140 bar)	WBL1114	11	Honda 6.5HP GX200 recoil	1450	620x540x580	45	<b>\$4,168</b>
Scud 350 HTP*	ABBSS350/390HTP	3,000 (200 bar)	TTL1520	15	Honda 13HP GX390 recoil	1450	1100x800x950	110 <sup>#</sup>	<b>\$6,108</b>
Predator A HTP	ABSSPRED-A/GX630HTP	5,000 (350 bar)	RAL2035	20	Honda 28HP GX690 e/start	1450	1100x800x1130	130	<b>\$10,873</b>
Raptor 18 HTP	ABSSRAP/VAN18HTP	7,300 (500 bar)	RA1850	18	Vanguard 35HP e/start	1450	1100x800x1000	135	<b>\$18,843</b>

KPA = bar x 100

**Optional Wash-Down Kits ...** Gun/lance & high pressure hose kits enable hydrostatic tester to be used as a blaster... page 97





**NEW**  
STAINLESS  
STEEL FRAME



Raptor Kohler HTP

### Aussie Mine Boss Hydrostatic Testers

Aussie Mine Spec Features:

- 38mm Scud gal frame with anti vib mounts
- Steel wheels with pneumatic tyres
- Emergency stop
- Fire extinguisher
- Dry cell battery
- Double insulated wiring
- Optional bunded tray



HYDROSTATIC TESTERS

#### DIESEL DRIVE

# these units are shipped on a skid, dimensions & weight include skid.







Model	S/code	Pump Pressure (psi)	Pump model	Flow rate (lpm)	Engine	Pump (rpm)	Boxed Dimensions (LxWxH) mm	Wt (kg)	
Scud 100 D HTP	ABBSS100DHTP	2,000 (140 bar)	WBL1114	11	YANMAR L48 4.8HP recoil	1450	680 x 400 x 340	70	<b>\$6,084</b>
Scud 350 D HTP	ABBSS350L100HTP	3,000 (200 bar)	TTL1520	15	YANMAR L100E 10HP e/start	1450	1100x800x950	160 <sup>#</sup>	<b>\$10,617</b>
Scud 400 D HTP	ABBSS400DHTP	4,000 (275 bar)	TTL1330	13	YANMAR L100E 10HP e/start	1450	1100x800x950	160 <sup>#</sup>	<b>\$10,993</b>
Predator A DHTP	ABSSPRED-A/KDEHTP	5,000 (350 bar)	KTL	21	KOHLER KD477 23HP e/start	1450	1250x800x1130	250	<b>\$22,359</b>
Raptor D HTP 16	ABRAPTOR16DHTP	7,300 (500 bar)	RA1650	16	KOHLER KD477 23HP e/start	1450	1200x1200x1500	250	<b>\$23,159</b>
Raptor 450 D HTP	ABRAP450KDEHTP	6,525 (450 bar)	RA1850	18	KOHLER KD477 23HP e/start	1450	1200x1200x1500	250	<b>\$23,159</b>
Raptor D HTP 18	ABRAP18KDEHTP	7,300 (500 bar)	RA1850	18	KOHLER KD625 28HP e/start	1450	1200x1200x1500	280	<b>\$26,361</b>

#### Aussie Mine Boss option

Scud 350 D HTP	ABBSS350DHTPMS	3,000 (200 bar)	TTL1520	15	YANMAR L100E 10HP e/start	1450	1100x800x950	175 <sup>#</sup>	<b>\$13,285</b>
Predator A DHTP	ABSCPREDAKDEHTPM	5,000 (350 bar)	RAL2035	21	KOHLER KD477 23HP e/start	1450	1250x800x1130	265	<b>\$24,897</b>
Raptor D HTP 16	ABRAP16DHTPMS	7,300 (500 bar)	RA1650	16	KOHLER KD477 23HP e/start	1450	1200x1200x1500	265	<b>\$25,694</b>
Raptor D HTP 18	ABRAP18KDEHTPMS	7,300 (500 bar)	RA1850	18	KOHLER KD625 28HP e/start	1450	1200x1200x1500	295	<b>\$28,895</b>

KPA = bar x 100

**Optional Wash-Down Kits ...** Gun/lance & high pressure hose kits enable hydrostatic tester to be used as a blaster

Suits	Gun/lance kit		10 metres of high pressure hose	
HTPs to 4,000 psi	 APROGUN-900-035 \$175 APROGUN-900-045 \$175		 10m 5,800 PSI (AHW06M22X2X10)	\$177
5,000 psi HTPs	 MPA30456000 \$213 C915 ___ M (nozzle) \$22		 10m 5,800 PSI (AHW06M24X2X10)	\$279
500 bar HTPs	 MPA30473000 \$621 + nozzle \$142		 10m 500 bar (A3641443109)	\$666

### HIGH FLOW HYDROSTATIC TESTERS



This range of hydrostatic testers consist of reliable Udor diaphragm pumps driven by petrol or diesel engines.

- High flow pumps to 125 litres per minute, pressures to 4,000 kPa
  - Reliable Udor pumps standard
  - Simple diaphragm design pump
  - In line strainers standard
  - Double pressure gauge and lock off valve system
  - Integrated control system
  - Gear box drive, enclosed
  - Heavy duty trolley with four big flat free tyres
- Applications:**
- Leak detection in water pipelines
  - Hydrostatic testing of boilers
  - Hydrostatic testing of pressure vessels
  - Oil or gas pipeline testing
  - Hydrostatic testing of pumps, valves or fire mains

# these units are shipped on a skid, dimensions & weight include skid.

\* electric start option available

#### HONDA PETROL ... 3 YEAR ENGINE WARRANTY

Model	S/code	Max Pump Pressure (psi)	Max Flow (lpm)	Engine	Pump (rpm)	Boxed Dimensions (LxWxH) mm	Weight (kg)	
Kappa 43 HTP*	SKAPPA43/HTP200	580 (40 bar) 4,000 kPa	44	HONDA 6.5HP recoil start	550	1100x800x900	50	<b>\$5,648</b>
Delta 75 HTP*	SDELTA75HTP390	580 (40 bar) 4,000 kPa	73	HONDA 13HP recoil start	550	1100x800x950	110 <sup>#</sup>	<b>\$6,709</b>
Delta 125 HTP*	SDELTA125HTP390	435 (30 bar) 3,000 kPa	125	HONDA 13HP recoil start	550	1100x800x950	120 <sup>#</sup>	<b>\$8,428</b>

#### YANMAR DIESEL ... 2 YEAR ENGINE WARRANTY

Note: Pressure and flow figures are expressed as pump maximums. Horsepower limitations may affect pressure/flow combinations.

Model	S/code	Max Pump Pressure (psi)	Max Flow (lpm)	Engine	Pump (rpm)	Boxed Dimensions (LxWxH) mm	Weight (kg)	
ZETA 85 D HTP	SZETA85/L48HTP	290 (20 bar) 2,000 kPa	85	<b>YANMAR 4.8HP</b> recoil	550	1100x800x950	65 <sup>#</sup>	<b>\$7,970</b>
	SZETA85/L48EHTP	290 (20 bar) 2,000 kPa	85	<b>YANMAR 4.8HP</b> electric start	550	1100x800x950	65 <sup>#</sup>	<b>\$9,082</b>
Kappa 43 D HTP	SKAPPA43HTPL48E	580 (40 bar) 4,000 kPa	44	<b>YANMAR 4.8HP</b> electric start	550	1100x800x950	65 <sup>#</sup>	<b>\$9,082</b>
Delta 75 D HTP	SDELTA75L100HTP	580 (40 bar) 4,000 kPa	75	<b>YANMAR 10HP</b> electric start	550	1100x800x950	160 <sup>#</sup>	<b>\$11,213</b>
Delta 125 D HTP	SDELTA125HTP100	435 (30 bar) 3,000 kPa	125	<b>YANMAR 10HP</b> electric start	550	1100x800x950	170 <sup>#</sup>	<b>\$11,751</b>

#### Aussie Mine Boss option ....

includes following extras

- 38mm super robust gal frame
- Balanced lifting bar
- Emergency stop
- Double insulated wiring
- Lockable battery isolation
- Dry cell battery
- Integrated fire extinguisher
- Bunded tray



#### Wash down kit ...

Turbo 400 gun with 30m of 10mm single wire braid hose

SHOSEKIT1 **\$1,122**



Model	S/code	Max Pump Pressure (psi)	Max Flow (lpm)	Engine	Pump (rpm)	Boxed Dimensions (LxWxH) mm	Weight (kg)	
Delta 75 D HTP	SDELTA75L100HTM	580 (40 bar) 4,000 kPa	75	<b>YANMAR 10HP</b> electric start	550	1100x800x950	175 <sup>#</sup>	<b>\$13,214</b>
Delta 125 D HTP	SDELTA125L100HTM	435 (30 bar) 3,000 kPa	125	<b>YANMAR 10HP</b> electric start	550	1100x800x950	185 <sup>#</sup>	<b>\$13,771</b>



### NEW CLEAN AIR SERIES EUROPE'S FINEST



COMMERCIAL  
WET/DRY VACS

p100



INDUSTRIAL  
WET/DRY VACS

p101



JUMBO VACS

p102



DRUM VACS

p102



PUMP OUT VACS

p103



CARPET  
EXTRACTORS

p103



ACCESSORIES

p104



### 10 LITRE WET/DRY ... VF13

**71.5dBa**



- ◆ Impact resistant polypropylene barrel
- ◆ Unique Aussie Microweb ... 99.9% filtration, reusable filter
- ◆ Professional 32mm tool kit
- ◆ 7 metre heavy duty commercial grade power cable
- ◆ Heavy duty wheel kit



32mm accessory kit

Model	<b>VF13</b>
S/code	VF13
Capacity	10 litres
Motor	1 x 1200 watt, 240 volt
Air Flow	250 m <sup>3</sup> /h
Air Flow	70 l/s
Noise Level	71.5 dBA at 7m
Weight	8 kg
Boxed dimensions	400 x 380 x 600 mm
	<b>\$430</b>

Replacement Microweb filter (VKF052) \$125

### 30 LITRE WET/DRY ... VC44

**60dBa**

#### SUPER QUIET



- ◆ Impact resistant polypropylene barrel
- ◆ Heavy duty wheel kit
- ◆ Professional 40mm accessory kit
- ◆ Unique Aussie Microweb ... 99.9% filtration, reusable filter
- ◆ 7 metre durable power cable

Model	<b>VC44</b>
S/code	VC44
Capacity	30 litres
Motor	1 x 1200 watt, 240 volt
Water lift	2200 mm
Air Flow	70 l/s
Accessory size	40 mm
Weight	12 kg
Boxed dimensions	440 x 440 x 800
	<b>\$504</b>

Replacement Microweb filter (VKF055) \$125



40mm accessory kit

## 6 Accessories & options for VF13



Multipurpose carpet & floor tool

### 32 MM ACCESSORIES

- ◆ Heavy duty, 3 metre, crush proof hose
- ◆ Multipurpose carpet & floor tool
- ◆ Squeegee with swivel
- ◆ 3 piece chrome wand assembly including handle
- ◆ Crevice tool
- ◆ Venetian blind tool
- ◆ Round brush



Blind tool

### OPTIONAL ACCESSORIES

- ◆ Turbo brush, air driven (s/code V72042) **\$213**
- ◆ Paper bags, set of five (s/code V40096) **\$40**

## Accessories & options for VC44



Squeegee with swivel

### 40 MM ACCESSORIES

- ◆ 3 metre flexible crush proof hose VHOSE38MMX3
- ◆ 2 piece chrome wand assembly VHH012M(male) & VHH012F (female)
- ◆ Crevice tool VLL002N
- ◆ Round brush VZZ061
- ◆ Hard floor brush with swivel (420mm) VKS011
- ◆ Squeegee with swivel (420mm) VKS013
- ◆ Adaptor to suit round brush VAD001



Hard floor brush with swivel

### OPTIONAL ACCESSORIES

- ◆ Aluminium carpet brush (suits 40mm accessory kit) (VKS012) \$70
- ◆ Paper bag (VSF802) \$29
- ◆ Reusable nylon filter, protects VC61 Microweb filter (VSF065) \$59
- ◆ Drain kit (VKT013) \$104



### 50 & 75 LITRE WET/DRY

#### INDUSTRIAL STRENGTH

- ◆ Impact resist polypropylene barrel
- ◆ Heavy duty wheel kit
- ◆ Professional 40mm accessory kit
- ◆ Unique Aussie Microweb ... 99.9% filtration, reusable filter
- ◆ 7 metre durable power cable



40mm accessory kit

Model	VC61	VC72	VC73
S/code	VC61	VC72	VC73
Capacity	50 litres	75 litres	75 litres
Motor	1 x 1200 watt, 240 volt 10 amp plug	2 x 1200 watt, 240 volt 10 amp plug	3 x 1200 watt, 240 volt 15 amp plug
Water lift	2200 mm	2400 mm	2600 mm
Air Flow	70 l/s	119 l/s	181 l/s
Accessory size	40 mm	40 mm	40 mm
Weight	22 kg	28 kg	31 kg
Boxed dimensions LxWxH (mm)	570 x 530 x 920	660 x 580 x 1000	660 x 580 x 1000
	<b>\$754</b>	<b>\$933</b>	<b>\$1,078</b>

Replacement Microweb filter (VKF056) \$167 (VKF056) \$167 (VKF056) \$167

#### What is Microweb?

It's a **unique** filter media constructed from a **homopolymer acrylic fibre**. It has a microporous membrane applied to the collection surface. This provides a low pressure drop, causes the dust to 'cake', facilitates **better dust release** and **improves collection efficiency**.



**Microweb** is essential for dust from limestone, biochemical, lead, sugar, cement, Gyprock, precious metals, pigments and fertilizers.



Orange or blue head options



AUSSIE VACCS

### Accessories & options for VC61/72/73



Squeegee with swivel



Hard floor brush with swivel

#### 40 MM ACCESSORIES

- ◆ 3 metre flexible crush proof hose VHOSE38MMX3
- ◆ 2 piece chrome wand assembly including handle VHH012M(male) VHH012F (female)
- ◆ Crevice tool VLL002N
- ◆ Round brush VZZ061
- ◆ Hard floor brush with swivel (420mm) VKS011
- ◆ Squeegee with swivel (420mm) VKS013
- ◆ Adaptor to suit round brush VAD001

#### OPTIONAL ACCESSORIES

- ◆ Aluminium carpet brush (suits 40mm accessory kit) (VKS012) \$70
- ◆ Paper bag (VSF802) \$29
- ◆ Reusable nylon filter, protects Microweb filter (VSF065) \$54

#### DRAIN KIT

Drain kit, fits to any barrel vac to enable tank to be drained without lifting barrel

VKT013 \$104



### JUMBO WET/DRY

#### INDUSTRIAL STRENGTH

- ◆ Impact resist polypropylene barrel
- ◆ Heavy duty wheel kit
- ◆ 50mm & 90mm accessory kit
- ◆ Unique Aussie Microweb... 99.9% filtration, reusable filter
- ◆ 7 metre durable power cable



90mm accessories



50mm accessories

**FREE**  
Microweb filter  
...99.9% filtration



Model	<b>Jumbo</b>
S/code	VC83
Capacity	75 litres
Motor	3 x 1200 watt, 240 volt 15 amp plug
Water lift	2600 mm
Air Flow	181 l/s
Accessory size	50 & 90 mm
Weight	31kg
Boxed dims LxWxH (mm)	640 x 700 x 1000
	<b>\$1,467</b>

Replacement Microweb filter (VKF056) \$167

#### 50 MM ACCESSORIES

- ◆ 3 metre flexible crush proof hose
- ◆ One piece chromed steel wand with handle
- ◆ Crevice tool
- ◆ Round brush
- ◆ Heavy duty hard floor tool available for wet/dry applications
- ◆ Accessory adaptor

#### 90MM ACCESSORIES

- ◆ Super strength 3 metre sinflex hose assembly
- ◆ 1 metre heavy duty 90mm poly suction tube
- ◆ Poly suction spout (length 310mm)

#### OPTIONAL ACCESSORIES

- ◆ Paper bag (VSF802) \$29
- ◆ Reusable nylon filter, protects Microweb filter (VSF065) \$59
- ◆ Drain kit (VKT013) \$104

AUSSIE VACS

## 6 AUSSIE DRUM VAC ...WORKSHOP CLEAN-UP



- ◆ Standard 200 litre steel drum for easy disposal/replacement.
- ◆ Heavy duty steel collar
- ◆ Professional 40mm accessory kit with standard version (see p 99)
- ◆ 50mm & 90mm accessories with Jumbo version (see above)
- ◆ Unique Aussie Microweb ... 99.9% filtration, reusable filter
- ◆ 7 metre durable power cable

**FREE**  
Microweb filter  
...99.9% filtration



	DRUM VAC	JUMBO DRUM VAC
Model	VDRUMVAC40MM	VDRUMVAC50MM/90
S/code		
Capacity		200 litres
Motor		3 x 1200 watt, 240 volt, 15 amp plug
Water lift		2600 mm
Air Flow		181 l/s
Accessory size	40 mm	50 & 90 mm
Weight		63 kg
Boxed dimensions		570 x 530 x 970
	<b>\$2,821</b>	<b>\$3,067</b>
Trolley (VDRUMDOLLIE)	\$681	



## 75 LITRE PUMP OUT VAC

### WET AREA SPECIALIST

#### INDUSTRIAL STRENGTH



- ◆ Impact resist polypropylene barrel
- ◆ Heavy duty wheel kit
- ◆ 40mm flexible crush proof hose (3m)
- ◆ Heavy duty squeegee tool
- ◆ 7 metre durable power cable
- ◆ Pump-out system
- ◆ Note: no filter fitted, not suitable for dust collection

Model	<b>VC72MX</b>
S/code	VC72MX
Capacity	75 litres
Motor	2 x 1200 watt, 240 volt
Water lift	2400 mm
Air Flow	119 l/s
Accessory size	40 mm
Weight	32 kg
Boxed dimensions LxWxH (mm)	660 x 580 x 1000
	<b>\$1,944</b>



AUSSIE VACS

6

## AUSSIE CARPET EXTRACTOR

A heavy duty carpet extractor designed for domestic and commercial applications. Forces detergent water deep into the carpet then extracts dirty water into the recovery tank.

Units feature a 50 litre stainless steel recovery tank, and 30 litre polypropylene solution tank mounted on a manoeuvrable trolley.

Model	<b>VL450</b>
S/code	VL450
Capacity	50 litres
Motor	2
Air Flow	119 m <sup>3</sup> /h
Delivery	2 lpm
Pump	1/3HP Shurflo
Weight	33 kg
Boxed dimensions	670 x 810 x 1010
	<b>\$2,667</b>

#### Standard Accessories

- Chrome wand with carpet extractor, with 2 jets , 280 mm width
- Upholstery tool with single jet



Stock Code	Description		
<b>32mm Accessories (standard with all vacs)</b>			
V68220X3		Heavy duty, 3 metre, crush proof hose	\$78
VZZ002	A	Multipurpose carpet & floor tool	\$76
VKC002	B	3 piece chrome wand assembly including handle	\$67
VLL01N	C	Crevice tool	\$13
VZZ077N	D	Venetian blind tool	\$13
VZZ021N	E	Round brush	\$21
<b>Optional 32mm Accessories</b>			
V68220		Extension hose (per metre)	\$26
V69035		Hose joiner	\$19
<b>40mm Standard Accessories</b>			
VAK40MM		Complete kit	\$327
VHOSE38MMX3		3 metre flexible crush proof hose	\$83
VHH012M (to hose)	A	2 piece chrome wand assembly including handle (male or female)	\$34 each
VHH012F (to tools)	B		
VLL002N	C	Crevice tool	\$15
VZZ061	D	Round brush	\$22
VKS011	E	Hard floor brush with swivel (length 420mm)	\$80
VKS013	F	Squeegee with swivel (length 420mm)	\$89
VAD001	G	Accessory adaptor to suit round brush	\$15
<b>Optional 40mm Accessories</b>			
VKS012		Aluminium carpet brush with swivel	\$70
VKA011		Outrigger (650mm) with mounting bracket	\$720
VKR001		Hard floor brushes to suit outrigger (two needed)	\$66
VHOSE38MM		Extension hose (per metre)	\$29
VEE005N		38mm hose cuff (hose to wand fitting)	\$20
VEE004N		38mm hose tail (hose to tank fitting)	\$18
V69052		38mm hose jointer	\$24
VLA013		Rubber squeegee to suit VKS013 (two required)	\$26
<b>50mm Accessories</b>			
VK0100		Complete kit	\$484
VKT005		3 metre flexible crush proof hose	\$164
VHH005		One piece chromed steel wand with handle	\$74
VLL003		Crevice tool	\$31
VZZ101		Round brush	\$31
VZZ091		Hard floor tool for wet/dry applications	\$238
VAD002		Accessory adaptor	\$15
<b>90mm Accessories</b>			
VK0101		Complete kit	\$469
VKT006		Super strength 3 metre synflex hose assy	\$486
VHH019		Heavy duty 90mm polysuction tube	\$111
VLL005		Poly suction spout (length 310mm)	\$57
<b>Paper Bags</b>			
V40048		Suits Whisper (5 pack)	\$37
V40096		Suits VY13F1 (5 pack)	\$40
V40064		Suits Dorsal (10 pack)	\$37
V44715		Suits VC44, VC61, VC62, VC73, VC83/3 (1 only -22 litre capacity)	\$20
VSF802		Suits VC44, VC61, VC72, VC73, VC83/3 (1 only -40 litre capacity)	\$29
<b>Filter Protectors</b>			
VSF065		Nylon filter protector, prevents filter clogging from fine dust, suits VC61/62, VC72/73/83, Drum vac	\$59

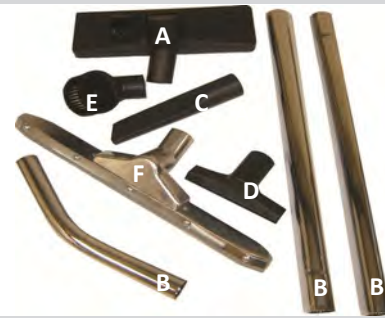

**Drain Kit**

VKT013	Drain kit, fits to any barrel vac to enable tank to be drained without lifting barrel	\$104
--------	---	-------



**Microweb Micro Filters (99.9% filtration) for a healthy clean**

VKF052	suits Clean Air VY13F1	\$125
VKF055	suits VC44	\$125
VKF056	suits VC61/62, VC72/73/83, Drum Vac	\$167

**Complete Heads**

VKE005	Suits VF13	\$258
VKE012	Suits VC44	\$316
VKE013	Suits VC61 (single motor option)	\$616
VKE014	Suits VC62, VC72 (two motor option)	\$646
VKE026	Suits VC72MX pump out vac (two motors)	\$665
VKE015	Suits VC73, VC83 (three motor option)	\$911



### Triplex Pump Trouble shooting guide - common to all pressure cleaners

Symptoms	Cause	Action	User check	Service Agent only
<b>No pressure</b>	No gun/lance assembly fitted	Fit gun/lance assembly	<input checked="" type="checkbox"/>	
	Unloader jammed	Replace unloader valve		<input checked="" type="checkbox"/>
	Worn unloader valve	Replace unloader valve		<input checked="" type="checkbox"/>
	Debris in pump valves	Wash out pump , flush manifold and install inlet water filter, clean valves		<input checked="" type="checkbox"/>
<b>Pump runs normally but pressure is low or drops</b>	Pump is sucking air	Check that hoses and fittings are tight	<input checked="" type="checkbox"/>	<input checked="" type="checkbox"/>
	Insufficient water supply	Check supply, clean or replace water filter if fitted	<input checked="" type="checkbox"/>	<input checked="" type="checkbox"/>
	Nozzle worn, missing or incorrect	Check size is correct, replace if worn	<input checked="" type="checkbox"/>	<input checked="" type="checkbox"/>
	Valves worn or dirty	Replace valves		<input checked="" type="checkbox"/>
	Unloader seat worn or damaged	Replace unloader valve		<input checked="" type="checkbox"/>
	Worn piston packing	Replace packing		<input checked="" type="checkbox"/>
	Relief valve jammed, plugged or improperly adjusted	Clean, adjust relief valve		<input checked="" type="checkbox"/>
	Cracked pistons caused by dry running	Replace pistons		<input checked="" type="checkbox"/>
<b>Pressure fluctuates</b>	Pump sucking air	Check that hoses and fittings are tight	<input checked="" type="checkbox"/>	<input checked="" type="checkbox"/>
	Valves are worn, dirty or stuck	Clean or replace valves		<input checked="" type="checkbox"/>
	Worn piston packings	Replace piston packings		<input checked="" type="checkbox"/>
<b>Back pressure in supply hose when on by-pass</b>	Low pressure valves dirty or worn	Clean or replace low pressure valves		<input checked="" type="checkbox"/>
<b>High pressure hose vibrates</b>	Insufficient water supply	Check supply, clean or replace water filter if fitted.	<input checked="" type="checkbox"/>	<input checked="" type="checkbox"/>
	Pump is sucking air from empty detergent tank	Refill the detergent tank	<input checked="" type="checkbox"/>	<input checked="" type="checkbox"/>
	Pump sucking air from hoses or fittings	Check that hoses and fittings are tight	<input checked="" type="checkbox"/>	<input checked="" type="checkbox"/>
	Air in water circuit	Check for leaks. Tighten all fittings. Disconnect high pressure hose and let machine run until water is flowing constantly without air	<input checked="" type="checkbox"/>	<input checked="" type="checkbox"/>
	Valves dirty or stuck	Clean or replace valves		<input checked="" type="checkbox"/>
<b>Machine is noisy</b>	Pump sucking air	Check hoses and fittings are tight	<input checked="" type="checkbox"/>	<input checked="" type="checkbox"/>
	Water too hot	Reduce temperature to below 60°C	<input checked="" type="checkbox"/>	<input checked="" type="checkbox"/>
	Valves worn, dirty or stuck	Clean or replace valves		<input checked="" type="checkbox"/>
	Worn bearings	Replace bearings		<input checked="" type="checkbox"/>
<b>Pump oil is milky (water in oil)</b>	Worn packings & oil seals	Replace packings & oil seals		<input checked="" type="checkbox"/>
	High humidity in air	Check and change oil more frequently		<input checked="" type="checkbox"/>
	Sand or dirt entering system	Check supply, use only clean water and fit water filter if required		<input checked="" type="checkbox"/>
<b>Water dripping from pump</b>	Safety valve activated due to pressure spike	Reset safety valve, if it keeps activating refurbish or replace unloader		<input checked="" type="checkbox"/>
	Thermal dump activated	Activated if water temperature exceeds 60°C. Should reset once water in pump cools. If not, replace		<input checked="" type="checkbox"/>
	Piston seals worn/damaged	Replace piston seals		<input checked="" type="checkbox"/>
	O-rings of piston guide or retainer worn	Replace o-rings		<input checked="" type="checkbox"/>
<b>Oil leak</b>	Travel plug in use on pump	Replace with breather plug	<input checked="" type="checkbox"/>	<input checked="" type="checkbox"/>
	Loose drain plug	Check drain plug fitted correctly	<input checked="" type="checkbox"/>	<input checked="" type="checkbox"/>
	Worn oil seals	Replace oil seals		<input checked="" type="checkbox"/>
	Oil level too high	Drain excess oil		<input checked="" type="checkbox"/>
<b>Unloader 'knocking' in use</b>	Water nozzle partially blocked	Clean water nozzle	<input checked="" type="checkbox"/>	<input checked="" type="checkbox"/>
	Water filter dirty	Clean water filter	<input checked="" type="checkbox"/>	<input checked="" type="checkbox"/>
<b>Unloader valve is 'knocking' when gun is closed</b>	Gun is leaking	Clean inside gun removing any deposits or build-up		<input checked="" type="checkbox"/>
	Air in water circuit	Check for leaks. Tighten all fittings. Disconnect high pressure hose and let machine run until water is flowing constantly without air	<input checked="" type="checkbox"/>	<input checked="" type="checkbox"/>
	Damaged high pressure hose	Check and replace	<input checked="" type="checkbox"/>	<input checked="" type="checkbox"/>
	Faulty unloader valve	Replace unloader valve		<input checked="" type="checkbox"/>
<b>No detergent supplied</b>	Lance not set to low pressure	Adjust lance or fit detergent nozzle	<input checked="" type="checkbox"/>	
	Empty detergent tank	Refill detergent tank	<input checked="" type="checkbox"/>	
	Detergent valve stuck	Clean or replace		<input checked="" type="checkbox"/>
	Intake hose and/or filter dirty	Check and clean	<input checked="" type="checkbox"/>	<input checked="" type="checkbox"/>
<b>Pressure gauge shows high pressure fluctuations when shutting off gun</b>	Unloader valve set too high above operating pressure	Adjust the unloader at the operating pressure		<input checked="" type="checkbox"/>
	Dirty valve	Clean unloader valve (removing lime deposits etc). Grease parts before installing		<input checked="" type="checkbox"/>
<b>Leaky unloader at nominal pressure</b>	Nozzle too small	Check nozzle size correct		<input checked="" type="checkbox"/>
	Worn out unloader valve	Replace unloader valve		<input checked="" type="checkbox"/>

This guide is for trained technicians ... contact your Aussie service centre for assistance.

Symptoms	Cause	Action	User check	Service Agent only
----------	-------	--------	------------	--------------------

### Electric drive pressure cleaners

<b>Machine does not start</b>	Power not connected	Check plug, cable and switch	<input checked="" type="checkbox"/>	
	Wrong voltage	Check mains voltage	<input checked="" type="checkbox"/>	
	Power cable damaged	Replace cable		<input checked="" type="checkbox"/>
<b>Motor hums but does not run</b>	Voltage supply is too low	Check power supply for correct voltage	<input checked="" type="checkbox"/>	
	Pump is stuck	Manually turn motor		<input checked="" type="checkbox"/>
	Spray gun not activated	Activate spray gun when switching on	<input checked="" type="checkbox"/>	
	Cross section of extension lead too small	Use correct dimension extension lead	<input checked="" type="checkbox"/>	
<b>Motor stops suddenly</b>	Cut out switch activated due to overheating	Check power supply is correct. Disconnect machine and allow to cool off for a few minutes.	<input checked="" type="checkbox"/>	
<b>Motor trips out</b>	Unit run on excessive extension lead	Remove lead	<input checked="" type="checkbox"/>	
	Power lead or plug damaged	Fix or replace		<input checked="" type="checkbox"/>
	Excessive pressure build up	Check pressure, nozzle size, unloader setting		<input checked="" type="checkbox"/>
	Motor down to earth e.g. water ingress	Electrician to test, fix or replace		<input checked="" type="checkbox"/>
	Suction amperage cut-out set too low	Reset to correct setting		<input checked="" type="checkbox"/>

### Engine drive pressure cleaners .... For further assistance with engine trouble shooting consult the manufacturers handbook

<b>Machine does not start</b>	Battery dead	Recharge or replace battery		<input checked="" type="checkbox"/>
	Battery cables disconnected	Clean connections and reconnect cables		<input checked="" type="checkbox"/>
	Engine, pump or gearbox is seized	Replace or repair seized part		<input checked="" type="checkbox"/>
	Low oil shutdown is activated	Add oil to engine, consult user guide		<input checked="" type="checkbox"/>
	Low on fuel	Add fuel		<input checked="" type="checkbox"/>
<b>Revs dip under load, when gun trigger is pressed</b>	Engine needs service	Consult engine service centre		<input checked="" type="checkbox"/>

### Hot water & Steam cleaners

<b>Burner is smoking</b>	Water in the fuel tank	Empty fuel tank, clean and refill with clean fuel		<input checked="" type="checkbox"/>
	Fuel pressure incorrect	Adjust fuel pressure		<input checked="" type="checkbox"/>
	Air throttle adjusted incorrectly	Adjust air intake on fan		<input checked="" type="checkbox"/>
	Electrodes positioned incorrectly	Clean, adjust or replace as required		<input checked="" type="checkbox"/>
	Fuel nozzle dirty	Clean fuel nozzle		<input checked="" type="checkbox"/>
	Fuel nozzle worn or damaged	Change fuel nozzle		<input checked="" type="checkbox"/>
	Heating coil blocked by soot	Remove & clean heating coil		<input checked="" type="checkbox"/>
	Fuel pump dirty	Replace fuel pump		<input checked="" type="checkbox"/>
Fuel solenoid valve not working	Replace fuel solenoid		<input checked="" type="checkbox"/>	
<b>Burner will not fire</b>	Burner switch not on	Turn switch on burner	<input checked="" type="checkbox"/>	
	Diesel fuel level low	Add diesel	<input checked="" type="checkbox"/>	
	Trigger on spray gun not pulled	Squeeze trigger to fire burner	<input checked="" type="checkbox"/>	
	Fuel filter blocked	Clean and replace if necessary		<input checked="" type="checkbox"/>
	Overload on burner motor tripped	Consult service manual		<input checked="" type="checkbox"/>
	Low water pump pressure	Trouble shoot pump (see page 105)		<input checked="" type="checkbox"/>
	Fuel blockage	Check fuel system for flow, clear blockage		<input checked="" type="checkbox"/>
	Electrode gap incorrect	Reset		<input checked="" type="checkbox"/>
No power to electrodes	Trace power & replace faulty parts		<input checked="" type="checkbox"/>	
<b>Burner cuts out during operation</b>	Fuel tank is empty (burner will produce white smoke)	Refill the fuel tank	<input checked="" type="checkbox"/>	
	Suction filter is dirty	Remove filter and clean using fuel and a brush		<input checked="" type="checkbox"/>
	Water in fuel	Empty fuel tank, clean and refill with clean fuel		<input checked="" type="checkbox"/>
	Pressure switch not functioning	Replace pressure switch		<input checked="" type="checkbox"/>
	Ignition transformer faulty	Replace transformer		<input checked="" type="checkbox"/>
	Rotation of electrodes	Adjust electrodes		<input checked="" type="checkbox"/>
	Fuel nozzle is dirty	Clean fuel nozzle		<input checked="" type="checkbox"/>
	Fuel nozzle is worn Fuel pump is faulty	Replace fuel pump		<input checked="" type="checkbox"/>
	Fuel solenoid valve not working	Replace solenoid valve		<input checked="" type="checkbox"/>
Fuse burnt out	Check & replace		<input checked="" type="checkbox"/>	
<b>Water does not reach working temperature</b>	Thermostat adjusted too low	Adjust thermostat	<input checked="" type="checkbox"/>	
	Thermostat is faulty	Replace thermostat		<input checked="" type="checkbox"/>
	Scale build up in water circuit	De-scale inside of coil		<input checked="" type="checkbox"/>
	Burner sooted	Remove & clean outside of coil & inside of cove		<input checked="" type="checkbox"/>

This guide is for trained technicians ... contact your Aussie service centre for assistance.

Aussie Pump's general terms of sale represent a statement of contracts to supply equipment between Australian Pump Industries Pty Ltd and its customers.

### Prices

- Prices printed in the Aussie Pumps price list are current at date of issue and are subject to change without notice. Prices charged will be those ruling at the date of delivery.
- All retail prices quoted are recommendations only. There is no obligation to comply with these recommendations.
- The validity of any quote given by Aussie Pumps will be 30 calendar days unless stated otherwise in the quotation. We reserve the right to withdraw quotations in writing before the end of the validity period.
- In line with industry standards, minimum order value of \$50<sup>+GST</sup> applies to all customer orders.

### Special Construction Products

- Pressure cleaners or any other product, not listed as a standard product in the price list may be manufactured by Aussie Pumps against specific customer order and specification. These units are not eligible for return under the stock swap program.
- It is the purchaser's responsibility to satisfy itself of the suitability of any special order products being built by Aussie Pumps for the buyer's purpose based on the information provided by Aussie Pumps in its quotation.
- Special orders as described above are irrevocable and not subject to cancellation or deferment.
- Warranties applicable to special order products as described above are the same as that which applies to all standard Aussie Pumps product, other than for those items supplied to Aussie Pumps by third parties for which Aussie Pumps will assign the original supplier's warranty to the buyer of the "special order product".

### Goods Returned Policy

- Return of goods for credit will not be accepted without our prior written approval. There is no obligation on the part of Australian Pump to accept goods returned for credit without prior approval. Return authority label must be attached to outside of box. Return is conditional upon the products being returned;
  - Freight prepaid in unused condition and in original packaging. Obsolete products are not eligible for return.
  - Products returned for credit must be unsoiled, undamaged, in resalable condition and not more than 12 months old.
  - All returned products must be accompanied by a copy of the original delivery docket.
  - A written statement including the original invoice number, the date of purchase and full reasons for the return.
- Credit value of the goods returned will be at the absolute discretion of Aussie Pumps and will be limited to the original amount invoiced for that product. A restocking charge, the amount of which shall be at the absolute discretion of Aussie Pumps but will be not less than 25% of the original price of the product, will be applied to cover restock, repackaging, documentation and administration charges.

### Incorrectly Supplied, Missing or Damaged Goods

- Aussie Pumps must be notified, in writing, within three (3) working days of delivery of any goods incorrectly supplied so that prompt replacement with the correct products can be arranged.
- All deliveries should be inspected for missing or damaged goods before the buyer signs for the goods. Missing or damaged goods should be noted on the consignment note. Any claims for missing goods or for products supplied in damaged condition must be reported to Aussie Pumps, in writing, within three (3) working days for the claim to be considered. N.B. Our terms are ex works. Claims

for damage in transit will not be considered.

### Warranty

- All Aussie Pumps products are guaranteed to be free from faulty workmanship or material as detailed in the warranty card supplied with each product and as detailed in the operator's manual that is supplied with the goods.
- All engine warranty** claims should be made directly to the service agent for the engine manufacturer and warranty is subject to their terms & conditions.
- Federal battery warranty** is covered by Ryde Batteries, 1300 133 980. Call to find their nearest nominated agent.
- Repairs carried out** by Aussie Pumps Service Division on products outside the guarantee period are guaranteed to be free of faulty workmanship or material for a period of three (3) months after the repair.
- Warranty** is deemed to apply to failures due to faulty workmanship or materials and does not apply to fair wear and tear, improper installation or application, the user's failure to carry out maintenance, or as a result of the product's use for purposes for which it was not designed.
- Aussie Pumps is not liable for any loss of profit or consequential or indirect special loss arising from defects in any of its products.
- Aussie Pumps will not be liable for damage or injury of any kind whatsoever arising directly or indirectly from product defects.
- Aussie Pumps' liability under the terms of the company's guarantee or warranty is limited to any one of the following:
  - replacement of the product with a suitable equivalent
  - repair of the product
  - return of the product for refund of purchase price
  - payment for the cost of having the product repaired
  - supply of replacement services
  - payment of the cost of having services supplied again
- Aussie Pumps reserves the right to choose the lowest cost option of the above.

N.B. All prices are ex works Castle Hill warehouse. If purchaser chooses to use our carrier insurance is purchaser's responsibility. We do offer freight insurance at 2% of the value of the goods shipped.

**DEMONSTRATION/FIELD DAY STOCK** - In the event that goods are loaned to a customer for demonstration or display, the customer is responsible for return of the goods in BRAND NEW CONDITION. Any parts, labour or packaging required to put the loaned items back into brand new condition will be charged to the customer at normal rates.

N.B. The customer is deemed to be the person / customer to whom Australian Pump Industries loans the goods.

Due to our program of continuous product development Australian Pump reserves the right to alter specifications without notice.

### Note:

Our goods come with guarantees that cannot be excluded under the Australian Consumer Law. You are entitled to a replacement or refund for a major failure and for compensation for any other reasonably foreseeable loss or damage. You are also entitled to have the goods repaired or replaced if the goods fail to be of acceptable quality and the failure does not amount to a major failure.

The benefits under the Aussie Pump warranty are in addition to other rights under Australian Consumer Law.

# Aussie Pumps

More than just pressure cleaners



## Reliable Products ... Reliable People

### Australian Pump Industries Pty Ltd

7 Gladstone Road, Castle Hill NSW 2154

Ph: (02) 8865 3500 Fax: (02) 9894 4240

[aussiepumps.com.au](http://aussiepumps.com.au) | [info@aussiepumps.com.au](mailto:info@aussiepumps.com.au)

All prices exclude GST & are recommended prices only. Freight, insurance, pre delivery & installation costs are excluded. Prices effective from 1/07/2021 but are subject to change without notice. All items have been included in good faith based on our knowledge or product availability at the time of publication. Australian Pump reserves the right to change specifications & prices without notice.

API\_BB6/0721/1



Quality  
ISO 9001

SAI GLOBAL

Distributed by

