

PIPEGEN AI

BY TASK FAILED SUCCESSFULLY

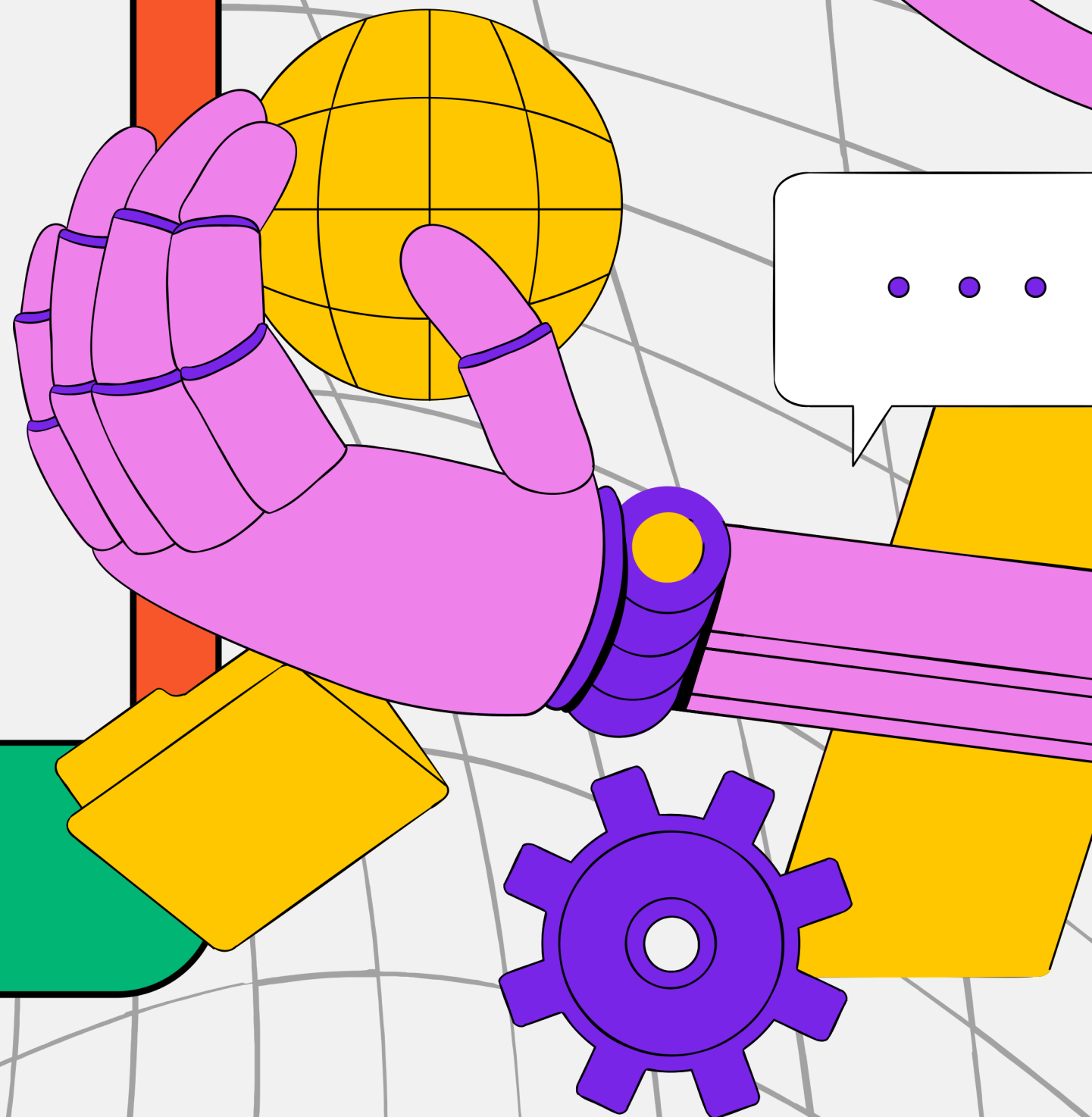

TABLE OF CONTENTS



01

**Solution
Development**

02

Our Design Process

03

Our Approach

PROBLEM STATEMENT

BUILDING RAG MODELS IS DIFFICULT AND
USUALLY REQUIRES KNOWLEDGE ABOUT
TOOLS ALONG WITH ADVANCED
PROGRAMMING ABILITIES

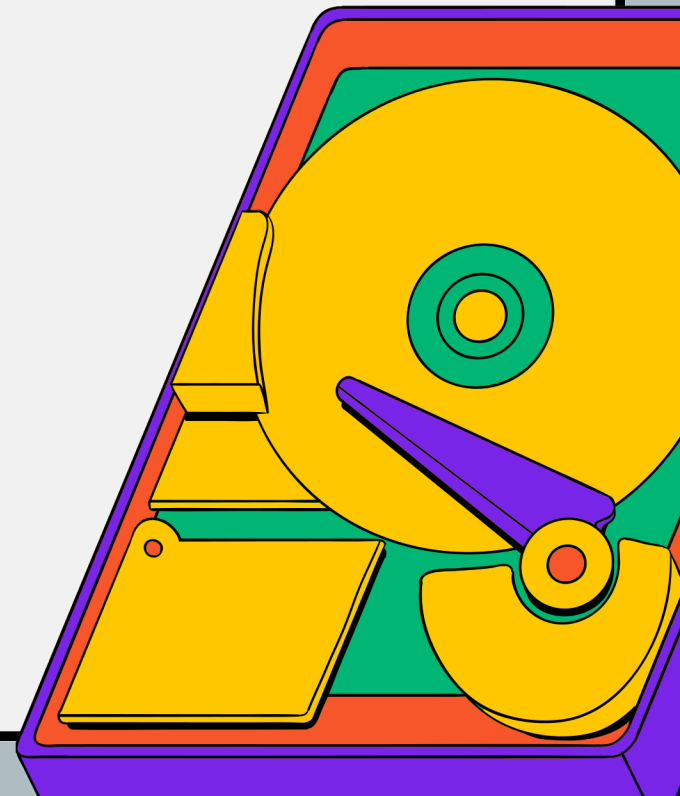

OUR SOLUTION

Our solution, Pipegen, simplifies this process by offering a no-code platform equipped with an intuitive creation wizard. This platform allows users to easily generate RAG pipelines and create custom models, which can be fine-tuned and utilized with RAG.

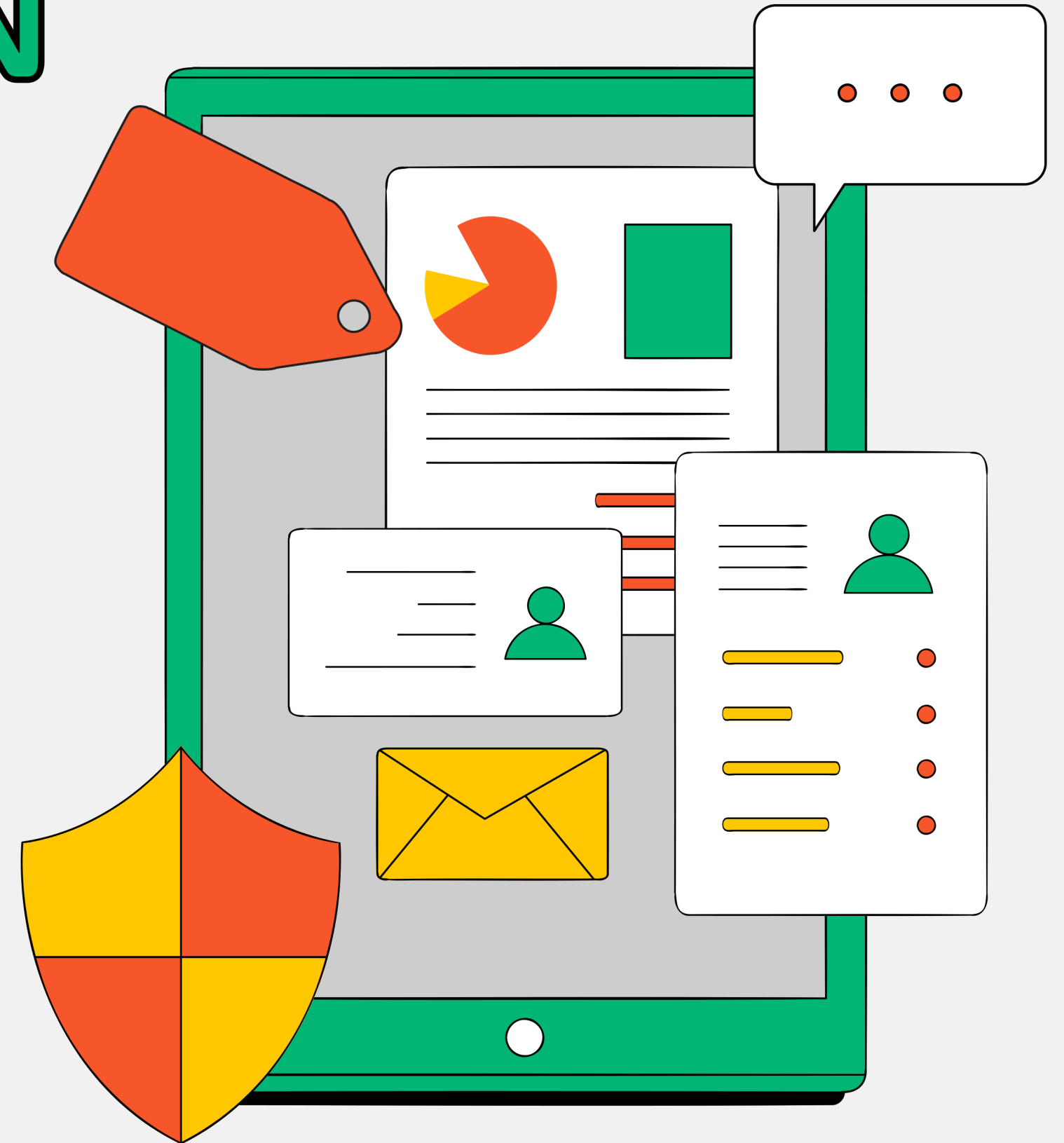

KEY SERVICES

CREATION
WIZARD

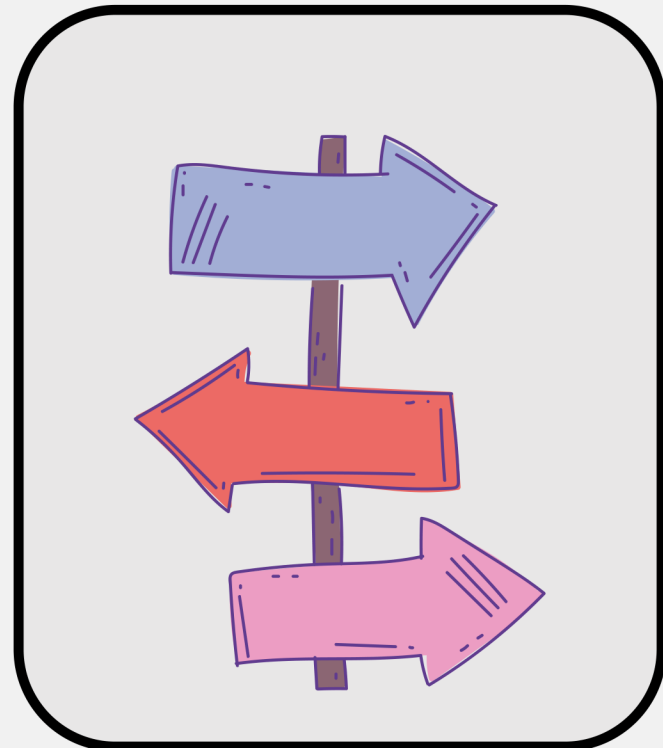

RAG
CAPABILITIES

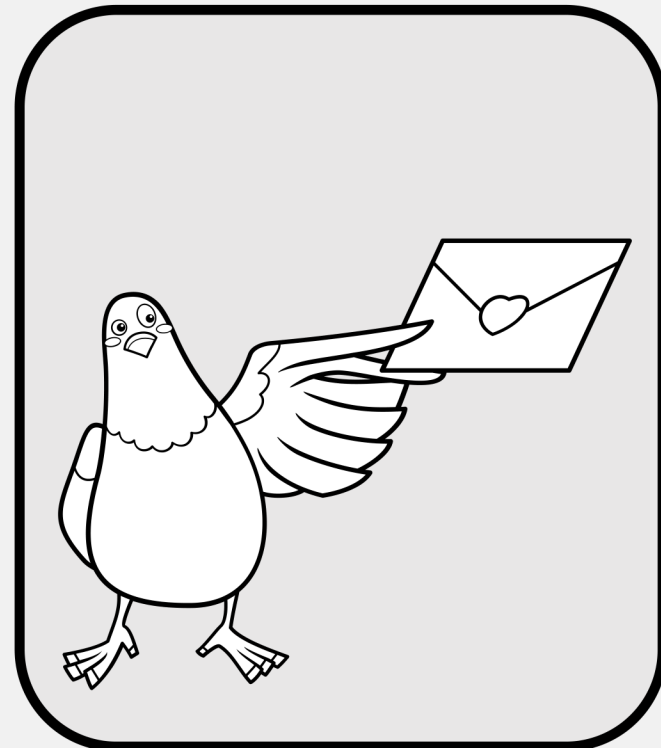

CUSTOM
MODELS

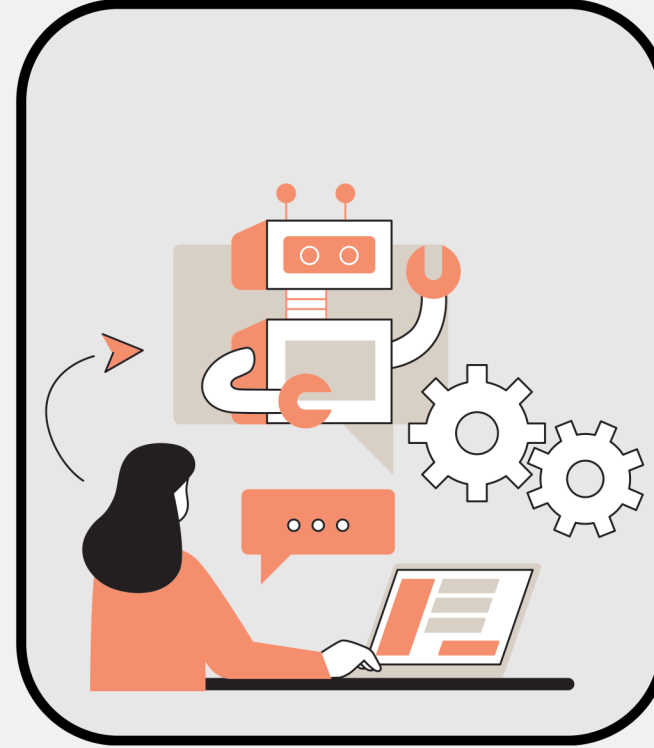

DYNAMIC
MODELS



BUILT IN
GUI USE

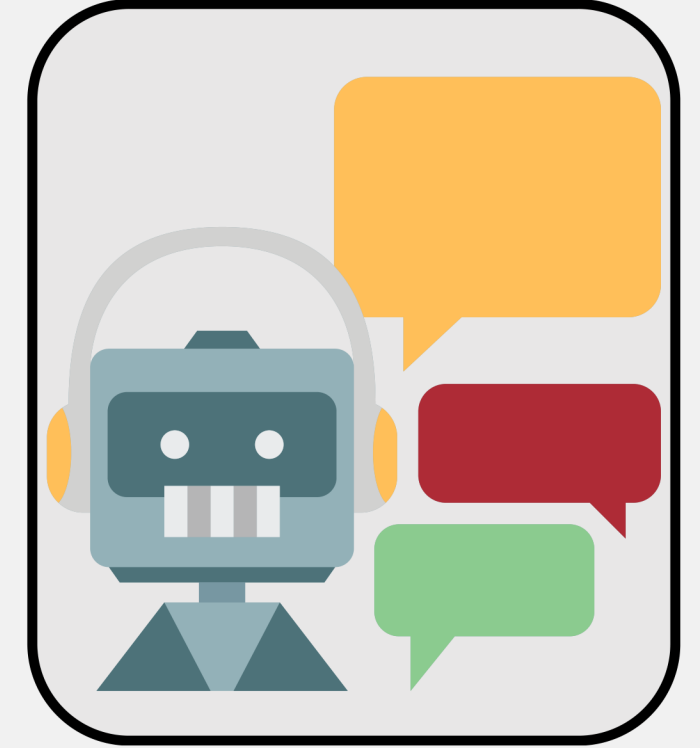

BACKEND STACK

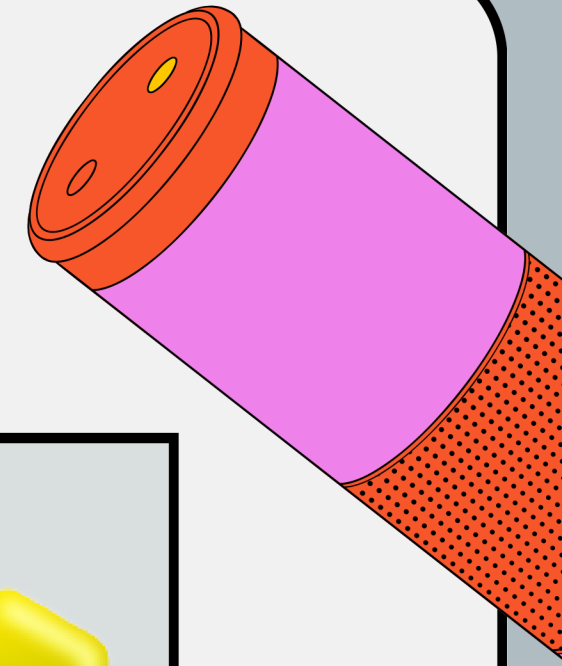

Cohere

Used as a base for all the models in the pipeline

Weaviate

Used as the default vector database

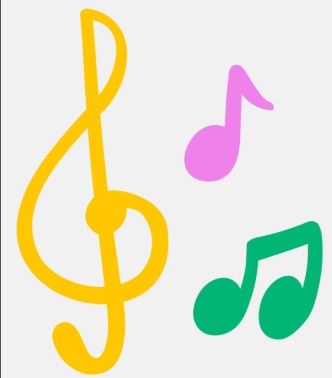
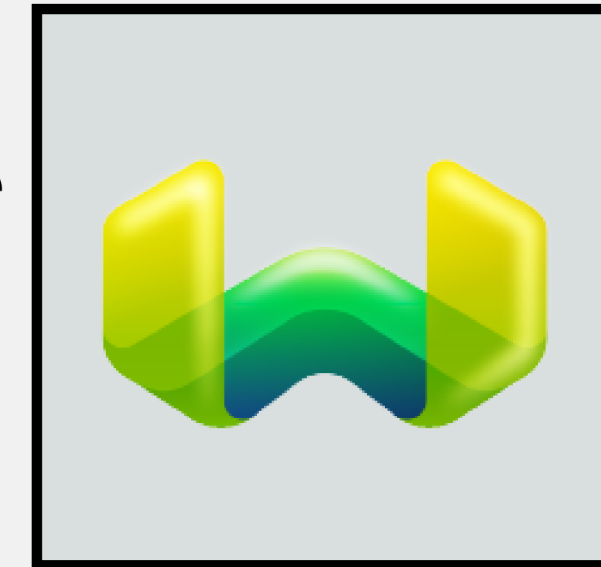

Flask

Used to create our REST API responsible for handling requests

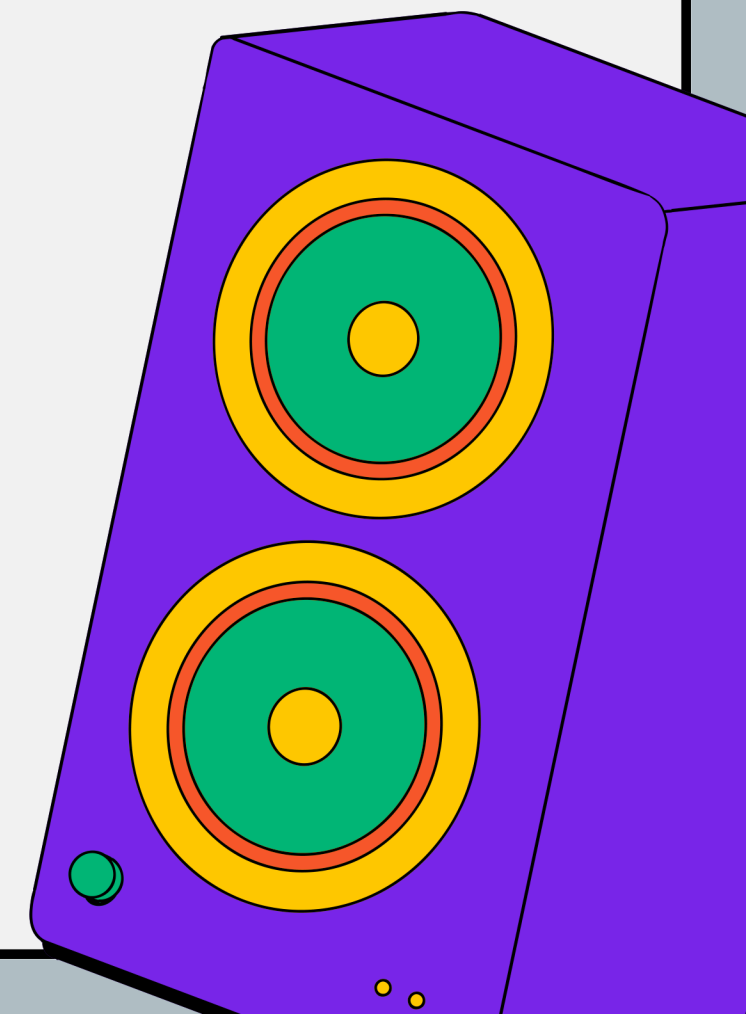
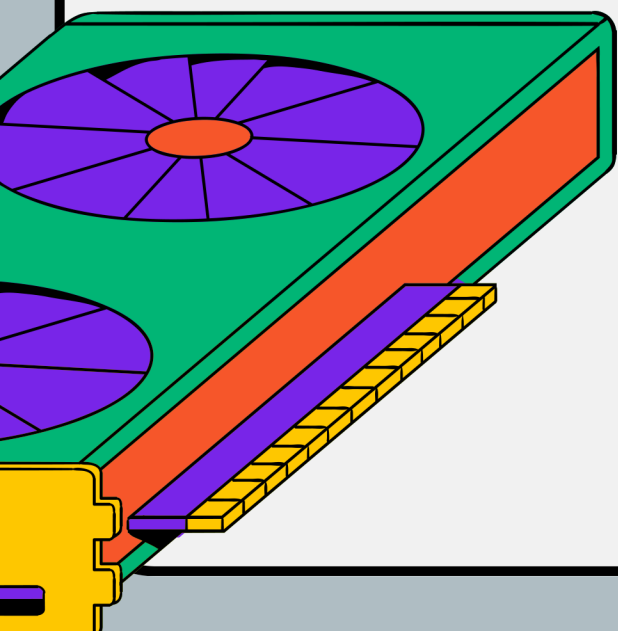
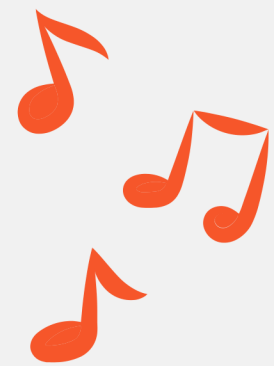

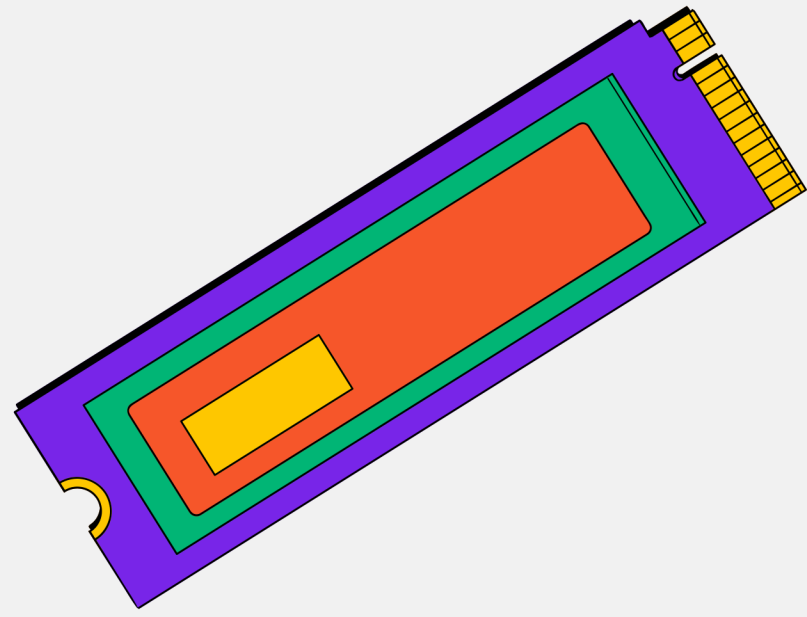

PRICING PLANS

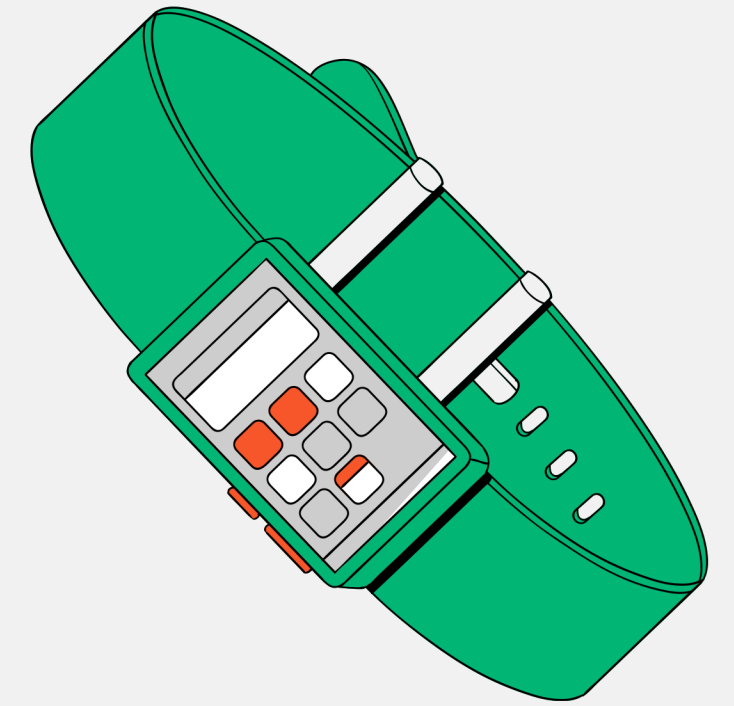

Pipeline Creation

RAG

Custom Models

FREE



PLUS



PREMIUM



PRICE

\$Free

\$13.00

\$10.50



DEMO