

Food Safety Booklet

Complete compilation of applications for food analysis



Click on the icons to navigate



Overview

Food and agricultural industries play a major role in safeguarding global food security, through advanced scientific research and technological developments. Due to these developments, issues such as GMO validation, food authenticity and food contaminants are a major concern in the industry. To ensure public health and address food safety quality and traceability issues, food compositional analysis, regulations and good practices have been established.

However, food analysis is often complicated due to the variation of the food matrices and the diverse groups of contaminants (pesticides, drugs, toxins, etc.), which differs from one another in chemical and biological properties. With the increasingly stringent and rigorous requirements in food safety standards and regulations, food industries and regulators require trace-level detection and quantification of compounds in food. Hence, there is an increasing demand for more sophisticated instruments that give higher sensitivity, precision, speed and ease of implementation.

Shimadzu is a leading analytical instrument manufacturer that provides a complete solution and supports your food safety analysis with a wide range of analytical instruments and food-related applications. These applications are incorporated with our unique UFMS technologies and advanced techniques which increases confidence in your analyses. This food safety booklet compiles and offers all necessary information for global food manufacturing industries, food safety regulators and testing laboratories.

Identification and quality of food authenticity

Identification and quantification of chemical and biochemical food contaminants



Determination of changes in genetically modified foods

Safety, quality and traceability of global food

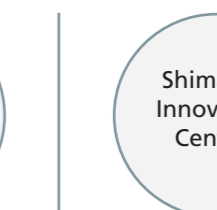
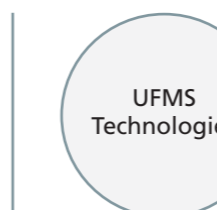

HARDWARE SOLUTIONS

ROBUST & RELIABLE INSTRUMENTS FOR ALL ANALYSES

MASS SPECTROMETERS

PERFORM ANALYSIS WITH UNPARALLELED THROUGHPUT

- Equipped with Shimadzu's UFMSTM patented technology
- Increase specificity using the Library Screening MRM Spectrum mode
- Reduce instrument maintenance with excellent robustness
- Versatile configurations to fit your specific analysis
- Suitable for various agricultural and food contaminants analyses

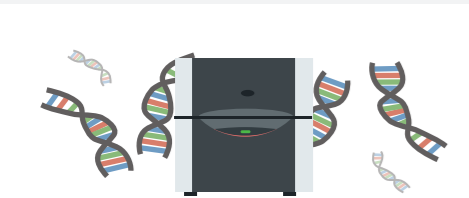
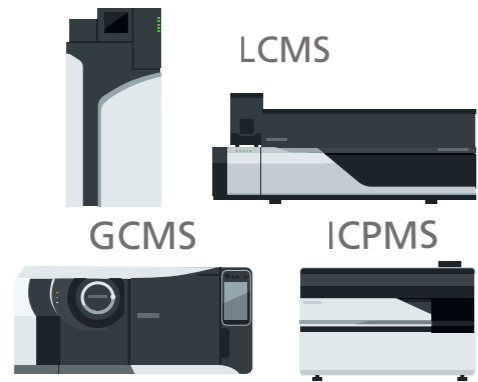

MultINA Microchip Electrophoresis System

- Automated microfluidic device
- Wide range of amplicon detection (food allergens, pathogens, etc.)
- Higher sample throughput compared to conventional gel electrophoresis
- Compatible with 96-well PCR plates

CHROMATOGRAPHS

LIQUID CHROMATOGRAPHS
SIMPLIFY YOUR STARTUP

- Quick method setup for your specific applications
- Reduce method development cost



GAS CHROMATOGRAPHS
FLEXIBLE CONFIGURATION

- [Carrier gas save] mode reduces operation costs
- Tool-free routine maintenance



NEXERA UC
SUPERCRITICAL FLUID BASED TECHNOLOGY

- Suitable for both polar and non-polar samples
- Fully automated online sample preparation and analysis

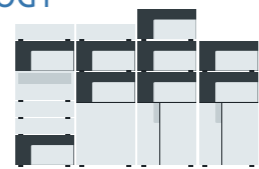

SPECTROSCOPIES

- Routine toxic metal and foreign substance analysis

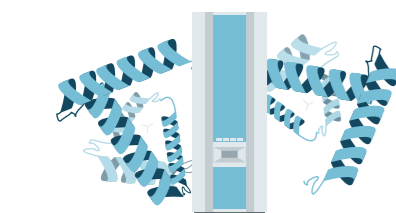
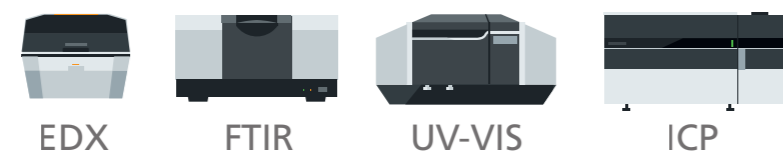

AXIMA Series MALDI-TOF MS

- Bacterial characterization with high discriminatory capacity
- Automated microbial identification with high accuracy

ANALYTICAL BALANCES

SHORT RESPONSE TIME

- Accurate trace measurement with UniBloc Technology

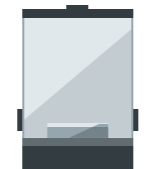

EXTENSIVE SOLUTIONS TO ENHANCE YOUR FOOD TESTING LAB ANALYSIS AND DATA INTEGRITY

Understand
your solutions

Identify your
challenges

Analytical Network Data System
LabSolutions



Connectivity

↑ Increase
Productivity
Accuracy
Robustness

1 Method Development

Tedious method development resulting in wasted resources and time

2 Data Processing

Inefficient data processing causing massive accumulation of unprocessed data

3 Data Security

Lack of effective data management system causing higher risk of data security and integrity

SOFTWARE SOLUTIONS

SIMPLE WORKFLOW

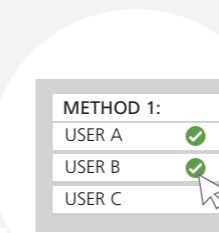

Fast & easy analysis setup
Easy-to-use databases, method package and user access configuration

High throughput, swift and accurate analysis
Enabled with Shimadzu's UFMSTM technologies

Oversee your analysis with ease
Monitor instruments' operation status via multiple workstations and devices



Different brand? No problem!
LabSolutions DB/CS can also control instruments from other vendors

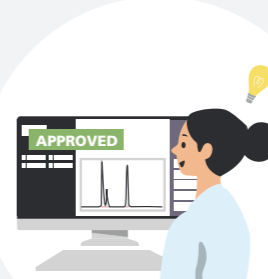

Reduce time spent on data processing
Peak integration algorithm resolves problematic analyses

Go paperless, go green
Sign off with electronic signatures, no more manual transcriptions

Report sets without a hitch
All data and reports summarized in a single PDF
Create multi-data reports to combine data from various instruments



No tampering of results
Overwriting and editing is disabled
Post-run analysis automatically assigned with data revision numbers

Automatic and secure data backup

Centralised data storage



POST-SALES SOLUTIONS

LAB SERVICES



Compliance Services



Laboratory Asset Management



Total Lab Relocation



Product Warranty



Application Support



LabTotal Vial



Super-Clean Gas Filters



Shim-pack HPLC Columns

[← Return to main page](#)

Find the application that suits your needs



Hot Topics



Dairy Products



Grains & Edible Oil



Fertilizers



Meat & Seafood



Vegetables, Fruits & Spices



Others

Click to navigate	GC	GC-MS	LC	LC-MS	ICP ICP-MS	FTIR / FTIR Imaging / EDX	MALDI TOF-MS	Microchip Electrophoresis (DNA/RNA)	UV-VIS	TOC
Hot Topics		Dioxins Mineral Oil Residues Mineral Oil Residues		Allergens Allergens Fipronil Aminoglycosides Fipronil				Allergens		
Pesticides										
Veterinary Drugs										
Mycotoxin & Biotoxins										
Food Additives										
Heavy Metals										
Foreign Substances										
Halal Authentication										
Microbial Identification										
Food Adulteration										
GMOs										
Carbon Dioxide										
Other Analyses		PCB MCPD POPS	Melamine Nitrous Acid	Melamine Synthetic Dyes Antibiotics					Olive Oil Classification	

[← Return to main page](#)

Hot Topics



1. Sensitive and Fast Measurement of Aminoglycoside Antibiotics in Milk, Meat or Eggs by HILIC-MS/MS and Identification using MRM Spectrum Mode
2. Determination of Polychlorinated Dibenzo-p-dioxins and Dibenzofurans (PCDD/Fs) in Foodstuffs and Animal Feed Using a Triple Quadrupole GCMS-TQ8040 System with Smart MRM Transforms Laboratory Analysis
3. Analysis of Dioxins in Feed and Food Using GC-MS/MS as Confirmatory Method in Complying with EU Regulation
4. Sensitive Method for the Determination of Fipronil in Egg using UHPLC-MS/MS [LCMS-8060]
5. Detection of Allergenic Substances Using MCE-202 MultiNA Microchip Electrophoresis System
6. High Sensitivity Analysis of Peanut Allergen in Cumin and Spice Mix [LCMS-8060]
7. Simultaneous Analysis of Major Allergens in Food Matrices by High Sensitive Mass Spectrometer
8. Sensitive Method for the Determination of Fipronil and its Metabolite Fipronil Sulfone in Egg using QuEChERS Sample Pretreatment and LC-MS/MS Detection [LCMS-8060]
9. Ultra-Sensitive and Rapid Assay of Neonicotinoids, Fipronil and Some Metabolites in Honey by UHPLC-MS/MS [LCMS-8060]
10. Determination of MOSH Contamination in Baby Foods by Using LC-GC and LC-GC×GC-MS
11. Mineral Oil Residues in Food Part 1- Dry Food (Flour, Noodles and Rice)

Sensitive and Fast Measurement of Aminoglycoside Antibiotics in Milk, Meat or Eggs by HILIC-MS/MS and Identification using MRM Spectrum Mode

ASMS 2017 TP-184

Mikaël LEVI¹, Hisashi KATO², David BAKER³, Ichiro HIRANO¹
1 SHIMADZU Corporation, MS Business Unit, Kyoto, Japan;
2 BIOTAGE Japan, Tokyo, Japan; 3 SHIMADZU MS Business
Unit Overseas, Manchester, UK.

Sensitive and Fast Measurement of Aminoglycoside Antibiotics in Milk, Meat or Eggs by HILIC-MS/MS and Identification using MRM Spectrum Mode

Introduction

Aminoglycoside are an antibiotic family widely used for the treatment of bacterial infections in cattle, sheep, pigs and poultry. Due to their high affinity for tissues, the consumption of meat, milk or eggs containing aminoglycosides (AGs) can be potentially hazardous for human health. Regulatory agencies have set maximum residue limits (MRL) for these compounds with veterinary use. Depending on the countries, the animal species, the commodity or the AG, these MRL are different. For food safety laboratories testing large numbers of samples, a method capable to cover as many compounds, matrices and regulated range as possible would be of great help. In addition, some AGs are strictly banned for some

commodities (e.g. spectinomycin in eggs) or have low MRL. So in the case of a positive sample, a strict identification of the compound is necessary to confidently report potential fraud.

AGs are very polar compounds poorly retained by reversed-phase liquid chromatography and ion-pairing reagents are not desirable when users share several methods on a single system.

Here we present a method using hydrophilic interaction liquid chromatography (HILIC) with high sensitivity mass spectrometer to reach limits of quantification at femtogram level on column, combined with MRM Spectrum Mode for formal identification.

Methods and Materials

Sample Preparation

Frozen meat samples were homogenized using a knife mill (Grindomix GM200, Retsch). 5 g of homogenized sample or mixed eggs or 10 mL of milk were placed in a polypropylene tube. After addition of 20 mL of extraction solution (10 mM NH₄OAc, 0.4mM EDTA, 0.5% NaCl, 2% trichloroacetic acid in water), sample were vortex mixed and shaken for 10 min. After centrifugation for 10 min at 4000 rpm, the supernatant was transferred to a clean PP tube. Extraction was repeated and supernatant combined. Extract pH was then adjusted to pH 6.5 +/- 0.25.

Further purification was then performed by Solid Phase Extraction (SPE) using mixed-mode sorbent (WCX Express 96-well plate 30 mg, Biotage) and Extrahera automate (Biotage). 1 mL of extract was loaded without prior conditioning. Then the sample was washed with 1 mL of ammonium acetate buffer 50mM pH7. After sorbent drying, target compounds were eluted with 250 µL of aqueous formic acid 10% (v/v). Purified extracts were then diluted 25 times with aqueous formic acid 1% (v/v) prior to transfer into a polypropylene vial and analysis.

Analytical Conditions

Two methods were used. First method for fast quantitative screening is using a fast gradient with two MRM by compound. The second method for positive sample confirmation, used same mobile phases and

column but with a longer gradient and 15 MRM per compound. Parameters are described parameters in Table 1 and 2.

Sensitive and Fast Measurement of Aminoglycoside Antibiotics in Milk, Meat or Eggs by HILIC-MS/MS and Identification using MRM Spectrum Mode

Table 1 HILiC conditions

System	: Nexera X2
Column	: GL Sciences Inertsil Amide 3µm 100x2.1mm
Temperature	: 50°C
Mobile Phases	: A: Water + 250 mM ammonium formate + 1% formic acid B: Acetonitrile
Flow Rate	: 800 µL/min
Injection Volume (Quant screening)	: 5 µL
Gradient	: 80 % B (0.1min) to 30%B in 1 min. 30%B (0.5 min). 30%B to 80%B in 0.1 min
Total Run Time (ID Confirmation)	: 3.5 min
Gradient	: 70 % B (0.1min) to 60%B in 6 min. 60%B to 50 (3min). 50%B to 70%B in 0.1 min
Total Run Time	: 11 min

Table 2 MS/MS conditions for fast quantitative screening

System	: LCMS-8060		
Ionization	: Heated ESI		
Probe Voltage	: +1.5 kV (positive ionization)		
Temperature	: Interface: 400°C Desolvation Line: 150°C Heater Block: 300°C		
Gas Flow	: Nebulizing Gas: 3 L/min Heating Gas: 20 L/Min Drying Gas: 3 L/min		
Dwell Time / Pause time	: 6 ms / 1.5 ms		
MRM	Compound	MRM Quant	MRM Qual
	Spectinomycin	351.1 > 207.0	351.1 > 98.2
	Apramycin	540.3 > 217.1	540.3 > 378.3
	Dihydrostreptomycin	584.3 > 263.2	584.3 > 246.0
	Gentamicin C1a	450.2 > 322.2	450.2 > 163.0
	Gentamicin C1	478.3 > 322.3	478.3 > 157.1
	Gentamicin C2	464.3 > 322.1	464.3 > 160.0
	Hygromycin B	528.3 > 177.1	528.3 > 352.1
	Kanamycin	485.3 > 163.0	485.3 > 324.2
	Neomycin B	615.3 > 161.1	615.3 > 163.1
	Streptomycin	582.3 > 263.2	582.3 > 246.12
	Amikacin	586.3 > 425.2	586.3 > 163.3
	Netilmicin	476.3 > 299.2	476.3 > 191.2
	Paromomycin	616.3 > 163.1	616.3 > 293.2
	Sisomicin	448.3 > 254.1	448.3 > 271.2
	Tobramycin	468.3 > 324.0	468.3 > 163.0

Sensitive and Fast Measurement of Aminoglycoside Antibiotics in Milk, Meat or Eggs by HILIC-MS/MS and Identification using MRM Spectrum Mode

Results

Calibration

As the method should fit any type of sample, calibration standards were prepared in aqueous 1% formic acid. The calibration range was set up by combining all MRL from Europe, Japan and USA for all target compounds and all commodities. For each compound, the lowest MRL divided by 10, or the practical achievable concentration with $S/N > 10$ was considered as the target limit of quantification. The highest MRL +50% was used to

define the highest calibration level. When no MRL was defined, the Japan rule using 10 ng/g as default MRL was employed for the highest level. Finally, taking into account the sample preparation protocol, volumetric concentration were established. The table 3 summarize the calibration ranges used. Some typical chromatograms at LOQ are provided in figure 1.

Table 3 Calibration ranges

Compound	Calibration range (pg/mL)	
	lowest (Low MRL/10)	highest (high MRL + 50%)
Amikacin	20	150
Apramycin	30	30000
Dihydrostreptomycin	5	30000
Gentamicin(*)	80	75000
Hygromycin	10	150
Kanamycin	20	37500
Neomycin (+)	100	150000
Netilmicin	10	150
Paromomycin	40	22500
Sisomycin	10	150
Spectinomycin	10	75000
Streptomycin	5	30000
Tobramycin	10	150

(*) sum of C1, C1a and C2 congeners

(+) using Neomycin B as marker

Sensitive and Fast Measurement of Aminoglycoside Antibiotics in Milk, Meat or Eggs by HILIC-MS/MS and Identification using MRM Spectrum Mode

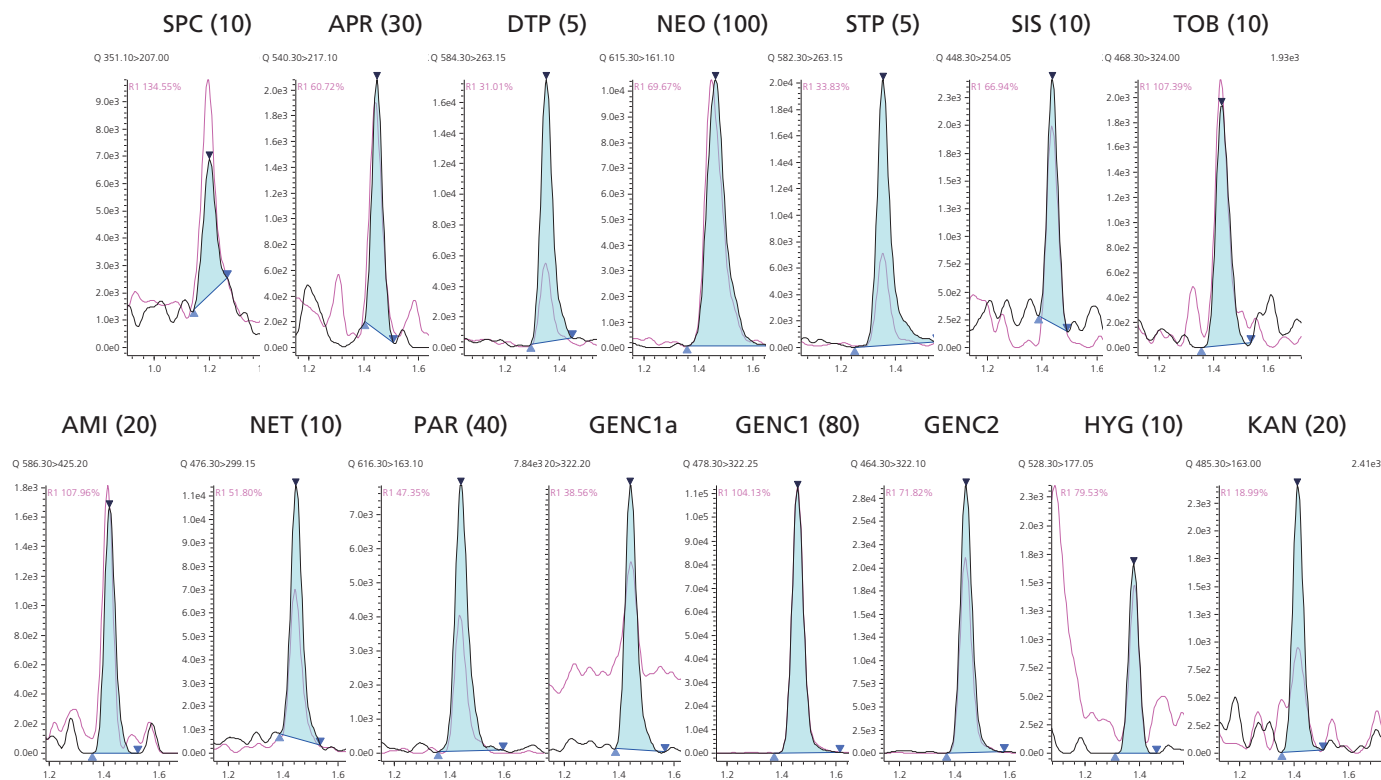

Figure 1 Chromatograms at the LOQ (concentrations in brackets, in pg/mL)

Recovery

Several meat samples, eggs and milk samples were purchased from the local supermarket. All samples were processed as described in 2.1. Blank samples and samples spiked at 100 ng/g before extraction were analysed. No compound were found in blank samples. Peak areas were compared to an aqueous standard at the same

concentration. Results are presented in table 4. The mean recoveries for each compound were superior to 80% and moreover, were homogenous within the type of samples tested. This illustrates the good extraction recoveries and low matrix effect obtained.

Identification using MRM Spectrum Mode

In MRM Spectrum Mode, 15 MRM transitions were acquired per compound. Signals were merged by the software to create a spectrum with optimized sensitivity for each fragment. By comparing this spectrum to a predefined library, identification becomes unambiguous.

Thanks to ultrafast MRM features of the mass spectrometer used, there is no significant difference in sensitivity when acquiring 2 or 15 MRM per compound. Figure 2 illustrates this approach.

Sensitive and Fast Measurement of Aminoglycoside Antibiotics in Milk, Meat or Eggs by HILIC-MS/MS and Identification using MRM Spectrum Mode

Table 4 Total recovery in real samples

	SPC	APR	DTP	GEN C1a	GEN C1	GEN C2	HYG	KAN
Eggs	93%	83%	86%	83%	86%	96%	89%	85%
Fat Milk	94%	81%	109%	88%	86%	88%	84%	82%
Low Fat Milk	88%	90%	106%	85%	89%	82%	88%	78%
Low Fat Beef	99%	88%	99%	78%	90%	87%	89%	101%
Fat Beef	93%	82%	102%	82%	80%	89%	76%	73%
Chicken Leg	94%	100%	97%	109%	93%	106%	77%	103%
Chicken Liver	83%	86%	90%	90%	81%	87%	88%	89%
Chicken Breast	93%	83%	96%	89%	90%	81%	84%	81%
Pork Cutlet Muscle	86%	87%	102%	84%	83%	88%	86%	86%
Pork Cutlet Fat	94%	83%	92%	82%	91%	91%	88%	90%
Pork Bacon	92%	79%	98%	96%	93%	96%	89%	96%
Mean	92%	86%	98%	88%	87%	90%	85%	88%
%RSD	4.9%	6.9%	6.9%	9.7%	5.2%	7.9%	5.6%	10.6%

	NEO	STP	AMI	NET	PAR	SIS	TOB
Eggs	79%	89%	84%	84%	85%	89%	81%
Fat Milk	80%	101%	83%	83%	90%	73%	87%
Low Fat Milk	81%	105%	75%	85%	73%	85%	87%
Low Fat Beef	80%	100%	98%	85%	82%	84%	87%
Fat Beef	89%	103%	83%	83%	73%	83%	59%
Chicken Leg	98%	99%	108%	108%	106%	105%	109%
Chicken Liver	82%	95%	84%	85%	87%	86%	95%
Chicken Breast	89%	93%	78%	90%	91%	87%	90%
Pork Cutlet Muscle	79%	103%	82%	74%	88%	92%	94%
Pork Cutlet Fat	75%	92%	88%	88%	84%	86%	86%
Pork Bacon	89%	93%	102%	99%	97%	96%	85%
Mean	84%	98%	88%	88%	87%	88%	87%
%RSD	8.0%	5.5%	11.8%	10.3%	11.0%	9.3%	13.6%

Sensitive and Fast Measurement of Aminoglycoside Antibiotics in Milk, Meat or Eggs by HILIC-MS/MS and Identification using MRM Spectrum Mode

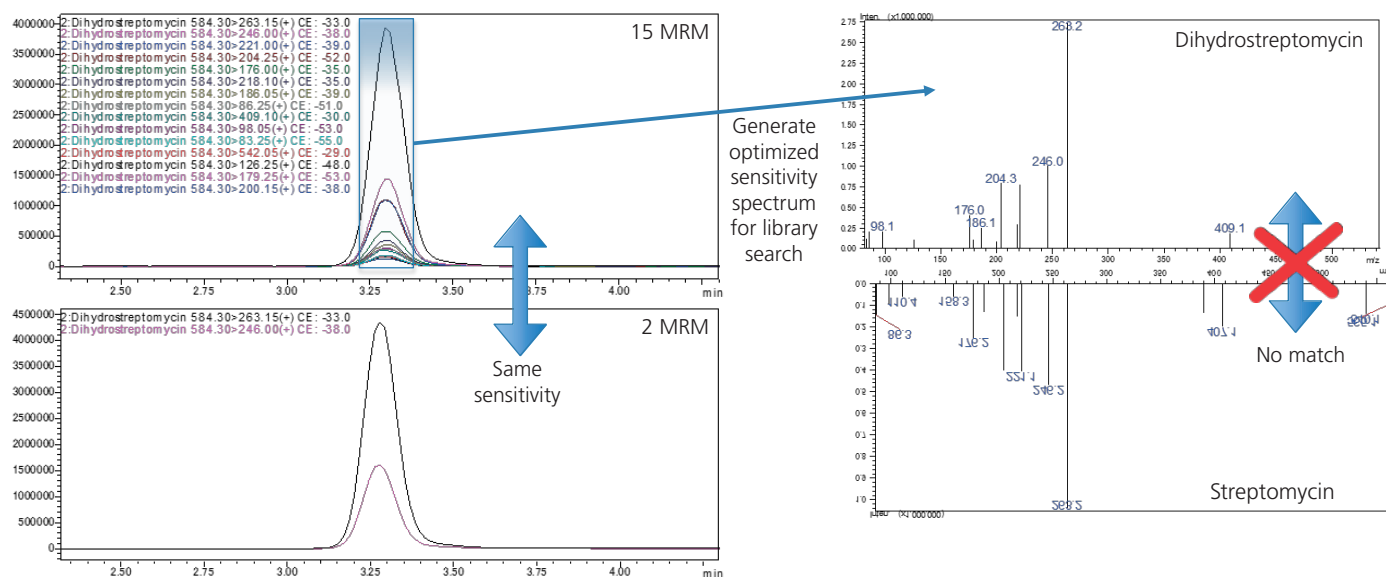

Figure 2 MRM Spectrum Mode ID confirmation

Conclusions

A very sensitive HILIC-MS/MS method was developed to detect a large panel of aminoglycoside antibiotics without ion-pairing. One method can be used for all kind of animal species or commodities, covering major food safety regulations. The complete workflow, including sample preparation has

been optimized to provide high-throughput. The good recoveries obtained across the tested matrices eliminate the use of matrix-matched calibration standards. In addition to the fast quantitative screening method, a ID confirmation method using MRM Spectrum Mode can be performed with same mobile phases and column.

First Edition: June, 2017

Technical Report

Determination of Polychlorinated Dibenzo-*p*-dioxins and Dibenzofurans (PCDD/Fs) in Foodstuffs and Animal Feed Using a Triple Quadrupole GCMS-TQ8040 System with Smart MRM Transforms Laboratory Analysis

Pu Wang¹, Huizhong Sun¹, Qinghua Zhang¹, Feifei Tian², Lei Cao²

Abstract:

A method was developed on a high selectively triple quadrupole GCMS-TQ8040 system for screening trace levels of polychlorinated dibenzo-*p*-dioxins and dibenzofurans (PCDD/Fs) in foodstuffs and animal feed. Smart MRM technology was employed for method development and GC-MS/MS analysis. The results showed good sensitivity and repeatability for PCDD/Fs at low levels, as well as a good linear response over the required concentration range. The performance on real sample analysis indicated the feasibility of Shimadzu GCMS-TQ8040 system for PCDD/Fs measurement in food and feed, as required by European Union legislation.

Keywords: GC-MS/MS, MRM, PCDDs, PCDFs, dioxins, food, feed

1. Introduction

Polychlorinated dibenzo-*p*-dioxins and dibenzofurans (PCDD/Fs) are of special concern, due to their harmful health effects. They have neurotoxic potential and are linked to causing cancer, endocrine disruption, and reproductive disorders. PCDD/Fs were never produced intentionally as marketable products, while they are widespread around the world. They can also bioaccumulate and biomagnify through the food chain, and finally pose a threat to human body. Most dioxin exposure to human derives from food (>90%), 90 % of which is of animal origin [1]. Consequently, incidents of dioxin contamination involving food and feed have generally raised great public concern in the world. For example, Germany's dioxin-tainted food scandal in 2011 led to a shutdown of more than 4700 farms and tremendous economic losses in Germany.

European regulations specifying official sampling and analysis methods for controlling PCDD/F levels and polychlorinated biphenyls (PCBs) in food and feed were initially issued in the early 2000s, followed by

several amendments thereafter. The latest amendment was Commission Regulation (EU) Nos. 589/2014 [2] and 709/2014 [3], where a major update is that gas chromatography–triple quadrupole mass spectrometry (GC-MS/MS) was recognized as an appropriate confirmatory method for checking compliance with the maximum levels of PCDD/Fs and PCBs in food and feed control. This means GC-MS/MS can be used to provide full or complementary information enabling the PCDD/Fs and dioxin-like PCBs to be identified and quantified unequivocally at the maximum or in case of need at the action threshold.

This Technical Report describes a highly sensitive and reproducible method for determining PCDD/Fs (Table 1) in food and feed using a triple quadrupole GCMS-TQ8040 system with Smart MRM, which transforms laboratory analysis process. The results show performance comparable to using high resolution gas chromatography/high resolution mass spectrometry (HRGC/HRMS) for quantitation of PCDD/Fs in food and feed.

Table 1 PCDD/Fs Specified in EU Legislation and TEF Values Established by WHO

Congener	WHO ₁₉₉₈ -TEF	WHO ₂₀₀₅ -TEF	Congener	WHO ₁₉₉₈ -TEF	WHO ₂₀₀₅ -TEF
2,3,7,8-TCDD	1	1	2,3,7,8-TCDF	0.1	0.1
1,2,3,7,8-PeCDD	1	1	1,2,3,7,8-PeCDF	0.05	0.03
1,2,3,4,7,8-HxCDD	0.1	0.1	2,3,4,7,8-PeCDF	0.5	0.3
1,2,3,6,7,8-HxCDD	0.1	0.1	1,2,3,4,7,8-HxCDF	0.1	0.1
1,2,3,7,8,9-HxCDD	0.1	0.1	1,2,3,6,7,8-HxCDF	0.1	0.1
1,2,3,4,6,7,8-HpCDD	0.01	0.01	2,3,4,6,7,8-HxCDF	0.1	0.1
OCDD	0.0001	0.0003	1,2,3,7,8,9-HxCDF	0.1	0.1
			1,2,3,4,6,7,8-HpCDF	0.01	0.01
			1,2,3,4,7,8,9-HpCDF	0.01	0.01
			OCDF	0.0001	0.0003



2. Experimental

2-1. Sample Preparation and Instrumental Analysis

The sample preparation of food and feed was mainly followed US EPA method 1613B^[4] with proper modification^[5]. The samples were extracted using an accelerated solvent extraction (ASE) system, followed by purification steps (including acidic/basic silica gel, alumina, and carbon columns). Samples were spiked with ¹³C-isotope labeled surrogate standards (1613-LCS) and internal standards (1613-IS) prior to extraction and instrumental analysis, respectively.

Samples were analyzed in a Shimadzu GCMS-TQ8040 system with Smart MRM, which transforms laboratory analysis process. The GC unit was equipped with a split/splitless injection port. The capillary column was a 60 m DB-5MS fused silica capillary column (J&W, Scientific, 0.25 μm film thickness, 0.25 mm I.D.). Table 2 showed the selected instrumental conditions for PCDD/Fs detection. Measurements were performed in EI-MS/MS Multiple Reaction Monitoring (MRM) mode. The MRM method for PCDD/Fs was developed using the Shimadzu

GCMS-TQ8040 MRM optimization tool, which automatically determines the optimum transitions and collision energies in a single sequence, and then seamlessly incorporates them into the Smart Database series for full method development (Fig. 1). At that point, the two most intense ions of the molecular chlorine isotope cluster of each congener and internal standard were chosen. Using flexible MS event, the Smart MRM function routinely determines the best dwell and loop times for the two transitions in a single method, providing optimum precision and sensitivity. In order to improve the peak shape for 2,3,7,8-TCDD/F at very low concentration levels (10 fg/μL), the event times were manually increased to 0.35 seconds for the native 2,3,7,8-TCDD/F and decreased to 0.20 seconds for the ¹³C-labeled 2,3,7,8-TCDD/F to maintain the same loop time as other congeners. Information on the MRM settings and analyte retention times are given in Table 3.

Table 2 Conditions for Gas Chromatograph and Mass Spectrometer

GC Conditions		MS Conditions	
Column	: DB-5MS (60 m × 0.25 mm × 0.25 μm)	Ionization Mode	: EI
Injection Mode	: Splitless	Ion Source Temperature	: 250 °C
Injection Volume	: 2 μL	Interface Temperature	: 270 °C
High Pressure Injection	: 300 kPa (2 min)	Acquisition Mode	: MRM Mode
Sampling Time	: 1 min	Collision Gas	: Argon
Injection Temperature	: 290 °C	Emission Current	: 250 μA
Column Oven Temperature	: 150 °C (3 min) → (20 °C/min) → 230 °C (18 min) → (5 °C/min) → 235 °C (10 min) → (4 °C/min) → 320 °C (1 min)	Loop Time	: 1.1 sec
Flow Control Mode	: Linear Velocity	Pressure of CID Gas	: 150 kPa
Column Flow	: 1.03 mL/min	Detector Voltage	: 1.8 kV

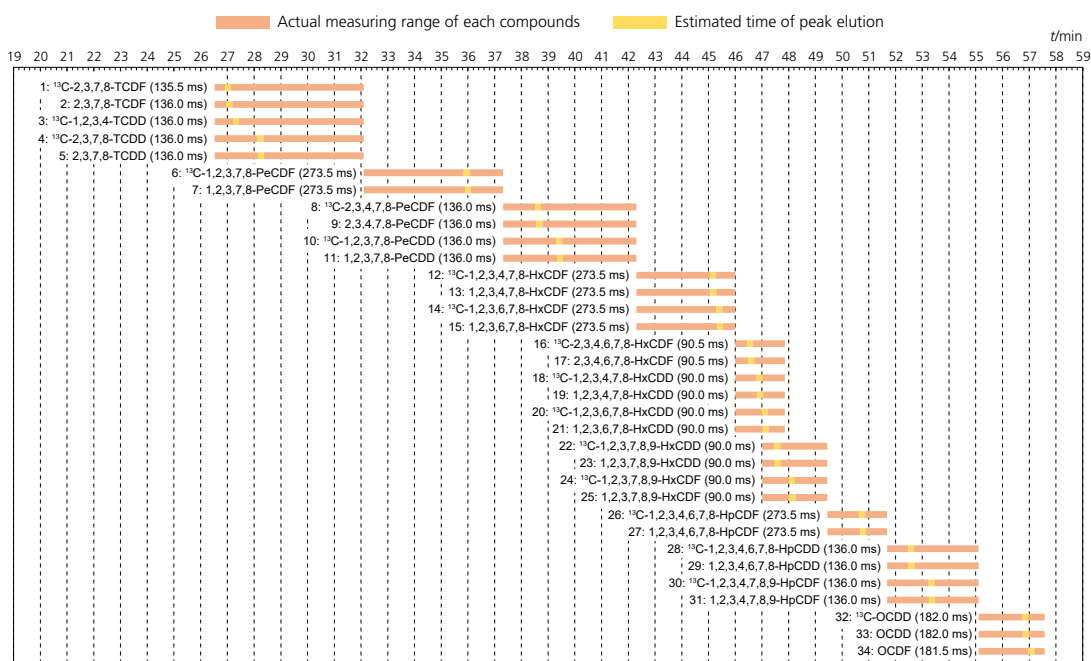

Fig. 1 Optimized MS Event Times for PCDD/F Congeners with Smart MRM Function

3. Results and Discussion

3-1. Chromatography

The chromatographic separation of the 17 native 2,3,7,8-substituted PCDD/F congeners is shown in Fig. 2 (EPA 1613 CS3). The sample was completely separated in a total run time of 60 minutes.

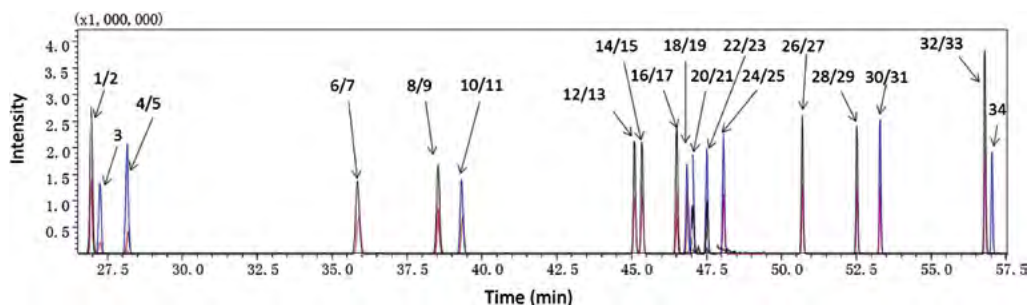

Fig. 2 Mass Chromatogram of PCDD/Fs in EPA 1613 CS3 (10 – 100 µg/L) (Peak numbers refer to analytes listed in Table 3.)

Table 3 MS/MS Settings for Native PCDD/F Congeners and ¹³C-Internal Standards

Peak No.	Analyte	RT (min)	Precursor > Product	CE (V)	Precursor > Product	CE (V)
1	¹³ C-2,3,7,8-TCDF	27.024	315.90 > 251.90	31	317.90 > 253.90	31
2	2,3,7,8-TCDF	27.076	303.90 > 240.90	31	305.90 > 242.90	31
3	¹³ C-1,2,3,4-TCDD	27.323	331.90 > 267.90	25	333.90 > 269.90	25
4	¹³ C-2,3,7,8-TCDD	28.235	331.90 > 267.90	25	333.90 > 269.90	25
5	2,3,7,8-TCDD	28.253	319.90 > 256.90	25	321.90 > 258.90	25
6	¹³ C-1,2,3,7,8-PeCDF	35.953	351.90 > 287.90	34	349.90 > 285.90	34
7	1,2,3,7,8-PeCDF	36.01	339.90 > 276.90	34	337.90 > 274.90	34
8	¹³ C-2,3,4,7,8-PeCDF	38.625	351.90 > 287.90	37	349.90 > 285.90	37
9	2,3,4,7,8-PeCDF	38.673	339.90 > 276.90	37	337.90 > 274.90	37
10	¹³ C-1,2,3,7,8-PeCDD	39.419	367.90 > 303.90	25	365.90 > 301.90	25
11	1,2,3,7,8-PeCDD	39.441	355.90 > 292.90	25	353.90 > 290.90	25
12	¹³ C-1,2,3,4,7,8-HxCDF	45.168	385.80 > 321.90	37	387.80 > 323.90	37
13	1,2,3,4,7,8-HxCDF	45.183	373.80 > 310.90	37	375.80 > 312.90	37
14	¹³ C-1,2,3,6,7,8-HxCDF	45.413	385.80 > 321.90	37	387.80 > 323.90	37
15	1,2,3,6,7,8-HxCDF	45.438	373.80 > 310.90	37	375.80 > 312.90	37
16	¹³ C-2,3,4,6,7,8-HxCDF	46.568	385.80 > 321.90	37	387.80 > 323.90	37
17	2,3,4,6,7,8-HxCDF	46.604	373.80 > 310.90	37	375.80 > 312.90	37
18	¹³ C-1,2,3,4,7,8-HxCDD	46.911	401.80 > 337.90	25	403.80 > 339.80	25
19	1,2,3,4,7,8-HxCDD	46.935	389.80 > 326.90	25	391.80 > 328.80	25
20	¹³ C-1,2,3,6,7,8-HxCDD	47.1	401.80 > 337.90	25	403.80 > 339.80	25
21	1,2,3,6,7,8-HxCDD	47.139	389.80 > 326.90	25	391.80 > 328.80	25
22	¹³ C-1,2,3,7,8,9-HxCDD	47.577	401.80 > 337.90	25	403.80 > 339.80	25
23	1,2,3,7,8,9-HxCDD	47.591	389.80 > 326.90	25	391.80 > 328.80	25
24	¹³ C-1,2,3,7,8,9-HxCDF	48.126	385.80 > 321.90	34	387.80 > 323.90	34
25	1,2,3,7,8,9-HxCDF	48.145	373.80 > 310.90	34	375.80 > 312.90	34
26	¹³ C-1,2,3,4,6,7,8-HpCDF	50.755	419.80 > 355.80	37	421.80 > 357.80	37
27	1,2,3,4,6,7,8-HpCDF	50.788	407.80 > 344.80	37	409.80 > 346.80	37
28	¹³ C-1,2,3,4,6,7,8-HpCDD	52.584	435.80 > 371.80	25	437.80 > 373.80	25
29	1,2,3,4,6,7,8-HpCDD	52.596	423.80 > 360.80	25	425.80 > 362.80	25
30	¹³ C-1,2,3,4,7,8,9-HpCDF	53.348	419.80 > 355.80	37	421.80 > 357.80	37
31	1,2,3,4,7,8,9-HpCDF	53.357	407.80 > 344.80	37	409.80 > 346.80	37
32	¹³ C-OCDD	56.85	469.70 > 405.80	25	471.70 > 407.80	25
33	OCDD	56.867	457.70 > 394.80	25	459.70 > 396.80	25
34	OCDF	57.081	441.70 > 378.80	34	443.70 > 380.80	34

3-2. Sensitivity

To verify the performance of the GC-MS/MS system in the low concentration range, 1:50 dilutions of the calibration standard EPA-1613CS1 were also measured (10 fg/µL 2,3,7,8-TCDD). Based on the 2 µL injection volume, the dilutions of the calibra-

tion standard EPA-1613CS1 indicate an absolute amount of 20 fg 2,3,7,8-TCDD in the column. The MRM chromatograms for native PCDD/Fs are shown in Fig. 3.

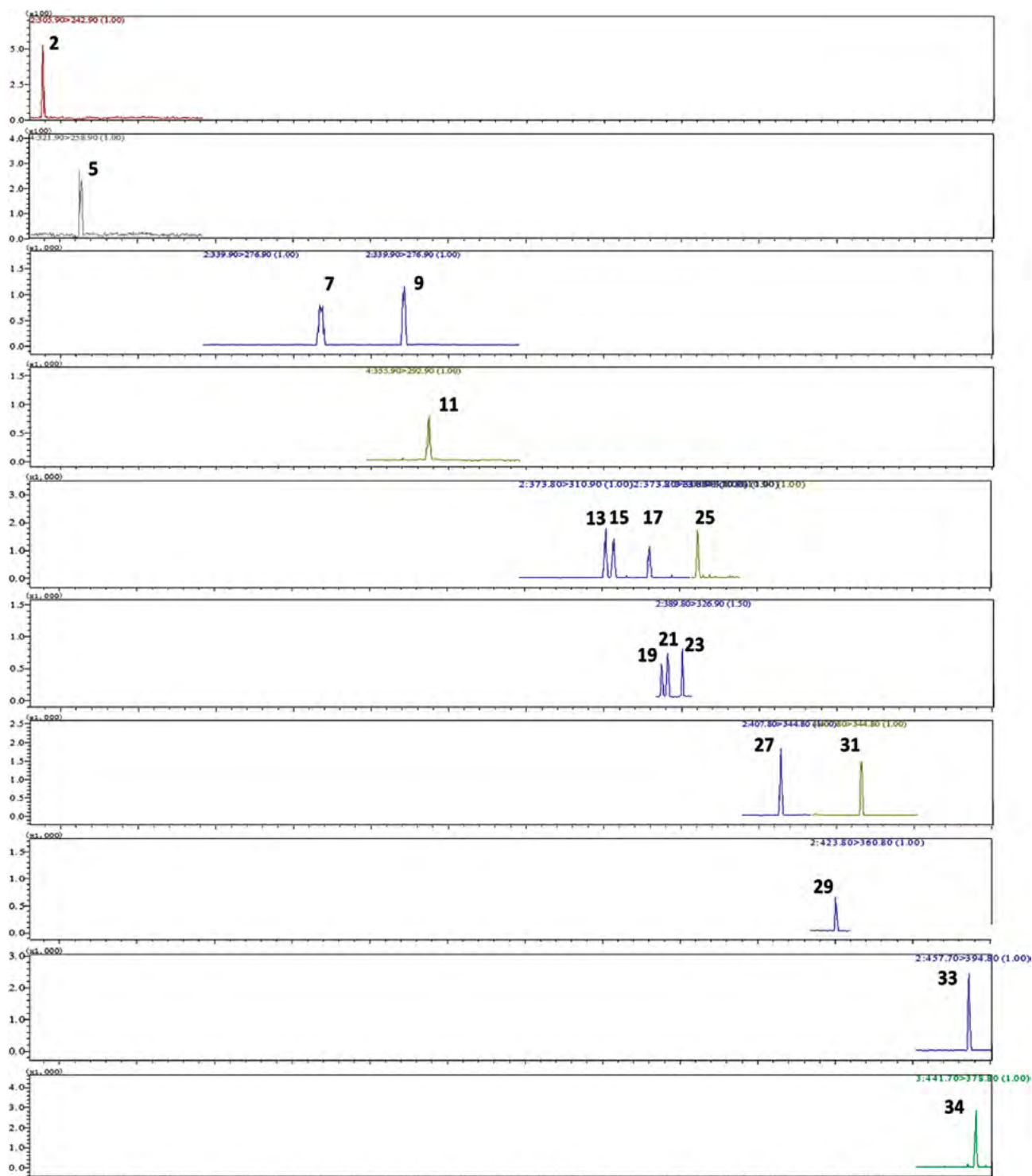

Fig. 3 MRM Chromatograms of Native PCDD/F Congeners (10 – 100 fg/μL, 2 μL injection volume) (Peak numbers refer to analytes listed in Table 3.)

3-3. Linearity of Response

A seven-point calibration curve was prepared based on US EPA method 1613, defined for calibration verification solutions (CS1-CS5), together with EPA-1613CSL and EPA-1613CS0.5. Excellent linearity was obtained for the calibration standards over the concentration range from

0.1 to 200 ng/mL (TCDD), with R^2 values >0.999 for an injection volume of 1 μL (Table 4). The mean response factor for each congener is also given in Table 4. The calibration curves for 2,3,7,8-TCDD, 2,3,7,8-TCDF and 1,2,3,7,8-PeCDD are shown in Fig. 4 to 6.

Table 4 Linear Regression for Seven-Point Calibration Curves over the Range 0.1 to 200 ng/mL (TCDD) and the Mean Response Factor for Each Congener

Congener	Regression line equation	R ²	Mean RF	RF %RSD
2,3,7,8-TCDD	Y = 1.150399X + 3.29953e-004	0.99999	1.22794	8.06
1,2,3,7,8-PeCDD	Y = 1.014733X + 3.009239e-003	1.00000	1.03887	1.96
1,2,3,4,7,8-HxCDD	Y = 1.079761X - 5.260601e-004	0.99997	1.09358	3.65
1,2,3,6,7,8-HxCDD	Y = 0.9705907X + 5.362575e-002	0.99915	1.08710	5.37
1,2,3,7,8,9-HxCDD	Y = 1.024768X + 3.682249e-002	0.99967	1.00394	14.48
1,2,3,4,6,7,8-HpCDD	Y = 0.9429045X + 1.331675e-002	0.99998	1.02985	6.92
OCDD	Y = 1.242978X - 6.145206e-002	0.99929	1.14683	6.10
2,3,7,8-TCDF	Y = 1.15754X + 9.032785e-004	0.99996	1.18104	3.57
1,2,3,7,8-PeCDF	Y = 1.015266X - 5.771587e-003	0.99997	1.07846	7.83
2,3,4,7,8-PeCDF	Y = 1.045151X - 6.304552e-003	0.99998	1.04210	4.49
1,2,3,4,7,8-HxCDF	Y = 1.006328X + 2.605984e-002	0.99988	1.09930	6.04
1,2,3,6,7,8-HxCDF	Y = 0.9307018X + 3.432044e-002	0.99971	1.06611	8.06
2,3,4,6,7,8-HxCDF	Y = 0.9080292X + 3.053454e-002	0.99983	1.00464	6.34
1,2,3,7,8,9-HxCDF	Y = 0.960272X + 2.450491e-002	0.99993	1.03403	9.10
1,2,3,4,6,7,8-HpCDF	Y = 0.9732686X + 4.031919e-002	0.99958	1.08255	4.88
1,2,3,4,7,8,9-HpCDF	Y = 0.9562794X + 3.622056e-002	0.99969	1.06788	5.48
OCDF	Y = 1.424071X + 3.271179e-003	0.99999	1.50245	8.94

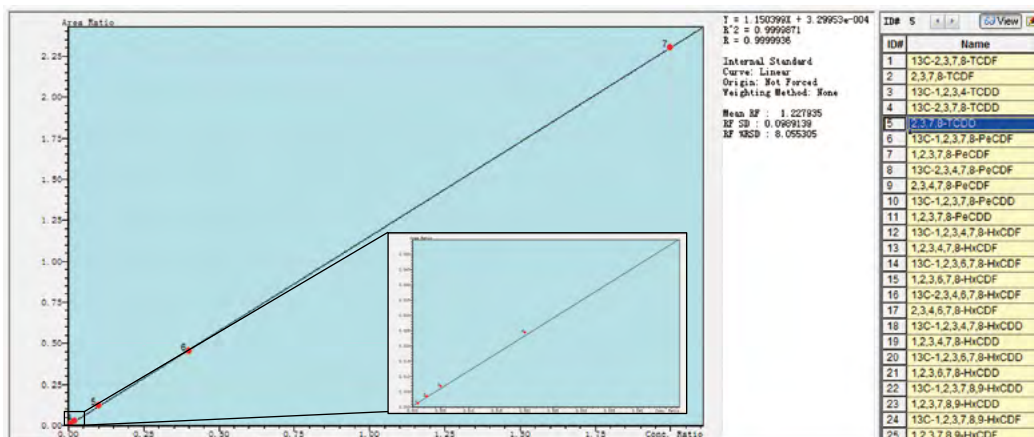

Fig. 4 Seven-Point Calibration Curve for 2,3,7,8-TCDD with Both Linear Fit and Mean Response Factors

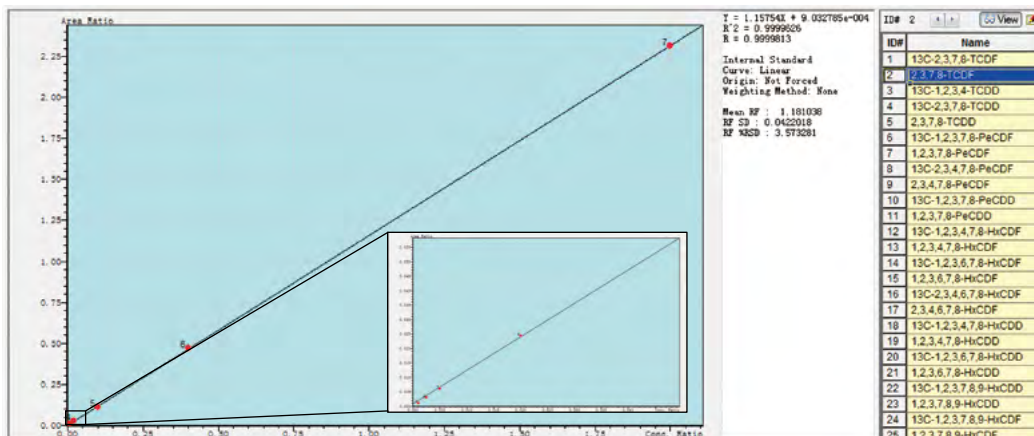

Fig. 5 Seven-Point Calibration Curve for 2,3,7,8-TCDF with Both Linear Fit and Mean Response Factors

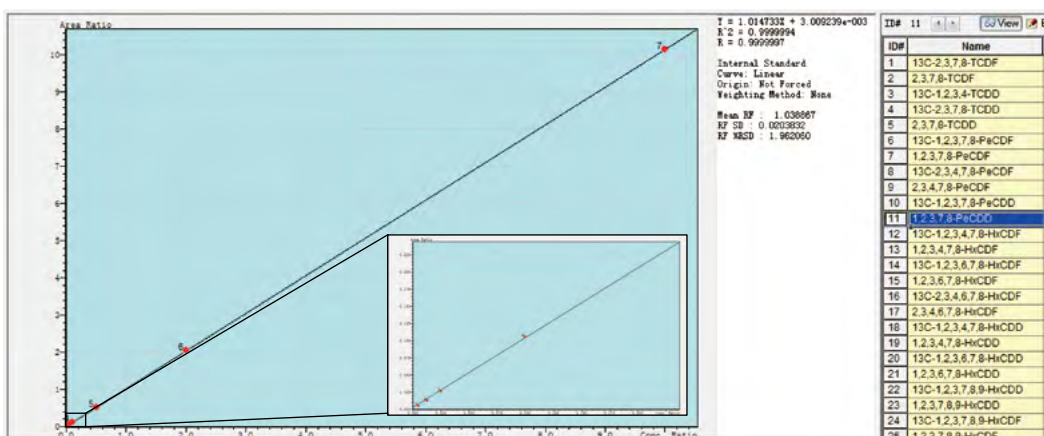

Fig. 6 Seven-Point Calibration Curve for 1,2,3,7,8-PeCDD with Both Linear Fit and Mean Response Factors

3-4. Repeatability

The repeatability was confirmed for within the same day and over different days. Total 12 injections (four 2 μ L injections per day for three days) of 1:50 diluted EPA-1613CS1 (10 fg/ μ L 2,3,7,8-TCDD)

were performed. Results exhibited good repeatability for the peak areas of each congener, with a relative standard deviations (RSD) less than 15 % (Fig. 7).

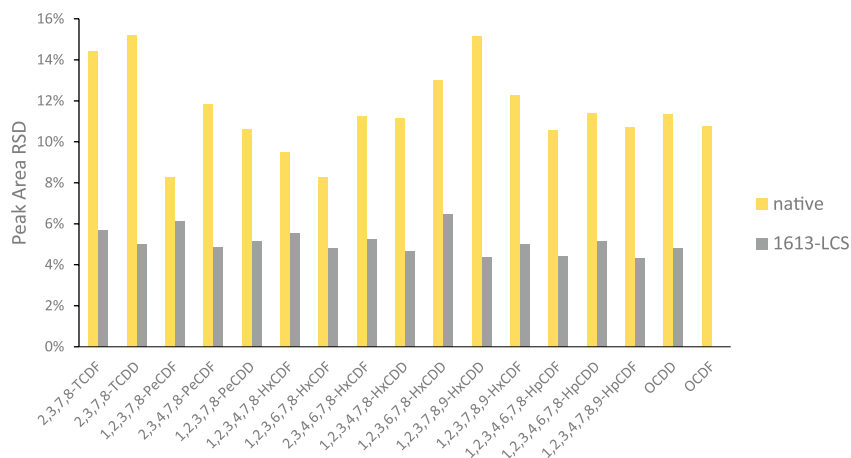

Fig. 7 Repeatability of Peak Areas for Native PCDD/Fs and 1613-LCS (n = 12)

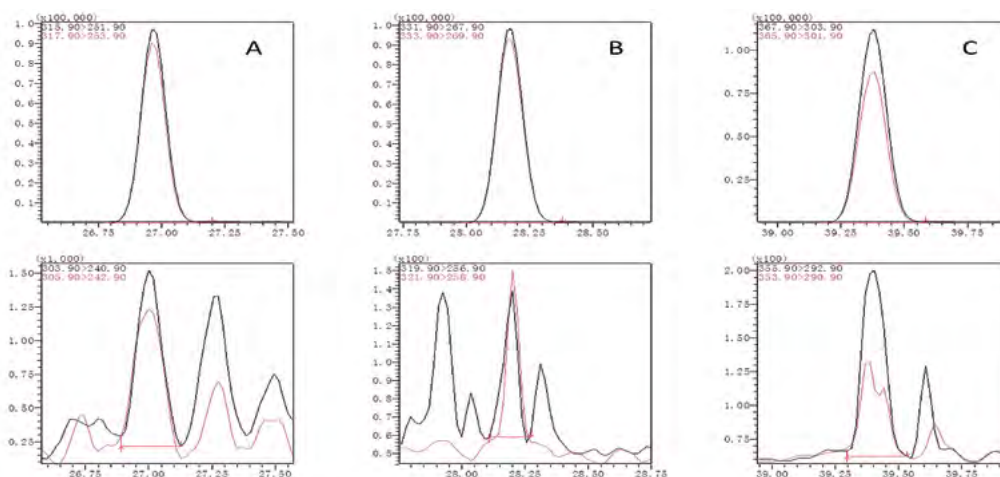

Fig. 8 MRM Chromatograms for ¹³C-Labeled and Native 2,3,7,8-TCDF (A), 2,3,7,8-TCDD (B), and 1,2,3,7,8-PeCDD (C) in Fish Oil

3-5. Sample Analysis

For comparison, each fish oil and milk sample was analyzed in both GC-MS/MS and HRGC/HRMS systems, using the same GC conditions for the HRGC/HRMS system. The MRM chromatograms for 2,3,7,8-TCDF, 2,3,7,8-TCDD, and 1,2,3,7,8-PeCDD in the fish oil sample are shown in Fig. 8. The congener profiles in both samples are exhibited in Fig. 9 and 10. GC-MS/MS results showed good consistency with HRGC/HRMS results. The toxic equivalents (TEQ) of PCDD/Fs were 29.5 pg WHO-TEQ₂₀₀₅/g fat and 1.38 pg WHO-TEQ₂₀₀₅/g fat (upper bound values) in the fish oil and milk samples, respectively, which were comparable to the results of 24.9 and 1.37 pg WHO-TEQ₂₀₀₅/g fat obtained from the HRGC/HRMS system.

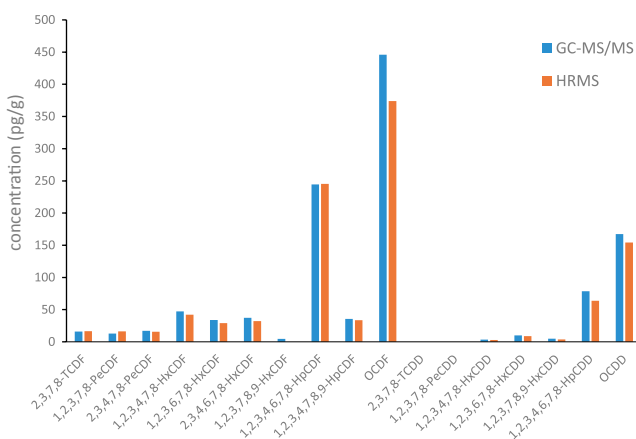

Fig. 9 Congener Profiles of PCDD/Fs in Fish Oil

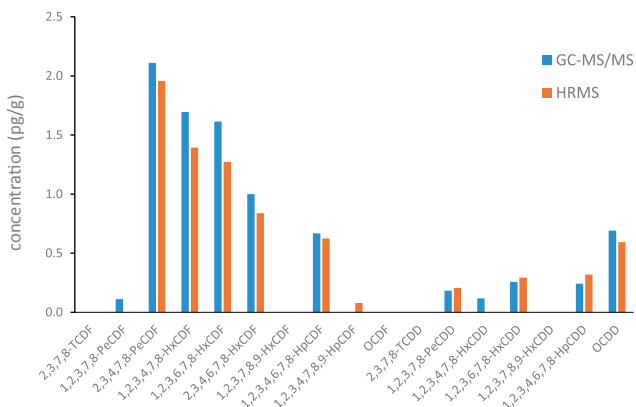

Fig. 10 Congener Profiles of PCDD/Fs in Milk

4. Conclusion

The Shimadzu GCMS-TQ8040 system facilitates the screening and quantitation of low concentration PCDD/Fs in different foodstuffs and animal feed samples. The method showed good linearity, sensitivity, and repeatability. The analytical results from real samples also indicated good precision using this method, when compared with HRGC/HRMS results. This suggests that the Shimadzu GCMS-TQ8040 system provides a substitute solution for routine screening and quantitation of PCDD/Fs in food and feed, as required by European Union legislation.

References

1. IOM (Institute of Medicine). Dioxins and dioxin-like compounds in the food supply: Strategies to decrease exposure. (Washington, DC: The National Academies Press, 2003).
2. Commission Regulation (EU) No. 589/2014 of 2 June 2014 laying down methods of sampling and analysis for the control of levels of dioxins, dioxin-like PCBs and non-dioxin-like PCBs in certain foodstuffs and repealing Regulation (EU) No. 252/2012, *Offic. J. Eur. Commun.* 2014, L164/18–40.
3. Commission Regulation (EU) No. 709/2014 of 20 June 2014 amending Regulation (EC) No. 152/2009 as regards the determination of the levels of dioxins and polychlorinated biphenyls, *Offic. J. Eur. Commun.* 2014, L188/1–18.
4. US EPA method 1613B Tetra- through Octa-Chlorinated Dioxins and Furans by Isotope Dilution HRGC/HRMS. 1997.
5. Wang P, Zhang Q, Wang Y, Wang T, Li X, Ding L, Jiang G. Evaluation of Soxhlet extraction, accelerated solvent extraction and microwave-assisted extraction for the determination of polychlorinated biphenyls and polybrominated diphenyl ethers in soil and fish samples. *Anal. Chim. Acta.* 2010, 663(1):43–48.

Triple Quadrupole Gas Chromatograph Mass Spectrometer

GCMS-TQ8040

Finally, a triple quadrupole GCMS *Smart* enough for everyday use in your laboratory.

The Shimadzu GCMS-TQ8040 is the first triple quadrupole with Smart Productivity for high efficiency sample throughput, Smart Operation for quick and easy method development, and Smart Performance for low detection limits and Scan/MRM. These three smart technologies contribute to Smart MRM, and provide the most accurate, cost-effective, and easy-to-use triple quadrupole GCMS you have ever imagined.

UFMS
ULTRA FAST MASS SPECTROMETRY



Smart Productivity

- Retention time synchronized MRM provides simultaneous sensitivity and precision for hundreds of compounds in one run
- Smart MRM optimizes analysis of 400+ compounds in a single acquisition with maximum sensitivity
- Reduced downtimes with the Twin Line configuration MS system

Smart Operation

- MRM Optimization Tool to optimize MRM transitions automatically
- Smart Database Series with fully optimized transitions for hundreds of compounds
- Smart MRM for automatic method creation in a single step

Smart Performance

- The patented ion source design and uniform temperature prevent active spots and boost sensitivity
- The OFF-AXIS ion optics eliminate chemical noise and lower detection limits
- High-sensitivity analysis even in single GC-MS mode

Smart Environmental Database

Create MRM Methods for GC-MS/MS

The Smart Environmental Database contains all the information necessary to create MRM methods for over 500 environmental pollutants, including PCBs, BFRs, dioxins, PAHs, organochlorine pesticides (OCPs), and stable isotopically labeled compounds that are commonly used as Internal and Surrogate Standards.

Smart MRM Optimizes Methods Automatically

The Smart MRM feature allows the user to create fully optimized MRM and Scan/MRM methods automatically. GC-MS/MS Dwell, Event, and Loop times can be difficult to optimize when dozens, or even hundreds of compounds are to be analyzed simultaneously. The Smart MRM feature automatically determines the optimum Dwell, Event, and Loop settings using flexible MRM events, and creates MRM and Scan/MRM methods that provide the best sensitivity for all compounds in a single method.

Analysis of PCB in River Water

(2,2',5,5'-Tetrachlorobiphenyl (#52) concentration in water of 0.080 ng/L)

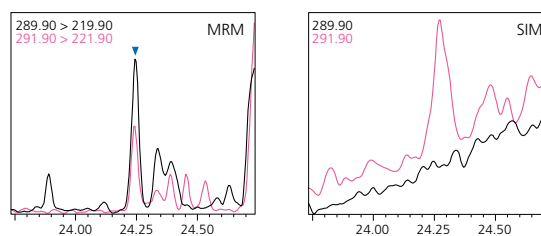

Number of Registered Compounds	Number of Registered Native Compounds	Number of Registered Compounds Labeled with Stable Isotopes
Polychlorinated biphenyls	209	45
Brominated flame retardants	55	28
Dioxins	32	26
Polycyclic aromatic hydrocarbons	38	37
Organochlorine pesticides	32	25

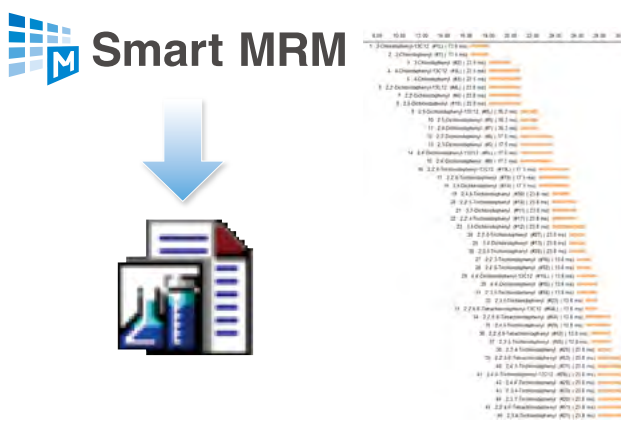

Shimadzu Corporation

www.shimadzu.com/an/

For Research Use Only. Not for use in diagnostic procedures.

The content of this publication shall not be reproduced, altered or sold for any commercial purpose without the written approval of Shimadzu. The information contained herein is provided to you "as is" without warranty of any kind including without limitation warranties as to its accuracy or completeness. Shimadzu does not assume any responsibility or liability for any damage, whether direct or indirect, relating to the use of this publication. This publication is based upon the information available to Shimadzu on or before the date of publication, and subject to change without notice.

First Edition: January, 2016

© Shimadzu Corporation, 2016

Printed in Japan 3655-10529-10ANS

Technical Report

Analysis of Dioxins in Foods and Feeds Using GC-MS/MS

Masato Takakura¹, Thomas Lehardy², Philippe Marchand²

Abstract:

Until recently, the analysis of dioxins in foods and feeds was performed using magnetic sector GC-MS (GC-HRMS), which provided highly accurate quantitation. In recent years, the quantitative accuracy of GC-MS/MS has improved significantly. Accordingly, this method has become officially recognized in the EU as can be used for analyzing dioxins (EU589/2014, 644/2017). In this investigation, dioxins were analyzed in 44 types and 201 samples of foods and feeds using the GCMS-TQ8050 and the GC-MS/MS method package for dioxins in foods, which is compliant with EU regulations. Additionally, the GC-MS/MS analysis results were compared with the analysis results from GC-HRMS, to compare the quantitative capabilities of both methods. For the comparison, the TEQ ratio was calculated for various samples. From the comparison of the results, for samples with a higher TEQ than 0.060 pg/uL (TEQ when any of the compounds was detected at a higher concentration than LOQ), GC-MS/MS and GC-HRMS provided similar TEQ values in at least 98 % of the samples. Accordingly, it was evident that analysis with GCMS-TQ8050 and method package provides a quantitative capability equivalent to that from GC-HRMS for samples at the concentration levels required for analysis.

Keywords: GC-MS/MS, foods, feeds, dioxins

1. Introduction

Residual organic compounds (persistent organic pollutants or POPs) in foods and feeds are analyzed using a variety of methods. In particular, dioxins are particularly toxic even for POPs, so quantitative analysis is required down to low concentrations.

Until recently, the analysis of dioxins was performed using magnetic sector (double focusing) GC-MS (hereinafter "GC-HRMS"), which provides highly accurate quantitation. However, triple quadrupole GC-MS (hereinafter "GC-MS/MS") is less expensive and easier to handle than GC-HRMS, so its use is being increasingly investigated. In recent years, the quantitative accuracy of GC-MS/MS has improved significantly. Accordingly, the use of this analysis method has become officially recognized in the EU (EU589/2014, 644/2017).

However, in order to change from GC-HRMS to GC-MS/MS, it is first necessary to compare their respective quantitative capabilities.

The Shimadzu GCMS-TQ8050 combines a high-sensitivity detector, capable of detection at femtogram order concentrations, with noise-reduction technology, enabling the analysis of dioxins in foods and feeds. Additionally, the "EU Regulation Compliant GC-MS/MS Method Package for Dioxins in Foods" consists of method files registered with the optimal conditions for the analysis of dioxins, as well as a report creation tool, which can output the items required by EU regulations. As a result, analysis can start without spending time on investigating conditions.

In this technical report, dioxins (polychlorinated dibenzo-p-dioxin (PCDD) and polychlorinated dibenzofuran (PCDF) only) were analyzed in 44 types and 201 samples of foods and feeds using the GCMS-TQ8050 in combination with the method package. Additionally, the GC-MS/MS analysis results were compared with the analysis results from GC-HRMS, in order to evaluate the quantitative capabilities of both techniques.

2. EU Regulation Compliant GC-MS/MS Method Package for Dioxins in Foods

The features of the "EU Regulation Compliant GC-MS/MS Method Package for Dioxins in Foods" are shown below.

Method Files Registered with the Optimal Conditions for the Analysis of Dioxins

To perform an analysis with TQ, the transition and collision energy (CE) of each compound must be optimized.

Additionally, when creating method files, it is necessary to calculate the retention times of all the target compounds and then to set up a complicated time program based on those results.

Optimized analytical conditions (including transition and CE) are pre-registered in the method files in this product. Additionally, the files are registered with retention times and retention indices, and the retention times can be adjusted automatically using the retention time adjustment function (AART: Automatic Adjustment of Retention Time), allowing analysis to start immediately.

The retention times and time programs can be adjusted automatically, even if the retention times for the measured compounds change, such as when conducting maintenance of the column tip.

Report Creation Tool, Capable of Outputting Items Required by EU Regulations

Complicated calculations are required in analysis reports for dioxins in foods. A report creation tool is included in this product. It can automatically create reports showing items required by EU regulations.

In the analysis of dioxins, a single sample is fractionated into a dioxin (DXN) analysis sample and a polychlorinated biphenyl (PCB) analysis sample. However, depending on the pretreatment method, some of the PCBs can be eluted in the fraction for DXNs, so the analysis results for PCBs are sometimes divided into two parts (the analysis sample for both DXNs and PCBs, and the analysis sample for PCBs only).

With the report creation tool in this product, even if the analysis results for PCBs are divided into two parts, they can be combined, enabling support for a variety of samples and pretreatment methods.

3. Experiment

For the various food samples, pretreatment was performed using an automatic pretreatment unit (extraction: SpeedExtractor (BUCHI); purification: GO-xHT (Miura Co., Ltd.)). Nonane was used as the final solvent for the sample, and the amount of final solvent for the samples was 10 uL. For the STD, a mixture of DF-ST and DF-LCS from Wellington Laboratories was used.

In terms of the analytical conditions for GC-MS/MS, the conditions registered in the method package were used. The analytical conditions in detail are shown in Table 1. Additionally, the transition and collision energies for the compounds measured in this investigation are shown in Table 2.

Table 1 GC-MS/MS Analytical Conditions

System Configuration	Analytical Conditions (GC)
Pretreatment Unit (Extraction) : SpeedExtractor (BUCHI)	Insert Liner : Topaz® single gooseneck liner, with wool (Restek Corp., P/N: 23336)
Pretreatment Unit (Purification) : GO-xHT (Miura Co., Ltd.)	Column : SH-Rxi™-5Sil MS (60 m, 0.25 mm I.D., 0.25 µm), (SHIMADZU, P/N: 227-36036-02)
Autosampler : AOC-20i/s	Injection Mode : Splitless
GC-MS/MS : GCMS-TQ8050	Sampling Time : 1.00 min.
Software : GCMSsolution™ Ver. 4.45 SP1 LabSolutions Insight™ Ver. 3.2 SP1 GC-MS/MS method package for dioxins in foods	Injection Temp. : 280 °C
	Column Oven Temp. : 150 °C (1min.) → (20 °C/min.) → 220 °C → (2 °C /min.) → 260 °C (3 min.) → (5 °C /min.) → 320 °C (3.5 min.)
Analytical Conditions (AOC-20i/s)	Analytical Conditions (MS)
# of Rinses with Solvent (Pre-run) : 3	High Pressure Injection : 450 kPa (1.5 min.)
# of Rinses with Solvent (Post-run) : 3	Flow Control Mode : Linear Velocity (45.6 cm/sec.)
# of Rinses with Sample : 0	Purge Flow : 20 mL/min.
Plunger Speed (Suction) : Low	Carrier Gas : Helium
Viscosity Comp. Time : 0.2 sec.	
Plunger Speed (Injection) : High	
Syringe Insertion Speed : High	
Pumping Times : 5	Ion Source Temp. : 230 °C
Inj. Port Dwell Time : 0.3 sec.	Interface Temp. : 300 °C
Terminal Air Gap : No	Detector Voltage : 1.8 kV (Absolute)
Plunger Washing Speed : High	Loop Time : 0.8 sec. (for native compounds) 0.2 sec. (for labeled compounds)
Washing Volume : 6 µL	Transitions : Refer to Table 2
Injection Volume : 2 µL	

Table 2 Transition and Collision Energies for the Measured Compounds

I.D.	Compound Name	Retention Index	Quantitative Ion	CE	Reference Ion	CE
1	2,3,7,8-Tetrachlorodibenzo-p-dioxin	2383	319.9>256.9	20	321.9>258.9	20
2	1,2,3,7,8-Pentachlorodibenzo-p-dioxin	2567	355.9>292.9	20	353.9>290.9	20
3	1,2,3,4,7,8-Hexachlorodibenzo-p-dioxin	2742	389.8>326.9	22	391.8>328.9	22
4	1,2,3,6,7,8-Hexachlorodibenzo-p-dioxin	2748	389.8>326.9	22	391.8>328.9	22
5	1,2,3,7,8,9-Hexachlorodibenzo-p-dioxin	2762	389.8>326.9	22	391.8>328.9	22
6	1,2,3,4,6,7,8-Heptachlorodibenzo-p-dioxin	2936	423.8>360.8	22	425.8>362.8	22
7	Octachlorodibenzo-p-dioxin	3128	457.7>394.7	22	459.7>396.7	22
8	2,3,7,8-Tetrachlorodibenzofuran	2357	303.9>240.9	28	305.9>242.9	28
9	1,2,3,7,8-Pentachlorodibenzofuran	2513	339.9>276.9	30	337.9>274.9	30
10	2,3,4,7,8-Pentachlorodibenzofuran	2553	339.9>276.9	30	337.9>274.9	30
11	1,2,3,4,7,8-Hexachlorodibenzofuran	2694	373.8>310.9	30	375.8>312.9	30
12	1,2,3,6,7,8-Hexachlorodibenzofuran	2701	373.8>310.9	30	375.8>312.9	30
13	2,3,4,6,7,8-Hexachlorodibenzofuran	2732	373.8>310.9	30	375.8>312.9	30
14	1,2,3,7,8,9-Hexachlorodibenzofuran	2778	373.8>310.9	30	375.8>312.9	30
15	1,2,3,4,6,7,8-Heptachlorodibenzofuran	2867	407.8>344.8	30	409.8>346.8	30
16	1,2,3,4,7,8,9-Heptachlorodibenzofuran	2965	407.8>344.8	30	409.8>346.8	30
17	Octachlorodibenzofuran	3137	441.8>378.8	30	443.8>380.8	30
18	1,2,3,4-Tetrachlorodibenzo-p-dioxin-13C12	2287	331.9>268.0	20	333.9>270.0	20
19	2,3,7,8-Tetrachlorodibenzo-p-dioxin-13C12	2382	331.9>268.0	20	333.9>270.0	20
20	1,2,3,7,8-Pentachlorodibenzo-p-dioxin-13C12	2567	367.9>303.9	20	365.9>301.9	20
21	1,2,3,4,7,8-Hexachlorodibenzo-p-dioxin-13C12	2742	401.8>337.9	22	399.9>335.9	22
22	1,2,3,6,7,8-Hexachlorodibenzo-p-dioxin-13C12	2747	401.8>337.9	22	399.9>335.9	22
23	1,2,3,7,8,9-Hexachlorodibenzo-p-dioxin-13C12	2762	401.8>337.9	22	399.9>335.9	22
24	1,2,3,4,6,7,8-Heptachlorodibenzo-p-dioxin-13C12	2935	435.8>371.8	22	437.8>373.8	22
25	Octachlorodibenzo-p-dioxin-13C12	3127	469.8>405.8	22	471.8>407.8	22
26	2,3,7,8-Tetrachlorodibenzofuran-13C12	2357	315.9>251.9	28	317.9>253.9	28
27	1,2,3,7,8-Pentachlorodibenzofuran-13C12	2513	351.9>287.9	30	349.9>285.9	30
28	2,3,4,7,8-Pentachlorodibenzofuran-13C12	2553	351.9>287.9	30	349.9>285.9	30
29	1,2,3,4,7,8-Hexachlorodibenzofuran-13C12	2694	385.8>321.9	30	387.8>323.9	30
30	1,2,3,6,7,8-Hexachlorodibenzofuran-13C12	2701	385.8>321.9	30	387.8>323.9	30
31	2,3,4,6,7,8-Hexachlorodibenzofuran-13C12	2732	385.8>321.9	30	387.8>323.9	30
32	1,2,3,7,8,9-Hexachlorodibenzofuran-13C12	2778	385.8>321.9	30	387.8>323.9	30
33	1,2,3,4,6,7,8-Heptachlorodibenzofuran-13C12	2867	419.8>355.9	30	421.8>357.9	30
34	1,2,3,4,7,8,9-Heptachlorodibenzofuran-13C12	2965	419.8>355.9	30	421.8>357.9	30
35	Octachlorodibenzofuran-13C12	3137	453.8>389.8	30	455.8>391.8	30

4. Analysis Results

4-1. Analysis Results for the STD

In the analysis of dioxins in foods, the maximum permitted concentrations (Maximum Levels, hereinafter "ML") are prescribed for each food and feed. With the food and feed samples in this investigation, the ML for pig's fat and pig's meat were the lowest at 1 pg/g of fat (sum of dioxins (WHO-PCDD/F-TEQ)). Additionally, the limit of quantitation (hereinafter "LOQ") required for each compound in the analysis depends on the food or feed sample's ML, the pretreatment method, and the TEF (toxic equivalence factor) of each compound. The compounds 2,3,7,8-Tetrachlorodibenzo-p-dioxin and 1,2,3,7,8-Pentachlorodibenzo-p-dioxin have the highest TEF (TEF=1), so their LOQ are lower than for other compounds. In this investigation, the LOQ for 2,3,7,8-Tetrachlorodibenzo-p-dioxin and 1,2,3,7,8-Pentachlorodibenzo-p-dioxin in pig's fat and pig's meat was 0.060 pg/uL at the concentration in the final vial.

In the EU regulations, for each compound, at least one of the criteria shown below (a partial excerpt from EU589/2014 and 644/2017) must be satisfied at the LOQ.

1. S/N Ratio (Hereinafter "Method 1")

The concentration of an analyte in the extract of a sample which produces an instrumental response at two different ions to be monitored with a S/N (signal/noise) ratio of 3:1 for the less intensive raw data signal.

2. Lowest Concentration Point on the Calibration Curve (Method 2)

The lowest concentration point on a calibration curve that gives an acceptable ($\leq 30\%$) and consistent (measured at least at the start and at the end of an analytical series of samples) deviation to the average relative response factor calculated for all points on the calibration curve in each series of samples.

In this technical report, for the purposes of confirmation, an evaluation was performed using both criteria.

As noted above, for 2,3,7,8-Tetrachlorodibenzo-p-dioxin, it is necessary to set the LOQ to 0.060 pg/uL or less. Accordingly, before analysis, the STD was prepared so that the concentration of each compound was 0.050 pg/uL. (The concentration was double however for Octachlorodibenzo-p-dioxin and Octachlorodibenzofuran.) From the results of the analysis, it was evident that the criteria for Method 1 were satisfied for all compounds. The S/N ratios for each compound are shown in Fig. 1.

Additionally, with Method 2, a calibration curve was created with all six points used, including the two at concentrations less than 0.060 pg/uL (0.025 pg/uL and 0.050 pg/uL). The concentrations for each compound at each calibration curve point (level) are shown in Table 3. For each compound, when the level 1 RRF and average RRF were compared, it was found that all compounds satisfied the criteria for Method 2. The RRF deviations for each compound are shown in Table 3.

From the above-mentioned results, it was evident that at the LOQ, the criteria were satisfied for all compounds.

Table 3 Each Calibration Point Concentration and RRF for the Measured Compounds

I.D.	Compound Name	TEF	Calibration Point Concentration						Average RRF	RRF (level 1)	RRFDev (%) (Level 1)
			Level 1	Level 2	Level 3	Level 4	Level 5	Level 6			
1	2,3,7,8-Tetrachlorodibenzo-p-dioxin	1	0.025	0.050	0.100	0.250	0.500	1.000	1.07	1.15	8.10
2	1,2,3,7,8-Pentachlorodibenzo-p-dioxin	1	0.025	0.050	0.100	0.250	0.500	1.000	1.09	0.97	10.56
3	1,2,3,4,7,8-Hexachlorodibenzo-p-dioxin	0.1	0.025	0.050	0.100	0.250	0.500	1.000	1.14	1.39	22.26
4	1,2,3,6,7,8-Hexachlorodibenzo-p-dioxin	0.1	0.025	0.050	0.100	0.250	0.500	1.000	0.95	0.92	2.72
5	1,2,3,7,8,9-Hexachlorodibenzo-p-dioxin	0.1	0.025	0.050	0.100	0.250	0.500	1.000	1.03	1.25	21.44
6	1,2,3,4,6,7,8-Heptachlorodibenzo-p-dioxin	0.01	0.025	0.050	0.100	0.250	0.500	1.000	0.92	0.82	11.46
7	Octachlorodibenzo-p-dioxin	0.0003	0.050	0.100	0.200	0.500	1.000	2.000	1.19	1.04	12.21
8	2,3,7,8-Tetrachlorodibenzofuran	0.1	0.025	0.050	0.100	0.250	0.500	1.000	1.10	1.05	4.66
9	1,2,3,7,8-Pentachlorodibenzofuran	0.03	0.025	0.050	0.100	0.250	0.500	1.000	1.04	1.00	3.23
10	2,3,4,7,8-Pentachlorodibenzofuran	0.3	0.025	0.050	0.100	0.250	0.500	1.000	0.97	0.89	7.59
11	1,2,3,4,7,8-Hexachlorodibenzofuran	0.1	0.025	0.050	0.100	0.250	0.500	1.000	1.03	0.82	20.72
12	1,2,3,6,7,8-Hexachlorodibenzofuran	0.1	0.025	0.050	0.100	0.250	0.500	1.000	1.09	1.36	24.62
13	2,3,4,6,7,8-Hexachlorodibenzofuran	0.1	0.025	0.050	0.100	0.250	0.500	1.000	1.09	1.39	27.83
14	1,2,3,7,8,9-Hexachlorodibenzofuran	0.1	0.025	0.050	0.100	0.250	0.500	1.000	1.06	1.23	16.10
15	1,2,3,4,6,7,8-Heptachlorodibenzofuran	0.01	0.025	0.050	0.100	0.250	0.500	1.000	1.17	1.05	10.37
16	1,2,3,4,7,8,9-Heptachlorodibenzofuran	0.01	0.025	0.050	0.100	0.250	0.500	1.000	1.02	0.97	4.97
17	Octachlorodibenzofuran	0.0003	0.050	0.100	0.200	0.500	1.000	2.000	1.00	0.84	15.80

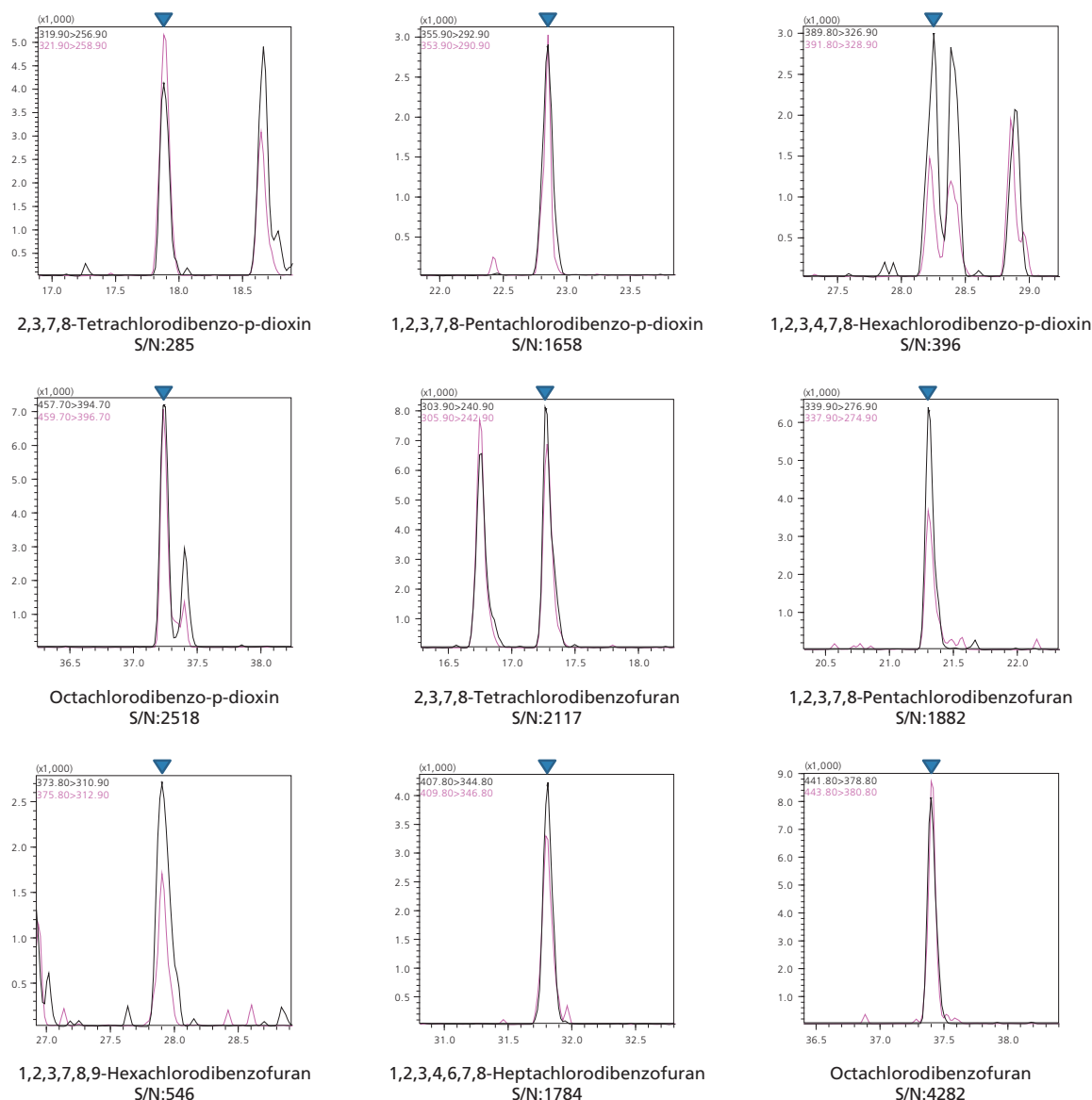

Fig. 1 Chromatograms for a Concentration of 0.050 pg/uL

4-2. Analysis Results for the Test Samples

As previously noted, the strength of toxicity differs for each dioxin compound. The TEF, which is calculated for each compound by taking the toxicity of 2,3,7,8-Tetrachlorodibenzo-p-dioxin as 1, is used as an index of strength. Note that the TEF values for each compound are as shown in Table 3.

The ML for the dioxins in foods and feeds are prescribed by their toxic equivalents (TEQ). The TEQ is calculated by multiplying the concentration of each compound by the TEF, and then calculating the total TEQ for all compounds.

In this investigation, 44 types and 201 samples of foods were analyzed using GC-MS/MS. Additionally, the same samples were analyzed with GC-HRMS, and the results were compared with the GC-MS/MS analysis results. For this comparison, the TEQ was calculated by multiplying the concentration in the final vial for each compound by the TEF, and then calculating a total TEQ for all com-

pounds. The results were tallied separately for each food and feed.

The results for typical foods and feeds are shown in Fig. 2. The results for all foods and feeds are shown in Fig. 3. Additionally, typical chromatograms for each compound are shown in Fig. 4.

Fig. 2 shows a comparison of the TEQ values for GC-MS/MS and GC-HRMS by food and feed. The sample is indicated on the horizontal axis, and the TEQ for each sample is indicated on the vertical axis.

Fig. 3 shows the GC-HRMS TEQ on the horizontal axis, and the GC-MS/MS TEQ on the vertical axis. If they were correlated, the values would approach a straight line with a slope of 1 (the blue dashed line in the figure).

A TEQ of 0.060 pg/uL and a TEQ of 0.025 pg/uL are marked as indicators for the samples.

TEQ 0.060 pg/uL: If even one compound is detected at a concentration higher than the LOQ, the total TEQ value will be higher than 0.060 pg/uL. Accordingly, a straight line (red dashed line in the figure) is drawn on the vertical axis in Fig. 2, and on the horizontal axis and vertical axis in Fig. 3 to mark 0.060 pg/uL.

TEQ 0.025 pg/uL: If a compound with the highest TEF (2,3,7,8-Tetrachlorodibenzo-p-dioxin or 1,2,3,7,8-Pentachlorodibenzo-p-dioxin) is detected at a higher concentration than the lowest point in the calibration curve, the total TEQ value will be higher than 0.025 pg/uL. Accordingly, a straight line (green dashed line in the figure) is drawn on the vertical axis in Fig. 2, and on the horizontal axis and vertical axis in Fig. 3 to mark 0.025 pg/uL.

In order to check the correlation between GC-MS/MS and GC-HRMS, a regression line was calculated with respect to Fig. 3, and a t-test was performed for the slope and intercept. The calculated results are shown in Table 4. The 95 % confidence limits for the intercept and slope are extremely close to 0 and 1, respectively.

Next, the distribution of the TEQ ratios for GC-MS/MS and GC-HRMS was calculated and checked in detail.

Table 5 Distribution of the Ratio of Total TEQ Values for Samples with a TEQ of at Least 0.060 pg/uL

	TEQ Ratio (TQ/Sector) (%)		
	<50	50 - 200	200<
Number of Samples (pc)	2	87	0
Distribution (%)	2	98	0.00

For samples with a TEQ of at least 0.060 pg/uL, when the TEQ ratio (%) was calculated, for at least 98 % of the samples, the ratio was between 50 % and 200 %, indicating a similar TEQ value for both systems. (Table 5)

In contrast, for samples with a TEQ less than 0.060 pg/uL, 79 % of the samples had a ratio between 50 % and 200 %, indicating a significant difference for 21 % of the samples. For many of the samples, the lower the TEQ, the greater the difference. 92 % of the samples with a ratio less than 50 % or more than 200 % had a TEQ less than 0.025 pg/uL. (Table 6)

From the above-mentioned results, it was evident that GC-MS/MS and GC-HRMS provide similar TEQ values for samples with a TEQ higher than 0.060 pg/uL. Additionally, it was evident that the lower the TEQ, the greater the number of samples with a significant difference in TEQ values.

Table 4 Results of the t-Tests for the Intercept and Slope

	Coefficient	Standard Error	t	95 % Confidence Interval	
				Lower Limit	Upper Limit
Intercept	-0.005	0.001	-3.235	-0.008	-0.002
Slope	1.049	0.001	741.500	1.046	1.051

Table 6 Distribution of the Ratio of Total TEQ Values for Samples with a TEQ Less Than 0.060 pg/uL

	TEQ Ratio (TQ/Sector) (%)		
	<50	50 - 200	200<
Number of Samples (pc)	21*	92	4
Distribution (%)	18	79	3

* 19 of the 21 samples with a ratio under 50 % had a TEQ less than 0.025 pg/uL. It was evident that the lower the total TEQ value, the greater the tendency for a difference to arise.

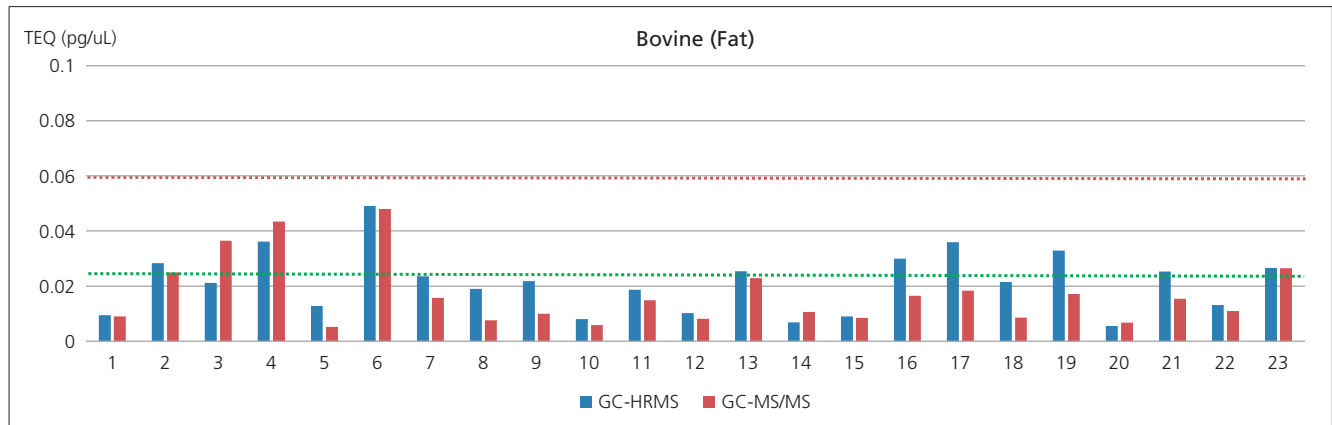
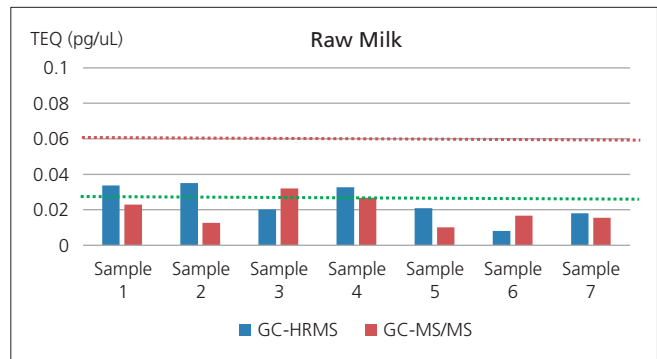
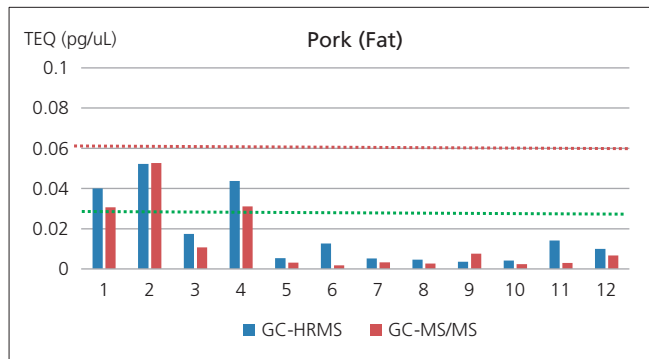

Fig. 2 Comparison of the TEQ Results for Each Food and Feed

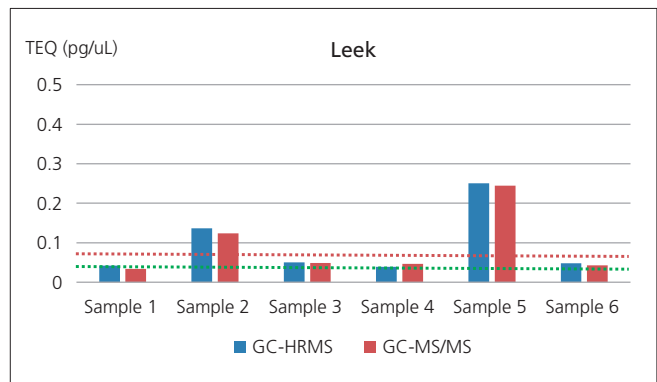
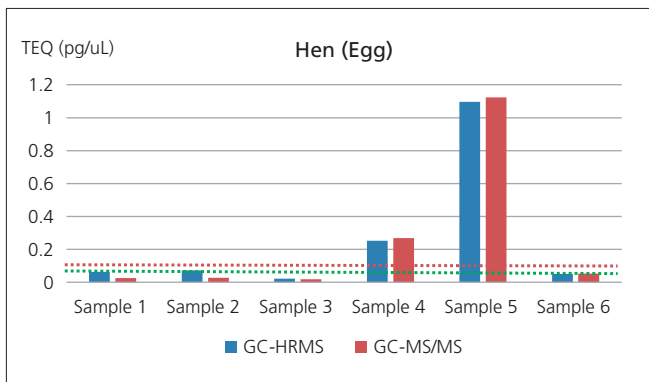
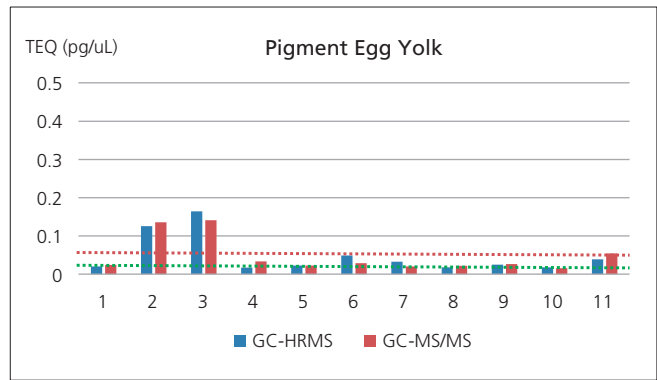
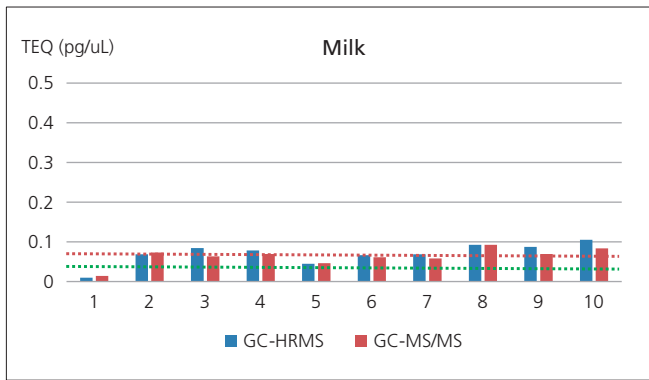
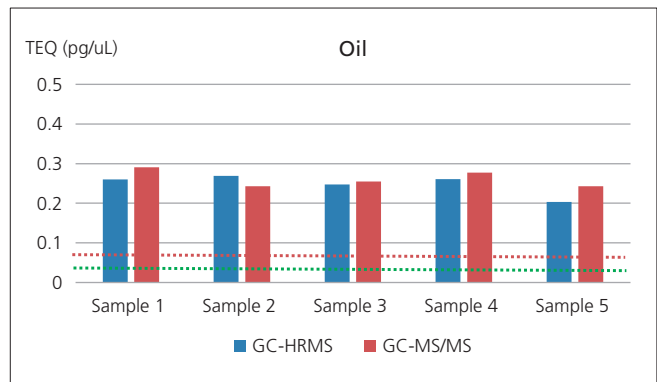
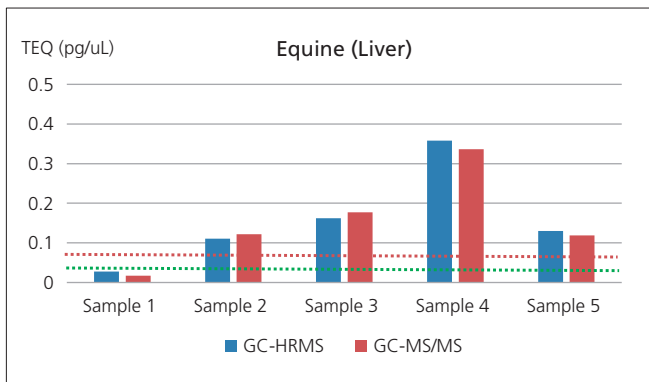
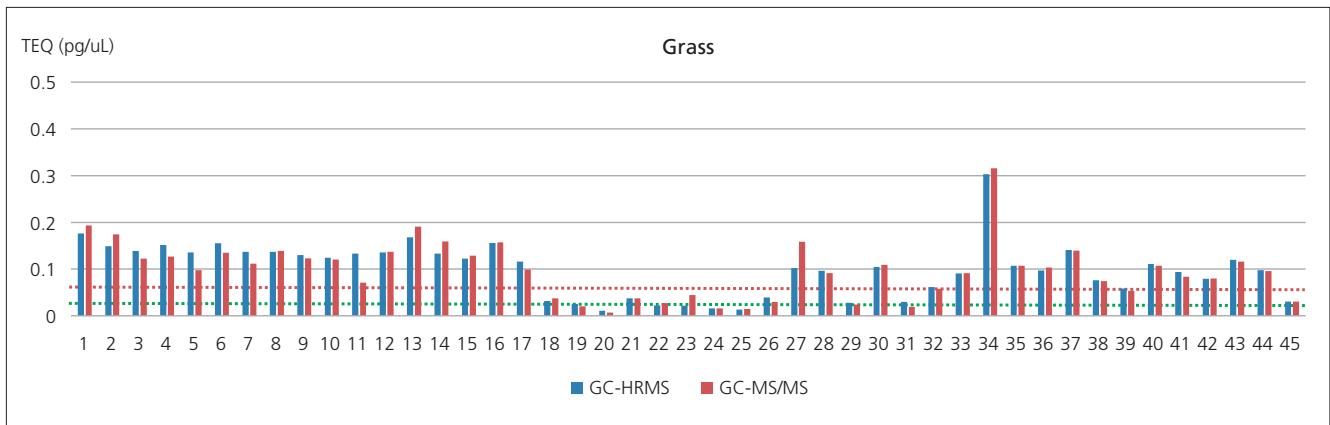

Fig. 2 Comparison of the TEQ Results for Each Food and Feed

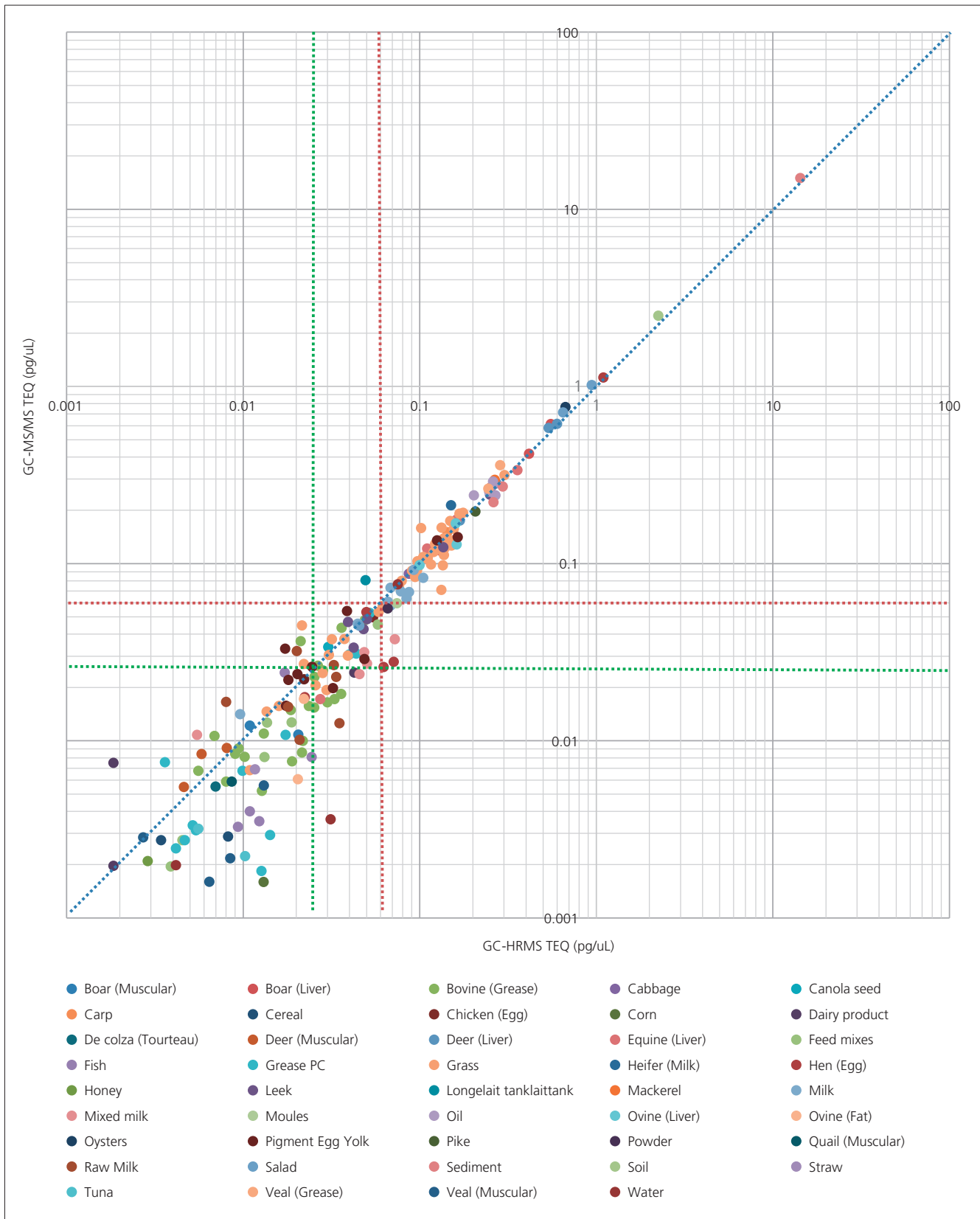

Fig. 3 Comparison of the TEQ Results for Each Food and Feed

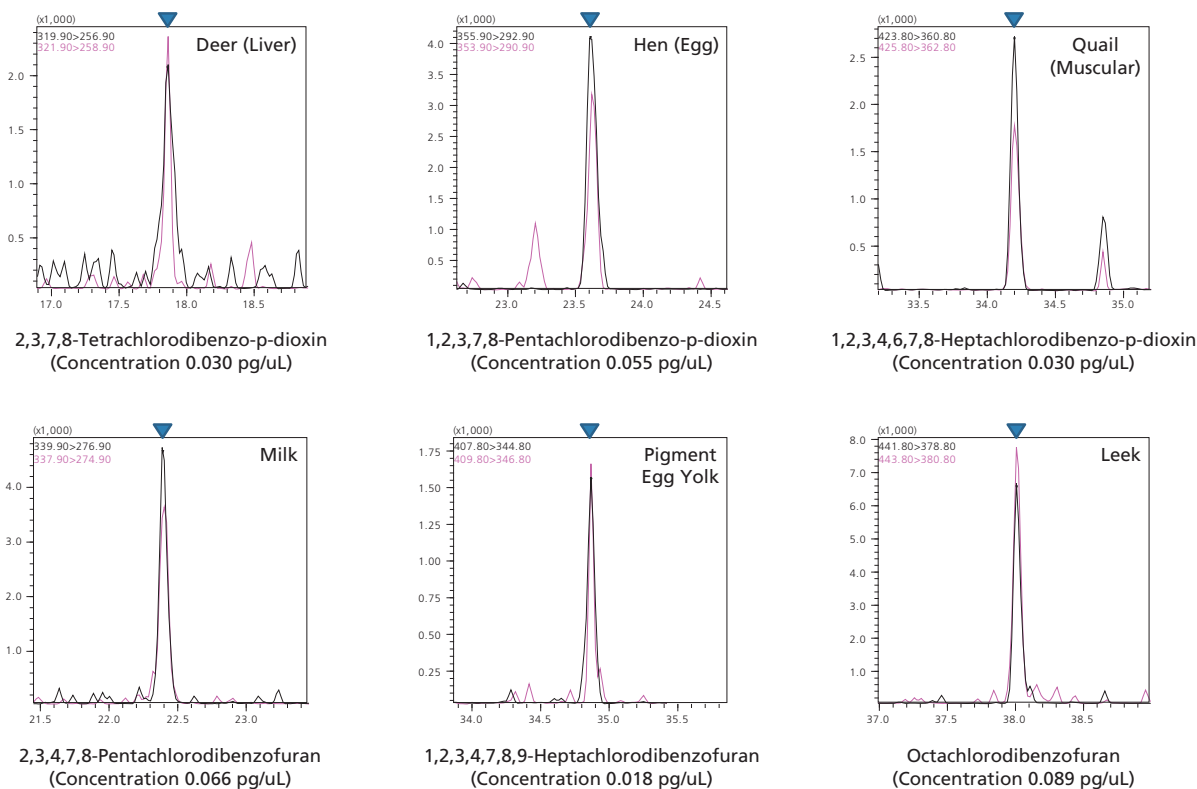

Fig. 4 Chromatograms of Dioxins in Various Samples

5. Conclusion

In this technical report, dioxins were analyzed in 44 types and at least 201 samples of foods and feeds using the GCMS-TQ8050 and the "EU Regulation Compliant GC-MS/MS Method Package for Dioxins in Foods". Additionally, the GC-MS/MS analysis results were compared with the analysis results from GC-HRMS in order to assess the quantitative capabilities of both methods.

Firstly, before analyzing the foods and feeds, a STD was analyzed using GC-MS/MS, and it was confirmed that the criteria were satisfied at the LOQ.

Next, the foods and feeds were analyzed, and the results were compared with those from magnetic sector GC-MS. For the comparison, the TEQ ratio was calculated for GC-MS/MS and GC-HRMS. For samples with a higher TEQ than 0.060 pg/uL (TEQ when any of the com-

pounds was detected at a higher concentration than the LOQ), GC-MS/MS and GC-HRMS provided similar TEQ values in at least 98 % of the samples. Additionally, it was evident that the number of samples with a significant difference in TEQ increases as the TEQ value decreases.

From the above-mentioned results, it is evident that analysis with GCMS-TQ8050 and method package provides a quantitative capability equivalent to that from GC-HRMS for samples at the concentration levels required for analysis. However, at concentrations below the required level, differences in quantitative capability could arise. For this reason, it is necessary to be aware of the system status by confirming quantitative capability at the LOQ, and evaluating whether there has been a decrease in sensitivity.

GCMS-TQ, GCMSsolution and LabSolutions Insight are trademarks of Shimadzu Corporation. Topaz and Rxi are registered trademarks of Restek Corporation.

First Edition: July, 2018



Shimadzu Corporation
www.shimadzu.com/an/

For Research Use Only. Not for use in diagnostic procedures.

This publication may contain references to products that are not available in your country. Please contact us to check the availability of these products in your country.

The content of this publication shall not be reproduced, altered or sold for any commercial purpose without the written approval of Shimadzu. Company names, products/service names and logos used in this publication are trademarks and trade names of Shimadzu Corporation, its subsidiaries or its affiliates, whether or not they are used with trademark symbol "TM" or "®".

Third-party trademarks and trade names may be used in this publication to refer to either the entities or their products/services, whether or not they are used with trademark symbol "TM" or "®".

Shimadzu disclaims any proprietary interest in trademarks and trade names other than its own.

The information contained herein is provided to you "as is" without warranty of any kind including without limitation warranties as to its accuracy or completeness. Shimadzu does not assume any responsibility or liability for any damage, whether direct or indirect, relating to the use of this publication. This publication is based upon the information available to Shimadzu on or before the date of publication, and subject to change without notice.

Application News

No. SCA_210_038

Liquid Chromatography Mass Spectrometry

Sensitive method for the determination of Fipronil in egg using UHPLC-MS/MS [LCMS-8060]

Introduction

The broad-spectrum insecticide Fipronil from the group of phenylpyrazoles is used in many countries as a biocide and plant protection product against fleas, lice, ticks, cockroaches, mites and other insects. The use as plant protection product is restricted to seed treatment in the European Union since 2007. It is also an active compound in veterinary products fighting tick and flea infestations in dogs and cats. But its use in food-producing animals is not permitted. However, due to the illegal use as addition to the cleaning supplies used in poultry farm the eggs, egg products and meat were found to be contaminated in summer 2017 in 15 European countries.

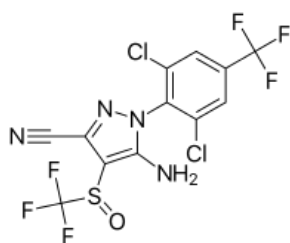

Fipronil

MF $C_{12}H_4Cl_2F_6N_4OS$
MW 437,1 g/mol

Sample preparation

Compound extraction was performed using a simplified QuEChERS (Quick, Easy, Cheap, Effective, Rugged and Safe) method.

5 g of egg (egg white and egg yolk) were weighted into a 50 mL polypropylene tube and spiked with a respective amount of Fipronil (and other pesticides using dilutions of RESTEK LC Multiresidue Pesticide Standard #5, Cat. 31976). 5 mL of acetonitrile was added and the samples were mixed vigorously. After that 2 g of $MgSO_4$ and 0.5 g of NaCl were added, samples were mixed again and centrifuged at 3000 rpm for 5 minutes. The supernatant was transferred into a glass vial.

Materials and methods

Extracts were analyzed using a method set up with Shimadzu LC/MS/MS Method Package for Residual Pesticides Version 2 and a Nexera X2 UHPLC system coupled to a LCMS-8060 mass spectrometer. Analysis was carried out using MRM (Multi Reaction Monitoring) mode.

LC system	Nexera X2 (Shimadzu, Japan)
Analytical column	Raptor Biphenyl™ 100 x 2.1 mm, 2.7 μm (RESTEK)
Column oven temperature	35 °C
Injection volume	2 μl (using POISE*)
Mobile Phase A	2 mM ammonium formate + 0.002% formic acid - Water
Mobile Phase B	2 mM ammonium formate + 0.002% formic acid - Methanol
Mass spectrometer	LCMS-8060 (Shimadzu, Japan)
Interface voltage	-3 kV
Q1 resolution	Unit (0.7 Da FWHM)
Q3 resolution	Unit (0.7 Da FWHM)
Nebulizing gas flow	3 L/min
Drying gas flow	10 L/min
Heating gas flow	10 L/min
DL temperature	150 °C
Heat block temperature	300 °C
Interface Temperature	350 °C

*Performance Optimising Injection Sequence



▪ Calibration

The matrix matched calibration curve (Figure 1) was prepared according to the method described before ranging from 0.025 mg/kg to 2 mg/kg.

Control samples at 0.05 mg/kg and 0.5 mg/kg correspond to the calibration curve. Figure 2 shows a typical chromatogram of the lowest calibration point (0.025 mg/kg)

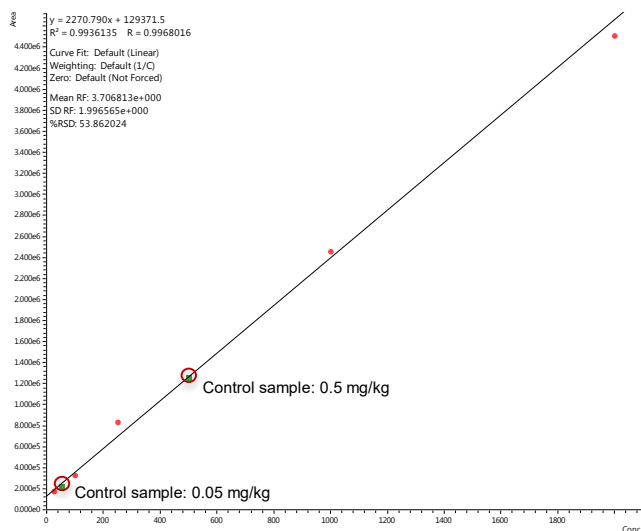

Figure 1: Calibration curve of Fipronil in egg ranging from 0.025 mg/kg to 2 mg/kg

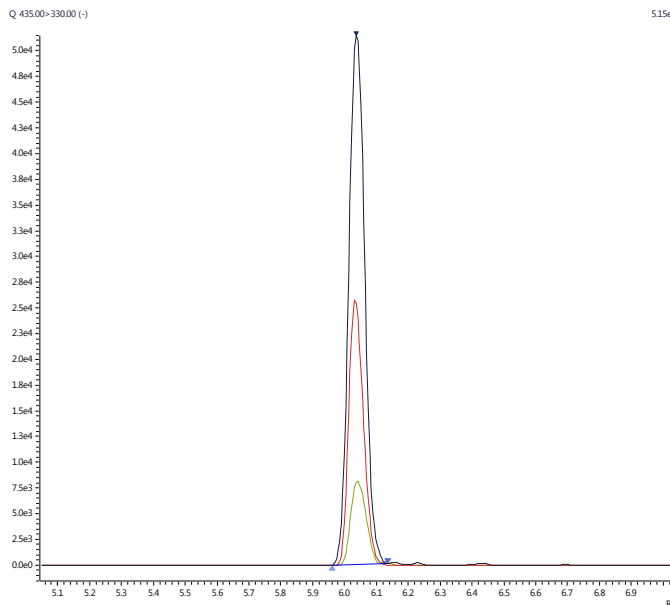

Figure 2: Chromatogram of Fipronil in egg at a concentration of 0.025 mg/kg

▪ Conclusion

By using the LC/MS/MS method package for residual pesticides V2 and a simplified QuEChERS sample preparation a method for the determination of Fipronil in eggs could be set up rapidly without further method development covering the calibration range from 0.025 mg/kg to 2 mg/kg.



Shimadzu Europa GmbH

www.shimadzu.eu

For Research Use Only. Not for use in diagnostic procedures.

This publication may contain references to products that are not available in your country. Please contact us to check the availability of these products in your country.

The content of this publication shall not be reproduced, altered or sold for any commercial purpose without the written approval of Shimadzu. Company names, products/service names and logos used in this publication are trademarks and trade names of Shimadzu Corporation, its subsidiaries or its affiliates, whether or not they are used with trademark symbol "TM" or "®".

Third-party trademarks and trade names may be used in this publication to refer to either the entities or their products/services, whether or not they are used with trademark symbol "TM" or "®".

Shimadzu disclaims any proprietary interest in trademarks and trade names other than its own.

The information contained herein is provided to you "as is" without warranty of any kind including without limitation warranties as to its accuracy or completeness. Shimadzu does not assume any responsibility or liability for any damage, whether direct or indirect, relating to the use of this publication. This publication is based upon the information available to Shimadzu on or before the date of publication, and subject to change without notice.

Application Note

Application Note No.4 (Lifescience)



Lifescience

Food Allergen Test – Application of MultiNA –

Yuji Sogabe

1. What are Allergies?

We have immune functions that protect our bodies by creating antibodies to substances entering the body (antigens) that are foreign and hostile to the body. This is known as the "antigen-antibody reaction" or "immune response." When the same antigen subsequently enters the body, the memorized antibody activates and binds to the antigen to render it harmless.

However, if the immune functions go out of control, excess antibodies can be created or harmful antibodies produced in the body. This imbalance causes allergic diseases. Typical allergic diseases include atopic dermatitis, allergic rhinitis (hay fever, etc.), allergic conjunctivitis, allergic gastroenteritis, asthma, childhood asthma, food allergy, drug allergy, and hives.

Immunity was originally intended to protect the body from harmful substances. However, for people with a certain disposition, the immune function can activate in response to foods, pollen, dust and other substances which are usually harmless. People predisposed to such symptoms are said to have an "allergic predisposition."

When specific substances enter the body of a person with an allergic predisposition, the antibodies act abnormally to cause specific symptoms.

2-1 What are Food Allergies?

A hypersensitive immune reaction resulting from eating specific foods is called a "food allergy." Food allergies can cause a diverse range of symptoms, including skin symptoms such as hives and eczemas; gastrointestinal symptoms such as diarrhea, vomiting, and stomachache; and respiratory symptoms such as coughing and breathing difficulties. In severe cases, food allergies can lead to systemic symptoms, such as anaphylactic shock.

The substances causing food allergies and the amounts required differ from person to person. The reaction also differs according to the person's physical condition. For children, in particular, food allergies are often caused by the so-called "three major allergens": eggs, milk, and wheat. Of these, chicken eggs are the major cause of food allergies. Other causes are fish (in particular, blue-backed fish), meat (in particular, pork), shellfish, shrimp, crab, soybeans, cereals, and buckwheat.

Food allergies are mainly caused by proteins derived from the ingredients in the food. The three major allergens – eggs, milk, and wheat – are all foods with a high protein content. Normally, the proteins in foods are broken down in the stomach and intestines and absorbed as amino acids and peptides (several amino acids linked together). These small molecules do not normally cause allergies.

However, when the digestive tract and its functions are immature during infancy, inadequately digested proteins (oligopeptides) are often absorbed and are said to cause many food allergies. When the digestive functions are suppressed during illness, in particular, more undigested substances than normal pass through the digestive tract. As a result, undigested substances are more frequently absorbed and the incidence of allergies also increases.

The 2005 Ministry of Health, Labour and Welfare Science Research Report (Fig. 1) of Japan lists the following incidences of food allergies:

1. Eggs (38 % of total)
2. Dairy products (16 % of total)
3. Wheat (8 % of total)
4. Fruit (6 % of total)
5. Buckwheat (5 % of total)
6. Shrimp (4 % of total)
7. Peanuts (3 % of total)

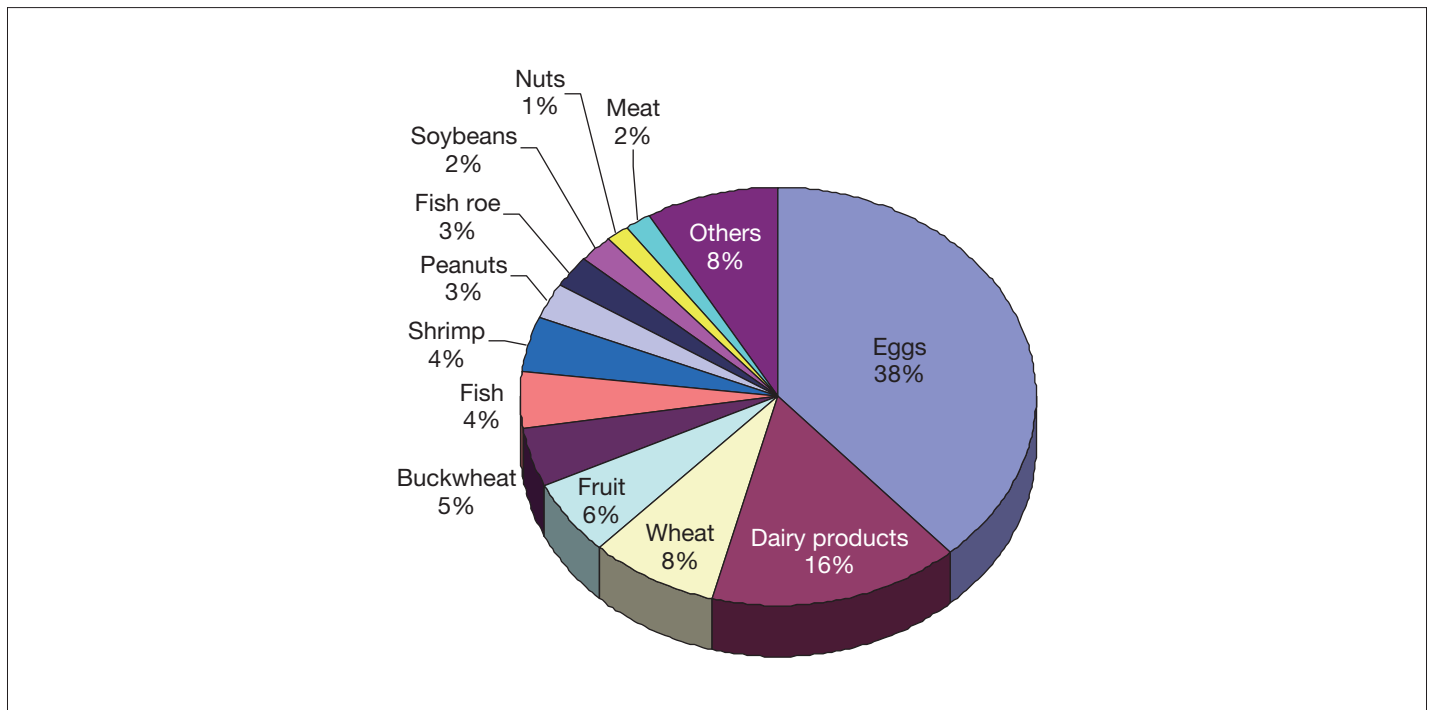

Fig. 1 Proportions of Foods Causing Allergies (source: 2005 Ministry of Health, Labour and Welfare Science Research Report of Japan)

3. Food Labeling

Japan was the world's earliest adopter of a labeling system for foods containing allergens (see Fig. 2).

The labeling of foods containing allergens is categorized into "Mandatory" (7 specified ingredients) and "Recommended" (18 specified ingredients).

Of the foods discovered to cause allergies in recent investigations, the five items with a high incidence or severity – eggs, milk, wheat, buckwheat, and peanuts – were prescribed as "specified ingredients" under the Japanese Ordinance for Enforcement of the Food Sanitation Act. Foods containing these ingredients were subject to mandatory labeling from April 2002. Two more items were added from June 2008: shrimp and crab. Labeling is required for foods containing 10 µg/g or higher of these seven specified ingredients, even if they are impurities mixed in during the manufacturing process. Labeling the possibility that the items could be included, such as "May contain xxx," is not permitted.

Eighteen other items for which labeling is recommended (items corresponding to specified ingredients) have been notified: abalone, squid, salmon roe, orange, kiwi fruit, beef, walnuts, salmon, mackerel, soybeans, chicken, banana, pork, matsutake mushroom, peach, yam, apple, and gelatin (Table 1). Labeling is intended to provide information to consumers to avoid health hazards due to allergies. Consequently, labeling must inform of even trace levels of specified ingredients contained in or mixed in a food product.

(*However, mandatory labeling of manufactured, processed, or imported food products was deferred to 3 June 2010.)

Recently, more and more food companies are producing products free of egg, milk, wheat, buckwheat, peanuts and other allergens. They implement strict product development, ingredient selection, production line cleaning (and subsequent checks), and inspections of individual production lots (according to the official method prescribed by the Japanese Ministry of Health, Labour and Welfare).

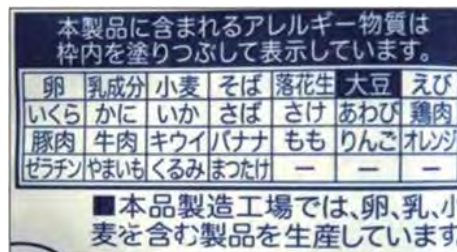

This product contains the allergens in the highlighted frames below.

Egg	Milk	Wheat	Buckwheat	Peanuts	Soybeans	Shrimp
Salmon roe	Crab	Squid	Mackerel	Salmon	Abalone	Chicken
Pork	Beef	Kiwi fruit	Banana	Peach	Apple	Orange
Gelatin	Yam	Walnuts	Matsutake mushroom	-	-	-

■ The factory that produced this product manufactures products containing egg, milk, and wheat.

Fig. 2 Example of Labeling

Table 1 Items Labeled as Allergens

(Source: March 2009 revision of "Handbook for Labeling of Processed Foods Containing Allergens," Japanese Ministry of Health, Labour and Welfare)

Labelling	Term	Name
Mandatory	Specified ingredients (7 items)	Egg, milk, wheat, buckwheat, peanuts, shrimp, crab
Recommended	Items pursuant to specified ingredients (18 items)	Abalone, squid, salmon roe, orange, kiwi fruit, beef, walnuts, salmon, mackerel, soybeans, chicken, banana, pork, matsutake mushroom, peach, yam, apple, and gelatin

*The scope of the specified ingredients is basically the range designated by the numbers in the Japan Standard Commodity Classification (JSCC). (For more details, see the March 2009 revision of "Handbook for Labeling of Processed Foods Containing Allergens," Japanese Ministry of Health, Labour and Welfare.)

4. Analysis of Allergenic Substances

Test methods have been established for 20 items: egg, milk, wheat, buckwheat, peanuts, shrimp, crab, abalone, squid, kiwi fruit, beef, walnuts, salmon, mackerel, soybeans, chicken, pork, yam, apple, and banana. These test methods are included in the Japanese Ministry of Health, Labour and Welfare Notification "Regarding the testing method for foods containing allergenic substances," No. 0622003 issued by the Dept. of Food Safety, June 22, 2006.

Test methods for proteins derived from specified ingredients in foods include the ELISA method (*1) based on antigen-antibody reactions for quantitative analysis, Western blotting method (*2) for qualitative analysis, and PCR method (*3) (Table 2).

The ELISA quantitative test method is used for the screening of the seven specified ingredients – egg, milk, wheat, buckwheat, peanuts, shrimp, crab – as well as soybeans, which are listed as items corresponding to specified ingredients.

Western blotting method is generally used for the qualitative analysis of egg and milk.

The polymerase chain reaction (PCR) method uses specific sequences for the confirmation testing of the specified ingredients wheat, buckwheat, peanuts, shrimp, and crab (excluding egg and milk) and for soybeans, beef, pork, chicken, salmon, mackerel, abalone, squid, kiwi fruit, walnuts, yam, apple, and banana that are items corresponding to specified ingredients.

Table 2 Test Methods of Allergen

Test Method	Application
ELISA	Screening (quantitative)
Western blotting	Confirmation testing (qualitative)
PCR	Confirmation testing (qualitative)

(*1) ELISA (Enzyme-Linked ImmunoSorbent Assay) Method

The Enzyme-Linked ImmunoSorbent Assay is an analysis method that combines an immunoreaction (antigen-antibody reaction) and an enzyme-substrate reaction. This method is used to detect and quantify the concentration of antibodies and antigens contained in the sample. This method is known as ELISA.

(*2) Western Blotting Method

After separating a sample by electrophoresis, it is transferred and bound to a membrane. It is reacted with an antibody (primary antibody) for the protein of interest. A secondary enzyme-marked antibody is reacted with the primary antibody and the target substance is detected through luminescence or fluorescence.

(*3) Polymerase Chain Reaction (PCR) Method

This method selectively amplifies part of the DNA, using the sample DNA as a template. Cycle reactions (separation of double-stranded DNA → primer binding → DNA synthesis) are performed using a primer (short sequence-specific single-stranded DNA with each end of the region to be amplified) and DNA polymerase to amplify the required DNA region. In principle, even a single DNA molecule can be amplified in multiples of the number of reaction cycles. The presence of the substance of interest can be evaluated from whether the regions straddling the primer are amplified.

Table 3 summarizes the test methods applicable for each item.

Table 3 Test Methods for Each Item

	Item	Test Method
Specified Ingredients Mandatory Labeling	Egg	ELISA, Western blotting
	Milk	ELISA, Western blotting
	Wheat	ELISA, PCR
	Buckwheat	ELISA, PCR
	Peanuts	ELISA, PCR
	Shrimp	ELISA, PCR
	Crab	ELISA, PCR
Items Corresponding to Specified Ingredients Recommended Labeling	Soybeans	ELISA, PCR
	Beef	PCR
	Pork	PCR
	Chicken	PCR
	Salmon	PCR
	Mackerel	PCR
	Abalone	PCR
	Squid	PCR
	Kiwi fruit	PCR
	Walnuts	PCR
	Yam	PCR
	Apple	PCR
	Banana	PCR

5. Analysis by PCR

1) Extracting and Purifying DNA from Food Samples

The extraction and purification of DNA can be performed by the cetyltrimethylammonium bromide surfactant (CTAB) method or methods using a silica gel membrane or ion-exchange resin. Each method has its own characteristics. The CTAB method makes it difficult for PCR inhibitors to remain in the food. Commercial kits are available for extraction and purification methods using a silica gel membrane or ion-exchange resin, making them relatively simple to perform.

The CTAB method is applicable to test samples with a low degree of processing, such as wheat flour or buckwheat flour. Methods using a silica gel membrane or ion-exchange resin are applicable to test samples subjected to a high degree of processing, including sweetening, oil treatment, hot mixing, or fermentation.

2) Confirming DNA Purification and Quantitation

The extracted and purified DNA sample solution is diluted ten times and the absorbance measured at 230 nm, 260 nm, and 280 nm. In principle, the DNA sample solution is prepared at 20 ng/μL concentration.

3) PCR

The base sequence region of interest contained in the extracted and purified DNA is amplified by performing polymerase chain reaction (PCR) using the appropriate organism-specific primer (Table 4). These amplification

products are separated and detected by electrophoresis to determine the absence or presence of the specified ingredient in the inspected sample. Fig. 3 shows the detection procedure.

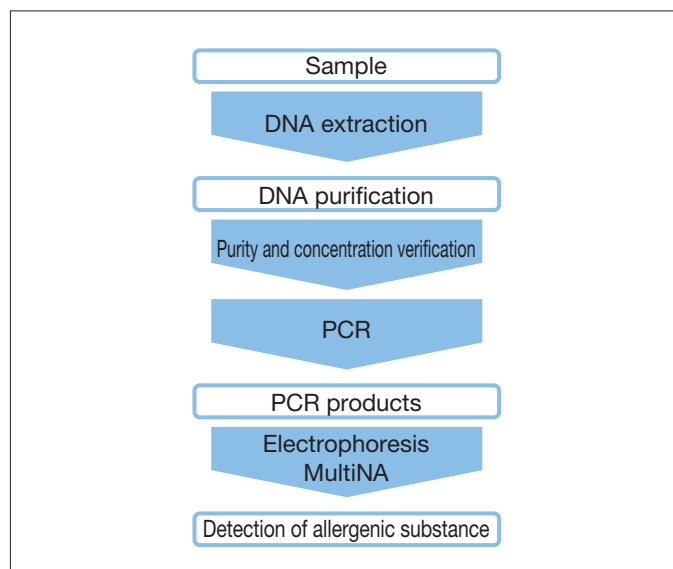

Fig. 3 Experimental Procedure for Detection of Allergenic Substances

Table 4 Primers for Enzyme Detection

Japanese Ministry of Health, Labour and Welfare Notification "Regarding the testing method for foods containing allergenic substances," No. 0724, Publication No. 1 issued by the Dept. of Food Safety, July 24, 2009 (See Note)

	Plant DNA	Animal DNA	Wheat	Buckwheat	Peanuts	Shrimp	Crab
PCR Amplification Product Size (bp)	124	370-470	141	127	95	187	62
	F-Primer			R-Prime			
Plant DNA	CP03-5' : 5'-CGG ACG AGA ATA AAG ATA GAG T-3'			CP03-3' : 5'-TTT TGG GGA TAG AGG GAC TTG A-3'			
Animal DNA	AN1-5': 5'-TGA CCG TGC GAA GGT AGC-3' AN2-5': 5'-TAA CTG TGC TAA GGT AGC-3' Use 1:1 mixture of AN1-5' and AN2-5'.			AN-3' : 5'-CTT AAT TCA ACA TCG AGG TC-3'			
Wheat	Wtr01-5' : 5'-CAT CAC AAT CAA CTT ATG GTG G-3'			Wtr10-3' : 5'-TTT GGG AGT TGA GAC GGG TTA-3'			
Buckwheat	FAG19-5' : 5'-AAC GCC ATA ACC AGC CCG ATT-3'			FAG22-3' : 5'-CCT CCT GCC TCC CAT TCT TC-3'			
Peanuts	agg04-5' : 5'-CGA AGG AAA CCC CGC AAT AAA T-3			agg05-3' : 5'-CGA CGC TAT TTA CCT TGT TGA G-3'			
Shrimp	ShH12-05' : 5'-TTA TAT AAA GTC TRG CCT GCC-3' ShH12-05' is synthesized as A and G mixed bases (R) to the 8th base from the 3' terminal.			ShH13-03'-1: 5'-GTC CCT CTA GAA CAT TTA AGC CTT TTC-3' ShH13-03'-2: 5'-GTC CCT TTA TAC TAT TTA AGC CTT TTC-3' ShH13-03'-3: 5'-GTC CCC CCA AAT TAT TTA AGC CTT TTC-3 Use a 1:1:1 mixture of ShH13-03'-1, ShH13-03'-2, and ShH13-03'-3.			
Crab	CrH16-05'-1: 5'-GCG TTA TTT TTT TTG AGA GTT CWT ATC GTA-3' CrH16-05'-2: 5'-GCG TAA TTT TTT CTG AGA GTT CTT ATC ATA-3' CrH16-05'-3: 5'-GCG TTA TTT TTT TTA AGA GTA CWT ATC GTA-3' CrH16-05'-4: 5'-GCG TTA TTT CTT TTG AGA GCT CAT ATC GTA-3' CrH16-05'-1 and CrH16-05'-3 are synthesized as A and T mixed bases (W) to the 8th base from the 3' terminal. Use a 10:1:6:3 mixture of CrH16-05'-1, CrH16-05'-2, CrH16-05'-3, and CrH16-05'-4.			CrH11-03' : 5'-TTT AAT TCA ACA TCG AGG TCG CAA AGT-3'			

* The amplification products of Shanghai hairy crab, Dungeness crab, giant spider crab, red queen crab, deep sea red crab, or swimming crab may be detected by PCR for shrimp. If it is unknown whether the amplification products obtained are derived from shrimp or crab, they can be identified by performing restriction enzyme digestion on the PCR products. For details, see the Japanese Ministry of Health, Labour and Welfare Notification "Regarding the testing method for foods containing allergenic substances."

Note) See rear cover for details.

6. MCE-202 MultiNA Microchip Electrophoresis System

The long series of operations required for agarose gel electrophoresis – reagent preparation, gel preparation, electrophoresis, acquiring result images, and clean-up – requires a lot of time and effort. Moreover, the data obtained is objectively poor in terms of sensitivity, separation, reproducibility, and quantitiveness.

The MCE-202 MultiNA Microchip Electrophoresis System overcomes the problems with agarose gel electrophoresis.



Fig. 4 MultiNA Microchip



Fig. 5 MultiNA Reagent Kit

Features of MultiNA

- Microchip electrophoresis by MultiNA offers superior sensitivity, separation, reproducibility, and quantitiveness to agarose gel electrophoresis.
- Simply load the samples and reagents for automated, unmanned analysis of up to 120 samples. Pretreatment and electrophoresis proceed in parallel to achieve an analysis time of just 80 s (*) per sample.
- MultiNA offers extremely easy analysis operation. Once the analysis schedule is created, simply load the samples and reagents and click the Start button.
- Reusable high-performance microchip achieves running costs equal to or lower than agarose gel electrophoresis.

(*) DNA standard analysis (DNA-100 kit/Pre-Mix mode) using four microchips.
However, this time does not include the times for initial and subsequent rinsing or the time for initial analysis.

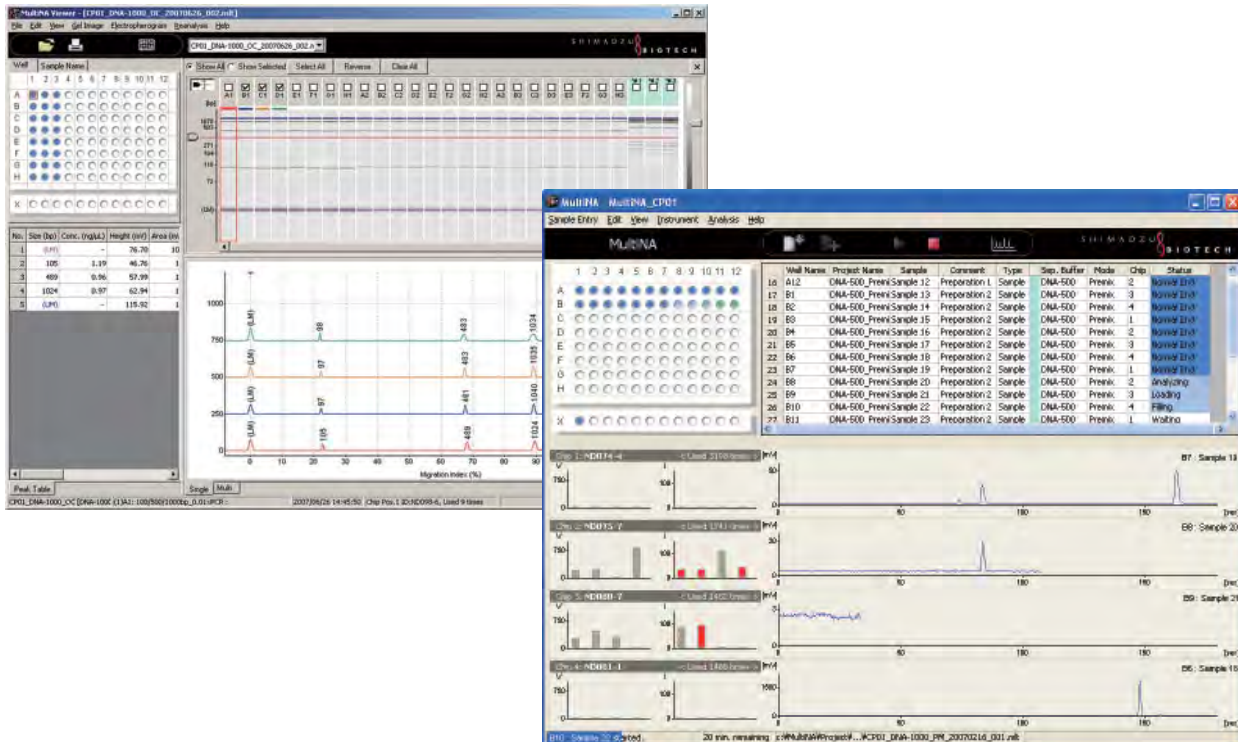

Fig. 6 MultiNA Operation Screen

7. Detection of Allergenic Substances Using MCE-202 MultiNA Microchip Electrophoresis System

7. Detection of Allergenic Substances Using MCE-202 MultiNA Microchip Electrophoresis System

The results of analysis of the PCR amplification products of DNA derived from wheat, buckwheat, peanuts, shrimp and crab, respectively, using the MultiNA are shown in Fig. 7. The PCR amplification products derived from the wheat, buckwheat, peanuts, shrimp and crab substances were all clearly detected using the MultiNA. (The estimated sizes shown in the figure were obtained in this experiment.)

The results of analysis by agarose gel electrophoresis of the same PCR amplification products are shown in Fig.8 [Reference]. The sizes of the PCR amplification

products are imprecise, resulting in the lack of objectivity in interpreting the gel electrophoresis. However, the results obtained using the MultiNA consist of an electropherogram (Fig. 7-b) in addition to a gel image (Fig. 7-a), ensuring a high level of accuracy. Despite the proximity of the wheat and buckwheat amplification products, they could be separated. Compared to agarose gel electrophoresis, the MultiNA's excellent resolution and sensitivity allow these to be clearly detected.

Fig. 9 shows a photograph of the MCE-202 MultiNA Microchip Electrophoresis System.

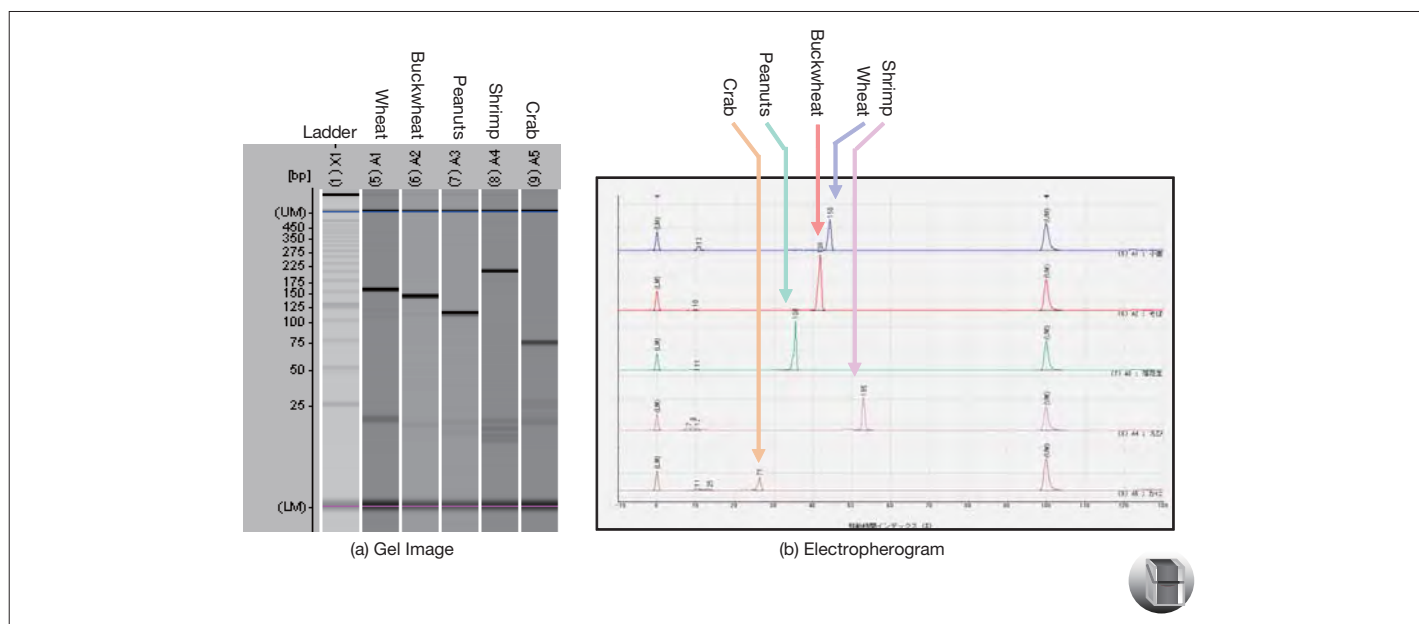

Fig. 7 Analytical Results for PCR Products from Allergenic Substances

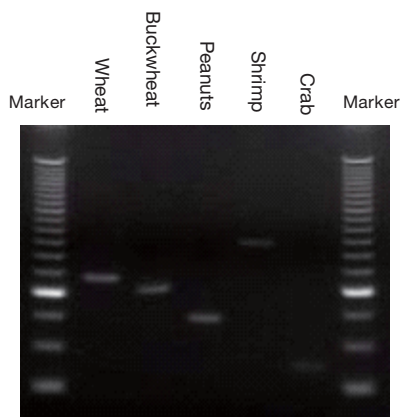

Fig. 8 [Reference] Agarose Gel Electrophoresis of PCR Products from Allergenic Substances



Fig. 9 MCE-202 MultiNA Microchip Electrophoresis System

References:

- "Regarding the testing method for foods containing allergenic substances," No. 0724, Publication No. 1, the Dept. of Food Safety, Ministry of Health, Labour and Welfare of Japan, July 24, 2009
- "Handbook for Labeling of Processed Foods Containing Allergens," Japanese Ministry of Health, Labour and Welfare, March 2009 revision
- "What You Need to Know About Food Labeling," Japanese Ministry of Health, Labour and Welfare, Japanese Ministry of Agriculture, Forestry and Fisheries, Japan Fair Trade Commission, March 2009

Note)

Separate arrangements are required for contract testing using the primers described above for commercial applications on behalf of analytical laboratories, with the exception of public institutions.
Contact the appropriate company below. The synthesis and application of these primers for research applications is unrestricted.

- Animal: Nissin Food Products Co., Ltd.
- Wheat, buckwheat, soybeans: Nisshin Seifun Group Inc.
- Shrimp, crab: House Foods Corporation

* MCE[®]-202 MultiNA is not available in the United States.

* This document is based on information valid at the time of publication. It may be changed without notice.



SHIMADZU CORPORATION, International Marketing Division

3, Kanda-Nishikicho 1-chome, Chiyoda-ku, Tokyo 101-8448, Japan Phone: 81(3)3219-5641 Fax: 81(3)3219-5710
Cable Add.: SHIMADZU TOKYO

3295-07010-PDF-IK

Application News

No. C141

Liquid Chromatography Mass Spectrometry

High Sensitivity Analysis of Peanut Allergen in Cumin and Spice Mix [LCMS-8060]

Food allergens are a major public health concern. Among them, peanut allergy is one of the common food allergies. To avoid unexpected contact with food allergens, food labels are strictly used to indicate the presence of specific allergens. With the increasing awareness of food allergies, the presence of undeclared peanut in cumin lead to huge recalls in recent years. Although ELISA is the most commonly used technique to detect allergens, its false-positive rate is a major concern due to its cross-reactivity. We developed a method with high specificity and sensitivity to overcome this issue by using a high sensitivity triple quadrupole mass spectrometer to detect peanut allergen Ara h1 (Fig. 1) in commercially available spices and seasonings.

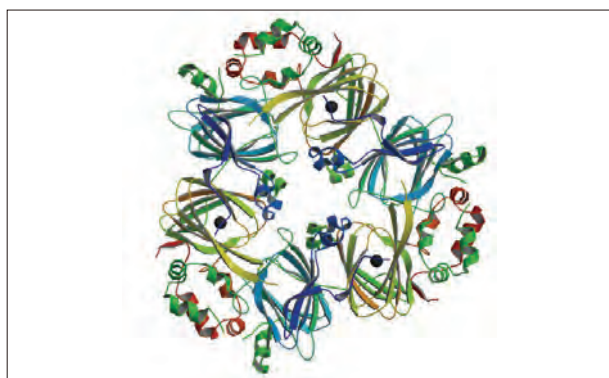

Fig. 1 Structure of Ara h1 [357I] (68kDa) Vicilin Like Protein

■ Sample Preparation

Commercially available defatted peanut flour was purchased and used for the initial development work. The test samples were ground and protein content was enriched by liquid-liquid extraction. Extracted proteins were denatured, reduced and alkylated before subjecting to tryptic digestion to obtain peptides that were quantitated as proxies of original protein abundance.

Cinnamon, cumin, chilli pepper, ginger, garlic, mustard seed, nutmeg, oregano, rosemary, sage, turmeric and thyme were selected as test food samples for evaluating cross-reactivity and sensitivity of the developed method. Food samples were pretreated as above with or without 2 ppm peanut powder.

■ Selection of MRM Transitions Using Skyline

Ara h1 is known as is known as the sensitizing allergen in 95 % of peanut allergy. Tryptic digest of protein extracted from peanuts were analyzed by monitoring theoretically calculated transitions of peptides based on amino acid sequences of two clones P17 and P41B of Ara h1.

MRM transitions for each clone was determined by using Skyline (MacCoss Lab Software). The transition list, which contained more than ten peptides for each clone, was reviewed by removing several peptides that could be susceptible by post translational modification and Maillard reaction during food processing. Finally, nine peptides including three common peptides to both clones were selected based on sensitivity. Three transitions were set for each peptide.

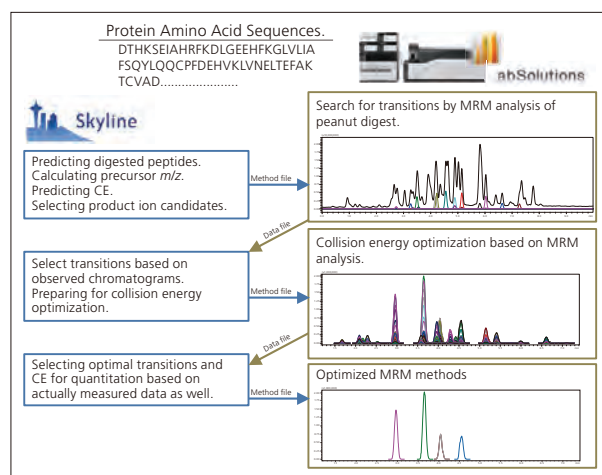

Fig. 2 Workflow of MRM Transition Optimization Using Skyline

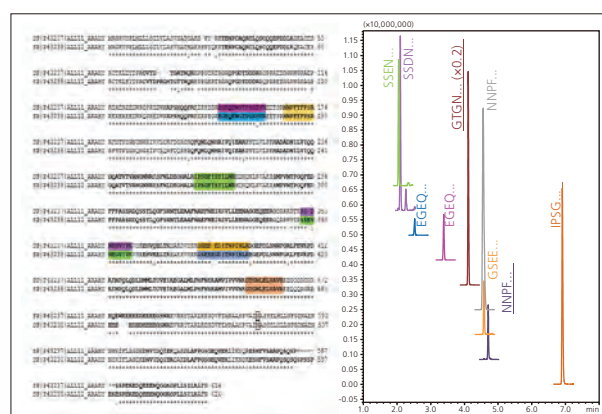

Fig. 3 AA Sequences of P17/P41B and Nine MRM Chromatograms

Table 1 Analytical Conditions

System	: Nexera X2	System	: LCMS-8060
Column	: Shim-pack XR-ODS II (50 mm L. x 2 mm I.D., 1.6 μm)	Ionization	: Heated ESI
Column Temperature	: 40 °C	Probe Voltage	: +1 kV (positive ionization)
Mobile Phases	: A: Water + 0.1 % formic acid B: Acetonitrile	Temperature	: Interface: 250 °C Desolvation Line: 150 °C Heater Block: 200 °C
Flowrate	: 500 μL/min	Gas Flow	: Nebulizing Gas: 3 L/min Heating Gas: 20 L/min Drying Gas: 5 L/min
Gradient	: 2 %B (0.00 min) > 25 %B (7.00 min) > 95 %B (7.10-8.00 min) > 2 %B (8.10-10.00 min)		
Injection Volume	: 10 μL		

Table 2 MS/MS Acquisition Parameters

MRM Transitions	Name	Polarity	Quan	Qual1	Qual2
	EGEQEWGTPGSEVR	+	780.85 > 802.40	780.85 > 644.35	780.85 > 316.10
	NNPFYFPSR	+	571.25 > 669.35	571.25 > 506.25	571.25 > 229.10
	IPSGFISYILNR	+	690.40 > 765.45	690.40 > 211.15	690.40 > 502.25
	SSDNEGVIK	+	524.25 > 515.35	524.25 > 359.25	524.25 > 175.05
	GSEEDITNPINLR	+	793.90 > 726.45	793.90 > 612.40	793.90 > 402.25
	GTGNLELVAVR	+	564.80 > 686.40	564.80 > 557.40	564.80 > 444.30
	EGEQEWGTPGSHVR	+	784.85 > 652.35	784.85 > 555.30	784.85 > 316.10
	SSENNEGVIK	+	588.30 > 515.35	588.30 > 359.25	588.30 > 246.20
	GSEEGDITNPINLR	+	822.40 > 726.45	822.40 > 612.40	822.40 > 402.25

Dwell Time : 41 to 130 msec depending upon the number of concomitant transitions to ensure to have at least 15 points per peak (max total loop time 400 msec).

Pause Time : 3 msec

CID Pressure : 300 kPa

Quadrupole Resolution : Q1: Unit Q3: Unit

Interface Optimization

Ionization parameters optimization was performed using companion software ISSS (Interface Setting Support Software, Shimadzu Corp.). As a result, sensitivity was improved more than twofold compared to default values.

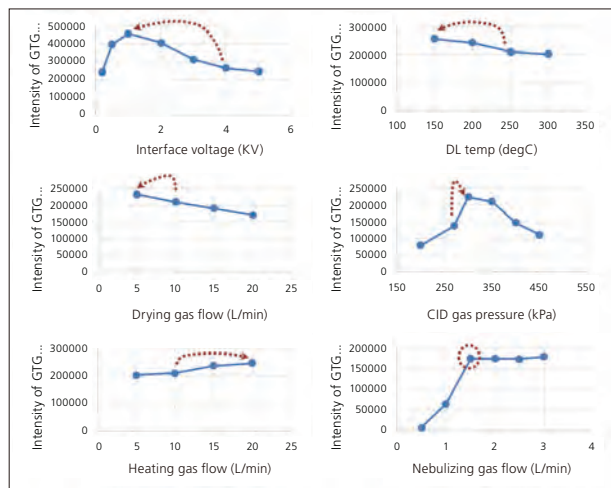

Fig. 4 Interface Optimization Results

Effect of Surfactant During Digestion

A higher intensity of peptides by addition of a surfactant during tryptic digestion was expected due to improved digestion efficiency. However, the intensity of peptides were relatively worse by adding surfactant. Thus, no surfactant was used for tryptic digestion.

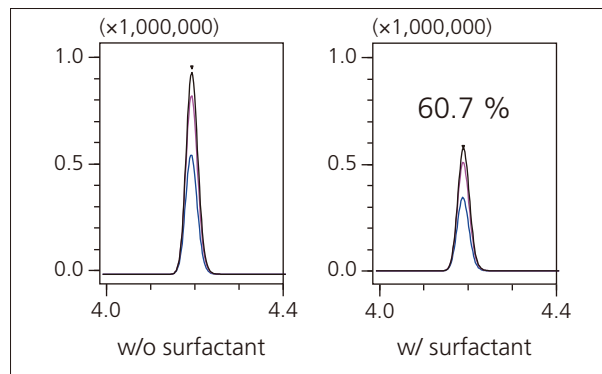

Fig. 5 Difference of the Chromatograms of Peptide GTG... by Addition of Surfactant

■ **Peanut Allergen in Other Nuts**

Walnuts, cashew nuts, and almonds were analyzed to test specificity. These nuts were spiked with 2 ppm (2 mg/kg) of peanut before sample preparation. The spiked peanut peptides were successfully detected and any obvious peak was detected in blank samples.

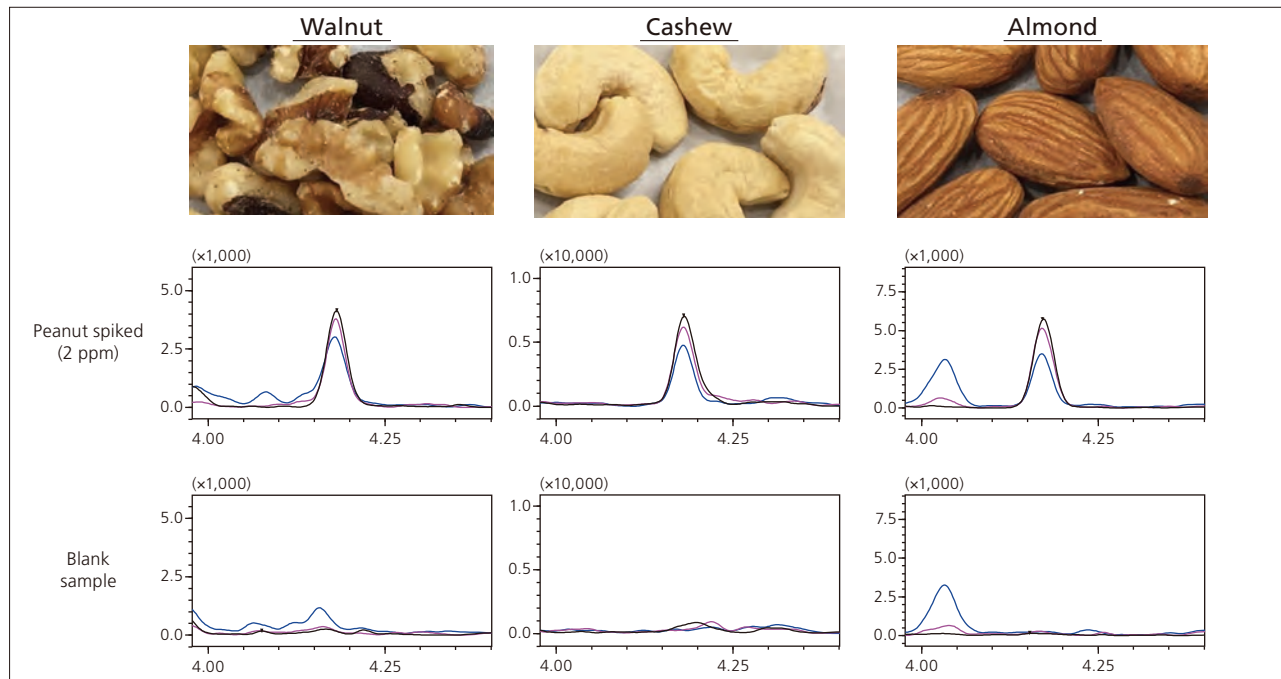

Fig. 6 Chromatograms of Peptide GTG... in Other Kind of Nuts With or Without Spiking with Peanuts

■ **Detection of ARA h1 in Spice Mixes and Seasonings**

Several spice mixes and seasonings were analyzed using sample preparation and analytical conditions described here. Peaks of tryptic peptides of Ara h1 from samples without spiking of peanut peptides were detected.

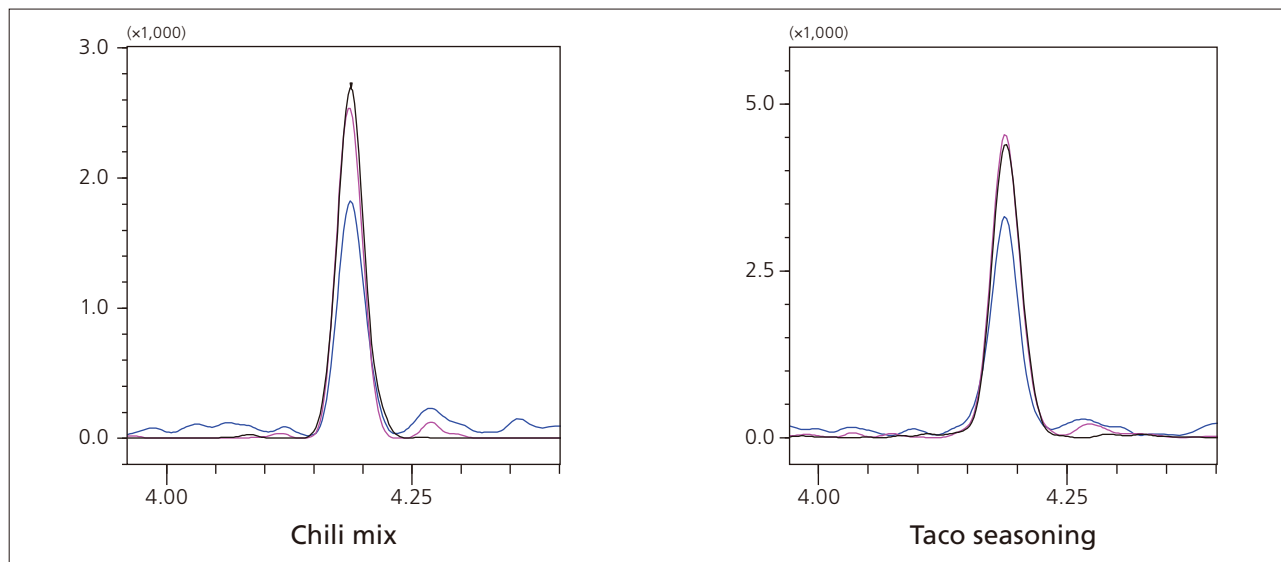

Fig. 7 Detected Peaks of Peptide GTG... in Chili Mix and Seasoning

■ Peanut Allergen in Spices

Contaminated spice samples were prepared and analyzed to confirm that the low amount of peanuts added into the various spices can be detected. Peptides of Ara h1 were successfully observed from the spice samples spiked with 2 ppm of peanuts. It was also confirmed that there are no obvious false-positive peaks from the blank samples.

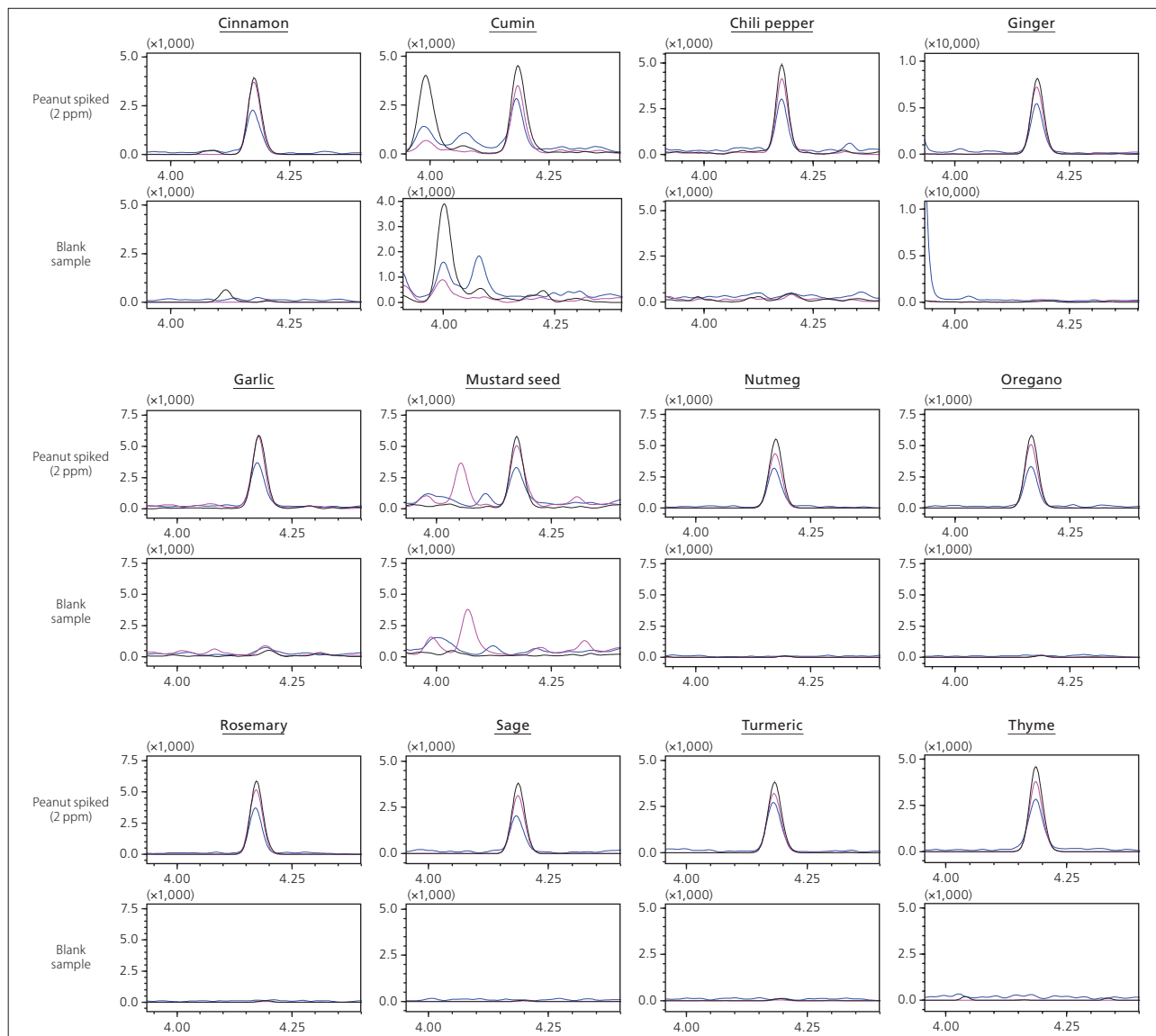

Fig. 8 Chromatograms of Peptide GTG... in Spices With or Without Spiking with Peanuts

■ Conclusion

A method for the analysis of Ara h1 in spices and seasonings was successfully developed. The combination of the developed method and a high sensitivity triple quadrupole mass spectrometer enabled the detection of 2 ppm or lower of peanut allergen Ara h1 in spices and seasonings.

First Edition: Dec. 2016



For Research Use Only. Not for use in diagnostic procedure.

This publication may contain references to products that are not available in your country. Please contact us to check the availability of these products in your country.

The content of this publication shall not be reproduced, altered or sold for any commercial purpose without the written approval of Shimadzu. Company names, product/service names and logos used in this publication are trademarks and trade names of Shimadzu Corporation or its affiliates, whether or not they are used with trademark symbol "TM" or "®". Third-party trademarks and trade names may be used in this publication to refer to either the entities or their products/services. Shimadzu disclaims any proprietary interest in trademarks and trade names other than its own.

The information contained herein is provided to you "as is" without warranty of any kind including without limitation warranties as to its accuracy or completeness. Shimadzu does not assume any responsibility or liability for any damage, whether direct or indirect, relating to the use of this publication. This publication is based upon the information available to Shimadzu on or before the date of publication, and subject to change without notice.

Shimadzu Corporation
www.shimadzu.com/an/

Simultaneous analysis of major allergens in food matrices by high sensitive mass spectrometer

ASMS 2017 TP 202

Tairo Ogura¹
Shimadzu Scientific Instruments, Inc. Columbia, MD, USA

Simultaneous analysis of major allergens in food matrices by high sensitive mass spectrometer

Introduction

Food allergy is an abnormal overreaction of immune system to a particular protein in food. It is becoming a major concern for public health and food industries. Typical food allergens are proteins and peptides. The signs and symptoms may range widely from itching, red skin, swelling, anaphylaxis etc. There is no cure for food allergy at present, so people with allergy must avoid food triggers. To avoid unexpected contact with food allergens, food labels are strictly used to indicate presence of specific allergens. The Food Allergen Labeling and Consumer Protection Act (FALCPA) identified eight foods or food groups as major allergens which include milk, eggs, fish (e.g., bass, flounder, cod), crustacean shellfish (e.g., crab, lobster, shrimp), tree nuts (e.g., almonds, walnuts, pecans), peanuts, wheat and soybeans and FALCPA mandates that the labels of foods containing eight major food allergens declare the presence of allergens. ELISA (enzyme-linked immunosorbent assay) and PCR (Polymerase chain reaction) are most commonly used technique to detect allergenic foods due to relatively simple handling. Even so,

cross-reactivity of ELISA can raise a the risk of false positive results. Additionally, ELISA requires separated analysis for each target. Since PCR assay is based on detection of DNAs rather than allergenic proteins, milk cannot be distinguished from beef and will be difficult to detect food contains egg white. Therefore, it is important to determine allergens in food by using more reliable detection method. Recently, liquid chromatography mass spectrometry becomes an alternative technique to detect allergenic proteins with high selectivity, sensitivity, and capability to analyze multiple allergens simultaneously. We developed a method to detect 31 peptides derived from eight allergens. We analyzed commercially available samples such as bread and gluten free bread etc to evaluate this method. We did not detected any peptides derived from gluten in gluten free bread and gluten free cracker. And we could detect peptides of 20 ppm wheat fortified to gluten free bread. We could detect other allergens shown on the label from commercial available food matrices.

Materials and methods

Sample preparation

Commercially available allergenic food materials were purchased at local grocery store and used for development of analytical methods. The samples were ground in fine powders by GM-200 (Retsch). 0.5 - 1 g of each ground samples was transferred into 50 mL tube. Hexane was used for removal of oils and fats from samples. Proteins were extracted by using the extraction

buffer containing 50 mM Tris-HCl (pH8.0) 2M Urea and protease inhibitors. Aliquot of extract containing 100 – 250 µg of proteins were denatured, alkylated, and digested into peptides by traditional in-solution protein digestion technique. Digested peptides were desalted by SPE, lyophilized, and stored until analysis.

LC/MS analytical conditions

LC/MS analysis was conducted by using Shimadzu Nexera X2 UHPLC coupled to triple quadrupole mass spectrometer LCMS-8050. 0.1 % formic acid in water (A) and acetonitrile (B) were used for mobile phase at a flow rate of 0.5 mL/min. Shim-pack XR-ODS III (2.0 mmID x 75 mmL., 1.6 µm) was used as analytical column. The high pressure gradient elution was set as follows: 2%B (0.0 min), 15%B (4 min), 40%B (7 min), 95%B (7.10-8.00

min), 2%B (9.10-10.00 min). Peptides were detected by MRM acquisition. Other parameters for mass spectrometer were set as follows: positive mode electrospray ionization, nebulizing gas flow of 3 L/min, heating gas flow of 20 L/min, drying gas flow of 5 L/min, interface temperature of 250 °C, DL temperature of 150 °C, heat block temperature of 200 °C.

Simultaneous analysis of major allergens in food matrices by high sensitive mass spectrometer

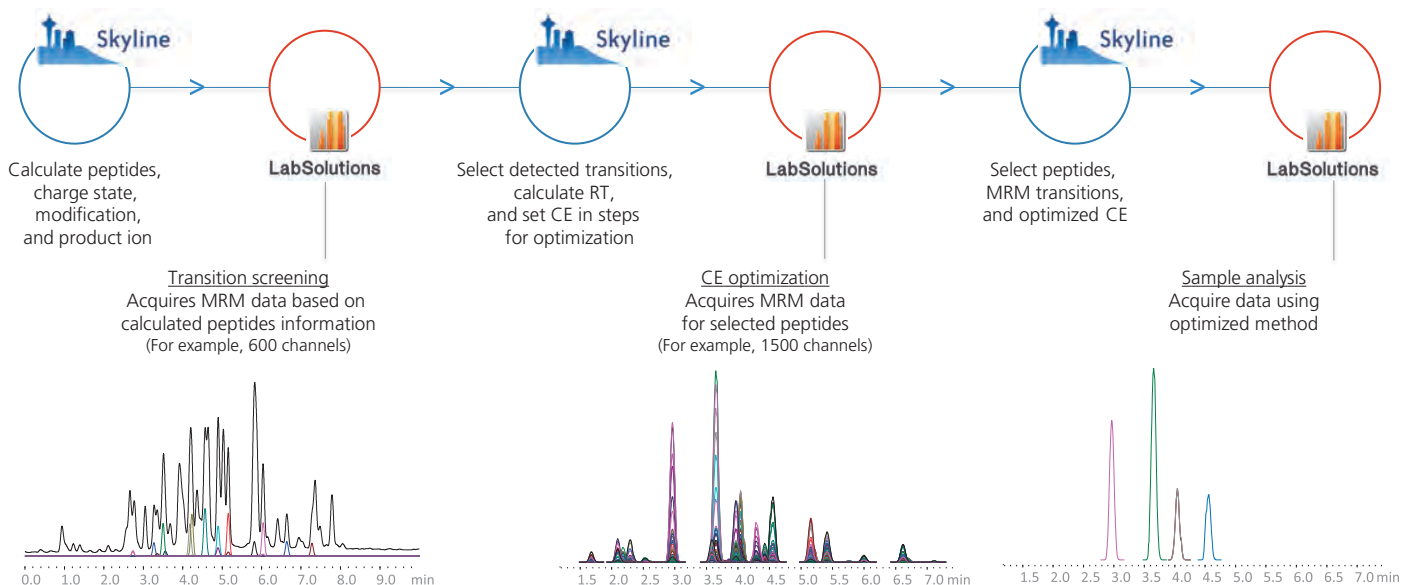

Figure 1 Work flow of MRM transition optimization using Skyline.

Result

Detection of allergenic proteins by LC-MS/MS

To establish analytical method, we selected MRM transitions of signature peptides by using Skyline (Figure 1) based on their peak intensity, peak shape, and similarity to other peptides of target proteins. As a result of method development, we finally selected 150 MRM

transitions for monitoring 33 peptides derived from 13 proteins as allergenic proteins of eight foods or food groups. As Figure 2 shows, all of peptides were eluted within 6.5 min with good separation. Figure 2 also shows the linearity of peptides.

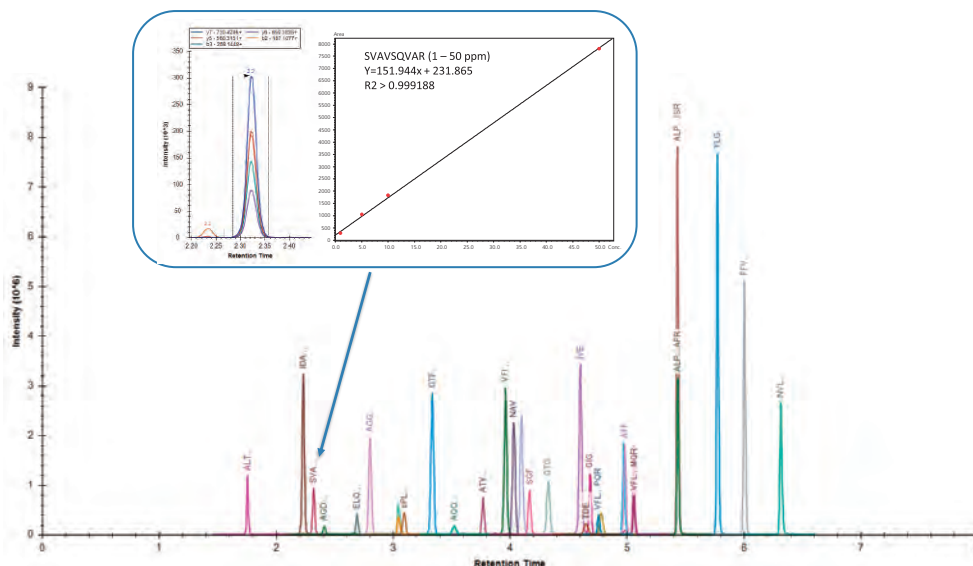

Figure 2 Chromatogram of peptides mixture derived from eight food allergens, and magnified view of five MRM transitions for wheat peptides and its calibration curve.

Simultaneous analysis of major allergens in food matrices by high sensitive mass spectrometer

Table 1 The target food matrices, protein name, peptides, and UniProt ID found in same food.

Food (Binomial name)		Protein name (IUIS name)	Peptides	UniProt ID
Milk (<i>Bos taurus</i>)		Caseins (Bos d 8)	FFVAPFPEVFGK	P02662, B5B3R8
			YLGYLEQLLR	P02662, B5B3R8
			NAVPIPTLNR	P02662, B5B3R8
			FALPQYLK	P02663
		Beta-lactoglobulin (Bos d 5)	IDALNENK	P02754, G5E5H7, B5B0D4
Egg (<i>Gallus gallus</i>)		Ovalbumin (Gal d 2)	NVLQPSSVDSQTAMVLVNAIVFK	P01012
		Ovotransferrin (Gal d 3)	ATYLDCIK	P02789, Q4ADJ7, Q4ADJ6, E1BQC2, Q4ADG4, A0A1D5P4L7
			TDERPASYFAVAVAR	P02789, Q4ADJ7, Q4ADJ6, E1BQC2, Q4ADG4, A0A1D5P4L7, A0A1L1RSU6
Fish	Atrantic cod (<i>Gadus morhua</i>)	Beta-parvalbumin (Gad m 1)	ALTDAETK	P02622, A5I873, Q90YLO
			AFFVIDQDK	Q90YLO, A5I873
			SGFIEDELK	Q90YLO, A5I873
Crustacean shellfish	Whiteleg shrimp (<i>Litopenaeus vannamei</i>)	Tropomyosin (Lit v 1)	IQLLEEDLER	B4YAH6
			IVELEELR	B4YAH6
		Myosin, light chain 2 (Lit v 3)	EGFQLMDR	B7SNI3
			GTFDEIGR	B7SNI3
		Sarcoplasmic calcium-binding protein (Lit v 4)	VFIANQFK	C7A639
AGGLTLER	C7A639			
Tree nuts	Almonds (<i>Prunus dulcis</i>)	Amandin, 11S globulin legumin-like protein (Pru du 6)	ALPDEVLANAYQISR	E3SH28, Q43607
			ALPDEVLQNAFR	E3SH29
Peanuts (<i>Arachis hypogaea</i>)		Cupin Vicillin-type, 7S globulin (Ara h 1)	NNPFYFPSR	P43237, P43238, E5G076, B3IXL2, N1NG13, Q6PSU3
			GTGNLELVAVR	P43237, P43238, B3IXL2, Q6PSU6, Q6PSU3, N1NG13, Q6PSU5, E5G076, Q6PSU4
Wheat (<i>Triticum aestivum</i>)		High molecular weight glutenin (Tri a 26)	ELQELQER	P10388, P08489 and 22 others in wheat
			SVAVSQVAR	P10387, P08488, and 21 others in wheat
			AQQPATQLPTVCR	P10387, P08488, and 21 others in wheat
		Low molecular weight glutenin GluB3-23 (Tri a 36)	VFLQQQCIPVAMQR	P10385 and 71 others in wheat
			VFLQQQCSPVAMPQR	P10386, P04729, P04730 and 114 others in wheat
Soybeans (<i>Glycine max</i>)		Trypsin inhibitor (Gly m TI)	CPLTVVQSR	P01070, P01071, P25272 and 13 others
			NKPLVVQFQK	P01070, P01071, P25272 and 8 others
			NKPLVVEFQK	P25273

Simultaneous analysis of major allergens in food matrices by high sensitive mass spectrometer

Allergens in cooked food matrices

Chromatograms of commercially available food matrices were shown below. A mixture of eight allergenic food and seven cooked food were analyzed. As summarized in Table 3, even we missed soybeans from several food, these data shows that we could detect expected allergens from actual samples overall.

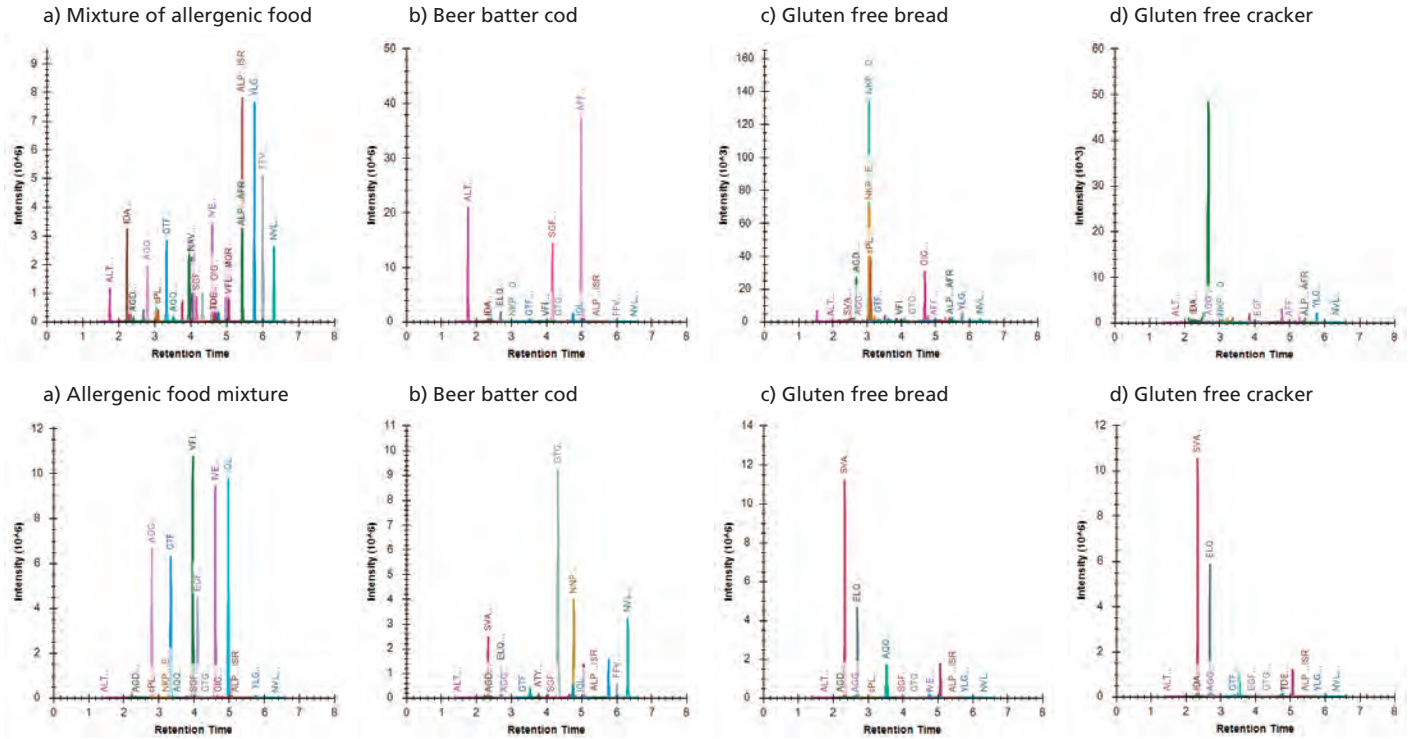

Figure 3 Chromatograms of seven cooked food matrices and mixture of allergenic food as positive control.

Simultaneous analysis of major allergens in food matrices by high sensitive mass spectrometer

Table 2 The results of seven cooked food samples.

Food	Allergens	Gluten free bread		Gluten free cracker		Bread		Cracker	
		Label	Detect	Label	Detect	Label	Detect	Label	Detect
Milk	Caseins (Bos d 8)			x	x			(x)	
	Beta-lactoglobulin (Bos d 5)				x				
Egg	Ovalbumin (Gal d 2)			x	x	x	x	(x)	
	Ovotransferrin (Gal d 3)				x		x		
Atrantic cod	Beta-parvalbumin (Gad m 1)								
Whiteleg shrimp	Tropomyosin (Lit v 1)								
	Myosin, light chain 2 (Lit v 3)								
	Sarcoplasmic CBP (Lit v 4)								
Almonds	Amandin (Pru du 6)							(x)	
Peanuts	Cupin, vicillin-type, 7S globulin (Ara h 1)			x				(x)	
Wheat	High molecular weight glutenin (Tri a 26)					x	x	x	x
	Low molecular weight glutenin (Tri a 36)						x		x
Soybeans	Trypsin inhibitor (Gly m TI)	x	x	x				x	

Food	Allergens	Peanuts cookies		Frozen fish "fried cod"		Frozen pasta "garlic shrimp"	
		Label	Detect	Label	Detect	Label	Detect
Milk	Caseins (Bos d 8)	-	x	x	x	x	x
	Beta-lactoglobulin (Bos d 5)		x		x		x
Egg	Ovalbumin (Gal d 2)	-	x				
	Ovotransferrin (Gal d 3)		x				
Atrantic cod	Beta-parvalbumin (Gad m 1)	-		x	x		
Whiteleg shrimp	Tropomyosin (Lit v 1)						x
	Myosin, light chain 2 (Lit v 3)	-				x ¹	x
	Sarcoplasmic CBP (Lit v 4)						x
Almonds	Amandin (Pru du 6)	-					
Peanuts	Cupin, vicillin-type, 7S globulin (Ara h 1)	-	x				
Wheat	High molecular weight glutenin (Tri a 26)	-	x	x	x	x	x
	Low molecular weight glutenin (Tri a 36)	-	x		x		x
Soybeans	Trypsin inhibitor (Gly m TI)	-				x	

¹Labeled as "Crustacean shellfish (Shrimp)"

Simultaneous analysis of major allergens in food matrices by high sensitive mass spectrometer

“Gluten-free” food samples

As a part of evaluation of the method, we analyzed bread containing gluten and gluten-free bread. In US, as one of the criteria for using the claim “gluten-free”, FDA set a gluten limit of less than 20 ppm in foods that carry this label. Then, we also analyzed gluten free-bread spiked with wheat extract at 10 ppm. As shown in Figure 4, those level of glutes was detected successfully.

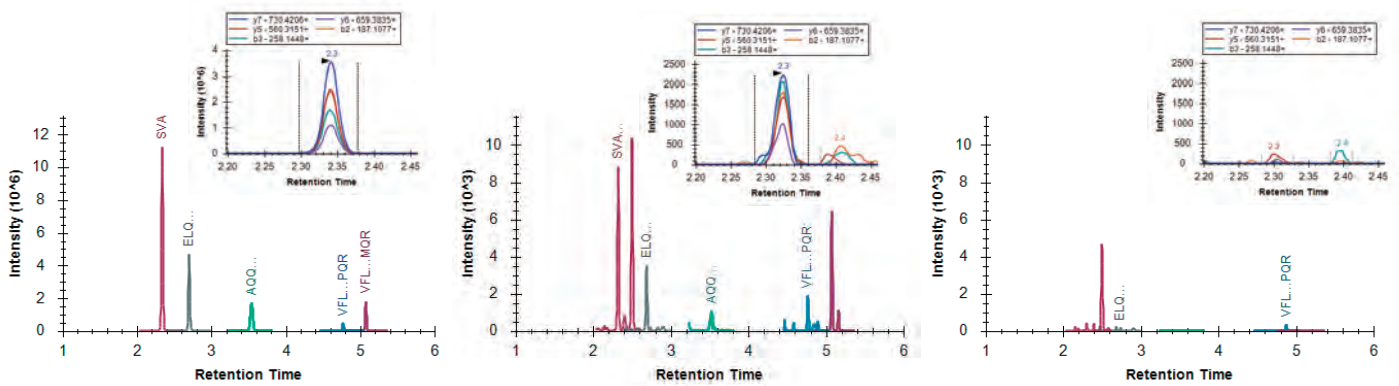

Figure 3 Chromatograms of seven cooked food matrices and mixture of allergenic food as positive control.

Similarity to other food ingredients

In method development, we performed peptides search for amino acid sequences of theoretically calculated peptides by using UniProt database. Since gluten is a major protein in grains, those peptides sequences are commonly preserved in other edible grains as well (Table 3). To avoid miss identification of food ingredients, we selected the sequences not found in Barley or Rye as significant peptides. On the other hand, these peptides are also found in some sort of goat grass.

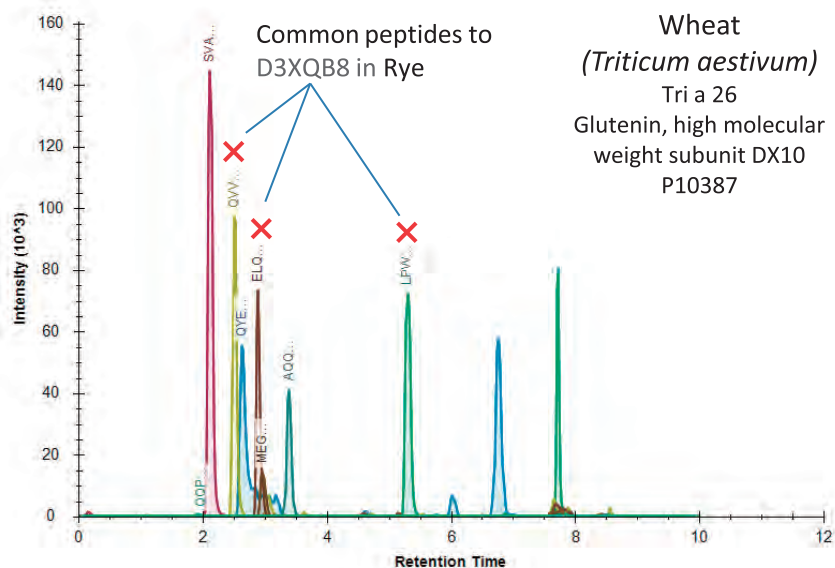

Figure 3 Work flow of MRM transition optimization using Skyline.

Simultaneous analysis of major allergens in food matrices by high sensitive mass spectrometer

Table 1 Peptides search result of predicted peptides

Analyzed wheat peptides (P10387)	Positions	Barley	Rye
AQQPATQLPTVCR	624-636		
ELQESSLEACR	33-43	x	x
LPWSTGLQMR	54-63	x	x
MEGGDALSASQ	637-647		x
QGSYYPGQASPQQPGQGQQPGK	135-156		x
QQPGQGQHPEQGK	469-481		x
QVVDQQLAGR	44-53		x
QYEQTVVPPK	86-95		
SVAVSQVAR	75-85		

x: found, blank: not found

Conclusion

- Major food allergens were successfully detected by LC-MS/MS method.
- The method contains 150 MRMs for 31 peptides of 13 allergenic proteins identified in 8 foods.
- The presence of allergenic ingredients in cooked meal could be detected.



LCMS-8050 triple quadrupole mass spectrometer

The product and application are Research Use Only. Not for use in human clinical diagnostics or in vitro diagnostic procedures.

First Edition: June, 2017

Application News

No. SCA_210_041

Liquid Chromatography Mass Spectrometry

Sensitive method for the determination of Fipronil and its metabolite Fipronil Sulfone in egg using QuEChERS sample pretreatment and LC-MS/MS detection [LCMS-8060]

▪ Introduction

Fipronil concerns a broad-spectrum insecticide from the group of phenylpyrazoles used in many countries as a biocide and plant protection product against fleas, lice, ticks, cockroaches, mites and other insects. Fipronil is an active compound in veterinary products fighting tick and flea infestations in dogs and cats. The use as plant protection product is restricted to seed treatment in the European Union since 2007. However, due to the illegal use as addition to the cleaning supplies used in chicken coops the eggs and meat might get contaminated as well.

The MRL (maximum residue levels) for Fipronil and its metabolite Fipronil sulfone (which is classified as having similar toxicity) in eggs is set to 0.005 mg/kg by the EU (by definition the sum of fipronil and fipronil-sulfone expressed as fipronil) [1], so that there is an actual requirement for the determination of both compounds in egg matrix at a relatively low level.

This application news presents a simple method using a standard QuEChERS extraction protocol followed by LC-MS/MS detection.

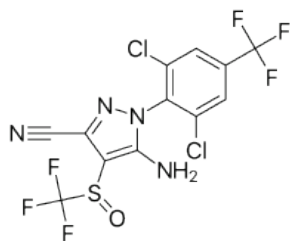

Fipronil

MF C₁₂H₄Cl₂F₆N₄OS
MW 437,1 g/mol

▪ Sample preparation

Compound extraction was performed using a simple QuEChERS (Quick, Easy, Cheap, Effective, Rugged and Safe) method.

5 g of egg (egg white and egg yolk) were weighted into a 50 mL polypropylene tube, diluted with 5 mL

of water and spiked with a respective amount of Fipronil, Fipronil sulfone and in addition Fipronil-desulfinyl and Fipronil-sulfide (neochema, Germany).

10 mL of acetonitrile was added and the samples were mixed vigorously. After that ready to use QuEChERS extraction salts (Q-sepTM Q110, Pouch and tubes – cat. #26235, Restek) were added for sample drying and buffering. Samples were mixed again and centrifuged at 4500 rpm for 5 minutes. 1 mL of the supernatant was transferred into a dSPE tube (Q-sepTM QuEChERS dSPE – cat. #26217, Restek), shaken for 2 minutes, centrifuged, the supernatant was transferred into a glass vial and the pH was adjusted with 5% formic acid solution in acetonitrile (10 µL/mL supernatant).

▪ Materials and methods

Extracts were analyzed using a method set up with Shimadzu's LC/MS/MS Method Package for Residual Pesticides Version 2 and a Nexera X2 UHPLC system coupled to a LCMS-8060 mass spectrometer. Analysis was carried out using MRM (Multi Reaction Monitoring) mode.



LC system	Nexera X2 (Shimadzu, Japan)
Analytical column	Raptor Biphenyl™ 100 x 2.1 mm, 2.7 μm (RESTEK)
Column oven temperature	35 °C
Injection volume	2 μl
Mobile Phase A	2 mM ammonium formate + 0.002% formic acid - Water
Mobile Phase B	2 mM ammonium formate + 0.002% formic acid - Methanol

Mass spectrometer	LCMS-8060 (Shimadzu, Japan)
Interface voltage	-3 kV
Q1 resolution	Unit (0.7 Da FWHM)
Q3 resolution	Unit (0.7 Da FWHM)
Nebulizing gas flow	3 L/min
Drying gas flow	10 L/min
Heating gas flow	10 L/min
DL temperature	150 °C
Heat block temperature	300 °C
Interface Temperature	350 °C

In addition, the so-called "MRM spectrum mode" was used for analysis. Here, not only the fragments of the quantifier and the qualifiers are determined, but also a higher number (typically 6-10) of MRM fragment ions. Using this MRM spectrum mode, conventional MRM quantification is combined with a high-quality MRM product ion spectrum, which can be used in a library search routine, thus increasing the specificity and verification of results (Figures 1 and 2).

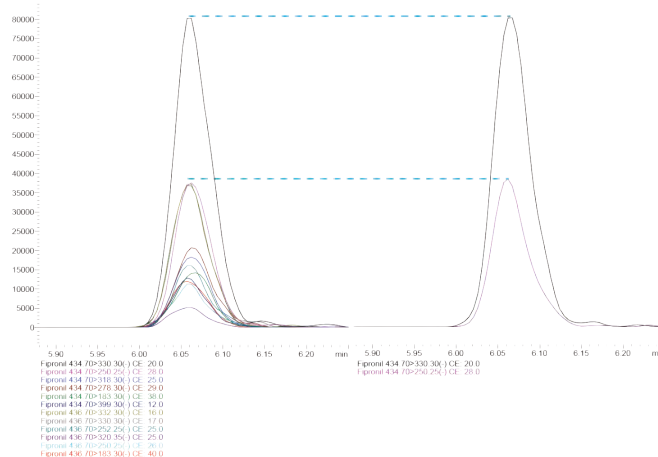

Figure 2: The figure shows MRM chromatograms for Fipronil, one recorded with the usual 2 fragment ions, and compared with a method with higher number (12) of fragment ions which, despite this fact, have the same sensitivity.

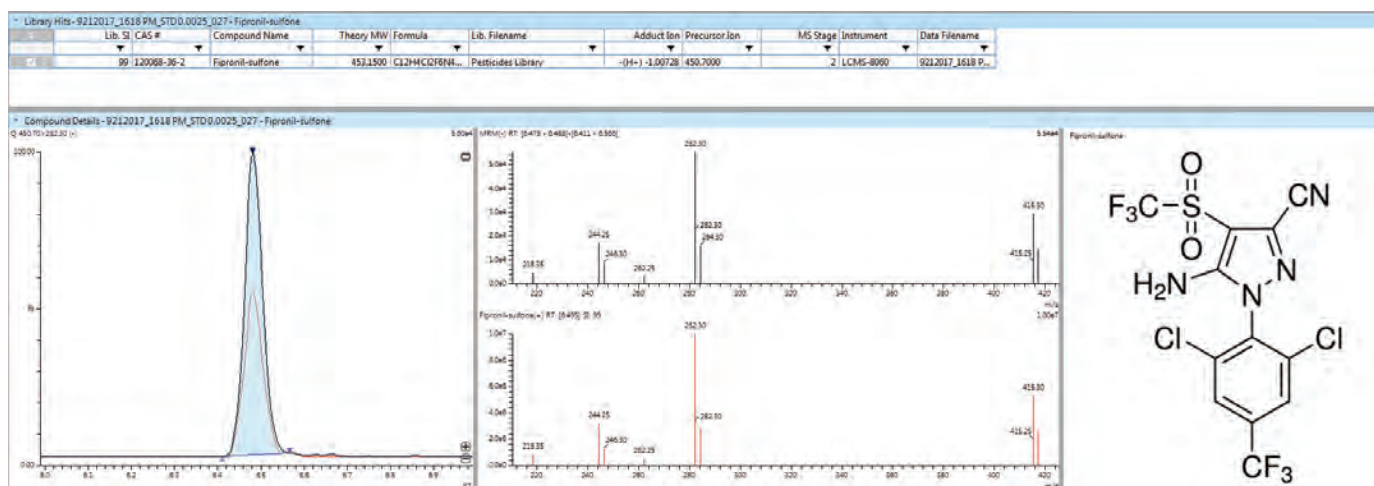

Figure 1: Result of the library search, presented with LabSolutions Insight Screening software

Calibration

The matrix matched calibration curve (Figure 3-6) was prepared according to the method described before ranging from 0.0005 mg/kg to 0.05 mg/kg. Control samples at 0.001 mg/kg and 0.01 mg/kg correspond to the calibration curve.

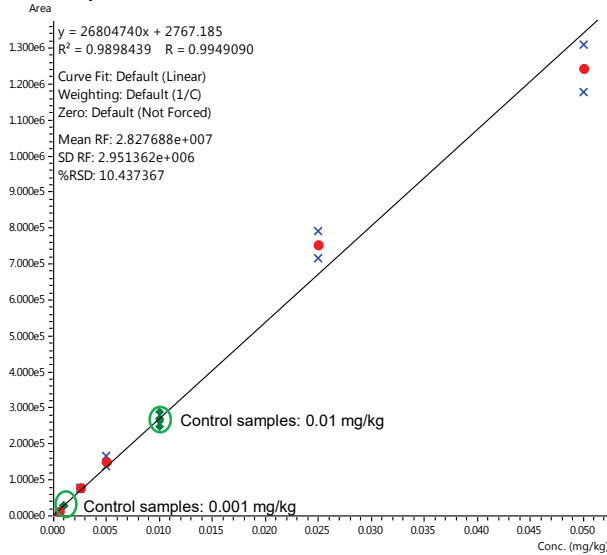

Figure 3: Calibration curve of Fipronil in egg ranging from 0.0005 mg/kg to 0.05 mg/kg

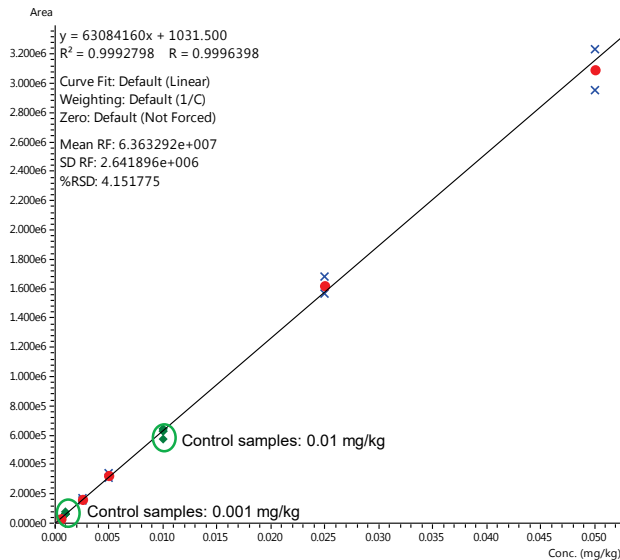

Figure 4: Calibration curve of Fipronil-sulfide in egg ranging from 0.0005 mg/kg to 0.05 mg/kg

[1] EU Commission Regulation No 1127/2014 of 20 October 2014 Amending Annexes II and III to Regulation (EC) No 396/2005 of the European Parliament and of the Council in regards to maximum residual levels for amitrole, dinocap, fipronil, flufenacet, pendimethalin, propyzamide and pyridate in or on certain products.

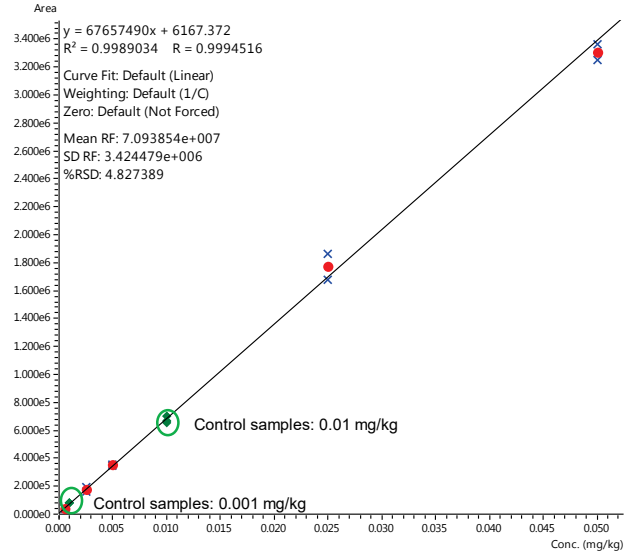

Figure 5: Calibration curve of Fipronil-sulfone in egg ranging from 0.0005 mg/kg to 0.05 mg/kg

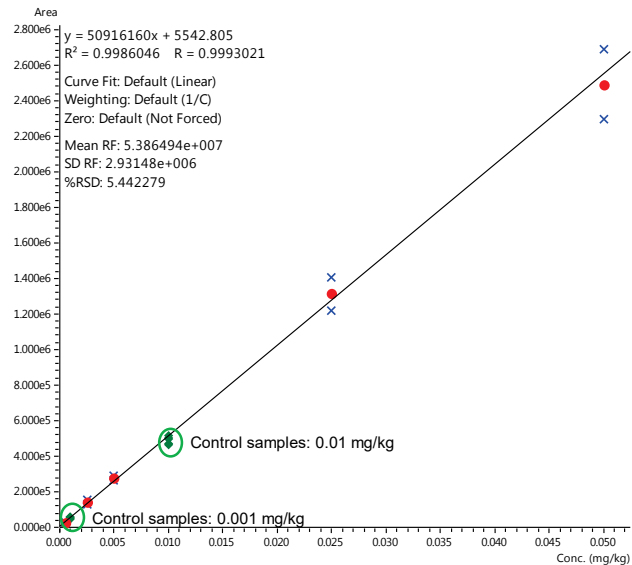

Figure 6: Calibration curve of Fipronil-desulfinyl in egg ranging from 0.0005 mg/kg to 0.05 mg/kg

Conclusion

By using the LC/MS/MS method package for residual pesticides V2 and a QuEChERS sample preparation a method for the determination of Fipronil and Fipronil-sulfone in eggs below the requested MRL of 0.005 mg/kg could be set up rapidly without further method development.



Shimadzu Europa GmbH

www.shimadzu.eu

For Research Use Only. Not for use in diagnostic procedures.

This publication may contain references to products that are not available in your country. Please contact us to check the availability of these products in your country.

The content of this publication shall not be reproduced, altered or sold for any commercial purpose without the written approval of Shimadzu. Company names, products/service names and logos used in this publication are trademarks and trade names of Shimadzu Corporation, its subsidiaries or its affiliates, whether or not they are used with trademark symbol "TM" or "®".

Third-party trademarks and trade names may be used in this publication to refer to either the entities or their products/services, whether or not they are used with trademark symbol "TM" or "®". Shimadzu disclaims any proprietary interest in trademarks and trade names other than its own.

The information contained herein is provided to you "as is" without warranty of any kind including without limitation warranties as to its accuracy or completeness. Shimadzu does not assume any responsibility or liability for any damage, whether direct or indirect, relating to the use of this publication. This publication is based upon the information available to Shimadzu on or before the date of publication, and subject to change without notice.

Application News

No. C140

Liquid Chromatography Mass Spectrometry

Ultra-Sensitive and Rapid Assay of Neonicotinoids, Fipronil and Some Metabolites in Honey by UHPLC-MS/MS [LCMS-8060]

Neonicotinoids are a class of insecticides widely used to protect fields as well as fruits and vegetables.

Recently the use of these compounds became very controversial as they were pointed as one cause of the honeybees colony collapse disorder. Since pollination is essential for agriculture, extensive studies have been conducted to evaluate the impact of neonicotinoids on bee health. Following this the European Food Security Authority (EFSA) limited the use of thiamethoxam, clothianidin and imidacloprid. Fipronil, a pesticide from a different chemical class, has been also banned by EFSA for maize seed treatment due to its high risk for honeybee health.

In order to better understand the effect of these compounds on bees and their contamination in pollen and honey, a highly sensitive assay method was necessary. A method was set up using Nexera X2 with LCMS-8060.

Sample Preparation

Thiamethoxam-d3, imidacloprid-d4 and clothianidin-d3 were used as internal standards.

Compound extraction was performed using a QuEChERS (Quick, Easy, Cheap, Effective, Rugged and Safe) method with an additional dispersive Solid Phase Extraction (dSPE) step.

5 g of honey (± 1 %) were weighted in a 50 mL polypropylene tube. 5 μ L of internal standard solution at 5 μ g/mL of each compound in acetonitrile was added on honey and let dry for 10 minutes. 10 mL of ultra pure water were added and the samples were homogenized by vortex mixing for 1 minute. 10 mL of acetonitrile were then added followed by vortex mixing for 1 minute.

After incubation at room temperature for one hour with gentle shaking, a commercially available salt mix from Biotage (4 g MgSO₄, 1 g Sodium Citrate, 0.5 g Sodium Citrate sesquihydrate, 1g NaCl) was added. After manual shaking, samples were centrifuged at 3000 g for 5 minutes at 10 °C.

Supernatant (6 mL) was transferred into a 15 mL tube containing 1200 mg of MgSO₄, 400 mg PSA and 400 mg C18 from Biotage. After centrifugation at 3000 g and 10 °C for 5 minutes the supernatant was transferred into a LCMS certified inert glass vial for analysis (Shimadzu LabTotal 227-34001-01).

Recovery

An "all-flowers" honey from the local supermarket was extracted with or without spike at 50 ppt. A blank extract (no honey) was prepared to evaluate losses or non specific interactions. Results are presented in Table 1.

Calculated recoveries are within acceptance values 70-120 % from EU SANTE/11945/2015.

Table 1 Measured Recoveries in Honey

Compound	Recovery	Compound	Recovery
Acetamiprid	78.8 %	Fipronil sulfone	74.2 %
Acetamiprid-N-desmethyl	93.4 %	Imidacloprid	83.2 %
Chlothianidin	70.6 %	Nitenpyram	87.0 %
Dinotefuran	76.5 %	Thiacloprid	82.2 %
Fipronil	78.1 %	Thiamethoxam	75.6 %

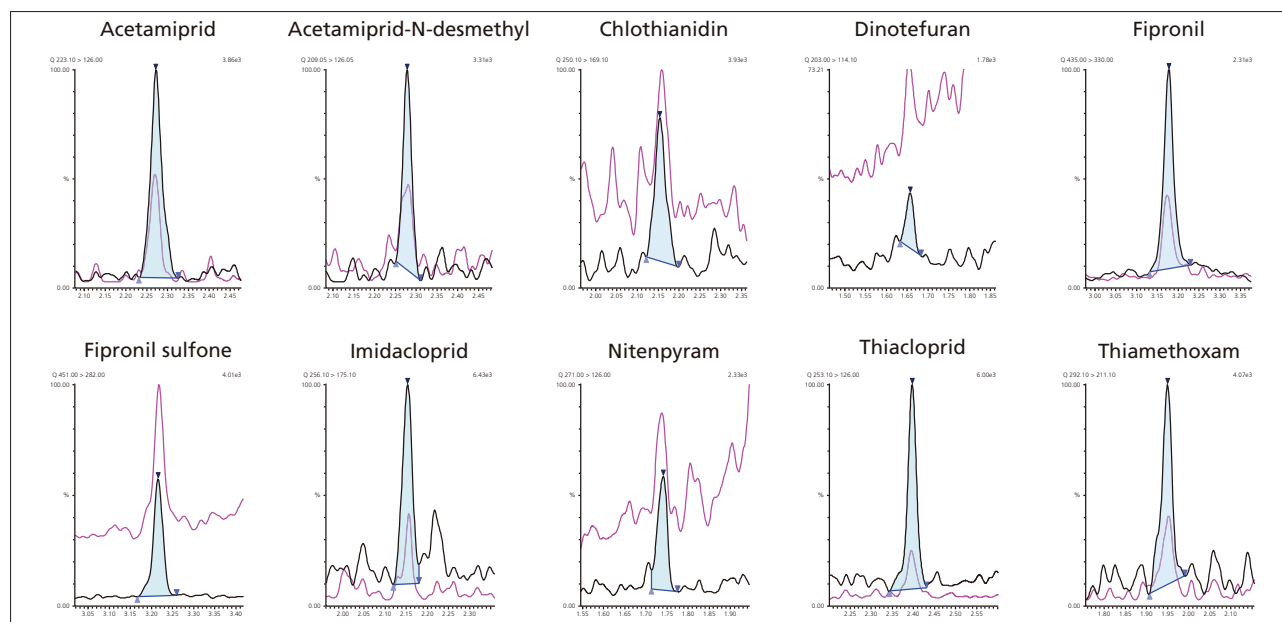

Fig. 1 Chromatogram of the Target Compounds at Their Lower Limit of Quantification

Table 2 Analytical Conditions

System	: Nexera X2	System	: LCMS-8060
Column	: ACE SuperC18 (100 mm L. x 2.1 mm I.D., 2 μm)	Ionization	: Heated ESI
Column Temperature	: 30 °C	Probe Voltage	: +1 kV (positive ionization) / -1.5 kV (negative ionization)
Mobile Phases	: A: Water = 0.05 % ammonia B: Methanol + 0.05 % ammonia	Temperature	: Interface: 400 °C Desolvation Line: 200 °C Heater Block: 400 °C
Flowrate	: 600 μL/min	Gas Flow	: Nebulizing Gas: 3 L/min Heating Gas: 10 L/min Drying Gas: 5 L/min
Gradient	: 5 %B to 100 %B in 3 min 100 %B to 5 %B in 0.1 min		
Total Run Time	: 4 min		
Injection Volume	: 2 μL (POISe mode with 10 μL of water)		

Table 3 MS/MS Acquisition Parameters

MRM Transitions	Name	Polarity	MRM Quan	MRM Qual	ISTD
	Acetamiprid	+	223.1 > 126.0	223.1 > 56.1	2
	Acetamiprid-N-desmethyl	+	209.1 > 126.0	211.1 > 128.0	2
	Clothianidin	+	250.1 > 169.1	250.1 > 132.0	3
	Dinotefuran	+	203.0 > 114.0	203.0 > 87.0	1
	Fipronil	-	435.0 > 330.0	435.0 > 250.0	3
	Fipronil sulfone	-	451.0 > 415.0	451.0 > 282.0	3
	Imidacloprid	+	256.1 > 175.1	258.1 > 211.1	2
	Nitenpyram	+	271.0 > 126.0	271.0 > 225.0	3
	Thiacloprid	+	253.1 > 126	253.1 > 90.1	1
	Thiamethoxam	+	292.1 > 211.1	292.1 > 181.1	1
	Thiamethoxam-D3	+	295.1 > 214.05	---	1
	Imidacloprid-D4	+	260.1 > 179.1	---	2
	Clothianidin-D3	+	253.1 > 132.05	---	3

Dwell Time : 3 to 34 msec depending upon the number of concomitant transitions to ensure to have at least 30 points per peak (max total loop time 140 msec).

Pause Time : 1 msec

Quadrupole Resolution : Q1: Unit Q3: Unit

Calibration

Calibration curves were prepared in acetonitrile to obtain final concentrations ranging from 0.5 pg/mL (1 fg on column) to 5 ng/mL. These concentrations corresponds to 1 ng/kg and 10 μg/kg in honey, respectively.

For each compound, the lower limit of quantification was selected to give an accuracy between 80-120 % (see table 4).

A typical calibration curve is shown in Fig. 2.

Table 4 Limits of Quantification in Honey

Compound	LOQ (μg/kg)	Compound	LOQ (μg/kg)
Acetamiprid	0.005	Fipronil sulfone	0.001
Acetamiprid-N-desmethyl	0.005	Imidacloprid	0.020
Chlothianidin	0.020	Nitenpyram	0.020
Dinotefuran	0.010	Thiacloprid	0.005
Fipronil	0.001	Thiamethoxam	0.005

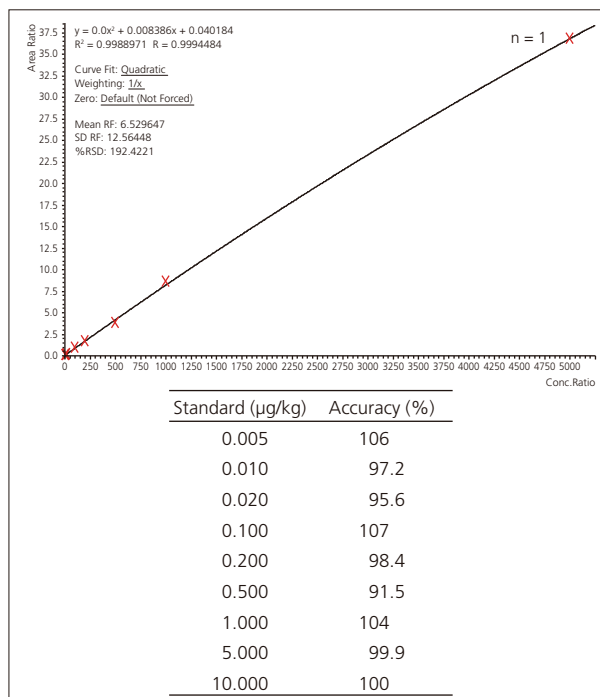

Fig. 2 Calibration Curve of Acetamiprid

■ **Real Samples Analysis**

Nine honey samples purchased at the local supermarket or used as raw materials in cosmetics (orange tree honey) were assayed as unknowns.

All tested honeys showed concentrations far below the authorized maximum residue limit. But thanks to the very high sensitivity reached, even low concentrations of neonicotinoids were quantified. Results are presented in table 5.

A representative chromatogram of a sample honey is shown in Fig. 3.

Table 5 Honey Samples Results (concentrations in µg/kg)

Honey	Acetamidrid	Clothianidin	Imidacloprid	Thiacloprid	Thiamethoxam
1. Provence creamy	---	---	0.20	---	0.010
2. Italy creamy	0.15	---	0.17	---	---
3. Pyrenees liquid	0.38	---	0.043	0.020	---
4. French-Spanish creamy	0.27	---	0.047	0.020	---
5. Thyme liquid	---	---	---	---	---
6. Lemon tree creamy	1.7	---	0.15	0.033	---
7. Orange tree liquid	1.2	---	0.62	---	---
8. Flowers creamy	0.14	---	0.055	0.39	---
9. Flowers liquid	0.34	---	0.11	0.010	---

Honey	Dinotefuran	Nitenpyram	Acetamidrid-N-desmethyl	Fipronil	Fipronil sulfone
1. Provence creamy	---	0.052	0.005	---	---
2. Italy creamy	---	0.040	---	---	---
3. Pyrenees liquid	---	---	0.015	0.004	---
4. French-Spanish creamy	---	0.032	---	---	---
5. Thyme liquid	---	---	---	---	---
6. Lemon tree creamy	---	---	0.020	---	---
7. Orange tree liquid	---	0.024	0.018	---	---
8. Flowers creamy	---	---	0.016	---	---
9. Flowers liquid	---	---	0.006	---	---

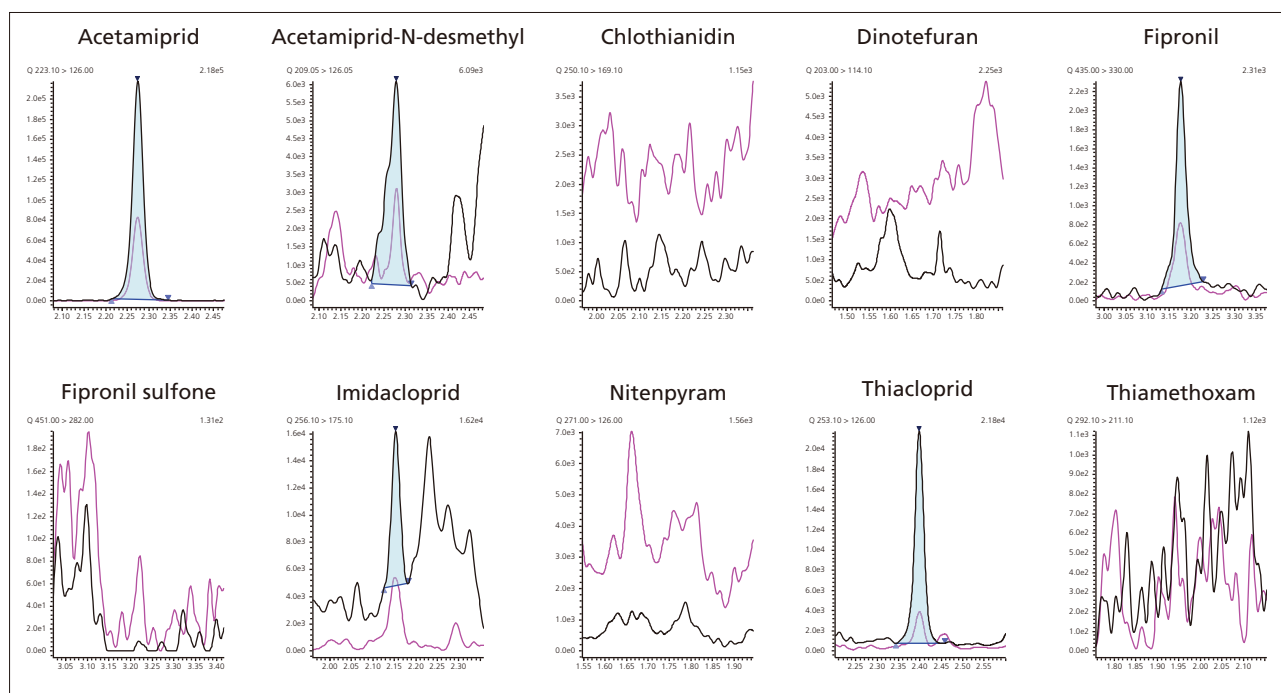

Fig. 3 Chromatogram of a Sample Honey (Pyrenees)

■ Stability

The thyme honey sample with no detectable target compound was spiked at 50 ng/kg with all compounds prior to extraction. The extract obtained was then consecutively injected 150 times in the system.

The results presented in Fig. 4 show excellent stability of the signal even at these low concentrations. This demonstrates that the excellent sensitivity can be maintained over long series of real sample analysis thanks to the ion source ruggedness.

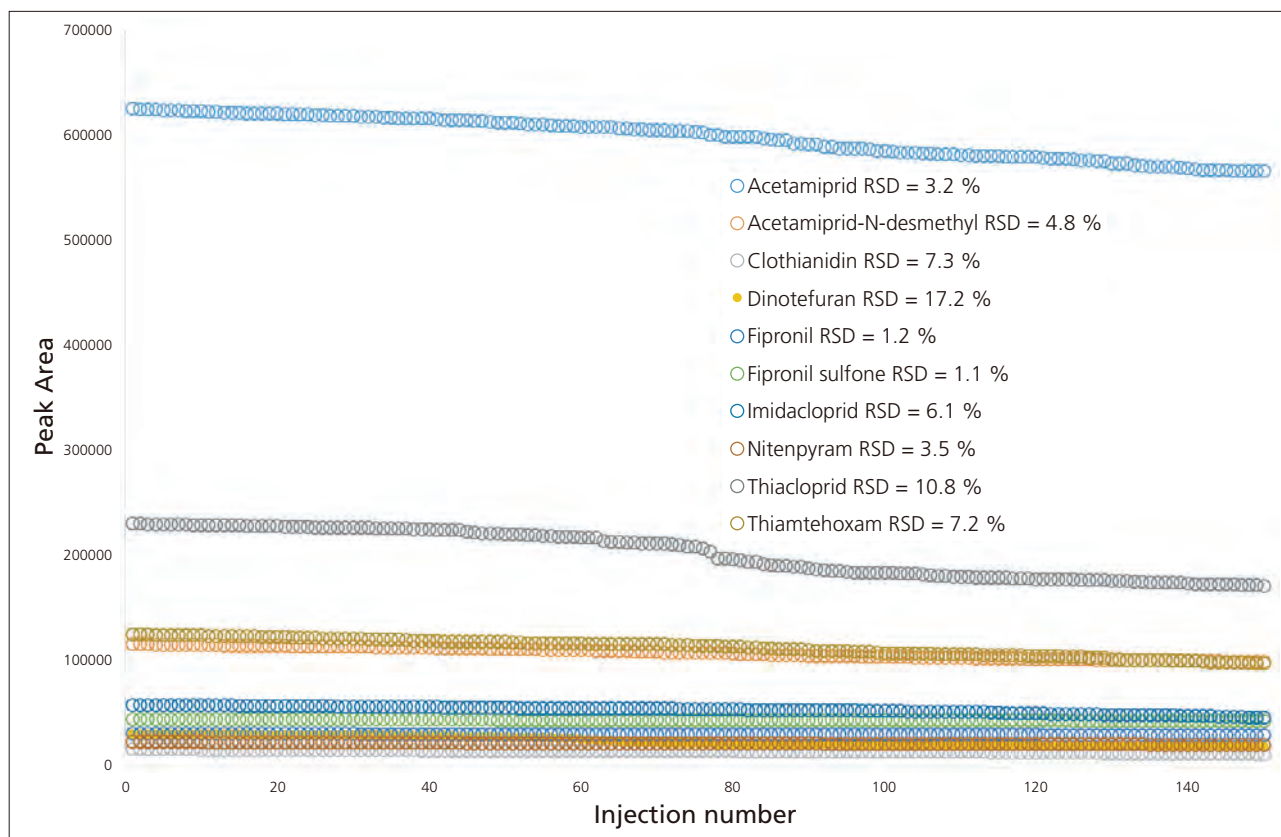

Fig. 4 Stability of Peak Areas in Real Honey Samples

■ Conclusion

A method for ultra sensitive assay of neonicotinoids in honey was set up. The sample preparation was simple but provided excellent recoveries. The injection mode used prevented the use of tedious evaporation/reconstitution or dilution steps.

Thanks to the high sensitivity obtained enabled assay in real samples at very low levels far under the regulated residue levels. Furthermore, even at low measured concentrations, the system demonstrated its stability after long analytical series of real samples.

This method can be a very efficient support tool to better understand the impact of neonicotinoids on honey bee colonies and could be easily transposed to pollen or bee samples.

Technical Report

Determination of MOSH Contamination in Baby Foods by Using LC–GC and LC–GC×GC–MS

Advances in food contaminant analysis

Mariosimone Zoccali¹, Peter Q. Tranchida¹, Paola Dugo^{1,2}, Luigi Mondello^{1,2}

Abstract:

The present research is based on an investigation directed towards the use of a rapid heart-cutting multidimensional LC–GC–FID method for the analysis of mineral oil saturated hydrocarbons (MOSH), contained in different types of homogenized solid baby food. Sixteen commercial baby food samples were subjected to analysis. The results were confirmed, in qualitative terms, by collecting the LC fractions, relative to some of the food samples, and subjecting them to comprehensive two-dimensional GC–quadrupole mass spectrometry.

Keywords: multidimensional liquid-gas chromatography, comprehensive 2D gas chromatography, baby food

1. Introduction

Mineral oil is derived from crude oil and consists, mainly, of saturated and aromatic hydrocarbons. The former class of compounds, generically defined mineral oil saturated hydrocarbons (MOSH), is formed of straight and branched alkanes, as well as cyclic constituents (naphthenes). The contamination of foods with MOSH is a common occurrence, and many works have been published. For example, Grob *et al.* in 1991 found a series of contamination sources, namely lubricating oils and release agents exploited in the food industry, or mineral batching oil used for the production of jute^[1, 2]. In a later study, it was found that mineral oil can be transferred to dry baby food products *via* ink printed on cardboard containers^[3].

At present, there are no legal limits related to the amounts of MOSH contained in foods; a single exception (50 mg/kg) is that related to Ukrainian sunflower oil, following a severe case of contamination^[4]. A limit of 0.6 mg/kg for MOSH (from C₁₀ to C₂₅) contamination in foods, as a consequence of migration from cardboard packaging, has been recently proposed by the German Federal Ministry of Food, Agriculture and Consumer Protection (BMELV).

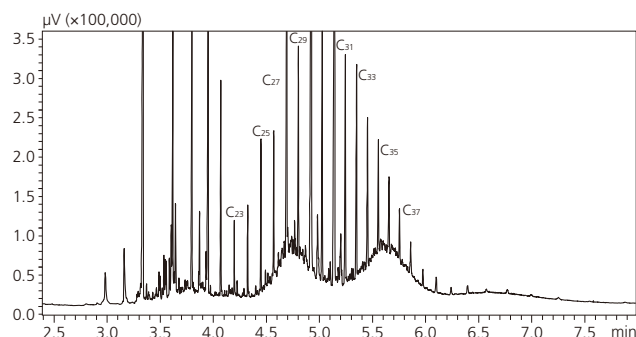

Fig. 1 LC–GC–FID chromatogram for the salmon (I) baby food sample.

Such a limit was derived from a calculation made considering an adult of 60 kg, consuming 1 kg of contaminated food per day.

Heart-cutting LC–GC, with a flame ionization detector (FID), is a prime choice for the quantification of MOSH. The first LC dimension is always exploited to separate the hydrocarbons from the lipid matrix.

The present investigation is based on the development and validation of an LC–GC–FID method for the analysis of mineral oil saturated hydrocarbons in baby food. The main novelties of the research, are related to the high analysis speed and to the use of a novel comprehensive LC–GC (LC×GC) interface, capable of working in both heart-cutting or “comprehensive” (LC×GC) conditions. In the latter configuration, continuous and sequential LC fractions are transferred to the GC column.

The MOSH fraction is transferred and analyzed in the GC dimension, where it appears typically as a “hump”. Moreover, the use of LC–GC×GC–qMS appears to be an interesting option to “see and identify” what is beneath anonymous LC–GC–FID hydrocarbon humps.

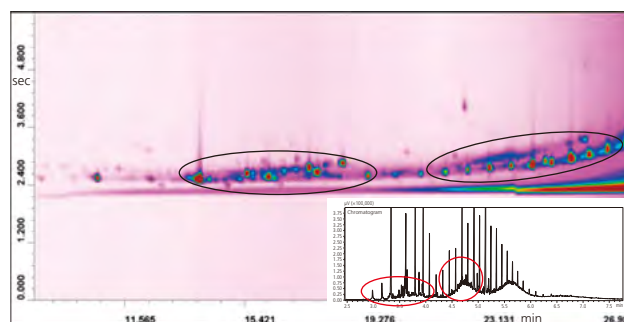

Fig. 2 TIC GC×GC–MS chromatogram relative to the MOSH fraction derived from the salmon (I) baby food.

2. Experimental

2-1. Sample Preparation

All the samples (500 mg) were extracted for three times with hexane (1 mL each, for 15 min), and then each time filtered. After, the filtrates were added together and dried under a gentle nitrogen stream. The extract was weighed (to derive the % of extract) and then diluted to a final concentration of 25% v/v in hexane. Quantification was achieved through a calibration curve, constructed through external standardization. The MOSH hump was integrated through a manual software function, performing the subtraction of the linear alkanes.

2-2. LC–GC–FID Analyses

All sixteen samples were analyzed by using an LC×GC system (Shimadzu) consisting of:

(1) A Shimadzu Prominence LC-20A system, equipped with a CBM-20A communication bus module, two LC-20AD dual-plunger parallel-flow pumps, a DGU-20A degassing unit, an SPD-M20A photodiode array detector, a CTO-20A column oven, and an SIL-20AC autosampler. Data were acquired by the LCsolution software (Shimadzu). LC conditions: a 100 mm L. × 3 mm I.D. × 5 μm *d_p* silica column (SUPELCOSIL LC-Si, Supelco, Milan, Italy) was operated under isocratic conditions, using hexane as mobile phase (0.35 mL/min). Injection volume: 20 μL. At the end of the heart cut, the column was backflushed using CH₂Cl₂.

(2) A Shimadzu AOC-5000 autoinjector equipped with a dedicated dual side-port syringe, employed as a transfer device. Chromatography band transfer is achieved, in the stop-flow mode, through a modified 25-μL syringe. The lower part of the syringe is connected, *via* two transfer lines, to the LC detector exit and to waste. A Teflon plug is located at the end of the syringe plunger; the latter is characterized by a lower OD with respect to the barrel ID, thus enabling mobile phase flow inside the syringe. In the waste mode, the syringe plug is located below both lines and the effluent is directed to waste. In the cut position, the syringe plug is located between the upper and lower line and the effluent flows to the GC. From 0 to 1.5 min the LC effluent was directed to waste, while from 1.5 to 2.0 min the LC effluent was directed to the GC.

(3) A Shimadzu GC-2010 Plus, equipped with an Optic-3 PTV injector (GL Sciences B.V., Eindhoven, The Netherlands). The Optic-3 injector was temperature-programmed as follows: from 75 °C (1 min) to 360 °C at 250 °C/min. Injection mode: split, at a ratio of 200:1 for 1 min during sample introduction and solvent vent, then splitless for 1 min during sample desorption and transfer, then 50:1 for the remaining analysis time.

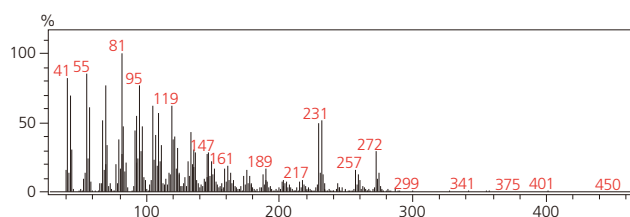

Fig. 3 Mass spectrum extracted from the first “cycloalkane zone”.

Data were acquired by the GCsolution software. GC conditions: an SLB-5 ms [silphenylene polymer, virtually equivalent in polarity to poly (5% diphenyl/95% methylsiloxane)] 15 m L. × 0.10 mm I.D. × 0.10 μm *d_f* column (Supelco) was heated from 50 °C (1 min) to 360 °C (4 min) at 70 °C/min. Carrier gas, hydrogen, was supplied at an initial pressure of 529 kPa (constant linear velocity: 100 cm/s). FID (360 °C) sampling frequency was 50 Hz.

A dedicated LC×GC software enabled the control of each instrument through the respective native software. The LC×GC software controlled the transfer process. All parameters, including the LC and GC methods, can be saved with the LC×GC method.

2-3. GC×GC–MS Analyses

All GC×GC applications were carried out on a Shimadzu GC×GC–MS system, consisting of a GC-2010 gas chromatograph, and a GCMS-QP2010 Plus quadrupole mass spectrometer. The primary column, an SLB-5 ms 30 m L. × 0.25 mm I.D. × 0.25 μm *d_f* column, was connected to an uncoated capillary segment (1.0 m L. × 0.25 mm I.D., used to create a double-loop), by using an SGE SilTite mini-union (SGE, Ringwood, Victoria, Australia). The uncoated capillary was then connected to a segment of BPX50 (50% phenyl polysilphenylene–siloxane) 1.5 m L. × 0.10 mm I.D. × 0.10 μm *d_f* column (SGE), by using another union. Modulation was carried out every 6 s, by using a loop-type modulator (under license from Zoex Corporation, Houston, TX, USA). The duration of the hot pulse (350 °C) was 375 ms.

Table 1 Samples analyzed, total levels of contamination, and contamination considering an upper boundary defined by C₂₅.

Baby food	MOSH (mg/kg)	≤ C ₂₅ alkanes (mg/kg)
1 - Salmon I	13.8	2.0
2 - Plaice	3.5	0.9
3 - Chicken	3.0	1.4
4 - Beef I	1.9	0.8
5 - Beef II	5.6	2.2
6 - Beef-Ham	4.9	2.0
7 - Turkey	3.2	1.1
8 - Sea bass	1.4	0.9
9 - Calf	2.5	0.7
10 - Rabbit	3.5	1.0
11 - Ostrich	1.6	—
12 - Salmon II	1.1	—
13 - Prune I	0.6	—
14 - Pear	3.6	0.6
15 - Fruit mix	0.3	—
16 - Prune II	10.5	1.8

MS parameters: the samples were analyzed in the full scan mode, using a mass range of 40–460 m/z ; spectra generation frequency: 25 Hz; interface and ion source temperatures were 300 °C and 200 °C, respectively. MS ionization mode: electron ionization. GC oven temperature program: 80–360 °C at 10 °C/min. Carrier gas, helium, was supplied at an initial pressure of 250 kPa (constant linear velocity). Injection temperature: 350 °C. Injection mode and volume: split (1:10), 4 μ L. Data were collected by the GCMsolution software; bi-dimensional visualization was carried out by using the Chrom-Square v. 2.0 software.

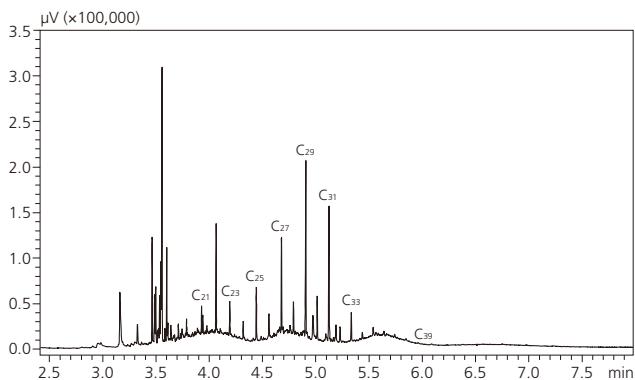

Fig. 4 LC-GC-FID chromatogram for the beef (II) baby food sample.

3. Method Validation

A seven-point calibration curve was constructed using solutions of mineral oil saturated hydrocarbons in hexane at the 1, 5, 10, 20, 50, 100, and 200 ppm levels ($n = 3$). The area of each MOSH hump was integrated by using the GC-FID “manual integration” software function; the n -alkane areas on top of the hump were subtracted from the final result. The derived calibration curve was linear in the range of concentrations considered and was characterized by a regression coefficient (R^2) of 0.9994. Intra-day precision was calculated by analyzing one sample, six times consecutively. The resulting standard deviation equaled ± 1.5 mg/kg (average value: 35.2 mg/kg), while the coefficient of variation was 4.1%. Inter-day precision was calculated by analyzing sample no. 9 three times, on five consecutive days. The resulting standard deviation equaled ± 0.34 mg/kg (average value: 14.5 mg/kg), while the coefficient of variation was 2.4%. Limits of detection and quantification were calculated by multiplying the standard deviation of the area of the “blank” olive oil sample ($n = 3$) three and ten times, respectively, and then dividing the result by the slope of the calibration curve. The values extrapolated, namely 0.15 and 0.5 mg/kg, gave final LOD and LOQ values of 0.6 and 2 ppm, respectively. Such LOD and LOQ values can be considered as acceptable.

4. Results and Discussion

Initially, the scope of the present research was to apply an LC-GC method to baby foods, prepared using vegetable oil. Twelve homogenized solid baby foods, containing either meat or fish (and vegetable oil), were subjected to analysis (Table 1). Three products were fish-based (2 salmon, sea bass, plaice), while all the others contained meat as the main ingredient (chicken, 2 beef, calf, beef-ham, turkey, rabbit, ostrich). Hexane baby food extraction was performed three times; the fourth extraction gave a negligible analytical response. The vegetable oil used as an ingredient was, in all twelve cases, sunflower oil and on the basis of its position in the ingredient list it was certainly present in low amounts (most probably less than 5%). A hexane blank was analyzed periodically throughout the period of research, by drying a 3 mL volume of hexane (the volume used for sample extraction), by adding a 50 μ L volume of hexane to the residue, and then subjecting a 20 μ L quantity to LC-GC analysis. The resulting chromatograms were always characterized by a negligible response. As can be observed in Table 1, the meat and fish baby foods were all contaminated (the results are the average of two applications), to various degrees. Also reported in the table are (approximate) MOSH concentrations considering the upper alkane boundary on the basis of the BMELV proposal (MOSH up to C_{25}). The highest MOSH level, namely 13.8 mg/kg, was found in the salmon I sample.

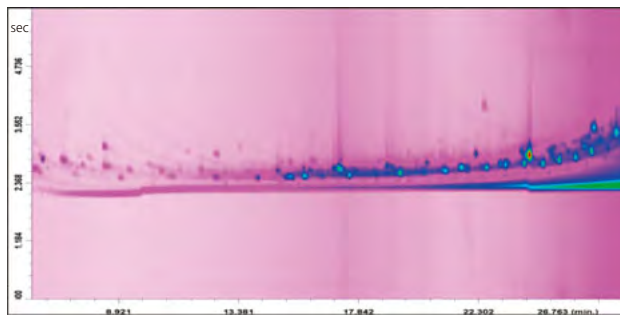

Fig. 5 TIC GCxGC-MS chromatogram relative to the MOSH fraction derived from the beef (II) baby food sample.

Considering contamination up to the C_{25} point, the MOSH concentration was approximately 2.0 mg/kg, well over the proposed maximum limit (0.6 mg/kg). The GC chromatogram, relative to the salmon I baby food, is reported in Fig. 1. The chromatogram is characterized by two predominant humps (and two external smaller ones) centered roughly at n -alkane C_{27} and C_{36} . After quantification, the MOSH “humps” were subjected to a qualitative investigation. A four-dimension off-line LC-GCxGC-qMS experiment was carried out as follows: the 175 μ L MOSH fraction was collected, dried, and the residue was solubilised in 10 μ L of hexane. Four microliters were injected into the GCxGC-qMS system (split ratio: 1:10), leading to an injected MOSH quantity about 25 times lower than that analyzed by using LC-GC-FID. However, the enhanced sensitivity of cryogenic modulation was something that was counted on. The LC-apolarGCxpolarGC-qMS result, which is shown in Fig. 2, was attained in a relatively short time (<30 min), but obviously could not match the speed of the LC-GC second dimension. The LC-GC-FID result, for the salmon I sample, is also included in the same figure to make a direct comparison easier.

A mass spectrum derived from the “cycloalkane zone” is shown in Fig. 3. The “cyclics” were identified on the basis of (I) bidimensional chromatogram location, and (II) information reported in the literature, related to the fragmentation of cycloalkanes^[5]: the molecular ion intensity is more abundant in cycloalkanes than in straight-chain alkanes, as is also the tendency to lose even-numbered fragment ions, producing a greater number of even-numbered mass ions. Compounds containing cyclohexyl rings tend to produce ions at m/z 83, 82 and 81 corresponding to ring fragmentation, and loss of one and two hydrogen atoms, respectively. A further example of MOSH contamination can be observed in Fig. 4 and 5, which illustrates the LC–GC–FID result for beef sample II. The MOSH levels in the beef sample were approximately one third (5.6 ppm) of that found in the salmon. However, the contamination type is different because three MOSH humps are present, with the second and third spanning the C_{25} – C_{39} range, and the first starting approximately at C_{19} and ending at C_{24} . Considering the C_{25} boundary, the MOSH concentration was 2.2 mg/kg. With regards to the other samples reported in Table 1, it can be affirmed as follows: the third most contaminated sample, namely beef-ham (4.9 ppm), generated a GC chromatogram characterized by two humps, in the C_{19} – C_{24} ($\approx 40\%$) and C_{25} – C_{42} range. Such a contamination level and type is comparable to that observed in beef sample II. Five other samples were characterized by MOSH levels around the 3 ppm mark (plaice, chicken, turkey, calf, rabbit), while the remaining four baby foods, namely beef (sample I), ostrich, sea bass, and salmon II were the less contaminated ones, with values under 2 ppm. It must be emphasized that only two baby foods, namely ostrich and salmon II, were characterized by a MOSH contamination lower than the “ C_{25} ” limit. At this point, it was decided to extend the study to fruit-based baby foods, namely products containing no vegetable oil. Four samples (2 prunes, 1 pear, 1 fruit mix) were subjected to analysis, and found to contain MOSH concentrations in the range 0.3–10.5 mg/kg (Table 1). Two baby foods, namely prune I and fruit mix, were characterized by a MOSH presence within the “ C_{25} ” limit, while the pear sample was right at the limit; the prune II sample was, on the other hand, the second most contaminated, considering all the baby foods subjected to analysis (Table 1). The results attained from the fruit products clearly indicated that the presence of MOSH was not only due to that of the vegetable oil.

5. Conclusions

All the baby foods analyzed in the present research were found to be MOSH contaminated, with considerable levels being observed (average value: 3.8 mg/kg). In fact, if one refers to the 0.6 mg/kg limit proposed by the BMELV, the contamination levels must be evaluated as high, especially considering the age and body weight of the consumers. In fact, taking into account the C_{25} boundary, the average MOSH concentration was approx. 1 mg/kg. The presence of MOSH has been found in human milk^[6], and on the basis of the present findings, there is a high probability that MOSH intake continues as soon as the infant passes on to solid food. It is clear that the origin of the MOSH contamination observed, in all samples, cannot be exactly pinpointed, though the vegetable oil probably plays a role. The hydrocarbon molecular-weight range also varied, meaning that the contamination most certainly came from different sources.

References

- [1] K. Grob, *et al. Food Addit. Contam.* 8 (1991) 437.
- [2] K. Grob, *et al. J. AOAC Int.* 74 (1991) 506.
- [3] C. Droz, *et al. Z. Lebensm. Unters. Forsch.* 205 (1997) 239.
- [4] Summary Minutes of the Meeting of the Standing Committee on the Food Chain and Animal Health, June 20, 2008.
- [5] F. G. Kitson, B. S. Larsen, C. N. McEwen. *Gas Chromatography and Mass Spectrometry*, Academic Press, 1996.
- [6] N. Concin, *et al. Food Chem. Toxicol.* 46 (2008) 544.

Application News

No. SCA-100-001

Food – MOSH/MOAH

Mineral Oil Residues in Food Part 1- Dry Food (Flour, Noodles and Rice)

■ Introduction

Mineral oil (MO) residues in food raised public concern due to some elevated concentrations up to several thousand milligrams per kilogram food [1]. Due to the chemical structures two groups of MOs can be differentiated. Mineral oil saturated hydrocarbons (MOSH) consist of linear and branched alkanes, and alkyl-substituted cyclo-alkanes, whilst mineral oil aromatic hydrocarbons (MOAH) include mainly alkyl-substituted polyaromatic hydrocarbons. Technical grades of mineral oil contain aromatic hydrocarbons in a concentration range from 15-35%. Food grade mineral oils (white oils) can have lower MOAH concentrations. Rice and pasta and other grain based food products including flour from different grain varieties are consumed in high amounts all over the world. The annual rice consumption per capita is over 54 kg per capita [2]. The annual pasta consumption in Italy is 26 kg and approximately 8 kg in Germany [3].

At the moment there are no legal limits in Europe for MOSH/MOAH, but MOSH concentrations up to 2 mg/kg and MOAH levels below 0,5 mg/kg are considered to be acceptable.

■ System Setup

For the determination of the two mineral oil fractions an online LC-GC –FID system was

used. The LC is directly connected to two high temperature GC columns with retention gaps which are installed in one GC oven. MOSH and MOAH fractions are separated on a silica gel column using a n-hexane /dichloromethane gradient. The interface between LC and GC is controlled by Axel Semrau LC-GC Chronect interface. After transferring the MOSH fraction on column 1 and MOAH on column 2 the temperature programme is started and both fractions are separated simultaneously and detected by FID. Figure 1 shows a typical LC-Chromatogram with UV-signal in black, pump pressure in green, CH₂Cl₂ concentration in blue and total flow in purple. Figure 2 shows the LC-GC-FID system.

LC Parameters:

Shimadzu LC-20AD solvent delivery pump
Column: Allure Silica 5 µm (250 × 2.1 mm)
Gradient: Start with 100 % n-Hexane (flow 0.3 ml/min), CH₂Cl₂ raised to 35 % within 2 min (hold for 4.20 min), column was flushed at 6.30 min with 100 % CH₂Cl₂ (flow 0.5 ml/min; hold for 9 min) and reconditioned to 100 % n-Hexane (flow 0.5 ml/min; hold for 10 min). Flow was decreased afterwards to 0.3 ml/min until next injection.
UV-Detector: D₂-lamp; 230 nm, 40 °C cell temperature

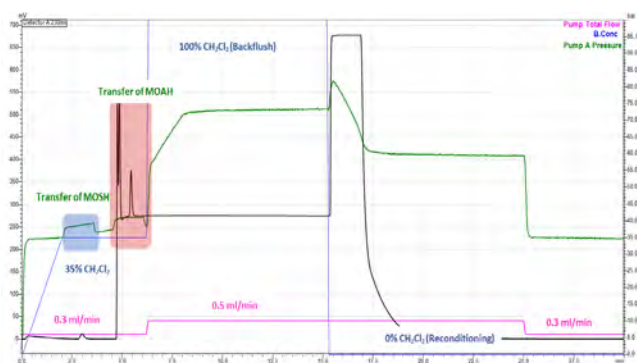

Fig. 1: LC-Chromatogram

GC Parameters:

Shimadzu GC-2010 Plus dual FID
Guard Columns: Restek MXT Siltek (10 m × 0.53 mm id)
Columns: Restek MTX ®-1 (15 m × 0.25 mm id × 0.1 µm df)
Carrier gas: Hydrogen (150 kPa analysis pressure; evaporation pressure: 87 kPa MOSH, 85 kPa MOAH)
Temperature program:
60 °C (6 min) @ 20 °C/min to 100 °C (0 min)
and followed by 35 °C/min to 370 °C (9.29 min)



Fig. 2: LC-GC-FID System

■ Experimental Work

Sample preparation

Depending on the expected mineral oil concentration 1-10 g of homogenized and finely ground samples were used. The sample was extracted in Hexane/Ethanol 1/1 after the addition of an internal standard mixture (Restek MOSH/MOAH standard Cat.#: 31070 containing 9 internal standards) at room temperature for 2 hours under

occasionally shaking the flask. After the extraction water was added and centrifuged. The washing step was repeated a second time. Afterwards the organic layer was dried over anhydrous sodium sulphate and the volume was adjusted to 1 mL in an automated solvent concentrator. The extract was transferred into a 2 mL autosampler vial and put in the autosampler rack of the LC-GC system. Aliquots of 50 µl were injected into the LC. Here the separation into the MOSH- and MOAH fraction is performed. Each fraction has a size of 450 µL and is transferred to the respective channel of the GC for parallel MOSH/MOAH determination.

Quantification

For the quantification of the MOSH fraction the internal standard Bicyclohexyl (CyCy) is used. For the MOAH fraction 2-Methylnaphtahlene (2-MN) is used. All other internal standards are used to ensure no losses of analytes and a good separation between the MOSH and MOAH fraction.

According to a proposed method published by the German Bundesinstitut für Risikobewertung (BfR) quantification is done by integration of the hump for different molecular weight regions. They propose for food contact materials three ranges for the MOSH fraction (C₁₀-C₁₆, C₁₆-C₂₅ and C₂₅-C₃₅) and two ranges for the MOAH fraction (C₁₀-C₂₅, C₂₅-C₃₅). For dry food only the ranges up to C₂₅ are used [4]. Figure 3 shows the MOSH (black trace) and MOAH (purple trace) of a spaghetti sample with a MOSH concentration of 12.7 mg/kg from C₁₆-C₃₅ and the marked regions of C₁₆-C₂₅ (blue) and C₂₅-C₃₅ (red). The internal standards are marked with symbols (black squares internal standards MOSH: C₁₁, Bicyclohexyl, C₁₃ and Cholestane eluting with the MOSH hump, purple stars internal standards MOAH: Pentylbenzene, 1 & 2-Methylnaphthalene, Tri-tert-butylbenzene and Perylene). The rice sample (Figure 3) shows also additional peak in the rear part of the chromatogram. These are naturally occurring odd-numbered alkanes with a chain length of C₂₁ to C₃₅.

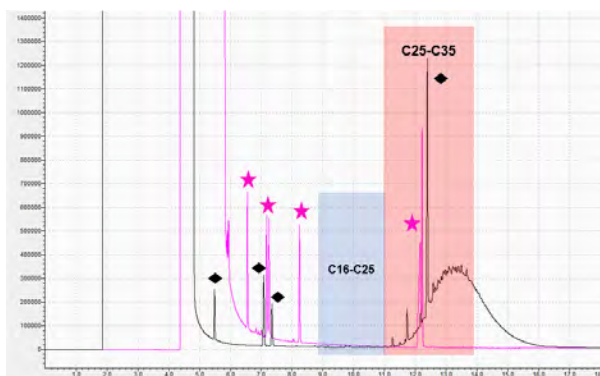

Fig. 3: Spaghetti sample

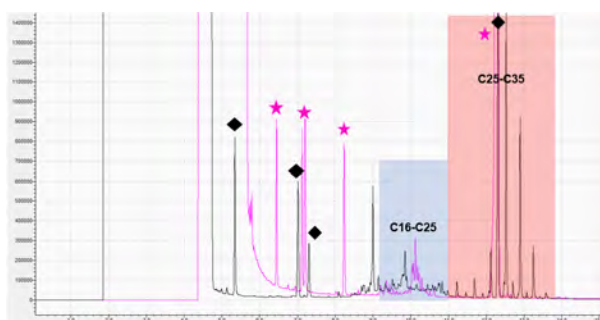

Fig. 4: Rice sample

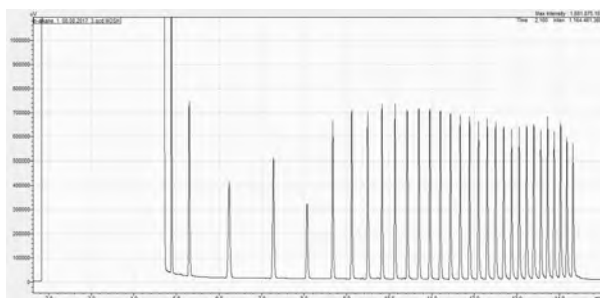

Fig. 5: n-Alkane standard C10-C40 as retention time marker

■ Conclusion

The new LC-GC-FID provides a tool for fast and reliable routine analysis of MOSH and MOAH in dry non fatty food. After the extraction step the samples are analysed fully automated with a high sample through put.

■ References

- 1) EFSA Panel on Contaminants in the Food Chain (CONTAM) Scientific Opinion on Mineral Oil Hydrocarbons in Food
DOI: 10.2903/j.efsa.2012.2704
- 2) Link:
<https://www.statista.com/statistics/256002/global-per-capita-rice-use-since-2000/>
- 3) Link:
<http://www.internationalpasta.org/index.aspx?idsub=118>
- 4) Link:
<http://www.bfr.bund.de/cm/343/bestimmung-von-kohlenwasserstoffen-aus-mineraloel-oder-kunststoffen.pdf>

[← Return to main page](#)

Dairy Products



1. A High Sensitivity LC/MS/MS Method with QuEChERS Sample Pre-treatment for Analysis of Aatoxins in Milk Powder Samples
2. Assay of Aflatoxin M1 in Milk Based on Notification Test Methodology, Using Prominence-i and the RF-20AXS Fluorescence Detector
3. Determination of Polychlorinated Dibenzo-p-dioxins and Dibenzofurans (PCDD/Fs) in Foodstuffs and Animal Feed Using a Triple Quadrupole GCMS-TQ8040 System with Smart MRM Transforms Laboratory Analysis
4. Analysis of Minerals and Harmful Elements in Formula Milk Powder Using ICPMS-2030
5. Milk and Dairy Product Profiling Using iD^{plus}
6. Development of an UHPLC Method for Simultaneous Determination of Thirteen Bisphenols in Milk Samples
7. Ultra-High-Speed Analysis of Melamine in Powdered Milk Using LDTD-MS/MS
8. Determination of 5 Kinds of Estrogens in Milk using LCMS-8045
9. Determination of Imidocarb Residues in Milk by Ultra-High Performance Liquid Chromatography Coupled with Triple Quadrupole Mass Spectrometry
10. Analysis of Toxic Elements in Processed Milk Products using ICP-MS
11. Analysis of Nutritional and Harmful Elements in Powdered Milk by ICPE-9820 / HVG-1

A High Sensitivity LC/MS/MS Method with QuEChERS Sample Pre-treatment for Analysis of Aflatoxins in Milk Powder Samples

ASMS 2016 WP230

Yin Ling Chew¹; Jie Xing¹; Leonard Guan Seng Lim^{*2};
Zhaoqi Zhan¹

¹Application Development & Support Centre,
Shimadzu (Asia Pacific) Pte Ltd, Singapore;

²School of Physical & Mathematical Sciences,
Nanyang Technological University, Singapore,

*Student

A High Sensitivity LC/MS/MS Method with QuEChERS Sample Pre-treatment for Analysis of Aflatoxins in Milk Powder Samples

Introduction

Aflatoxins (B1, B2, G1 and G2) are metabolites produced by fungi (*Aspergillus favus* and *Aspergillus parasiticus*) in crops, animal feed and dairy products. Aflatoxins are highly toxic contaminants in food and feed and their amounts increase under bad storage conditions favourable for fungal growth. Aflatoxin M1 is a hydroxylated metabolite of aflatoxin B1 found in milk of cow fed with a diet contaminated with aflatoxin B1^[1]. Aflatoxin B1 is known the most carcinogenic among all the aflatoxins, and hence its metabolite aflatoxin M1 is given critical attention. Strict regulations for aflatoxin M1 in milk and

dairy products have been set. For example, European Union (EU) limits the level of aflatoxin M1 to no more than 0.05 µg/kg in milk and dairy products and 0.025 µg/kg in infant food. We present a high sensitivity LC/MS/MS method for quantitative analysis of the five aflatoxins (B1, B2, G2, G2 and M1) in milk powder incorporating QuEChERS sample pre-treatment procedure, which is more cost effective as compared to the traditional procedure using immunoaffinity column (IAC)^[2]. High sensitivity and good recoveries were achieved using this LC/MS/MS method.

Experimental

A mixed standard of aflatoxin B1, B2, G1 and G2 was obtained from Supelco. Aflatoxin M1 was obtained from Romer Labs. A stock solution of the mixture of 5 aflatoxins was prepared using methanol as the diluent, from which calibrant series and spiked samples were prepared. The QuEChERS kits were purchased from RESTEK. Two grams of milk powder was first extracted with the extraction kits followed by cleaning up using

dSPE tubes. A LCMS-8060 triple quadrupole LC/MS/MS (Shimadzu Corporation, Japan) was used in this work. A C18 column (Kinetex, 2.1 x 100mm, 1.7µm) was used for fast separation of aflatoxins using a gradient elution program. Method performance evaluation were carried out using spiked aflatoxins in milk powder samples. Table 1 shows the analytical conditions on LCMS-8060.



Shimadzu LCMS-8060, an UFMS triple quadrupole system with a heated ESI interface

A High Sensitivity LC/MS/MS Method with QuEChERS Sample Pre-treatment for Analysis of Aflatoxins in Milk Powder Samples

Table 1: LC/MS/MS analytical conditions of aflatoxins on LCMS-8060

Column	: Kinetex C18 (2.1mmL.D x 100mmL., 1.7 µm)
Flow rate	: 0.5 mL/min
Mobile phase	: A: 5 mM ammonium acetate in water with 0.1% FA B: 5 mM ammonium acetate in MeOH
Oven temp.	: 40°C
Injection vol.	: 5 µL
Elution mode	: Gradient elution, B%: 5% (0-5 min) 50% (4- 5.5 min) 85% (6-7.5 min) 5% (8.1-10 min)
Interface	: ESI (Heated)
MS mode	: Positive, MRM, 2 transitions each compound
Interface temp.	: 350°C
Block temp.	: 400°C
DL temp.	: 250°C
CID gas	: Ar (350 kPa)
Nebulizing gas flow	: 3.0 L/min
Drying gas flow	: 10.0 L/min
Heating gas flow	: 10.0 L/min

Results and Discussion

QuEChERS sample pre-treatment

Hexane was used in the procedure to remove fats, oils and non-polar components from the milk powder samples. The extraction step was completed using Q-sep QuEChERS extraction salt packet (4 g MgSO₄, 1 g NaCl, 1 g trisodium citrate dehydrate, 0.5 g disodium hydrogen

citrate). Dispersive SPE tube containing MgSO₄, PSA and C18 was used in the clean-up process to remove remaining water, organic acid and non-polar components respectively. The process of the sample preparation is illustrated in Figure 1.

Method Development

Automated MRM optimisation of the five aflatoxins was carried out using the LabSolutions workstation. Two MRM transitions for every aflatoxin were chosen as quantifier and confirmation ion (Table 2).

A milk powder matrix free from aflatoxins was used as a “blank” and matrix for the preparation of post-spiked calibrants to build calibration curves. The blank and every post-spiked calibrant was injected thrice and the average area was calculated to obtain reliable results.

A High Sensitivity LC/MS/MS Method with QuEChERS Sample Pre-treatment for Analysis of Aflatoxins in Milk Powder Samples

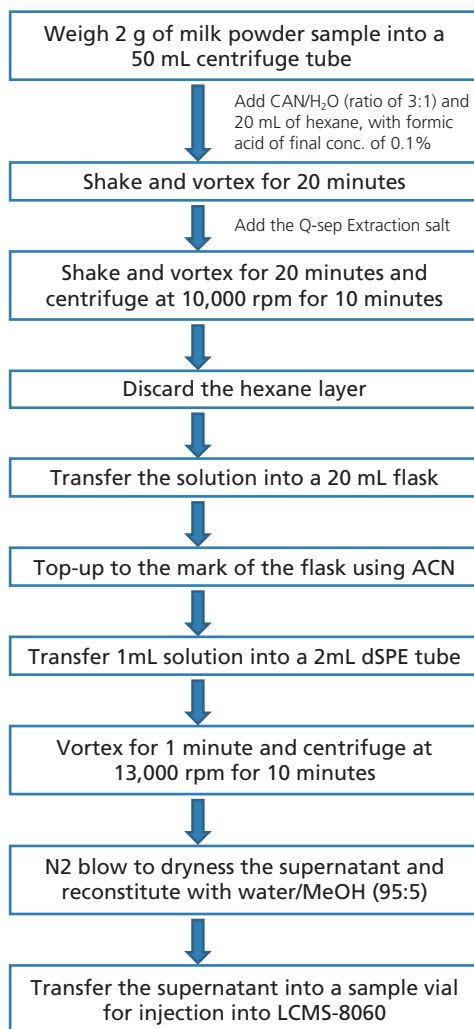

Figure 1: Flowchart of sample pre-treatment for aflatoxins in milk powders by modified QuEChERS method.

Table 2: LC/MS/MS analytical conditions of LCMS-8050 for aflatoxins

Compound	MRM (m/z)	CID Voltage (V)		
		Q1	CE	Q3
Aflatoxin B1	313.1>241.0*	-12	-40	-17
	313.1>213.0	-21	-44	-15
Aflatoxin B2	315.1>287.0*	-22	-27	-20
	315.1>259.1	-11	-30	-18
Aflatoxin G1	329.1>243.0*	-12	-28	-17
	329.1>200.0	-12	-40	-22
Aflatoxin G2	331.1>189.0*	-24	-43	-19
	331.1>245.0	-12	-31	-18
Aflatoxin M1	329.0>273.0*	-12	-23	-18
	329.0>259.0	-23	-24	-29

* MRM transitions used as quantifiers.

A High Sensitivity LC/MS/MS Method with QuEChERS Sample Pre-treatment for Analysis of Aflatoxins in Milk Powder Samples

A chromatogram of spiked sample is shown in Figure 2. Linear calibration curves were obtained for all five aflatoxin compounds with good linearity ($r^2 > 0.999$). The calibration curves of aflatoxins spiked in milk powder matrix are shown in Figure 4.

Method Performance Evaluation

The LOD and LOQ of aflatoxins in milk powder matrix are lower than 0.83 pg/mL and 2.50 pg/mL respectively (Table 3). The repeatability of the method was evaluated using spiked samples at two concentrations. The peak area %RSD of aflatoxins were found to be lower than 7.46%.

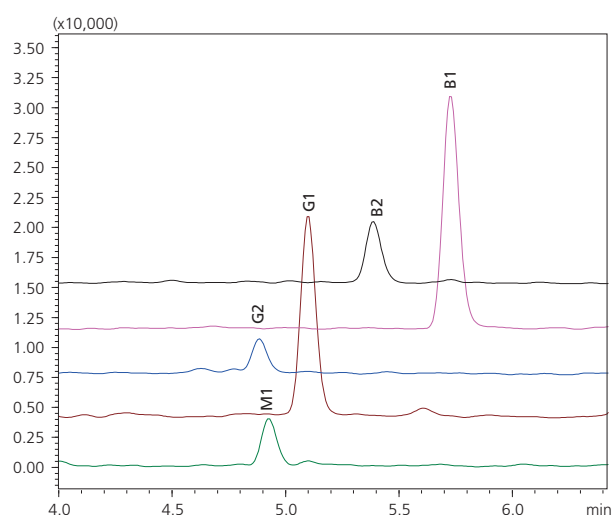

Figure 2: Total ion chromatogram of 5 aflatoxins (Concentrations of B1,G1 and M1 at 10 pg/mL; B2 and G2 at 3 pg/mL)

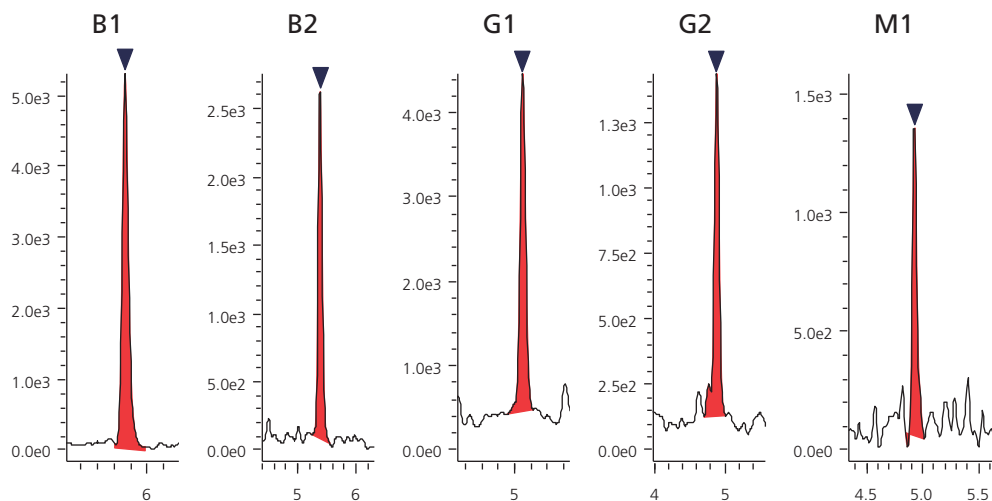

Figure 3: Single LOQ MRM chromatograms of 5 aflatoxins (Concentrations of B1, G1 and M1 (5 pg/mL); B2 and G2 (3 pg/mL))

A High Sensitivity LC/MS/MS Method with QuEChERS Sample Pre-treatment for Analysis of Aflatoxins in Milk Powder Samples

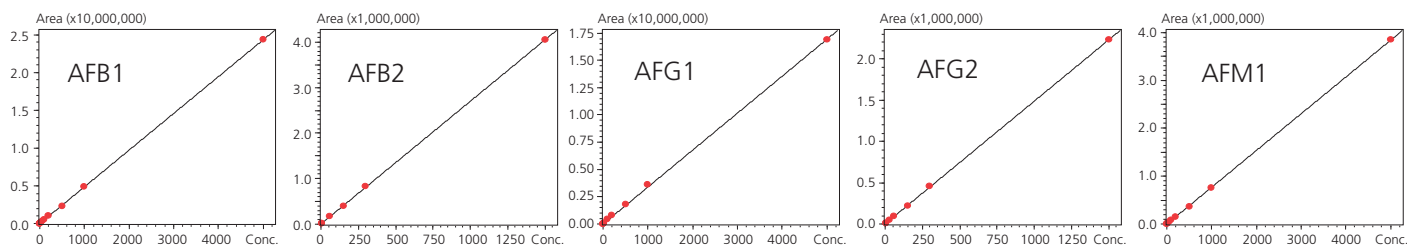

Figure 4: Calibration curves of aflatoxins B1, B2, G1, G2 and M1 in milk powder matrix.

Table 3: LOD, LOQ and repeatability of aflatoxin spiked samples at different concentrations

Aflatoxin	Range (pg/mL)	Linearity	LOD (pg/mL)	LOQ (pg/mL)	%RSD (n=6)			
					5 pg/mL	6 pg/mL	30 pg/mL	50 pg/mL
B1	1-5000	0.9999	0.14	0.44	3.1			2.3
B2	3-1500	0.9999	0.36	1.09		6.4	2.4	
G1	3-5000	0.9998	0.71	2.16	4.0			2.44
G2	3-1500	0.9999	0.41	1.22		5.8	3.5	
M1	3-5000	0.9999	0.83	2.50	7.5			2.7

Both the matrix effect and recoveries of aflatoxins were evaluated by using a duplicate set of samples at different concentrations. Each duplicate was obtained from the average of three injections. The results are shown in Table 4 and Table 5.

Table 4: Matrix effects of the MRM method for aflatoxins in spiked milk powder samples

Concentration (pg/mL)	Matrix effect (%)			Concentration (pg/mL)	Matrix effect (%)	
	B1	G1	M1		B2	G2
5.0	105.1	116.0	99.4	6.0	105.8	116.3
50.0	105.3	107.9	105.4	30.0	110.2	109.3

Table 5: Recoveries of aflatoxins in spiked milk powder samples

Concentration (pg/mL)	Recovery (%)			Concentration (pg/mL)	Recovery (%)	
	B1	G1	M1		B2	G2
5.0	76.6	87.3	83.8	6.0	71.6	70.8
50.0	73.8	76.5	75.6	30.0	73.9	75.6

Analysis of aflatoxins in actual milk powder samples

Three milk powder samples from local supermarket were analysed using the established MRM method. The results showed that no aflatoxin was detected in all three samples.

A High Sensitivity LC/MS/MS Method with QuEChERS Sample Pre-treatment for Analysis of Aflatoxins in Milk Powder Samples

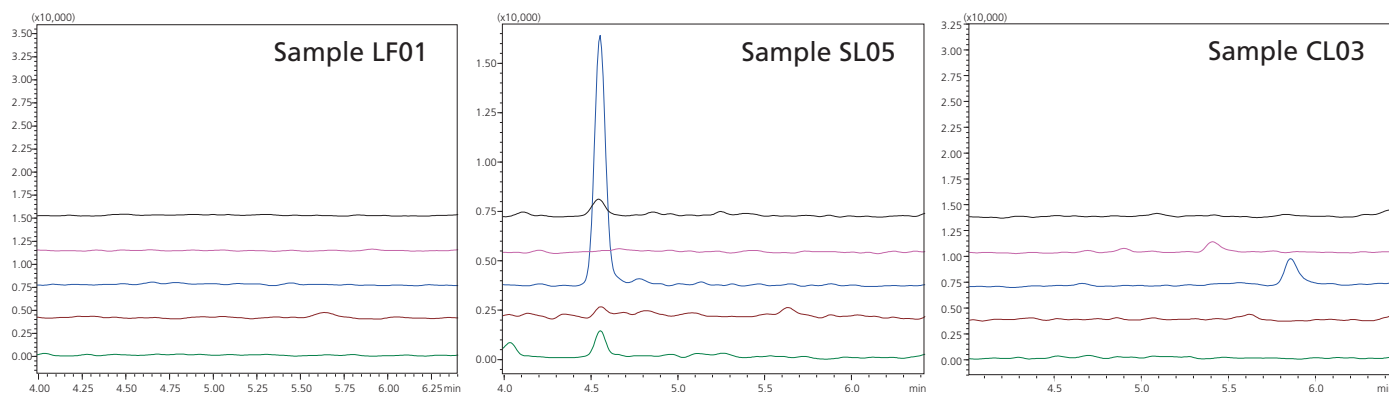

Figure 5: MRM Chromatograms for Aflatoxin B2, B1, G2, G1 and M1 (top to bottom) of three milk powder samples from local supermarket. Targets were not detected in all samples.

Conclusions

A high sensitivity LC/MS/MS method with QuEChERS for sample pre-treatment was established using Shimadzu LCMS-8060 system. The QuEChERS sample preparation method was proven effective and easy to operate. The method performance including sensitivity, linearity,

repeatability, matrix effect and recovery were carried out and the results confirm that the method is feasible and reliable for determination of aflatoxins in milk powder samples.

References

1. Iqbal, S. Z.; Jinap, S.; Pirouz, A. A.; Ahmad Faizal, A.R. *Trends in Food Science & Technology* 2015, 46, 110-119.
2. Cherkani-Hassani, A.; Mojemmi, B.; Mouane, N. *Trends in Food Science & Technology* 2016, 50, 56-69.

Disclaimer: The products and application in this presentation are intended for Research Use Only (RUO). Not for use in diagnostic procedures.

Application News

No.L506

High Performance Liquid Chromatography

Assay of Aflatoxin M₁ in Milk Based on Notification Test Methodology, Using Prominence-i and the RF-20A_{XS} Fluorescence Detector

Aflatoxin M₁ (AFM₁) is a mycotoxin suspected of carcinogenicity in humans that is detected in the milk of mammals that eat food contaminated with aflatoxin B₁. The notification "Handling of Aflatoxin M₁ in Milk" issued on July 23, 2015 (Notification No. 0723-[1] of the Department of Food Safety, PFSB, MHLW)¹⁾ sets a regulatory level for AFM₁ in milk of 0.5 µg/kg, and came into force on January 23, 2016.

The assay methodology for AFM₁ in milk was included in "Test Methodology for Aflatoxin M₁ in Milk" (Notification No. 0723-[5] of the Department of Food Safety, PFSB, MHLW)²⁾, which was announced on the same day and describes two test methodologies.

- (1) Test method consisting of quantitation by HPLC with attached fluorescence detector and confirmation by LC/MS or LC/MS/MS.
- (2) Screening method using an assay kit.

We describe an analysis of commercially available milk that is compliant with test method (1). We analyzed for AFM₁ in bovine milk using the Prominence-i integrated HPLC and the RF-20A_{XS} fluorescence detector. Under these conditions we were able to measure AFM₁ at a concentration of 1/10th Japan's regulatory level for AFM₁ in milk.

■ Analysis of Standard Aflatoxin M₁ Solutions

Chromatograms obtained after analysis of standard AFM₁ solutions (0.1 µg/L, equivalent to 1/100th the regulatory concentration) are shown in Fig. 1, and the analytical conditions used are shown in Table 1. The relative standard deviation (%RSD) of peak areas after repeating analysis six times was 3.4 %. Fig. 2 shows the calibration curve for 0.1 to 20 µg/L. Good linearity was achieved with a contribution ratio R² of ≥ 0.9999 within the concentration range. These results show the RF-20A_{XS} fluorescence detector can be used to analyze trace quantities of AFM₁ with high sensitivity and high precision.

When the standard AFM₁ solution of 0.1 µg/L is processed according to the pretreatment procedure shown in Fig. 3, which follows the notification methodology, it produces a sample equivalent to 1/100th the regulatory level for AFM₁ in milk (0.005 µg/kg).

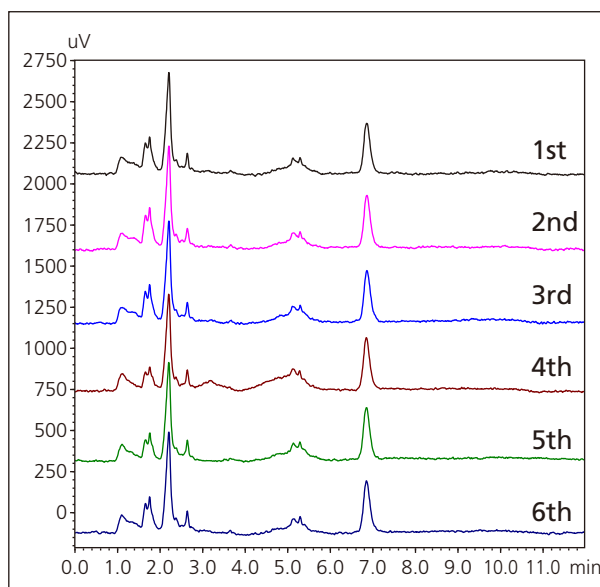

Fig. 1 Chromatograms for Standard AFM₁ Solution Equivalent to 1/100th the Regulatory Concentration (0.1 µg/L, Test Repeated 6 Times)

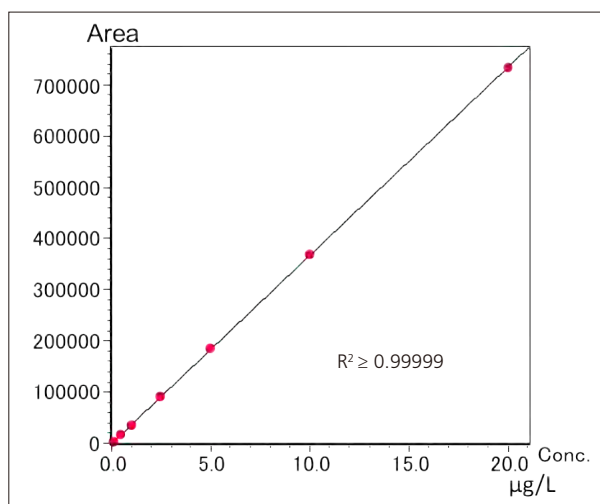

Fig. 2 AFM₁ Calibration Curve (0.1-20 µg/L)

Table 1 HPLC Analytical Conditions

System	:Prominence-i
Column	:Shim-pack VP-ODS (150 mm L. × 4.6 mm I.D., 5 µm)
Mobile Phase	:Water/Acetonitrile = 3/1 (v/v)
Flowrate	:1.0 mL/min
Column Temp.	:40 °C
Detection	:RF-20A _{XS} , Ex. at 365 nm, Em. at 435 nm
RF Cell.	:Conventional Cell
Cell Temp.	:25 °C
Injection Volume	:100 µL

■ Analysis of Aflatoxin M₁ in Milk

We analyzed commercially available milk and milk with added AFM₁. AFM₁ was added to make up a concentration of 0.05 µg/kg in milk (1/10th the regulatory level), and pretreatment was performed according to the notification methodology.²⁾ The pretreatment procedure is shown in Fig. 3. Refer to the notification methodology²⁾ for further details.

An AflaStar™ R* immunoaffinity column from Romer Labs was used to remove contaminant constituents. The chromatograms obtained after analysis of these samples are shown in Fig. 4. (A) is the chromatogram for milk with added AFM₁, and (B) is the chromatogram for milk with no added AFM₁.

The analytical conditions were the same as those used in Fig. 1, which are shown in Table 1.

* "AflaStar" is a registered trademark of Romer Labs.
The AflaStar™ R can be purchased from Shimadzu GLC Ltd.

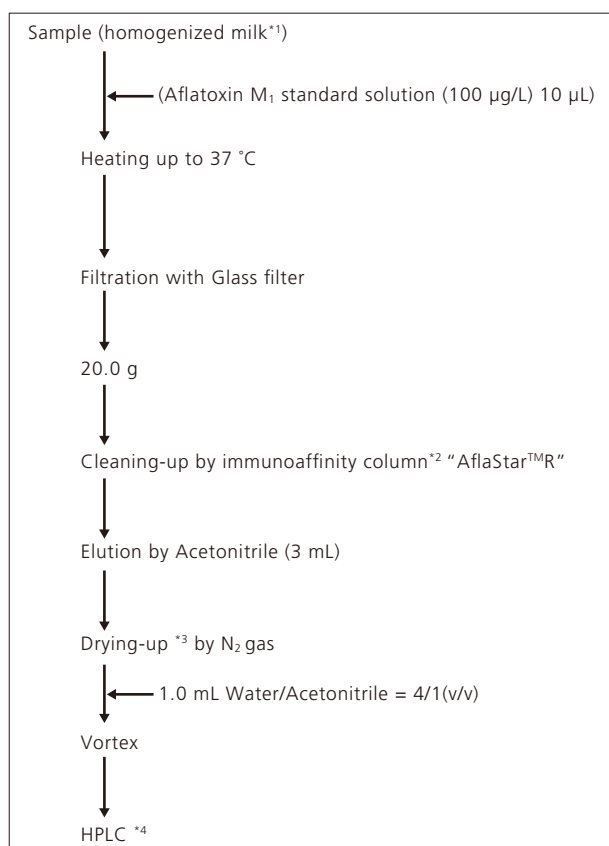

Fig. 3 Milk Pretreatment Procedure

- *1 A pretreatment centrifugation step is needed for raw milk and other milks that are not homogenized. Refer to reference²⁾ for details.
- *2 Refer to the annotations in reference²⁾ for detailed information on use of the immunoaffinity column.
- *3 AFM₁ can adhere to the container during drying, so it is recommended that silane-treated containers be washed with 20 % to 30 % aqueous acetonitrile then dried before use.
- *4 AFM₁ can adhere to glass containers used to hold samples for HPLC even when these containers have been treated with silane, so it is recommended that plastic containers be used.

The percentage recovery calculated according to Eqn. 1 shown below was 98 %. We found that using the RF-20Axs fluorescence detector allows for analysis at concentrations 1/10th the regulatory level with high sensitivity and good precision.

A small peak was observed at the AFM₁ elution position when milk with no added AFM₁ was analyzed. Using LC/MS/MS to analyze the milk with no added AFM₁ suggested this peak was derived from AFM₁, and the concentration of the substance present was below 1/100th Japan's regulatory level.

$$\text{Recovery rate (\%)} = \frac{(\text{Peak area of milk with added standard AFM}_1) - (\text{Peak area of milk with no added standard AFM}_1)}{\text{Peak area of standard AFM}_1 \text{ sample}} \times 100$$

Eqn. 1 Percentage Recovery Equation

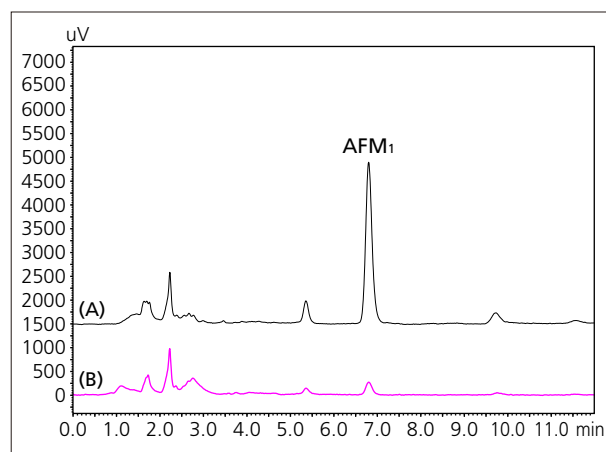

Fig. 4 HPLC Chromatograms for Commercially Available Milk (A) With added standard AFM₁, (B) with no added standard AFM₁

References

- 1) "Handling of Aflatoxin M₁ in Milk" (July 23, 2015, Notification No. 0723-[1] of the Department of Food Safety, PFSB, MHLW)
- 2) "Test Methodology for Aflatoxin M₁ in Milk" (Notification No. 0723-[5] of the Department of Food Safety, PFSB, MHLW)

First Edition: Jun. 2016



Shimadzu Corporation
www.shimadzu.com/an/

For Research Use Only. Not for use in diagnostic procedure.

This publication may contain references to products that are not available in your country. Please contact us to check the availability of these products in your country.

The content of this publication shall not be reproduced, altered or sold for any commercial purpose without the written approval of Shimadzu. Company names, product/service names and logos used in this publication are trademarks and trade names of Shimadzu Corporation or its affiliates, whether or not they are used with trademark symbol "TM" or "®". Third-party trademarks and trade names may be used in this publication to refer to either the entities or their products/services. Shimadzu disclaims any proprietary interest in trademarks and trade names other than its own.

The information contained herein is provided to you "as is" without warranty of any kind including without limitation warranties as to its accuracy or completeness. Shimadzu does not assume any responsibility or liability for any damage, whether direct or indirect, relating to the use of this publication. This publication is based upon the information available to Shimadzu on or before the date of publication, and subject to change without notice.

Technical Report

Determination of Polychlorinated Dibenzo-*p*-dioxins and Dibenzofurans (PCDD/Fs) in Foodstuffs and Animal Feed Using a Triple Quadrupole GCMS-TQ8040 System with Smart MRM Transforms Laboratory Analysis

Pu Wang¹, Huizhong Sun¹, Qinghua Zhang¹, Feifei Tian², Lei Cao²

Abstract:

A method was developed on a high selectively triple quadrupole GCMS-TQ8040 system for screening trace levels of polychlorinated dibenzo-*p*-dioxins and dibenzofurans (PCDD/Fs) in foodstuffs and animal feed. Smart MRM technology was employed for method development and GC-MS/MS analysis. The results showed good sensitivity and repeatability for PCDD/Fs at low levels, as well as a good linear response over the required concentration range. The performance on real sample analysis indicated the feasibility of Shimadzu GCMS-TQ8040 system for PCDD/Fs measurement in food and feed, as required by European Union legislation.

Keywords: GC-MS/MS, MRM, PCDDs, PCDFs, dioxins, food, feed

1. Introduction

Polychlorinated dibenzo-*p*-dioxins and dibenzofurans (PCDD/Fs) are of special concern, due to their harmful health effects. They have neurotoxic potential and are linked to causing cancer, endocrine disruption, and reproductive disorders. PCDD/Fs were never produced intentionally as marketable products, while they are widespread around the world. They can also bioaccumulate and biomagnify through the food chain, and finally pose a threat to human body. Most dioxin exposure to human derives from food (>90%), 90 % of which is of animal origin^[1]. Consequently, incidents of dioxin contamination involving food and feed have generally raised great public concern in the world. For example, Germany's dioxin-tainted food scandal in 2011 led to a shutdown of more than 4700 farms and tremendous economic losses in Germany.

European regulations specifying official sampling and analysis methods for controlling PCDD/F levels and polychlorinated biphenyls (PCBs) in food and feed were initially issued in the early 2000s, followed by

several amendments thereafter. The latest amendment was Commission Regulation (EU) Nos. 589/2014^[2] and 709/2014^[3], where a major update is that gas chromatography–triple quadrupole mass spectrometry (GC-MS/MS) was recognized as an appropriate confirmatory method for checking compliance with the maximum levels of PCDD/Fs and PCBs in food and feed control. This means GC-MS/MS can be used to provide full or complementary information enabling the PCDD/Fs and dioxin-like PCBs to be identified and quantified unequivocally at the maximum or in case of need at the action threshold.

This Technical Report describes a highly sensitive and reproducible method for determining PCDD/Fs (Table 1) in food and feed using a triple quadrupole GCMS-TQ8040 system with Smart MRM, which transforms laboratory analysis process. The results show performance comparable to using high resolution gas chromatography/high resolution mass spectrometry (HRGC/HRMS) for quantitation of PCDD/Fs in food and feed.

Table 1 PCDD/Fs Specified in EU Legislation and TEF Values Established by WHO

Congener	WHO ₁₉₉₈ -TEF	WHO ₂₀₀₅ -TEF	Congener	WHO ₁₉₉₈ -TEF	WHO ₂₀₀₅ -TEF
2,3,7,8-TCDD	1	1	2,3,7,8-TCDF	0.1	0.1
1,2,3,7,8-PeCDD	1	1	1,2,3,7,8-PeCDF	0.05	0.03
1,2,3,4,7,8-HxCDD	0.1	0.1	2,3,4,7,8-PeCDF	0.5	0.3
1,2,3,6,7,8-HxCDD	0.1	0.1	1,2,3,4,7,8-HxCDF	0.1	0.1
1,2,3,7,8,9-HxCDD	0.1	0.1	1,2,3,6,7,8-HxCDF	0.1	0.1
1,2,3,4,6,7,8-HpCDD	0.01	0.01	2,3,4,6,7,8-HxCDF	0.1	0.1
OCDD	0.0001	0.0003	1,2,3,7,8,9-HxCDF	0.1	0.1
			1,2,3,4,6,7,8-HpCDF	0.01	0.01
			1,2,3,4,7,8,9-HpCDF	0.01	0.01
			OCDF	0.0001	0.0003



2. Experimental

2-1. Sample Preparation and Instrumental Analysis

The sample preparation of food and feed was mainly followed US EPA method 1613B^[4] with proper modification^[5]. The samples were extracted using an accelerated solvent extraction (ASE) system, followed by purification steps (including acidic/basic silica gel, alumina, and carbon columns). Samples were spiked with ¹³C-isotope labeled surrogate standards (1613-LCS) and internal standards (1613-IS) prior to extraction and instrumental analysis, respectively.

Samples were analyzed in a Shimadzu GCMS-TQ8040 system with Smart MRM, which transforms laboratory analysis process. The GC unit was equipped with a split/splitless injection port. The capillary column was a 60 m DB-5MS fused silica capillary column (J&W, Scientific, 0.25 μm film thickness, 0.25 mm I.D.). Table 2 showed the selected instrumental conditions for PCDD/Fs detection. Measurements were performed in EI-MS/MS Multiple Reaction Monitoring (MRM) mode. The MRM method for PCDD/Fs was developed using the Shimadzu

GCMS-TQ8040 MRM optimization tool, which automatically determines the optimum transitions and collision energies in a single sequence, and then seamlessly incorporates them into the Smart Database series for full method development (Fig. 1). At that point, the two most intense ions of the molecular chlorine isotope cluster of each congener and internal standard were chosen. Using flexible MS event, the Smart MRM function routinely determines the best dwell and loop times for the two transitions in a single method, providing optimum precision and sensitivity. In order to improve the peak shape for 2,3,7,8-TCDD/F at very low concentration levels (10 fg/μL), the event times were manually increased to 0.35 seconds for the native 2,3,7,8-TCDD/F and decreased to 0.20 seconds for the ¹³C-labeled 2,3,7,8-TCDD/F to maintain the same loop time as other congeners. Information on the MRM settings and analyte retention times are given in Table 3.

Table 2 Conditions for Gas Chromatograph and Mass Spectrometer

GC Conditions		MS Conditions	
Column	: DB-5MS (60 m × 0.25 mm × 0.25 μm)	Ionization Mode	: EI
Injection Mode	: Splitless	Ion Source Temperature	: 250 °C
Injection Volume	: 2 μL	Interface Temperature	: 270 °C
High Pressure Injection	: 300 kPa (2 min)	Acquisition Mode	: MRM Mode
Sampling Time	: 1 min	Collision Gas	: Argon
Injection Temperature	: 290 °C	Emission Current	: 250 μA
Column Oven Temperature	: 150 °C (3 min) → (20 °C/min) → 230 °C (18 min) → (5 °C/min) → 235 °C (10 min) → (4 °C/min) → 320 °C (1 min)	Loop Time	: 1.1 sec
Flow Control Mode	: Linear Velocity	Pressure of CID Gas	: 150 kPa
Column Flow	: 1.03 mL/min	Detector Voltage	: 1.8 kV

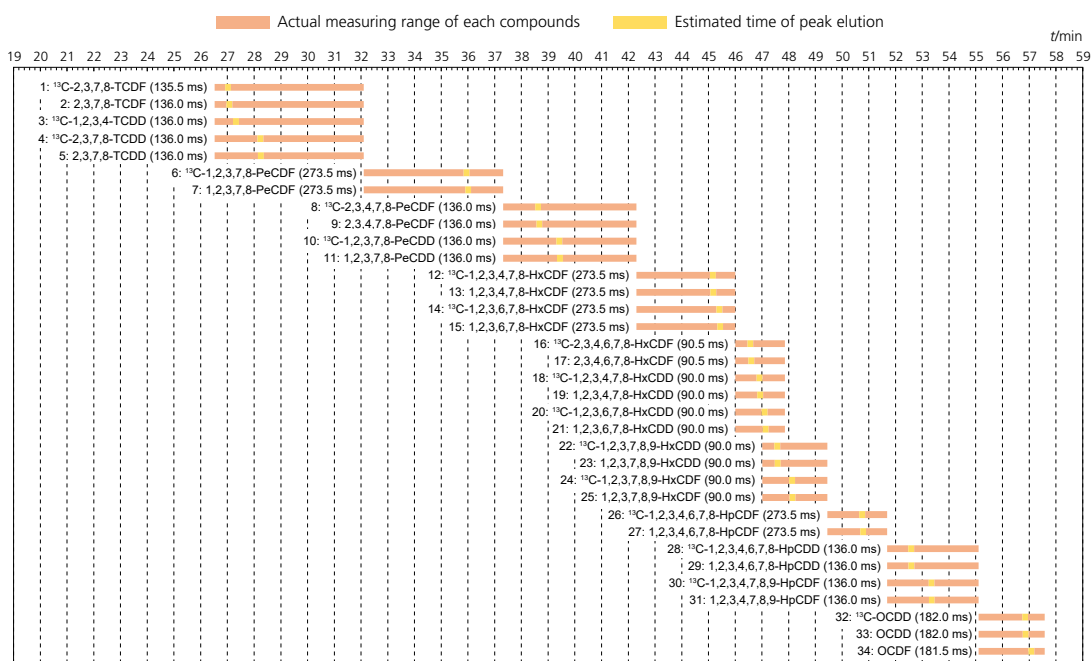

Fig. 1 Optimized MS Event Times for PCDD/F Congeners with Smart MRM Function

3. Results and Discussion

3-1. Chromatography

The chromatographic separation of the 17 native 2,3,7,8-substituted PCDD/F congeners is shown in Fig. 2 (EPA 1613 CS3). The sample was completely separated in a total run time of 60 minutes.

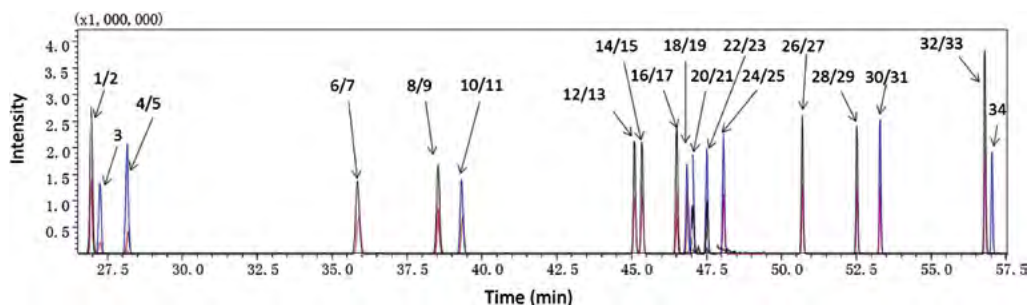

Fig. 2 Mass Chromatogram of PCDD/Fs in EPA 1613 CS3 (10 – 100 µg/L) (Peak numbers refer to analytes listed in Table 3.)

Table 3 MS/MS Settings for Native PCDD/F Congeners and ¹³C-Internal Standards

Peak No.	Analyte	RT (min)	Precursor > Product	CE (V)	Precursor > Product	CE (V)
1	¹³ C-2,3,7,8-TCDF	27.024	315.90 > 251.90	31	317.90 > 253.90	31
2	2,3,7,8-TCDF	27.076	303.90 > 240.90	31	305.90 > 242.90	31
3	¹³ C-1,2,3,4-TCDD	27.323	331.90 > 267.90	25	333.90 > 269.90	25
4	¹³ C-2,3,7,8-TCDD	28.235	331.90 > 267.90	25	333.90 > 269.90	25
5	2,3,7,8-TCDD	28.253	319.90 > 256.90	25	321.90 > 258.90	25
6	¹³ C-1,2,3,7,8-PeCDF	35.953	351.90 > 287.90	34	349.90 > 285.90	34
7	1,2,3,7,8-PeCDF	36.01	339.90 > 276.90	34	337.90 > 274.90	34
8	¹³ C-2,3,4,7,8-PeCDF	38.625	351.90 > 287.90	37	349.90 > 285.90	37
9	2,3,4,7,8-PeCDF	38.673	339.90 > 276.90	37	337.90 > 274.90	37
10	¹³ C-1,2,3,7,8-PeCDD	39.419	367.90 > 303.90	25	365.90 > 301.90	25
11	1,2,3,7,8-PeCDD	39.441	355.90 > 292.90	25	353.90 > 290.90	25
12	¹³ C-1,2,3,4,7,8-HxCDF	45.168	385.80 > 321.90	37	387.80 > 323.90	37
13	1,2,3,4,7,8-HxCDF	45.183	373.80 > 310.90	37	375.80 > 312.90	37
14	¹³ C-1,2,3,6,7,8-HxCDF	45.413	385.80 > 321.90	37	387.80 > 323.90	37
15	1,2,3,6,7,8-HxCDF	45.438	373.80 > 310.90	37	375.80 > 312.90	37
16	¹³ C-2,3,4,6,7,8-HxCDF	46.568	385.80 > 321.90	37	387.80 > 323.90	37
17	2,3,4,6,7,8-HxCDF	46.604	373.80 > 310.90	37	375.80 > 312.90	37
18	¹³ C-1,2,3,4,7,8-HxCDD	46.911	401.80 > 337.90	25	403.80 > 339.80	25
19	1,2,3,4,7,8-HxCDD	46.935	389.80 > 326.90	25	391.80 > 328.80	25
20	¹³ C-1,2,3,6,7,8-HxCDD	47.1	401.80 > 337.90	25	403.80 > 339.80	25
21	1,2,3,6,7,8-HxCDD	47.139	389.80 > 326.90	25	391.80 > 328.80	25
22	¹³ C-1,2,3,7,8,9-HxCDD	47.577	401.80 > 337.90	25	403.80 > 339.80	25
23	1,2,3,7,8,9-HxCDD	47.591	389.80 > 326.90	25	391.80 > 328.80	25
24	¹³ C-1,2,3,7,8,9-HxCDF	48.126	385.80 > 321.90	34	387.80 > 323.90	34
25	1,2,3,7,8,9-HxCDF	48.145	373.80 > 310.90	34	375.80 > 312.90	34
26	¹³ C-1,2,3,4,6,7,8-HpCDF	50.755	419.80 > 355.80	37	421.80 > 357.80	37
27	1,2,3,4,6,7,8-HpCDF	50.788	407.80 > 344.80	37	409.80 > 346.80	37
28	¹³ C-1,2,3,4,6,7,8-HpCDD	52.584	435.80 > 371.80	25	437.80 > 373.80	25
29	1,2,3,4,6,7,8-HpCDD	52.596	423.80 > 360.80	25	425.80 > 362.80	25
30	¹³ C-1,2,3,4,7,8,9-HpCDF	53.348	419.80 > 355.80	37	421.80 > 357.80	37
31	1,2,3,4,7,8,9-HpCDF	53.357	407.80 > 344.80	37	409.80 > 346.80	37
32	¹³ C-OCDD	56.85	469.70 > 405.80	25	471.70 > 407.80	25
33	OCDD	56.867	457.70 > 394.80	25	459.70 > 396.80	25
34	OCDF	57.081	441.70 > 378.80	34	443.70 > 380.80	34

3-2. Sensitivity

To verify the performance of the GC-MS/MS system in the low concentration range, 1:50 dilutions of the calibration standard EPA-1613CS1 were also measured (10 fg/µL 2,3,7,8-TCDD). Based on the 2 µL injection volume, the dilutions of the calibra-

tion standard EPA-1613CS1 indicate an absolute amount of 20 fg 2,3,7,8-TCDD in the column. The MRM chromatograms for native PCDD/Fs are shown in Fig. 3.

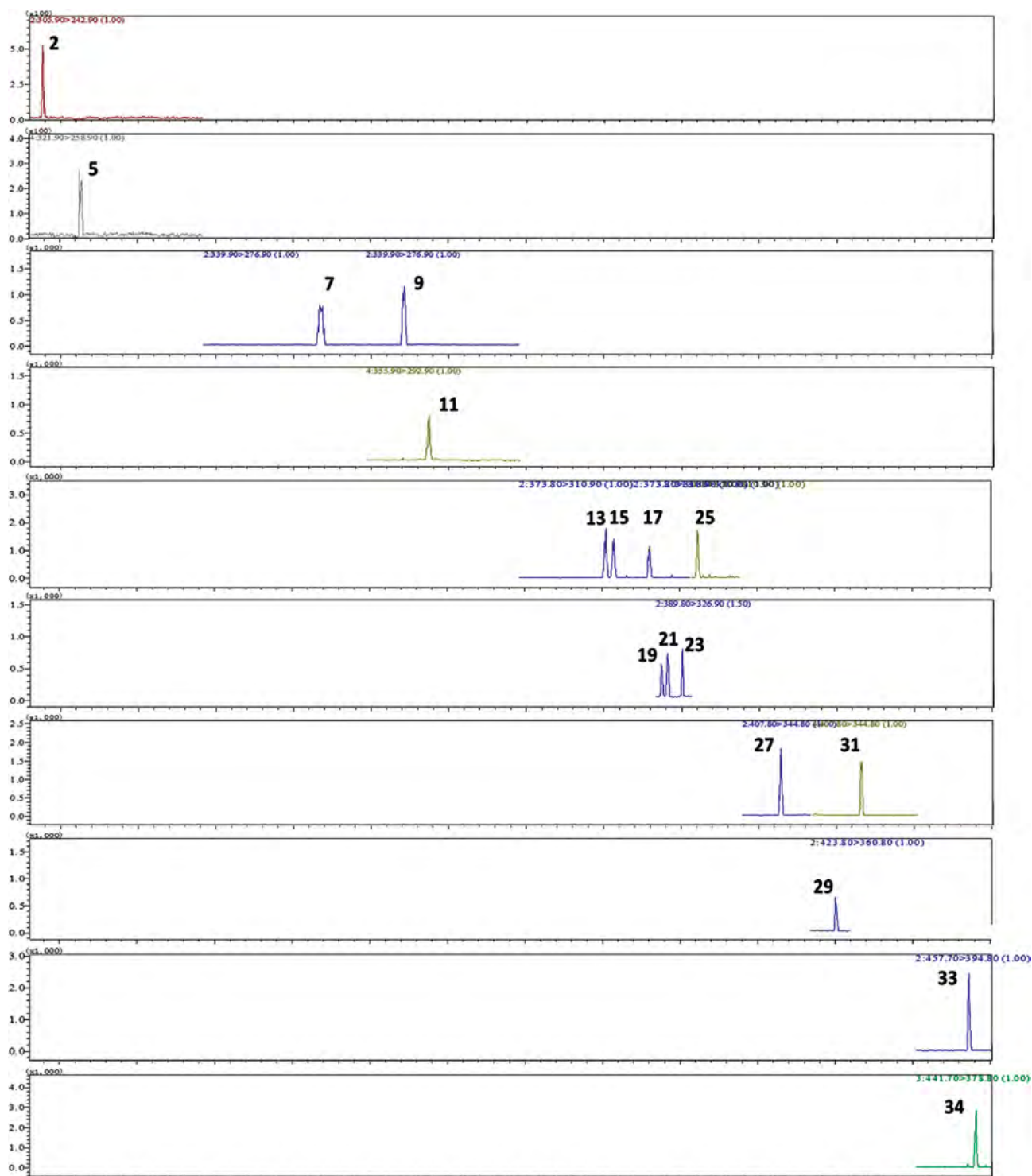

Fig. 3 MRM Chromatograms of Native PCDD/F Congeners (10 – 100 fg/μL, 2 μL injection volume) (Peak numbers refer to analytes listed in Table 3.)

3-3. Linearity of Response

A seven-point calibration curve was prepared based on US EPA method 1613, defined for calibration verification solutions (CS1-CS5), together with EPA-1613CSL and EPA-1613CS0.5. Excellent linearity was obtained for the calibration standards over the concentration range from

0.1 to 200 ng/mL (TCDD), with R^2 values >0.999 for an injection volume of 1 μL (Table 4). The mean response factor for each congener is also given in Table 4. The calibration curves for 2,3,7,8-TCDD, 2,3,7,8-TCDF and 1,2,3,7,8-PeCDD are shown in Fig. 4 to 6.

Table 4 Linear Regression for Seven-Point Calibration Curves over the Range 0.1 to 200 ng/mL (TCDD) and the Mean Response Factor for Each Congener

Congener	Regression line equation	R ²	Mean RF	RF %RSD
2,3,7,8-TCDD	Y = 1.150399X + 3.29953e-004	0.99999	1.22794	8.06
1,2,3,7,8-PeCDD	Y = 1.014733X + 3.009239e-003	1.00000	1.03887	1.96
1,2,3,4,7,8-HxCDD	Y = 1.079761X - 5.260601e-004	0.99997	1.09358	3.65
1,2,3,6,7,8-HxCDD	Y = 0.9705907X + 5.362575e-002	0.99915	1.08710	5.37
1,2,3,7,8,9-HxCDD	Y = 1.024768X + 3.682249e-002	0.99967	1.00394	14.48
1,2,3,4,6,7,8-HpCDD	Y = 0.9429045X + 1.331675e-002	0.99998	1.02985	6.92
OCDD	Y = 1.242978X - 6.145206e-002	0.99929	1.14683	6.10
2,3,7,8-TCDF	Y = 1.15754X + 9.032785e-004	0.99996	1.18104	3.57
1,2,3,7,8-PeCDF	Y = 1.015266X - 5.771587e-003	0.99997	1.07846	7.83
2,3,4,7,8-PeCDF	Y = 1.045151X - 6.304552e-003	0.99998	1.04210	4.49
1,2,3,4,7,8-HxCDF	Y = 1.006328X + 2.605984e-002	0.99988	1.09930	6.04
1,2,3,6,7,8-HxCDF	Y = 0.9307018X + 3.432044e-002	0.99971	1.06611	8.06
2,3,4,6,7,8-HxCDF	Y = 0.9080292X + 3.053454e-002	0.99983	1.00464	6.34
1,2,3,7,8,9-HxCDF	Y = 0.960272X + 2.450491e-002	0.99993	1.03403	9.10
1,2,3,4,6,7,8-HpCDF	Y = 0.9732686X + 4.031919e-002	0.99958	1.08255	4.88
1,2,3,4,7,8,9-HpCDF	Y = 0.9562794X + 3.622056e-002	0.99969	1.06788	5.48
OCDF	Y = 1.424071X + 3.271179e-003	0.99999	1.50245	8.94

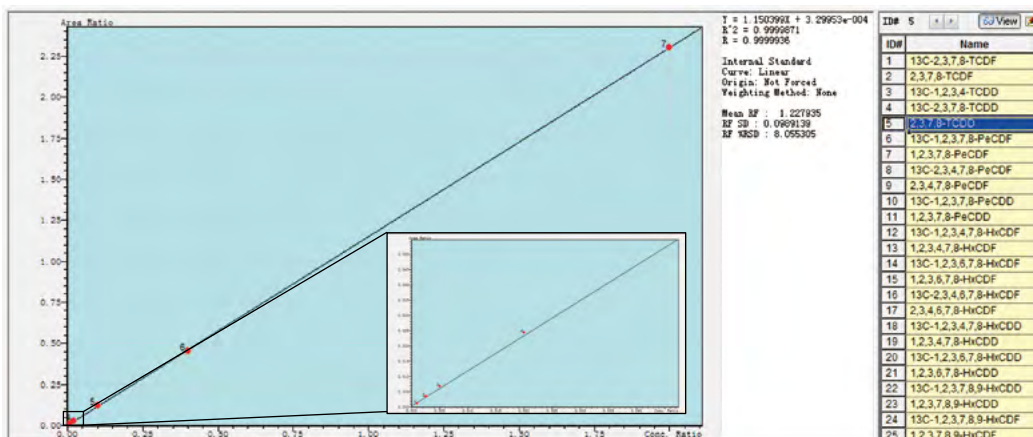

Fig. 4 Seven-Point Calibration Curve for 2,3,7,8-TCDD with Both Linear Fit and Mean Response Factors

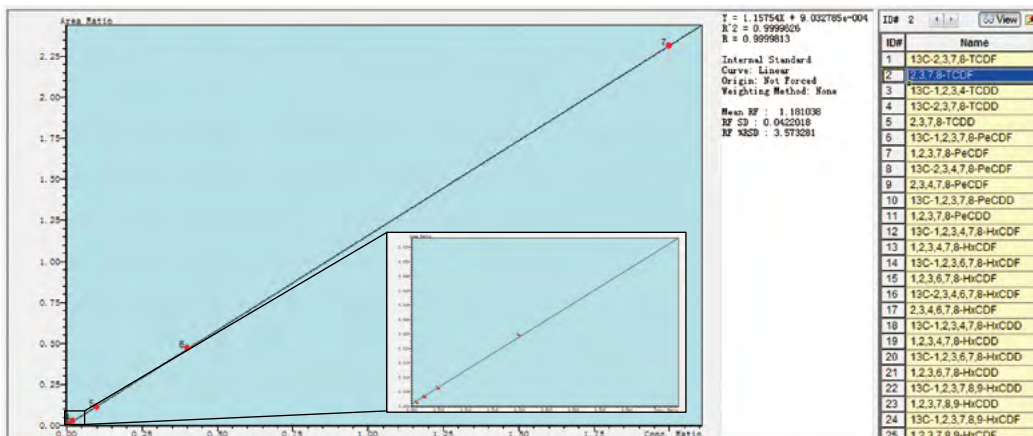

Fig. 5 Seven-Point Calibration Curve for 2,3,7,8-TCDF with Both Linear Fit and Mean Response Factors

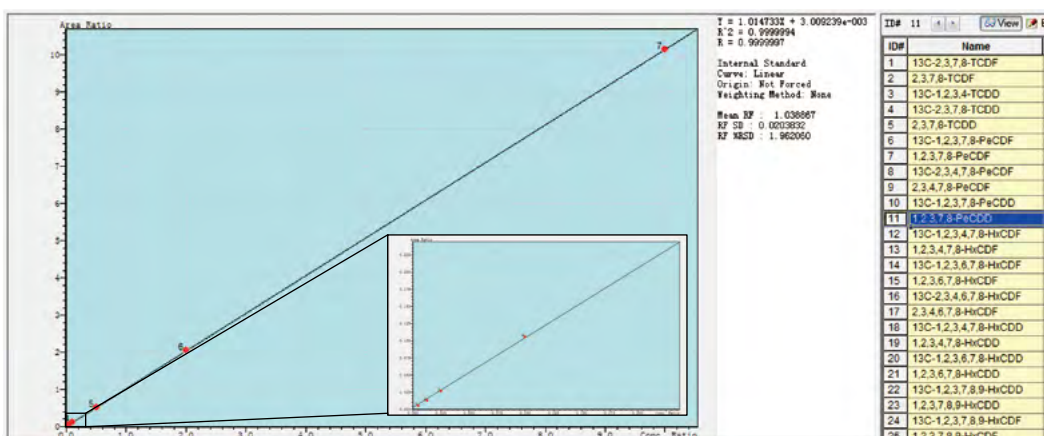

Fig. 6 Seven-Point Calibration Curve for 1,2,3,7,8-PeCDD with Both Linear Fit and Mean Response Factors

3-4. Repeatability

The repeatability was confirmed for within the same day and over different days. Total 12 injections (four 2 µL injections per day for three days) of 1:50 diluted EPA-1613CS1 (10 fg/µL 2,3,7,8-TCDD)

were performed. Results exhibited good repeatability for the peak areas of each congener, with a relative standard deviations (RSD) less than 15 % (Fig. 7).

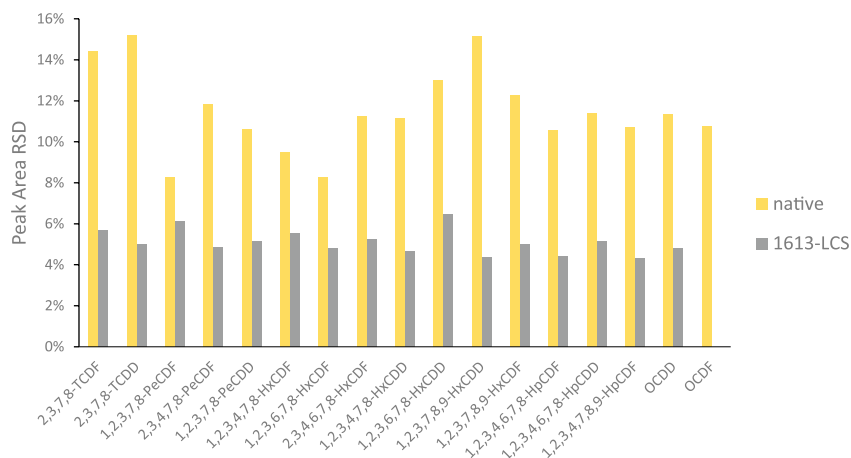

Fig. 7 Repeatability of Peak Areas for Native PCDD/Fs and 1613-LCS (n = 12)

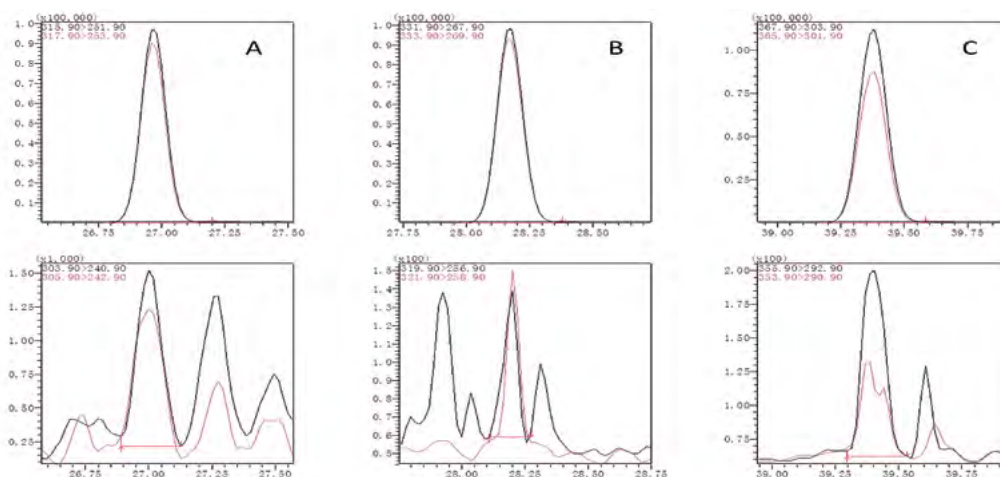

Fig. 8 MRM Chromatograms for ¹³C-Labeled and Native 2,3,7,8-TCDF (A), 2,3,7,8-TCDD (B), and 1,2,3,7,8-PeCDD (C) in Fish Oil

3-5. Sample Analysis

For comparison, each fish oil and milk sample was analyzed in both GC-MS/MS and HRGC/HRMS systems, using the same GC conditions for the HRGC/HRMS system. The MRM chromatograms for 2,3,7,8-TCDF, 2,3,7,8-TCDD, and 1,2,3,7,8-PeCDD in the fish oil sample are shown in Fig. 8. The congener profiles in both samples are exhibited in Fig. 9 and 10. GC-MS/MS results showed good consistency with HRGC/HRMS results. The toxic equivalents (TEQ) of PCDD/Fs were 29.5 pg WHO-TEQ₂₀₀₅/g fat and 1.38 pg WHO-TEQ₂₀₀₅/g fat (upper bound values) in the fish oil and milk samples, respectively, which were comparable to the results of 24.9 and 1.37 pg WHO-TEQ₂₀₀₅/g fat obtained from the HRGC/HRMS system.

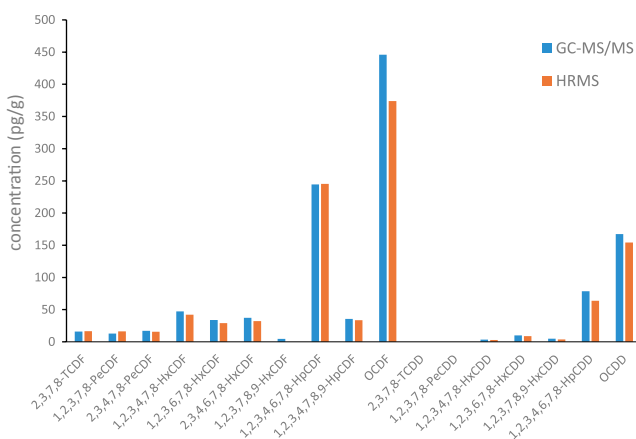

Fig. 9 Congener Profiles of PCDD/Fs in Fish Oil

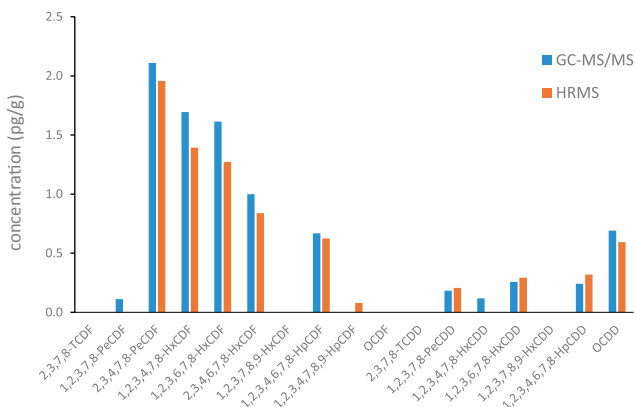

Fig. 10 Congener Profiles of PCDD/Fs in Milk

4. Conclusion

The Shimadzu GCMS-TQ8040 system facilitates the screening and quantitation of low concentration PCDD/Fs in different foodstuffs and animal feed samples. The method showed good linearity, sensitivity, and repeatability. The analytical results from real samples also indicated good precision using this method, when compared with HRGC/HRMS results. This suggests that the Shimadzu GCMS-TQ8040 system provides a substitute solution for routine screening and quantitation of PCDD/Fs in food and feed, as required by European Union legislation.

References

1. IOM (Institute of Medicine). Dioxins and dioxin-like compounds in the food supply: Strategies to decrease exposure. (Washington, DC: The National Academies Press, 2003).
2. Commission Regulation (EU) No. 589/2014 of 2 June 2014 laying down methods of sampling and analysis for the control of levels of dioxins, dioxin-like PCBs and non-dioxin-like PCBs in certain foodstuffs and repealing Regulation (EU) No. 252/2012, *Offic. J. Eur. Commun.* 2014, L164/18–40.
3. Commission Regulation (EU) No. 709/2014 of 20 June 2014 amending Regulation (EC) No. 152/2009 as regards the determination of the levels of dioxins and polychlorinated biphenyls, *Offic. J. Eur. Commun.* 2014, L188/1–18.
4. US EPA method 1613B Tetra- through Octa-Chlorinated Dioxins and Furans by Isotope Dilution HRGC/HRMS. 1997.
5. Wang P, Zhang Q, Wang Y, Wang T, Li X, Ding L, Jiang G. Evaluation of Soxhlet extraction, accelerated solvent extraction and microwave-assisted extraction for the determination of polychlorinated biphenyls and polybrominated diphenyl ethers in soil and fish samples. *Anal. Chim. Acta.* 2010, 663(1):43–48.

Triple Quadrupole Gas Chromatograph Mass Spectrometer

GCMS-TQ8040

Finally, a triple quadrupole GCMS *Smart* enough for everyday use in your laboratory.

The Shimadzu GCMS-TQ8040 is the first triple quadrupole with Smart Productivity for high efficiency sample throughput, Smart Operation for quick and easy method development, and Smart Performance for low detection limits and Scan/MRM. These three smart technologies contribute to Smart MRM, and provide the most accurate, cost-effective, and easy-to-use triple quadrupole GCMS you have ever imagined.

UPLC
ULTRA FAST MASS SPECTROMETRY



Smart Productivity

- Retention time synchronized MRM provides simultaneous sensitivity and precision for hundreds of compounds in one run
- Smart MRM optimizes analysis of 400+ compounds in a single acquisition with maximum sensitivity
- Reduced downtimes with the Twin Line configuration MS system

Smart Operation

- MRM Optimization Tool to optimize MRM transitions automatically
- Smart Database Series with fully optimized transitions for hundreds of compounds
- Smart MRM for automatic method creation in a single step

Smart Performance

- The patented ion source design and uniform temperature prevent active spots and boost sensitivity
- The OFF-AXIS ion optics eliminate chemical noise and lower detection limits
- High-sensitivity analysis even in single GC-MS mode

Smart Environmental Database

Create MRM Methods for GC-MS/MS

The Smart Environmental Database contains all the information necessary to create MRM methods for over 500 environmental pollutants, including PCBs, BFRs, dioxins, PAHs, organochlorine pesticides (OCPs), and stable isotopically labeled compounds that are commonly used as Internal and Surrogate Standards.

Smart MRM Optimizes Methods Automatically

The Smart MRM feature allows the user to create fully optimized MRM and Scan/MRM methods automatically. GC-MS/MS Dwell, Event, and Loop times can be difficult to optimize when dozens, or even hundreds of compounds are to be analyzed simultaneously. The Smart MRM feature automatically determines the optimum Dwell, Event, and Loop settings using flexible MRM events, and creates MRM and Scan/MRM methods that provide the best sensitivity for all compounds in a single method.

Analysis of PCB in River Water

(2,2',5,5'-Tetrachlorobiphenyl (#52) concentration in water of 0.080 ng/L)

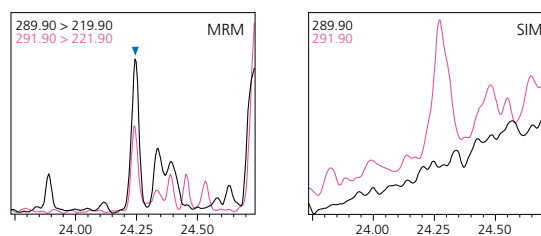

Number of Registered Compounds	Number of Registered Native Compounds	Number of Registered Compounds Labeled with Stable Isotopes
Polychlorinated biphenyls	209	45
Brominated flame retardants	55	28
Dioxins	32	26
Polycyclic aromatic hydrocarbons	38	37
Organochlorine pesticides	32	25

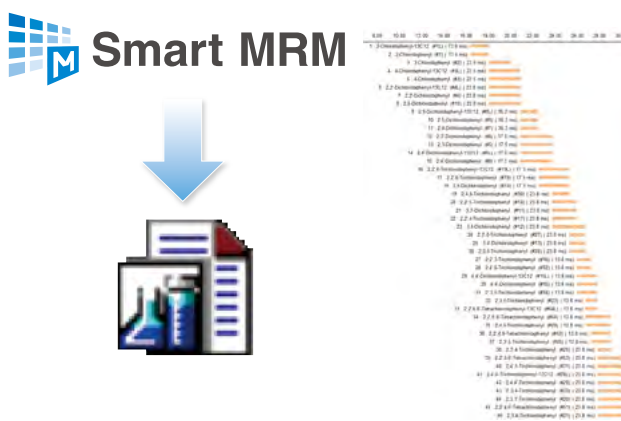

Shimadzu Corporation

www.shimadzu.com/an/

For Research Use Only. Not for use in diagnostic procedures.

The content of this publication shall not be reproduced, altered or sold for any commercial purpose without the written approval of Shimadzu. The information contained herein is provided to you "as is" without warranty of any kind including without limitation warranties as to its accuracy or completeness. Shimadzu does not assume any responsibility or liability for any damage, whether direct or indirect, relating to the use of this publication. This publication is based upon the information available to Shimadzu on or before the date of publication, and subject to change without notice.

First Edition: January, 2016

© Shimadzu Corporation, 2016

Printed in Japan 3655-10529-10ANS

Application News

No. J120

Inductively Coupled Plasma Mass Spectrometry

Analysis of Minerals and Harmful Elements in Formula Milk Powder Using ICPMS-2030

■ Introduction

Formula milk powder is formulated to contain a good balance of minerals necessary for infant growth. Japan's Health Promotion Law includes stipulations on the essential mineral content, including calcium (Ca), iron (Fe), and copper (Cu), of food for special dietary use (e.g., formulated milk powder for infants) and requires the labeling of their content.¹⁾

Harmful elements like lead (Pb) have a negative effect on infant development, and require strict safety controls from raw materials to the finished product.

We describe using Shimadzu's ICPMS-2030 inductively coupled plasma mass spectrometer to perform a simultaneous analysis of elements present in formula milk powder (National Metrology Institute of Japan certified reference material [NMIJ CRM]). In addition to being highly sensitive, the ICPMS-2030 uses a helium gas collision system that greatly reduces the spectral interference caused by argon and chlorine.

[References]

1) Permission standards for labeling and component composition of breast milk and formulated milk powder for infants (Permission for labeling of food for special dietary use, Food Labeling Division, Consumer Affairs Agency, No. 221 of March 31, 2016)

■ Sample

NMIJ CRM milk powder (for trace element analysis) (NMIJ CRM 7512-a: No. MI-040)

■ Sample Preparation

Compared to the normal wet digestion method, the microwave sample decomposition method has the advantages of completing decomposition in a shorter period of time and within a closed system, which results in little volatilization loss of As and other analytes. We used the ETHOS One (Milestone General K.K., Japan) to perform sample decomposition.

After placing a sample 0.25 g, hydrochloric acid 0.5 mL, and nitric acid 6.5 mL in a quartz decomposition vessel, decomposition was performed using a microwave sample pretreatment system.

After decomposition, pure water was added to make up 250 mL of solution for analysis (1000-fold dilution). At this point, Sc, Co, Ga, Y, In, and Ti internal standard elements were added (to an analytical solution concentration of 10 µg/L).

Table 1 shows the decomposition conditions.

Table 1 Decomposition Conditions for Microwave Digestion System

STEP	Temperature (°C)	Time (min)	Power (W)
1	50	2	1000
2	30	3	0
3	180	25	1000
4	150	1	0
5	180	4	1000
6	180	15	1000

■ Instrument and Analytical Conditions

Shimadzu's ICPMS-2030 inductively coupled plasma mass spectrometer was used for analysis. Analytical conditions are shown in Table 2.

In addition to being highly sensitive, the ICPMS-2030 uses a helium gas collision system that greatly reduces the spectral interference caused by argon and chlorine.

Table 2 Analytical Conditions

Instrument	: ICPMS-2030
High-frequency output	: 1.2 kW
Plasma gas flowrate	: 8.0 L/min
Auxiliary gas flowrate	: 1.10 L/min
Carrier gas flowrate	: 0.60 L/min
Sample introduction	: Nebulizer 10
Chamber	: Cyclone chamber (electronic cooling)
Plasma torch	: Mini-torch
Collision gas	: He

■ **Analysis**

Minerals and harmful elements present in formula milk powder were measured simultaneously using a calibration curve method.

To confirm the validity of measured values, a spike and recovery test sample was prepared by adding a standard solution of analyte elements (Cd, Cr, Pb, As) after sample decomposition treatment.

■ **Analytical Results**

Table 3 shows the analytical results. The results for mineral elements were within the range of certified levels, and good spike and recovery was obtained for trace amounts of harmful elements.

■ **Conclusions**

We successfully used the ICPMS-2030 to simultaneously measure mineral constituents present in high concentrations in formula milk powder along with trace amounts of harmful elements.

Table 3 Analytical Results for Certified Reference Material in Formula Milk Powder (NMIJ CRM 7512-a)

	Unit	Measured Value (in Powder)	NMIJ Certified Value	Expanded Uncertainty	Spike and Recovery (%)
Ca	g/kg	8.5	8.65	0.38	-
Fe		0.102	0.104	0.007	-
K		8.3	8.41	0.33	-
Mg		0.82	0.819	0.024	-
Na		1.81	1.87	0.09	-
P		5.4	5.62	0.23	-
Mn	mg/kg	0.91	0.931	0.032	-
Mo		0.230	0.223	0.012	-
Sr		5.7	5.88	0.20	-
Zn		41	41.3	1.4	-
Cd		<0.005	-	-	100
Cr		<0.06	-	-	101
Pb		<0.03	-	-	100
As		<0.03	-	-	108

Spike and recovery (%) = { (Spike and recovery test sample analysis result - Measured value) / Spiked concentration} × 100



For Research Use Only. Not for use in diagnostic procedure.

This publication may contain references to products that are not available in your country. Please contact us to check the availability of these products in your country.

The content of this publication shall not be reproduced, altered or sold for any commercial purpose without the written approval of Shimadzu. Company names, product/service names and logos used in this publication are trademarks and trade names of Shimadzu Corporation or its affiliates, whether or not they are used with trademark symbol "TM" or "®". Third-party trademarks and trade names may be used in this publication to refer to either the entities or their products/services. Shimadzu disclaims any proprietary interest in trademarks and trade names other than its own.

The information contained herein is provided to you "as is" without warranty of any kind including without limitation warranties as to its accuracy or completeness. Shimadzu does not assume any responsibility or liability for any damage, whether direct or indirect, relating to the use of this publication. This publication is based upon the information available to Shimadzu on or before the date of publication, and subject to change without notice.

Application News

iD^{plus}

No. **MO398** | Milk and Dairy Product Profiling Using iD^{plus}

- Foodstuff authenticity screening
- Effective detection of adulteration in dairy products
- Molecular profiling with minimal sample preparation
- Patented SuperSpectrum™ concept
- High degree of flexibility: customizable open database
- Visualization, clustering and dendrogramming tools for simple interpretation of results

Introduction

iD^{plus}™ is an established MALDI-TOF MS based platform in microbial identification but it is far from limited to this application. The flexibility of the open database associated with iD^{plus} allows the use of the platform for molecular profiling experiments and differentiation of related samples based on the unique features in their profile. New custom sample-specific entries (SuperSpectra) can be added to the existing microbial database to create a sub-database relevant to a particular area of research. This has been reported in areas as diverse as cell line identification, entomology, zooplankton research, fish speciation and the study of food-borne bacteria (ref 1-7).

Adulteration of dairy products is a significant problem in the food industry. Methods for the detection of fraudulent addition of cows' milk to other more expensive types of milk, such as goat or sheep, is important to eradicate economically motivated milk adulteration. This illegal practice, however, is not limited solely to milk production: other areas of the dairy industry such as cheese manufacture have also been targeted.

For example: the European protected designation of origin (PDO) legislation protects highly sought-after buffalo mozzarella from the Campania region of Italy (Mozzarella di Bufala Campana). While mozzarella can be made from cows' milk, it would not receive PDO certification and would be a significantly cheaper product. This has led to widespread fraudulent attempts to misrepresent cow mozzarella as buffalo mozzarella, a practice highlighted in 2010 when checks of PDO-protected Mozzarella di Bufala Campana by the ministry of agriculture in Italy found that at least 25% contained cows' milk.

This work demonstrates the effectiveness of the iD^{plus} platform for rapid differentiation of dairy products and identification of fraudulent practices. Proof of principle of this technique is demonstrated using milk profiling from several different species. The established method is then applied to foodstuff authentication using mozzarella cheese as a model product.

The SuperSpectrum Concept

SuperSpectra are database entries within the *iD^{plus}* database (SARAMIS™) that represent a typical population of a species or sample. They are computed from multiple mass spectra (Reference Spectra) acquired from a given sample that are combined into a consensus spectrum weighted by specificity. The weighting algorithm favors sample-specific peaks and devalues common-feature peaks, further increasing confidence when using database matching. The diagram in figure 1 illustrates the process used to create a SuperSpectrum.

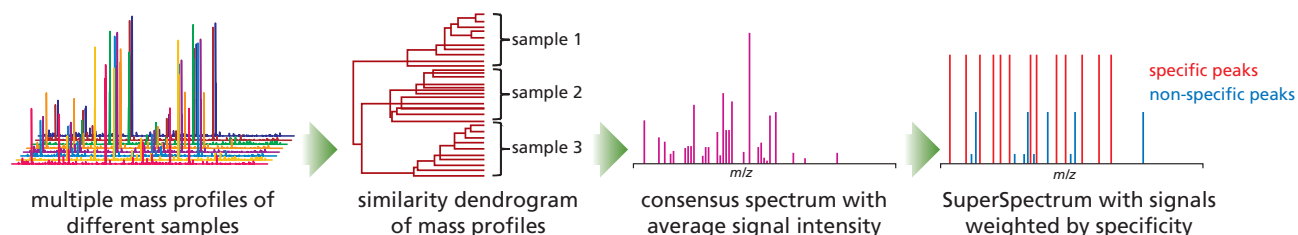

Figure 1: Creation of a SuperSpectrum

Experimental

Three types of milk (cow, buffalo and goat) and two types of mozzarella cheese (cow and buffalo) were obtained from several sources (table 1). Multiple reference spectra were acquired and combined into a characteristic SuperSpectrum for each milk product to populate a custom dairy-specific database.

Briefly, each of the milk samples was diluted 10-fold into 0.1% aqueous TFA. 1 μ L of this solution was then deposited onto the target plate and left until almost dry before adding 1 μ L of CHCA matrix. For the mozzarella samples, a small amount of the cheese was smeared directly onto the FlexiMass-DS™ target surface using an inoculation loop before adding 1 μ L of CHCA matrix. Spectra were acquired across the *m/z* range 2000 to 20000.

Product Name	Product Type	Species
Tesco Semi-skimmed	Milk	Cow
Tesco Pure Filtered Semi-skimmed	Milk	Cow
Tesco Jersey & Guernsey Cow	Milk	Cow
Delamere Sterilized Whole	Milk	Cow
Laverstock Park Semi-skimmed	Milk	Buffalo
Laverstock Park Whole	Milk	Buffalo
St Helen's Farm Semi-skimmed	Milk	Goat
Galbani	Mozzarella	Cow
Waitrose Italian	Mozzarella	Cow
Cantile	Mozzarella	Buffalo
Laverstock Park	Mozzarella	Buffalo
Garofalo	Mozzarella	Buffalo

Table 1: Summary of the milk and mozzarella samples

Results

Proof of Principle

The different types of milk analyzed (cow, goat and buffalo) generated highly taxon-specific mass profiles exhibiting many species-specific masses. Figure 2 highlights the differences observed between these profiles.

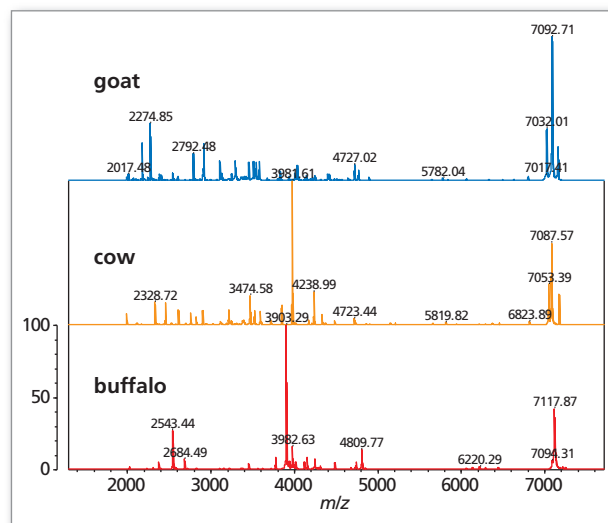

Figure 2: *iD^{plus}* mass profiles for goat, cow and buffalo milk

Additional samples of cow, buffalo and goat milk were analyzed and processed for cluster analysis. The dendrogram results obtained confirmed effective differentiation of the milk samples (figure 3).

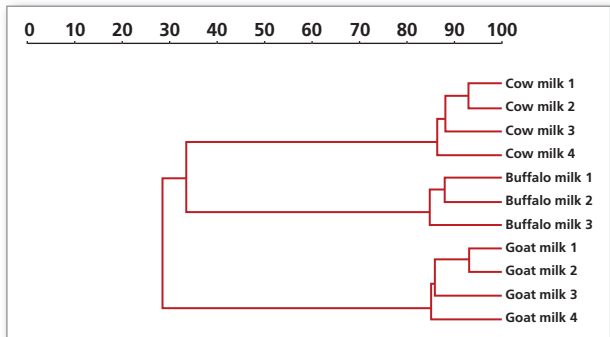

Figure 3: Cluster analysis of milk originating from cow, buffalo and goat

Food Adulteration Detection

Similarly to milk, the different types of mozzarella cheese generated distinguishable mass profiles exhibiting many product specific masses (figure 4).

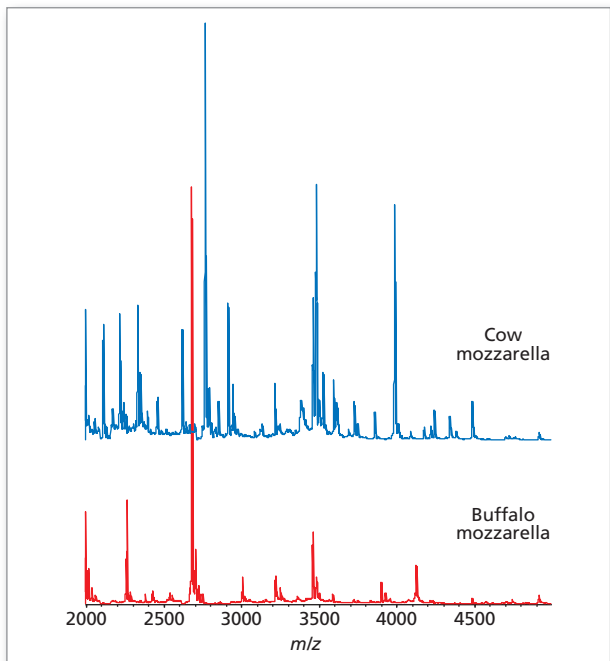

Figure 4: *iD^{plus}* mass profiles for cow and buffalo mozzarella cheese

To simulate adulteration of a mozzarella sample, Mozzarella di Bufala Campana cheese was mixed with cow mozzarella and prepared in the same manner as previously. The mass profile obtained for the adulterated sample is shown in figure 5 and clearly exhibits mass signals from both taxa.

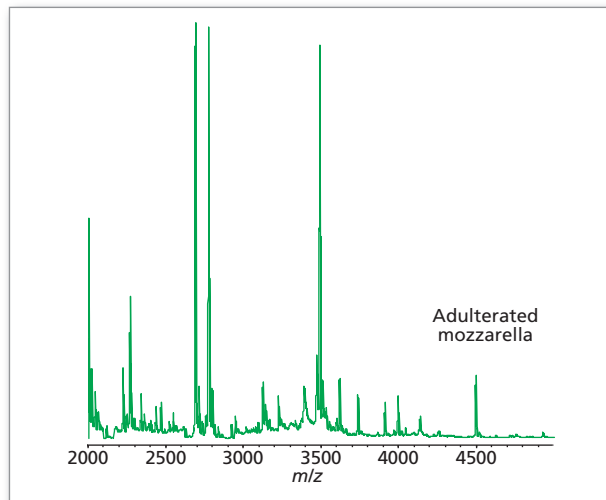

Figure 5: *iD^{plus}* mass profiles for adulterated mozzarella cheese

When the adulterated mozzarella sample results were submitted to search the custom dairy database an unambiguous identification was not achieved (result flagged in red in figure 6). Further inspection of the detailed result showed that the sample had matched both cow and buffalo mozzarella in the database, a clear indication of an adulterated sample (figure 6).

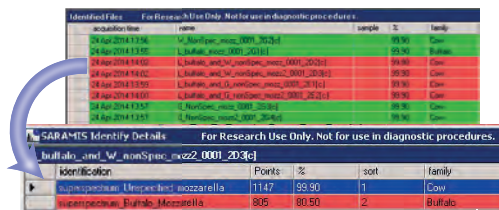

Figure 6: Search result confirming mozzarella adulteration

Further adulterated mozzarella samples were analyzed. Cluster analysis of the results clearly displayed three distinct groups: buffalo mozzarella, cow mozzarella and adulterated mozzarella (cow and buffalo mix) confirming that the *iD^{plus}* system can be applied to dairy foodstuff adulteration detection (figure 7).

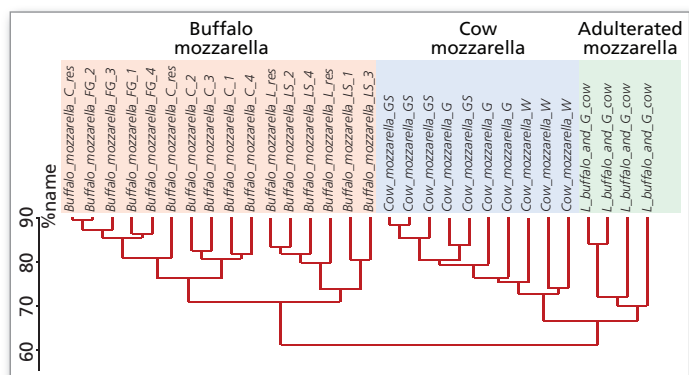

Figure 7: Cluster analysis of buffalo, cow and adulterated mozzarella

Conclusion

Foodstuff adulteration is a prevalent problem within the industry. It comprises both misrepresentation of products and deliberate contamination with lesser ingredients. The results shown here demonstrate effective detection of adulteration in dairy products. Construction of custom databases is straightforward and provides a very high level of confidence due to the use of the patented SuperSpectrum concept and the cluster analysis tool provides a simple graphical representation of the results obtained. The *iD^{plus}* is an ideal platform for simple and efficient foodstuff adulteration detection and authenticity screening.

References

- (1) Vogel *et al*, *BMC Proceedings*. 2011; **5(suppl 8)**: p45.
- (2) Muller P *et al*, *PLoS ONE*. **8(2)**: e57486.
- (3) Kaufmann C *et al*, *Parasitology*. 2012; **139**: 248-258.
- (4) Kaufmann C *et al*, *Medical and Veterinary Entomology*. 2011; **25**: 32-38.
- (5) Riccardi N *et al*, *Journal of Plankton Research*. 2012; **34**: 6, 484-492.
- (6) Volta P *et al*, *J. Limnol.* 2012; **71(1)**: 164-169.
- (7) Stephan R *et al*, *Journal of Microbiological Methods*. 2011; **87**: 150-153.

Application News

No. AD-0096

Food Safety Analysis / Nexera X2

Development of An UHPLC Method for Simultaneous Determination of Thirteen Bisphenols in Milk Samples

□ Introduction

Bisphenol A (BPA) and Bisphenol F (BPF) are the monomers to make polycarbonate plastics and epoxy resins. Their diglycidyl esters, i.e., BADGE and BFDGE (Figure 1), are also present in the polymeric products. These materials are made into a variety of consumer products or used as inner coatings for baby milk bottles and reusable food containers which are allowed to use in refrigerator and microwave for food storage and heating. It has been reported that polycarbonate plastics and epoxy-based coatings can release BPA, BPF, BADGE and BFDGE as well as their reaction products as illustrated in Figure 1 [1]. These leached chemicals can migrate into food and become contaminants consumed by consumers eventually. Although researches indicate that the migration of these chemicals is normally extremely low [2], the specific migration limits (SMLs) of bisphenols were listed in the EU legislation No 1895/2005 on the restriction of use of certain epoxy derivatives in materials contacted with food. BPA has estrogenic effect and can disrupt normal hormone levels and development in fetuses and babies. In U.S., FDA has published food additive regulations prohibiting the use of BPA-based epoxy resins as inner coatings of containers for infant formula packaging [3]. We describe in this Application News a new UHPLC method for simultaneous determination of thirteen concerned bisphenols including BPA, BPF, BADGE, BFDGE and some structural analogues. An UHPLC system (Nexera X2, Shimadzu Corporation) with a high sensitivity fluorescence detector [4] was adopted to develop a fast and high sensitivity method to meet the requirements of regulations.

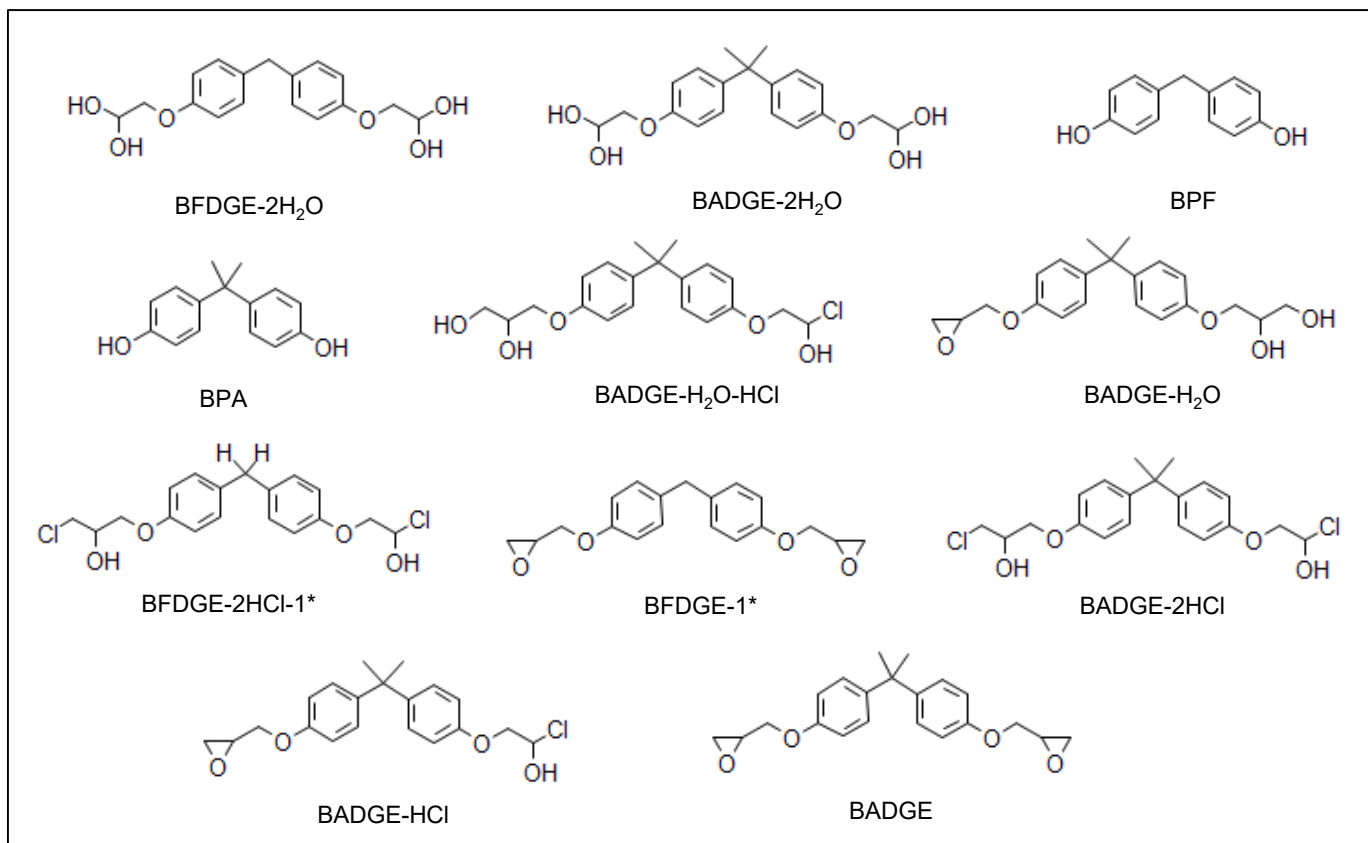

Figure 1 Chemical structures and abbreviation names of bisphenol A, bisphenol F, their diglycidyl esters and derivatives [1].

*Note: positional isomers of BFDGE-2 and BFDGE-2HCl-2 are not shown.

□ Experimental

Instrumental and analytical conditions

An UHPLC system - Nexera X2 (Shimadzu Corporation) equipped with a fluorescence detector (RF-20Axs) was employed in this work. Separation of bisphenol A (BPA), bisphenol F (BPF) and other 11 derivatives are performed using a Shim-pack HR-ODS column (250 x 3.0mm, 3 μ m) with an optimized gradient elution program. Pure water and acetonitrile (ACN) were used as UHPLC mobile phases without any additive. The detailed analytical conditions of the UHPLC method are shown in Table 1.

Standards and spiked milk samples

A mixed standard stock solution of thirteen bisphenols (Refer to Table 2) containing BPA, BPF and other derivative compounds were prepared in ACN/H₂O (30:70). A serial of calibration standards of concentrations from 5 μ g/L to 2,000 μ g/L were prepared from the stock to set up multi-point calibration curves. Two blank milk matrix spiked with known concentrations of standards (100 and 1,000 μ g/L) obtained from a third party laboratory were used for evaluation of the method performance.

Table 1: UHPLC conditions of Bisphenols and derivatives.

Column	Shim-pack HR-ODS (250 x3.0 mm, 3 μ m)
Mobile phase	A: Water B: Acetonitrile
Elution program	0.1min, 30% B; 13min, 45% B; 37min, 70% B; 38-43min, 85% B; 43.1min, 30% B.
Flow rate	0.40 mL/min
Detection	Ex 235 nm, Em 317nm
Oven temp.	30 °C
Injection	10 μ L

□ Results and Discussion

Development of fast UHPLC method

For well separation of the thirteen bisphenols studied, a reference HPLC method has a long running time of 95 mins. As shown in Figure 3, the current UHPLC method was optimized to achieve fast elution for every compounds with sufficient separation resolution, especially for the separation of BADGE-H₂O and BADGE-H₂O-HCl at 19.4 and 19.9 mins. Due to the similarity in compound structure and chemical properties, separation of these two peaks was a main obstacle to achieve fast analysis speed. The results obtained show clearly the advantages of an UHPLC column with small particle size (3 μ m) of the C18 stationary phase.

The main targets BPA (18.1 min) and BPF (13.4 min), BADGE (34.3 min) are separated completely without any inference. BFDGE has two positional isomers, which appeared as a pair at 28.8 min and 30.0 min, respectively. Noted that, another pair of positional isomers BFDGE-2HCl appeared just before the BFDGE peaks at 26.9 min and 27.9 min, respectively.

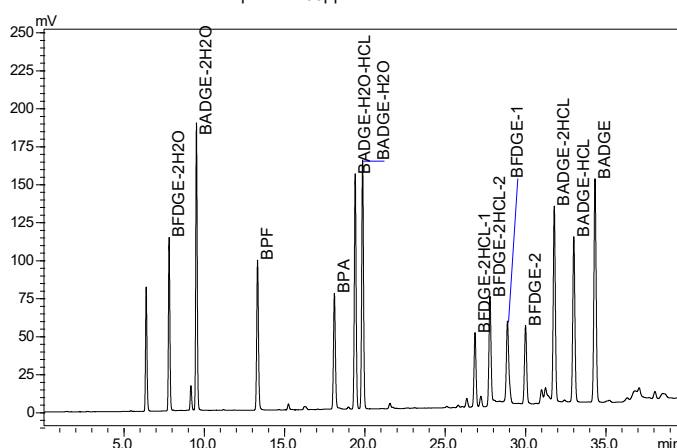

Figure 2: UHPLC-RF chromatogram of mixed standards of thirteen bisphenols at concentration of 100 μ g/L each.

Table 2: Summary of UHPLC method and performance evaluation results for analysis of thirteen bisphenols

ID #	Name	Ret Time (min)	Calibration range: 5-2000 μ g/L		RSD (%), n=6		Sensitivity ²	
			R ²	Accuracy (%) ¹	5 μ g/L	100 μ g/L	LOD (μ g/L)	LOQ (μ g/L)
1	BFDGE-2H ₂ O	7.9	0.9998	100.9	1.0	0.9	0.7	2.0
2	BADGE-2H ₂ O	9.5	0.9991	98.7	0.4	0.4	0.4	1.2
3	BPF	13.4	0.9997	101.7	0.7	0.3	0.8	2.5
4	BPA	18.1	0.9997	101.2	0.8	0.3	1.0	3.1
5	BADGE-H ₂ O-HCL	19.4	0.9998	101.5	0.5	0.3	0.5	1.5
6	BADGE-H ₂ O	19.9	0.9997	103.2	0.3	0.3	0.5	1.5
7	BFDGE-2HCL-1	26.9	0.9996	98.8	0.6	0.1	1.5	4.6
8	BFDGE-2HCL-2	27.8	0.9997	100.8	2.3	0.2	1.2	3.6
9	BFDGE-1	28.9	0.9997	99.3	0.9	0.3	1.4	4.2
10	BFDGE-2	30.0	0.9997	101.3	1.2	0.4	1.6	4.7
11	BADGE-2HCL	31.8	0.9997	98.9	1.8	0.3	0.6	1.7
12	BADGE-HCL	33.0	0.9997	101.7	0.5	0.4	0.7	2.2
13	BADGE	34.3	0.9997	100.7	1.0	0.5	0.5	1.6

Notes: 1. Average of 12 concentration levels 5-2000 μ g/L
2. Estimated using 5 μ g/L mixed stds data based on S/N=3 for LOD and S/N=10 for LOQ

Calibration curves, range and linearity

Linear calibration curves of the thirteen bisphenols are established using mixed standards samples for concentrations ranging from 5 µg/L to 2000 µg/L as shown in Figure 3. A total of 12 concentration levels were used with each compound in the mixture being 5, 10, 20, 50, 100, 200, 400, 600, 800, 1200, 1500 and 2000 µg/L. All of the thirteen bisphenols peaks give excellent linearity with R^2 greater than 0.999 as tabulated in Table 2.

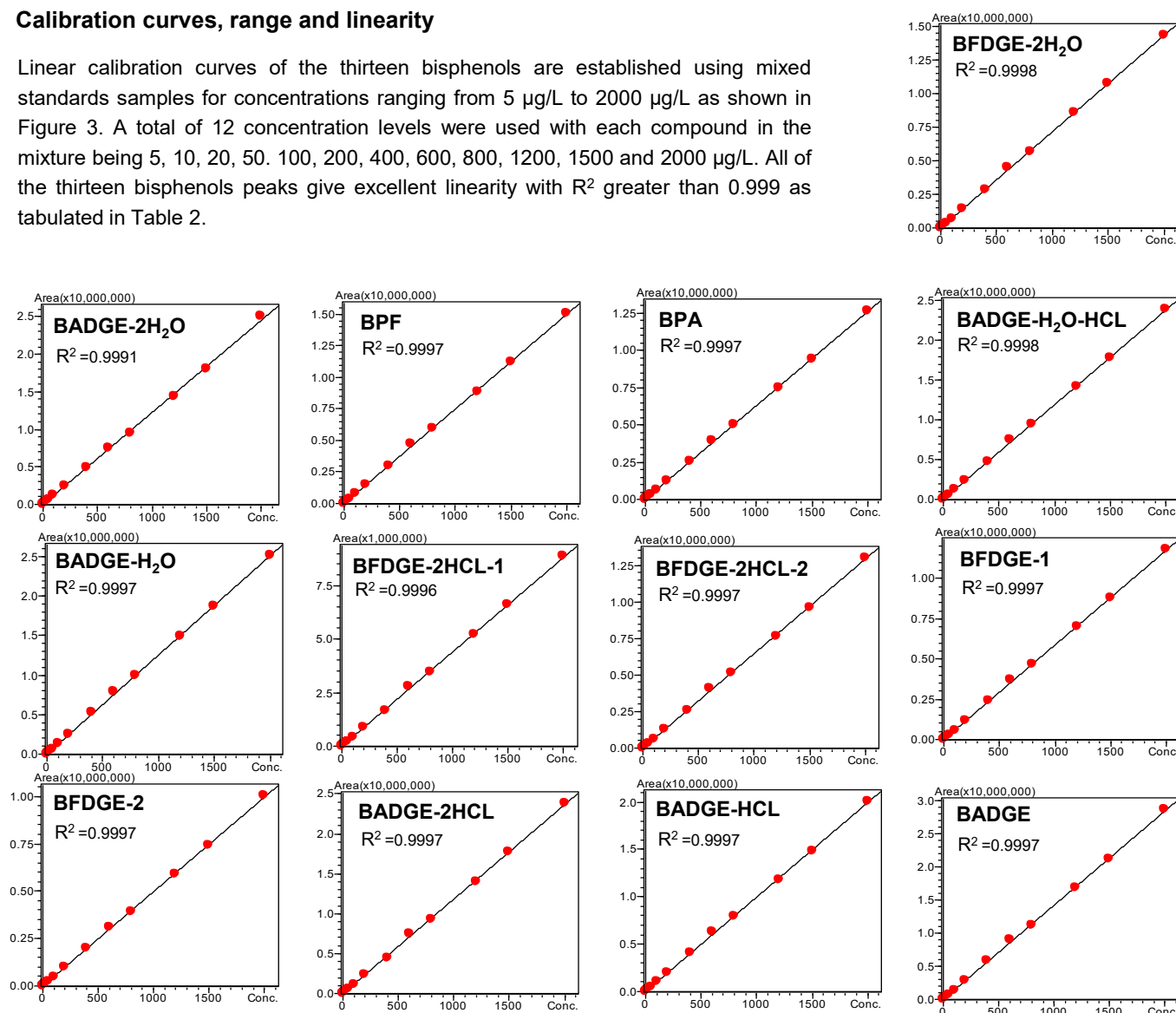

Figure 3: Calibration curves of the thirteen bisphenols with concentration range from 5 µg/L to 2,000 µg/L.

Evaluation of method performance

The accuracy of the method at every calibration levels were calculated and the average accuracy values for every compounds are presented in Table 2. To evaluate repeatability of the method, six consecutive runs of the lowest concentration mixed standard sample (5 µg/L) and a mixed standard sample of 100 µg/L were performed. The RSD values for the 5µg/L mixed standards are less than 2.3%, while RSD values for 100µg/L concentration level are less than 1%, as can be seen in Table 2. The limit of detection (LODs) and limit of quantification (LOQs) were determined from the chromatogram of the lowest concentration mixed standards (5µg/L) as shown in Figure 4, following the rule of $S/N=3$ for LOD and $S/N=10$ for LOQ. The obtained LODs and LOQs are at 0.4~1.6 µg/L, and 1.5~4.7 µg/L for the thirteen bisphenols (Table 2).

Datafile Name:HSA-18Aug 007.lcd
Sample Name:HSA mix std
Sample ID:5ppb

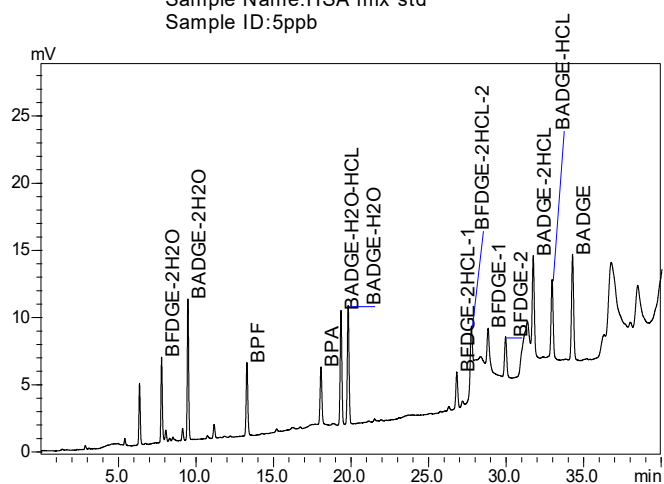

Figure 4: UHPLC-RF chromatogram of mixed standards of thirteen bisphenols, 5 µg/L each compound.

Spiked milk samples and recovery

A blank milk sample and two spiked samples of 13 mixed standards in the same blank were obtained from an analytical laboratory, labeled as Blank, S1 (spiked 100 µg/L) and S2 (spiked 1,000 µg/L). The blank milk matrix was analyzed first and the result showed no any detection of the 13 bisphenols studied. The chromatogram of spiked sample S1 is shown in Figure 5. The quantitative results and recovery data of the 13 bisphenols in both samples are tabulated in Table 3. In both samples, the measured concentrations of BADGE-H₂O-HCl are higher than the expected levels with a recovery around 130%. On the other hand, three compounds with longer retentions (peaks 11~13) exhibit much lower concentrations as expected and low recovery of about 40% and 60%.

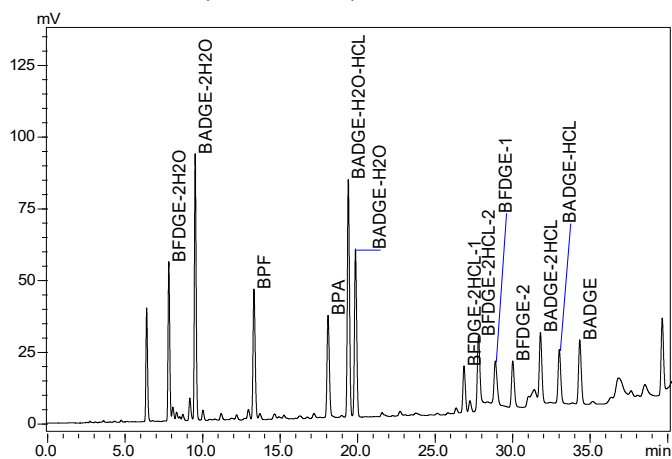

Figure 5: UHPLC-RF chromatogram of spiked milk sample S1 (100 µg/L). The sample was diluted with water for two time prior to injection (10 µL)

Table 3: Analysis results of spiked milk samples for 13 bisphenols determined by the UHPLC-RF method established

ID #	Name	Ret Time (min)	Spiked S1		Spiked S2	
			Conc. (µg/L)	Recovery %	Conc. (µg/L)	Recovery %
1	BFDGE-2H ₂ O	7.9	115.0	115	1140.8	114.1
2	BADGE-2H ₂ O	9.5	114.5	114.5	1123.6	112.4
3	BPF	13.4	114.9	114.9	1152.4	115.2
4	BPA	18.1	114.1	114.1	1162.9	116.3
5	BADGE-H ₂ O-HCL	19.4	131.3	131.3	1284.9	128.5
6	BADGE-H ₂ O	19.9	91.1	91.1	983.1	98.3
7	BFDGE-2HCL-1	26.9	79.3	79.3	947.6	94.8
8	BFDGE-2HCL-2	27.8	90.5	90.5	983.0	98.3
9	BFDGE-1	28.9	68.6	68.6	823.8	82.4
10	BFDGE-2	30.0	77.2	77.2	824.2	82.4
11	BADGE-2HCL	31.8	47.3	47.3	668.9	66.9
12	BADGE-HCL	33.0	43.3	43.3	635.7	63.6
13	BADGE	34.3	37.4	37.4	563.7	56.4

Conclusions

An UHPLC method with using a high sensitivity fluorescence detector was developed for fast, well-separation and high sensitivity analysis of thirteen bisphenols, including the most concerned BPA, BPF, BADGE and BFDGE, in milk samples. This new method shows high sensitivity to low µg/L levels, high accuracy and excellent repeatability. The method was applied to spiked milk samples and the results indicated the good feasibility, high sensitivity and reliability in simultaneous determination of thirteen bisphenols in milk samples.

References

1. Jan Poustka, Lenka Dunovská, Jana Hajšlová, Kateřina Holadová and Ivana Poustková, Czech J. Food Sci., Vol. 25, No. 4: 221–229 (2007)
2. Ivana Poustková, Jaroslav Dobiš, Ingrid Steiner, Jan Poustka, Michal Voldřich, Eur Food Res Technol (2004) 219:534–539.
3. United States Food and Drug Administration web site: Bisphenol A (BPA) for Use in Food Contact Applications
4. Application News No. L408, Shimadzu Corporation.

Application News

No. C164

Liquid Chromatograph Mass Spectrometry

Ultra-High-Speed Analysis of Melamine in Powdered Milk Using LDTD-MS/MS

The deliberate contamination of powdered milk and pet food with melamine has become a serious social issue. If melamine is contained in food at high concentrations together with cyanuric acid, which is produced in the manufacturing process of melamine, contamination can lead to kidney stones and even kidney failure. In many cases, melamine is added for producing adulterated products, and when added, is done so at very high concentrations. In order to stop these sorts of adulterated products at the border, high-speed screening analysis that can be performed together with easy sample preparation is required. A widely reported analysis technique for melamine in powdered milk involves using LCMS and GCMS after performing pretreatment to remove impurities. This article describes an ultra-high-speed analysis of melamine in powdered milk without column separation by using a laser diode thermal desorption (LDTD) ion source together with the LCMS-8060.

An ion source for ultra-high-speed screening analysis developed by Phytronix Technologies Inc. (<https://phytronix.com/>) in Canada was employed as the LDTD ion source. Mass spectrometry can be completed within a few seconds by sample vaporization using laser irradiation and subsequent APCI ionization. By applying samples to 96-well plates, up to 10 plates can undergo consecutive analysis. When using the LDTD ion source together with a Shimadzu LCMS-8060, each instrument can be utilized as necessary, such as for direct analysis using LDTD or for LC/MS analysis with column separation, simply by loading a method file with no need to disconnect the LDTD ion source from the LCMS-8060 (Fig. 1). This allows for MRM optimization of the compound for analysis on the LCMS-8060 and then ultra-high-speed analysis with LDTD using the determined MRM transitions. Conversely, polyspecimen analysis screening using ultra-high-speed analysis with LDTD can be performed first, and then using the results, LC/MS analysis can be performed with respect to a particular sample. In this way the combination of the LDTD ion source and LCMS-8060 can be used to switch between two completely different analysis methods according to the purpose of analysis.

In this research, we connected an LDTD ion source, performed MRM optimization of melamine using DUIS (dual ion sources of ESI and APCI), and then used the obtained MRM transitions in ultra-high-speed analysis by LDTD-MS. In performing ultra-high-speed analysis by LDTD-MS, we used a mass spectrometry system comprising an LDTD ion source and the LCMS-8060 and used samples prepared by adding melamine to powdered milk and collecting the melamine using liquid-liquid extraction. The following introduces an example of analyzing melamine in powdered milk by switching between the two analysis systems of LCMS and LDTD-MS.

■ MRM Optimization Using LC-MS with an LDTD System Connected

First, MRM optimization was performed in DUIS mode using a standard sample of melamine. The LC conditions used in optimization were the MRM optimization conditions used for general flow injection analysis (FIA). Fig. 2 shows the MS/MS spectrum (CE: -25 V) obtained when optimizing melamine in DUIS mode. Of the MRM transitions (m/z 126 > 85, 127 > 68, and 127 > 43) identified under these conditions, the MRM transition (m/z 127 > 68) with low background noise in LDTD-MS analysis was used to perform the analysis of melamine in powdered milk with LDTD-MS.

T. Nakanishi

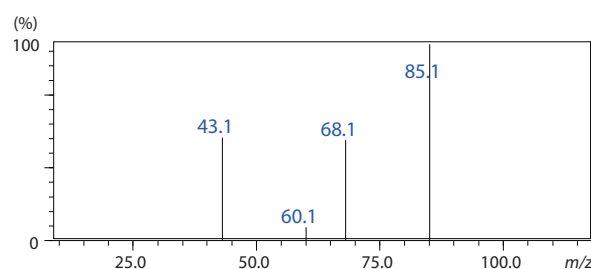
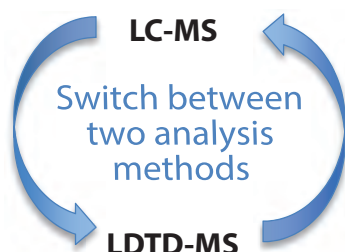

Fig. 2 MS/MS Spectrum of Melamine Using DUIS Mode



While independently utilizing the three ionization methods of ESI, APCI, and DUIS, MRM optimization of target components can be performed to ensure a smooth start to ultra-high-speed analysis using LDTD, and in cases of complex analysis samples, detailed analysis by LC/MS can be performed following the LDTD analysis.

Easy application of samples to 96-well plates for LDTD-MS allows ultra-high-speed analysis (four second ionization) of multiple components by LDTD-MS.

Fig. 1 Two Methods of Analysis Using LC-MS and LDTD-MS

■ Extraction of Melamine Added to Powdered Milk

Commercially-available powdered milk was weighed out (125 mg portions) and transferred to 1.5 mL Eppendorf tubes. Next, 0.5 mL of ultra pure water and 0.5 mL of acetonitrile were added and the mixtures were thoroughly agitated for one minute. Then, 12.5 μ L of 0, 5, 10, 25, 50, 100, 500, and 1000 μ g/mL melamine solutions prepared in advance were added to each powdered milk suspension. These correspond to the concentrations of 0, 0.5, 1, 2.5, 5, 10, 50, and 100 ppm in the powdered milk. Further agitation was performed for another minute to ensure that the added melamine was sufficiently mixed into each solution. Powdered milk components were precipitated by centrifugal separation (14,000 g, room temperature, 5 min) and 200 μ L of supernatant containing melamine was collected and transferred to new tubes. Next, 200 μ L of sodium carbonate buffer solution (saturated NaCl, pH 10) was added and thoroughly agitated, and then 1 mL of ethyl acetate was added and sufficiently agitated. Since this separates into an aqueous layer and organic layer, centrifugal separation was performed. From the organic layer which contains melamine, 4 μ L was taken and dispensed into a LazWell plate (96 well) and then dried. The LazWell plate was set into the LDTD ion source and batch analysis was performed on each sample.

Table 1 LDTD-MS Analysis Conditions

LDTD Analysis Conditions	
Laser pattern	: 65 % laser power, 2 seconds
Gas flow rate	: 3.0 L/min
MS Analysis Conditions	
Mode	: MRM (pos)
Interface	: APCI
DL temperature	: 250 °C
Heat block temperature	: 400 °C

■ LDTD-MS Analysis of Melamine Added to Powdered Milk

Table 1 summarizes the LDTD-MS analysis conditions. Fig. 3 shows MRM chromatograms of melamine added to powdered milk (corresponding to 0.5, 5, and 50 ppm concentrations in the powdered milk). It is apparent that the LDTD ion source ionized the melamine within just six seconds (within 0.1 minute). Also, analysis at $n = 3$ of the samples with melamine added at each concentration resulted in favorable repeatability as shown in Fig. 3. These results indicate that ultra-high-speed analysis by LDTD-MS has unparalleled throughput and is capable of quantitative analysis with high repeatability that is comparable to LCMS analysis. Next, the peak area for each additive concentration of melamine was graphed based on the analysis results of each sample concentration (Fig. 4). A linearity of $R^2 = 0.998$ was verified from these analysis results. From these results we can see that LDTD-MS enables ultra-high-speed analysis with both high repeatability and linearity, even for samples that contain many impurities, such as melamine in powdered milk.

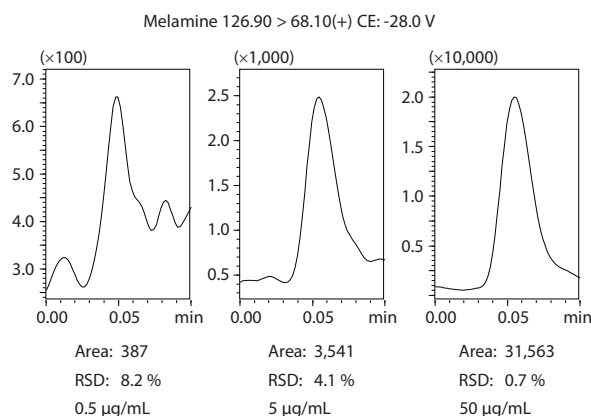

Fig. 3 MRM Chromatograms of Melamine Added to Powdered Milk

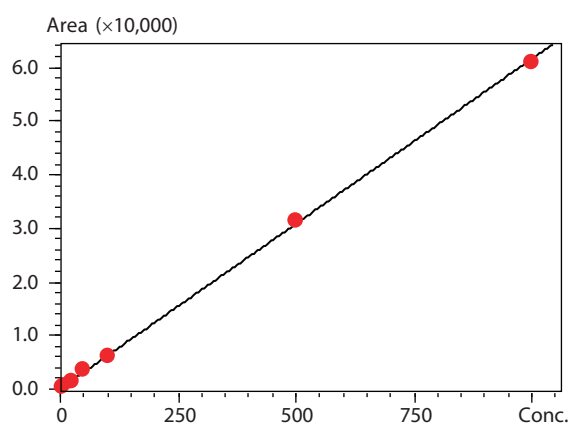

Fig. 4 Linearity of Melamine Added to Powdered Milk

In this research, we performed MRM optimization in DUIS mode on the LCMS-8060 followed by ultra-high-speed analysis using LDTD-MS with respect to melamine added to powdered milk, and verified the level of repeatability and linearity. As demonstrated, the combination of the LCMS-8060 with an LDTD ion source allows easy switching of the analysis system according to the purpose of analysis, thereby allowing multicomponent optimization by LCMS, or LCMS analysis of complex analysis samples as necessary based on the results of simple ultra-high-speed screening analysis by LDTD. These two characteristic analysis methods can be utilized as necessary.

Determination of 5 Kinds of Estrogens in Milk using LCMS-8045

Jianli Chen
Shimadzu (China), Shanghai Analysis Center

Application News
SSL-CA14-360

Abstract

A method for determination of three kinds of natural estrogen (estrone, 17 β -estradiol, and estriol) and two kinds of synthetic estrogen (hexestrol and diethylstilbestrol) in milk was developed using Shimadzu's ultra-high performance liquid chromatograph (UHPLC) LC-30A coupled with the triple quadrupole mass spectrometer LCMS-8045. Proteins in milk samples were precipitated with acetonitrile and extracted by sonication. Without any further pretreatment and derivatization, the samples were analyzed by the ESI-MS/MS in negative ion mode. The samples were quantified by an external standard method. The linearity of the calibration curve was good and all linear correlation coefficients were at or above 0.9993. Samples of low, medium and high concentrations were tested in 6 replicates. The relative standard deviations of retention time and peak area were 0.05 to 0.12% and 0.42 to 8.26%, respectively. The method's limit of quantitation was 0.006 to 0.033 ng/mL. This method, characterized by simple sample preparation, high sensitivity and good repeatability, can be used for determination of estrogen content in milk products.

Estrogen is a type of steroid hormones and is widely used in dairy farming to increase milk yield in dairy cows. While the use of estrogen can increase economic efficiency, it may also give rise to estrogen residues in milk. In recent years, a large number of studies have demonstrated that estrogen can enter the human body through the food chain and may induce cancers of the breast, uterus, testis, bone, kidney, and other tissues. Therefore, the analysis and detection of estrogen in milk are of practical significance.

In this application news, estrone (E₁), 17 β -estradiol (E₂), estriol (E₃), hexestrol (HEX) and diethylstilbestrol (DES)

were used as target substances to establish a method for detection of estrogen content in milk using Shimadzu LCMS-8045. First, proteins in milk samples were precipitated with acetonitrile and extracted by sonication. Subsequently, without further pretreatment and derivatization, the samples were ionized by ESI negative ion mode and data was analyzed and collected under MRM mode. The samples were then quantitated by the external standard method. This method, characterized by simple sample preparation, high sensitivity and good repeatability, can be used for determination of estrogen content in milk products.

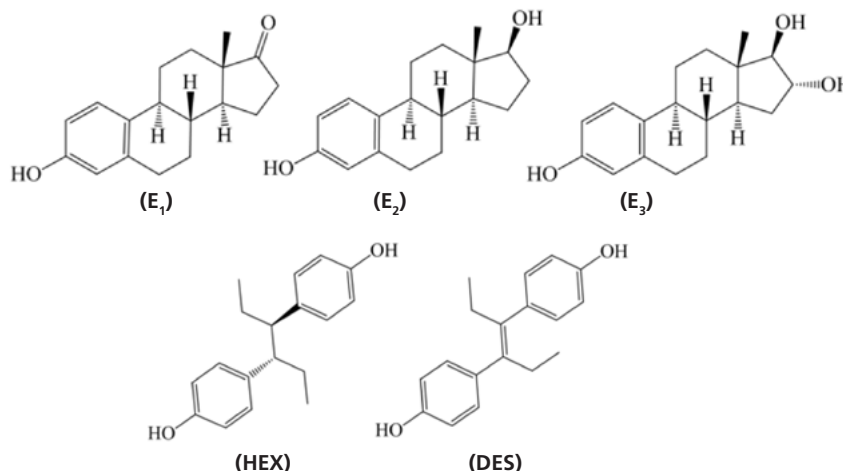

Figure 1 Structural formulas of five estrogen molecules

EXPERIMENTAL

Instrumentation

The experiment employed Shimadzu's UHPLC LC-30A and triple quadrupole mass spectrometer LCMS-8045. The configurations are two LC-30AD pumps, DGU-20A5 online degassing unit, SIL-30AC autosampler, CTO-30A column oven, CBM-20A system controller, LCMS-8045 triple quadrupole mass spectrometer and LabSolutions Ver. 5.86 chromatography workstation.

Analytical Conditions

LC Chromatography (LC) Conditions

Column	: Shim-pack GISS Column (2.1 mm I.D.×100 mm L., 1.9 μm C18)
Mobile phase	: Mobile phase A - 0.03% ammonia in water Mobile phase B-acetonitrile
Flow rate	: 0.4 mL/min
Column Temp.	: 40 °C
Injection volume	: 5 μL
Elution method	: Gradient elution with initial concentration of mobile phase B at 20%. Refer to Table 1 for detailed elution program.

Standard Solution Preparation

Preparation of standard solution: mixed standard stock solution at a concentration of 100 mg/L was serially diluted with an aqueous solution of 50% methanol to obtain standard solutions at concentrations of 0.1, 0.2, 0.5, 1.0, 5.0, 10.0, 50.0 and 100.0 ng/mL.

Sample Preparation Method

200 μL of milk sample were added

Table 1 Time program

Time (min)	Module	Command	Value (%)
0.30	Pumps	Pump B Conc.	20
0.50	Pumps	Pump B Conc.	50
3.50	Pumps	Pump B Conc.	50
3.70	Pumps	Pump B Conc.	95
4.50	Pumps	Pump B Conc.	95
4.60	Pumps	Pump B Conc.	20
7.00	Controller	Stop	

Mass Spectrometry (MS) Conditions

Ion source	: ESI (-)
Heated air	: Air 12.0 L/min
Nebulizing gas	: Nitrogen 12.0 L/min
Drying gas	: Nitrogen 8.0 L/min
Collision gas	: Argon
Interface temperature	: 350 °C
DL temperature	: 150 °C
Block heater temperature	: 350 °C
Mode	: Multiple reaction monitoring (MRM)
Dwell time	: 100 ms
Pause time	: 3 ms
MRM transitions	: Refer to Table 2

to 800 μL of acetonitrile and vortexed for 1 min. Subsequently, the sample was subjected to 20 min of sonication extraction and centrifuged at 10,000 rpm for 3 min. Finally, the supernatant was collected for testing.

Table 2 MRM transition

No.	Compound	CAS No.	Precursor Ion	Product Ion	Q1 Pre Bias (V)	CE (V)	Q3 Pre Bias (V)
1	Estriol (E3)	50-27-1	287.20	171.10*	20.0	40.0	27.0
				145.10	20.0	47.0	22.0
2	17 β-Estradiol	50-28-2	271.20	145.10*	13.0	44.0	21.0
				183.20	28.0	45.0	30.0
3	Estrone (E1)	53-16-7	269.20	145.10*	30.0	41.0	25.0
				143.00	13.0	66.0	12.0
4	Hexestrol (HEX)	84-16-2	269.20	119.05*	19.0	43.0	18.0
				134.10	19.0	16.0	11.0
5	Diethylstilbestrol (DES)	6898-97-1	267.20	251.10*	18.0	27.0	23.0
				237.10	18.0	31.0	22.0

Note: * indicates quantification ion

RESULTS AND DISCUSSION

Chromatogram of Standard Mixture

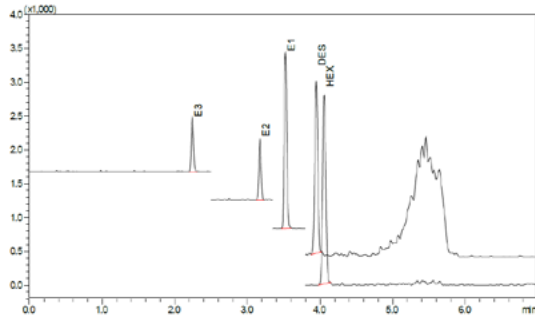

Figure 2 MRM chromatograms of standard mixture (0.2 ng/mL)

Calibration and Linearity

Standard calibration solutions of the four target compounds at concentrations of 0.1, 0.2, 0.5, 1.0, 5.0, 10.0, 50.0 and

100.0 ng/mL were determined based on conditions listed in the experimental section. An example of the MRM chromatograms of a standard sample (0.2ng/mL) is shown in Figure 2. Calibration curves were established using the external standard method and shown in Figure 3. The linear equation, linear range, and correlation coefficients are tabulated in Table 3.

Precision Test

Mixed standard samples containing 0.2, 5.0, and 100 ng/mL of target substances were prepared and tested in 6 replicates to determine the repeatability. The retention time and peak area are shown in Table 4 and it demonstrates good repeatability.

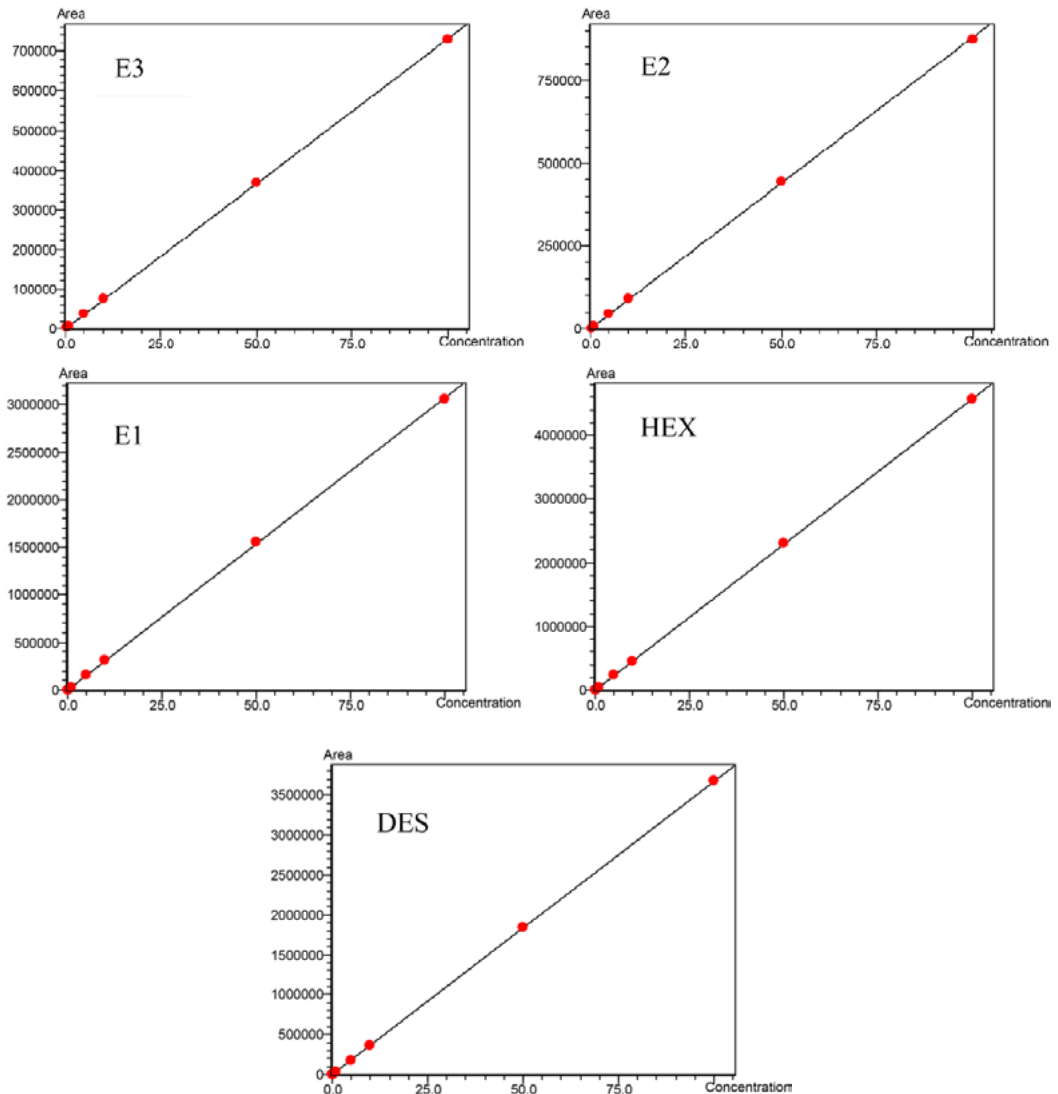

Figure 3 Calibration curve

Table 3 Parameters of calibration curve

Compound	Calibration Curve	Linear Range (ng/mL)	Correlation Coefficient (r)	Accuracy (%)
E3	$Y = (7335.5) X + 150.426$	0.2-100	0.9999	96.01-103.4%
E2	$Y = (8932.6) X - 2.7160$	0.2-100	0.9999	95.5-104.7%
E1	$Y = (30778.2) X - 18.0396$	0.1-100	0.9998	94.7-104.9%
HEX	$Y = (45714.2) X - 376.316$	0.1-100	0.9999	96.5-106.1%
DES	$Y = (36057.1) X - 196.210$	0.1-100	0.9997	93.4-105.1%

Table 4 Repeatability results of retention time and peak area (n=6)

Compound	RSD% (0.2 ng/mL)		RSD% (5.0 ng/mL)		RSD% (100 ng/mL)	
	R.T.	Area	R.T.	Area	R.T.	Area
E3	0.12	3.99	0.11	1.33	0.08	0.42
E2	0.12	5.34	0.09	1.48	0.06	0.54
E1	0.10	2.20	0.09	0.62	0.06	0.51
HEX	0.11	3.35	0.09	0.84	0.05	0.49
DES	0.08	8.26	0.09	1.62	0.05	0.39

Sensitivity Test

Standard solutions containing 0.20 ng/mL of target compounds were injected and analyzed. The limit of detection (ILOD, S/N=3) and limit of quantitation (ILOQ, S/N=10) for each target component were calculated based on the signal to noise ratios (S/N). The results are shown in Table 5.

Table 5 Limit of detection and limit of quantitation

Compound	Limit of Detection (ng/L)	Limit of Quantitation (ng/L)
E3	0.008	0.025
E2	0.007	0.021
E1	0.002	0.006
HEX	0.007	0.020
DES	0.010	0.033

Recovery Test

A certain brand of milk purchased from a supermarket was processed, injected and analyzed according to the method listed in the experimental section. The results showed that none of the five target compounds were detected, as shown in Figure 4. The five target compounds were added into the milk to determine the spike recovery. The results are shown in Table 6.

CONCLUSION

This application news describes a method for determination of three kinds of natural estrogen and two kinds of synthetic estrogen in milk using Shimadzu's ultra-high performance liquid chromatograph (UHPLC) LC-30A and triple quadrupole mass spectrometer LCMS-8045. Proteins in milk samples were precipitated with acetonitrile and extracted by sonication.

Table 6 Spike Recovery Test

Compound	Spiked Concentration (ng/mL)	Recovery (%)	Spiking Concentration (ng/mL)	Recovery (%)	Spiking Concentration (ng/mL)	Recovery (%)
E3	0.2	103.3	4.0	86.5	80	92.0
E2	0.2	87.8	4.0	103.3	80	106.0
E1	0.2	86.8	4.0	102.4	80	106.3
HEX	0.2	81.0	4.0	90.8	80	95.9
DES	0.2	83.3	4.0	102.9	80	109.4

Without any further pretreatment or derivatization, the samples were ionized by the ESI negative ion mode and the data was obtained under MRM mode. The samples were then quantified by an external standard method. The linearity of the calibration curve was good and all linear correlation coefficients were at or above 0.9993. Samples of low, medium and high concentrations were tested in 6

replicates. The relative standard deviations of retention time and peak area were 0.05 to 0.12% and 0.42 to 8.26%, respectively. The limit of quantitation was 0.006 to 0.033 ng/mL. This method, characterized by simple sample preparation, high sensitivity and good repeatability, can be used for determination of estrogen in milk products.

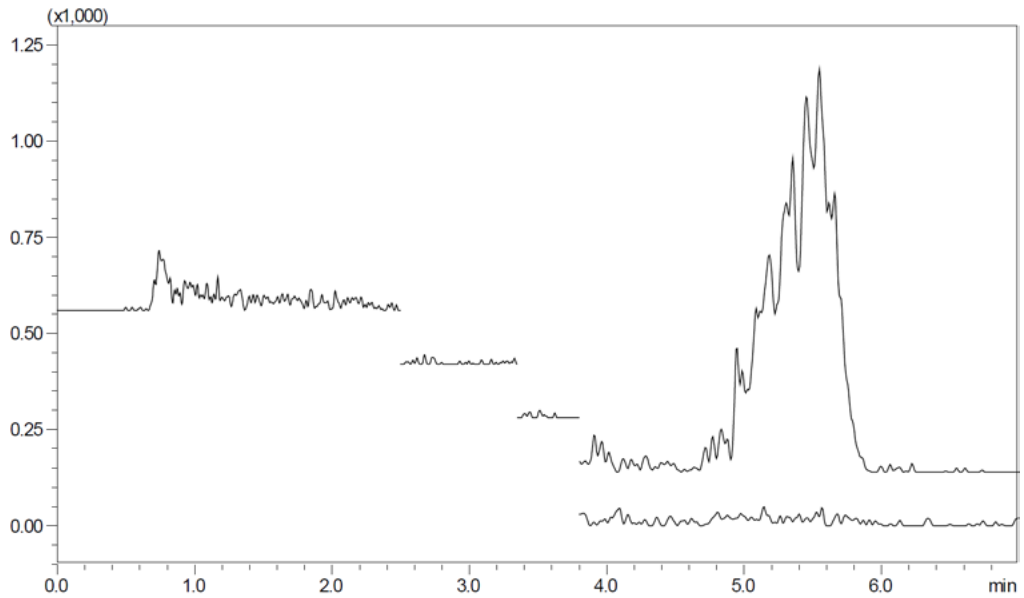

Figure 4 Chromatogram of milk sample found to not contain any targeted estrogen

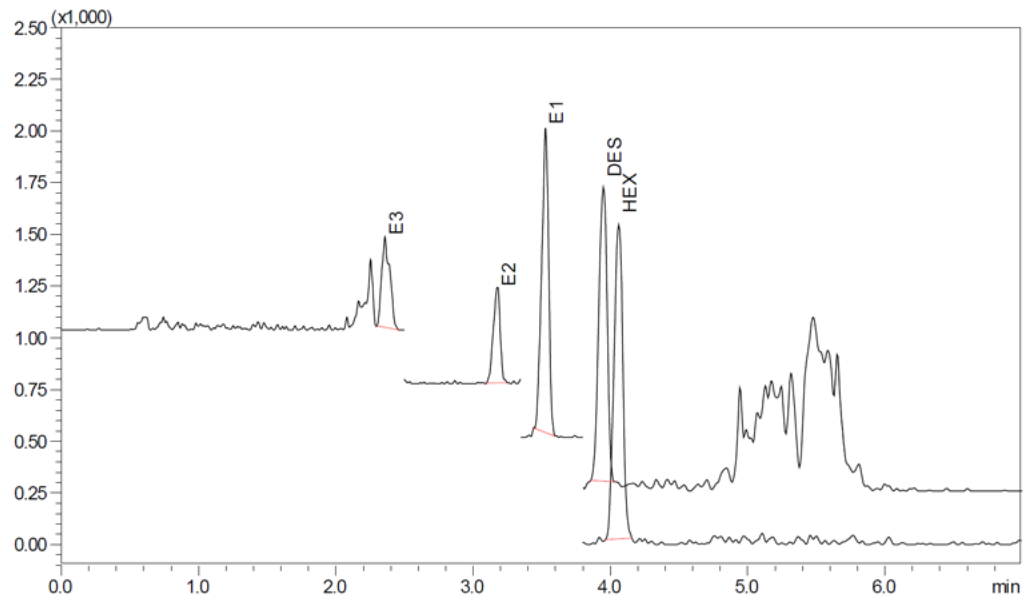

Figure 5 Chromatogram of blank sample matrix spiked with 0.2 ng/mL estrogens

Determination of Imidocarb Residues in Milk by Ultra-High Performance Liquid Chromatograph Coupled with Triple Quadrupole Mass Spectrometer

Zhiru Li
Shimadzu (China), Guangzhou Analysis Center

Application News
SSL-CA14-551

Abstract

In this application news, Shimadzu's Ultra-High Performance Liquid Chromatograph (UHPLC) LC-30A was coupled with Triple Quadrupole Mass Spectrometer LCMS-8045 for the determination of imidocarb residues in milk. This method is made in reference to the "Inspection and Quarantine Industry Standard, SN/T 4252-2015: Method for Detection of Imidocarb Residues in Animal-Derived Food for Export". The linearity was excellent over the range of 0.02 – 50 ng/mL and the correlation coefficient of the method was 0.9999. In the precision experiment, the RSD% of the retention time and peak area of imidocarb samples were 0.1 – 0.2% and 1.5 – 5.4% respectively, indicating good precision. In the spike recovery test, the spike recovery of the matrix at different concentrations ranged from 86.0 to 98.6%.

Imidocarb is a derivative of 1,3-Diphenylurea and is commonly used as a novel antiprotozoal chemical drug (veterinary medicine) used in animals. In clinical applications, imidocarb preparations are usually used in forms of dipropionate salt or bis-hydrochloride salt. Through intramuscular or subcutaneous injection, imidocarb is used in the treatment and prevention of various parasitic infections such as babesiosis, piroplasmiasis, trypanosomiasis, eperythrozoonosis, anaplasmosis and theileriosis. Imidocarb is concentrated in kidneys and resorbed in its original forms. The detoxification (metabolism) of imidocarb occurs in the liver. Therefore, the amount of imidocarb use is small and its efficacy is long-lasting, thus inducing minimal stimulation. As a veterinary medicine, imidocarb is characterized by small dosage, convenient administration, short course of treatment and low drug resistance.

Studies have shown that imidocarb has a long metabolic period and high residue levels in animals. High concentrations of imidocarb residues may pose a threat to human health. CODEX, EU, Japan, and Australia have all established standards regarding the Maximum Residue Level (MRL) of imidocarb in foods. In particular, the MRL of imidocarb in both milk and

beef fat is 50 µg/Kg.

Milk contains a high nutritional content and is the most ideal natural food for humans. Therefore, the detection of imidocarb residues in milk is of great significance. In this experiment, in reference to the "Inspection and Quarantine Industry Standard, SN/T 4252-2015: Method for Detection of Imidocarb Residues in Animal-Derived Food for Export", Shimadzu's UHPLC LC-30A was used together with the Triple Quadrupole Mass Spectrometer LCMS-8045 to establish a method for determination of imidocarb residues in milk. UHPLC-tandem mass spectrometry is characterized by high selectivity, high sensitivity, strong qualitative and quantitative capabilities, and high accuracy. Therefore, in the inspection and quarantine industry, UHPLC-tandem mass spectrometry is ideal for the analysis of veterinary drug residues in animal-derived foods.

EXPERIMENTAL Instrumentation

The experiment employed Shimadzu's UHPLC LC-30A and Triple Quadrupole Mass Spectrometer LCMS-8045. The specific configurations are two LC-30AD pumps, DGU-20A_{SR} online degassing unit, SIL-30AC autosampler,

CTO-20AC column oven, CBM-20A system controller, LCMS-8045 triple quadrupole mass spectrometer and LabSolutions LCMS DB Ver. 6.80 Chromatographic Workstation.

Analytical Conditions

Liquid Chromatography (LC) Conditions

Column	: Shim-pack GISS, 2.1 mm I.D. x 100 mm L., 1.9 µm
Mobile Phase	: Mobile Phase A-0.1% formic acid in water Mobile Phase B-methanol
Flow rate	: 0.40 mL/min
Column temp.	: 40 °C
Injection volume	: 1 µL
Type of elution	: Gradient elution with the initial concentration of Mobile Phase B at 25%. Refer to Table 1 for elution program.

Table 1 Gradient elution time program

Time (min)	Module	Command	Value (%)
0.50	pumps	B Conc.	25
1.00	pumps	B Conc.	50
2.00	pumps	B Conc.	50
2.10	pumps	B Conc.	90
3.00	pumps	B Conc.	90
3.10	pumps	B Conc.	25
5.00	controller	Stop	

Mass Spectrometry (MS) Conditions

Analytical Instrument	: LCMS-8045
Ion source	: ESI (+)
Heating gas	: Air 10.0 L/min
Nebulizing gas	: Nitrogen 3.0 L/min
Drying gas	: Nitrogen 10.0 L/min
Collision gas	: Argon
Interface temp.	: 300 °C
DL temp.	: 250 °C
Heating block temp.	: 400 °C
Scanning mode	: Multiple reaction monitoring (MRM)
Interface voltage	: 0.2 kV
MRM parameters	: See Table 2

Standard Solution Preparation

An appropriate amount of imidocarb standard was weighed and dissolved in methanol to prepare a standard stock solution at a concentration of 1.0 µg/mL. The standard stock solution was stored at 4 °C. The standard stock solution was diluted with the mobile phase at its initial ratio (0.1% formic acid in water: methanol = 75:25, v/v) to obtain standard working solutions at concentrations of 0.02 ng/mL, 0.1 ng/mL, 1 ng/mL, 10 ng/mL, and 50 ng/mL.

Sample Preparation

Sample preparation was performed according to the milk extraction and purification method in the "Inspection and Quarantine Industry Standard, SN/T 4252-2015: Method for Detection of Imidocarb Residues in Animal-Derived Food for Export". 5.00 g of the sample (to the nearest 0.01 g) was weighed and placed

Table 2 MRM optimized parameters

Compound Name	CAS No.	Precursor Ion	Product Ion	Q1 Pre Bias (V)	CE (V)	Q3 Pre Bias (V)
Imidocarb	27885-92-3	349.1	188.2*	-17	-30	-18
			162.2	-17	-25	-15

Note: * indicates quantification ion

into a 50 mL centrifuge tube. After adding the extraction solution (acetonitrile: water = 8:2, v/v) to a final volume of 25 mL, the solution was vortexed and mixed for 2 min. Subsequently, the solution was centrifuged at 4500 r/min for 8 min, and 5 mL of the supernatant was transferred into another centrifuge tube. After adding sodium hydroxide solution into the supernatant (sample solution) to adjust the pH to approximately 8.0, the solution was centrifuged at 4000 r/min for 5 min. The sample solution was added to a WCX solid-phase extraction (SPE) column, followed by washing with 2 mL of water and 3 mL of methanol. The entire wash solution was discarded and the column was eluted with 5 mL of methanol. The eluate was collected

and completely dried with nitrogen. The residues were dissolved in 1 mL of solution (0.1% formic acid in water : methanol = 75:25, v/v) and filtered through a 0.22 µm membrane filter to obtain the final sample for analysis

RESULTS AND DISCUSSION

Q1 MS Scan and Product Ion Scan of Imidocarb Standard

The Q1 MS scan and product ion scan of the imidocarb standard are shown in Figures 1 and 2.

MRM Chromatogram of 0.02 ng/mL Imidocarb Standard Solution

The MRM chromatogram is shown in Figure 3.

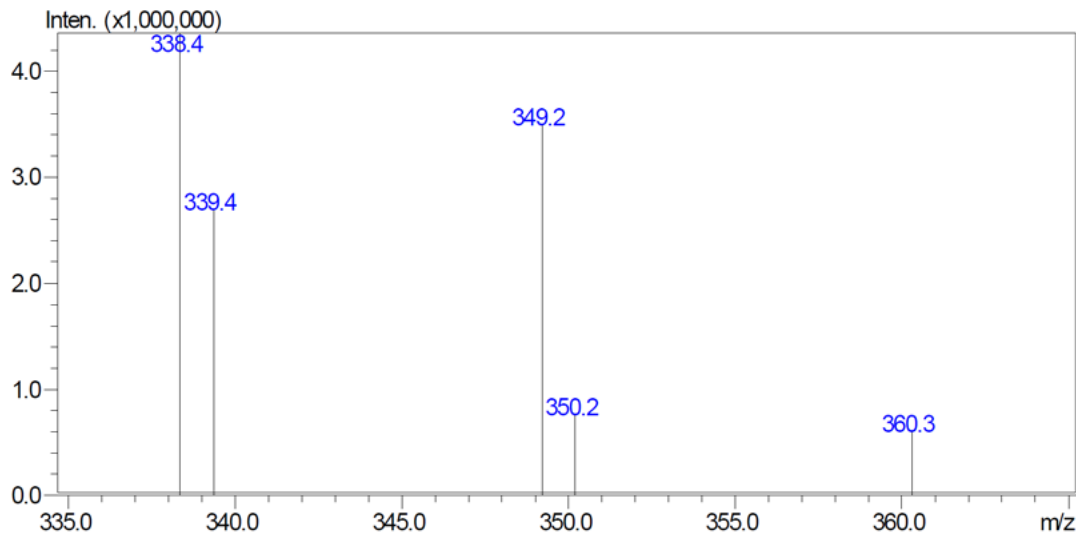

Figure 1 Q1 MS scan of imidocarb

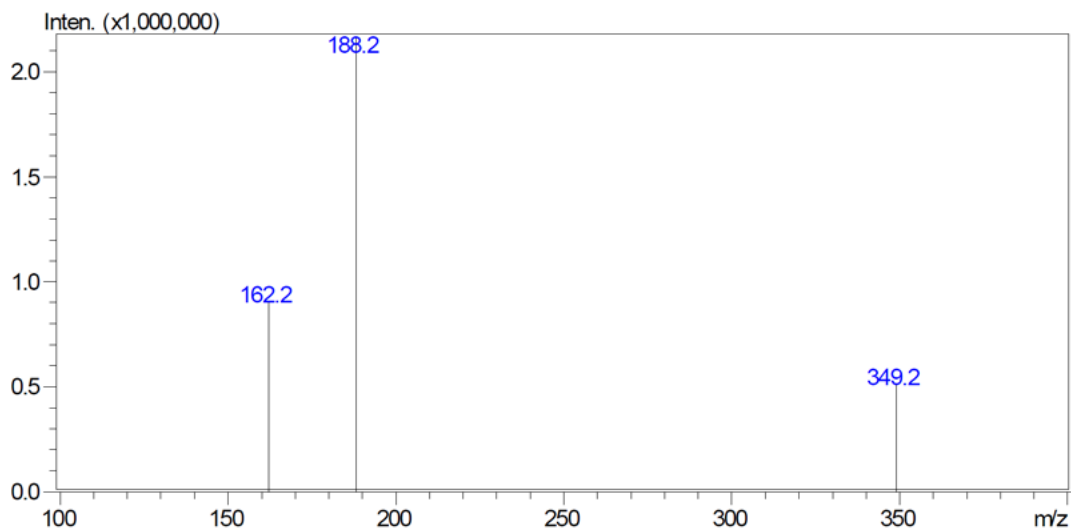

Figure 2 Product ion scan of imidocarb (the CE value was -25 V)

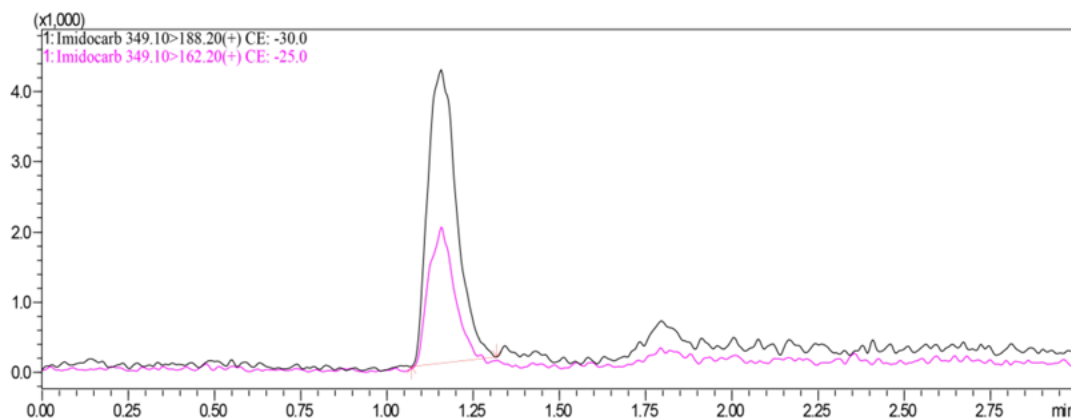

Figure 3 MRM chromatogram of 0.02 ng/mL imidocarb standard solution

Calibration Curve and Linear Range

After the measurement was performed according to the analytical conditions specified in the experimental section, a standard curve was established by the external standard method. The results are shown in Figure 4. In the linear concentration range of 0.02-50 ng/mL, the correlation coefficients of imidocarb were all greater than 0.9999 and the linear correlation of the results was excellent. The detailed results are shown in Table 3.

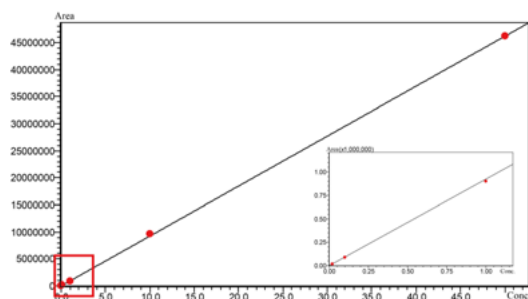

Figure 4 The standard curve of imidocarb

Precision Test

According to the analytical conditions specified in previously, the standard solutions of imidocarb at concentrations of 0.02 ng/mL, 1 ng/mL, and 50 ng/mL were injected consecutively and tested in 6 replicates. The relative standard deviation (RSD) for the retention time of imidocarb was in the range of 0.1 – 0.2%. The RSD for the peak area was in the range of 1.5 – 5.4% (see Table 4 for detailed results). The results showed that the precision was adequate.

Sensitivity Test

In order to examine the sensitivity, the imidocarb standard solution at a low concentration of 0.02 ng/mL was measured under the analytical conditions specified in the experimental section. The signal-to-noise ratio, limit of detection, and limit of quantitation were calculated using the LabSolutions LCMS DB Ver. 6.80 software. The results are shown in Table 5.

Table 3 Parameters of the calibration curve

Analyte	Linear Equation	Correlation Coefficient	Concentration Point of the Curve (ng/mL)	Accuracy (%)
Imidocarb	Y = 923549X	0.9999	0.02	92.8
			0.1	94.6
			1	99.4
			10	103.3
			50	99.9

Table 4 Precision results (n=6)

Analyte	0.02 ng/mL		1 ng/mL		50 ng/mL	
	Retention Time (Min)	Peak Area	Retention Time (Min)	Peak Area	Retention Time (Min)	Peak Area
Imidocarb	1.158	22343	1.147	688961	1.143	40201400
	1.162	21251	1.148	697204	1.141	40360042
	1.155	24061	1.152	690845	1.141	40507473
	1.156	24457	1.152	718771	1.143	40860853
	1.156	22054	1.147	711057	1.142	41454168
	1.160	22913	1.147	718038	1.145	41716697
Average	1.157	22846	1.149	704146	1.143	40850106
RSD%	0.2	5.4	0.2	1.9	0.1	1.5

Table 5 Signal-to-noise ratio(S/N), limit of detection and limit of quantitation

Analyte	Conc. (ng/mL)	S/N	LOD (ng/mL)	LOQ (ng/mL)
Imidocarb	0.02	19.2	0.003	0.01

the pretreatment method specified in experimental section. The final volume of the sample was 1.0 mL.

As specified in SN/T 4252-2015, the lower limit of detection for imidocarb is 25 µg/kg. No imidocarb was detected in the sample. The samples were spiked to obtain the final spiked concentrations of 0.02 ng/mL (0.02 µg/kg), 1 ng/mL (1 µg/kg) and 50 ng/mL (50 µg/kg). Each spiked sample was continuously injected 6 times. The chromatograms of the spiked samples and the spike recovery rates are shown in Figure 6 and Table 6 respectively. From

Spike Recovery

The milk sample solutions, prepared as mentioned in experimental section, were injected and analyzed to obtain the chromatogram shown in Figure 5. The imidocarb standard solution was added into 5.00 g of milk sample and the matrix spike sample was prepared according to

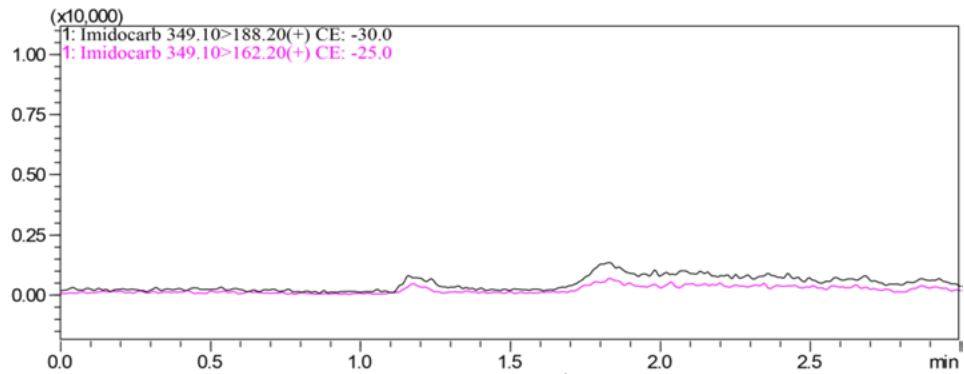

Figure 5 Chromatogram of milk samples

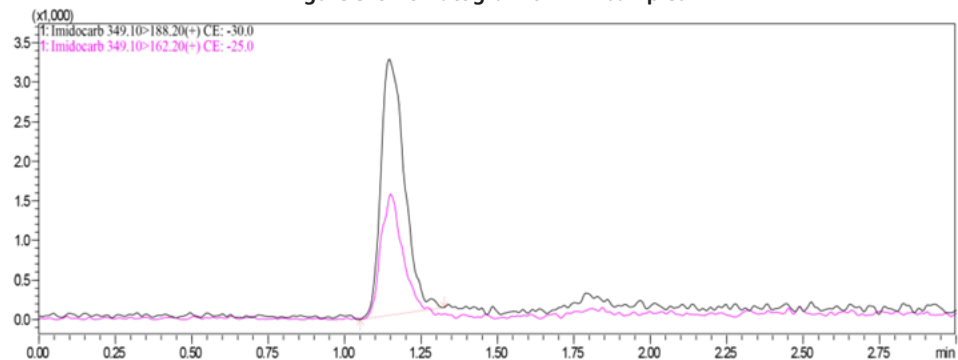

Figure 6 Chromatogram of milk samples using 0.02 µg/kg of imidocarb standard addition

Table 6 Spike recovery (n=6)

Analyte/Spiked Amount	Detected Concentration µg/kg	Spike Recovery (%)		
		0.02 µg/kg	1 µg/kg	50 µg/kg
Imidocarb	N.D.	92.0	89.0	99.0
		83.5	90.9	97.7
		82.0	87.5	99.8
		85.5	86.8	97.9
		89.5	87.9	99.5
		85.5	88.7	97.7
Average Recovery (%)		86.0	88.5	98.6
RSD%		5.0	1.6	0.9

(N.D.: Not Detected)

Table 6, it is observed that when the level of imidocarb spiked in the matrix was 0.02 µg/kg, the recovery was in the range of 82.0-92.0%; at the level of 1 µg/kg, the recovery was in the range of 86.8-90.9%; at the level of 50 µg/kg, the recovery was in the range of 97.7-99.5%. The spiked samples showed an adequate response above the limit of quantitation. Therefore, the method can meet the requirements for the quantitative analysis of the samples.

CONCLUSION

This application news established a method for determination of imidocarb residues in milk using Shimadzu's UHPLC LC-30A coupled with Triple Quadrupole Mass Spectrometer LCMS-

8045. The linearity was excellent over the concentration range of 0.02-50 ng/mL and the correlation coefficient was 0.9999. The precision was evaluated and the RSD% of the retention time and peak area of imidocarb samples were 0.1 – 0.2% and 1.5 – 5.4% respectively, indicating the adequate precision. In the spike recovery test, the spike recovery of the matrix at different concentrations ranged from 86.0 to 98.6%. This method, characterized by fast analysis, high sensitivity and excellent reproducibility, is suitable for the detection and analysis of imidocarb residues by the inspection/quarantine department and related industries.

Analysis of toxic elements in processed milk products using ICP-MS

ASMS 2017 TP 195

Mangesh Pawar¹, Amol Shinde¹, Sampada Khopkar¹,
Ankush Bhone¹, Ajit Datar¹, Pratap Rasam¹, Jitendra Kelkar¹
Shimadzu Analytical (India) Pvt. Ltd., 1 A/B Rushabh
Chambers, Makwana Road, Marol, Andheri (E),
Mumbai-400059, Maharashtra, India.

Analysis of toxic elements in processed milk products using ICP-MS

Introduction

Milk is considered as complete food as it provides all essential macro and micronutrients. Macronutrients consist of protein, carbohydrate and lipids, whereas micronutrients consist of elements, vitamins and enzymes^{[1][2]}. Milk as an excretion of the mammary gland can carry numerous xenobiotic substances that constitute a technological risk factor for milk and milk products.

Toxic elements like Arsenic (As), Cadmium (Cd), Lead (Pb) and Mercury (Hg) have caused adverse effects on human

health. These can be transferred from contaminated soil to plants and grass, causing accumulation of these toxic metals in cattle, but also in humans consuming milk. Milk processing may also cause contamination of milk products with toxic elements.

The objective of this study is to develop a sensitive, selective, accurate and reliable method using Shimadzu ICPMS-2030 to determine the risk of toxic heavy metals in milk product.



Figure 1 Milk and processed milk products

Methods and Materials

Commercially available milk products e.g. toned milk and cheese (Figure 1) were used for the extraction of toxic heavy metals in this study. Recovery studies were

established by spiking milk product samples with standard solution of elements. The extracts obtained were analysed on Shimadzu ICPMS-2030.

Sample Preparation:

The samples were digested using microwave digestion system (Anton Paar).

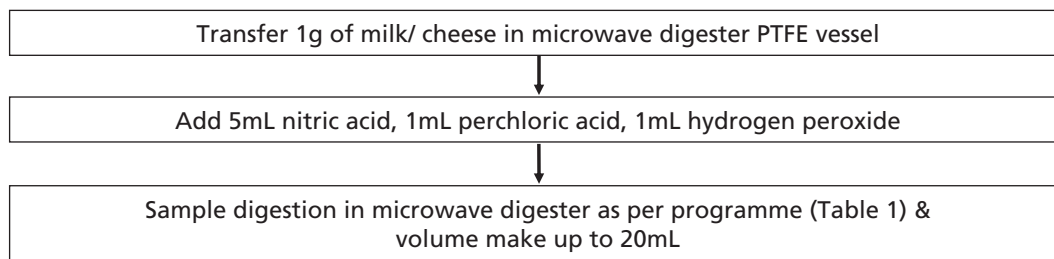

Analysis of toxic elements in processed milk products using ICP-MS

Table 1: Microwave digester programme

Steps	Ramp (min)	Temp (°C)	Hold time (min)
1	10	100	05
2	10	150	10
3	10	180	10
4	10	200	10

The extracts obtained were analysed on Shimadzu ICPMS-2030. Analysis was done using plasma generated by specially designed mini torch as an ionization source. ICPMS LabSolutions software and special features like Profile integration time and Total mass measurement

were used for identification, detection and quantitation. NIST traceable standards were used for quantification of elements at low level in QuantBase mode (used for quantitation purpose).

Key features of ICPMS-2030

Inductively coupled plasma mass spectrometer ICPMS-2030 by Shimadzu (shown in Figure 3), sets a new benchmark in ICP-MS technology with minimum consumption of Argon gas. This system ensures highest quality of data, with very high degree of reliability. The

newly developed collision cell (shown in Figure 3) based on UFsweeper technology uses high purity Helium gas for removal of polyatomic interferences. The mini-torch design allows the operation of ICPMS at low RF power without compromising the sensitivity.



Figure 2 Shimadzu ICPMS-2030 Inductively coupled plasma mass spectrometer



Figure 3 Newly developed Collision Cell

Analysis of toxic elements in processed milk products using ICP-MS

Analytical Conditions (ICPMS-2030)	
Torch	: Mini torch
Radiofrequency	: 1.2 kW
Sampling depth	: 5 mm
Plasma gas (L/min)	: 8.0
Auxiliary gas (L/min)	: 1.1
Carrier gas (L/min)	: 0.7
Cell voltage	: -21 V
Cell gas (mL/min)	: 6.0
Energy Filter	: 7V
Chamber temp.	: 5 °C
Number of scans	: 10
Integration time	: 2sec
Peristaltic pump speed	: 60 r.p.m.- High 20 r.p.m.- Low
Isotopes monitored	= ⁷⁵ As, ¹¹¹ Cd, ²⁰⁸ Pb, ²⁰² Hg
Internal standard	= ⁸⁹ Y

Linearity data for elemental standards in the concentration range of 0.1 µg/L to 10 µg/L for toned milk and cheese is shown in Figure 4 and Figure 5.

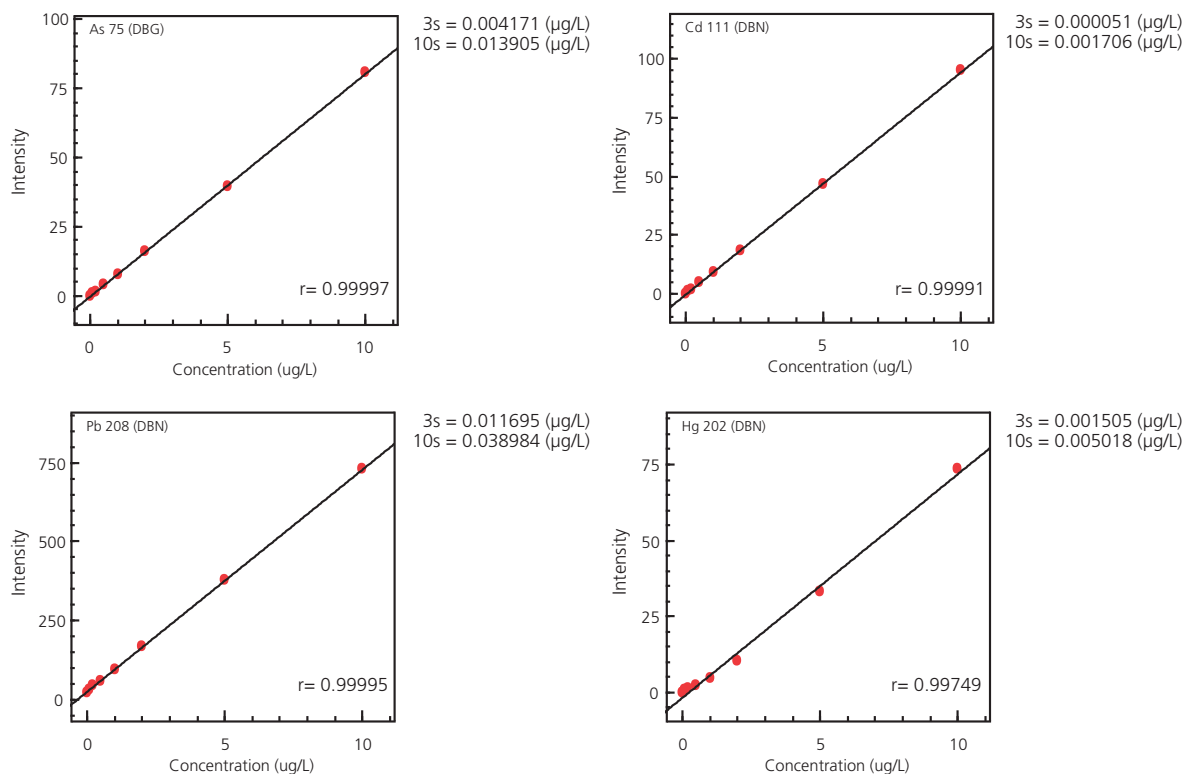

Figure 4 Standard linearity curves for 0.1-10µg/L for Milk

Analysis of toxic elements in processed milk products using ICP-MS

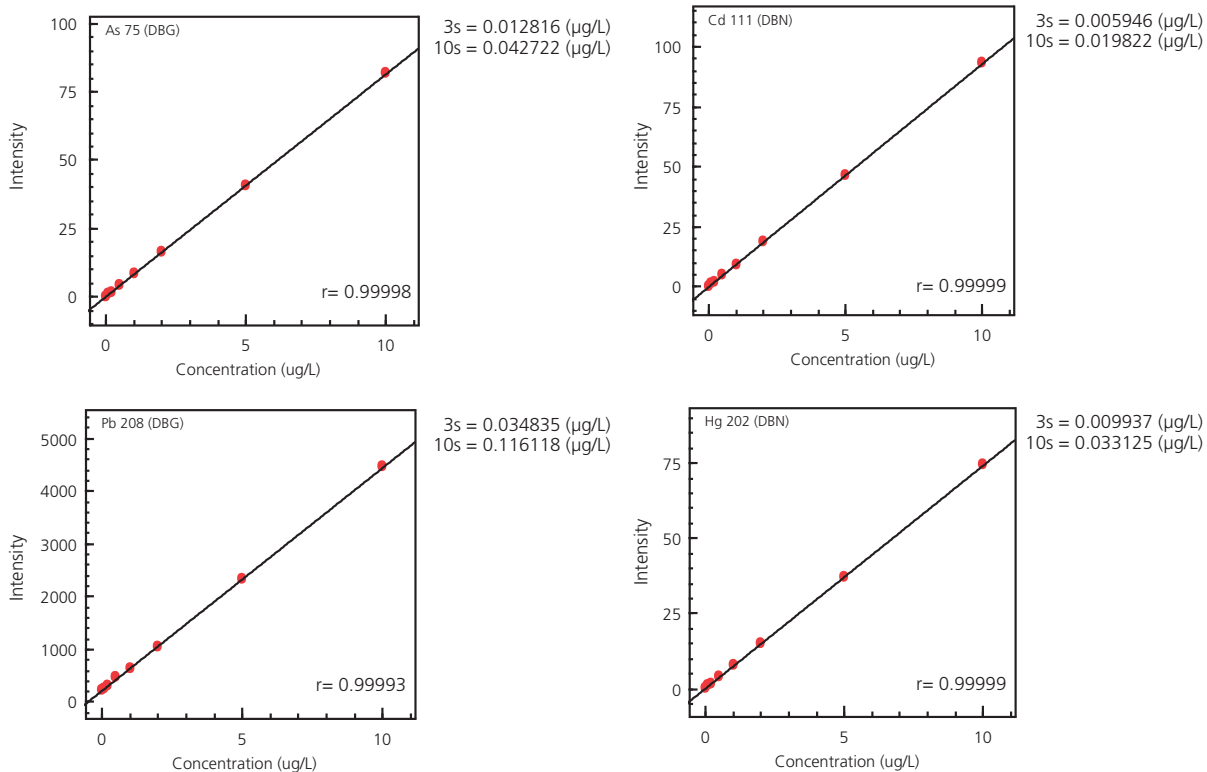

Figure 5 Standard linearity curves for 0.1-10µg/L for Cheese

Results

Extracts were analysed on ICPMS-2030 in QuanBase mode. The elements were further quantified using calibration curves plotted from analytical standards (Merck). Measurements were made using an off axis Collision cell system which helped to remove neutrals and photon interferences.

The results obtained were evaluated for statistical parameters like accuracy and linearity. Accuracy in terms of

recovery was found to be between 70 to 120% for pre-spiked samples. The results showed good linear response with correlation coefficient ≥ 0.995 . The results obtained for toned milk and cheese are given in Table 1. RSD and % recoveries for toned milk and cheese are shown in Table 2 and Table 3 respectively. The RSD of six replicates was within 7%, showing good precision of the method.

Table 2 Average elemental results obtained for processed milk products (n = 6 replicates)

Elements	Toned milk (µg/L)	Cheese (µg/L)
As	Not detected	5.0
Cd	Not detected	Not detected
Pb	5.6	Not detected
Hg	1.6	1.2

Analysis of toxic elements in processed milk products using ICP-MS

Table 3 Average accuracy results at 0.25 µg/L of for toned milk & cheese sample (n = 6 replicates)

Elements	Toned milk		Cheese	
	%Recovery (Accuracy)	%RSD	%Recovery (Accuracy)	%RSD
As	95-108	5.4	96-117	6.8
Cd	87-98	1.6	92-97	2.2
Pb	75-106	2.1	99 -115	6.3
Hg	100-110	0.9	101-107	2.4

Conclusion

ICPMS-2030 was found to be best technique for the determination of toxic heavy metals at very low concentration. The above methodology proved to be selective, sensitive, accurate and reliable.

Disclaimer: Shimadzu ICPMS-2030 and application in this poster are intended for Research Use Only (RUO). Not for use in diagnostic procedures. Not available in the USA, Canada and China.

First Edition: December, 2017

For Research Use Only. Not for use in diagnostic procedures.

This publication may contain references to products that are not available in your country. Please contact us to check the availability of these products in your country.

The content of this publication shall not be reproduced, altered or sold for any commercial purpose without the written approval of Shimadzu. Company names, products/service names and logos used in this publication are trademarks and trade names of Shimadzu Corporation, its subsidiaries or its affiliates, whether or not they are used with trademark symbol "TM" or "®".

Third-party trademarks and trade names may be used in this publication to refer to either the entities or their products/services, whether or not they are used with trademark symbol "TM" or "®".

Shimadzu disclaims any proprietary interest in trademarks and trade names other than its own.

The information contained herein is provided to you "as is" without warranty of any kind including without limitation warranties as to its accuracy or completeness. Shimadzu does not assume any responsibility or liability for any damage, whether direct or indirect, relating to the use of this publication. This publication is based upon the information available to Shimadzu on or before the date of publication, and subject to change without notice.

Application News

No.J116

Inductively Coupled Plasma Atomic Emission Spectrometry

Analysis of Nutritional and Harmful Elements in Powdered Milk by ICPE-9820 / HVG-1

■ Introduction

Minerals required for infant growth are well balanced in powdered infant formula. According to Japan's Health Promotion Law, a specific formulation of essential minerals, including calcium (Ca), iron (Fe) and copper (Cu), etc., has been established for infant formula as a special-use food, and is required to be displayed on the product label.¹⁾

However, the potential adverse effects of certain harmful elements such as arsenic (As) on infant growth and development is of utmost concern, accentuating the importance of strict safety management in the production of infant formula from the raw material stage to the finished product.

Here, using the Shimadzu ICPE-9820 simultaneous ICP atomic emission spectrometer, we conducted simultaneous analysis of elements in powdered milk (NMIJ-certified reference material). In addition, high-sensitivity analysis using an HVG-1 hydride vapor generator was conducted for the detection and quantification of the minute levels of arsenic in the sample.

The ICPE-9820 permits analysis using both high-sensitivity axial (AX) direction observation and high-concentration radial (RD) observation, thereby allowing simultaneous analysis of elements present at concentrations ranging from very low to high levels. As for detection of arsenic, the HVG-1 permits detection of As at the several tens ng/L trace level.

■ Sample

NMIJ-certified reference material; Trace Elements in Milk Powder (NMIJ CRM 7512-a: No. MI-040)

■ Sample Preparation

(1) Acid Digestion

Sample decomposition was conducted using a microwave sample digestion system. Each sample was weighed out to approximately 0.5 g, and digestion was conducted by adding 5 mL nitric acid, 2 mL hydrochloric acid and 1 mL hydrogen peroxide. Table 1 shows the sample digestion conditions. Following sample digestion, 0.5 mL of perchloric acid was added, and after conducting digestion again using the same digestion conditions, the total volume was adjusted to 20 mL using purified water. At this time, yttrium (Y) and indium (In) were added as internal standard elements to the measurement solution to obtain concentrations of 0.5 mg/L for Y, and 5.0 mg/L for In.

Table 1 Digestion Conditions Using Microwave Digestion System

STEP	Temperature (°C)	Time (Minutes)	Power (W)
1	50	2	1000
2	30	3	0
3	180	25	1000
4	150	1	0
5	180	4	1000
6	180	15	1000

(2) Pretreatment for High-Sensitivity Analysis of As Using HVG-1
After conducting digestion as described in step (1), the sample was heated (180 °C) to near-dryness on a hot plate. Then, 3 mL hydrochloric acid, 2 mL potassium iodide (200 g/L) and 0.4 mL ascorbic acid (100 g/L)

were added, and the mixture was left standing for 60 minutes. The total volume was then adjusted to 20 mL using purified water.

In addition, as reagents for operation of the HVG-1, 6 M hydrochloric acid solution and sodium borohydride solution were prepared.

(3) Validation

For validation of the analytical values, a spike and recovery test sample spiked with the standard solution containing the trace-level analyte elements (As, Cd, Cr, Pb) was prepared prior to digestion.

■ Instrument and Analytical Conditions

Measurement was conducted using the Shimadzu ICPE-9820 simultaneous ICP atomic emission spectrometer and the HVG-1 hydride vapor generator. The typical measurement conditions are shown in Table 2, and the measurement conditions using the HVG-1 are shown in Table 3.

Constituents present at high and trace level concentrations were measured using radial (RD) and high-sensitivity axial (AX) observation, respectively. This all-at-once analysis of both high-concentration components and trace components is possible due to the automatic switching between the radial and axial observation directions featured in the ICPE-9820.

The HVG-1 permits analysis of As with sensitivity that is several hundred times higher than that possible using typical measurement. Moreover, the proprietary design of the gas-liquid separator permits acquisition with stable analytical results over an extended period of time.

Table 2 Analytical Conditions

Instrument	: ICPE-9820
Radio Frequency Power	: 1.20 kW
Plasma Gas Flowrate	: 10.0 L/min
Auxiliary Gas Flowrate	: 0.60 L/min
Carrier Gas Flowrate	: 0.70 L/min
Sample Introduction	: Nebulizer 10
Misting Chamber	: Cyclone chamber
Plasma Torch	: Mini torch
Observation	: Axial (AX) / Radial (RD)

Table 3 Analytical Conditions (HVG-1)

Instrument	: ICPE-9820, HVG-1
Radio Frequency Power	: 1.20 kW
Plasma Gas Flowrate	: 10.0 L/min
Auxiliary Gas Flowrate	: 0.60 L/min
Carrier Gas Flowrate	: 0.80 L/min
Plasma Torch	: Mini torch

■ Analysis

The calibration curve method (internal standard method) was used to conduct simultaneous analysis of the minerals and harmful elements in powdered milk.

[Reference]

1) Allowable Standard for Component Composition and Display of Breast Milk and Infant Formula (published by Japan's Ministry of Health, Labour and Welfare)

Analytical Results

The analytical results are shown in Table 4. The results for the mineral elements were within the certification range, and good spike and recovery test results were obtained for the trace level toxic elements.

Table 5 shows the analysis result and spike and recovery test result for As using the HVG-1. The As detection limit in aqueous solution was 0.04 µg/L, and in powder, 2 µg/L. As for the spike and recovery test, excellent result of 99 % was obtained.

Fig. 1 shows the results of continuous analysis of a standard solution of As over a 4-hour period. The relative

standard deviation (RSD) was 1.6 %, demonstrating stable results over an extended period.

Conclusion

These results demonstrate that the ICPE-9820 can be used for simultaneous analysis of the elements in powdered milk, from the minerals present at high concentrations to the toxic substances present at trace levels. Further, in combination with the HVG-1, measurement of As at trace levels is also possible.

Table 4 Analytical Results for Powdered Milk (NMIJ CRM 7512-a)

Element	Unit	Analytical Value in Powder	NMIJ-Certified Value	Expanded Uncertainty	Detection Limit in Powder (DL: 3σ)	Analytical Value in Measurement Solution mg/L	Spike Concentration mg/L	Spike and Recovery %	Detection Limit in Measurement Solution (DL: 3σ) mg/L
Ca	g/kg	8.63	8.65	0.38	0.000002	211	-	-	0.000005
Fe		0.100	0.104	0.007	0.000006	2.45	-	-	0.0001
K		8.66	8.41	0.33	0.00002	215	-	-	0.0004
Mg		0.838	0.819	0.024	0.000002	20.5	-	-	0.000005
Na		1.78	1.87	0.09	0.00001	50.2	-	-	0.0003
P		5.52	5.62	0.23	0.0002	135	-	-	0.005
Cu	mg/kg	4.70	4.66	0.23	0.02	0.115	-	-	0.0005
Mn		0.957	0.931	0.032	0.002	0.023	-	-	0.00005
Mo		0.229	0.223	0.012	0.02	0.006	-	-	0.0006
Sr		5.89	5.88	0.20	0.0008	0.144	-	-	0.00002
Zn		40.9	41.3	1.4	0.01	1.00	-	-	0.0003
Cd		µg/kg	<DL	-	-	10	<DL	0.5	98
Cr	<DL		-	-	15	<DL	0.5	100	0.0004
Pb	<DL		-	-	97	<DL	0.5	100	0.002

<DL: Below detection limit (3σ) (concentration in measurement solution)

Spike and Recover Rate (%) = (Analytical value of spike-and-recovery test solution – Analytical Value) / Spike Concentration × 100

Table 5 Results of Analysis of As in Powdered Milk Using HVG-1 and Results of Spike and Recovery Test

Element	Unit	Analytical Value in Powder	NMIJ Reference Value	Detection Limit in Powder (DL: 3σ)	Analytical Value in Measurement Solution µg/L	Spike Concentration µg/L	Spike and Recovery %	Detection Limit in Measurement Solution (DL: 3σ) µg/L
As	µg/kg	(2.5)	2.1	2	(0.06)	4	99	0.04

Reference values in () indicate value greater than detection limit, and value less than the lower limit of quantitation.

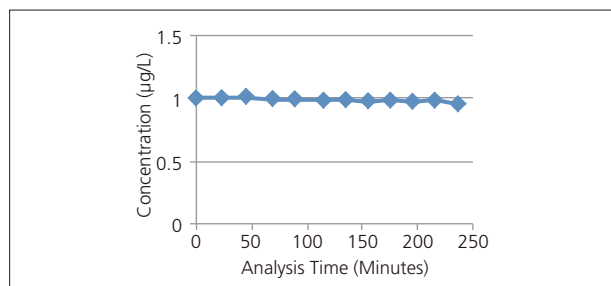

Fig. 1 Long Term Stability of As Value Using HVG-1

Continuous measurement of As 1 µg/L solution (10 % HCl-based) measured continuously every 20 minutes for four hours.

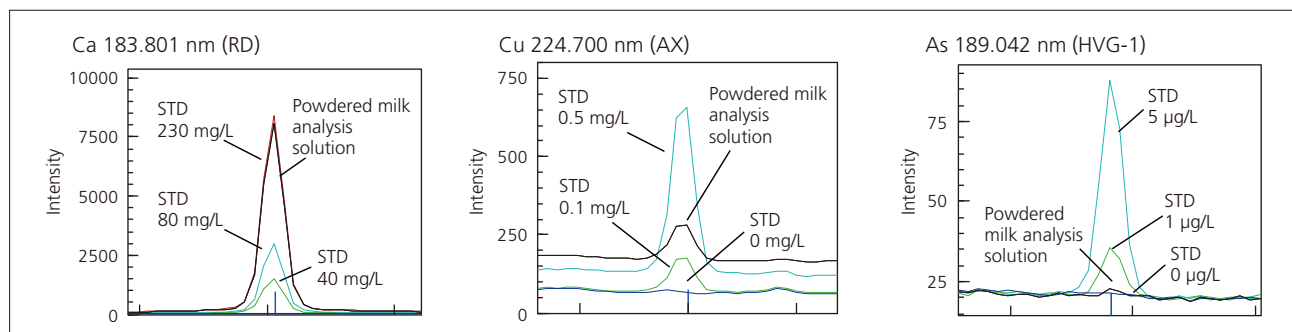

Fig. 2 Spectral Profiles of Ca, Cu, and As

[← Return to main page](#)

Grain and Edible Oil



1. Determination of Fatty Acid Esters of 2- and 3-Monochloro-1,2-propanediol (MCPD) and Glycidol in Edible Oil Using GC/Triple Quadrupole MS
2. Simultaneous Analysis of 477 Residual Pesticides in Agricultural Crops Using GC-MS/MS - Part 1
3. Simultaneous Analysis of 477 Residual Pesticides in Agricultural Crops Using GC-MS/MS - Part 2
4. Analysis of Additive Elements, Wear Metals, and Contaminants in Used Lubricating Oil According to ASTM D5185: ICPE-9820
5. Differentiating Olive Oils Using UV-VIS Spectrophotometer and Spectrofluorophotometer
6. Analysis of Food Contaminants Using KBr Cuttings: KBr Plates for KBr Pellet Formation
7. Sensitive Multi-mycotoxins Analysis with a Single Sample Preparation by LC-MS/MS
8. Use of MALDI-TOF Mass Spectrometry and Machine Learning to Detect the Adulteration of Extra Virgin Olive Oils
9. A Rapid Screening Method of Mycotoxins in Grains by Liquid Chromatograph Tandem Mass Spectrometry
10. Qualitative Determination of Edible Corn Oil Using the MultiNA and the PCR Method
11. Cost-effective SPE and LC/MS/MS for Analysis of 18 Mycotoxins
12. Testing and Analysis of Genetically Modified Food – Application of MultiNA –
13. Quantitative Determination of Lard Adulteration by FTIR Spectroscopy with Chemometrics Method - Vegetable Palm Oil
14. An Ultrafast LC/MS/MS Method for Characterization and Quantitation of Triton X-100 Extracted From Palm Oil

Determination of Fatty Acid Esters of 2- and 3-Monochloro-1,2-propanediol (MCPD) and Glycidol in Edible Oil Using GC/Triple Quadrupole MS

ASMS 2017 TP-273

Samuel Chao Ming Yeo¹, Crystal Hui Xian Yeong¹,
Kok Ming Goh², Chin Pang Tan², May Yen Ang³,
Lai Chin Loo¹

¹Shimadzu (Asia Pacific) Pte Ltd, 79 Science Park Drive,
#02-01/08, Cintech IV, Singapore Science Park 1,
Singapore 118264;

²Department of Food Technology, Faculty of Food Science
and Technology, Universiti Putra Malaysia, 43400 UPM
Serdang, Selangor, Malaysia;

³Shimadzu Malaysia Sdn Bhd, No.6 Lorong Teknologi 3/4A,
Nouvelle Industrial Park 2, Taman Sains Selangor I,
Kota Damansara, 47810 Petaling Jaya, Selangor, Malaysia

Determination of Fatty Acid Esters of 2- and 3-Monochloro-1,2-propanediol (MCPD) and Glycidol in Edible Oil Using GC/Triple Quadrupole MS

Introduction

Esterified and free forms of 2-MCPD, 3-MCPD and glycidol (Figure 1) are heat-induced contaminants found in various types of processed food.^[1] Following ingestion, esterified forms of these compounds are metabolised to the respective free forms which have been associated with a range of toxicities such as carcinogenicity and nephrotoxicity.

Various studies have investigated the levels of these contaminants in oils/fats from different sources and mitigation strategies are currently under development. Well-validated analytical methods are critical for these studies and currently, the American Oil Chemists' Society (AOCS) has adopted three methods for the analysis of

these contaminants in edible oils and fats using gas chromatography-mass spectrometry.^[2]

However, to support future studies where higher sensitivity and selectivity are necessary, analytical solutions based on triple-quadrupole mass spectrometer will be required. In the present study, a novel gas chromatography-triple quadrupole mass spectrometry (GC/TQMS) method was developed and validated for the simultaneous analysis of 2-MCPD, 3-MCPD and glycidyl fatty acid esters in edible oil. Subsequently, this method was applied for the quantitation of these contaminants in commercial edible oil samples.

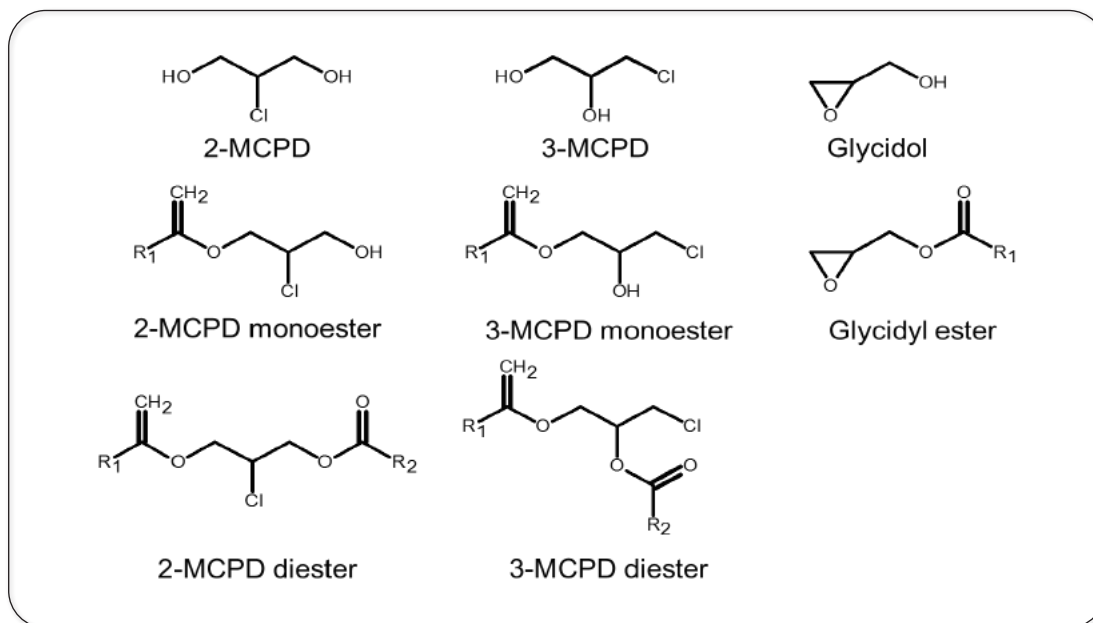

Figure 1. Structures of free and bound forms of 2-MCPD, 3-MCPD and glycidol.

Determination of Fatty Acid Esters of 2- and 3-Monochloro-1,2-propanediol (MCPD) and Glycidol in Edible Oil Using GC/Triple Quadrupole MS

Methods and Materials

Fatty acid esters of 2-MCPD, 3-MCPD and glycidol in oil were extracted and derivatised using phenylboronic acid according to the validated AOCS Official Method Cd 29a-13.^[2] The analyte standards used were 1,3-dipalmitoyl-2-chloropropanediol (PP-2-MCPD), 1,2-dipalmitoyl-3-chloropropanediol (PP-3-MCPD) and glycidyl palmitate (GlyP) (Toronto Research Chemical, Ontario, Canada). The internal standards were 1,2-dipalmitoyl-3-chloropropanediol-d5 (PP-2-MCPD-d5) (Santa Cruz Biotechnology, and glycidyl palmitate-d5 (GlyP-d5) (Toronto Research Chemical, Ontario, Canada).

Cold-pressed extra virgin olive oil was used as blank matrix. For simplicity, the target analytes in this analysis are named as 2-MCPD, 3-MCPD and glycidol although the actual analytes are the derivatives.

The extracts were analysed on a GC/TQMS system (GCMS-TQ8040, Shimadzu Corporation, Japan). Separation was performed using a 30 m × 0.25 mm × 1.0 µm capillary column (SH-Rxi-1MS, Shimadzu Corporation, Japan). Detailed instrumental conditions are presented in Table 1 and MRM parameters for the different analytes are shown in Table 2.

Table 1. Instrumental conditions used for analysis

Parameter	Setting
GC conditions	
Injection mode/volume	: Splitless/0.5 µL
Injector temperature	: 250 °C
Flow control mode	: Pressure
Pressure	: 49.7 kPa
Oven temperature programme	: 80 °C (1 min) → 10 °C/min to 170 °C (5 min) → 3 °C/min to 200 °C → 15 °C/min to 300 °C → 300 °C (15 min)
MS conditions	
Interface temperature	: 300 °C
Ion source temperature	: 230 °C

Table 2. MRM parameters used in analysis

ISP	Start Time (min)	End Time (min)	Mode	Event Time (s)	Ch1 m/z	Ch1 CE	Ch2 m/z	Ch2 CE	Ch3 m/z	Ch3 CE	Ch4 m/z	Ch4 CE	Ch5 m/z	Ch5 CE
3-MCPD-d5	17.0	19.2	MRM	0.167	150.00>93.10	15	201.00>150.20	10	201.00>93.20	30	203.00>150.10	10	203.00>93.20	25
3-MCPD	17.0	19.2	MRM	0.133	147.00>91.10	15	196.05>91.20	25	147.00>65.10	25	198.10>147.20	15	-	-
2-MCPD	19.2	21.2	MRM	0.300	196.00>104.10	20	198.00>104.10	20	196.00>91.20	10	196.00>62.00	25	198.00>91.10	10
Glycidol-d5	21.2	23.0	MRM	0.167	150.00>93.10	15	245.00>150.10	10	247.00>150.10	10	245.00>93.10	25	247.00>93.10	25
Glycidol	21.2	23.0	MRM	0.133	242.00>147.10	10	240.00>147.10	15	240.00>91.20	30	242.00>91.10	25	-	-

Determination of Fatty Acid Esters of 2- and 3-Monochloro-1,2-propanediol (MCPD) and Glycidol in Edible Oil Using GC/Triple Quadrupole MS

Results

MRM chromatograms of the analytes (using target MRM transitions) showed good peak shapes (Figure 2). The retention times of 3-MCPD-d5, 3-MCPD, 2-MCPD, glycidol-d5 and glycidol were approximately 18.4 min, 18.6 min, 19.6 min, 21.6 min and 21.7 min respectively.

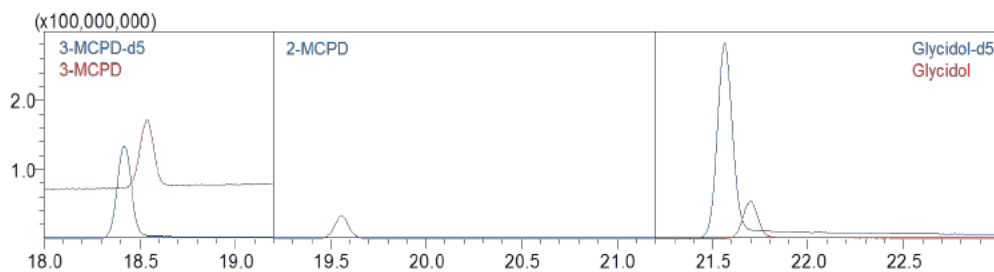

Figure 2. Representative MRM chromatogram where 3-MCPD-d5, 3-MCPD, 2-MCPD, glycidol-d5 and glycidol were eluted at 18.4 min, 18.6 min, 19.6 min, 21.6 min and 21.7 min, respectively.

Method validation was carried out to assess parameters such as sensitivity, accuracy, precision, linearity and repeatability using calibration standards or quality control (QC) sample. Subsequently, this method was applied for the quantitation of the different analytes in commercially available edible oil samples

Sensitivity

The sensitivity of the assay was examined by measuring the signal to noise (S/N) ratio of the analyte peaks. The was defined as S/N ratio of at least 5. The LOD (limit of detection) for this method was 0.003 μg of 2-MCPD and 3-MCPD and 0.006 μg of glycidol. The limit of quantitation (LOQ) was defined as S/N ratio of at least 10. The LOQ of this method was 0.01 μg of 2-MCPD and 3-MCPD and 0.024 μg of glycidol.

Linearity

Eight calibration standards ranging from 2-MCPD and 3-MCPD: 0.010 μg , glycidol: 0.024 μg to 2-MCPD and 3-MCPD: 0.930 μg , glycidol: 2.130 μg were used to construct the calibration curves. The calibration curves (Figure 3) for all analytes showed excellent linearity ($R^2 > 0.998$) ($n = 6$).

Repeatability

Excellent repeatability of the peak areas of consecutive injections were achieved for all analytes ($< 3\%$) ($n = 6$).

Accuracy and Precision

QC samples at three concentrations (QC1, QC2 and QC3) were used to investigate the accuracy and precision of the method. High accuracy and precision were demonstrated for this method as the accuracy of the QC samples were all within $100 \pm 7\%$ and the %RSD were all $< 10\%$ ($n = 6$).

Application of method for quantitation of analytes in commercially available edible oil samples

The validated method was applied for the quantitation of esters of 2-MCPD, 3-MCPD and glycidol in edible oil samples from different sources (Table 3, Figure 4). Generally, samples containing palm oil were found to contain the highest levels of the contaminants.

Determination of Fatty Acid Esters of 2- and 3-Monochloro-1,2-propanediol (MCPD) and Glycidol in Edible Oil Using GC/Triple Quadrupole MS

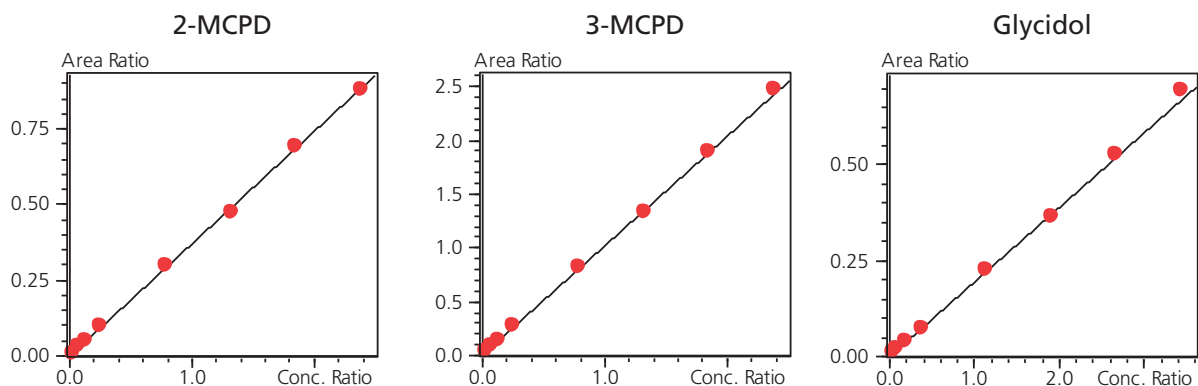

Figure 3. Calibration curves for the analytes 2-MCPD, 3-MCPD and glycidol where the x axis is the concentration ratio and y axis is the peak area ratio between analyte and IS peak areas.

Table 3. Concentration of contaminants in commercially available edible oil samples

Sample	Analyte Concentration (ppm) (n=3)		
	2-MCPD	3-MCPD	Glycidol
Kenaf seed oil	0.173 ± 0.007	0.354 ± 0.008	0.367 ± 0.003
Mustard oil	< LOQ	< LOQ	< LOQ
Olive oil	< LOQ	< LOQ	< LOQ
Palm oil A	2.820 ± 0.062	5.313 ± 0.032	8.813 ± 0.131
Palm oil B	0.653 ± 0.032	1.145 ± 0.023	5.891 ± 0.032
Peanut oil	0.491 ± 0.008	0.898 ± 0050	0.589 ± 0.016
Vegetable cooking oil*	1.346 ± 0.0182	2.804 ± 0.061	4.273 ± 0.046

*Vegetable cooking oil contains palm olein and soyabean oil

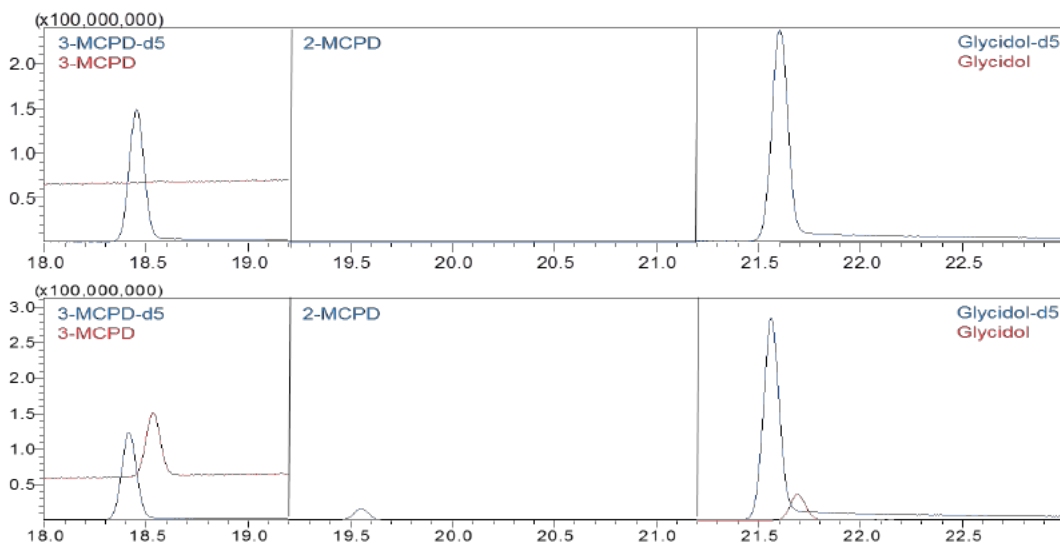

Figure 4. Representative MRM chromatograms of olive oil (top) and kenaf seed oil (bottom) shown below.

Determination of Fatty Acid Esters of 2- and 3-Monochloro-1,2-propanediol (MCPD) and Glycidol in Edible Oil Using GC/Triple Quadrupole MS

Conclusions

In summary, a novel GC/TQMS method was developed and validated for the simultaneous analysis of 2- and 3-MCPD and glycidol fatty acid esters in edible oil. This method showed more than 3-fold improvement in sensitivity compared to the official method currently available and demonstrated excellent linearity, repeatability, accuracy and precision. Application of this method to the analyses of commercially available edible oil samples confirmed that samples containing palm oil show higher levels of contaminants.

References

- [1] Federation for European Oil and Proteinmeal Industry. 2016. FEDIOL Q&A on 2- and 3-MCPD and Their Esters and Glycidyl Esters
- [2] The American Oil Chemists' Society. 2013. 2- and 3-MCPD Fatty Acid Esters and Glycidol Fatty Acid Esters in Edible Oils and Fats by Acid Transesterification. AOCS Official Method Cd29a-13, Cd29b-13 and Cd29c-13

Disclaimer: The products and applications in this poster are intended for Research Use Only (RUO). Not for use in diagnostic procedures.

Application Data Sheet

No. 106

GC-MS

Gas Chromatograph Mass Spectrometer

Simultaneous Analysis of 477 Residual Pesticides in Agricultural Crops Using GC-MS/MS - Part 1

GC-MS/MS systems can measure more than 400 residual pesticides in foods. However, analyzing more than 400 pesticides simultaneously requires a short dwell time (data loading time) during MRM measurements, which results in problems with inadequate sensitivity and the tedious process of creating MRM measurement programs. Consequently, several different methods are used for target pesticides and the same sample is measured multiple times to analyze all components. That can decrease productivity, due to the time required for analyzing all the components involved in the large number of pesticides being inspected. This Application Data Sheet describes a solution to these problems with the creation of a method for simultaneously analyzing 477 components and evaluating the resulting sensitivity and accuracy.

Experiment

Matrix solutions were prepared by processing soy bean, orange, brown rice, and spinach samples according to a pretreatment procedure for residual pesticide analysis, and then purifying them using the GPC Cleanup System (from Shimadzu Corporation).¹⁾ Measurement sample solutions (1 g/mL sample concentration) were then prepared by spiking the prepared matrix solutions with 477 components (including internal standard substances) to a concentration of 5 ppb (or 200 ppb for the internal standard substances). 19 kinds*¹ of surrogate pesticides were used as the internal standard substances. The GCMS-TQ8040 combined with the Twin Line MS System was used to measure samples based on the analytical conditions listed in Table 1. Two transitions were specified for each component, one for quantitation and the other for confirmation, and Smart MRM was used to automatically create a measurement program.

Table 1: Analysis Conditions

GC-MS:	GCMS-TQ8040 (Twin Line MS System)		
Column 1:	SH-Rxi-5Sil MS (30m L., 0.25 mm I.D., df=0.25 μm) (Shimadzu, P/N: 221-75954-30)		
Column 2:	SH-Rtx-200 MS (30m L., 0.25 mm I.D., df=0.25 μm) (Shimadzu, P/N: 221-75811-30)		
Glass Insert :	Sky Liner, Splitless Single Taper Gooseneck w/Wool (Restek, P/N: 567366)		
[GC]		[MS]	
Injection Temp.:	250 °C	Interface Temp.:	300 °C
Column Oven Temp.:	60 °C (1 min) → (25 °C/min) → 160 °C → (4 °C/min) → 240 °C → (10 °C/min) → 290 °C (11 min)	Ion Source Temp.:	200 °C
Injection Mode:	Splitless	Measurement Mode:	MRM
High Pressure Injection:	250 kPa (1.5 min)	Loop Time:	0.4 sec
Carrier Gas Control:	Linear Velocity (40.0 cm/sec)	Processing Time Required:	0.3 min
Injection Volume:	2 μL		

Analysis Results

The relationship between the dwell time and retention time in the measurement program created using Smart MRM is shown in Fig. 1. The average dwell time for all components was 12.3 msec, with over 6.5 msec provided even for retention time bands where a high number of pesticides were eluted. Consequently, compared to conventional measurement methods that divide analysis into segments, Smart MRM provides, on average, 2.5 time longer dwell times and makes it easy to create optimal MRM measurement programs.

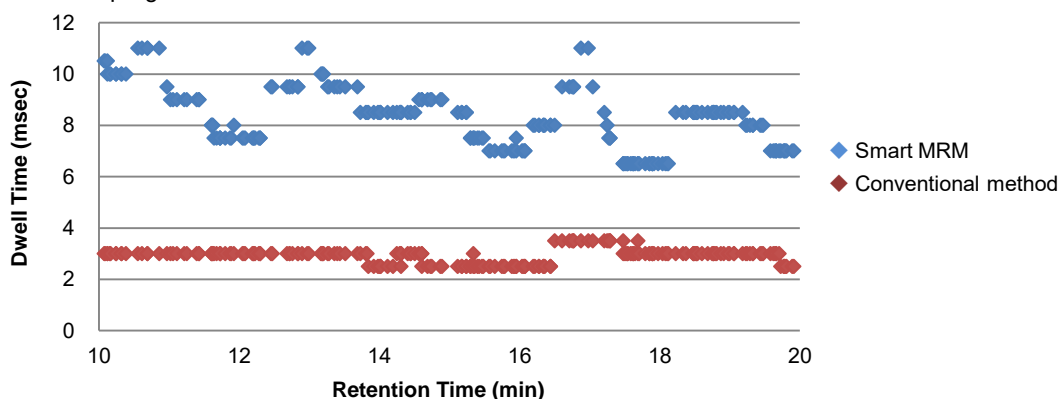

Fig. 1 Relationship Between Retention Time and Dwell Time (for retention times from 10 to 20 minutes)

1) E. Ueno, et al., *J. AOAC INT.* **87**, (2004) 1003-1015

*1 Dichlorvos-*d*₆, acephate-*d*₆, diazinon-*d*₁₀, iprobenfos-*d*₇, carbaryl-*d*₇, fenitrothion-*d*₆, linuron-*d*₆, metolachlor-*d*₆, chlorpyrifos-*d*₁₀, diethofencarb-*d*₇, fosthiazate-*d*₅, pendimethalin-*d*₅, thiabendazole-¹³C₆, imazalil-*d*₅, isoprothiolane-*d*₄, isoxathion-*d*₁₀, EPN-*d*₅, etofenprox-*d*₅, and esfenvalerate-*d*₇

The repeatability for each matrix was used to evaluate whether the measurement program created using Smart MRM provided adequate sensitivity. The %RSD distribution obtained for each matrix is shown in Fig. 2 and the %RSD values for 100 of the 477 components are tabulated in Table 2. These results show that %RSD (n = 5) was 10 % or less for 88 % of targets (1618 of the 1832 components in four types of matrix), which indicates that high analytical accuracy was achieved when analyzing as many as 477 components simultaneously. By eliminating the need to split the analysis using multiple methods, the number of injections is reduced and productivity increased. This also allows maintenance frequency and costs to be minimized. Though matrix interference was identified for a few components, high-accuracy detection was possible by using the Twin Line MS system, which uses two columns with different separation characteristics. For information regarding the Twin Line MS System, refer to Application Data Sheet 107.

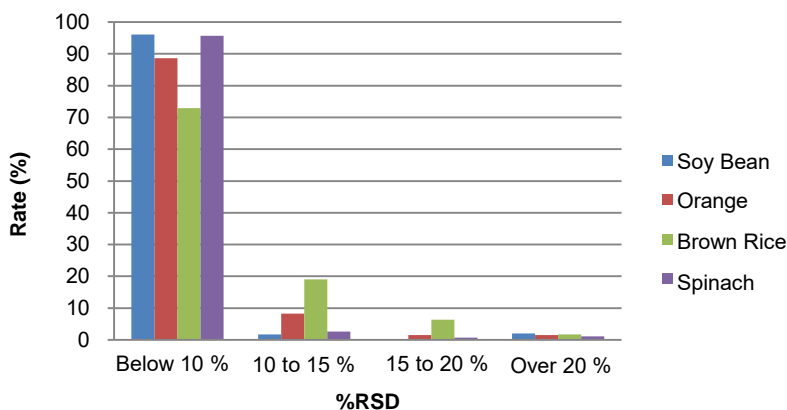

Fig. 2 %RSD Distribution for Each Matrix

Table 2: %RSD (n = 5) of Samples Spiked with Pesticides (5 ppb)

Name of Compound	Soy Bean	Orange	Brown Rice	Spinach	Name of Compound	Soy Beans	Orange	Brown Rice	Spinach	Name of Compound	Soy Bean	Orange	Brown Rice	Spinach
Methamidophos	4.82	7.66	8.84	1.86	Fthalide	6.92	5.01	12.09	4.79	Trifloxystrobin	6.80	8.83	8.84	5.89
Acephate	4.72	4.29	4.85	6.89	Fosthiazate-1	9.53	4.33	14.06	3.16	Tebuconazole	6.63	4.46	9.34	5.18
Propham	<u>4.55</u>	3.84	<u>15.43</u>	3.13	Fosthiazate-2	7.90	3.44	15.15	8.60	Piperonyl butoxide	4.41	3.91	9.63	2.78
Clothianidin	<u>3.66</u>	<u>4.84</u>	<u>7.53</u>	<u>2.92</u>	Pendimethalin	9.80	5.24	9.81	6.47	Acetamiprid	7.56	7.09	8.10	3.44
Chloroneb	<u>4.35</u>	<u>2.74</u>	<u>12.91</u>	<u>5.54</u>	Fipronil	9.68	11.76	9.33	9.72	Iprodione	8.26	3.90	9.09	3.65
Fenobcarb	2.95	3.02	7.72	2.14	Heptachlor-exo-epoxide	5.92	13.72	8.89	7.93	EPN	7.68	9.03	5.85	7.96
Phorate	6.20	4.87	10.62	4.72	Thiabendazole	4.22	<u>3.90</u>	9.34	5.03	Bromopropylate	4.58	3.65	9.49	3.71
Dimethoate	7.03	5.21	8.75	6.91	Captan	14.99	<u>3.41</u>	5.66	10.28	Bifenthrin	4.52	2.87	8.77	2.67
gamma-BHC	9.73	3.38	9.13	7.18	Phenthoate	8.96	1.92	9.77	5.60	Bifenazate	9.05	7.67	<u>9.58</u>	6.96
Cyanophos	5.89	3.82	8.64	4.01	Quinalphos	6.63	5.12	8.38	7.46	Fenpropathrin	8.53	4.96	9.79	9.01
Terbufos	2.89	4.37	7.94	5.04	Procymidone	4.31	5.49	12.58	5.87	Tebufenpyrad	3.66	4.18	9.73	2.88
Diazinon	8.13	4.68	9.35	7.42	Triflumizole	7.71	7.73	7.93	8.74	Tetradifon	8.47	4.02	8.83	7.17
Pyrimethanil	2.80	3.38	8.13	5.52	Chinomethionat	7.98	4.48	11.60	1.82	Azinphos-methyl	7.95	8.06	8.35	5.72
Iprobenfos	3.77	3.83	12.89	3.25	Trichlamide	7.78	3.23	9.93	5.82	Pyriproxyfen	4.25	6.00	5.30	3.39
Benoxacor	7.31	1.86	8.91	4.25	Butachlor	9.05	<u>5.75</u>	8.79	5.25	Fenarimol	1.45	4.13	9.64	2.72
Acetochlor	6.74	6.94	8.74	3.01	Alpha-endosulfan	8.92	3.48	9.39	3.12	Acrinathrin	5.27	9.02	8.37	8.17
Parathion methyl	7.86	4.91	7.77	3.41	Mepanipyrim	4.63	3.89	9.55	3.77	Coumaphos	5.15	6.18	7.79	4.18
Tolclofos-methyl	8.51	7.87	8.79	1.95	Hexaconazole	5.49	8.17	8.81	5.20	Pyridaben	6.42	3.16	7.25	1.59
Carbaryl	4.44	8.21	8.83	6.73	Imazalil	8.84	<u>5.09</u>	8.01	4.24	Cypermethrin-1	8.23	8.70	7.71	1.42
Heptachlor	7.92	3.29	8.59	4.05	Flutolanil	4.88	3.61	9.69	1.93	Boscalid	5.29	14.34	9.02	3.51
Metalaxyl	2.88	6.82	14.92	5.22	Prothiofos	9.31	4.77	10.21	4.80	Cypermethrin-2	8.68	5.80	8.49	7.71
Prometryn	4.48	5.90	8.83	7.87	Isoprothiolane	3.65	4.46	8.04	5.86	Cypermethrin-3	9.28	5.31	8.79	5.44
Pirimiphos-methyl	7.24	9.41	9.11	6.64	Dieldrin	9.55	8.16	9.39	6.59	Cypermethrin-4	4.59	12.36	2.67	7.80
Fenitrothion	9.87	6.55	5.77	7.20	Myclobutanil	4.80	5.72	9.55	2.11	Ethofenprox	4.72	7.17	7.04	3.51
Linuron	7.87	6.27	13.16	4.65	o,p'-DDD	5.51	3.71	11.30	3.02	Silafuofen	3.09	10.17	8.81	2.84
Malathion	9.97	7.47	7.37	2.98	Flusilazole	7.51	7.35	8.85	5.56	Fenvalerate-1	8.28	14.86	9.21	6.41
Metolachlor	3.77	3.78	12.20	4.78	Kresoxim-methyl	6.77	6.34	13.15	3.58	Fenvalerate-2	8.60	16.74	8.23	4.30
Chlorpyrifos	7.22	<u>3.28</u>	9.78	6.08	Chlorfenapyr	10.54	7.30	5.37	7.93	Difenoconazole-1	1.52	9.27	7.86	2.83
Thiobencarb	7.77	2.08	9.59	4.36	Isoxathion	9.10	7.85	12.21	9.12	Difenoconazole-2	5.84	9.25	7.16	7.27
Diethofencarb	5.44	4.17	12.25	6.75	Beta-endosulfan	8.66	8.25	12.65	4.06	Azoxystrobin	5.01	4.22	4.54	5.80
Fenthion	4.11	5.06	9.33	5.36	Ethion	5.81	4.81	9.01	4.22					
Parathion	7.43	8.93	9.05	5.05	Triazophos	6.42	4.64	8.64	2.63	Among Total of 458 Components*2				
Triadimefon	5.66	7.30	9.52	9.15	Edifenphos	7.40	6.61	9.89	7.70	Number of Components with 10 % or Lower Average %RSD (excluding N.D.)	440	406	334	438
Tetraconazole	9.01	8.56	9.70	6.59	Endosulfan sulfate	8.23	4.19	7.14	5.54		6.62	6.46	9.90	5.55
Dicofol degradation products	4.91	3.99	11.87	7.33	Quinoxifen	4.23	8.59	12.91	2.30					

Items determined to have 20 % or more overlap (area values) between pesticide-spiked and blank samples are underlined (reference data).
*2 Excludes the 19 internal standard substances.

First Edition: March, 2015



Application Data Sheet

No. 107

GC-MS

Gas Chromatograph Mass Spectrometer

Simultaneous Analysis of 477 Residual Pesticides in Agricultural Crops Using GC-MS/MS - Part 2

Application Data Sheet No. 106 showed that it is possible to simultaneously analyze 477 components with high sensitivity and high accuracy by using a measurement program created using Smart MRM. However, there were still cases where matrix interference was unavoidable even when using highly selective MRM analysis. Therefore, this Application Data Sheet presents results from analysis using two columns with different separation characteristics: a general-purpose 5 % phenyl / 95 % methylpolysiloxane column and a trifluoropropyl methyl polysiloxane column.

By using the Twin Line MS System, both of these columns can be installed in the same GC-MS/MS system at the same time for continuous analysis without having to release the vacuum or replace columns.

Experiment

Matrix solutions were prepared by processing soy bean, orange, brown rice, and spinach samples according to a pretreatment procedure for residual pesticide analysis, and then purifying them using the GPC Cleanup System (from Shimadzu Corporation).¹⁾ Measurement sample solutions (1 g/mL sample concentration) were then prepared by spiking the prepared matrix solutions with 477 components (including internal standard substances) to a concentration of 5 ppb (or 200 ppb for the internal standard substances). 19 kinds*¹ of surrogate pesticides were used as the internal standard substances.

The GCMS-TQ8040 combined with the Twin Line MS System was used to measure samples based on the analytical conditions listed in Table 1. Two transitions were specified for each component, one for quantitation and the other for confirmation, and Smart MRM was used to automatically create a measurement program.

Table 1: Analysis Conditions

GC-MS:	GCMS-TQ8040 (Twin Line MS System)		
Column 1:	SH-Rxi-5Sil MS (30 m L., 0.25 mm I.D., df=0.25 μm) (Shimadzu, P/N: 221-75954-30)		
Column 2:	SH-Rtx-200 MS (30 m L., 0.25 mm I.D., df=0.25 μm) (Shimadzu, P/N: 221-75811-30)		
Glass Insert :	Sky Liner, Splitless Single Taper Gooseneck w/Wool (Restek, P/N: 567366)		
[GC]		[MS]	
Injection Temp.:	250 °C	Interface Temp.:	300 °C
Column Oven Temp.:	60 °C (1 min) → (25 °C /min) → 160 °C → (4 °C /min) → 240 °C → (10 °C /min) → 290 °C (11 min)	Ion Source Temp.:	200 °C
Injection Mode:	Splitless	Measurement Mode:	MRM
High Pressure Injection:	250 kPa (1.5 min)	Loop Time:	0.4 sec
Carrier Gas Control:	Linear Velocity (40.0 cm/sec)	Processing Time Required:	0.3 min
Injection Volume:	2 μL		



Fig. 1: GCMS-TQ8040 with Twin Line MS System

Analysis Results

Results from analysis using columns 1 and 2 are shown in Figs. 2 and 3. Due to matrix interference, some pesticide peaks cannot be detected properly with column 1, but using column 2 allows separation of the matrix and results in accurate detection. Furthermore, high-precision analytical results can be obtained even when using column 2.

If a peak is detected in data from column 1, then the data from column 2 can be used to confirm that the peak is from a pesticide.

1) E. Ueno, et al., *J. AOAC INT.* **87**, (2004) 1003-1015

*1 Dichlorvos-*d*₆, acephate-*d*₆, diazinon-*d*₁₀, iprobenfos-*d*₇, carbaryl-*d*₇, fenitrothion-*d*₆, linuron-*d*₆, metolachlor-*d*₆, chlorpyrifos-*d*₁₀, diethofencarb-*d*₇, fosthiazate-*d*₅, pendimethalin-*d*₅, thiabendazole-¹³C₆, imazalil-*d*₅, isoprothiolane-*d*₄, isoxathion-*d*₁₀, EPN-*d*₅, etofenprox-*d*₅, and esfenvalerate-*d*₇

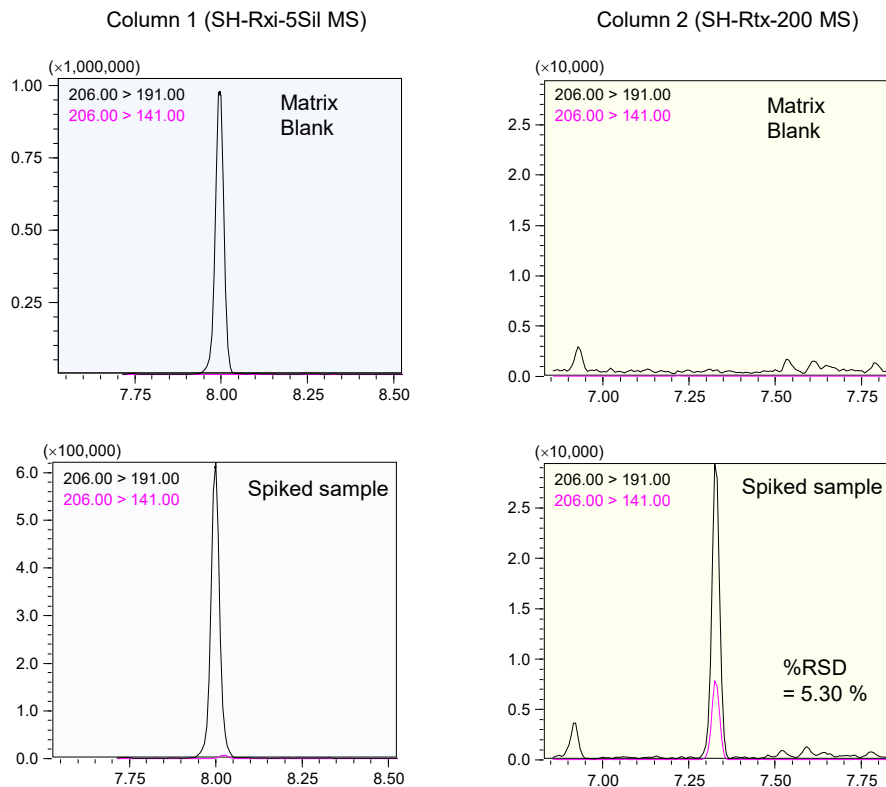

Fig. 2: MRM Chromatograms of Chloroneb in a Soy Bean Sample Using Column 1 (left) and Column 2 (right)

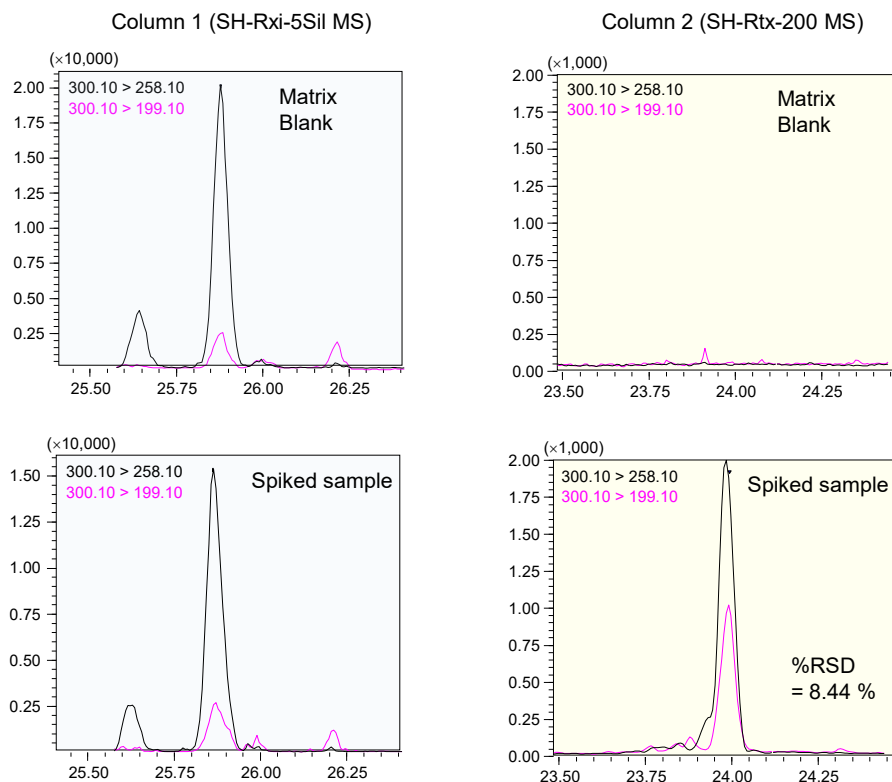

Fig. 3: MRM Chromatograms of Bifenazate in a Brown Rice Sample Using Column 1 (left) and Column 2 (right)

First Edition: March, 2015



Application News

No. J114A

Inductively Coupled Plasma Atomic Emission Spectrometry

Analysis of Additive Elements, Wear Metals, and Contaminants in Used Lubricating Oil According to ASTM D5185: ICPE-9820

■ Introduction

Analysis of lubricants added to engine oils such as those used in automobiles and ships is an effective as well as important way to diagnose the state of the engine and other equipment.

According to ASTM International Standard D5185 ¹⁾, inductively coupled plasma (ICP) atomic emission spectrometry with organic solvent dilution is specified for measurement of additive elements, wear metals and contaminants present in used lubricants. Also, the Japan Petroleum Institute standard JPI-5S-44-2011 stipulates the use of ICP atomic emission spectrometry in Japan for analysis of Fe, Cu, Al, Pb, Cr and Sn in used lubricating oil.²⁾ Here, using the Shimadzu ICPE-9820 multi-type ICP atomic emission spectrometer, we conducted analysis of 22 elements specified according to ASTM D5185 in samples consisting of a used lubricant (commercially available automotive lubricating oil) and, as a reference, the same, but unused lubricating oil, both of which were diluted with organic solvent. The ICPE-9820, which adopts a vertically-oriented plasma torch which reduces the possibility of carbon precipitation, provides stable analytical results for organic solvent samples without requiring the flow of oxygen through the system.

■ Samples

- Used lubricating oil (commercially available automotive lubricant, used for approximately 4000 km)
- Same lubricating oil as above, but in unused state

■ Sample Preparation

Approximately 10 g of each sample was weighed and then diluted with 100 mL of kerosene. The standard solutions were prepared by appropriately diluting with kerosene the SPEX oil-based 21-element mixed standard solution (500 µg/g), the Conostan[®] and SPEX oil-based single-element standard solution (5000 µg/g), and the Tokyo Kasei Kogyo Co., Ltd. heavy oil sulfur content standard sample (1.05 % by weight).

For validation of the measurement values, the above standard solution was added to the used lubricating oil to prepare a 5 mg/L solution to serve as a low-concentration element spike-and-recovery test sample. In addition, for high-concentration elements, the used lubricant was diluted 50-fold with kerosene to prepare a diluted test sample.

Finally, the Conostan[®] oil-based Y (yttrium) single-element standard solution (5000 µg/g) was diluted with kerosene and added to all the samples as the internal standard element so as to occupy a fixed concentration in all the samples.

■ Instrument and Analytical Condition

Measurement was conducted using the Shimadzu ICPE-9820 multi-type ICP atomic emission spectrometer. The measurement conditions are shown in Table 1.

When conducting analysis of organic solvent samples with most conventional ICP instruments, oxygen must typically be introduced into the plasma torch to suppress

carbon deposition at the tip of the torch. With the Shimadzu ICPE-9820, however, the vertical orientation of the plasma torch and adoption of a plasma torch that suppresses carbon deposition has nearly completely eliminated the deposition of carbon originating from the sample. Therefore, even in analysis of organic solvent samples such as kerosene, xylene and MIBK, the ICPE-9820 eliminates the need to introduce oxygen to suppress the precipitation of carbon.

Also, since the Shimadzu ICPE-9820 adopts a vacuum spectrometer, elements such as S with a wavelength in the vacuum ultraviolet region can be analyzed at a low running cost without the need for costly high-purity gas, typically required with a purge-type spectrometer.

Table 1 Analytical Conditions

Instrument	: ICPE-9820
Radio Frequency Power	: 1.40 kW
Plasma Gas Flowrate	: 16.0 L/min
Auxiliary Gas Flowrate	: 1.40 L/min
Carrier Gas Flowrate	: 0.70 L/min
Sample Introduction	: Nebulizer, 10UES
Misting Chamber	: Organic solvent chamber
Plasma Torch	: Torch
Observation	: Radial (RD)

■ Analysis

The calibration curve method – internal standard method was used to conduct analysis of 22 elements (Al, Ba, B, Ca, Cr, Cu, Fe, Pb, Mg, Mn, Mo, Ni, P, K, Si, Ag, Na, S, Sn, Ti, V, Zn) specified according to the ASTM standard.

■ Analytical Results

Table 2 shows the analytical results. Excellent results near 100 % were obtained in the dilution test for the high-concentration elements and the spike-and-recovery test for the low-concentration elements, both with respect to the used lubricating oil. In addition, the analytical results obtained in analysis of the unused lubricating oil are also listed for reference.

The spectral line profiles for Fe and P are shown in Fig. 1. The calibration curves for Fe, Mg and S are shown in Fig. 2.

■ Conclusion

Using the ICPE-9820, dissolved elements in used lubricating oil can be analyzed stably without the introduction of oxygen.

■ References

- 1) ASTM International Standard D5185
Standard Test Method for Determination of Additive Elements, Wear Metals, and Contaminants in Used Lubricating Oils and Determination of Selected Elements in Base Oils by Inductively Coupled Plasma Atomic Emission Spectrometry (ICP-AES)
- 2) The Japan Petroleum Institute Standard JPI-5S-44-2011
Method for Analyzing Fe, Cu, Al, Pb, Cr and Sn Contents in Used Lubricating Oil Using Solvent Dilution - Inductively Coupled Plasma Atomic Emission Spectrometry

Table 2 Analytical Results of Lubricating Oil

Element	Used lubricant (µg/g)	Used lubricant spike recovery rate (%)	Used lubricant dilution test (%)	Unused lubricant (µg/g)	Detection limit (µg/g)
Ag	<	100	-	<	0.02
Al	10	101	-	6.51	0.3
B	65.9	-	98	121	-
Ba	0.123	101	-	<	0.02
Ca	3970	-	98	2250	-
Cr	1.03	101	-	<	0.01
Cu	0.65	100	-	<	0.02
Fe	10.8	101	-	0.43	0.01
K	22.1	99	-	<	0.6
Mg	10.4	100	-	5.48	0.02
Mn	0.618	101	-	0.139	0.002
Mo	184	-	98	183	-
Na	2.5	100	-	<	0.4
Ni	<	102	-	<	0.05
P	756	-	99	731	-
Pb	<	100	-	<	0.5
S	3980	-	100	3810	-
Si	8.96	103	-	5.07	0.03
Sn	<	100	-	<	0.5
Ti	<	100	-	<	0.01
V	<	103	-	<	0.02
Zn	872	-	97	882	-

Spike recovery rate (%) = (C1-C2)/B×100 (C1: Spiked sample quantitative value; C2: Non-spiked sample quantitative value; B: Spike concentration)

Dilution test (%) = I/S ×100 (I: Quantitative value of sample before dilution; S: Quantitative value of 5-fold diluted sample ×5)

Detection limit: DL = 3×σ_{BL} × κ (σ_{BL}: Standard deviation of background intensity; κ: Concentration/intensity)
<: Less than the detection limit

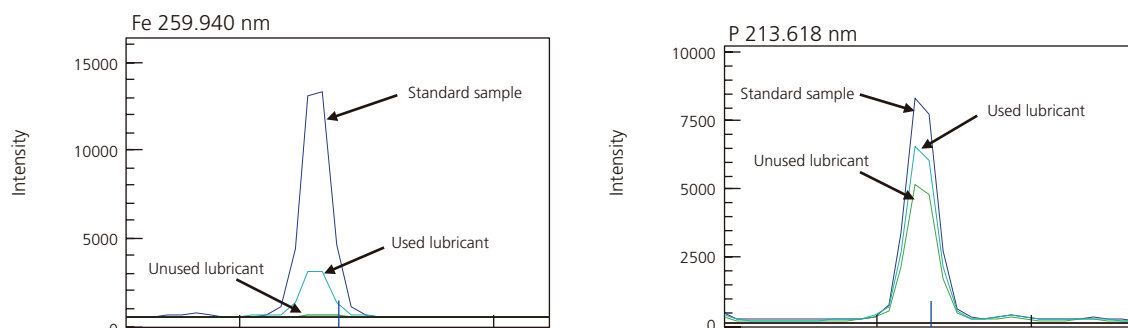

Fig. 1 Spectral Profiles of Fe and P

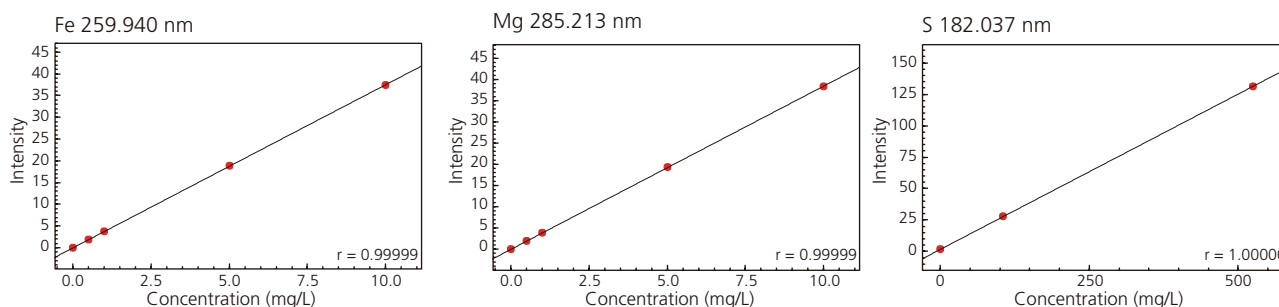

Fig. 2 Calibration Curves of Fe, Mg and S

Second Edition: Jul. 2015
First Edition: Apr. 2015



Application News

No. A524

Spectrophotometric Analysis

Differentiating Olive Oils Using UV-VIS Spectrophotometer and Spectrofluorophotometer

Introduction

There is growing interest in food safety and organic foods, with an increasing number of shops specializing in a variety of food products and increasing circulation of high price import goods. One of these foods is olive oil, which is supposed to have both health and aesthetic benefits. The most expensive form of olive oil is extra virgin olive oil, which is regulated by the International Olive Council. Only olive oil that is chemically unprocessed, produced by squeezing and filtering olive fruit, and with an acidity of no more than 0.8 % qualifies as extra virgin olive oil. Another olive oil called pure olive oil is created by purification and high-temperature treatment. Differentiating between extra virgin olive oil and pure olive oil based on appearance alone is difficult. This article describes an attempt to differentiate between these two olive oil types by spectrum measurement using Shimadzu UV-2700 UV-VIS spectrophotometer and RF-6000 spectrofluorophotometer, then performing multivariate analysis.

Absorbance Measurement of Olive Oils

Fig. 1 shows Shimadzu UV-2700 that was used to measure absorbance. Fig. 2 shows some of the olive oils tested. They each differ in terms of color, odor, and place of origin. Ten different extra virgin olive oils were prepared from a total of 6 producers. Samples were named in the format "○ × E", where "○" was replaced by letters A through F to refer to each producer, and "×" was replaced by each producer's consecutive numbers in order of increasing olive oil price. Pure olive oil was also prepared from producers A and B. These samples were named in the format "○ × P". Each olive oil was placed in a quartz cell, then its absorption spectrum was measured. Measurement conditions are shown in Table 1, and three spectra representative of the spectra obtained are shown in Fig. 3. Absorption peak wavelengths are almost identical between spectra, though with obvious differences in their degree of absorption. Results confirmed the extra virgin olive oils tended to exhibit higher absorbance than the pure olive oils.



Fig. 1 UV-2700 UV-VIS Spectrophotometer

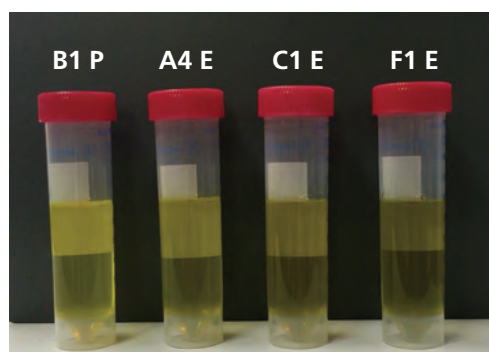

Fig. 2 Various Olive Oils

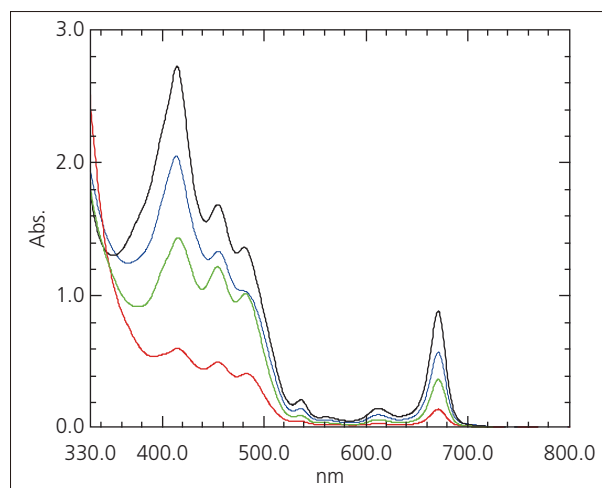

Fig. 3 Olive Oil Absorption Spectra
Red: B1 P, Green: A4 E, Blue: C1 E, Black: F1 E

Table 1 UV-2700 Measurement Conditions

Spectrum Type	: Absorption spectrum
Measurement Wavelength Range	: 330 nm to 800 nm
Scanning Speed	: Intermediate
Sampling Pitch	: 0.5 nm
Light Source Switching Wavelength	: 323 nm

Multivariate Analysis Using Absorption Spectra

We attempted to differentiate between pure olive oil and extra virgin olive oil by performing a multivariate analysis of the results obtained by absorbance measurement. The Unscrambler[®]X¹⁾ multivariate analysis software was used to perform difference analysis on absorbance at 7 peak wavelengths.

Principal component analysis (PCA) and cluster analysis were used to differentiate between olive oil types. With PCA, scores are calculated to allow visual differentiation by the analyst (score plot). A loading plot is also used to determine characteristic factors in each grouping that have a strong influence on the score plot. Cluster analysis differentiates samples based on a tree diagram. The shorter the horizontal line that connects each sample, the more similar those samples.

The score plot obtained by PCA is shown in Fig. 4. Pure olive oils are clustered in the negative direction along the dominant PC-1 axis, while extra virgin olive oils are clustered in the positive direction along the dominant PC-1 axis. This shows successful differentiation between olive oil types. The loading plot in Fig. 5 shows a characteristic of the extra virgin olive oils tested is strong signals at short wavelengths, such as 415 nm and 454.5 nm.

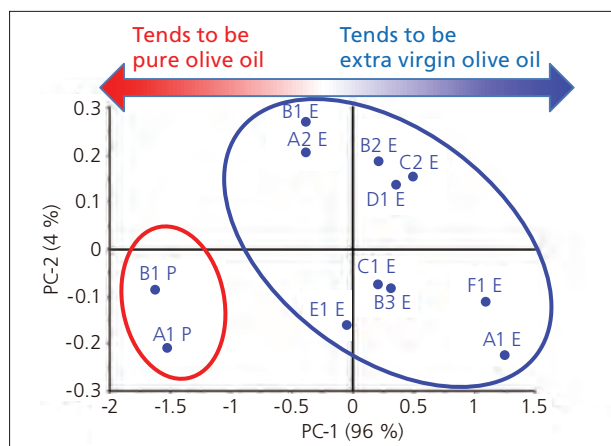

Fig. 4 Score Plot Based on Olive Oil Absorbance

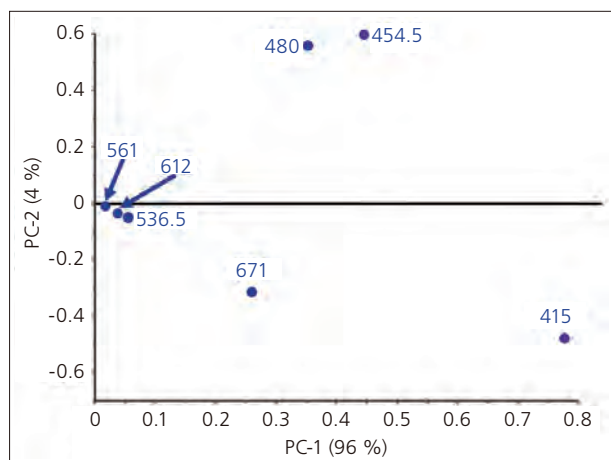

Fig. 5 Loading Plot Based on Olive Oil Absorbance

Cluster analysis results are shown in Fig. 6. At a glance, the tree diagram shows the olive oils separated into 2 groups and the degree of similarity between the samples. This result shows we successfully differentiated between pure olive oils and extra virgin olive oils.

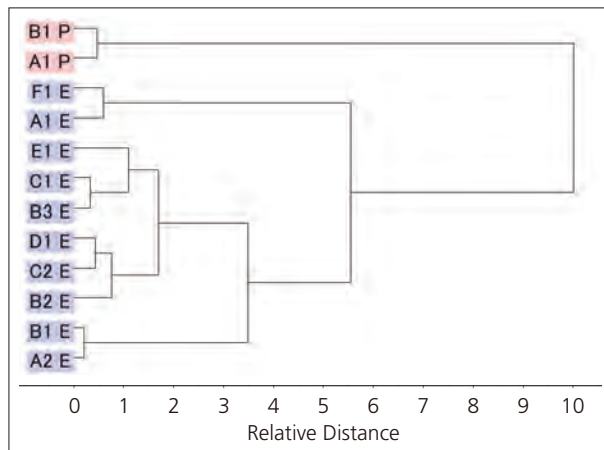

Fig. 6 Cluster Analysis Result Based on Olive Oil Absorbance

Three-Dimensional Spectra Measurements of Olive Oils

The three-dimensional emission spectra of olive oils were measured using Shimadzu RF-6000 spectrofluorophotometer. Fig. 7 shows the instrument used. Due to the high absorbance exhibited by the samples, a solid sample holder (Fig. 8) was used to compensate for self-absorption effects. Self-absorption is the phenomenon of light emitted by the sample being absorbed by the sample itself. When the absorption spectrum of a highly absorbing sample is measured in a normal cell holder, the amount of emission light that enters the detector can be reduced due to emission light being absorbed by the sample itself. A solid sample holder was used to direct excitation light towards the corner of the quartz cell as shown in Fig. 9. This reduces the amount of sample through which emission light travels, and so reduces the effects of self-absorption.

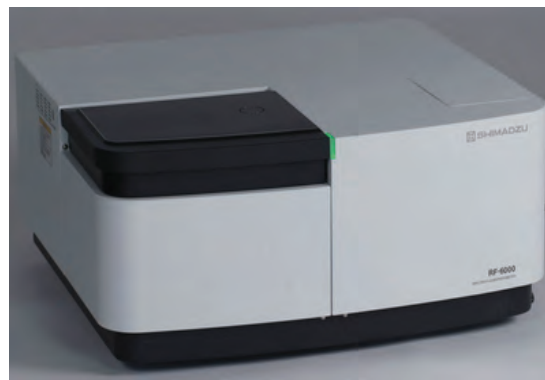

Fig. 7 RF-6000 Spectrofluorophotometer

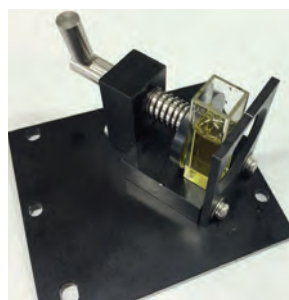

Fig. 8 Solid Sample Holder

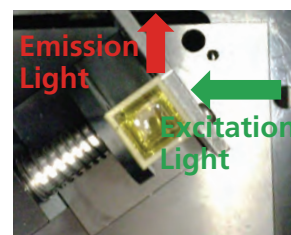

Fig. 9 Measurement Method

Table 2 shows the measurement conditions used. A filter (IHU310) that blocks light below 310 nm was placed in the path of emission light to prevent high-order excitation light reaching the detector. Fig. 10 shows two of the three-dimensional spectral diagrams obtained. Emission light predicted to be derived from chlorophyll was confirmed at Em 680 nm in both samples. Emission light at this wavelength was detected more strongly from extra virgin olive oil samples compared to pure olive oil samples. Also, strong emission light in the vicinity of Em 400 nm was mainly detected from pure olive oil samples. This 400 nm emission light is predicted to be derived from vitamins.

Fig. 11 compares a pure olive oil and an extra virgin olive oil showing emission spectra obtained at an excitation wavelength of 300 nm. The excitation light region shown in Fig. 11 is indicated by the white dotted lines in Fig. 10. The emission spectra show different peak strengths and peak tail shapes between 300 nm and 500 nm.

Table 2 RF-6000 Measurement Conditions

Optional Accessory	: Solid sample holder, IHU310
Spectrum Type	: 3D spectrum
Measurement Wavelength Range	: Ex 200 nm to 800 nm Em 250 nm to 800 nm
Scanning Speed	: 6000 nm/min
Wavelength Interval	: Ex 5.0 nm, Em 1.0 nm
Bandwidth	: Ex 5.0 nm, Em 5.0 nm
Sensitivity	: Low

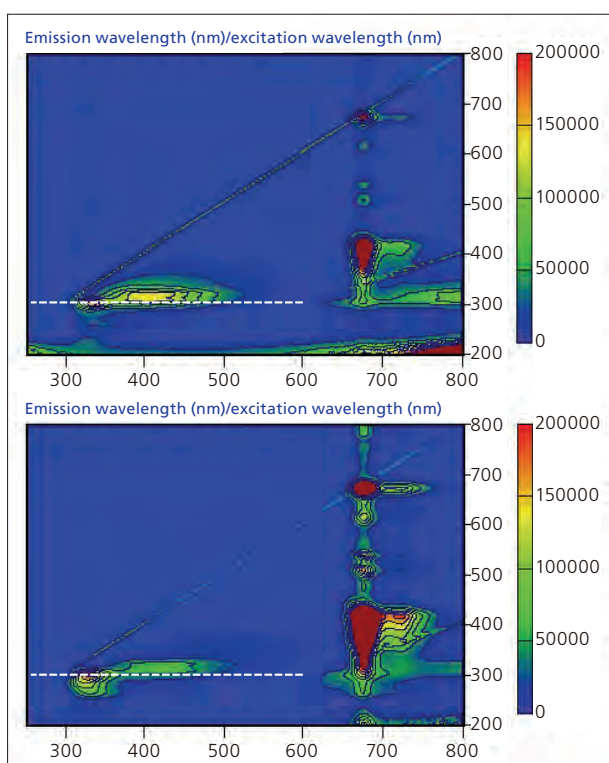

Fig. 10 Three-Dimensional Spectra of Olive Oils
Top: A1 P, Bottom: F1 E

■ **Multivariate Analysis Based on Three-Dimensional Spectra**

Similar to absorbance analysis, a multivariate analysis was performed on the three-dimensional spectra to differentiate between pure olive oils and extra virgin olive oils. Emission light intensity at the 10 points shown in Fig. 12 (A through J) was used for this analysis.

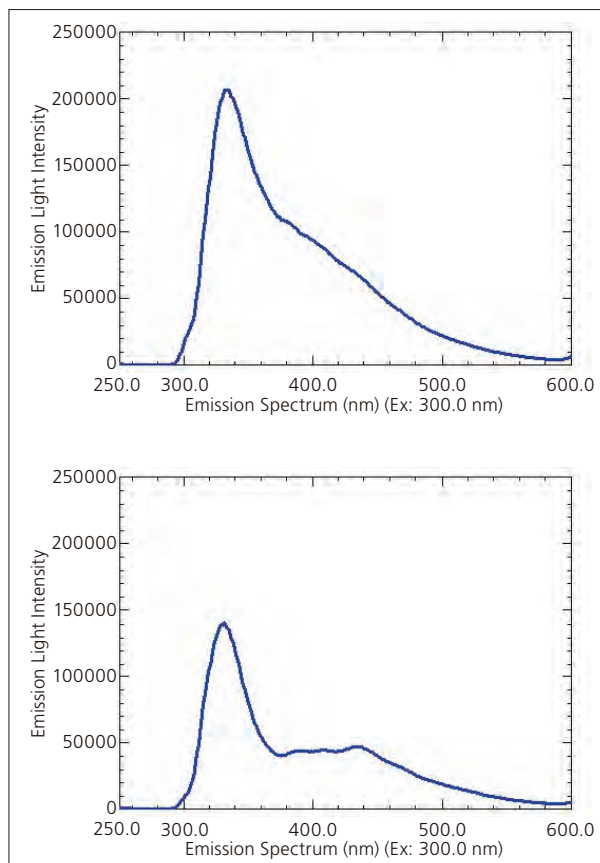

Fig. 11 Emission Spectrum of Olive Oils Excited at 300 nm
Top: A1 P, Bottom: F1 E

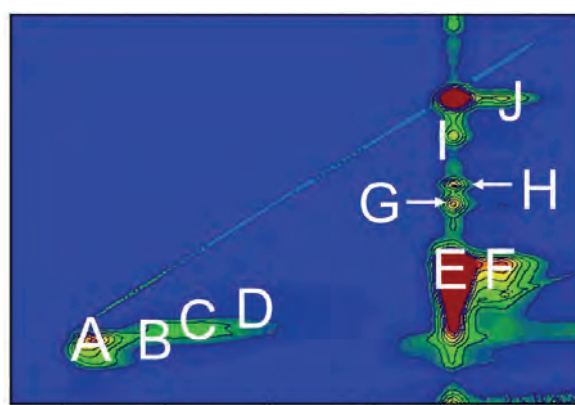

Fig. 12 Analysis Points for Multivariate Analysis

The score plot obtained by PCA is shown in Fig. 13. Pure olive oils are clustered in the positive direction along the dominant PC-1 axis and extra virgin olive oils are clustered in the negative direction along the dominant PC-1 axis. This shows the olive oil types have been separated.

Compared to the score plot created based on absorbance, the A2 E and B1 E samples are positioned closer to the pure olive oil samples. While A2 E and B1 E are both extra virgin olive oils, we can predict they are similar to pure olive oils. The loading plot is shown in Fig. 14. It shows a characteristic of the pure olive oils is for strong signals at emission light analysis points A through D, which are points predicted to be derived from vitamins.

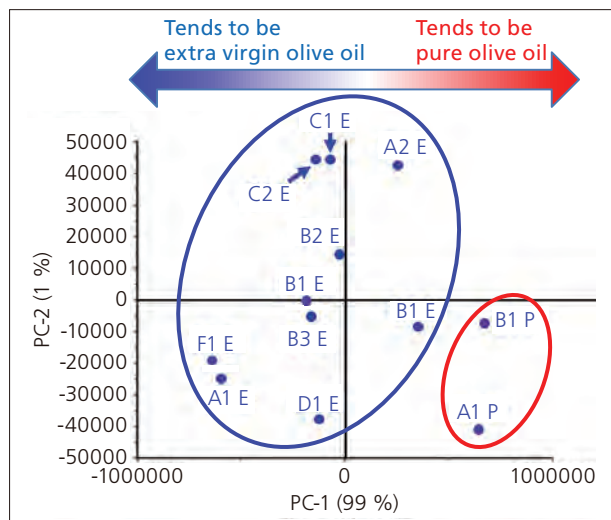

Fig. 13 Score Plot Based on Olive Oil Absorbance

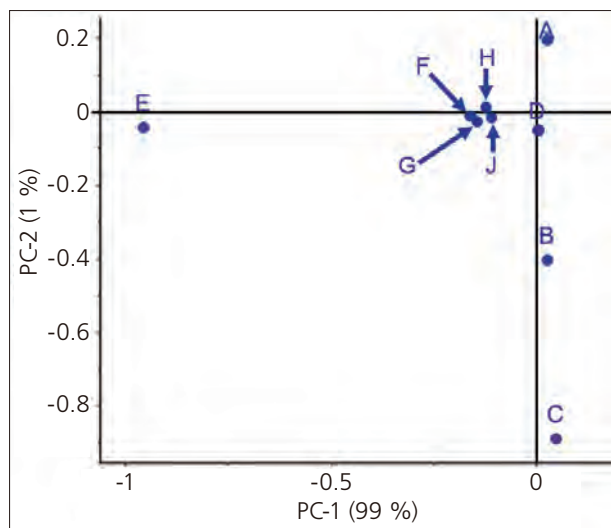

Fig. 14 Loading Plot Based on Olive Oil Absorbance

Results of the cluster analysis are shown in Fig. 15. Compared to the results obtained based on absorbance, the A2 E and B1 E samples are included in the pure olive oil group. This result also shows that while these samples are extra virgin olive oils, they tend to be closer to pure olive oils. Using emission light spectra, we could predict which extra virgin olive oils are likely to contain more vitamins.

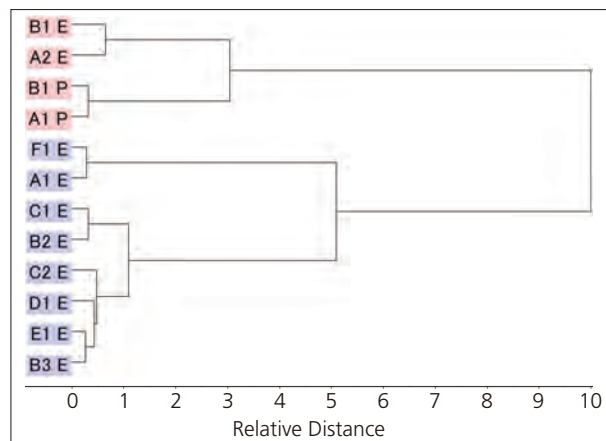

Fig. 15 Cluster Analysis Result Based on Olive Oil Absorbance

Conclusion

Shimadzu UV-2700 UV-VIS spectrophotometer was used to measure absorption spectra. Results showed the extra virgin olive oils have a higher absorbance than the pure olive oils. Next, the three-dimensional emission spectra of olive oils were measured using Shimadzu RF-6000 spectrofluorophotometer. Differences in emission light intensity and peak width were confirmed in the three-dimensional emission spectra results. Multivariate analysis was then performed based on each spectrum. This allowed successful differentiation between the extra virgin olive oils and pure olive oils, while results obtained from the RF-6000 allowed identification of extra virgin olive oils particularly similar to pure olive oils.

<Acknowledgments>

We are grateful to Kazumi Hashimoto of the Polymer Photonics Laboratory, Master's Program of Innovative Materials, Graduate School of Science and Technology, Kyoto Institute of Technology for providing assistance in performing these measurements.

- 1) The Unscrambler®X is a trademark or registered trademark of CAMO Software.

Application News

No. A543

Spectrophotometric Analysis

Analysis of Food Contaminants Using KBr Cuttings: KBr Plates for KBr Pellet Formation

The KBr pellet method is a technique mainly used to measure solid samples. This method exploits the plasticity of alkali halides that form a transparent plate when subjected to pressure. While potassium bromide (KBr) is the most common alkali halide used in pellet formation, potassium chloride (KCl) and cesium iodide (CsI) may also be used. Conventionally, pellets were formed by pulverizing KBr and the measurement sample each with an agate mortar, mixing the two to an appropriate concentration, and then applying pressure. However, compared to its crystallized state, crushed KBr readily absorbs moisture and there is also a risk of contamination from the mortar. Furthermore, press-forming work was a burden to analysts and preparing concentrations also took time.

By using KBr Cuttings, the onerous tasks of pulverizing KBr and mixing it with samples using an agate mortar are no longer required. KBr Cuttings are plates of cut KBr crystals. Good quality KBr disks can be produced by simply setting the sample for measurement between two KBr plates, placing the combination into a pelletizer, and applying pressure. When using KBr Cuttings, FTIR measurement is done using the transmittance mode. In this mode, the detector receives a greater amount of light compared to that with the reflectance mode and the ATR method, and therefore features measurement with good sensitivity. In Application News No. A536, we introduced the procedure for using KBr Cuttings and an example analysis of pharmaceutical identification testing.^{*1} In this article we introduce an example analysis of food contaminants using KBr Cuttings.

R. Fuji

■ KBr Cuttings Used

Material: KBr

Shape: 3 × 3 × 0.75 mm



Fig. 1 KBr Cuttings

Fig. 1 shows a photo of KBr Cuttings. The shape of KBr Cuttings is either 3 × 3 × 0.75 mm or 5 × 5 × 1 mm.

■ Analysis of Food Contaminants

Using KBr Cuttings, we measured a black contaminant which was caught in a mesh from filtering inspection, a quality inspection process. Fig. 2 shows the stereo microscope image of the contaminant. The IRTracer-100 Fourier transform infrared spectrophotometer and AIM-9000 infrared microscope, indicated in Fig. 3, were used for measurement. In measurement with an infrared microscope, usage of KBr Cuttings suppresses baseline distortions which occur due to scattering of light at the sample surface as well as interference fringes which may occur when measuring thin samples with a flat and smooth surface. Fig. 4 shows the KBr disk set for measurement. Since the formed KBr disk is the same size as the hole on the sample stage of AIM-9000, the disk can be fixed in place just simply by placing it. Table 1 lists the analysis conditions and Fig. 5 shows the measurement result.

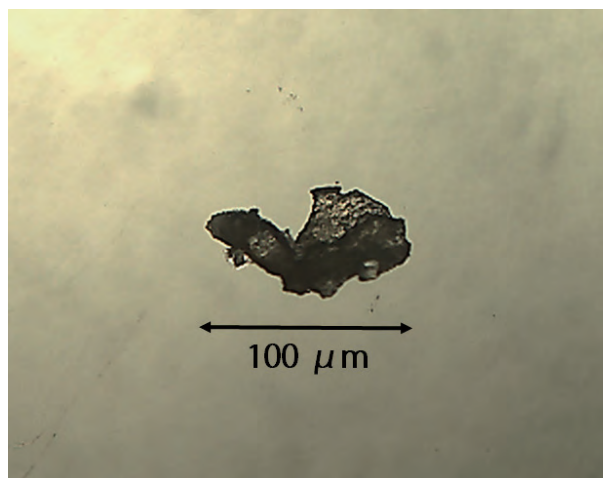

Fig. 2 Stereo Microscope Image of Contaminant



Fig. 3 IRTracer-100 Fourier Transform Infrared Spectrophotometer and AIM-9000 Infrared Microscope

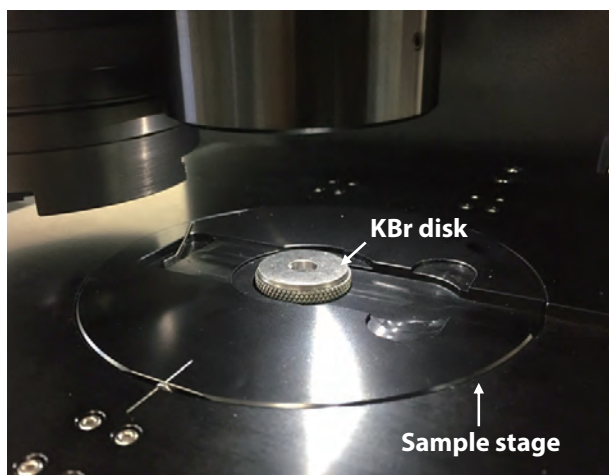

Fig. 4 KBr Disk Set for Measurement

Table 1 Measurement Conditions

Instrument	: IRTracer-100, AIM-9000
Resolution	: 8 cm ⁻¹
Accumulation	: 40 times
Apodization function	: Happ-Genzel
Detector	: MCT
Aperture size	: 100 μm × 100 μm

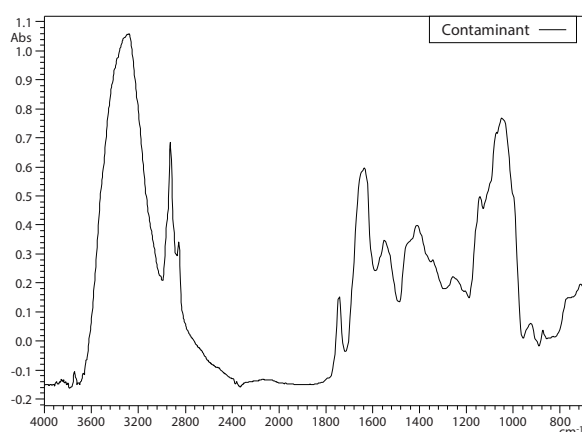

Fig. 5 Measurement Result

The measurement result shown in Fig. 5 indicates a large peak in the vicinity of 3200 cm⁻¹ caused by O-H bonds originating from water. Other detected peaks include a peak from C-H bonds near 2800 cm⁻¹, a peak from C=O bonds which are frequently found in foods containing oil near 1750 cm⁻¹, and a peak from amide bonds originating from protein in the range of 1650 to 1550 cm⁻¹.

■ Analysis of Measurement Result

Contaminant analysis was done using the standard library which contains 12,000 entries. Fig. 6 shows the analysis results.

Based on the library search, the contaminant was found to be a mixture of oil, protein and starch. Since all components are generally included in foods, we can presume that the contaminant is a part of a food.

In analysis of food contaminants, it is often the case that the found contaminant is a part of the food, or food components are attached to the contaminant.

In the latter case, there are times when measurement and analysis are required again after measuring the contaminant and then dissolving the food components such as with water. (The first measurement must be done since the contaminant may also dissolve through pretreatments.) In order to obtain more accurate qualitative results in contaminant analysis, information such as where the contaminant was found and the appearance of the contaminant observed with an optical microscope are also important.

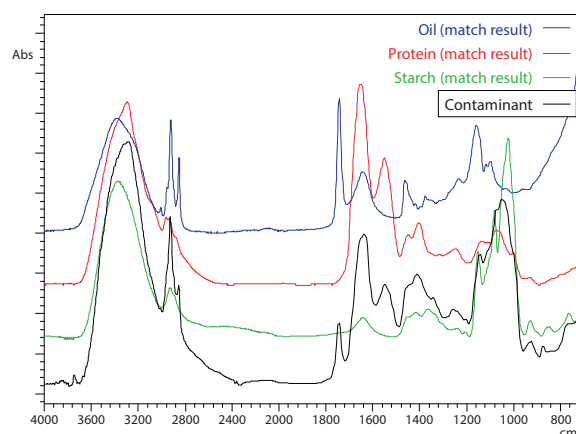

Fig. 6 Analysis Results

■ Conclusion

We introduced an example analysis of food contaminants using KBr Cuttings. Unlike the conventional KBr pellet method, measurement can be done easily and simply. Also, in addition to measurement with an infrared microscope, KBr disks can be used for the transmittance mode on FTIR instruments. We hope this method will be useful in measurements for contaminant analysis.

References:

- *1 Application News No.A536 "Introduction to KBr Cuttings: Convenient KBr Plates for KBr Pellet Formation"

Sensitive multi-mycotoxins analysis with a single sample preparation by LC-MS/MS

ASMS 2018 MP 266

Eishi IMOTO¹, Naoki MOCHIZUKI², Jun WATANABE¹
1 Shimadzu Corporation, MS Business Unit, Kyoto, Japan.
2 Yokohama University Pharmacy, Kanagawa, Japan.

Sensitive multi-mycotoxins analysis with a single sample preparation by LC-MS/MS

Introduction

There are various substances that can threaten the food safety, such as pesticides, mycotoxins. LC-MS/MS analysis is a prevailing technique for the detection of these substances in food. Mycotoxins are especially frequent contaminants of agricultural products, and brewers are concerned that they can give serious damages to consumers, for example liver cancer, nephritis, pulmonary edema and so on. This is the reason why most countries have adopted regulations to limit exposure to mycotoxins, while the regulated mycotoxins and value differ with

countries. The toxicity and potential health hazards induced by mycotoxins demand the need for sensitive, robust analytical methodologies. This research provides a LC-MS/MS system for quantitative screening of mycotoxins and includes a multi-mycotoxin sample preparation column to cover worldwide regulations. Although LC-MS/MS is a highly sensitive analytical technique, the problem of carryover occurs frequently. Metal-free column and multi-rinse mode were performed for reduction of carryover.



Fig 1. LC-MS/MS system (Nexera X2+LCMS-8060, Shimadzu Corporation.)

Methods and Pretreatment

19 mycotoxins (Nivalenol, Patulin, Doxynivalenol-3-Glucoside, Deoxynivalenol, Fusarenon-X, Neosoraniol, 3-Acetyl-Deoxynivalenol, 15-Acetyl-Deoxynivalenol, Aflatoxin B1, B2, G1, G2, Diacetoxyscirpenol, Fumonisin B1, B2, B3, T-2 toxin, Ochratoxin A, Zearalenone) were used for evaluation of matrix effect and recovery rates in wheat. These mycotoxins were diluted with ACN at 5 ng/mL. Ground

wheat flour samples were mixed with water/acetonitrile. After filtration, extracts were diluted with aqueous acetic acid solution and mixed with mycotoxins at 5 ng/mL. The solution were loaded to into the spin purification column (Mycospin™400, Romer Lab) and analyzed using a triple quadrupole mass spectrometer (LCMS-8060, Shimadzu Corp.).

Sensitive multi-mycotoxins analysis with a single sample preparation by LC-MS/MS

Table 1. LC and MS conditions

[LC] Nexera™ X2 System																							
Analytical Column	: Mastro™ PFP2 (Shimadzu GLC Ltd) 2.1 mmI.D.x150 mmL., 3 μm																						
Solvent A	: 10 mmol/L ammonium acetate																						
Solvent B	: 2% acetic acid in methanol																						
Gradient Program	: <table border="1" style="margin-left: 20px;"> <thead> <tr> <th>Time (min)</th> <th>%B</th> </tr> </thead> <tbody> <tr><td>1.00</td><td>40</td></tr> <tr><td>1.50</td><td>40</td></tr> <tr><td>1.51</td><td>50</td></tr> <tr><td>5.50</td><td>50</td></tr> <tr><td>5.51</td><td>65</td></tr> <tr><td>9.50</td><td>70</td></tr> <tr><td>9.51</td><td>95</td></tr> <tr><td>13.00</td><td>95</td></tr> <tr><td>13.01</td><td>20</td></tr> <tr><td>15.00</td><td>STOP</td></tr> </tbody> </table>	Time (min)	%B	1.00	40	1.50	40	1.51	50	5.50	50	5.51	65	9.50	70	9.51	95	13.00	95	13.01	20	15.00	STOP
Time (min)	%B																						
1.00	40																						
1.50	40																						
1.51	50																						
5.50	50																						
5.51	65																						
9.50	70																						
9.51	95																						
13.00	95																						
13.01	20																						
15.00	STOP																						
Flow Rate	: 0.4 mL/min																						
Column Temp	: 40 °C																						
[MS] LCMS-8060																							
Ionization	: ESI (Positive/Negative)																						
Nebulizer Gas	: 2 L/min																						
Interface temperature	: 300 °C																						
Desolvation Line	: 250 °C																						
Heat Block temperature	: 500 °C																						
Heating Gas	: 10 L/min																						
Drying Gas	: 10 L/min																						

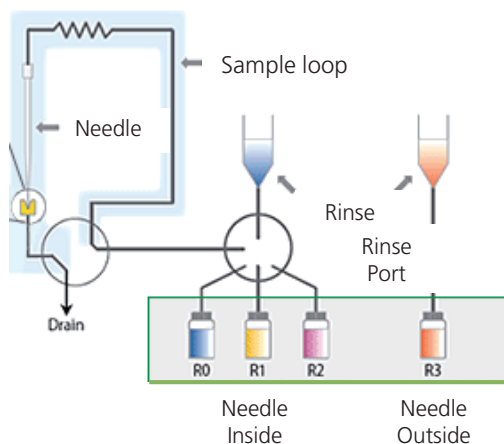

< Rinse Program >

R0	10 mmol/L ammonium acetate
R1	10 mmol/L sodium citrate
R2, R3	1% Formic acid + water/MeOH/ACN/PA= 1/1/1/1 (v/v)

Sensitive multi-mycotoxins analysis with a single sample preparation by LC-MS/MS

Table 2. MRM transitions for mycotoxins

☐ :Positive ☐ :Negative

No.	Mycotoxins	RT (min)	Polarity	transition	CE
1	NIV	1.88	-	371.10>281.10	16
2	PAT	2.22	-	153.00>109.00	11
3	D3G	2.30	-	517.20>427.20	21
4	DON	2.40	-	355.10>265.10	15
5	FUX	2.94	-	413.10>353.10	9
6	NEO	3.05	+	400.20>305.10	-12
7	15-ADON	3.74	+	339.10>261.10	-11
8	3-ADON	3.86	+	339.10>231.10	-14
9	AF G2	4.87	+	331.10>245.10	-31
10	AF G1	5.55	+	329.10>243.10	-30
11	DAS	5.78	+	384.20>307.10	-13
12	AF B2	6.22	+	315.10>259.10	-30
13	AF B1	6.96	+	313.10>241.10	-39
14	FB1	7.37	+	722.40>334.10	-43
15	FB3	8.08	+	706.40>336.10	-38
16	T-2	8.71	+	484.30>185.10	-20
17	FB2	8.97	+	706.40>336.10	-39
18	OTA	9.73	+	404.10>239.10	-24
19	ZEN	10.8	-	317.10>130.10	35

Details of sample preparation

1. Mix a ground wheat flour sample (50.0 g) with 100.0 mL of water/acetonitrile (15/85), and shake for 30 minutes



2. Filter the supernatant using glass-fiber filter paper (pore size < 0.7 um)

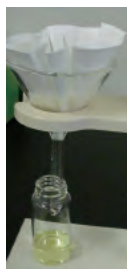

3. Add 500.0 µL of acetic acid to the filtrate (10.0 mL): Solution A



4. Load 1.0 mL of Solution A into the spin purification column and mix using vortex mixer for 1 minute while capped



5. Remove the bottom tip of the column and centrifugation for 2 minutes at 10,000 rpm



6. Transfer the supernatant into a vial then serve to the sample



Sensitive multi-mycotoxins analysis with a single sample preparation by LC-MS/MS

Results

Typical MS chromatogram for mycotoxins in ACN are shown in Fig. 2. An LC-MS/MS method was developed that achieved good separation and sensitivity for the detection of all mycotoxins without separating method for its polarity. Autosampler rinsing capabilities and metal free column were used to minimize the carryover of the fumonisins. Matrix effect was calculated by the peak area of mycotoxins (5 ng/mL) in ACN and post spiked samples.

Recovery rate was calculated by the peak area of post spiked samples (5 ng/mL) and pre spiked samples (5 ng/mL) which is shown in Table 3. NIV, DON, AF B1, T-2, ZEN were influenced wheat extractions which dramatically decrease the ionization efficiency of the mycotoxins. Recovery rate of the NIV, D3G, DON, T-2, ZEN were also insufficient. Therefore, internal standards are required for achieving accurate quantitative results.

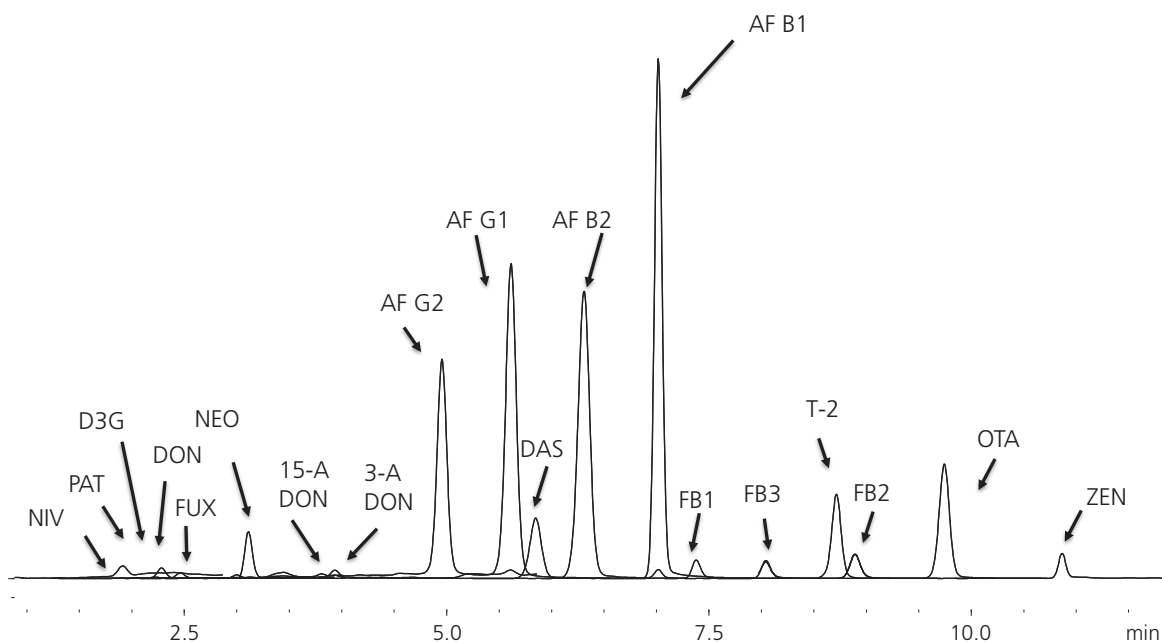

Fig 2. Typical MS chromatogram for mycotoxins mixture (50 ppb)

Table 3. Matrix effect and recovery rate of the mycotoxins in wheat matrix (5 ppb)

No.	Mycotoxins	Matrix Effect (%)	Recovery Rate (%)
1	NIV	35.0	156.6
2	PAT	71.6	115.8
3	D3G	34.4	166.8
4	DON	47.3	143.9
5	FUX	81.8	99.3
6	NEO	74.2	95.1
7	15-ADON	72.6	87.7
8	3-ADON	87.6	78.6
9	AF G2	78.3	70.7
10	AF G1	85.6	65.5

No.	Mycotoxins	Matrix Effect (%)	Recovery Rate (%)
11	DAS	84.6	76.4
12	AF B2	80.6	75.0
13	AF B1	33.8	65.3
14	FB1	73.6	128.6
15	FB3	71.5	120.1
16	T-2	51.8	52.0
17	FB2	68.6	122.2
18	OTA	42.3	111.5
19	ZEN	40.4	28.0

Sensitive multi-mycotoxins analysis with a single sample preparation by LC-MS/MS

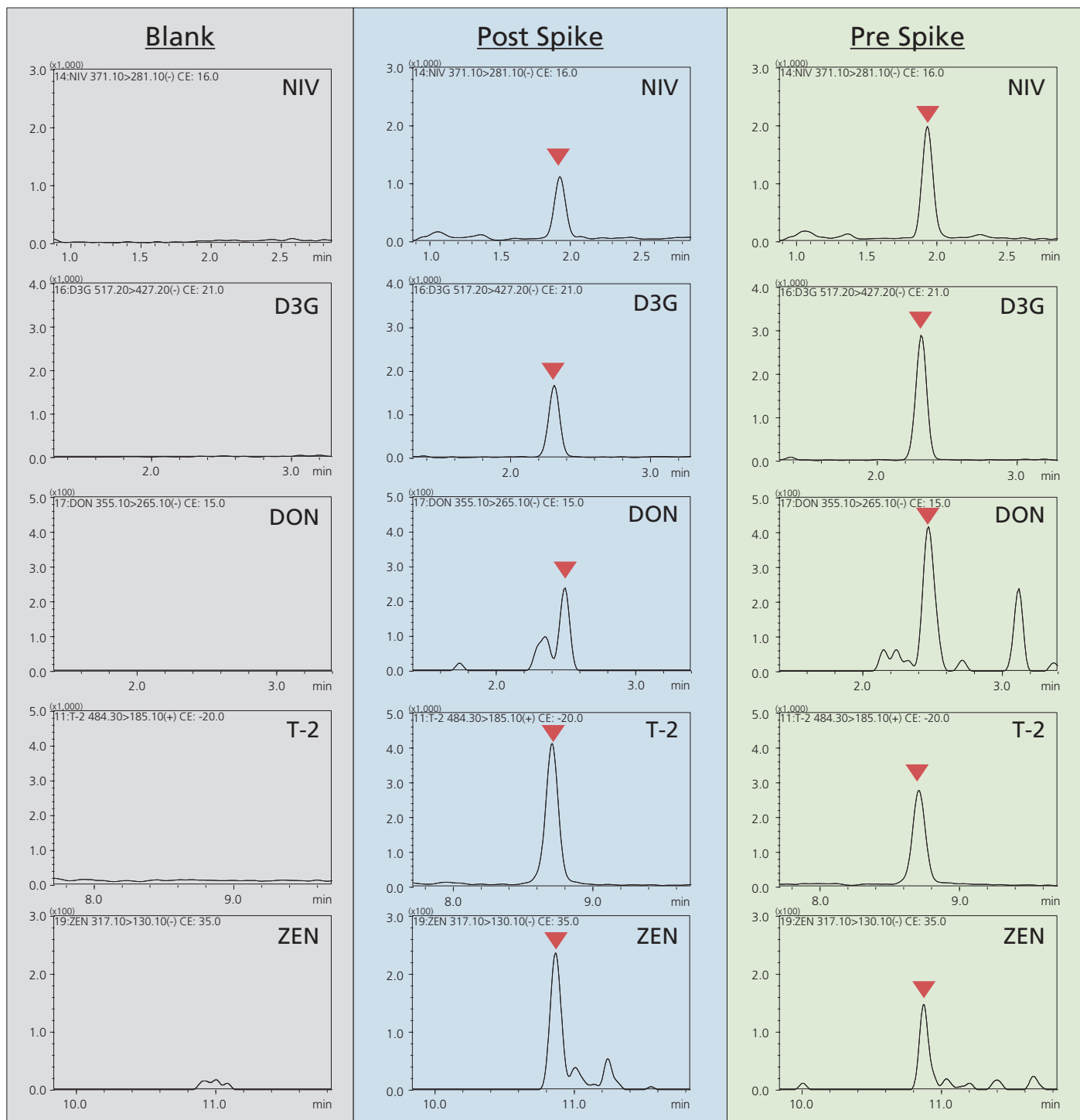

Fig 3. MS chromatograms of NIV, D3G, DON, T-2, ZEN which are pre-spiked in and post-spiked in wheat extraction at 5 ng/mL

Sensitive multi-mycotoxins analysis with a single sample preparation by LC-MS/MS

Conclusion

- This LC-MS/MS method and one step sample preparation measured various types of mycotoxins which spiked in wheat matrix.
- Sensitivity of some mycotoxins were decreased because of matrix effect.
- For accurate quantitative measurement, internal standard is necessary

Reference

- 1) Masayoshi TAMURA, Keiko MATSUMOTO, Jun WATANABE, Naoki MOCHIZUKI, et al., *Journal of separation science*, 2014, **37**, 1552-1560

The product and application are Research Use Only. Not for use in human clinical diagnostics or in vitro diagnostic procedures.

First Edition: June, 2018

Use of MALDI-TOF mass spectrometry and machine learning to detect the adulteration of extra virgin olive oils

ASMS 2018 MP 521

Simona Salivo¹; Tom K. Abban¹; Ismael Duque²;

Luis Mancera²; Matthew E. Openshaw¹

¹Shimadzu, Manchester, UK;

²Clover Bioanalytical Software, Granada, Spain

Use of MALDI-TOF mass spectrometry and machine learning to detect the adulteration of extra virgin olive oils

Introduction

Extra virgin olive oil (EVOO) is known for its nutraceutical properties, which associate it with several health benefits and a high economic value. For these reasons, EVOO is often a target of adulteration with cheaper, lower-grade vegetable oils, typically, sunflower, corn and soybean. Within the quality control process of EVOO products, it is fundamental to develop rapid, simple and robust analytical

methods to detect any fraud. Here, we present a simple approach based on the profiling of triacylglycerols (TAGs) using MALDI-TOF mass spectrometry and an evolved neural network based on a logistic regression machine learning algorithm to reveal the adulteration of extra virgin olive oils by seed oils.

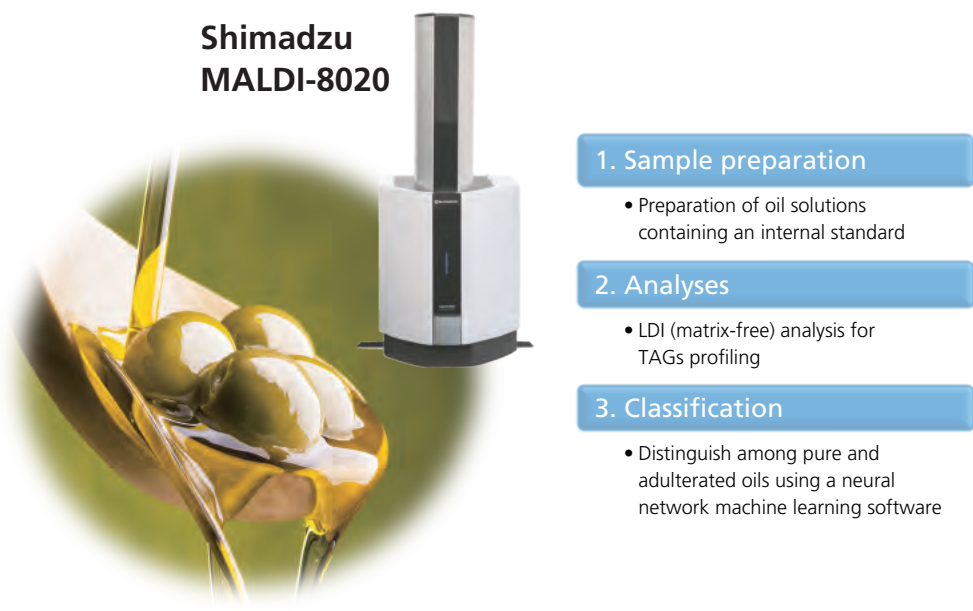

Figure 1. Left: MALDI-8020 Benchtop Linear MALDI-TOF mass spectrometer. Right: sample analysis workflow. (Picture taken from: <https://www.iobenessereblog.it/olio-extravergine-di-oliva-benefici/26429>).

Methods and Materials

EVOO and sunflower oils were purchased from local stores. Sample preparation involved dissolution of oil aliquots in chloroform. To simulate the adulteration, mixtures of EVOOs containing 5%, 10% and 20% of sunflower oil were prepared. Tricaprin was used as internal standard for mass alignment and the semi-quantitative analyses. LDI (matrix-free) analyses were conducted on a MALDI-8020 benchtop linear MALDI-TOF mass spectrometer (Shimadzu,

Manchester, UK; Figure 1), by spotting the oil sample solutions directly onto the MALDI target which was previously pre-coated with NaTFA. Data were acquired in quadruplicates for each scenario and processed using Clover MS software (Clover Bioanalytical Software, Granada, Spain) for peak area calculation and classification with neural networks.

Use of MALDI-TOF mass spectrometry and machine learning to detect the adulteration of extra virgin olive oils

Results and Discussion

MALDI analyses

Figure 2a shows a comparison between the TAG profiles of an EVOO and a sunflower oil. It can be seen how, in EVOO (red trace), naturally rich in palmitic (P) and oleic (O) acids, the TAGs at m/z 881 and 907, i.e. most likely OPO and OOO, are predominant. In sunflower oil (blue trace), highly rich in linoleic acid (L), the most representative TAGs are those at m/z 901, 903 and 905, i.e. most likely LLL, OLL

and OLO, respectively. In the oil mixture scenario (Figure 2b), the alteration of the natural TAG ratios in EVOO, e.g. m/z 877/907, 881/907, 903/907 and 905/907, can be observed. Interestingly, the TAG at m/z 901 (LLL), characteristic of sunflower oil but not normally present in EVOO, is revealed in the EVOO/sunflower mixtures even at the smallest adulteration level.

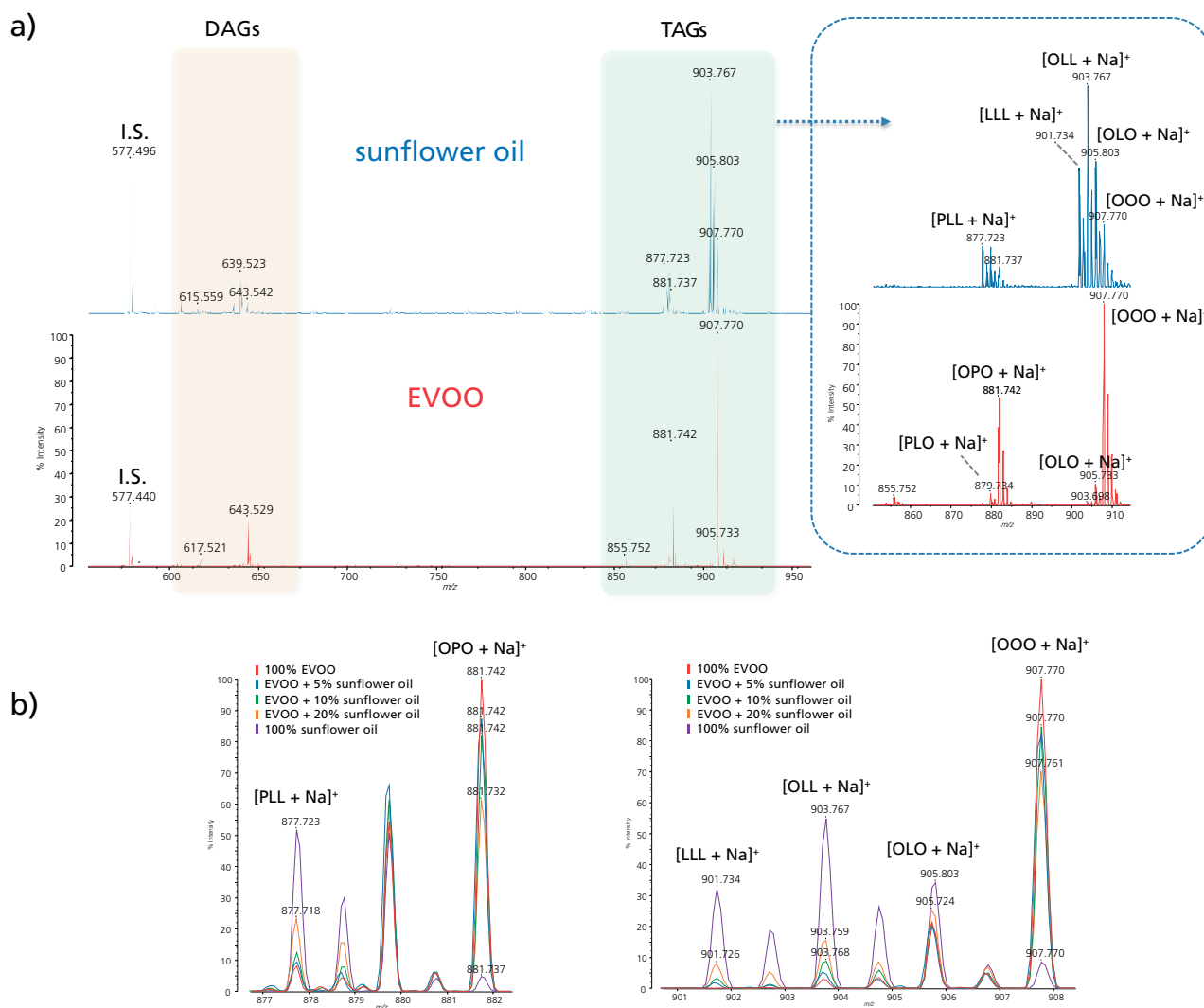

Figure 2. a) LDI MS spectra of a pure EVOO (red trace) and sunflower oil (blue trace). Right panel: expansion of the mass spectra showing the region of representative TAGs of EVOO (red trace) and sunflower oil (blue trace). b) Expansions of the overlaid mass spectra of EVOO (red trace), EVOO + 5% sunflower oil (blue trace), EVOO + 10% sunflower oil (green trace), EVOO + 20% sunflower oil (orange trace), sunflower oil (purple trace), showing the variation of TAGs and their ratios. P = palmitic acid; O = oleic acid; L = linoleic acid. I.S. = internal standard.

Use of MALDI-TOF mass spectrometry and machine learning to detect the adulteration of extra virgin olive oils

Semi-quantitative analyses

Figure 3 shows the plots of the ratios of EVOO's TAG markers and the TAG at m/z 907 (the most abundant and representative in EVOO), versus the different levels of adulterant oil (from 0%, i.e. pure EVOO, to 20% sunflower

oil). All TAGs were normalised against the internal standard using the area of the peaks from quadruplicate analyses. A good linearity has been achieved along with good coefficients of determination (R^2).

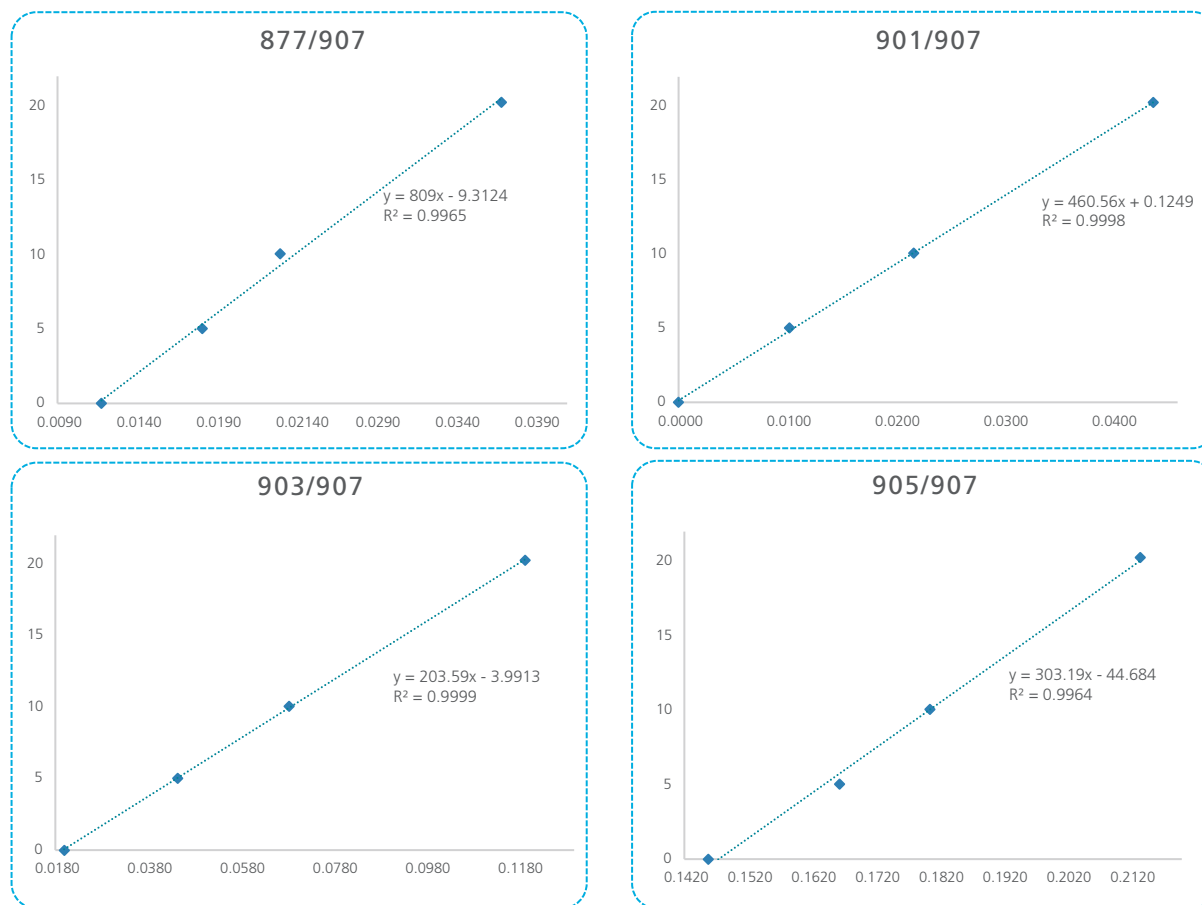

Figure 3. Plots of m/z 877/907, 901/907, 903/907 and 905/907 ratios (x-axis) versus percentage of EVOO adulteration (from 0%, i.e. pure EVOO, to 20% sunflower oil; y-axis).

Neural Network Training and Classification

Artificial Neural Networks (ANNs) are one of the well-known cutting edge technologies used for classification problems given the huge amount of data available nowadays. They are able to learn specific features from a given dataset. On the other hand, logistic regression models have been typically used for binary classification on linearly separable datasets. We show that the use of ANNs with a logistic regression model seems to be a fast and efficient combination to detect different

types of oil samples including the adulterated ones. We have created a three layers neural network able to classify between the EVOO, adulterated EVOO and sunflower oil categories (Figure 4). Prior to the classification, all spectra were aligned and normalised by the 903 Da mass. A total of 267 spectra were used to train and validate the neural network. Thirty single-blinded spectra were used to test the model accuracy (Figure 5).

Use of MALDI-TOF mass spectrometry and machine learning to detect the adulteration of extra virgin olive oils

NN Parameters Definition:

- Input Data: (1188, 222)
- Validation Data: (1188, 45)
- Categories: 3
- Epochs: 75
- Batch Size: 10
- Nodes Hidden I: 50
- Nodes Hidden II: 25
- Learning Rate: 0.00025

NN Accuracy and Testing:

- Validation Accuracy: 97.78%
- 30 single-blinded spectra: 100%

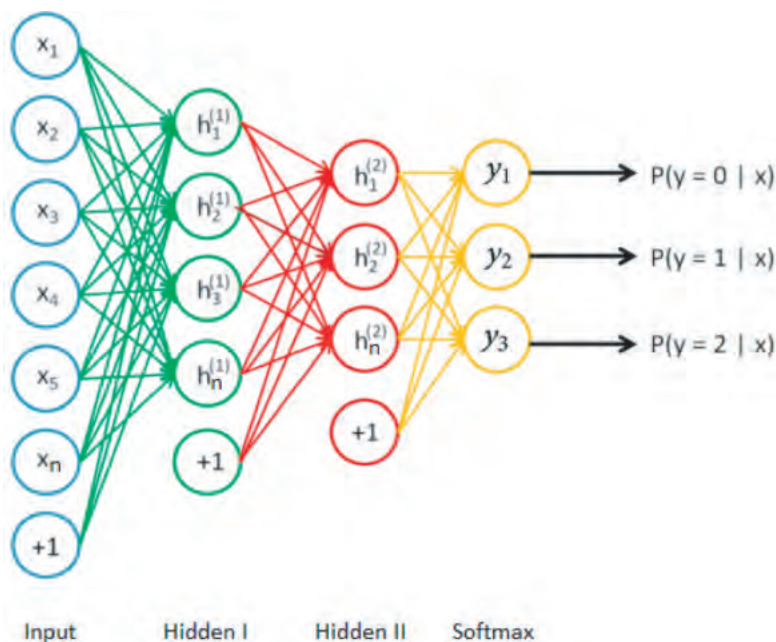

Figure 4. Representation of the neural network defined.

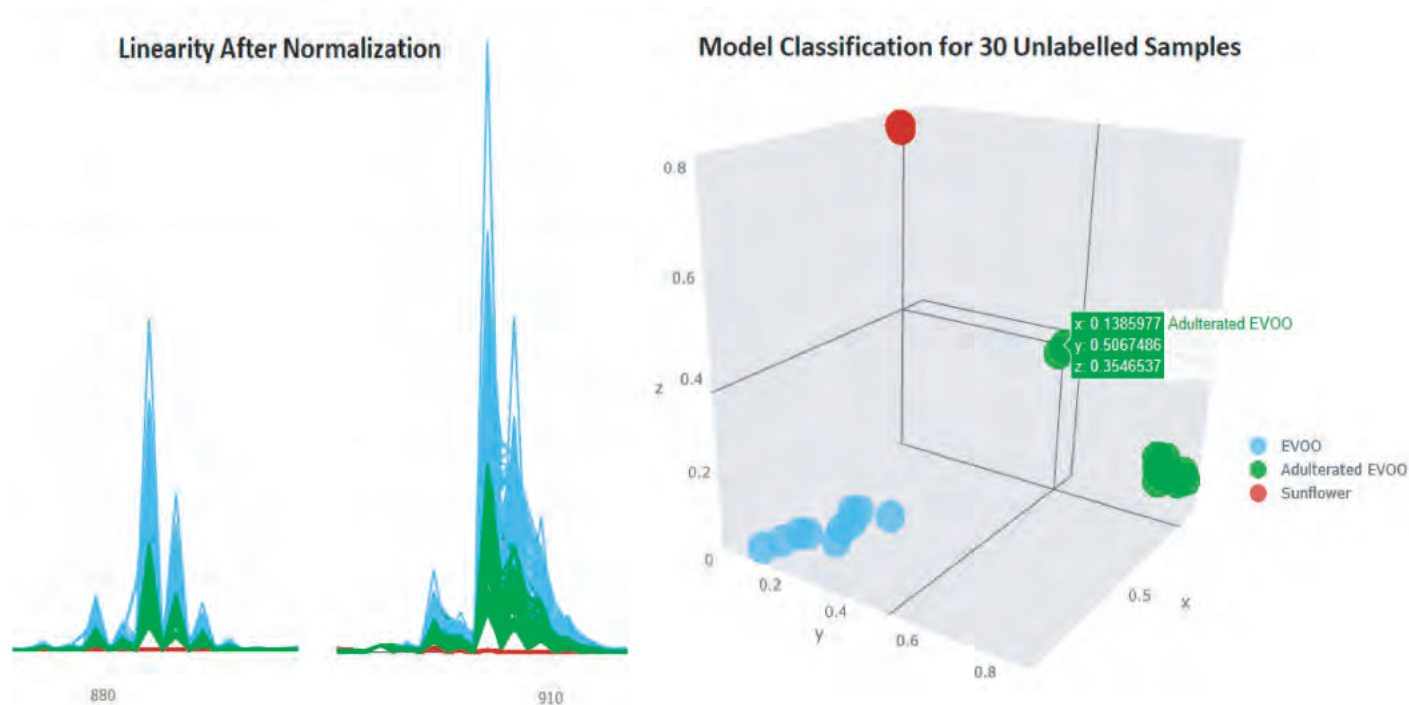

Figure 5. The linearity shown in the spectrum (left) after alignment and normalization of the input data using the Clover MS Software. The trained model classification results (left) over the 30 single-blinded samples.

Use of MALDI-TOF mass spectrometry and machine learning to detect the adulteration of extra virgin olive oils

Conclusions

The combination of MALDI-TOF MS and the use of a cutting edge machine learning technique has been proven to be suitable for the detection of adulterated EVOO. The efficiency and simplicity of the methodology proposed is

the key point of this research. The promising results achieved, and the expansion of the dataset and categories to be detected will determine the future viability of the system and its introduction into the oil industry.

Disclaimer: The products and applications in this presentation are intended for Research Use Only (RUO). Not for use in diagnostic procedures.

A rapid screening method of mycotoxins in grains by liquid chromatograph tandem mass spectrometry

ASMS 2018 MP-290

Manami Kobayashi¹, Eishi Imoto², Jun Watanabe²,
Satoshi Yamaki³, Junichi Masuda¹

¹ Shimadzu Corporation, Kanagawa, Japan

² Shimadzu Corporation, Kyoto, Japan

³ Shimadzu Corporation, Beijing, China

A rapid screening method of mycotoxins in grains by liquid chromatograph tandem mass spectrometry

Overview

Development of a rapid simple screening method by LC/MS/MS for mycotoxins containing fumonisins.

Introduction

Mycotoxin is a chemical substance produced by mold. In terms of harmful substances to health of human and livestock, regulatory limitation is defined in each country. In recent years, the risk management of mycotoxins has been gaining wider acceptance all over the world. In this report, we demonstrate a simultaneous screening analysis for 18

kinds of mycotoxins in grains by LC/MS/MS. For the purification of grain extract, Multitoxin Spin Column (Romer Labs) was utilized in order to perform a simple and rapid clean-up treatment for mycotoxins, which has individual chemical properties, such as aflatoxins, ochratoxin A, trichothecenes, and fumonisins.

Methods and Materials

Analytical conditions

Analysis was performed by a LCMS-8050 which was equipped with a Nexera™ X2 UHPLC. Pentafluorophenyl (PFP) bounded column was used to separate the regioisomeric pair (3-AcDON / 15-AcDON, FB2 / FB3) by gradient elution with a series of mobile phases containing ammonium acetate, acetic acid and methanol. Quantitative limits had been deemed to be less than or equivalent to the minimum values specified in EC/1886/2006. The developed method achieved the simultaneous

determination of mycotoxins such as aflatoxins (B1, B2, G1, G2), fumonisins (B1, B2, B3), ochratoxin A (OTA), trichothecenes [(3-acetyldeoxynivalenol(3-AcDON), 15-acetyldeoxynivalenol (15- AcDON), deoxynivalenol (DON), HT-2, nivalenol (NIV), T-2, zearalenone (ZEN)), Fusarenon-X (FUX) , Diacetoxy- scirpenol (DAS)] and patulin (PAT) in 15 minutes analytical cycle. This analytical method was developed by the modified LC/MS/MS method package for mycotoxin (Shimadzu Corporation, Japan).

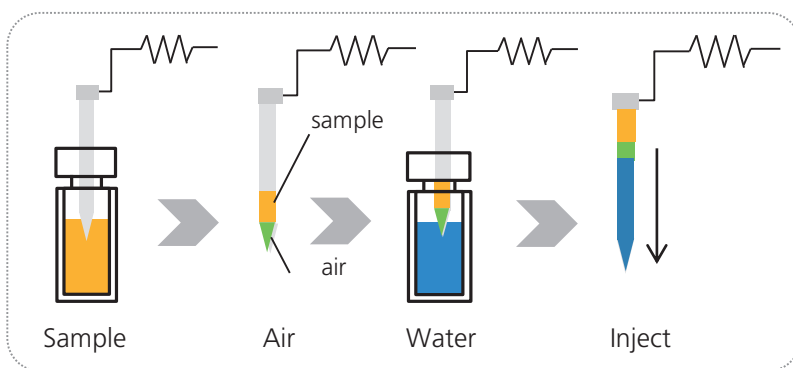

Inject method

Improving peak shape of NIV solved in more than 50% of acetonitrile aqueous solution, the sample solutions should be injected with additional water. SIL-30AC autosampler has this useful function shown as above.

A rapid screening method of mycotoxins in grains by liquid chromatograph tandem mass spectrometry



High Speed Mass Spectrometer
Ultra Fast Polarity Switching -5 msec
Ultra Fast MRM -Max.555 transition/sec

Figure 1 LCMS-8050 triple quadrupole mass spectrometer

UHPLC conditions (Nexera™ X2 system)

Column : Mastro PFP 2 (150 mm×2.1 mm, 3 μm)
 Mobile phase A : 10 mmol/L Ammonium acetate-water
 Mobile phase B : Methanol including 2% acetic acid
 Flow rate : 0.4 mL/min
 Time program : B conc. 15%(0 min) -35%(1.51 min) –
 45%(5.50 min) - 60%(5.51 min) –
 95%(9.50-12.00 min) - 15%(12.01-15.00 min)

Column temp. : 40 °C
 Injection vol. : 2.5 μL with 50 μL Water
 Rinse R0 : Mobile phase A
 Rinse R1 : 10 mmol/L Sodium citrate aqueous solution
 Rinse R2 : Water/ Methanol / Acetonitrile/ IPA = 1/1/1/1 including 1% formic acid
 Needle rinse program : inside: R1 → R0 → R2 → R0, outside: R3(1 sec) → R0

MS conditions (LCMS-8050)

Ionization : ESI, Positive/Negative MRM mode
 DL temp. : 150 °C
 Interface temp. : 200 °C
 Heat block temp. : 400 °C
 Nebulizer gas : 2.5 L/min
 Heating gas : 15 L/min
 Drying gas : 5 L/min

A rapid screening method of mycotoxins in grains by liquid chromatograph tandem mass spectrometry

Table 1 MRM transitions of Mycotoxins

No.	Mycotoxin	Retention Time (min)	Polarity	Precursor Ion (m/z)	Product Ion (m/z)	CE (V)
1	Nivalenol (NIV)	2.261	-	371.10	281.10	15
2	Patulin (PAT)	2.569	-	153.00	109.10	13
3	Deoxynivalenol (DON)	2.998	-	355.10	295.10	10
4	Fusarenon-X (FUX)	3.827	-	413.10	353.10	9
5	15-AcetylDeoxynivareno (15-AcDON)	5.582	+	339.10	261.10	-12
6	3-AcetylDeoxynivareno (3-AcDON)	5.751	+	339.10	231.10	-14
7	Aflatoxin G2 (AF G2)	7.197	+	331.10	245.10	-30
8	Diacetoxy- scirpenol (DAS)	7.480	+	384.20	307.10	-13
9	Aflatoxin G1 (AF G1)	7.433	+	329.10	243.10	-27
10	Aflatoxin B2 (AF B2)	7.669	+	315.10	259.10	-30
11	Fumonisin B1 (FB1)	7.804	+	722.40	334.10	-42
12	Aflatoxin B1 (AF B1)	7.904	+	313.10	241.10	-39
13	HT-2 toxin (HT-2)	8.060	+	442.20	263.10	-13
14	Fumonisin B3 (FB3)	8.107	+	706.40	336.10	-35
15	Fumonisin B2 (FB2)	8.475	+	706.40	336.10	-39
16	T2-toxin (T-2)	8.705	+	484.30	185.10	-23
17	Ochratoxin A (OTA)	8.987	+	404.10	239.10	-24
18	Zearalenone (ZEN)	9.532	-	317.10	131.10	30

Sample preparation

Analytical samples were prepared through the extraction protocol of MycoSpin™400 (Romer Labs), which is a very convenient method without evaporator nor nitrogen purge procedures. The operation of MycoSpin™400 was completed within 5 minutes.

A rapid screening method of mycotoxins in grains by liquid chromatograph tandem mass spectrometry

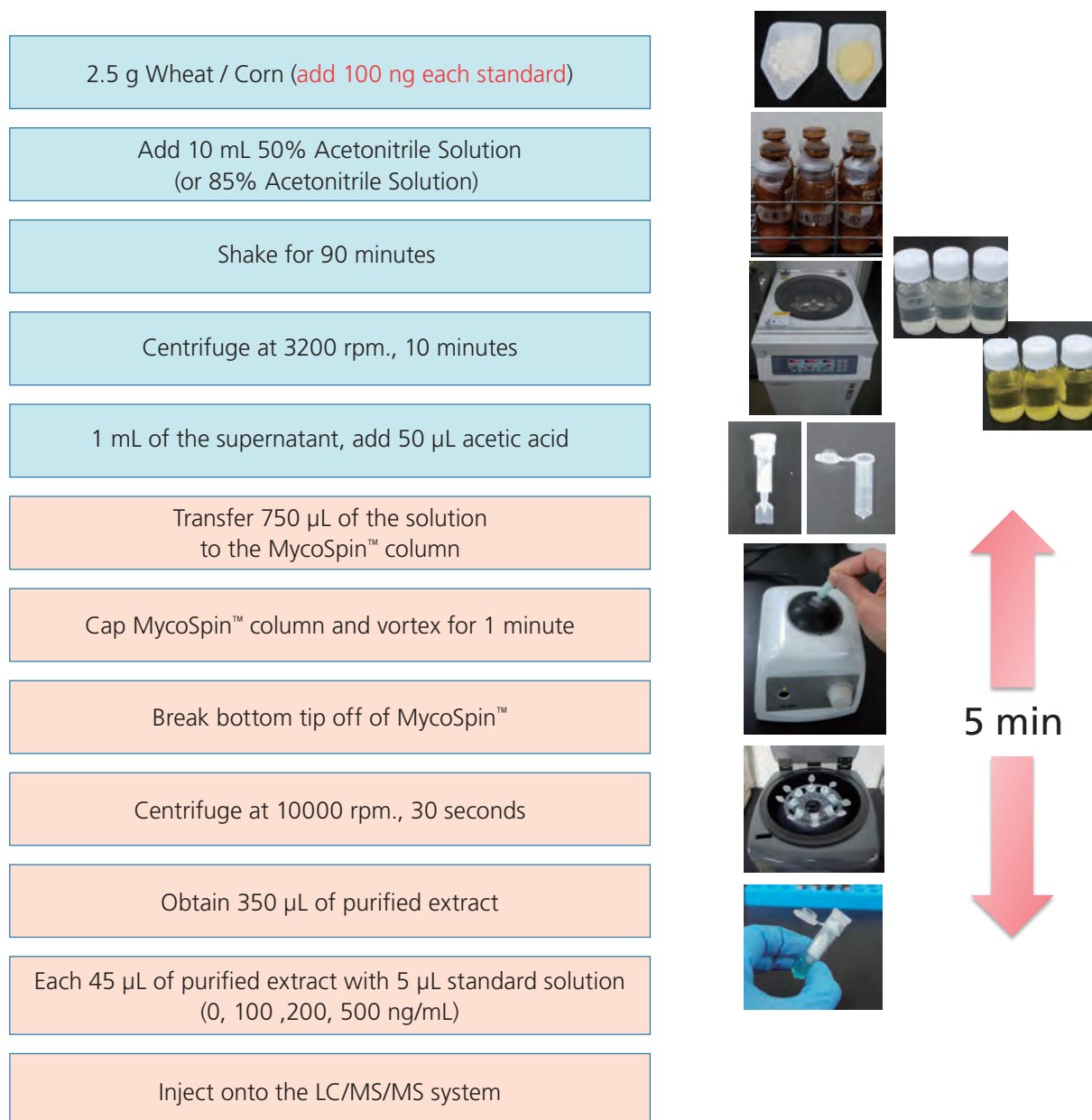

Figure 2 Protocol of sample preparation

A rapid screening method of mycotoxins in grains by liquid chromatograph tandem mass spectrometry

Result

Analysis of Standard Solution

Figure 3 shows MRM chromatograms of the 18 mycotoxin standards (each 10 ng/mL).

At first, we evaluated the solvent for better recovery of the mycotoxin from MycoSpin™ column.

In comparison, with 85% acetonitrile aqueous solution, better recovery of fumonisins was obtained with 50% acetonitrile aqueous solution (Fig.4). Thus, we decided to use 50% acetonitrile aqueous solution for the extraction solvent.

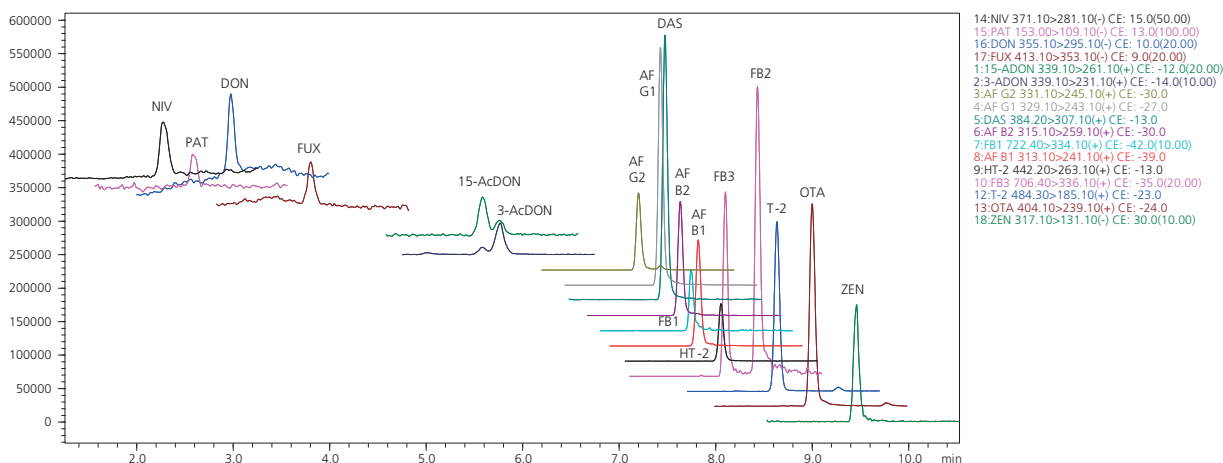

Figure 3 MRM chromatograms of the 18 mycotoxin standards (each 10 ng/mL).

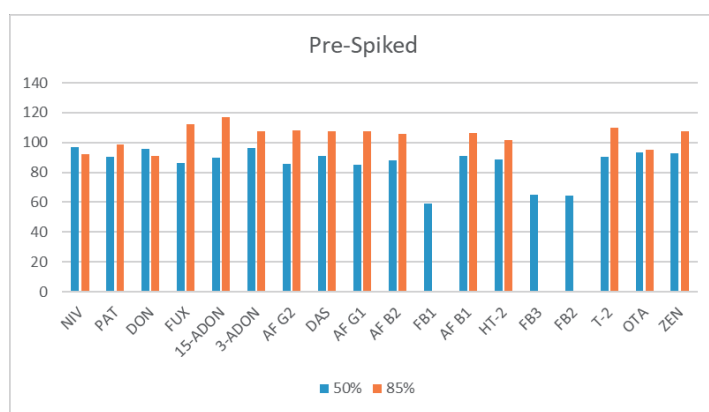

Figure 4 Recovery (%) of the mycotoxin standard from MycoSpin™ column. (Each 10 ng/mL standard mixture was applied on the column.)

Evaluation of the matrix effect

Figure 5 shows recovery (%) of the mycotoxin standards in the four kinds of extraction as wheat, corn powder, peanut powder, and almond powder. MycoSpin™ protocol was convenient in short timescale. However, even after the clean-up, many matrix compounds remained and was

affected.(Fig. 5). Although under this situation, it usually requires each labeled internal standard for target compound, we tried to investigate the quantify by the standard additive method.

A rapid screening method of mycotoxins in grains by liquid chromatograph tandem mass spectrometry

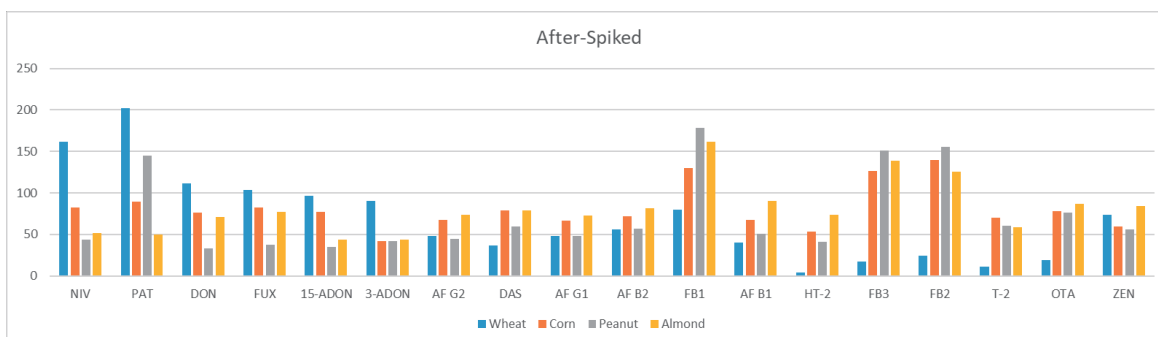

Figure 5 Recovery (%) of the mycotoxins under the four kinds of extractions. The each standard was spiked after clean-up procedure (final each 10 ng/mL).

Quantitative analysis

The results of quantitative analysis from wheat and corn powder using the sample preparation protocol (2.2) is summarized in table 2 through using the standard additive method instead of the internal standard method. The results indicates that the standard addition calibration

method could help correct and improve the recovery rate even under the influence of the matrix effect. Using this method, only a small amount of mycotoxins were detected in corn powder below the regulation value.

Table 2 The results of wheat and corn powder

	Wheat			Corn		
	Result (mg/Kg)	Recovery (%)	%RSD (n=2)	Result (mg/Kg)	Recovery (%)	%RSD (n=2)
NIV	N.D.	93	0.86	N.D.	134	2.00
PAT	0.0350	94	5.36	N.D.	79	15.60
DON	0.0148	128	6.34	0.1376	114	10.66
FUX	N.D.	101	0.30	N.D.	149	0.02
15-AcDON	N.D.	119	10.73	0.0213	114	14.30
3-AcDON	N.D.	106	7.64	N.D.	117	8.26
AF G2	N.D.	104	4.27	N.D.	115	1.80
DAS	N.D.	118	4.24	N.D.	137	2.25
AF G1	N.D.	101	3.45	N.D.	119	1.11
AF B2	N.D.	110	0.07	N.D.	125	5.95
FB1	N.D.	60	18.33	0.0407	94	15.16
AF B1	N.D.	104	2.06	0.0011	124	2.32
HT-2	N.D.	107	9.21	0.0008	132	3.91
FB3	N.D.	70	19.66	0.0078	83	7.19
FB2	N.D.	66	6.23	0.0094	79	5.80
T-2	N.D.	105	4.79	0.0005	119	1.80
OTA	N.D.	97	12.29	N.D.	109	4.38
ZEN	N.D.	97	0.90	0.0120	103	3.37

A rapid screening method of mycotoxins in grains by liquid chromatograph tandem mass spectrometry

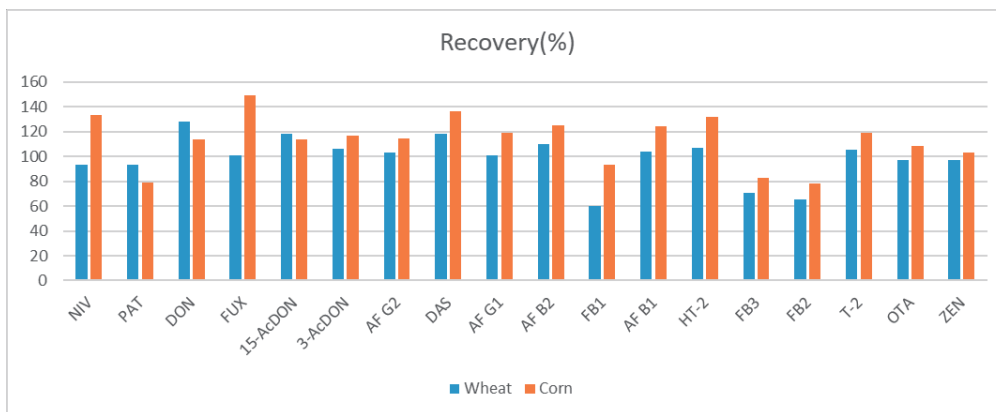

Figure 6 Recovery (%) of the mycotoxin standards from wheat and corn powder (Each 100 ng standard was spiked)

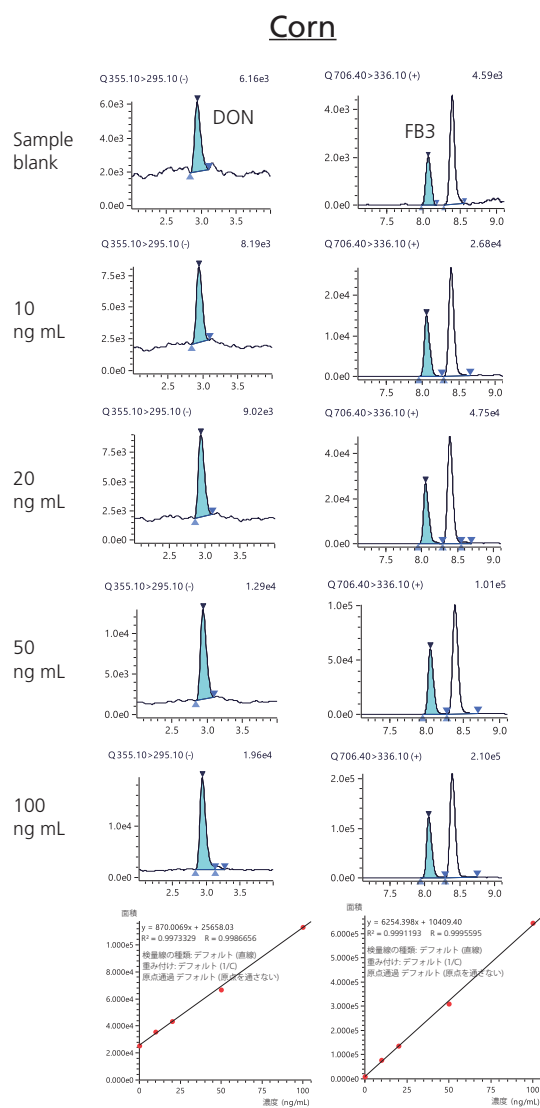

Figure 7 Chromatograms and calibration curves of the corn extraction (DON and FB3).

A rapid screening method of mycotoxins in grains by liquid chromatograph tandem mass spectrometry

Conclusions

- A rapid screening method for mycotoxins had been established.
- The LC/MS/MS method package for mycotoxin (Shimadzu Corporation, Japan) is useful tools for this type of analysis.
- The extraction solvent to improve the recovery rate of fumonisins was optimized.
- We investigated the standard addition method in order to compensate for the effect of the matrix.
- We plan to continue to evaluate multi-function columns or ion exchange columns for further improvement of the clean-up.

First Edition: June, 2018



Shimadzu Corporation
www.shimadzu.com/an/

For Research Use Only. Not for use in diagnostic procedures.

This publication may contain references to products that are not available in your country. Please contact us to check the availability of these products in your country.

The content of this publication shall not be reproduced, altered or sold for any commercial purpose without the written approval of Shimadzu. Company names, products/service names and logos used in this publication are trademarks and trade names of Shimadzu Corporation, its subsidiaries or its affiliates, whether or not they are used with trademark symbol "TM" or "®".

Third-party trademarks and trade names may be used in this publication to refer to either the entities or their products/services, whether or not they are used with trademark symbol "TM" or "®".

Shimadzu disclaims any proprietary interest in trademarks and trade names other than its own.

The information contained herein is provided to you "as is" without warranty of any kind including without limitation warranties as to its accuracy or completeness. Shimadzu does not assume any responsibility or liability for any damage, whether direct or indirect, relating to the use of this publication. This publication is based upon the information available to Shimadzu on or before the date of publication, and subject to change without notice.

Application News

MultiNA

Qualitative Determination of Edible Corn Oil Using the MultiNA and the PCR Method

Lixiao Li

Analytical Instruments Dept. Analytical Application Center Shimadzu (China) Co., LTD

■ Abstract:

Currently, edible oil adulteration is a common practice. This not only affects the physical health of consumers, but also lowers their confidence and has a serious impact on their interests. This paper proposes the design of a PCR primer for the specific gene of the species to be identified by DNA-based molecular biological means because different species have different DNA sequences, and determines the existence and chain length of the PCR amplified product using the MultiNA, thereby establishing a MultiNA-based method for edible oil identification. The specific gene PCR extracted from corn oil was amplified, and the size of its amplified product as determined by the MultiNA was 196 bp, largely consistent with the size of the PCR target product of the corn gene (190 bp). The experimental results indicate that this method can realize the qualitative determination of edible oils.

■ Introduction

Together with rice and flour, edible oils are foods essential to people's daily lives. In order to reduce costs and earn extra profits, some illegal traders sell lower-cost edible oils in place of higher-cost types, or substantially blend lower-cost edible oils with higher-cost types. This not only affects the physical health of consumers, but also lowers their confidence and has a serious impact on their interests. Edible oil identification and adulteration detection using molecular biological techniques feature high sensitivity and reliability. A PCR primer is designed to identify the specific gene of the species because different species have different DNA sequences, and the existence and chain length of the PCR amplified product are determined to realize substance identification. This paper establishes a MultiNA-based method for edible oil identification. A modified reagent kit method was used to extract the corn genome from corn oil. A primer was designed for the corn endogenous gliadin gene, and subject to PCR amplification using PCR instrument. The size of its amplified product based on the MultiNA was 196 bp, largely consistent with 190 bp of the expected product amplified from the primer. The experimental results indicate that through edible oil gene extraction using this method, PCR amplification, and MultiNA determination, edible oil identification can be realized.

■ 1. Experimental Materials and Methods

1.1 Instruments

MCE-202 MultiNA, PCR instrument

1.2 Reagents

Vegetable oil gene extraction reagent kit
(Beijing Kwinbon Biotechnology Co., Ltd.) FZ-002
SYBR[®] Premix Ex Taq[™] II (Takara Bio Inc.) RR820A
Primers: 5'-TGAACCCATGCATGCAGT-3'
5'-GGCAAGACCATTGGTGA-3'
(primer synthesized by Sangon Biotech)
DNA-500 Reagent Kit for MultiNA
(Shimadzu Corporation) 292-27910-91
SYBR[®] Gold Nucleic Acid Gel Stain (Invitrogen) S-11494
1xTE Buffer
25 bp DNA Ladder (Invitrogen) 10597-011
DNA-500 Reagent Kit for MultiNA
(Shimadzu Corporation) 292-27910-91
Sample: commercially available edible pure corn oil

1.3 Analysis Conditions

DNA-500 on chip mode

1.4 Analysis Procedure

1.4.1 DNA Extraction and Purification in Sample

1.4.1.1 Mix the sample oil with the 1x extract in the extraction reagent kit at a ratio of 2:1, and strongly stir the mixture with a magnetic stirrer for 30 minutes. Add the 1x extract obtained after centrifugation to the new sample oil again, and repeat this step. The total amount of sample oil used is 4,000 mL.

1.4.1.2 Centrifuge the thoroughly mixed mixture at high speeds (at 12,000 rpm for 10 min), then remove the upper oil phase completely, and put the aqueous phase extract in a rotary evaporator for dry concentration at 65 °C.

1.4.1.3 Dissolve the freeze-dried matter with 1 mL of 1x extract, extract 0.375 mL of the dissolved matter and place in a 1.5 mL centrifuge tube, add 0.375 mL of extract A, mix, and put in a 65 °C water bath for 1 hour.

1.4.1.4 After bathing, add 0.75 mL of extract B: extract C=1:1 mixture to the tube, mix for 30 seconds, and then centrifuge at 12,000 rpm for 5 minutes.

1.4.1.5 Pipette the upper aqueous phase into a new 1.5 mL centrifuge tube, add double volume of the pre-cooled anhydrous alcohol (4 °C), 10 % volume of settling agent 1 and 1.5 mL of settling agent 2, mix, and allow to settle at -20 °C for 1 hour.

1.4.1.6 After settlement, centrifuge at 12,000 rpm for 15 minutes, and pour away the supernatant carefully. At this point, white sediment can be seen at the bottom of the EP tube. This sediment is the extracted DNA.

1.4.1.7 Add 1 mL of pre-cooled washing solution (4 °C), flip the EP tube to mix, centrifuge at 12,000 rpm for 5 minutes, then discard the supernatant, and invert the EP tube onto a filter paper for drying.

1.4.1.8 Add 30 mL of dissolving solution to the dried EP tube for sediment dissolution, and maintain the resultant solution at -20 °C. Preheat the resultant solution at 65 °C for improved dissolution. The resultant solution can be used directly for subsequent PCR determination.

1.4.2 PCR reaction system

See Tables 1 and 2 for the PCR reaction reagents and conditions.

Table 1 PCR Reaction Reagents

	Amount	Final concentration
SYBR® Premix Ex Taq II (Tli RNaseH Plus) (2 ×)	10.0 µl	1 ×
PCR Forward Primer (10 mM)	0.8 µl	0.4 µM
PCR Reverse Primer (10 mM)	0.8 µl	0.4 µM
DNA template	2.0 µl	<100 ng
dH2O (sterile purified water)	6.4 µl	
Total volume	20.0 µl	

Table 2 PCR Reaction Parameters

Impact	Time/s	Temperature/°C
Active DNA enzyme and initial denaturation	30	95
PCR (45 cycles)		
Denaturation	30	95
Annealing	30	55
Extending	60	72
Holding after cycles	180	72

Discussion of Results

Fig. 1 and Fig. 2 are the gel diagram and electropherogram obtained by analyzing the ladder, DNA amplified product extracted from corn oil, positive control (used the corn gene template during PCR) and negative control (did not use the corn gene template during PCR), using the MultiNA, respectively. A remarkable 197 bp band was obtained from the positive control. Since the chain length of the PCR target product was 190 bp, and no corresponding band near this area was obtained from the negative control, the PCR procedure has been executed successfully. The DNA amplified product extracted from corn oil was subject to a MultiNA analysis, and the results indicate that a 196 bp band was detected, showing that this corn oil contains a corn endogenous gene. The fragment length determined using the MultiNA differs slightly from that of the PCR target product. This result is deemed rational in consideration of the instrument error of 5 %.

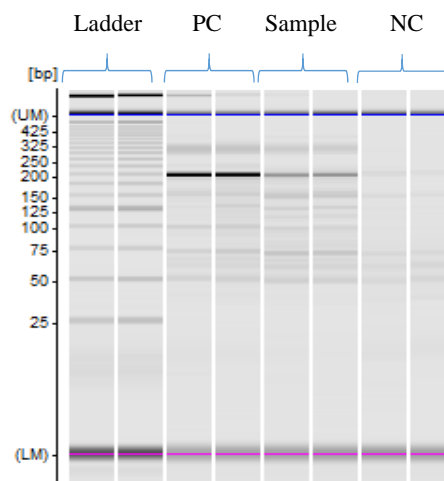

Fig. 1 Gel Analysis Results of Edible Corn Oil (PC: positive control; NC: negative control)

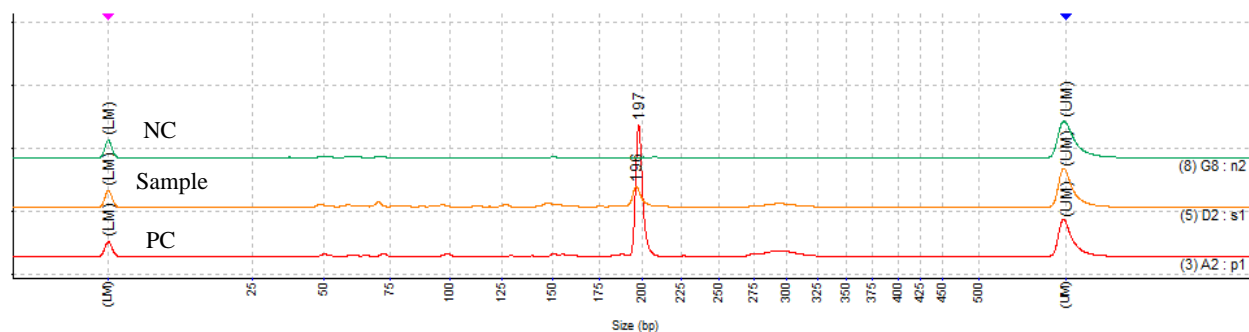

Fig. 2 Electrophoresis Results of Edible Corn Oil (PC: positive control; NC: negative control)

Conclusion

This paper establishes a method for the qualitative determination of edible vegetable oils using the Shimadzu MCE-202 MultiNA based on molecular biological technology. For the species identification of edible oils, this method is

reliable and easy to operate, and can be applied for the qualitative and quantitative measurement of edible oils in complex systems, thus allowing full exposure of edible oil adulteration.

Cost-effective SPE and LC/MS/MS for Analysis of 18 Mycotoxins



Background: Authorities such as European Union (EU) and US Food and Drug Administration (FDA) impose strict regulations on mycotoxins in agriculture products due to their extreme toxicity. There are many mycotoxins that are regulated under the European Union EC/1886/2006. Mycotoxins are extracted and cleaned up by immunoaffinity column or solid phase extraction. Due to their different polarities, different immunoaffinity cartridges or different SPE tubes and conditions must be used for recovering multiple mycotoxins, which is time-consuming and expensive. A cost-effective and reliable approach was developed using Biotage ISOLUTE Myco SPE tubes and LCMS-8060 with a Mastro PFP column. A total of 18 polar and less polar mycotoxins regulated by EU regulation could be effectively extracted and cleaned up using the same SPE tube under two conditions and analysed using the same LC/MS/MS method on LCMS-8060.

Technical approach & solution: the 18 targeted mycotoxins are extracted and cleaned up using ISOLUTE Myco SPE tubes under two conditions for polar (6) and less polar compounds (12) for different crop matrices. The operation of the two conditions is similar and easy as illustrated below. The obtained eluents can be injected to LCMS directly and analysed using a same MRM based method.

SPE Condition 1 – For polar mycotoxins (6)	SPE Condition 2 – For less polar mycotoxins (12)
<ol style="list-style-type: none"> 1. Powered sample extracted with acidified water. Vortex and centrifuge. 2. Dilution with water. 3. SPE clean-up <ul style="list-style-type: none"> ➤ Add ACN ➤ Add water ➤ Loading ➤ Wash with water ➤ Elute with ACN 	<ol style="list-style-type: none"> 1. Powered sample extracted with acidified water and ACN. Vortex and centrifuge. 2. Dilution with water. 3. SPE clean-up <ul style="list-style-type: none"> ➤ Add ACN ➤ Add water ➤ Loading ➤ Wash with water; followed by 10% ACN ➤ Elute with acidified ACN and MeOH

Workflow of ISOLUTE Myco SPE for extraction and clean-up for 6 polar and 12 less polar mycotoxins under different conditions

LC conditions for quantitative screening of 18 mycotoxins on LCMS-8060

Column:	Shimadzu Mastro PFP (100mL x 2.1mm I.D, 3 µm)
Flow rate:	0.4 mL/min
Mobile phase:	A: 0.15 mM Ammonium fluoride in water B: 0.15 mM Ammonium fluoride in MeOH with 2% acetic acid
Oven Temp:	40°C
Injection vol:	10 µL
LC program:	Gradient elution, 12.5 minutes B% : 15% (0.0 to 1.0 min) → 25% (1.0 min) → 40% (2.0 min) → 41% (4.5 min) → 100% (7.5 to 10.0 min) → 15% (10.1 to 12.5 min)

Biotage
ISOLUTE[®] Myco

- One product for multiple mycotoxins analysis
- Quick and easy to use
- No special storage requirements
- Cost-effective

MRM Chromatograms of 18 mycotoxins spiked in barley sample (NIV, DON, FUS-X, NEO, 15-AcDON, and 3-AcDON at 2.5 ng/mL; AFB1 and AFG1 at 0.5 ng/mL; AFB2 and AFG2 at 0.15 ng/mL; DAS, FB1, FB2, FB3, HT-2, T-2, OA and ZON at 25 ng/mL).

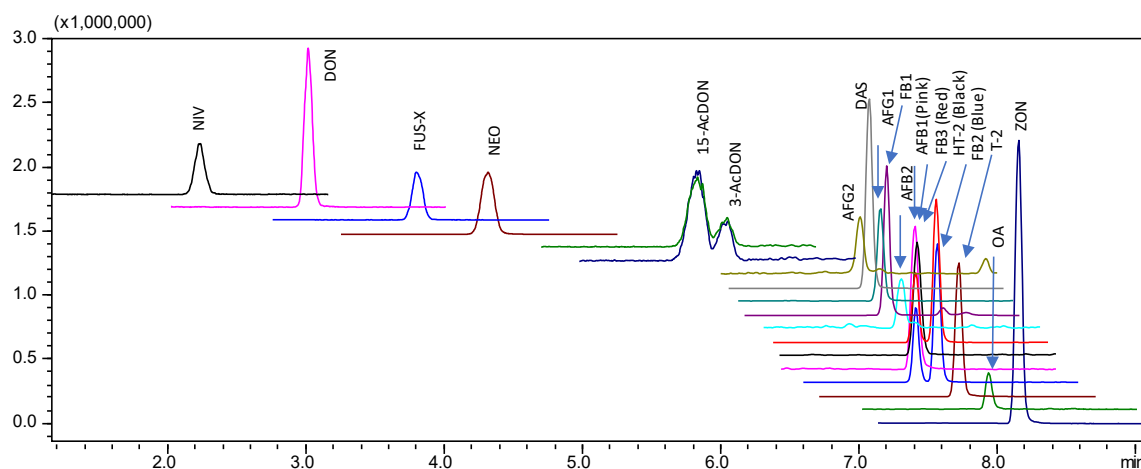

MRM transitions and LOQ and LOD (ng/mL) of 18 mycotoxins spiked in different matrices, dilution factor (DF) = 40 for No. 1~6 and DF = 20 for No. 7~18.

No	Compound	MRM transition 1	MRM transition 2	Barley		Rice		Corn		Wheat Flour		Cashew	
				LOQ	LOD	LOQ	LOD	LOQ	LOD	LOQ	LOD	LOQ	LOD
1	NIV	371.1 > 281.2	371.1 > 311.2	0.15	0.05	0.22	0.07	2.50	0.80	0.50	0.17	0.50	0.17
2	DON	297.2 > 249.2	297.2 > 279.2	0.25	0.08	0.05	0.02	0.50	0.17	0.25	0.08	2.50	0.8
3	FUS-X	355.2 > 247.2	355.2 > 277.2	0.06	0.02	0.10	0.03	0.09	0.03	0.25	0.08	1.57	0.52
4	NEO	400.2 > 305.2	400.2 > 215.2	0.01	<0.01	0.03	0.01	0.01	<0.01	0.01	<0.01	0.01	<0.01
5	15-AcDON	339.3 > 261.2	339.3 > 297.2	0.5	0.17	0.25	0.08	0.51	0.17	0.24	0.08	0.99	0.33
6	3-AcDON	339.2 > 261.2	339.2 > 297.2	0.44	0.15	0.50	0.17	0.63	0.21	0.27	0.09	2.50	0.8
7	AFG2	331.2 > 245.1	331.2 > 285.1	0.15	0.05	0.02	0.01	0.08	0.02	0.03	0.01	0.10	0.03
8	DAS	384.2 > 307.2	384.2 > 229.2	0.10	0.03	0.05	0.02	0.10	0.03	0.05	0.02	0.04	0.02
9	AFG1	329.1 > 243.1	329.1 > 200.1	0.01	<0.01	0.01	<0.01	0.04	0.01	0.01	<0.01	0.02	0.01
10	FB1	722.4 > 352.4	722.4 > 334.3	0.24	0.08	0.35	0.11	0.2	0.06	0.26	0.09	0.50	0.17
11	AFB2	315.2 > 287.1	315.2 > 259.1	0.03	0.01	0.01	<0.01	0.03	0.01	0.03	0.01	0.03	0.01
12	AFB1	313.1 > 285.1	313.1 > 241.1	0.01	<0.01	0.01	<0.01	0.02	0.07	0.02	0.01	0.03	0.01
13	HT-2	706.4 > 318.3	706.40 > 354.4	1.00	0.33	0.04	0.01	2.13	0.70	4.85	1.60	2.50	0.8
14	FB3	447.3 > 345.2	447.3 > 285.1	0.50	0.17	0.50	0.17	0.27	0.09	0.50	0.17	0.50	0.17
15	FB2	706.4 > 318.3	706.4 > 354.4	0.50	0.17	0.50	0.17	0.85	0.28	0.08	0.03	0.50	0.17
16	T-2	484.30 > 215.2	484.3 > 185.1	0.29	0.09	0.03	0.01	0.20	0.06	0.05	0.02	0.45	0.15
17	OA	404.2 > 221.0	404.2 > 239.1	0.05	0.02	0.08	0.03	0.31	0.10	0.05	0.02	0.05	0.02
18	ZON	317.1 > 175.1	317.1 > 131.2	0.10	0.03	0.05	0.02	0.22	0.07	0.10	0.03	0.10	0.03

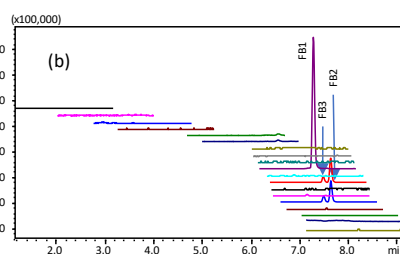
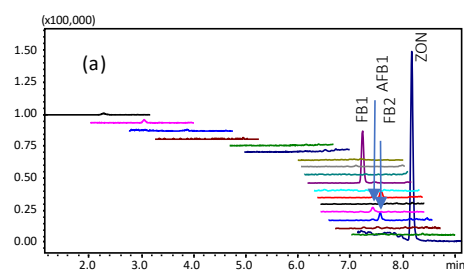

MRM chromatograms of real samples; (a) Barley J1 and (b) Corn G9. The quantitative results of few mycotoxins detected are below the EU limits.

Conclusions: a cost-effective method using ISOLUTE Myco SPE and LC/MS/MS was developed for quantitative screening for 18 mycotoxins regulated by EU regulation. The method performance was evaluated with 5 different crop matrices. The sensitivity of the method is sufficient for detection of the 18 targeted mycotoxins to the limits set by EU regulation.

Reference:

[1] Validation of A Low-Cost and Highly-Sensitive Method for Determination of Eighteen Mycotoxins in Food Matrixes Using SPE and LC/MS/MS, ASMS-2018 poster accepted

Testing and Analysis of Genetically Modified Food – Application of MultiNA –

Yoshiyuki Harada



(Photo Above: Natural product, unrelated to text contents)

1. Introduction

Genetically modified organism (GMO) has burgeoned over the years in order to satiate the global appetite or to add value to natural agriculture products. Technology to increase crop yields has been a constant demand, and the introduction and success of increased agricultural yield by using gene recombinant technology has indeed increased productivity in crop yields. On the other hand, the question arises as to whether these genetically modified food sources safe to eat, and nutritionally beneficial compared to natural products? The necessity to protect consumers while assisting agricultural food producers is a challenge for regulatory agencies globally, requiring that they keep up with quickly evolving technology and increasing genetically modified foods. In this environment, various regulations are conducted

in many countries. For example, in Japan, only genetically modified foods that have received approval through safety assessment are permitted to be circulated in the domestic food market.

Domestic consumers tend to avoid such genetically modified foods though many GMO food have been approved by the safety assessment, the cultivation and circulation of foods developed using gene recombinant technology are currently rare in Japan. However, genetically modified organisms are actively cultivated globally, and large quantities of genetically modified organisms and their processed foods spread all over the world. Thus, genetically modified may penetrate gradually into the Japanese market in future.

2. Genetically Modified Organism (GMO)

Genetically modified organisms are farm products that breed improvement is introduced by gene recombinant technology. Comparing to conventional methods of hybridization and artificial mutation, the gene recombinant technology transforms plants artificially and enables the introduction of genes from other species and a wider variety of breed improvements in a much shorter period of time.

Various characteristic forms including insect resistance, virus resistance and herbicide tolerance for the improvement of cultivation, high lysine for the increment of nutritive value and high oleic for health promotion are introduced to genetically modified organisms distributed globally.

According to ISAAA¹⁾ 2009 statistics, the cultivation area for genetically modified organisms has reached as much as 134 million hectares. The proportion of genetically modified organisms to whole organisms has reached 77 % for soybeans, 26 % for corn, 21 % for rapeseed, and 49 % for cotton respectively. Genetically modified organisms and their processed food are referred to as genetically modified food. According to the Food Sanitation Act in Japan, the safety assessment of genetically modified foods is mandatory and only foods approved in the assessment are permitted to be imported and circulated.

As of July 2010, genetically modified foods corresponding to 126 varieties of genetically modified organisms have been approved through safety assessments. These include 8 varieties of potatoes, 7 varieties of soybeans, 3 varieties of sugar beets, 70 varieties of corn, 15 varieties of rapeseed, 20 varieties of cotton, and 3 varieties of alfalfa²⁾.

3. Labeling of Genetically Modified Foods in Japan

According to Food Sanitation Act and Japanese Agricultural Standard (JAS) Law^{2), 3)} (Law Concerning Standardization and Proper Labeling of Agricultural and Forestry Products ~ Law No. 175, 1950), the genetically modified foods which are specified to be labeled as such are shown in Table 1^{2), 3)}. The items for which food labeling is obligatory include the 7 types of agricultural products along with the 32 types of processed foods containing those products listed in (1) of 1 of Table 1, as well as high oleic soybean and high lysine corn of category 2 in Table 1. The labeling of processed foods (corresponding to (2) of 1 in Table 1) in which genetically modified DNA or resulting protein does not remain after processing, is voluntary. The main raw ingredients of processed foods (those among the top 3 ingredients in terms of weight ratio of all ingredients, and where the weight ratio is at least 5 %) must be included in the label. The labeling of genetically modified foods is summarized in Table 2^{2), 3)}.

The segregation of genetically modified and non-genetically modified agricultural products (foods) is extremely important for labeling of genetically modified products. Whether or not identity preserved handling (IP) has been conducted is specified on the label.

Identity preserved handling refers to the management system in which genetically modified and non-genetically modified foods are segregated through every stage including production, distribution (truck, silo, container ship, etc.), and processing (at processing companies) under the greatest care. Further, its strict management should be confirmed by documents.

The implementation of Identity preserved handling cannot necessarily prevent the mixing of genetically modified foods into non-genetically modified foods.

If Identity preserved handling for soybean or corn is conducted and its mixing rate of genetically modified organism into non-genetically modified organism (GMO content) is less than 5 %, this Identity preserved handling is regarded as proper. The subject of the GMO content is described further on page 7.

[References]

1) ISAAA (International Service for the Acquisition of Agri-biotech Applications), <http://www.isaaa.org>

2) Department of Food Safety, The Ministry of Health, Labour and Welfare, Japan, <http://www.mhlw.go.jp/english/topics/foodsafety/dna/index.html>

3) Ministry of Agriculture, Forestry and Fisheries, Japan, "Food Labeling for Processed Foods", <http://www.maff.go.jp/e/jas/labeling/modified.html>

Table 1 Foods to Be Labeled as Genetically Modified Food in Japan

1	Produce whose composition and nutritional value are similar to that of conventional produce		
	(1) Agricultural products and processed foods containing genetically modified DNA or protein even after processing		
	Agricultural Products	Soybean (including green soybeans and soybean sprouts), Corn, Potato, Rapeseed, Cottonseed, Alfalfa, and Sugar beet	
	Processed Foods	Items subject to labeling	
		1. <i>Tofu</i> (soybean curd) and fried <i>tofu</i>	Soybean
		2. Dried soybean curd, soybean refuse, <i>yuba</i>	
		3. <i>Natto</i> (fermented soy beans)	
		4. <i>To-nyu</i> (Soy milk)	
		5. <i>Miso</i> (soybean paste)	
		6. Cooked soy bean	
		7. Canned or bottled soybean	
		8. <i>Kinako</i> (roasted soybean flour)	
		9. Roasted soybean	
		10. Item containing food of items 1 to 9 as a main ingredient	
		11. Item containing soybeans (for cooking) as a main ingredient	
		12. Item containing soybean flour as a main ingredient	
		13. Item containing soybean protein as a main ingredient	
		14. Item containing <i>edamame</i> (green soybean) as a main ingredient	<i>Edamame</i>
		15. Item containing soybean sprouts as a main ingredient	Soybean sprouts
		16. Corn snacks	Corn
		17. Corn starch	
		18. Popcorn	
		19. Frozen corn	
		20. Canned corn or bottled corn	
		21. Item containing corn flour as a main ingredient	
		22. Item containing corn grits as a main ingredient (except corn flakes)	
		23. Item containing corn (for cooking) as a main ingredient	
		24. Item containing food of items 16 to 20 as a main ingredient	
		25. Frozen potato	Potato
		26. Dried potato	
		27. Potato starch	
		28. Potato snacks	
		29. Item containing food of items 25 to 28 as a main ingredient	
		30. Item containing potatoes (for cooking) as a main ingredient	
		31. Item containing alfalfa as a main ingredient	Alfalfa
	32. Item containing sugar beet as a main ingredient	Sugar beet	
	(2) Processed foods in which genetically modified DNA or resulting protein does not remain after processing (e.g., soybean oil, soy source, corn oil, isomerized liquid sugar)		
2	Produce whose composition or nutritional value is markedly different from that of conventional produce (high oleic acid soybeans, high lysine corn)		

Table 2 Labeling of Genetically Modified Foods in Japan

	Classification	Labeling Example	Labeling	
1	Produce whose composition and nutritional value are similar to that of conventional produce			
	(1) Agricultural products and processed foods containing genetically modified DNA or resulting protein even after processing (corresponding to 7 agricultural products and 32 processed food categories in Table 1)	GM agricultural products under the identity preserved handling or processed foods made from those	"GMO segregated from non-GMO", "GMO"	Mandatory
		Agricultural products, not segregated GM products and non-GM products, or processed foods made from those the identity preserved handling ² or processed foods made from those	"Not segregated from GMO"	Mandatory
		non-GM agricultural products under the identity preserved handling or processed foods made from those	"Non-GMO segregated from GMO", "Non-GMO"	Voluntary
	(2) Processed foods in which genetically modified DNA or resulting protein does not remain after processing (e.g., soybean oil, soy source, corn oil, isomerized liquid sugar)	"Non-GMO segregated from GMO", "Non-GMO"	Voluntary	
2	Produce whose composition or nutritional value is markedly different from that of conventional produce (high oleic acid soybeans, high lysine corn)	"soybeans (high oleic, genetically modified)"	Mandatory	

4. Testing and Analysis of Genetically Modified Foods in Japan

The standard tests and methods used for analysis of genetically modified foods are specified in "Testing for Foods Produced by Recombinant DNA Techniques"¹⁾, notifications concerning inspection and guidance of imported foods^{2) - 5)} by The Ministry of Health, Labour and Welfare, and "JAS analytical test handbook"⁶⁾ by Food and Agricultural Materials Inspection Center.

Table 3 shows the genetically modified foods that are subject to testing, and test methods to be used. Both approved and unapproved genetically modified foods based on safety assessment are subject to the testing.

As of July, 2010, papaya (55-1), corn (CBH351), corn (Bt10),

corn (DAS59132), rice (LLRICE601), rice (Bt), and rapeseed (RT73 B.rapa) have not been unapproved by the safety assessment.

The tests can be classified to qualitative testing to determine the presence or absence of genetically modified organisms (GMO) and quantitative testing to determine the ratio of genetically modified organisms to non-genetically modified organisms (GMO content). The methods adopted for qualitative testing include lateral flow immunoassay, qualitative PCR, and the GUS gene test, while quantitative PCR and ELISA (enzyme-linked immunosorbent assay) are adopted for quantitative testing.

Table 3 Testing Methods for Genetically Modified Foods in Japan

Food Product	Genetically Modified Gene	Test Type	Test Method	References
Papaya (raw or processed)	Papaya (55-1)	Qualitative test	Qualitative PCR, GUS gene test	1)
Corn (grain)	Corn (CBH351)		Lateral flow immunoassay	
Corn (partially processed)			Lateral flow immunoassay, Qualitative PCR	
Corn (processed)				
Corn (grain)				
Corn (partially processed)	Corn (Bt10)		Qualitative PCR	
Corn (grain)	Corn (DAS59132)			
Corn	Corn (GA21)	Quantitative test or Qualitative test / Quantitative test	Quantitative PCR Qualitative PCR / Quantitative PCR	1) 6)
	Corn (Event176)			
	Corn (Bt11)			
	Corn (T25)			
	Corn (Mon810)			
Soybean	Soybean (Roundup Ready Soybean)	Quantitative test or Qualitative test / Quantitative test	Quantitative PCR Qualitative PCR / Quantitative PCR	1) 6)
Soybean	CP4EPSPS protein	Quantitative test	ELISA	1)
Rice	Rice (LLRICE601)	Qualitative test	Qualitative PCR	3)
Rice	Rice (Bt)			4)
Rapeseed	Rapeseed (RT73 B.rapa)			5)
Potato	Potato (New Leaf)			6)
	Potato (New Leaf Plus)			

[References]

- 1) The Ministry of Health, Labour and Welfare, Japan, "Testing for Foods Produced by Recombinant DNA Techniques", <http://www.mhlw.go.jp/english/topics/food/sec05-1a.html>
- 2) <http://www.mhlw.go.jp/english/topics/importedfoods/index.html>
- 3) Department of Food Safety, The Ministry of Health, Labour and Welfare, Japan, Notification No. 0915002, September 15, 2006.
- 4) Department of Food Safety, The Ministry of Health, Labour and Welfare, Japan, Notification No. 0220002, February 20, 2007.
- 5) Department of Food Safety, The Ministry of Health, Labour and Welfare, Japan Notification No. 0914 -5, September 14, 2009.
- 6) "Japanese Agricultural Standard (JAS) analytical test handbook: genetically modified food quality, labeling analysis manual for individual products, 2nd revision (2002)", Food and Agricultural Materials Inspection Center, Japan.

Table 4 presents an overview of analysis methods for testing genetically modified foods. Since the ELISA and lateral flow immunoassay methods are based on antigen-antibody reactions, they are not applicable to testing for processed foods because antigenicity is lost due to protein denaturation during heat processing, etc. DNA exhibits superior stability to protein because DNA has better thermal stability and is more tolerant to decomposition and denaturation upon heating or other processes.

On the other hand, qualitative PCR is applicable for testing of both agricultural products and processed foods due to the high possibility of target gene amplification by PCR. However, quantitative PCR cannot be applied to determination of recombinant gene content in processed foods, as discussed later in this document.

Table 4 Analysis Methods Used for Testing Genetically Modified Foods

Analysis Method	Overview
ELISA (Enzyme-Linked Immunosorbent Assay)	It is used for quantitative analysis or qualitative analysis (detection) of antigens and antibodies in a sample. It utilizes the high specificity of the antigen-antibody reaction and the high sensitivity of enzymatic reactions.
Lateral Flow Immunoassay	This is one type of immunochromatography that uses the antigen-antibody reaction as in the ELISA method. Here, a drop of sample is applied to a test strip, and as it migrates along the strip by capillary action, the presence or absence of an antigen in the sample is determined based on comparison of the color patterns in the test line and a control line. When the a sample including the target antigen passes through a zone including dyed antigen-specific antibodies, complex between antigen in the sample and dyed antibody (antigen- dyed antibody complex) is formed. Antigen-specific antibody is fixed in the test line zone, and it binds to the antigen- dyed antibody complex. The control line includes an antibody that binds dyed-antibody. If antigen is present in the sample, both the test line and control line are colored. If there are no antigens present in the sample, only the control line is colored.
GUS Gene Test	A β -glucuronidase (GUS) gene might be introduced along with an exogenous gene for use as an indicator (reporter) of genetic recombination. In this type of gene recombination, the GUS gene is expressed along with the recombinant gene, making it possible to confirm the success of recombination process based on the presence or absence of GUS activity. In the GUS gene test, the reagent containing the substrate 5-bromo-4-chloro-3-indolyl- β -D-glucuronide (X-Gluc) is added, and GUS activity is confirmed by the appearance of blue coloring.
Qualitative PCR	PCR (Polymerase Chain Reaction) is a technique in which a specific region of a DNA from template DNA is selectively amplified. In PCR, two single chain DNA fragments (primer pair) which are complimentary to both ends of the specific region to be amplified are used. An enzyme for DNA synthesis (DNA polymerase) is also added to reaction tube and a cycle reaction (dissociation of double-strand DNA to single-strand DNA (Denaturation) \rightarrow primers binding to each strand (Annealing) \rightarrow DNA synthesis (Elongation) is repeated to amplify the specific gene region selectively. Thus, in principle, the specific gene region is amplified by a factor of 2 during each reaction cycle. In qualitative PCR, PCR is conducted to detect a target gene region included in a DNA template extracted from the sample, and the obtained amplification product (PCR product) is subjected to electrophoretic analysis. If the target gene region is included in the extracted DNA, the PCR product corresponding to the target gene region will be detected.
Quantitative PCR	In quantitative PCR, PCR is conducted to amplify the specific gene region using a template DNA extracted from a sample and its amplification process is monitored just-timely. A fluorescent compound (intercalator) which can bind with double-stranded DNA, or a fluorescent marker probe to enable recognition of a specific part of the amplification region is added to allow monitoring of the amplification products at each cycle. Analysis of the obtained amplification curve allows determination of the quantity (number of copies) of the target genes.

Fig. 1 shows an example of the procedure used for analysis of genetically modified food using qualitative PCR. The sample is pulverized, and the DNA is extracted using an extraction kit. The DNA concentration of the extracted DNA is determined using the BioSpec-nano Ultraviolet-Visible spectrophotometer for life sciences, and PCR is conducted using a specified quantity of extracted DNA as the template. Electrophoretic analysis of the obtained PCR products is conducted using the 'MCE-202' MultiNA microchip electrophoresis system, and the presence or absence of PCR products corresponding to the target region is confirmed.

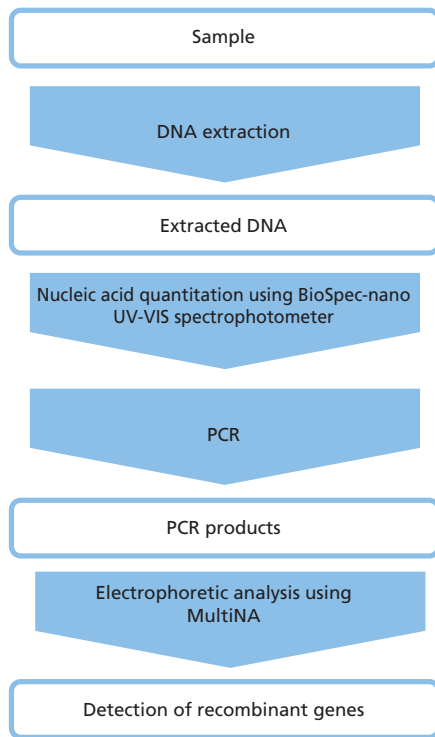

Fig. 1 Example of Procedure for Analysis of Genetically Modified Food by Qualitative PCR

Due to extremely high analysis sensitivity, qualitative PCR can detect even minute levels of modified genes in extracted DNA. When Identity preserved handling is implemented, the permissible genetically modified organism (GMO) content to non-GMO is 5 %.

However, recombinant gene is often detected even though the GMO content is below 5 %. When recombinant DNA is detected by qualitative PCR, quantitative PCR testing will be conducted to determine the GMO content. DNA extracted from the sample is used as the template in quantitative PCR, and PCR is conducted using a primer to detect recombinant and endogenous genes.

The number of copies of recombinant and endogenous genes in the extracted DNA can be determined by analysis of the quantitative PCR amplification curve. The GMO content and internal standard ratio are defined according to Equation 1 and 2, respectively. When the content of genetically modified species exceeds 5 % in identity preserved handling foods labeled as "non-GM (non-Genetically Modified)" or "Non-GM segregated from GM", a close inspection of the identity preserved handling is necessary. It should be mentioned that since the degradation rates of recombinant genes and endogenous genes are not necessarily same in processed food, obtaining the GMO content accurately by quantitative PCR method is impossible.

$\text{GMO content (\%)} = \left(\frac{\text{number of copies of the recombinant gene}}{\text{number of copies of internal standard genes}} \right) \times \left(\frac{1}{\text{Internal standard ratio}} \right) \times 100$	(Equation 1)
$\text{Internal standard ratio} = \left(\frac{\text{Number of recombinant gene in pure genetically modified agriculture product}}{\text{Number of internal gene in pure genetically modified agriculture product}} \right)$	(Equation 2)

[Reference]

"Japanese Agricultural Standard (JAS) analytical test handbook: genetically modified food quality, labeling analysis manual for individual products, 2nd revision(2002)", Food and Agricultural Materials Inspection Center, Japan.

5. Introduction of Tools for Optimizing Inspection and Analysis of Foods by Qualitative PCR

MCE-202 MultiNA Microchip Electrophoresis System

Agarose gel electrophoretic analysis requires a great deal of time and effort to conduct a series of operations including the mixing of reagents, preparing the gel, conducting electrophoresis, acquiring an image of the results, and post-cleanup. In addition, its data has a tendency to show inferior

sensitivity, resolution and quantitation performance.

The MCE-202 MultiNA microchip electrophoresis system solves these problems of agarose gel electrophoresis all at once since the system is based on brand-new, superior platform and fully automated.



Fig. 2 MultiNA

MultiNA Features

High Analysis Performance

Compared with agarose gel electrophoresis, the microchip electrophoretic analysis with the MultiNA delivers excellent sensitivity, separation, repeatability and quantitation performance.

Automated Operation for up to 120 Analyses

Simply set up the samples and the separation buffer for automated analysis of up to 120 analyses. The parallel processing for analysis pretreatment and electrophoresis permits a processing speed of just 80 seconds per analysis.¹⁾

Maximum Ease of Use

Analysis operation with the MultiNA is extremely simple. Just set up the analysis schedule, and then simply load the reagents and samples and click the [Start] button.

Reduce Analysis Costs

The reusable, high-performance microchip achieves lower running costs per analysis than agarose gel electrophoresis.

¹⁾ When 4 microchips are used in DNA standard analysis (for example, DNA-1000 Kit / Premix mode), this does not include the time required for the initial rinse and final rinse, and the initial analysis.

BioSpec-nano UV-VIS Spectrophotometer for Life Sciences

To successfully guide the PCR reaction to completion, confirming the DNA concentration of the extracted DNA and checking of DNA purity using OD ratio (OD₂₆₀/OD₂₈₀) are indispensable. Conducting analysis with UV-VIS spectrophotometers which use conventional cuvettes is both labor intensive and time consuming due to the required rinsing and drying of the cuvettes.

The BioSpec-nano, which incorporates a cuvette-free optical system, an innovative, automatic mounting mechanism, and an automatic wiping mechanism, offers simple fast and simple nucleic acid analysis of 1 to 2 μ L samples. High throughput analysis is achieved, requiring a mere 15 seconds to complete one analysis.



Fig. 3 BioSpec-nano

BioSpec-nano Features

Drop and Click Analysis

DNA concentration and purity can be checked by just dropping the sample on the target, and clicking the button. Measurement and wiping are both handled automatically by the instrument.

Nucleic Acid Quantitation of 1 to 2 μ L Samples

Sample volumes of 1 μ L (0.2 mm optical path length) and 2 μ L (0.7 mm optical path length) can be measured.

Simple and Quick Analysis

Blank measurement, sample measurement, report output in PDF or CSV format, and other basic operations are conducted simply and quickly just by clicking a button.

Support for Wide Range of Analyses

Nucleic acid quantitation, quantitation of nucleic acid labeled for micro-array, protein quantitation by OD₂₈₀, and labeled protein quantitation are all supported.

6. Examples of Qualitative PCR Analysis of Genetically Modified Foods Using the MultiNA

6.1 Analysis of Genetically Modified Corn (MON810)

Here we introduce an analysis of genetically modified corn (MON810) as an example of genetically modified food analysis. After extracting DNA from 3 powdered samples consisting of genetically modified corn (MON810) having GMO content of 0 %, 1 % and 5 %, respectively, the extracted DNA from each of the samples was used as a template. PCR was then conducted using a primer for endogenous gene *SSIIb-3* detection²⁾ and a primer for the genetically modified MON810 detection³⁾. The electrophoretic analysis of PCR product using the MultiNA are shown in Fig. 4. In analysis of the PCR products using the primer for the endogenous gene *SSIIb-3* detection, the PCR product (114

bp) corresponding to *SSIIb-3* was detected in all of the samples except for the negative control. The endogenous gene *SSIIb-3* is a gene that is specific to corn, and detection of the endogenous gene in a sample means PCR testing of the recombinant gene in that sample is effective. On the other hand, in analysis of the PCR products using the primer for the genetically modified MON810 detection, the PCR product (113 bp) corresponding to MON810 was detected in the 1 % and 5 % GMO content samples, as well as in the positive control sample.

Gel Image

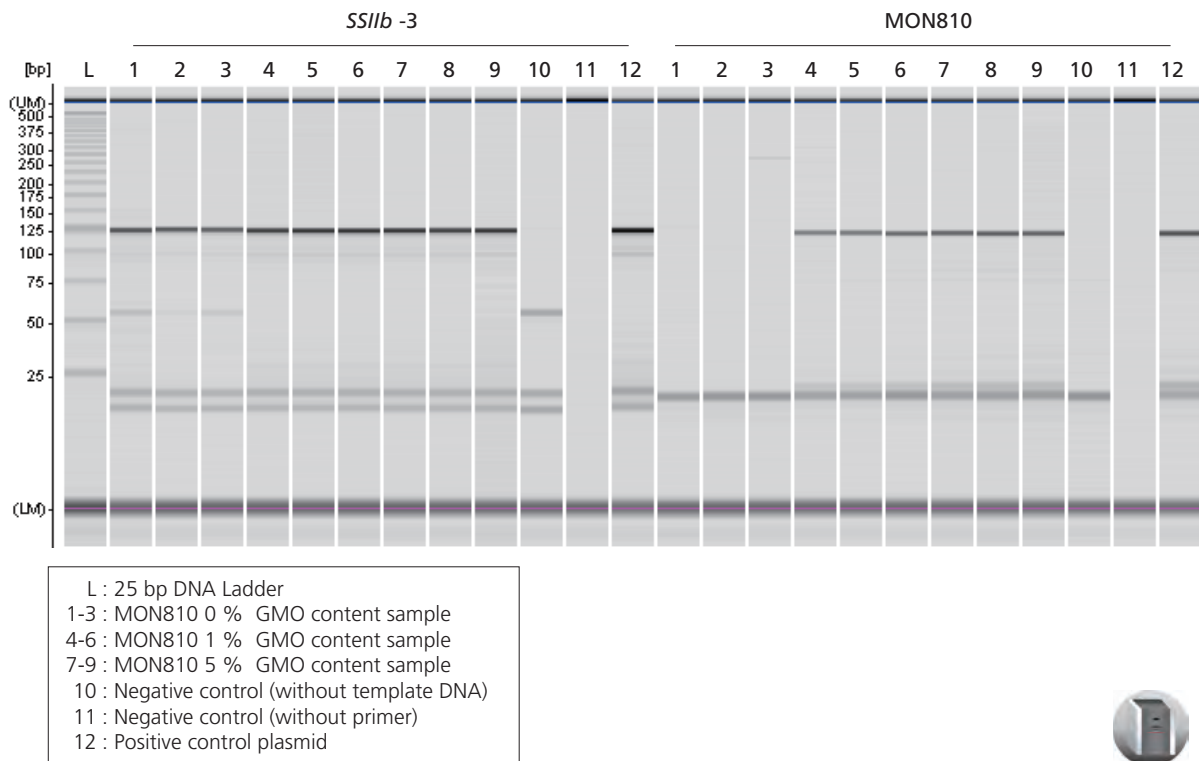

Fig. 4 Analysis of Genetically Modified Corn (MON810) Using MultiNA

[References]

- 1) Shimadzu Application News No. B29, Qualitative Analysis of Genetically Modified Corn by Standard Method with MCE-202 "MultiNA"
- 2) The Ministry of Health, Labour and Welfare, Japan, "Testing for Foods Produced by Recombinant DNA Techniques", <http://www.mhlw.go.jp/english/topics/food/sec05-1a.html>
- 3) "Japanese Agricultural Standard (JAS) analytical test handbook: genetically modified food quality, labeling analysis manual for individual products, 2nd revision (2002)", Food and Agricultural Materials Inspection Center, Japan.

6.2 Detection of Genetically Modified DNA (GA21) in Processed Corn

Here we introduce an example of analysis of genetically modified DNA in processed corn using qualitative PCR. DNA was extracted from 4 types of processed corn products (2 types of canned corn, 1 type of popcorn, 1 type of corn starch), and the DNA extracted from each of the samples was used as a template. PCR was conducted using a primer for the endogenous gene *SSI1b* detection and a primer for the genetically modified GA21 detection. Next, the obtained PCR products were analyzed using the MultiNA. The analysis results are shown in Fig. 5. In PCR using the primer for the endogenous gene *SSI1b* detection, the PCR product (151 bp) corresponding to *SSI1b* was detected in all of the processed food samples and in the positive control plasmid. If damage to DNA derived from processed food is considerable due to heating during processing, the endogenous genes will not be

detected. In samples where the endogenous gene is not detected, qualitative testing for genetically modified genes in these samples is regarded as invalid. On the other hand, in analysis of the PCR products using the primer for the genetically modified GA21 detection, the PCR product (133 bp) corresponding to GA21 was detected only in the positive control plasmid, and was not detected in the 4 types of processed food samples, which were labeled as "Non-GMO"

As shown in the electropherograms of the negative and positive controls, the *SSI1b* gene (151 bp) and GA21 gene (133 bp) are clearly detected using only 20 copies of the positive control plasmid. Thus, high-sensitivity qualitative PCR analysis of genetically modified food is clearly achieved using the MultiNA.

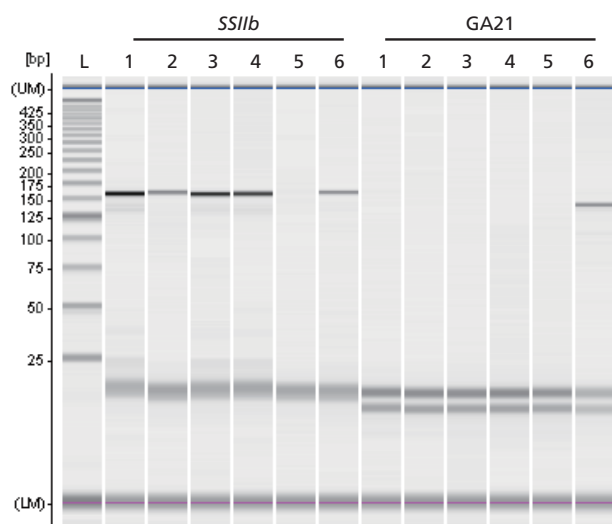

Gel Image

L : 25 bp DNA Ladder
 1-4 : 4 types of processed corn food samples
 5 : Negative control (without template DNA)
 6 : Positive control plasmid (20 copies)

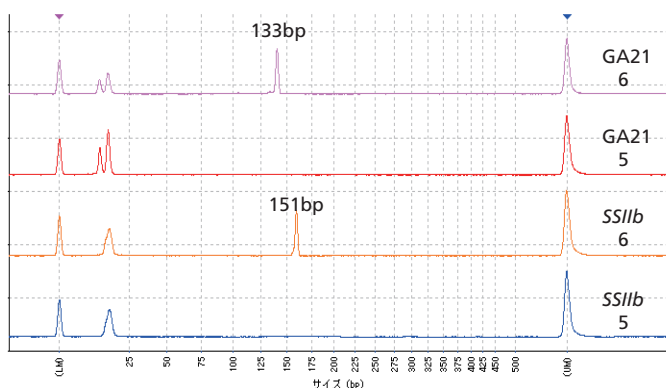

Electropherograms

5 : Negative control (without template DNA)
 6 : Positive control plasmid (20 copies)

Fig. 5 Analysis of Genetically Modified Gene (GA21) in Processed Corn Food Products Using MultiNA

[Reference]

"Japanese Agricultural Standard (JAS) analytical test handbook: genetically modified food quality, labeling analysis manual for individual products, 2nd revision (2002)", Food and Agricultural Materials Inspection Center, Japan.

6.3 Analysis of Genetically Modified Foods Unapproved by Safety Assessment in Japan

Some genetically modified foods that are unapproved by Japanese safety assessment, are permitted to be circulated in global market.

These particular foods are subject to qualitative inspection in Japan (Table 3). Positive control plasmids and primers according to official inspection methods are commercially available, making it possible to conduct analysis for modified DNA in these foods by the qualitative PCR method.

Examples of analysis of 3 types of modified DNA that were unapproved by the safety inspection as of July, 2010, including corn (CBH351)¹⁾, papaya (55-1)¹⁾, and rice (Bt)²⁾, are shown below. PCR was conducted using the respective positive control plasmids as templates, and the primers specified in the respective test methods for detection and identification. The obtained PCR products were analyzed using the MultiNA, and the results shown in Fig. 6 were obtained. The PCR products corresponding to the respective target genes and the primers can be verified.

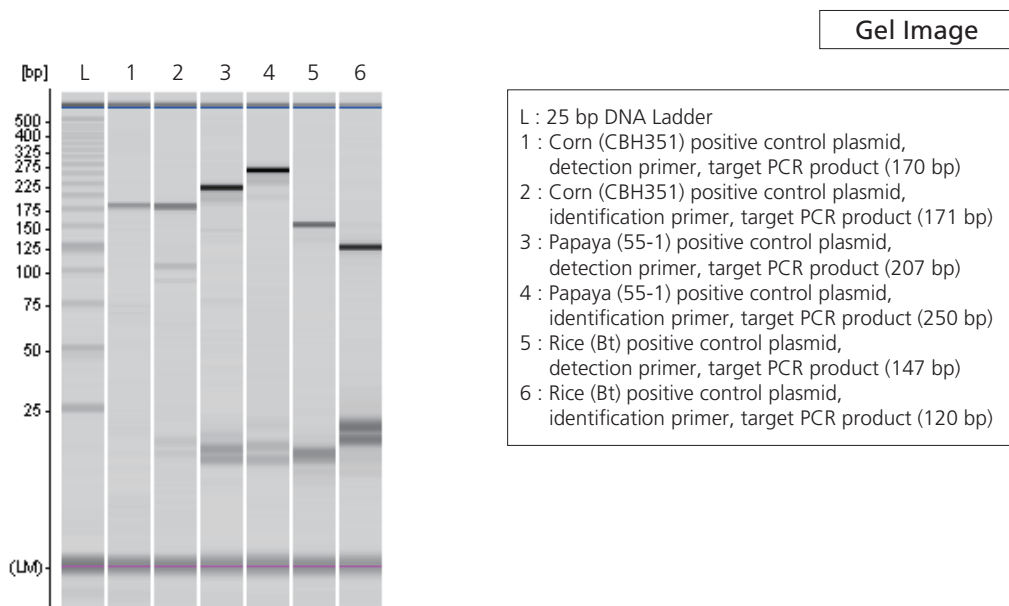

Fig. 6 Analysis of Genetically Modified Corn (CBH351), Papaya (55-1), Rice (Bt) using MultiNA

[References]

- 1) The Ministry of Health, Labour and Welfare, Japan, "Testing for Foods Produced by Recombinant DNA Techniques", <http://www.mhlw.go.jp/english/topics/food/sec05-1a.html>
- 2) Department of Food Safety, The Ministry of Health, Labour and Welfare, Japan, Notification No. 0220002 of February 20, 2007.

MCE®-202 MultiNA is not available in the United States.

*This document is based on information valid at the time of publication. It may be changed without notice.

First Edition: November, 2012



Shimadzu Corporation

www.shimadzu.com/an/

For Research Use Only. Not for use in diagnostic procedures.

The content of this publication shall not be reproduced, altered or sold for any commercial purpose without the written approval of Shimadzu. The information contained herein is provided to you "as is" without warranty of any kind including without limitation warranties as to its accuracy or completeness. Shimadzu does not assume any responsibility or liability for any damage, whether direct or indirect, relating to the use of this publication. This publication is based upon the information available to Shimadzu on or before the date of publication, and subject to change without notice.

© Shimadzu Corporation, 2012

Application News

No. AD-0162

Halal Authentication Analysis / IRTracer-100

Quantitative Determination of Lard Adulteration by FTIR Spectroscopy with Chemometrics Method - Vegetable Palm Oil

Zhen Hao Lee, Jia Sheng Kuek*, Joyce Lim, Ai Ming Chua

Application Development & Support Centre, Shimadzu (Asia Pacific) Pte Ltd, Singapore

*ITS Student from Nanyang Technological University, Singapore

□ Introduction

Food adulteration is a persistent problem which could occur either accidentally or intentionally. Among the food products, edible oil is the most prone to adulteration [1] and this poses a major concern in terms of economical and religious point of view. For example, the Islamic law prohibits Muslims from consuming pork in any form, including lard in food products [2]. Therefore, it is necessary to develop analytical techniques to identify and quantify lard adulterated edible oil.

Fourier Transform Infrared (FTIR) spectroscopy is an effective technique to differentiate fats and oils as different compounds have unique fingerprint region in the infrared (IR) region. FTIR spectroscopy in combination with chemometrics data analysis such as multi-linear regression (MLR) or partial least squares (PLS) regression is a fast and simultaneous quantitative analysis of multi-component. In this application news, we introduce a method for quantitative determination of lard adulterated vegetable palm oil using FTIR spectroscopy and PLS quantitative calibration model.

□ Experimental

Pork lard and commercially available palm oil were purchased from local markets. The lard was extracted based on the procedure by Rohman and Che Man [3]. Adipose tissue of pork was cut into small pieces and heated at 90-100°C for 2 hours. The melted fat was strained through sieve cloth and dried by addition of anhydrous Na₂SO₄. The extracted fat was centrifuged at 3000 rpm and for 20 minutes at 30°C. The fat layer was decanted and centrifuged again, followed by filtering through filter paper to remove solid residue.

A set of 13 standards containing 1-90% (w/w) lard in palm oil was prepared. A PLS calibration model for lard was established with 11 of these standards using LabSolutions IR workstation with Chemometrics PLS

function. The remaining 2 standards were used as samples for quantitative determination.

The sample was measured with horizontal type attenuated total reflection attachment (HATR) with zinc selenide (ZnSe) prism. Each sample was measured 3 times. The IR spectra were acquired in the wavenumber range from 4000 cm⁻¹ to 650 cm⁻¹. The measurement conditions are shown in Table 1.

Table 1: Instruments and Analytical Conditions

Instruments	: IRTracer-100, ATR-8200H (ZnSe)
Resolution	: 4.0 cm ⁻¹
Accumulation	: 45
Apodization	: Happ-Genzel
Detector	: DLATGS

□ Results and Discussion

Figure 1 shows the IR spectra of palm oil, lard and 50% w/w lard in palm oil. The IR spectra for palm oil and lard were quite similar. This is due to the similar chemical compositions between palm oil and lard. A closer examination of the IR region in the range of 1500-1000 cm⁻¹ revealed slight differences in terms of peak intensities ratio at around 1160 cm⁻¹, 1117 cm⁻¹ and 1097 cm⁻¹ as marked by arrows in the overlay spectrum of palm oil and lard (Figure 2).

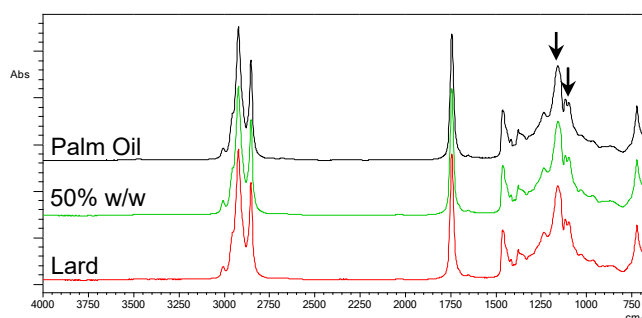

Figure 1: IR spectra of palm oil, lard and 50% w/w lard in palm oil.

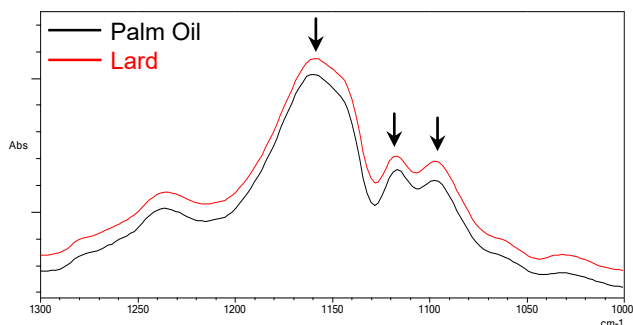

Figure 2: Overlay spectrum of lard and palm oil

Second derivative spectra were used in the PLS data analysis for better resolution of overlapping and shoulder peaks. Table 2 and Figure 3 show the PLS calibration parameter and result of lard in palm oil. A good square correlation coefficients of more than 0.999 was obtained for the PLS calibration modelling with low Mean Squared Error of Prediction (MSEP) and Standard Error of Prediction (SEP) as shown in Table 2.

Table 2: PLS calibration parameters of lard in palm oil

Calibration Table	
Algorithm	PLS I
Number of references	33 (three measurement per sample)
Range (cm ⁻¹)	1000 – 1490
Pre-process	Derivative, Order = 2, Points = 15
Scale	Autoscale
Number of factors	5
Square of correlation coefficient (R ²)	0.9993
MSEP	0.0007
SEP	0.0258

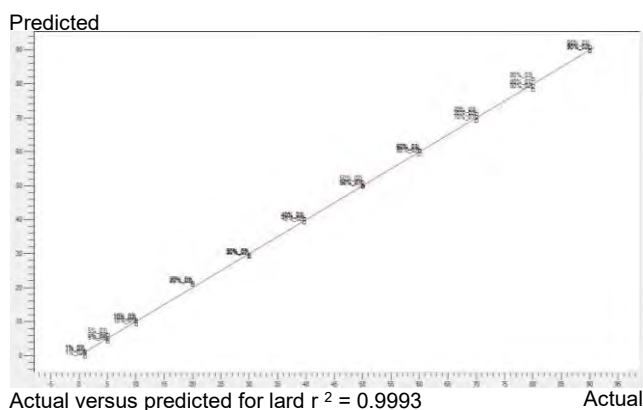

Figure 3: PLS calibration for lard predicted versus actual values.

Table 3 shows the quantitation results of lard in various types of edible oils by PLS method. The measurement results are within $\pm 10\%$ of the expected values for lard in palm oil. For lard in olive oil and palm soy oil, the mean predicted values differed greatly from the expected values. This is due to the difference in sample matrix of the edible oils.

Table 3: Predicted values of lard in different edible oils

Edible Oil	Brand A Palm Oil		Brand B Palm Oil		Olive Oil	Palm Soy Oil
	8.0	25.0	8.0	25.0		
Expected Value (% w/w)	8.0	25.0	8.0	25.0	25.0	25.0
Predicted Value (% w/w)	1	8.90	24.08	9.06	26.1	64.41
	2	8.24	23.54	7.60	25.82	64.56
	3	8.60	24.43	8.36	26.18	62.95
	Mean	8.58	24.02	8.34	26.03	63.97
Recovery (%)	107.2	96.1	104.2	104.1	255.9	130.8

Conclusions

FTIR spectroscopy in combination with PLS data analysis is a rapid technique which has potential in determination of lard adulteration in palm oil without excessive sample pre-treatment. In this application news, a percentage of verification sample within $\pm 10\%$ of the expected value was obtained. For lard adulteration in other types of edible oils, respective PLS calibration models have to be prepared to account for the difference in sample matrix.

References

1. Johnson, R. (2014). Food Fraud and economically motivated adulteration of food and food ingredients. Congressional Research Services R43358, 1–40.
2. Regenstein, J. M., Chaudry, M. M. and Regenstein, C.E. (2003). The kosher and halal food laws. Comprehensive Reviews in Food Science Food Safety 2: 111–127.
3. Rohman, A. and Che Man, Y. B. (2009). Analysis of cod-liver oil adulteration using FTIR spectroscopy. Journal of the American Oil Chemists' Society 86: 1149–1153.

An Ultrafast LC/MS/MS Method for Characterization and Quantitation of Triton X-100 Extracted From Palm Oil

ASMS 2017 TP 712

Udi Jumhawan, Jie Xing and Zhaoqi Zhan
Application Development & Support Centre,
Shimadzu (Asia Pacific) Pte Ltd, 79 Science Park Drive,
Singapore

An Ultrafast LC/MS/MS Method for Characterization and Quantitation of Triton X-100 Extracted From Palm Oil

Introduction

Triton X-100, oligomers of octylphenol ethoxylate (OPEOn), is predominantly used as detergent in laboratory, industry and household [1]. The chain lengths of ethoxy units (n) of the oligomers ranged from 0 to 20 (Figure 1). Analysis of octylphenol ethoxylates by GC, HPLC and LC/MS methods were reported previously for monitoring the residues in river and wastewater due to their potential toxicity towards aquatic ecosystem [2-4]. In the last decade, oil-bearing crops has gained much attention for use as a raw material for biofuel. Palm oil (*Elais guineensis*) is one of the

commercialized and most profitable oil-bearing crops to date. It has been widely used as a traditional cooking oil in Southeast Asia and Africa and commonly found in processed food, makeup, toothpaste and cleaning products. There is inquiry recently if Triton X-100 is present in edible palm oil and food products due to its involvement in the extraction process for palm oil production. We describe here an ultrafast LC/MS/MS method for sensitive analysis of Triton X-100 in palm oil samples.

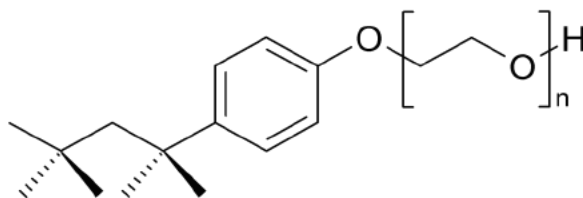

Figure 1. Chemical structure of the octylphenol ethoxylates (OPEOn) investigated in this study.

Experimental

Triton X-100 standard was acquired from Sigma Aldrich. An edible palm oil was obtained from local supermarket and utilized as matrix for method development. A customized liquid-liquid extraction (LLE) using

acetonitrile-saturated hexane (1:1, v/v) was employed for the extraction of Triton X-100. The sample pretreatment procedure and LC/MS/MS method are described in Figure 2 and Table 1, respectively.

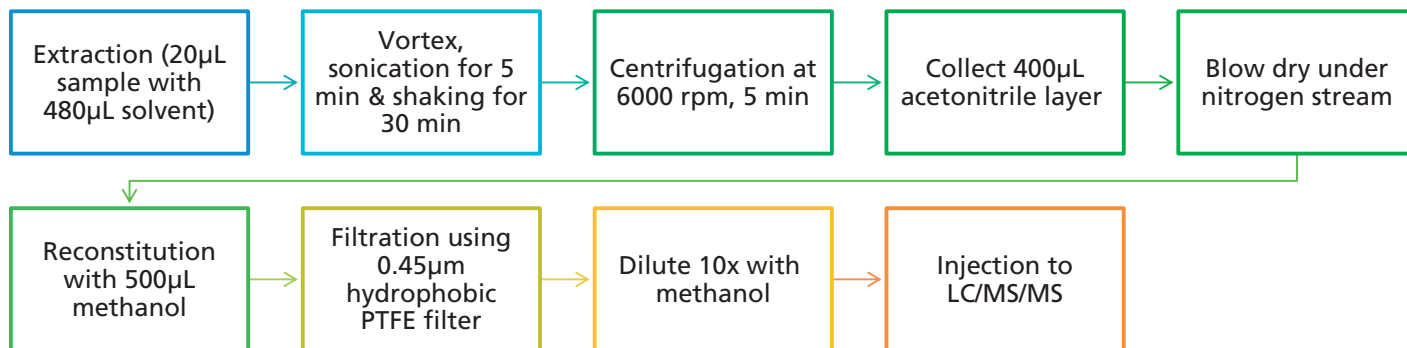

Figure 2. Flow chart of sample pretreatment.

An Ultrafast LC/MS/MS Method for Characterization and Quantitation of Triton X-100 Extracted From Palm Oil

Table 1. Analytical conditions of Triton X-100 on LCMS-8060.

Column	: Kinetex C18 100Å (50 x 2.1 mm, 1.7 µm)
Flow rate	: 0.3 mL/min
Mobile phase	: A: Water with 2mM ammonium acetate B: Acetonitrile with 2mM ammonium acetate
Elution mode	: Gradient elution, 0min (50% B) → 0.01-2.5mins (100% B) → 2.51-3.00mins (100% B) → 3.01-3.50mins (50% B) → 3.51-5.00 mins (50% B)
Oven temp.	: 30 °C
Injection vol.	: 5.0 µL
Interface & temp.	: ESI, 300 °C
MS mode	: Positive, MRM
Block temp.	: 400 °C
DL temp.	: 250 °C
CID gas	: Ar (270 kPa)
Nebulizing gas flow	: N ₂ , 2 L/min
Drying gas flow	: N ₂ , 15 L/min
Heating gas flow	: 0 air, 10 L/min

Results and Discussion

Development of LC/MS/MS method

A MRM-based method for quantitation of Triton X-100 was developed. The OPEOn species forms ammonia adduct ion $[M+NH_4]^+$ under the mobile phase and ESI conditions. Using an automated MRM optimization program on LCMS-8060, each OPEOn adduct ion was subjected to optimize for highest intensity for every MRM transition. It was observed that the most intensive MRM transition of OPEOn species ($n = 3\sim 20$) is not the transition losing ammonia. Two MRM transitions were selected for each

OPEOn species, with the higher intensity one as the quantifier (Table 2) and the other for confirmation. A total of eighteen species of OPEOn with $n = 3\sim 20$ were analysed. A characteristic pattern of peak distribution with OPEO8 peak highest is observed. The RT of the species decreases with the number of ethoxy units (n). The total MRM chromatograms (sum of two MRMs for each species) of the 18 OPEOn are displayed in Figure 3.

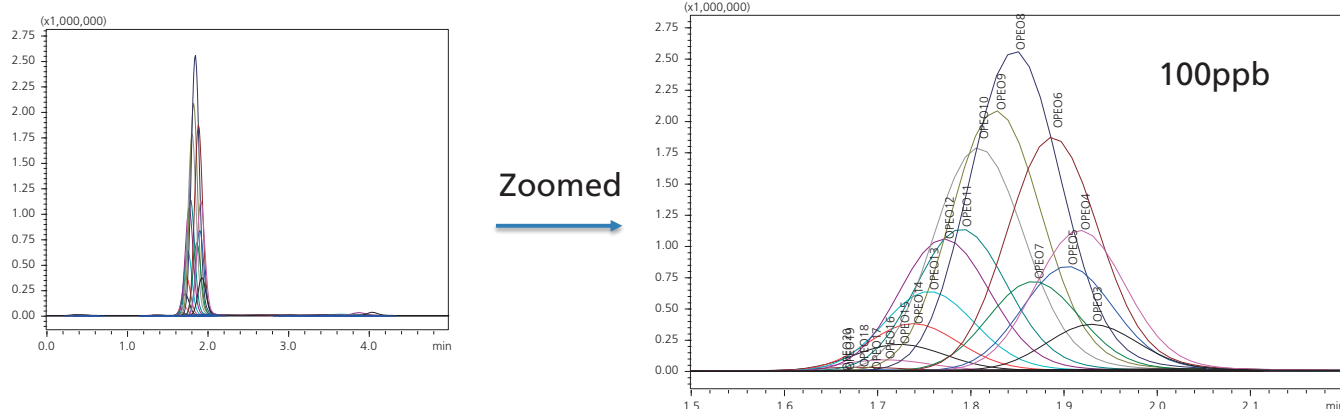

Figure 3. Total MRM chromatograms (each is the sum of two individual MRMs of the OPEOn) of 18 species of Triton X-100 standard ($n = 3\sim 20$) at 100 ppb.

An Ultrafast LC/MS/MS Method for Characterization and Quantitation of Triton X-100 Extracted From Palm Oil

Quantitation performance with edible palm oil spiked sample

The MRM-based calibration curves (Figure 4) was established with palm oil spiked samples. Effective extraction of the OPEOn from palm oil matrix was found challenging in the study. Various extraction procedures including LLE, solid phase extraction (SPE) and dispersive SPE (dSPE) were applied and compared to extract Triton X-100 from palm oil. The extraction efficiency was

determined with spiked samples. Triton X-100 standard dissolved in methanol was spiked into palm oil at low, mid, and high concentrations (8, 40 and 80 ppb). A LLE with acetonitrile-saturated with hexane (1:1, v/v) produced the best recovery ranged from 74.4 to 127.8% and without severe matrix effect (75.5 to 136.6%).

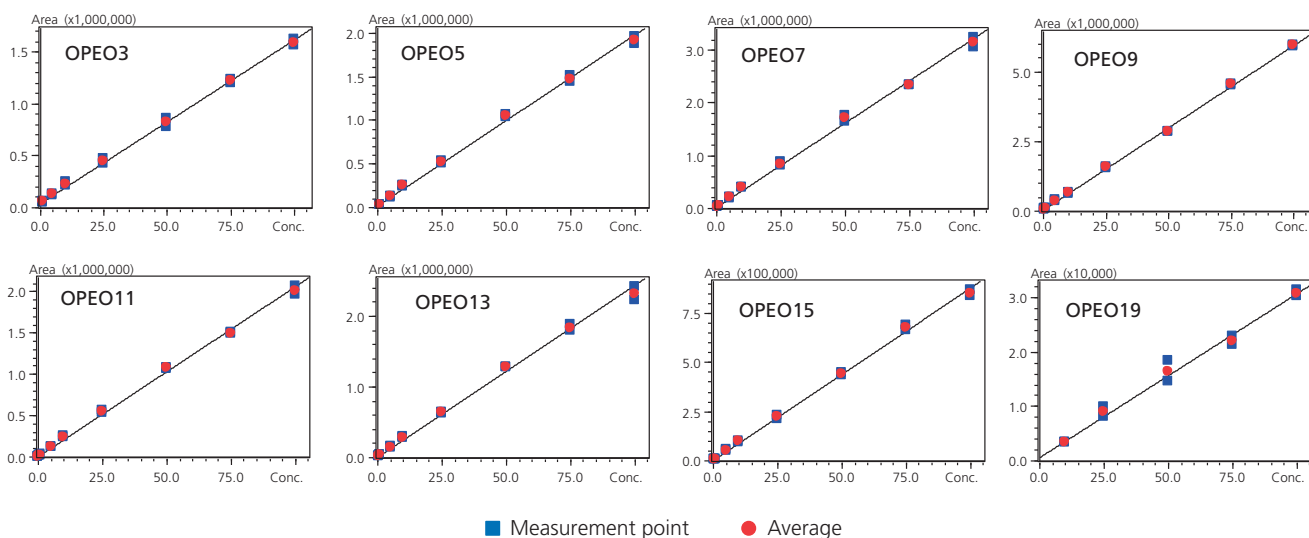

Figure 4. Representative calibration curves of OPEO species in oil matrix (two replications, $n=2$).

The calibration curves were built using palm oil matrix spiked with Triton X-100 standard. Linear relationship with $R^2 \geq 0.994$ were obtained for all OPEO species across minimum five quantitation points from 0.5 or 1 ppb to 100 ppb for most OPEO species except for the species of $n = 17, 19$ and 20 (Table 2).

Most of the OPEO species exhibited a detection limit (LOD) based upon $S/N > 3$ in the range of 0.02~0.8 ng/mL level and a quantitation limit (LOQ) method based

upon $S/N > 10$ of approximately lower than 3 ng/mL, except for OPEO17, OPEO19, and OPEO20. The reduced sensitivity for OPEO with a higher number of ethoxy units is probably because of poorer ionization and fragmentation efficiency of the molecules. The repeatability of the method was evaluated at 50 ppb for all OPEO species. The RSD of most species were under 8% across six repetitive injections, except for three OPEO species (OPEO17, 19, &20). The results are summarized in Table 2.

An Ultrafast LC/MS/MS Method for Characterization and Quantitation of Triton X-100 Extracted From Palm Oil

Table 2. Calibration results of Triton X-100 standard in edible palm oil matrix (two replications, $n=2$).

No	Triton X-100 species	MRM transition for quantitation	RT (min)	LOQ (ppb)	LOD (ppb)	Range (ppb)	Linearity (R^2)	Repeatability at 50 ppb*	
								Area RSD (%)	Conc. RSD (%)
1	OPEO3	365.25>227.15	1.93	0.21	0.07	1-100	0.998	6.09	6.35
2	OPEO4	400.25>271.10	1.92	1.25	0.41	1-100	0.999	3.97	4.04
3	OPEO5	444.25>133.05	1.91	1.29	0.43	1-100	0.997	3.63	3.68
4	OPEO6	488.25>471.25	1.89	0.65	0.22	1-100	0.997	1.79	1.81
5	OPEO7	532.35>277.20	1.87	0.81	0.53	0.5-100	0.997	4.75	4.79
6	OPEO8	576.35>559.35	1.85	0.85	0.28	0.5-100	0.998	2.93	2.95
7	OPEO9	620.40>603.40	1.83	0.59	0.2	0.5-100	0.998	4.66	4.7
8	OPEO10	664.40>133.10	1.81	0.07	0.035	0.5-100	0.998	5.52	5.55
9	OPEO11	708.40>177.10	1.79	0.06	0.02	0.1-100	0.997	3.07	3.08
10	OPEO12	752.45>133.05	1.78	0.09	0.03	0.5-100	0.997	3.72	3.75
11	OPEO13	796.50>133.00	1.76	0.67	0.22	0.5-100	0.997	4.3	4.3
12	OPEO14	840.50>133.10	1.74	0.64	0.21	0.5-100	0.997	3.38	3.4
13	OPEO15	884.55>133.05	1.75	2.17	0.72	0.5-100	0.998	4.39	4.4
14	OPEO16	928.60>88.95	1.71	1.15	0.38	0.5-100	0.995	6.43	6.43
15	OPEO17	972.60>146.95	1.70	24.9	8.21	5-100	0.997	8.19	8.2
16	OPEO18	1016.70>89.00	1.68	2.3	0.76	1-100	0.997	4.58	4.6
17	OPEO19	1060.80>133.25	1.67	15.9	5.25	10-100	0.994	17.4	17.9
18	OPEO20	1104.80>133.20	1.66	69.9	23.1	50-250	0.999	11.16	11.46

*6 replications, $n=6$

LC/MS/MS analysis of crude palm oil

The above method was applied to a crude palm oil sample obtained from a research lab to detect the presence of Triton X-100 residues, which might be used in the extraction process of production. The matrix of crude palm oil is more complex compared to that of edible palm oil sold in supermarket. Thus, in addition to

the blank crude palm oil sample, spiked samples with Triton X-100 at two concentrations (5 ppb and 50 ppb) were also analyzed to compare the baselines, interference and LC/MS/MS analysis results. The same sample extraction and purification procedure shown in Figure 2 was applied for the crude palm oil sample.

An Ultrafast LC/MS/MS Method for Characterization and Quantitation of Triton X-100 Extracted From Palm Oil

Table 3. Results of crude palm oil analysis (blank)

No	Triton X-100 species	Crude palm oil blank sample (non spiked)*	
		Area	Conc. (ppb)
1	OPEO3	24931	ND**
2	OPEO4	22300	ND**
3	OPEO5	30932	0.68
4	OPEO6	17996	ND**
5	OPEO7	7761	ND**
6	OPEO8	14118	ND**
7	OPEO9	7176	ND**
8	OPEO10	7152	ND**
9	OPEO11	1399	ND**
10	OPEO12	2278	ND**
11	OPEO13	-	ND
12	OPEO14	-	ND
13	OPEO15	-	ND
14	OPEO16	-	ND
15	OPEO17	-	ND
16	OPEO18	-	ND
17	OPEO19	-	ND
18	OPEO20	-	ND

*three replications, n=3

**under detection limit (S/N < 3)

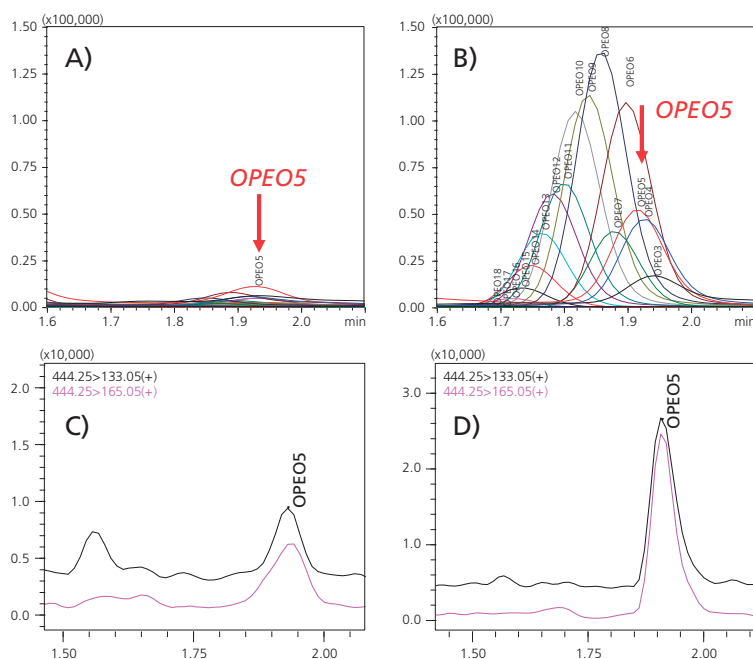

Figure 5. Total MRMs of crude palm oil (blank) (A) and spiked with 5ppb standard (B). Individual MRMs of OPEO5 of crude palm oil (blank) (C) and spiked with 5ppb standard (D).

An Ultrafast LC/MS/MS Method for Characterization and Quantitation of Triton X-100 Extracted From Palm Oil

The quantitative results indicate the presence of OPEO5 at very low content (~0.68 ppb) in the crude palm oil sample (Table 3 & Figure 5). However, this level is lower than the quantitation limit of the method. Despite shown with various peak area values, other 9 Triton X-100 species are

considered not detected because the levels are below the detection limit ($S/N < 3$). The characteristic of distribution pattern of Triton X-100 species are also not observed thus the targeted Triton X-100 is unlikely presence in the sample.

Conclusions

A MRM-based method for characterization and quantitation of Triton X-100 has been established using a Kinetex C18 100Å column on LCMS-8060. A total of 18 Triton X-100 species ($n = 3\sim 20$) was analysed within 5 minute running time using gradient elution program. With remarkable system sensitivity at the level of 3 ppb or less for most of Triton species, this ultrafast LC/MS/MS method is applicable to screen and quantitate the residue of Triton X-100 in crude palm oil.

References

1. P.D. DeArmond and A.L. DiGoregio, *Journal of Chromatography A*. (2013), 1305: 154-163
2. J.A. Field and R.L. Reed, *Environmental Science and Technology*. (1996). 30: 3544-3550
3. J.C. Dunphy, D.G. Pessler, S.W. Morall, K.A. Evans, D.A. Robaugh, G. Fujimoto, A. Negahban, *Environmental Science and Technology*. (2001). 35:1223-1230.
4. The Dow Chemical Company, "Safety Data Sheet Triton™ X-100 surfactant", <http://www.dow.com/en-US/ShowPDF.ashx?id=090003e8806f268e>

Disclaimer: The products and applications in this poster presentation are intended for Research Use Only (RUO). Not for use in diagnostic procedures.

First Edition: June, 2017

[← Return to main page](#)

Fertilizers

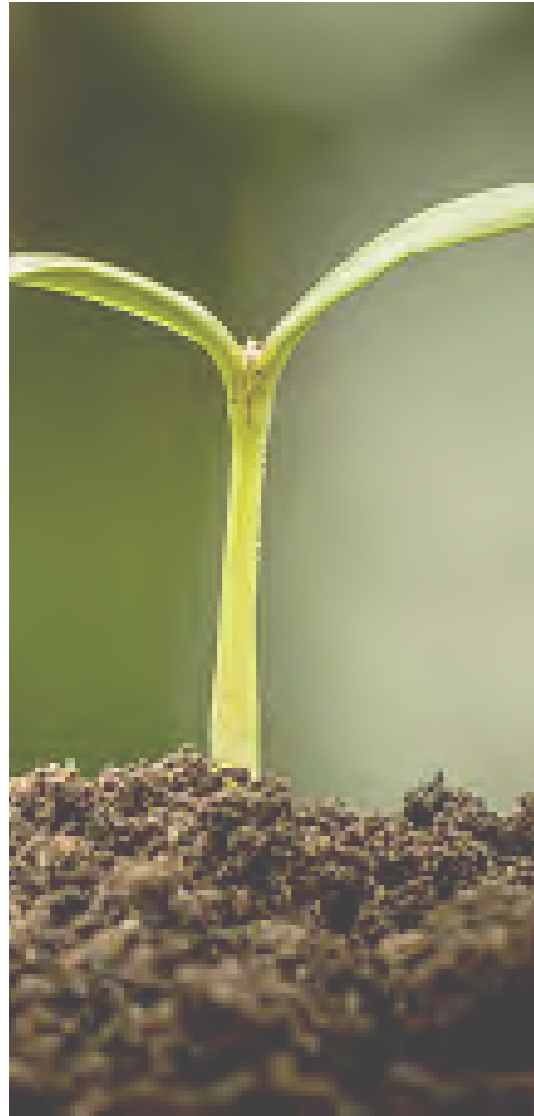

1. Analysis of Melamine and its Related Substances in Fertilizers
2. Analysis of Nitrous Acid and Ammonium Thiocyanate in Fertilizers
3. Multi-Residue Analysis of Antibiotics in Organic Fertilizers using the Ultra-High Performance Liquid Chromatography coupled with Triple Quadrupole Mass Spectrometry
4. Analysis of Sulfamic Acid in Fertilizers using LC/MS (LCMS-2020)

Application News

No.L514

High Performance Liquid Chromatography

Analysis of Melamine and Its Related Substances in Fertilizers

Calcium cyanamide is effective as a fertilizer, pesticide, soil amendment, and for many other uses, and it is essential compound for producing high quality vegetables. Recently, high levels of melamine were discovered as a byproduct in some calcium cyanamide hydrate products, pelletized by adding water to calcium cyanamide. Due to the risk of agricultural products absorbing the melamine from the soil, it has been identified as a potential public health risk. For example, if both melamine and its related substance cyanuric acid are ingested at the same time, they can form crystals that can impede kidney function.¹⁾

As a result, the Food Safety and Consumer Affairs Bureau in the Ministry of Agriculture, Forestry and Fisheries in Japan issued a notice specifying a 0.4 % provisional maximum allowable concentration of melamine in calcium cyanamide.²⁾

This article describes an example of pretreating and analyzing melamine and its related substances, namely ammeline, ammelide, and cyanuric acid, in fertilizer, in accordance with the testing methods supervised by the Food and Agricultural Materials Inspection Center (FAMIC) in Japan for fertilizers and other substances (2016, 8.1.c).^{3), 4), 5)}

■ Analysis of Standard Solution

The structure of melamine and its related substances is shown in Fig. 1. The analytical conditions are indicated in Table 1. The chromatogram of the standard mixture solution of melamine and its related substances (1 mg/L each) is shown in Fig. 2. For more details regarding the procedures used to prepare the standard solution and mobile phase, refer to the applicable test methods. Calibration curves for melamine and its related substances are shown in Fig. 3. Calibration curves were prepared for a concentration range of 0.05 to 5 mg/L. The results indicated good linearity, with a contribution rate (R^2) over 0.9999.

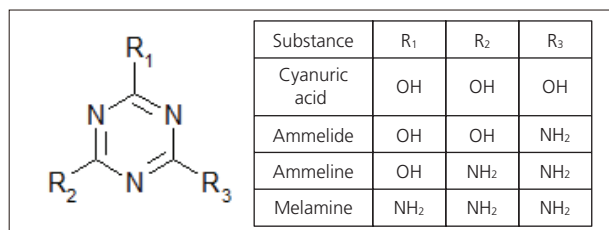

Fig. 1 Chemical Structure of Melamine and Its Related Substances

Table 1 Analytical Conditions

System	: Prominence
Column	: TOSOH, TSKgel Amide-80 (250 mm L. × 4.6 mm I.D., 5 μm)
Guard Column	: TOSOH, TSKgel guardgel Amide-80 (15 mm L. × 3.2 mm I.D.)
Mobile Phase	: (Sodium) phosphate buffer pH 6.7±0.2 / Acetonitrile = 1/4 (v/v)
Flowrate	: 1.0 mL/min
Column Temp.	: 40 °C
Injection Vol.	: 10 μL
Detection	: UV-VIS detector (SPD-20A) at 214 nm

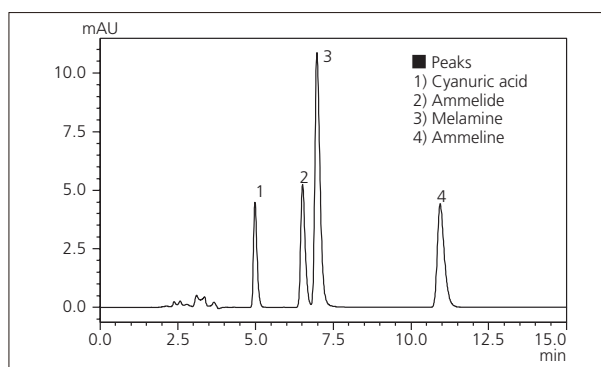

Fig. 2 Chromatogram of Standard Mixture (1 mg/L each)

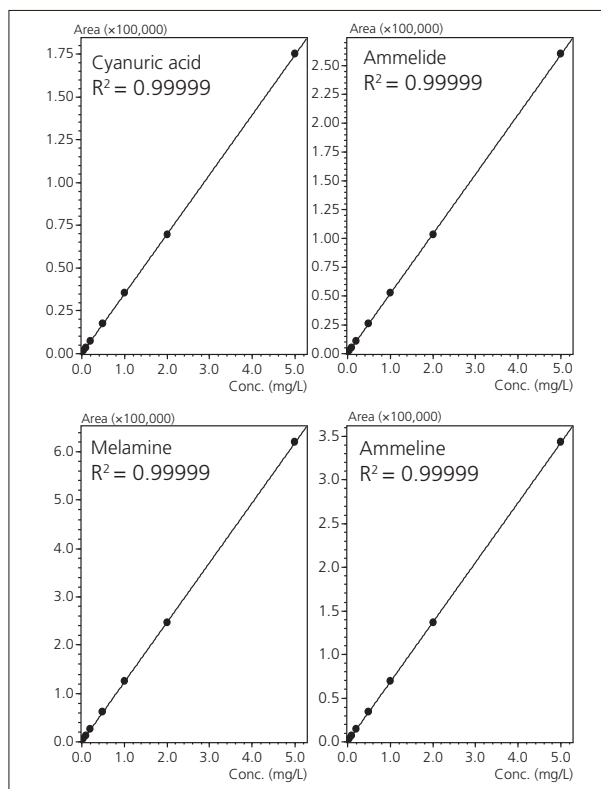

Fig. 3 Linearity (0.05 to 5 mg/L)

■ Repeatability

The relative standard deviation (%RSD) results for peak area after analyzing the standard solution (0.1 mg/L) six consecutive times were very good, with 0.41 % for cyanuric acid, 0.42 % for ammelide, 0.52 % for melamine, and 0.56 % for ammeline. When pretreated as indicated in Fig. 4, the 0.1 mg/L concentration of the standard solution is equivalent to a 0.02 % concentration of melamine and other related substances in fertilizer.

■ Analysis of Melamine and its Related Substances in Fertilizer

The analytical sample (fertilizer) was pretreated in accordance with the test method by adding a standard quantity of melamine and its related substances. The pretreatment procedure is indicated in Fig. 4 and the analytical results are shown in Fig. 5. In this example, five types of samples were tested, including two types of commercially available nitrolime, a synthetic fertilizer that contains calcium cyanamide, a synthetic fertilizer, and ammonium sulfate. The quantities of the substances added to the analytical samples, as a percentage of mass, were equivalent to about 0.035 to 2.8 % melamine, about 0.035 to 1.6 % ammelide, about 0.035 to 1.1 % ammeline, and about 0.037 to 1.2 % cyanuric acid. These results demonstrate that the Prominence system provides more than adequate performance for measuring the provisional 0.4 % melamine limit issued by the Food Safety and Consumer Affairs Bureau, Ministry of Agriculture, Forestry and Fisheries for calcium cyanamide and fertilizers that contain calcium cyanamide as an ingredient.

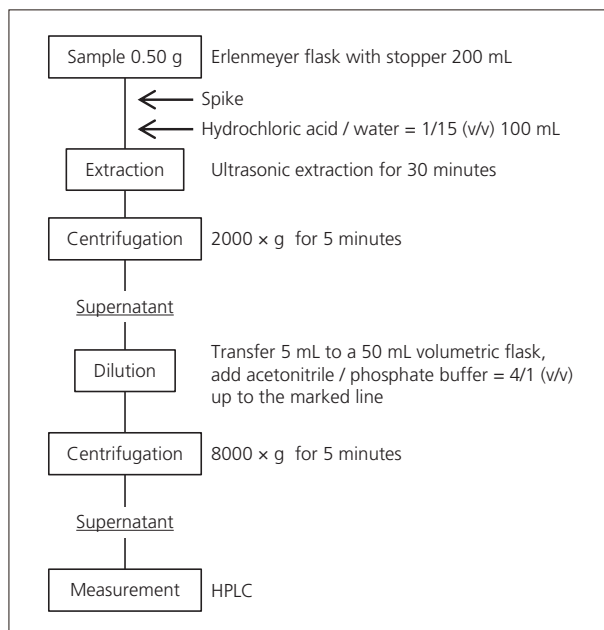

Fig. 4 Pretreatment Procedure

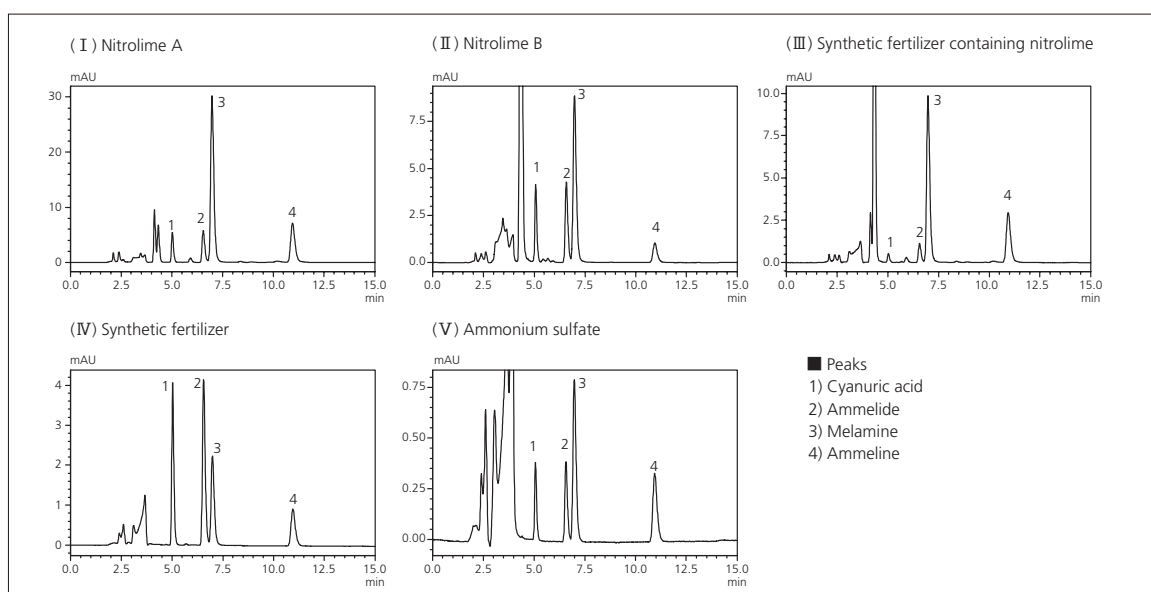

Fig. 5 Chromatograms for (I) Nitrolime A, (II) Nitrolime B, (III) Synthetic Fertilizer Containing Calcium Cyanamide, (IV) Synthetic Fertilizer, and (V) Ammonium Sulfate

References

- 1) Health effects of melamine, etc.: Food Safety Commission of Japan, October 9, 2008, updated April 30, 2009
- 2) Setting Allowable Limit Values for Melamine in Calcium Cyanamide, Food Safety and Consumer Affairs Bureau, Ministry of Agriculture, Forestry and Fisheries in Japan, Notice No. 6116, 2012, issued March 25, 2013 and partially revised March 30, 2013
- 3) Testing Methods for Fertilizers (2016), Food and Agricultural Materials Inspection Center (FAMIC): http://www.famic.go.jp/ffis/fert/obj/shikhenho_2016.pdf (in Japanese)
- 4) Etsuko Bando and Yuji Shirai: Validation of High Performance Liquid Chromatography (HPLC) for Determination of Melamine and Its Related Substances in Fertilizer, Research Report of Fertilizer Vol. 6, pp. 27 to 35 (2013)
- 5) Etsuko Bando and Shigehiro Kai: Determination of Melamine and Its Related Substances in Fertilizer by High Performance Liquid Chromatography (HPLC): A Collaborative Study, Research Report of Fertilizer Vol. 7 10-21 (2014)

First Edition: Jan. 2017



For Research Use Only. Not for use in diagnostic procedure.

This publication may contain references to products that are not available in your country. Please contact us to check the availability of these products in your country.

The content of this publication shall not be reproduced, altered or sold for any commercial purpose without the written approval of Shimadzu. Company names, product/service names and logos used in this publication are trademarks and trade names of Shimadzu Corporation or its affiliates, whether or not they are used with trademark symbol "TM" or "®". Third-party trademarks and trade names may be used in this publication to refer to either the entities or their products/services. Shimadzu disclaims any proprietary interest in trademarks and trade names other than its own.

The information contained herein is provided to you "as is" without warranty of any kind including without limitation warranties as to its accuracy or completeness. Shimadzu does not assume any responsibility or liability for any damage, whether direct or indirect, relating to the use of this publication. This publication is based upon the information available to Shimadzu on or before the date of publication, and subject to change without notice.

Shimadzu Corporation
www.shimadzu.com/an/

Application News

No.L513

High Performance Liquid Chromatography

Analysis of Nitrous Acid and Ammonium Thiocyanate in Fertilizers

After it is spread onto agricultural land, nitrogen fertilizer converts to nitrate-nitrogen or nitrite-nitrogen and leaches into subsoil and river water polluting the groundwater. Drinking water with a high nitrate-nitrogen or nitrite-nitrogen content is a potential public health risk. It causes methemoglobinemia that inhibits the oxygen-carrying capacity of blood and has caused deaths in infants outside Japan.

Fertilizers with high concentrations of nitrous acid and ammonium thiocyanate have a negative effect on plant growth, therefore maximum content levels (permitted content levels) for toxic substances are prescribed in official specifications for commercial fertilizers according to the Fertilizer Control Law¹⁾.

An example of simultaneous analysis of the nitrous acid and ammonium thiocyanate content of fertilizer by HPLC is described. Analysis was performed in conformance with the test method that appears in Testing Methods for Fertilizers (5.8.b and 5.9.a, 2016)²⁾, published by the Food and Agricultural Materials Inspection Center (FAMIC).

■ Analysis of a Standard Mixture

Analytical conditions are shown in Table 1. A chromatogram of a standard mixture of nitrous acid and ammonium thiocyanate (20 mg/L each) is also shown in Fig. 1. Please refer to the test method²⁾ for details on mobile phase preparation. Standard solution was prepared by dissolution and dilution with water. An NH2 column was used for analysis.

Table 1 Analytical Conditions

System	: Prominence
Column	: Shodex Asahipak NH2P-50 4E (250 mm L. × 4.6 mm I.D., 5 μm)
Guard Column	: Shodex Asahipak NH2P-50G 4A (10 mm L. × 4.0 mm I.D., 5 μm)
Mobile Phase	: (Sodium) phosphate buffer containing sodium perchlorate
Flowrate	: 1.0 mL/min
Column Temp.	: 40 °C
Detection	: UV-VIS detector (SPD-20AV) at 210 nm
Injection Vol.	: 10 μL

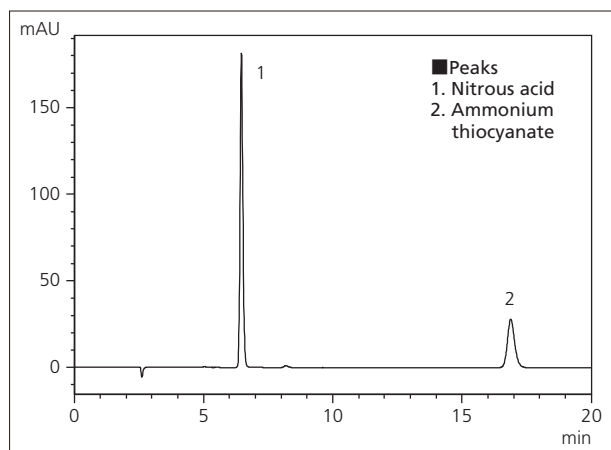

Fig. 1 Chromatogram of Standard Mixture (20 mg/L each)

■ Linearity of Calibration Curves

Fig. 2 shows calibration curves for nitrous acid and ammonium thiocyanate analyzed under the conditions shown in Table 1. The range used for calibration curves was 1 to 20 mg/L. Good linearity was obtained for both compounds with contribution rates (R^2) of 0.9999 or higher.

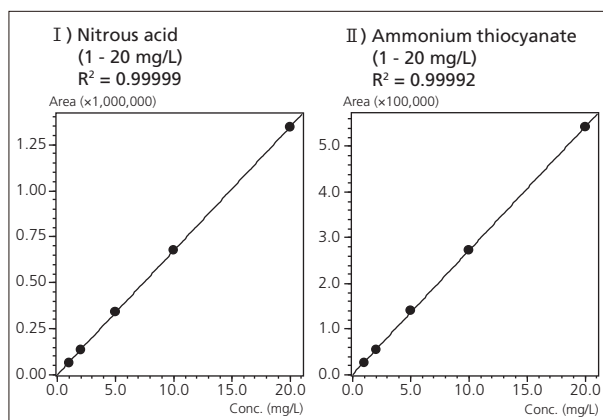

Fig. 2 Linearity of Calibration Curves
I) Nitrous acid (1 - 20 mg/L),
II) Ammonium thiocyanate (1 - 20 mg/L)

■ Repeatability

The relative standard deviation (%RSD) of retention times and peak areas obtained from an analysis of each compound at 0.1 mg/L repeated six times is shown in Table 2 and 3. The concentration analyzed (0.1 mg/L) was equivalent to 1/10 the lowest concentration on the calibration curve of either compound. Good repeatability was obtained for the retention times and peak areas of both compounds.

Table 2 Repeatability of Retention Time and Peak Area for Nitrous Acid Analysis

	R.T. (min)	Area
1st	6.452	6,752
2nd	6.452	6,801
3rd	6.450	6,722
4th	6.452	6,794
5th	6.452	6,727
6th	6.451	6,823
Ave.	6.452	6,770
%RSD	0.012	0.62

Table 3 Repeatability of Retention Time and Peak Area for Ammonium Thiocyanate Analysis

	R.T. (min)	Area
1st	16.868	2,551
2nd	16.870	2,534
3rd	16.882	2,524
4th	16.881	2,519
5th	16.885	2,546
6th	16.868	2,553
Ave.	16.876	2,538
%RSD	0.046	0.57

■ Analysis of Nitrous Acid and Ammonium Thiocyanate in Fertilizers

The method used to prepare fertilizer samples is shown in Fig. 3. The method of pretreatment differed depending on whether the sample was a powder or liquid, and on extraction liquid pH. Standard additions of nitrous acid and ammonium thiocyanate were made to the samples for analysis (fertilizer) before being further prepared according to the procedure shown in Fig. 3^{3), 4)}. The results of analysis are shown in Fig. 4.

Testing Methods for Fertilizers (2016) describes a method that uses ion chromatography for the analysis of ammonium thiocyanate (5.8.a). However, because this method produces a complex eluent, it takes some time for the baseline to stabilize. Another problem with the method is that it has resulted in multiple system peaks and peaks close to the elution position of ammonium thiocyanate. Nevertheless, on this occasion, the results show that good separation was achieved, including for contaminating constituents in the fertilizer.

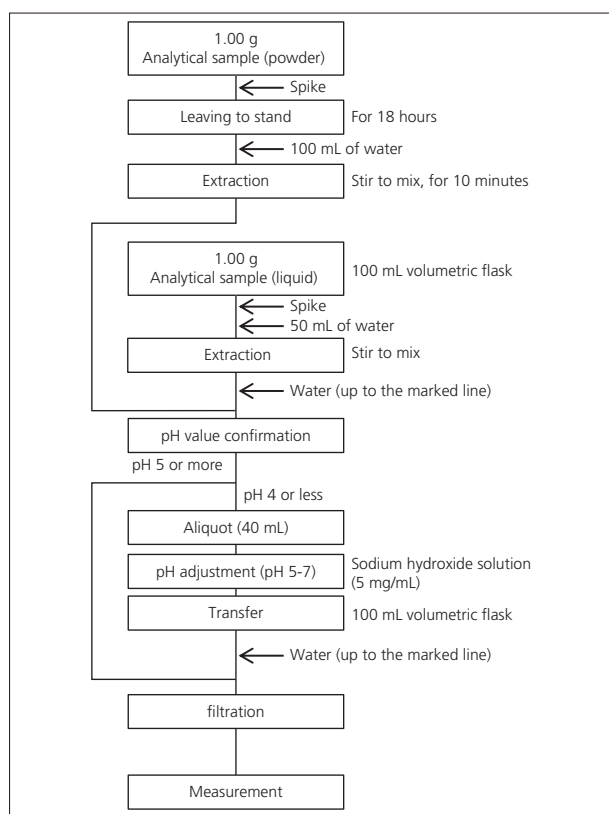

Fig. 3 Pretreatment

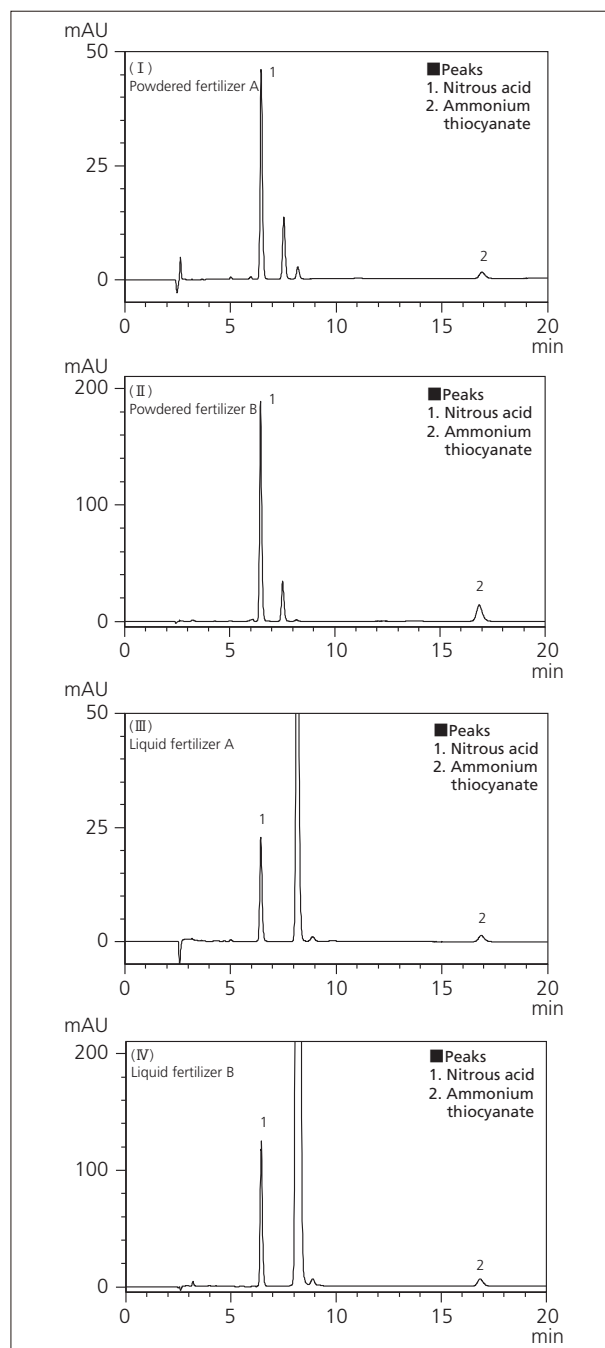

Fig. 4 Chromatograms of Fertilizer Sample Solutions (I) Powdered fertilizer A, (II) Powdered fertilizer B, (III) Liquid fertilizer A, (IV) Liquid fertilizer B

References

- 1) Ministry of Agriculture, Forestry and Fisheries notification: Establishment of official specifications for commercial fertilizers according to the Fertilizer Control Law, dated February 22, 1986. Ministry of Agriculture, Forestry and Fisheries notification no. 284: Final revision, dated March 30, 2016. Ministry of Agriculture, Forestry and Fisheries notification no. 884: Enactment, dated April 1, 2016. [In Japanese]
- 2) Testing Methods for Fertilizers (2016), Food and Agricultural Materials Inspection Center (FAMIC): http://www.famic.go.jp/ffis/fert/obj/shikhenho_2016.pdf [In Japanese]
- 3) Masanori Hasegawa, Yasuharu Kimura: Determination of Nitrous Acid and Ammonium Thiocyanate in Fertilizer by High Performance Liquid Chromatography (HPLC): A Collaborative Study, Research Report of Fertilizer, vol. 8, 70-78 (2015) [in Japanese]
- 4) Kohei Ito, Yasuharu Kimura, Masanori Hasegawa, Yuji Shirai: Simultaneous determination of nitrous acid and thiocyanate in fertilizer by HPLC, Japanese Journal of Soil Science and Plant Nutrition, 87 (3), 120-124 (2016) [In Japanese]

First Edition: Jan. 2017



For Research Use Only. Not for use in diagnostic procedure.

This publication may contain references to products that are not available in your country. Please contact us to check the availability of these products in your country.

The content of this publication shall not be reproduced, altered or sold for any commercial purpose without the written approval of Shimadzu. Company names, product/service names and logos used in this publication are trademarks and trade names of Shimadzu Corporation or its affiliates, whether or not they are used with trademark symbol "TM" or "®". Third-party trademarks and trade names may be used in this publication to refer to either the entities or their products/services. Shimadzu disclaims any proprietary interest in trademarks and trade names other than its own.

The information contained herein is provided to you "as is" without warranty of any kind including without limitation warranties as to its accuracy or completeness. Shimadzu does not assume any responsibility or liability for any damage, whether direct or indirect, relating to the use of this publication. This publication is based upon the information available to Shimadzu on or before the date of publication, and subject to change without notice.

Shimadzu Corporation
www.shimadzu.com/an/

Multi-Residue Analysis of Antibiotics in Organic Fertilizers using the Ultra-High Performance Liquid Chromatograph coupled with Triple Quadrupole Mass Spectrometer

Liu Zhao
Shimadzu (China), Shanghai Analysis Center

Application News
SSL-CA14-453

Abstract

This report describes a method for the determination of 15 antibiotics, such as tetracyclines, penicillin, quinolones and sulfonamides, in organic fertilizer using the Shimadzu Ultra-High Performance Liquid Chromatograph LC-30A and Triple Quadrupole Mass Spectrometer LCMS-8045. In this method, 15 antibiotics are analyzed within 12 minutes, and the correlation coefficients of the calibration curve are all above 0.995 with good linearity. Six parallel tests of the mixed standard solutions with low, medium and high concentrations were performed, and the relative standard deviations of retention time and peak area of the 15 antibiotics were 0.01–0.46% and 0.29–7.09% respectively. These results show good precision. The sensitivity test result indicates that the quantitation limit of the 15 antibiotics is at 0.004–0.135 ng/mL; the samples were also tested with the standard addition concentrations of 0.5 ng/mL and 5 ng/mL, and the recovery rates were measured to be in the range 82.2–104.8%. Characterized by fast analysis speed, good repeatability and high sensitivity, the described method can determine antibiotic residues in organic fertilizers and at the same time meet requirements specified in the new national standard (GB/T32951-2016).

With the rapid growth and developments in the livestock and poultry industry, antibiotics have been widely used as a feed additive to prevent and treat diseases and promote growth. Research shows that the amount of antibiotics discharged in an animal's urine or feces in the form of matrix or metabolites accounts for 40%–90% of the antibiotic dose. Organic fertilizer, consisting of mainly livestock and poultry feces, is widely used in agricultural production because of its rich organic compounds and nitrogen and phosphorus contents. However, due to limitations in the treatment process, antibiotics cannot be effectively degraded and removed during the production of organic fertilizer. The use of organic fertilizer containing antibiotics directly cause soil pollution, especially when livestock manure containing adsorbable tetracycline antibiotics is applied to farmland. These antibiotics combines with soil particles forming stable compounds with long lifetime, polluting the soil, as well as inducing and spreading various antibiotic-resistant bacteria. This poses

a major threat to human health and our environment.

The current organic fertilizer standards in China are referenced mainly from the "Organic Fertilizer" (NY525-2012) and "Bio-organic Fertilizer" (NY884-2012) standards. These standards stipulate the contents of organic material, total nutrients and heavy metal, but the amount of residual antibiotics is not included. In view of the lack of detection methods and standards for antibiotic content in organic fertilizers in China, the State General Administration of Quality Supervision, Inspection and Quarantine and the State Standardization Administration Committee approved and issued the standard GB/T32951-2016 "High Performance Liquid Chromatography for Determination of Oxytetracycline, Tetracycline, Chlortetracycline and Doxycycline Content in Organic Fertilizer" in August 2016, and implemented it on March 1st, 2017. This standard has not only provided an important method for determining tetracycline antibiotic residues in organic fertilizer products, but has also provided technical support for the analysis

and optimization of treatment processes in livestock and poultry manure processing enterprises.

With reference to the sample pretreatment method specified in GB/T 32951-2016 "High Performance Liquid Chromatography for Determination of Oxytetracycline, Tetracycline, Chlortetracycline and Doxycycline Content in Organic Fertilizer", this paper demonstrates a method that uses the Shimadzu Ultra-High Performance Liquid Chromatograph LC-30A and the Triple Quadrupole Mass Spectrometer LCMS-8045 to determine the amount of 15 antibiotic residues in organic fertilizer.

EXPERIMENTAL

Instrumentation

A system with a Shimadzu Ultra-High Performance Liquid Chromatograph (UHPLC) LC-30A and Triple Quadrupole Mass Spectrometer LCMS-8045 is used in this experiment. The specific configurations are two LC-30AD pumps, DGU-20A_{SR} online degassing unit, SIL-30AC automatic sampler, CTO-30AC column oven, CBM-20A system controller, LCMS-8045 triple quadrupole mass spectrometer and LabSolutions Ver. 5.86 Chromatographic Workstation.

Analytical Conditions

LC Chromatography (LC) Conditions

Column	: Shim-pack XR-ODS III, 2.0 mm I.D.× 75 mm L., 1.6 μm
Mobile Phase	: Phase A - 0.1% formic acid solution Phase B - acetonitrile
Flow rate	: 0.30 mL/min
Column temp.	: 40 °C
Injection volume	: 10 μL
Type of elution	: Gradient elution with the initial concentration of Mobile Phase B at 10%. Refer to Table 1 for elution program.

Table 1 Gradient elution time program

Time (min)	Module	Command	Value (%)
0.50	Pumps	Pump B Conc.	10
3.00	Pumps	Pump B Conc.	35
5.50	Pumps	Pump B Conc.	90
8.00	Pumps	Pump B Conc.	90
8.10	Pumps	Pump B Conc.	10
12.00	Controller	Stop	

Mass Spectrometry (MS) Conditions

Analytical Instrument	: LCMS-8045
Ion sources	: ESI
Nebulizer gas flow rate	: 3.0 L/min
Drying gas flow rate	: 10.0 L/min
Interface temp.	: 300 °C
DL temp.	: 250 °C
Heating module temp.	: 400 °C
Heating gas flow rate	: 10.0 L/min
Scanning mode	: Multiple reaction monitoring (MRM)
Dwell time	: 8 ms
MRM Parameters	: Refer to Table 2

Preparation of Standard Solutions

An appropriate amount of each of the 15 antibiotic standards was weighed, combined and dissolved in methanol to prepare a mixed standard stock solution containing 15 antibiotics, each of concentration 10 μg/mL. It is further diluted with blank matrix to obtain mixed standard solutions of concentrations 0.1, 0.2, 0.5, 1, 2, 5, 10, 20, 50 ng/mL (taking oxytetracycline calibration curve concentration as an example).

The sample pretreatment method was conducted in reference to the sample extraction and clean-up method specified in GB/T 32951-2016 "Determination of Oxytetracycline, Tetracycline, Chlortetracycline and Doxycycline in Organic Fertilizers".

Table 2 MRM optimized parameters

Compound Name	CAS No.	Precursor Ion	Product Ion	Q1 Pre Bias (V)	CE (V)	Q3 Pre Bias (V)
Amoxicillin	26787-78-0	366.2	114.00*	-26.0	-22.0	-20.0
			349.20	-26.0	-10.0	-17.0
Lincomycin	154-21-2	407.3	126.10*	-20.0	-40.0	-17.0
			359.30	-20.0	-20.0	-27.0
Sulfadiazine	68-35-9	251.0	156.00*	-30.0	-15.0	-29.0
			92.10	-30.0	-25.0	-17.0
Ampicillin	69-53-4	350.2	106.10*	-17.0	-23.0	-11.0
			114.10	-17.0	-30.0	-19.0
Sulfathiazole	72-14-0	256.0	156.00*	-30.0	-14.0	-30.0
			92.10	-30.0	-28.0	-17.0
Ciprofloxacin	85721-33-1	332.2	314.10*	-13.0	-16.0	-24.0
			231.00	-13.0	-44.0	-18.0
Levofloxacin	100986-85-4	362.1	318.10*	-11.0	-20.0	-21.0
			261.10	-11.0	-28.0	-17.0
Sulfapyridine	144-83-2	250.0	156.00*	-30.0	-16.0	-29.0
			92.10	-30.0	-27.0	-17.0
Oxytetracyclin	79-57-2	461.2	426.00*	-14.0	-18.0	-23.0
			443.10	-14.0	-14.0	-24.0
Tetracycline	60-54-8	445.2	410.20*	-11.0	-22.0	-30.0
			427.00	-11.0	-16.0	-23.0
Aureomycin	57-62-5	479.2	444.10*	-12.0	-24.0	-23.0
			154.10	-12.0	-28.0	-12.0
Doxycycline	564-25-0	445.1	428.05*	-16.0	-18.0	-30.0
			154.05	-11.0	-32.0	-30.0
Sulfamethazine	57-68-1	279.0	186.00*	-30.0	-17.0	-20.0
			92.10	-30.0	-31.0	-17.0
Chloramphenicol	56-75-7	321.00	152.10*	22.0	17.0	27.0
			257.10	22.0	11.0	26.0
Oxacillin	66-79-5	400.1	259.10*	29.0	13.0	19.0
			356.25	30.0	8.0	14.0

Note: * indicates quantification ion

RESULTS AND DISCUSSION

MRM Chromatograms of Standard Samples

The MRM chromatograms for the mixed standard samples are displayed in Figure 1.

Calibration curve and linearity

The samples were first extracted and purified to obtain blank matrix extract solutions. The stock solution was added to the blank matrix solution to prepare standard working solutions at different concentrations. LC-MS/MS analysis was conducted as specified in previously. A calibration curve was obtained using the external standard method. Refer to

Table 3 for linear equations, linear range and the corresponding correlation coefficient.

Precision experiment

Mixed standard solutions were prepared at different concentrations with blank matrix and injected for 6 consecutive times (taking oxytetracycline calibration curve concentration as an example) to check the precision. As shown in Table 4, the relative standard deviation (RSD%) of retention time and peak area are at 0.01–0.46% and 0.29–7.09% respectively, showing good precision.

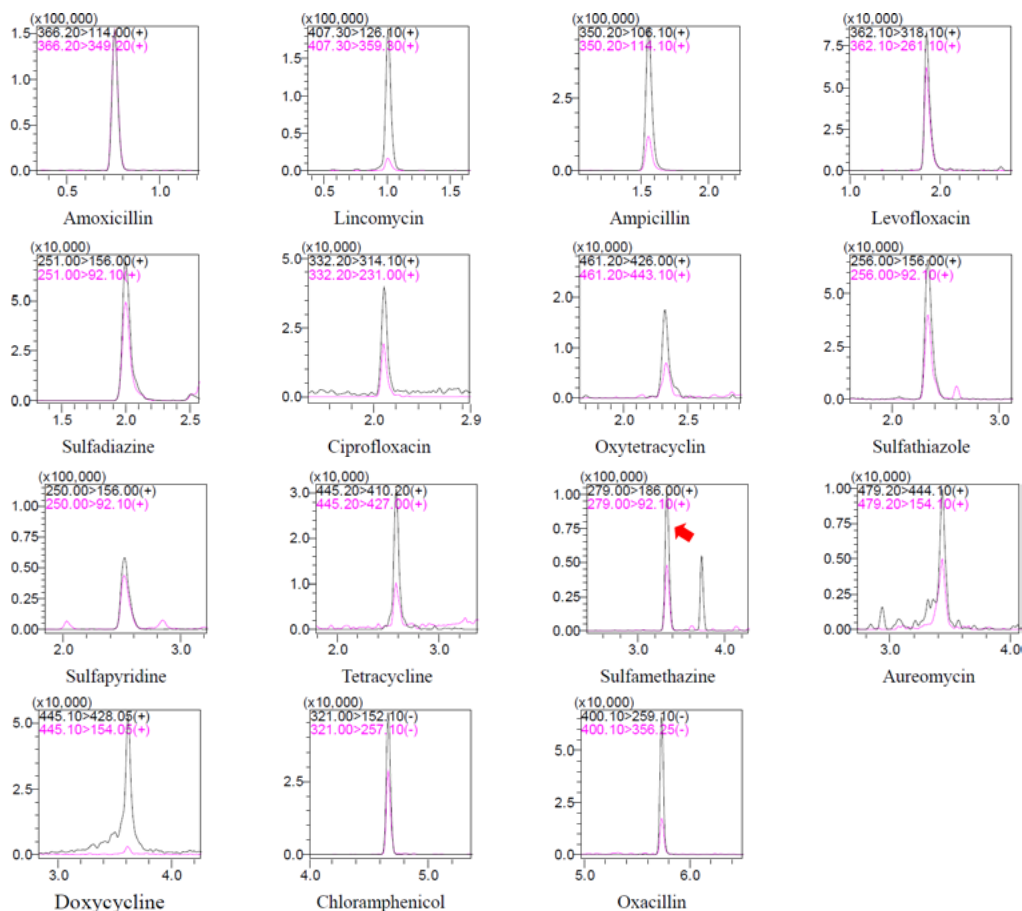

Figure 1 MRM chromatograms of standard samples with concentration of 1 ng/mL (taking the calibration curve concentration of Oxytetracyclin as an example)

Table 3 Parameters for the calibration curve (linear regression, the weight coefficient was 1/C²)

No.	Compound	Calibration curve	Linear Range (ng/mL)	Accuracy (%)	Correlation Coefficient (r)
1	Amoxicillin	$Y = (31256.8)X + (5907.03)$	1~200	93.8~113.7	0.9967
2	Lincomycin	$Y = (373554)X + (186159)$	0.1~50	94.0~110.4	0.9976
3	Ampicilin	$Y = (151576)X + (-9683.21)$	1~500	91.2~107.0	0.9984
4	Levofloxacin	$Y = (107361)X + (215994)$	0.2~50	90.4~111.7	0.9963
5	Sulfadiazine	$Y = (263530)X + (26112.5)$	0.1~50	88.6~110.1	0.9965
6	Ciprofloxacin	$Y = (45160.1)X + (95808.1)$	0.2~50	91.3~109.4	0.9972
7	Oxytetracyclin	$Y = (41615.1)X + (16467.2)$	0.1~50	92.1~105.4	0.9989
8	Sulfathiazole	$Y = (276746)X + (27313.8)$	0.1~20	93.1~104.6	0.9988
9	Sulfapyridine	$Y = (237308)X + (30237.9)$	0.1~20	90.5~107.7	0.9979
10	Tetracycline	$Y = (97960.6)X + (4577.06)$	0.1~50	95.6~107.4	0.9987
11	Sulfamethazine	$Y = (314461)X + (10821.7)$	0.1~50	94.3~109.6	0.9984
12	Aureomycin	$Y = (24763.0)X + (9419.09)$	0.1~50	86.7~111.0	0.9955
13	Doxycycline	$Y = (114771)X + (30987.1)$	0.2~50	91.5~109.1	0.9976
14	Chloramphenicol	$Y = (11132.6)X + (1469.11)$	1~100	92.2~108.0	0.9971
15	Oxacillin	$Y = (15531.9)X + (-1257.09)$	1~500	95.5~106.2	0.9993

Table 4 Repeatability results of retention time and peak area (n=6)

No.	Compound Name	RSD% (0.5 ng/mL)		RSD% (2 ng/mL)		RSD% (10 ng/mL)	
		R.T.	Area	R.T.	Area	R.T.	Area
1	Amoxicillin	0.09	3.62	0.08	2.65	0.03	1.61
2	Lincomycin	0.26	3.56	0.25	1.73	0.10	1.41
3	Ampicilin	0.37	2.02	0.39	0.89	0.13	0.29
4	Levofloxacin	0.45	3.51	0.46	1.34	0.16	0.79
5	Sulfadiazine	0.17	4.13	0.26	2.82	0.08	0.88
6	Ciprofloxacin	0.39	6.47	0.40	3.08	0.18	3.02
7	Oxytetracyclin	0.33	4.53	0.34	5.43	0.16	2.29
8	Sulfathiazole	0.22	5.11	0.21	2.73	0.09	1.41
9	Sulfapyridine	0.13	3.35	0.21	1.98	0.09	1.96
10	Tetracycline	0.29	6.96	0.23	3.68	0.09	1.08
11	Sulfamethazine	0.06	4.92	0.12	2.14	0.05	0.53
12	Aureomycin	0.13	5.45	0.14	5.70	0.06	5.40
13	Doxycycline	0.07	5.93	0.10	4.01	0.06	4.39
14	Chloramphenicol	0.04	3.75	0.05	2.77	0.01	1.12
15	Oxacillin	0.01	7.09	0.02	2.53	0.01	2.27

Limit of detection and limit of quantitation

The organic fertilizer samples are prepared according to the treatment method described in the experimental section. A matrix spike sample of concentration 0.2 ng/mL was prepared (taking the standard curve concentration of oxytetracycline as an example), and injected for analysis. The lowest detection limit (S/N=3) and the lowest quantitative limit (S/N=10) of the 15 antibiotics were calculated by software and the results are

shown in Table 5.

Matrix Spike and Recovery Experiment

The organic fertilizer sample was prepared according to the treatment method described in experimental section to obtain a blank matrix., Matrix spike samples at concentrations of 0.5 ng/mL and 5 ng/mL are prepared and injected to determine the recovery rate. The results in Table 6 show that the spike recovery rates are in the range of 82.2–104.8%.

Table 5 Detection Limit and Quantitation Limit of 15 Antibiotics

No.	Compound Name	Spiked Sample Concentration (0.5 ng/mL)		Spiked Sample Concentration (5 ng/mL)	
		Average (ng/mL)	Recovery (%)	Average (ng/mL)	Recovery (%)
1	Amoxicillin	4.72	94.4	46.66	93.3
2	Lincomycin	0.51	101.8	4.13	82.6
3	Ampicilin	4.67	93.5	47.25	94.5
4	Levofloxacin	0.42	83.9	4.34	86.9
5	Sulfadiazine	0.48	96.6	4.11	82.2
6	Ciprofloxacin	0.41	82.8	4.31	86.2
7	Oxytetracyclin	0.49	98.4	4.98	99.5
8	Sulfathiazole	0.49	97.8	4.52	90.3
9	Sulfapyridine	0.48	96.5	4.34	86.7
10	Tetracycline	0.47	93.0	4.39	87.8
11	Sulfamethazine	0.48	95.4	4.58	91.6
12	Aureomycin	0.45	89.7	5.24	104.8
13	Doxycycline	0.43	86.3	4.52	90.4
14	Chloramphenicol	4.85	96.9	46.43	92.9
15	Oxacillin	4.49	89.9	53.89	107.8

CONCLUSION

This paper establishes a method for the rapid determination of 15 antibiotics in organic fertilizer using the Shimadzu UHPLC LC-30A and Triple Quadrupole Mass Spectrometer LCMS-8045. With this method, 15 antibiotics are analyzed within 12 minutes, and the correlation coefficients of the calibration curve are all above 0.995 with good linearity. Six parallel tests of the mixed standard solutions with low, medium and high concentrations were performed, and the relative standard deviations of

retention time and peak area of the 15 antibiotics are at 0.01–0.46% and 0.29–7.09% respectively, showing good precision. Prepared samples with concentrations of 0.5 ng/mL and 5 ng/mL had a recovery rate of 82.2–104.8%, indicating characteristics of fast analysis speed, good repeatability and high sensitivity. This method has broadened the scope of antibiotic analysis and demonstrated the multi-residue analysis of antibiotics at the same time meet requirements specified in the new national standard (GB/T32951-2016).

Application News

No. C105

Liquid Chromatography Mass Spectrometry

Analysis of Sulfamic Acid in Fertilizers Using LC/MS (LCMS-2020)

Sulfamic acid, due to its plant growth inhibiting effects, is subject to maximum limits in fertilizers as specified in the official standard¹⁾ for ordinary fertilizers according to the Japanese Fertilizers Regulation Act. According to the Testing Methods for Fertilizers²⁾ supervised by Japan's Food and Agricultural Materials Inspection Center (FAMIC), the ion chromatography (IC) method is specified as the test method for sulfamic acid in ammonium sulfate. It has been reported, however, that when applying this IC method with byproduct compound fertilizer (fertilizer produced by concentrating and drying liquid byproducts obtained from fermentation plants involved in amino acid production, etc.) samples that contain large amounts of organic matter, it is difficult to separate the sulfamic acid peaks from contaminant peaks generated from sample matrix.³⁾

In this application, we investigated the analytical conditions for LC/MS that would permit acquisition of mass information and provide high selectivity in order to eliminate the effects of contaminating components. The LCMS-2020 single quadrupole mass spectrometer was used for the analysis.

Good quantitative results were obtained, confirming the applicability of this method using byproduct compound fertilizer as the actual sample.

■ Analysis of Standard Solution

Table 1 shows the analytical conditions, and Fig. 1 shows chromatogram obtained using a standard solution (0.1 mg/L aqueous solution) of sulfamic acid.

As retention of a zwitterionic compound such as sulfamic acid is difficult using reversed phase conditions, we adopted conditions using a HILIC column. Isocratic analysis was conducted using a mobile phase consisting of acetonitrile / ammonium formate + formic acid (pH 3.2).

Applying the LC/MS method (ESI-Negative), we conducted selected ion monitoring (SIM) analysis using the deprotonated molecule at m/z 95.9. Fig. 2 shows the calibration curve. Excellent linearity was obtained over the entire concentration range of 0.001 to 0.1 mg/L, with a correlation coefficient greater than 0.999.

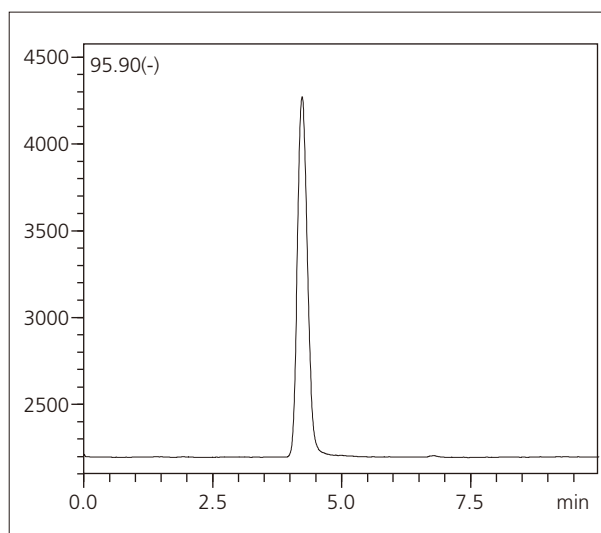

Fig. 1 Mass Chromatogram (SIM) of Sulfamic Acid (0.1 mg/L)

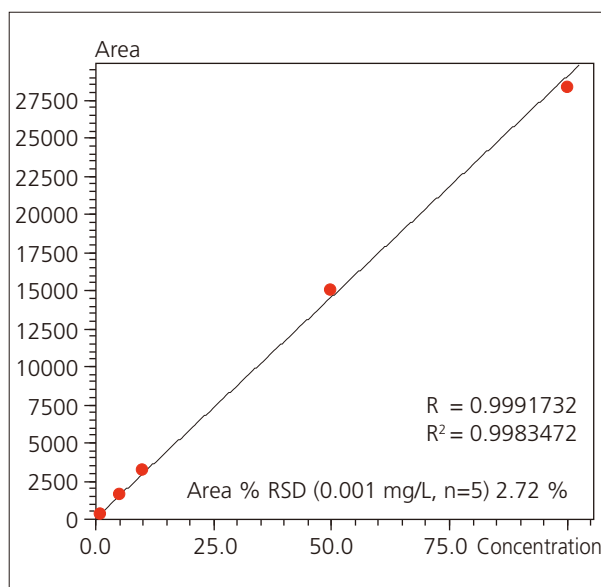

Fig. 2 Calibration Curve (0.001 - 0.1 mg/L)

Table 1 Analytical Conditions

Column	: Phenomenex Luna HILIC 20A (100 mm L. x 2.0 mm I.D., 5 μ m)
Mobile Phases	: Acetonitrile/100 mmol/L Ammonium Formate+ Formic Acid (pH 3.2) = 90:10, v/v
Flowrate	: 0.2 mL/min
Column Temperature	: 40 °C
Injection Volume	: 1 μ L
Probe Voltage	: -3.5 kV (ESI-negative mode)
DL Temperature	: 250 °C
Block Heater Temperature	: 400 °C
Nebulizing Gas Flow	: 1.5 L/min
Drying Gas Flow	: 15 L/min
Monitoring Ion (SIM)	: m/z 95.9

■ Analysis of Sulfamic Acid in Fertilizers

We verified the applicability of the LC/MS method using a byproduct compound fertilizer as an actual sample. The permissible content level of sulfamic acid is set based on the total amount of the principal component in each type of fertilizer. Here, taking the lower limit of quantitation of sulfamic acid in fertilizer as 1/5 the value of the minimum concentration permissible (sulfamic acid concentration 0.005 % per principal component 1 %), we conducted spike and recovery testing using a spike quantity equivalent to the lower limit of quantitation.

Fig. 3 shows the sample pretreatment procedure. The extraction method conforms to the Testing Methods for Fertilizers (2013) supervised by FAMIC. After weighing out 1 g of byproduct compound fertilizer, extraction was conducted using 100 mL of water, and after further diluting this 100 to 1 with water, the mixture was filtered to complete preparation of the fertilizer measurement solution.

As the total quantity of the principal component represented 5 % of the fertilizer content, the concentration of sulfamic acid corresponding to the lower limit of quantitation is calculated as 50 mg/kg of fertilizer. In the spike and recovery test, 0.5 mL of 100 mg/L standard sample was added to the fertilizer, and after letting the mixture stand for 30 minutes, a measurement solution was prepared using the same procedure. The concentration of sulfamic acid in the measurement solution is therefore 0.005 mg/L.

Representative chromatograms are shown in Fig. 4 including chromatograms of the standard sample (0.005 mg/L), the sample spiked with sulfamic acid, and the byproduct compound fertilizer measurement solution. Table 2 shows the analytical results. Sulfamic acid was not detected in the byproduct compound fertilizer, nor were there any noticeable peaks associated with contaminant components.

In the spike and recovery test, excellent results were obtained in continuous analysis (n=5), with an average recovery rate of 101 %. The LC/MS method investigated here in the analysis of highly contaminated byproduct compound fertilizer was demonstrated to permit quantitation by simply adding a dilution step following extraction, as opposed to the IC method which requires tedious processing to address the issue of high-contaminant content.

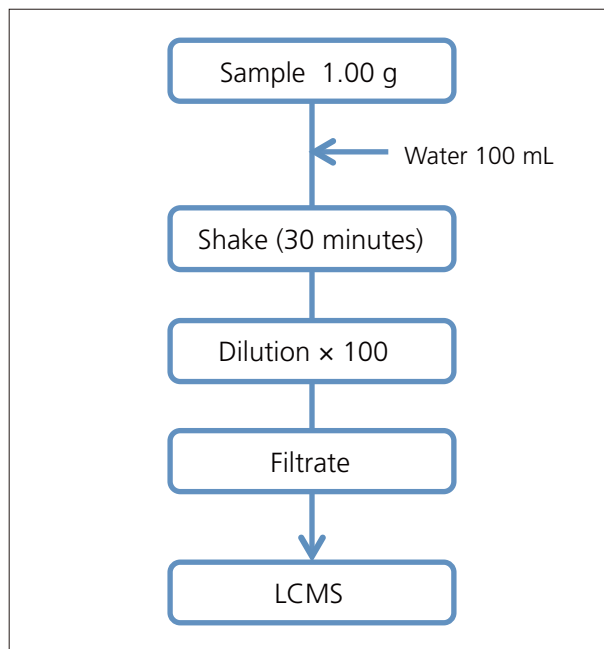

Fig. 3 Preparation Flow

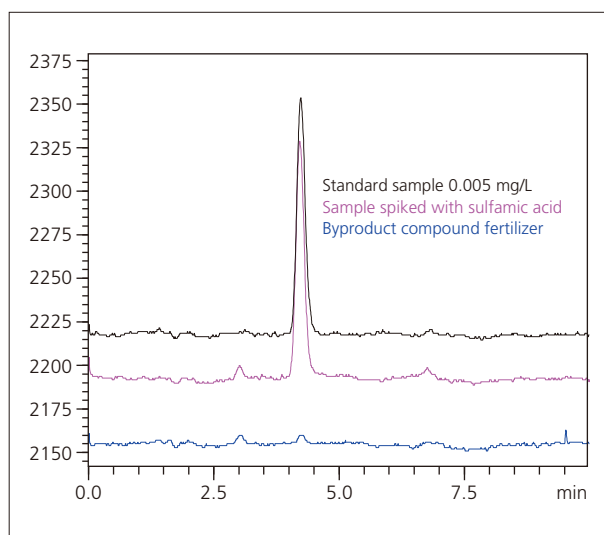

Fig. 4 SIM Chromatograms of STD and Fertilizer Sample

Table 2 Repeatability of Peak Area and Retention Time in Spike and Recovery Test

	R.t (min)	Peak Area	Recovery (%)
1st	4.217	1564	103
2nd	4.252	1561	102
3rd	4.229	1508	99
4th	4.224	1511	99
5th	4.219	1534	100
Ave	4.228	1535	101
%RSD	0.336	1.735	

[References]

- 1) Notification Regarding Determination of the Official Standard for Ordinary Fertilizer Based on the Fertilizers Regulation Act, February 22, 1986, the Japan's Ministry of Agriculture, Forestry and Fisheries Notification No. 284, Final Revision
December 5, 2013 the Ministry of Agriculture, Forestry and Fisheries Notification No. 2939 (2013)
- 2) Food and Agricultural Materials Inspection Center (FAMIC): Testing Methods for Fertilizers
< <http://www.famic.go.jp/ffis/fert/sub9.html> >
- 3) Hiroi T., Shirai Y.: Simultaneous Determination of Sulfamic Acid and Ammonium Thiocyanate in Ammonium Sulfate by Nonsuppressed Ion Chromatography, Research Report of Fertilizer, 5, 1 – 12 (2012)

[← Return to main page](#)

Meat and Seafood



1. Analysis of Trace Elements in Certified Fish Sample with ICP-MS
2. Analysis of Trace Elements in Fish Sample with ICP-AES (ICP-OES) on ICPE-9800
3. Multi-residual Quantitative Analytical Method for Antibiotics in Seafood by LC/MS/MS
4. Analysis of Residual Antimicrobials in Meat with Antimicrobial Screening System (Part 1)
5. Analysis of Residual Antimicrobials in Meat with Antimicrobial Screening System (Part 2)
6. Microchip Electrophoresis-Based Quantitative Determination of Composition of Blended Meat
7. Determination of Chemical Contaminants in Marine Fish by GCMS/MS using QuEChERS as an Extraction Method
8. Analysis of Diarrhetic Shellfish Toxin Using Triple Quadrupole LC/MS/MS (LCMS-8050)
9. Highly-Sensitive Detection of Multiple Porcine-Specific Peptides in Processed Foods by LC/MS/MS Method
10. Development of Sensitive and Selective Methods for Identification of Marine Toxins by Liquid Chromatography Tandem Mass Spectrometry
11. Multi-Residue Veterinary Drug Analysis of >200 Compounds using MRM Spectrum Mode by LC-MS/MS
12. Sensitive Detection of Pork DNA in Processed Meat Products on PCR-MultiNA Platform
13. Quantitative Analysis of Veterinary Drugs Using the Shimadzu LCMS-8050 Triple Quadrupole Mass Spectrometer
14. Determination of Nitrofurans Metabolites in Fish Matrix by LCMS-8045
15. Determination of Sulfonamide Residues in Pork Using LCMS-8045
16. Determination of Quinolone Antibiotic Residues in Chicken by Ultra-High Performance Liquid Chromatography Coupled with Triple Quadrupole Mass Spectrometry
17. Highly Sensitive and Rapid Analysis of Synthetic Dyes in Seafood by LC/MS/MS

Application News

No. AD-0169

Food Analysis / ICPMS-2030

Analysis of Trace Elements in Certified Fish Sample with ICP-MS

□ Introduction

Fish is one of the most important food resource that is widely consumed in many parts of the world due to its high protein content, low saturated fats and omega-3 fatty acid. However, because of industrial discharges from human activities, fish may have trace levels of heavy metals such as arsenic, cadmium, lead, mercury and nickel which are absorbed from the surrounding waters and the foods they eat. Not only do these heavy metals accumulate in organisms and circulate in food chain, they also remain in the sediments of the ecosystem in the long term [1]. The toxicity of these metals poses a concern to human health through the consumption of fish. Fish are the single largest sources of mercury and arsenic for man. Mercury is a known human toxicant and the primary sources of mercury contamination in man are through eating fish [2]. Minamata disease is a methylmercury poisoning associated with the daily consumption of large quantities of fish and shellfish heavily contaminated with the toxic chemical [3]. Here, Shimadzu ICPMS-2030, an inductively coupled plasma mass spectrometer (ICP-MS) was used to conduct a simultaneous analysis of elements in fish. In addition to being highly sensitive, the ICPMS-2030 uses a helium gas collision system that greatly reduces the spectral interference caused by argon and chlorine.

□ Experimental

The sample used in this analysis was Fish Protein Certified Reference Material for Trace Metals (DORM-4) from National Research Council Canada. There were two sets of preparation. The sample, 0.5 g, was placed in a digestion vessel followed by addition of 5.0 mL of concentrated nitric acid, 2.0 mL of hydrogen peroxide and 1.0 mL of water. The mixture was digested using microwave-assisted digestion system based on AOAC 999.10 procedure. After the digestion process, deionized water was added to the digested sample to a final total volume of 200.0 mL.

The calibration standards were prepared from 1000 ppm copper (Cu), iron (Fe) and zinc (Zn) standards, and 100 ppm ICP multi-element standard solution IX, which contains arsenic (As), cadmium (Cd), chromium (Cr), mercury (Hg), nickel (Ni), lead (Pb) and selenium (Se). The internal standards were prepared from 1000 ppm bismuth (Bi), germanium (Ge), indium (In) and scandium (Sc) standards and diluted to a concentration of 10 ppb with pure water. The standard solutions were purchased from Merck Millipore, Germany. Type E-1 ultra pure water with resistivity of 18 Ω W was used. Four different calibration ranges were prepared to cover the range of the elements based on the certified values. The calibration standards were acid matched to the digested samples.

Measurement was conducted using the Shimadzu ICPMS-2030 ICP-MS spectrometer, equipped with the mini-torch and helium (He) gas collision system. The mini-torch reduces running cost associated with argon gas usage. The helium gas collision system reduces spectral interference caused by polyatomic ions, for example, $^{40}\text{Ar}^{16}\text{O}$ that interferes with measurement of ^{56}Fe , $^{40}\text{Ar}^{35}\text{Cl}$ that interferes with measurement of ^{75}As , and $^{40}\text{Ar}^{38}\text{Ar}$ that interferes with measurement of ^{78}Se . The typical measurement conditions are shown in Table 1. The elements, mass, and calibration ranges used are shown in Table 2.

Table 1. Instrument and measurement conditions

Instrument	: ICPMS-2030
Radio Frequency Power	: 1.20 (kW)
Sampling Depth	: 6 (mm)
Plasma Gas Flow Rate	: 8.0 (L/min)
Auxiliary Gas Flow Rate	: 1.10 (L/min)
Nebulizer Gas Flow Rate	: 0.60 (L/min)
Nebulizer	: Coaxial Nebulizer
Spray Chamber	: Cyclone Chamber (electronic cooling)
Plasma Torch	: Mini-torch
Collision gas	: He

Table 2. Elements, mass and calibration ranges

Element	Mass	Calibration Range
As	75	0 to 20 ppb
Cd	111	
Cr	52	
Hg	202	
Ni	60	
Pb	208	
Se	78	
Cu	65	0 to 100 ppb
Fe	56	0 to 2000 ppb
Zn	66	0 to 200 ppb

Results and Discussion

The quantitative results for the trace elements were within the certification range of Fish Protein CRM DORM-4 as shown in Table 3.

The instrument detection limits (IDL) and the limits of quantitation (LOQ) are shown in Table 4. The IDL is calculated as three times the standard deviation of 10 replicate measurements of a calibration blank, and the LOQ is calculated as ten times the standard deviation of 10 replicate measurements of a calibration blank.

Table 3. Quantitation results of Fish CRM DORM-4

Element	Fish CRM DORM-4		
	Measured Value (mg/kg)	(Duplicate) Measured Value (mg/kg)	Certified Value (mg/kg)
As	6.59	6.69	6.80 ± 0.64
Cd	0.299	0.298	0.306 ± 0.015
Cr	1.88	1.89	1.87 ± 0.16
Cu	15.6	15.5	15.9 ± 0.9
Fe	326	328	341 ± 27
Hg	0.415	0.360	0.410 ± 0.055
Ni	1.31	1.29	1.36 ± 0.22
Pb	0.388	0.389	0.416 ± 0.053
Se	3.44	3.51	3.56 ± 0.34
Zn	55.0	53.3	52.2 ± 3.2

Table 4. Detection Limits

Element	IDL (ppb)	LOQ (ppb)
As	0.003	0.0097
Cd	0.001	0.0044
Cr	0.005	0.018
Cu	0.02	0.065
Fe	0.06	0.20
Hg	0.003	0.011
Ni	0.01	0.040
Pb	0.004	0.014
Se	0.01	0.045
Zn	0.03	0.091

Conclusions

The ICPMS-2030 can provide a sensitive multi-element analysis of the trace elements in fish accurately, even for low concentration of Cd, Hg and Pb.

References

- Sreenivasa Rao. J., Vasudeva Rao. Y., Devindra. S and Longvah. T. (2014). Analysis of heavy metal concentrations in Indian marine fish using ICP-MS after closed vessel micro wave digestion method. *International Journal of Analytical and Bioanalytical Chemistry* 4(3): 67-73.
- F. Emami Khansari, M. Ghazi-Khansari, M. Abdollahi (2005). Heavy metals content of canned tuna fish. *Food Chemistry* 93: 293-296.
- Noriyuki Hachiya (2006). The history and the present of Minamata disease. *Japan Medical Association Journal* 49 (3): 112-118.

Application News

No. AD-0163

Food Analysis / ICPE-9800 Series

Analysis of Trace Elements in Fish Sample with ICP-AES (ICP-OES) on ICPE-9800

□ Introduction

Fish is one of the most important food resource that is widely consumed in many parts of the world due to its high protein content, low saturated fats and omega-3 fatty acid. It is also rich in calcium and phosphorus. However, because of industrial discharges from human activities, fish may have trace levels of toxic elements such as arsenic, cadmium and lead which are absorbed from the environmental water and the foods they eat. The toxicity of these metals poses a concern to human health through the consumption of fish. Here, Shimadzu ICPE-9820, a simultaneous inductively coupled plasma atomic emission spectrometer (ICP-AES) was used to conduct a simultaneous analysis of elements in fish. The ICPE-9820, with its mini-torch plasma and spectrometer permitting all elements / all wavelengths simultaneous analysis, provides high sensitivity and throughput measurement while reducing running cost.

□ Experimental

The sample used in this analysis was Fish Protein Certified Reference Material for Trace Metals (DORM-4), from National Research Council Canada. There were two sets of preparation. The sample, 0.5 g, was placed in a digestion vessel followed by addition of 5.0 mL of concentrated nitric acid, 2.0 mL of hydrogen peroxide and 1.0 mL of water. The mixture was digested using microwave-assisted digestion system based on AOAC 999.10 procedure. After the digestion process, deionized water was added to the digested sample to a final total volume of 20.0 mL.

The calibration standards were prepared from 1000 ppm copper (Cu), iron (Fe) and zinc (Zn) standards, and 100 ppm ICP multi-element standard solution IX, which contains arsenic (As), cadmium (Cd), chromium (Cr), nickel (Ni), lead (Pb) and selenium (Se). The standard solutions were purchased from Merck Millipore, Germany. Type E-1 ultra pure water with resistivity of 18 ΩW was used. Three different calibration ranges were prepared to cover the range of the elements based on the certified values. The calibration standards were acid matched to the digested samples.

Measurement was conducted using the Shimadzu ICPE-9820 simultaneous ICP-AES spectrometer, equipped with the mini-torch.

The typical measurement conditions are shown in Table 1. The elements, wavelength and calibration ranges used are shown in Table 2.

Table 1. Instrument and measurement conditions

Instrument	: ICPE-9820	
Radio Frequency Power	: 1.20	(kW)
Plasma Gas Flow Rate	: 10.0	(L/min)
Auxiliary Gas Flow Rate	: 0.60	(L/min)
Nebulizer Gas Flow Rate	: 0.70	(L/min)
Nebulizer	: Coaxial Nebulizer	
Spray Chamber	: Cyclone Chamber	
Plasma Torch	: Mini-torch	
Observation	: Axial	

Table 2. Elements, wavelength and calibration ranges

Element	Wavelength	Concentration Range
As	193.759	0 to 0.2 ppm
Cd	214.438	
Cr	205.552	
Ni	231.604	
Pb	220.353	
Se	203.985	0 to 2 ppm
Cu	224.700	
Zn	206.200	0 to 20 ppm
Fe	239.147	

Results and Discussion

The quantitative results for the trace elements were within the certification range of Fish Protein CRM DORM-4 as shown in Table 3. The spectral profiles of standards and samples are displayed in Figure 1.

Conclusions

The ICPE-9800 can provide simultaneous analysis of trace elements in fish CRM sample with high accuracy, which include low concentrations of Cd and Pb.

Table 3. Quantitation results of Fish CRM DORM-4 on ICPE-9800

Element	Fish CRM DORM-4			IDL (ppm)*
	Measured Value (mg/kg)	(Duplicate) Measured Value (mg/kg)	Certified Value (mg/kg)	
As	6.7	6.6	6.80 ± 0.64	0.008
Cd	0.298	0.303	0.306 ± 0.015	0.0002
Cr	1.85	1.76	1.87 ± 0.16	0.0007
Cu	15.1	15	15.9 ± 0.9	0.002
Fe	336	323	341 ± 27	0.03
Ni	1.24	1.29	1.36 ± 0.22	0.0004
Pb	0.43	0.45	0.416 ± 0.053	0.002
Se	3.7	3.8	3.56 ± 0.34	0.01
Zn	51.7	49.4	52.2 ± 3.2	0.0003

*Instrument Detection limit (IDL) is calculated as three times the standard deviation of 10 replicate measurements of a calibration blank

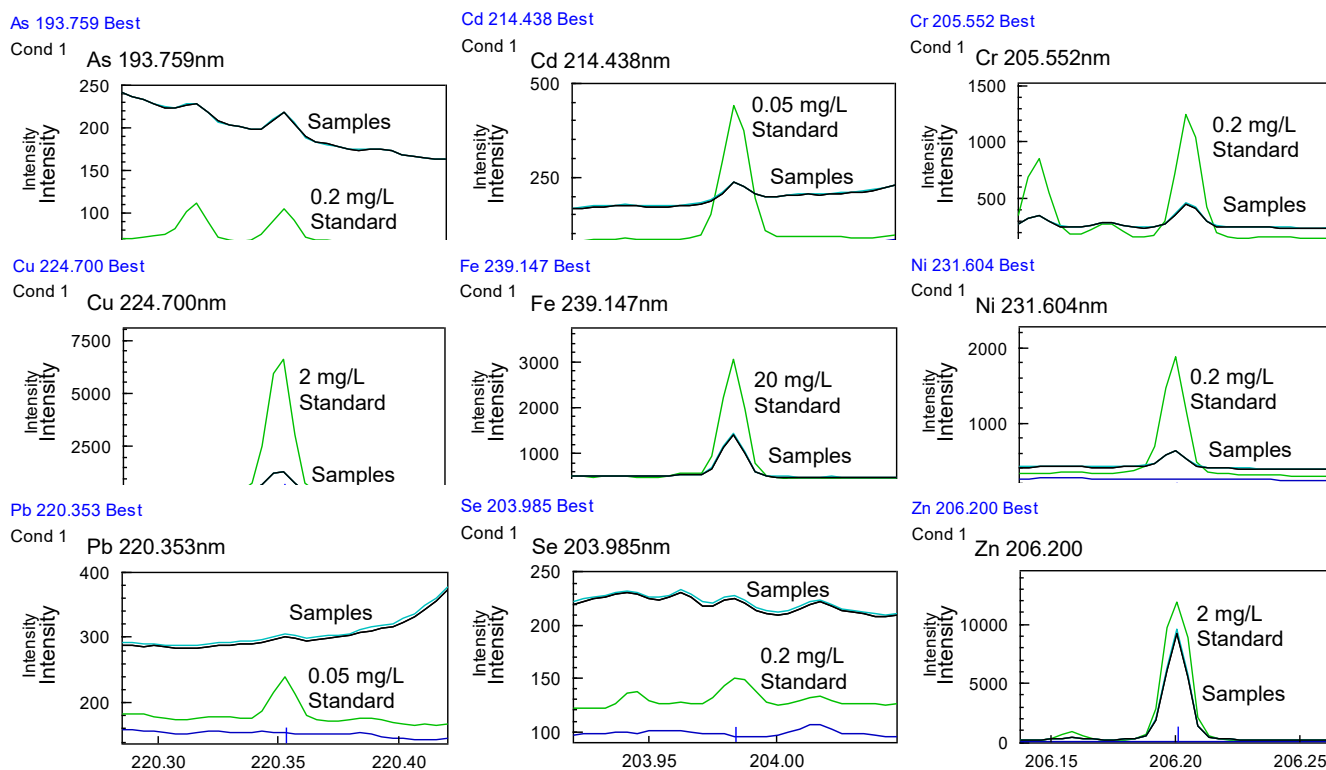

Multi-residual quantitative analytical method for antibiotics in sea food by LC/MS/MS

ASMS 2017 TP 198

Anant Lohar, Shailendra Rane, Ashutosh Shelar,
Shailesh Damale, Rashi Kochhar, Purushottam Sutar,
Deepti Bhandarkar, Ajit Datar, Pratap Rasam and
Jitendra Kelkar
Shimadzu Analytical (India) Pvt. Ltd., 1 A/B,
Rushabh Chambers, Makwana Road, Marol, Andheri (E),
Mumbai-400059, Maharashtra, India.

Multi-residual quantitative analytical method for antibiotics in sea food by LC/MS/MS

Introduction

Antibiotics are widely used in agriculture as growth enhancers, disease treatment and control in animal feeding operations. Concerns for increased antibiotic resistance of microorganisms have prompted research into the environmental occurrence of these compounds. Assessment of the environmental occurrence of antibiotics depends on development of sensitive and selective analytical methods based on new instrumental technologies.

LC/MS/MS method has been developed for quantitation of multi-residual antibiotics (Table 1) from sea food sample using LCMS-8040, a triple quadrupole mass spectrometer from Shimadzu Corporation, Japan. Simultaneous analysis of multi-residual antibiotics often exhibit peak shape distortion owing to their different chemical nature. To overcome this, autosampler pre-treatment feature was used ^[1].

Table 1. List of antibiotics

Sr.No.	Name of group	Name of compound	Number of compounds
1	Fluoroquinolones	Flumequine, Oxolinic Acid, Ciprofloxacin, Danofloxacin, Difloxacin.HCl, Enrofloxacin, Sarafloxacin HCl Trihydrate, Nalidixic Acid	8
2	Sulfonamides	Sulfadimethoxine, Sulfadoxine, Sulfachlorpyridazine, Sulfamethoxyipyridazine, Sulfadimidine, Sulfamethizole, Sulfamerazine, Sulfathiazole, Sulfamethizole, Sulfadiazine, Sulfapyridine	11
3	Dyes	Crystal Violet , Leucocrystal violet, Malachite green, Leucomalachite green	4
4	Anthelmintics	Albendazole, Albendazole Sulfone, Albendazole Sulfoxide, Albendazole-2-aminosulfone , Fenbendazole, Flubendazole	6
5	Nitroimidazoles	Ronidazole, Metronidazole, Dimetronidazole	3
6	Phenylbutazone	Phenylbutazone	1
7	Macrolides	Erythromycin, Spiramycin, Tilmicosin, Tylosin Tartarate, Trimethoprim	5

Methods and Materials

Sample preparation

The antibiotic standards procured from Sigma-Aldrich were used for the analysis. All individual standards stock were prepared in the methanol. Further mixture of all antibiotics were prepared in methanol. This stock was serially diluted to prepare calibration levels ranging from 0.5 ppb to 50 ppb in methanol for solvent standard and in matrix for matrix matched standard calibration. Commercially available shrimp sample were used for analysis. The shrimp was finely crushed by using a sample

crushing mixer. Crushed sample was transferred to 50 ml centrifuge tube. To this 10 mL of acidified acetonitrile was used for extraction of anti-biotics from the shrimp sample, because some of the antibiotics require acidic condition for extraction. Solution was then centrifuged at 4°C, 8000 rpm for 5 mins. Further dSPE clean-up was given to the supernatant and dSPE cleanup extract was filtered through 0.2 micron filter and injected on LCMS-8040.

Multi-residual quantitative analytical method for antibiotics in sea food by LC/MS/MS

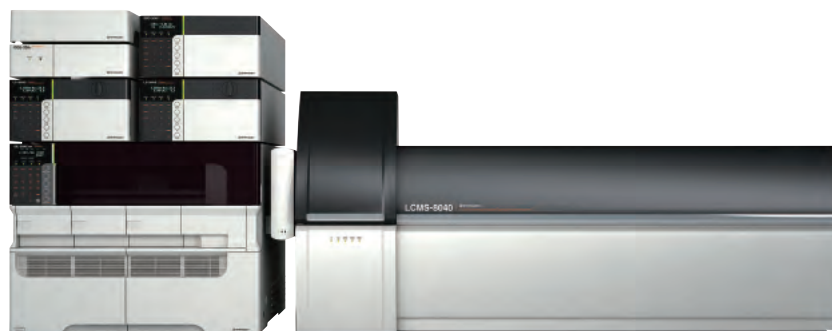

Figure 1. LCMS-8040 triple quadrupole mass spectrometer by Shimadzu

LCMS-8040 triple quadrupole mass spectrometer by Shimadzu, sets a new benchmark in triple quadrupole technology with an unsurpassed sensitivity (UFsensitivity), ultra fast scanning speed of 15,000 u/sec (UFscanning) and polarity switching speed of 15 msec (UFswitching). This system ensures highest quality of data, with very high degree of reliability.

LC/MS/MS analysis

All antibiotics i.e. 11 Sulfonamides, 8 Fluoroquinolones, 4 Dyes, 6 Antihelminthics, 3 Nitroimidazole, 5 Macrolides and Phenylbutazone were simultaneously analyzed using Ultra High Performance Liquid Chromatography (UHPLC) Nexera coupled with LCMS-8040 triple quadrupole system (Shimadzu Corporation, Japan). The details of analytical conditions are given in Table 2.

Table 2. Optimized LC/MS/MS conditions for antibiotic analysis

Column	: Shim-pack GIST Phenyl (75mm L X 3.0mm I.D, 2 μ m)
Mobile phase	: A- 2mM ammonium formate + 0.002 % formic acid in water : B- 2mM ammonium formate + 0.002 % formic acid in methanol
Flow rate	: 0.4 mL/min
Gradient program (B %)	: 0.01-1 min \rightarrow 10 (%); 1-5 min \rightarrow 10-70 (%); 5-9 min \rightarrow 70-95 (%); 9-11 min \rightarrow 95 (%); 11-11.5 min \rightarrow 95-10 (%); 11.5-15 min \rightarrow 10 (%)
Injection vol.	: 5 μ L
Column temperature	: 40°C
MS interface	: Electro Spray Ionization (ESI)
Nitrogen gas flow	: Nebulizing gas 2L/min; Drying gas 10L/min
MS temperature	: Desolvation line 250°C; Heating block 400°C

Multi-residual quantitative analytical method for antibiotics in sea food by LC/MS/MS

Table 3. Details of MRM transitions

Sr.No.	Name of Compound	Quantifier ions
1	Sulfamethoxypyridazine	281.10>156.05
2	Sulfamethizole	271.10>156.00
3	Sulfamerazine	265.15>92.10
4	Sulfadiazine	251.10>156.00
5	Sulfapyridine	250.10>92.10
6	Sulfamethazin	279.15>186.00
7	Sulfamethoxazole	254.10>155.95
8	Sulfadimethoxine	311.10>156.00
9	Sulfadoxine	311.10>156.10
10	Sulfachlorpyridazine	285.10>155.95
11	Sulfathiazole	256.10>156.05
12	Albendazole	266.10>234.00
13	Albendazole sulfone	298.10>159.00
14	Albendazole sulfoxide	282.20>240.00
15	Albendazole 2 aminosulfone	240.10>133.05
16	Fendendazole	300.10>268.00
17	Flubendazole	314.15>282.15
18	Morantel	221.05>111.10
19	Flumequine	262.15>201.95
20	Oxolinic acid	262.15>160.05
21	Ciprofloxacin	332.20>314.20
22	Difloxacin	400.10>382.15
23	Enrofloxacin	360.20>342.25
24	Sarafloxacin	386.15>368.05
25	Nalidixic Acid	233.15>187.05
26	Danofloxacin	358.20>340.20
27	Ronidazole	201.10>140.00
28	Metronidazole	172.20>127.90
29	Dimetronidazole	142.20>96.10
30	Leucocrystal violet	374.20>358.15
31	Malachite green	329.20>313.15
32	Leucomalachite green	331.20>239.10
33	Crystal violet	372.20>356.20
34	Spiramycin II	422.20>101.15
35	Tilmicosin I	435.20>98.90
36	Tylosin tartarate I	916.30>174.20
37	Trimethoprim	291.25>230.20
38	Neo spiramycin II	366.20>174.10
39	Phenylbutazone	309.15>77.10
40	Erythromycin	734.30>576.30

Multi-residual quantitative analytical method for antibiotics in sea food by LC/MS/MS

Results

Analysis was performed using aqueous as well as matrix matched standards. The MRM transitions used for these analysis are given in Table 3. Auto MRM optimization feature was used for optimization for MRM transitions. Linearity studies were carried out using external calibration method and linearity results are tabulated in Table 4.

The matrix matched calibration levels were prepared and injected in segmented MRM mode. The calibration curve of all antibiotics are shown in Figure 4 to Figure 6 and the correlation coefficient >0.99 was obtained for all compounds.

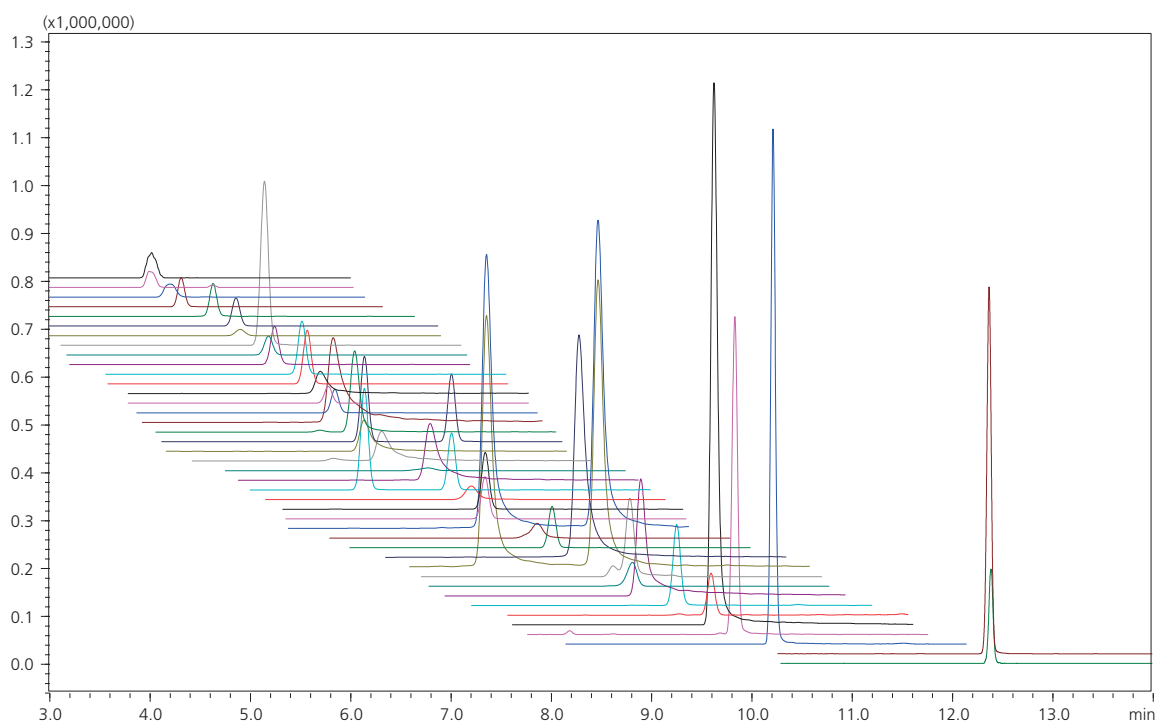

Figure 2. Chromatogram of matrix match standards of 2 ppb

Multi-residual quantitative analytical method for antibiotics in sea food by LC/MS/MS

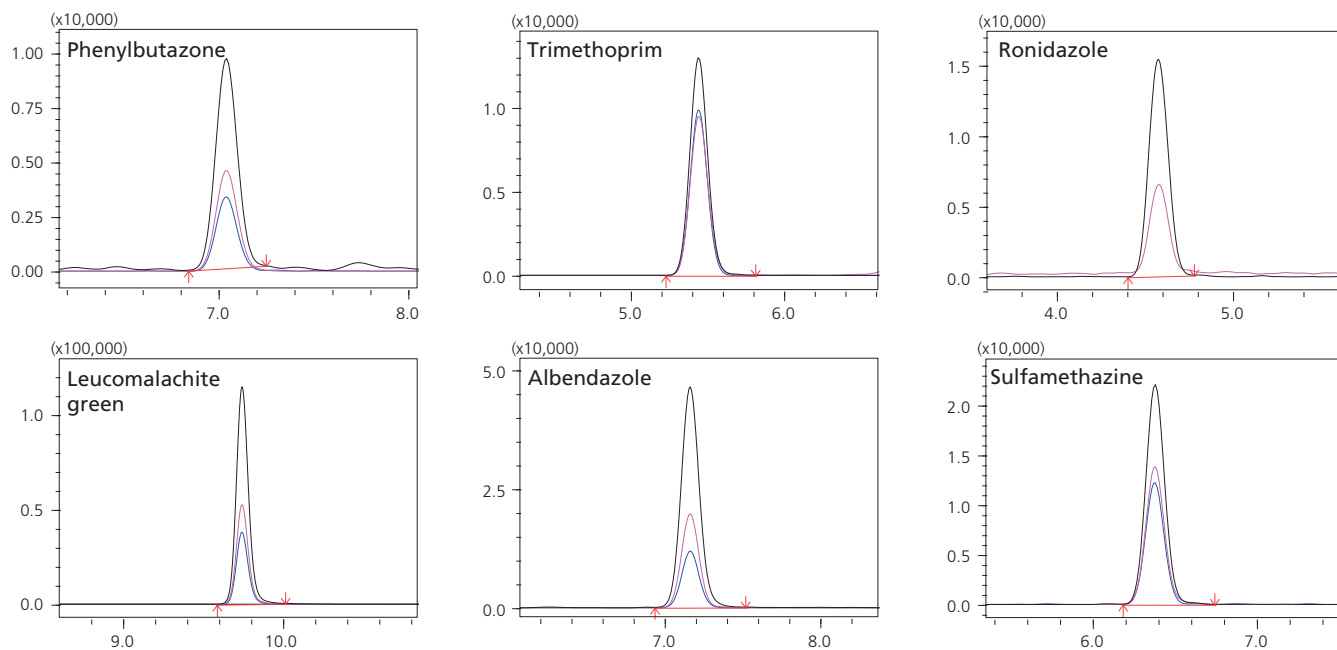

Figure 3. Extracted ion chromatogram of representative antibiotics

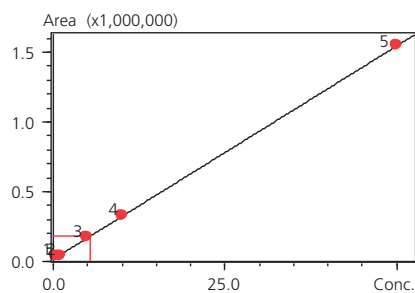

Figure 4. Sulfamethazine

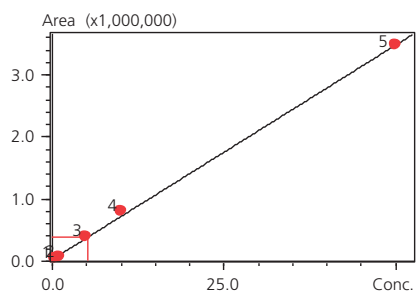

Figure 5. Albendazole

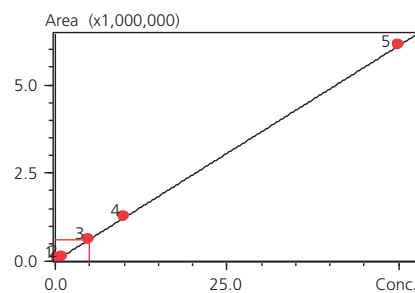

Figure 6. Leucomalachite green

Multi-residual quantitative analytical method for antibiotics in sea food by LC/MS/MS

Table 4. Result table for matrix matched standard calibration and recovery at different level

Sr.No.	Class / category	Name of Compound	MRPL in ppb	LOQ achieved in ppb	Linearity range in ppb	Recovery		
						0.5 ppb	1 ppb	2 ppb
1	Fluoroquinolones	Flumequine	600	0.5	0.5-50	106.8	88.76	87.5
2		Oxolinic Acid	100	0.5	0.5-50	89.32	97.7	97.03
3		Ciprofloxacin	100	2	0.5-50	NA	NA	105.36
4		Difloxacin.HCL	300	2	0.5-50	NA	NA	84.06
5		Enrofloxacin	100	2	0.5-50	NA	NA	88.52
6		Sarafloxacin	30	1	0.5-50	NA	117.42	86.52
7		Nalidixic Acid	Reporting>LOQ	0.5	0.5-50	100.82	105.52	92.6
8	Sulfonamides	Sulfadimethoxine	100	0.5	0.5-50	107.38	104.55	87.9
9		Sulfadoxine		0.5	0.5-50	102.88	89.41	89.54
10		Sulfachlorpyridazine		0.5	0.5-50	80.9	98.12	86.14
11		Sulfamethoxyipyridazine		0.5	0.5-50	116.08	108.14	88.95
12		Sulfamethizole		0.5	0.5-50	82.56	87.7	89.78
13		Sulfamerazine		0.5	0.5-50	113.78	78.61	89.88
14		Sulfathiazole		0.5	0.5-50	79.96	83.28	89.46
15		Sulfamethazin		0.5	0.5-50	90.8	90.06	90.47
16		Sulfadiazine		0.5	0.5-50	103.66	91.11	93.93
17		Sulfapyridine		0.5	0.5-50	93.72	84.48	101.36
18	Sulfamethoxazole	0.5	0.5-50	112.68	111.82	96.3		
19	Dyes	Leucocrystal violet	Nil	0.5	0.5-50	56.5	62.45	57.75
20		Crystal violet		0.5	0.5-50	94.56	117.22	103.44
21		Leucomalachite green	2	0.5	0.5-50	104.94	99.64	88.48
22		Malachite green		0.5	0.5-50	103.88	73.97	64.352
23	Anthelminthics	Albendazole	50	0.5	0.5-50	79.12	87.79	81.65
24		Albendazole Sulfone	50	0.5	0.5-50	84.74	97.29	98.49
25		Albendazole Sulfoxide	50	0.5	0.5-50	99.56	77.13	84.98
26		Albendazole-2-aminosulfone	50	1	0.5-50	NA	79.08	75.13
27		Fenbendazole	50	0.5	0.5-50	111.62	88.91	88.99
28		Flubendazole	50	0.5	0.5-50	108.34	100.81	97.33
29		Morantel	50	0.5	0.5-50	87.52	95.31	100.6
30	Fenbendazole sulfone	50	0.5	0.5-50	78.44	84.16	93.13	
31	Nitroimidazoles	Ronidazole	3	0.5	0.5-50	110.82	95.99	91.68
32		Metronidazole	3	0.5	0.5-50	108.16	96.71	82.89
33		Dimetronidazole	3	2	0.5-50	NA	NA	89.9
34	Phenylbutazone	Phenylbutazone	5	1	0.5-50	NA	107.11	96.11
35	Macrolides	Spiramycin	NA	1	0.5-50	NA	128.75	87.41
36		Tilmicosin	NA	0.5	0.5-50	114.14	89.45	84.68
37		Tylosin Tartarate	NA	0.5	0.5-50	119.98	94.15	105.11
38		Trimethoprim	NA	0.5	0.5-50	89.62	85.55	78.88
39		Neo Spiramycin	NA	5	0.5-50	70.34	75.9	79.23

Multi-residual quantitative analytical method for antibiotics in sea food by LC/MS/MS

Conclusion

- The recovery obtained for most of the compounds are well within the acceptance range of 70-120%.
- This method will improve the overall turn around time of sample analysis, along with reduction in per sample cost.

Reference

- [1] Defoirdt, T.; Sorgeloos, P.; Bossier, P. Alternatives to Antibiotics for the Control of Bacterial Disease in Aquaculture. *Curr. Opin. Microbiol.* 2011, 14, 251–258.

Disclaimer: The products and applications in this presentation are intended for Research Use Only (RUO). Not for use in diagnostic procedures.

Application News

No.L509

High Performance Liquid Chromatography

Analysis of Residual Antimicrobials in Meat with Antimicrobial Screening System (Part 1)

In May 2006, the positive list system took effect in Japan that, in principle, prohibited the sale of food products with residual levels of pesticides, animal feed additives, and veterinary drugs (collectively referred to as agricultural chemicals, etc.) above the level determined by the Minister of Health, Labour and Welfare.¹⁾

Antimicrobials are a type of veterinary drug and animal feed additive, and used for the treatment and prevention of disease in livestock and marine products. Quinolones and sulfonamides are two common groups of synthetic antimicrobials.

Shimadzu's quick and simple antimicrobial screening system is capable of screening 24 antimicrobials compounds. An example screening analysis targeting 12 widely used quinolones (old quinolones, new quinolones) is described here. Application News No.L510 also describes an example screening analysis targeting 12 antimicrobials including sulfonamides (also including antifolates).

Antimicrobial Screening System

Shimadzu's antimicrobial screening system is able to determine whether levels of antimicrobials subject to regulation in various countries are above a maximum residue limit (MRL). Table 1 shows MRLs for the target quinolones.

The system uses an i-Series integrated HPLC instrument and RF-20Axs high-sensitivity fluorescence detector, and comes with a sample pretreatment method, analytical column, analytical method files, and a UV spectral library that allow for immediate operation after installation. When the analysis method capable of simultaneous component analysis is used, the system can be used for simultaneous screening of multiple components. The determination of whether MRL have been exceeded can be viewed immediately after the system completes analysis. The photodiode array (PDA) detector built into the i-Series instrument supports highly accurate screening with compound identification based on retention times as well as UV spectra.

Table 1 Maximum Residue Limits and Sample Solution Concentration of Screening Target Compounds

Compound	MRL (mg/kg)	Sample Solution Concentration (mg/L)
1 Marbofloxacin	0.01	0.025
2 Ofloxacin	0.01	0.025
3 Ciprofloxacin	0.01	0.025
4 Danofloxacin	0.01	0.025
5 Enrofloxacin	0.01	0.025
6 Orbifloxacin	0.01	0.025
7 Sarafloxacin	0.01	0.025
8 Difloxacin	0.01	0.025
9 Oxolinic acid	0.01	0.025
10 Nalidixic acid	0.01	0.025
11 Flumequine	0.01	0.025
12 Piromidic acid	0.01	0.025

Sample Pretreatment

Sample pretreatment was performed based on Simultaneous Analysis Method I for Veterinary Drugs by HPLC (Livestock and Marine Products).^{2),3)} After acetonitrile extraction and removing fat by acetonitrile/hexane partitioning, sample solution was prepared by evaporation then redissolution. Fig. 1 shows the sample pretreatment protocol, and Table 1 shows sample solution concentrations after pretreatment. Refer to the instruction manual of the system for the details of the sample pretreatment procedure.

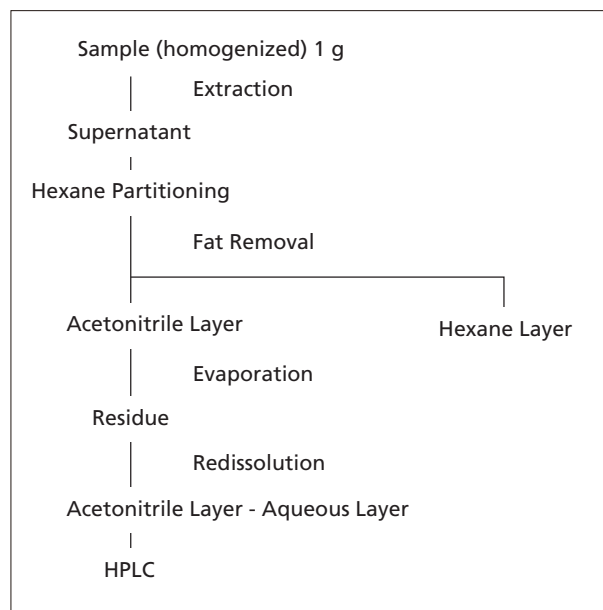

Fig. 1 Sample Pretreatment Protocol

Table 2 Analytical Conditions

System	: LC-2040C 3D, RF-20Axs
Column	: Shim-pack FC-ODS (150 mm L. x 4.6 mm I.D., 3 μm)
Mobile Phase	: A) 20 mM (Sodium) Phosphate Buffer Containing 0.1 M Sodium Perchlorate B) Acetonitrile/Methanol=90/10
Time Program	: Gradient Elution
Flowrate	: 1.0 mL/min
Column Temp.	: 40 °C
Injection Volume	: 5 μL
Detection	: <LC-2040C 3D> 280 nm <RF-20Axs> Ex at 290 nm, Em at 495 nm Ex at 325 nm, Em at 365 nm
Cell Temp.	: 40 °C (PDA), 30 °C (RF)

■ Analysis of Quinolones in Meat

Chicken and pork were used as samples. Chromatograms of the pretreated matrix solutions (blue line), matrix solutions spiked with standard solution to create matrix standard solutions (red line), and neat standard solution (black line) are shown in Fig. 2. Standard solution was added to matrix solutions to create matrix standard solutions with quinolone concentrations of 0.01 mg/kg. The analytical conditions are shown in Table 2. Analysis was performed with the fluorescence detector in dual wavelength mode. New quinolones (compounds 1 to 8 in Table 1) were detected at an excitation wavelength of 290 nm and fluorescence wavelength of 495 nm, and old quinolones (compounds 9 to 11 in Table 1) were detected at an excitation wavelength of 325 nm and fluorescence wavelength of 365 nm. Piromidic acid (compound 12 in Table 1) differs from other quinolones in exhibiting no fluorescence characteristics, and was detected using the PDA detector. Employing the analytical conditions shown, all 12 compounds were separated and eluted in approximately 22 minutes.

■ Similarity Calculation Using UV Spectral Library

The PDA-detected compound (piromidic acid) can be analyzed qualitatively based on UV spectra as well as retention times. Its spectrum can be checked for similarity against the library spectra. Fig. 3 shows a UV spectrum of piromidic acid in pork matrix spiked with a standard solution of piromidic acid at threshold concentration. The degree of similarity with the library spectrum was 0.998.

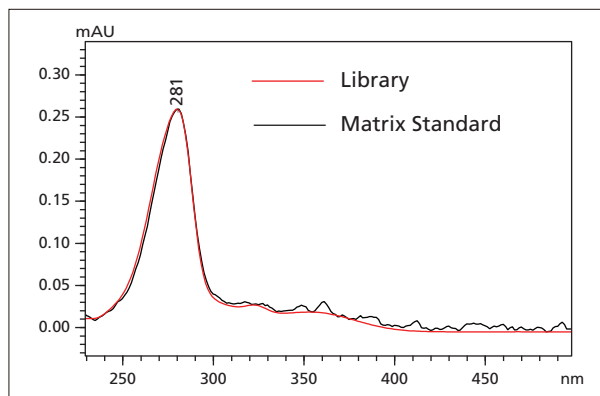

Fig. 3 Spectra of Piromidic Acid

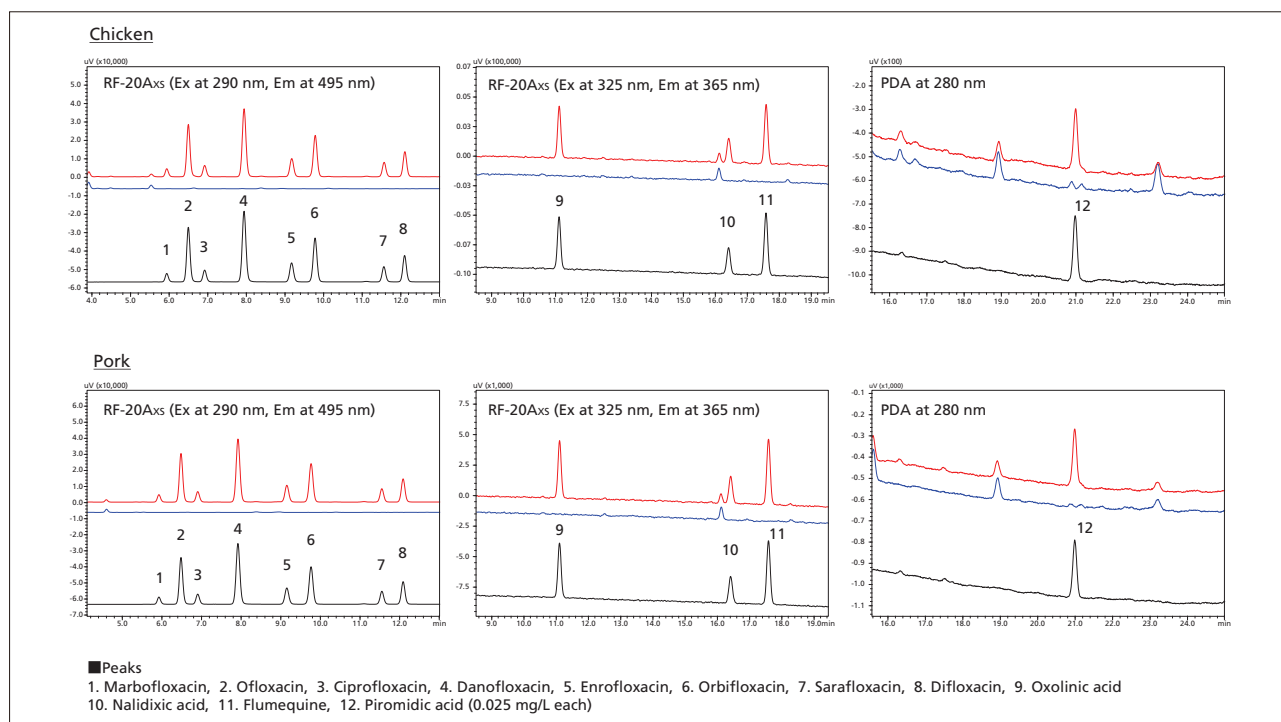

Fig. 2 Chromatograms of Chicken and Pork:
Matrix Standard Solution (Red Line), Matrix Solution (Blue Line), Neat Standard Solution (Black Line)

<References>

- 1) The Japanese Positive List System for Agricultural Chemical Residues in Foods, Japan's Ministry of Health, Labour and Welfare
- 2) Multiresidue Method I for Veterinary Drugs, Etc. by HPLC (Animal and Fishery products)
Director Notice about Analytical Methods for Residual Compositional Substances of Agricultural Chemicals, Feed Additives, and Veterinary Drugs in Food (Syoku-An No. 0124001, January 24, 2005. Final amendments were made on May 26, 2006.), Japan's Ministry of Health, Labour and Welfare
- 3) "Standard methods of analysis in food safety regulation (for veterinary drugs and animal feed additives)" p.26-43, Japan Food Hygiene Association (2003), edited under the supervision of the Japan's Ministry of Health, Labour and Welfare

First Edition: Oct. 2016



For Research Use Only. Not for use in diagnostic procedure.

This publication may contain references to products that are not available in your country. Please contact us to check the availability of these products in your country.

The content of this publication shall not be reproduced, altered or sold for any commercial purpose without the written approval of Shimadzu. Company names, product/service names and logos used in this publication are trademarks and trade names of Shimadzu Corporation or its affiliates, whether or not they are used with trademark symbol "TM" or "®". Third-party trademarks and trade names may be used in this publication to refer to either the entities or their products/services. Shimadzu disclaims any proprietary interest in trademarks and trade names other than its own.

The information contained herein is provided to you "as is" without warranty of any kind including without limitation warranties as to its accuracy or completeness. Shimadzu does not assume any responsibility or liability for any damage, whether direct or indirect, relating to the use of this publication. This publication is based upon the information available to Shimadzu on or before the date of publication, and subject to change without notice.

Shimadzu Corporation
www.shimadzu.com/an/

Application News

No.L510

High Performance Liquid Chromatography

Analysis of Residual Antimicrobials in Meat with Antimicrobial Screening System (Part 2)

Antimicrobials are a type of veterinary drug and animal feed additive, and are used for the treatment and prevention of disease in livestock and marine products. Residual antimicrobials are often found in livestock and marine products, so threshold levels for antimicrobials are set by regulation to ensure the safety of the consumer based on amounts that do not harm human health.

Due to ongoing reports of recent cases of regulatory violations in various countries and the large number of compounds targeted for testing, there is a demand for quick and simple antimicrobial screening.

While Application News No.L509 described an example of using the antimicrobial screening system for screening 12 quinolone compounds, this Application News describes an example screening analysis of 12 antimicrobial target compounds including sulfonamides.

■ Sample Pretreatment

Sample pretreatment for analysis of residual antimicrobials in meat usually employs liquid-liquid extraction (and sometimes solid phase extraction), but this process takes time and effort. In this article, we employed a QuEChERS method designed to be more efficient and reduce pretreatment times. The QuEChERS method is used to pretreat vegetables and fruits for residual pesticide analysis.

After using the QuEChERS method to perform extraction and fat removal, sample solutions were prepared by evaporation and redissolution steps. Table 1 shows the maximum residue limits (MRLs) of target compounds and sample solution concentrations after sample pretreatment, and Fig. 1 shows the sample pretreatment protocol. Refer to the instruction manual of the system for the details of the sample pretreatment procedure.

Table 1 Maximum Residue Limits and Sample Solution Concentration of Screening Target Compounds

Compound	MRL (mg/kg)	Sample Solution Concentration (mg/L)
1 Sulfadiazine	0.01	0.025
2 Sulfamerazine	0.01	0.025
3 Sulfadimidine	0.01	0.025
4 Sulfamonomethoxine	0.01	0.025
5 Trimethoprim	0.01	0.025
6 Sulfamethoxazole	0.01	0.025
7 Ormetoprim	0.01	0.025
8 Sulfadimethoxine	0.01	0.025
9 Sulfaquinolaxaline	0.01	0.025
10 Pyrimethamine	0.01	0.025
11 Difurazon	0.01	0.025
12 Nicarbazin ^{*1}	0.01	0.025

*1: Concentration of N, N'-Bis(4-nitrophenyl)urea, the main constituent of nicarbazin.

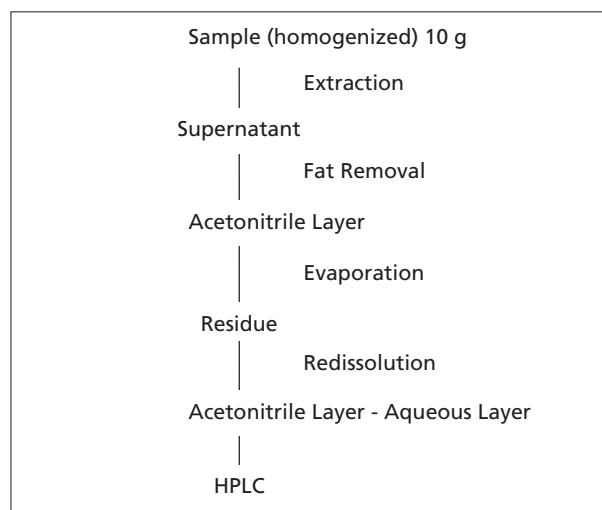

Fig. 1 Sample Pretreatment Protocol

■ Analysis of Antimicrobials Including Sulfonamides in Meat

Chicken and beef were used as samples. The analytical conditions are shown in Table 2. Chromatograms of the pretreated matrix solutions (blue line), matrix solutions spiked with standard solution to create matrix standard solutions (red line), and neat standard solution (black line) are shown in Fig. 2.

Standard solution was added to matrix solutions to make up antimicrobial concentrations, including sulfonamide concentrations, of 0.01 mg/kg in matrix standard solutions. Standard solutions were prepared to the sample solution concentrations listed in Table 1.

The photodiode array (PDA) detector (six-wavelength) built in the i-Series instrument was used for detecting all target compounds. Employing the analytical conditions shown, all 12 compounds were separated and eluted in approximately 25 minutes.

Table 2 Analytical Conditions

System	: LC-2040C 3D
Column	: Shim-pack FC-ODS (150 mm L. × 4.6 mm I.D., 3 μm)
Mobile Phase	: A) 20 mM (Sodium) Phosphate Buffer Containing 0.1 M Sodium Perchlorate B) Acetonitrile/Methanol=80/20
Time Program	: Gradient Elution
Flowrate	: 1.0 mL/min
Column Temp.	: 50 °C
Injection Volume	: 20 μL
Detection	: 240 nm 270 nm 280 nm 285 nm 350 nm 380 nm
Cell Temp.	: 40 °C

■ **Similarity Calculation Using UV Spectral Library**

All target compounds in this Application News can be analyzed qualitatively based on UV spectra as well as retention times. Sample spectra can be also checked for similarity against library spectra. Fig. 3 shows a UV spectrum of sulfaquinoxaline in a beef matrix spiked with a standard solution of sulfaquinoxaline at threshold concentration. Degree of similarity with the library spectrum was 0.997.

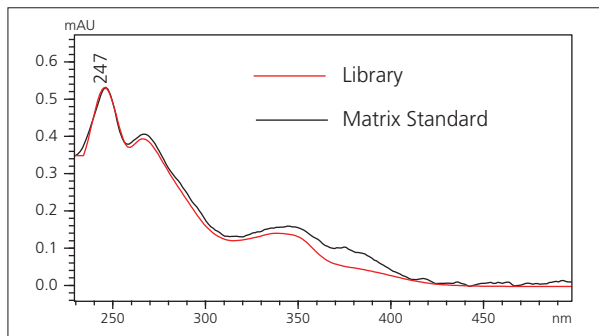

Fig. 3 Spectra of Sulfaquinoxaline

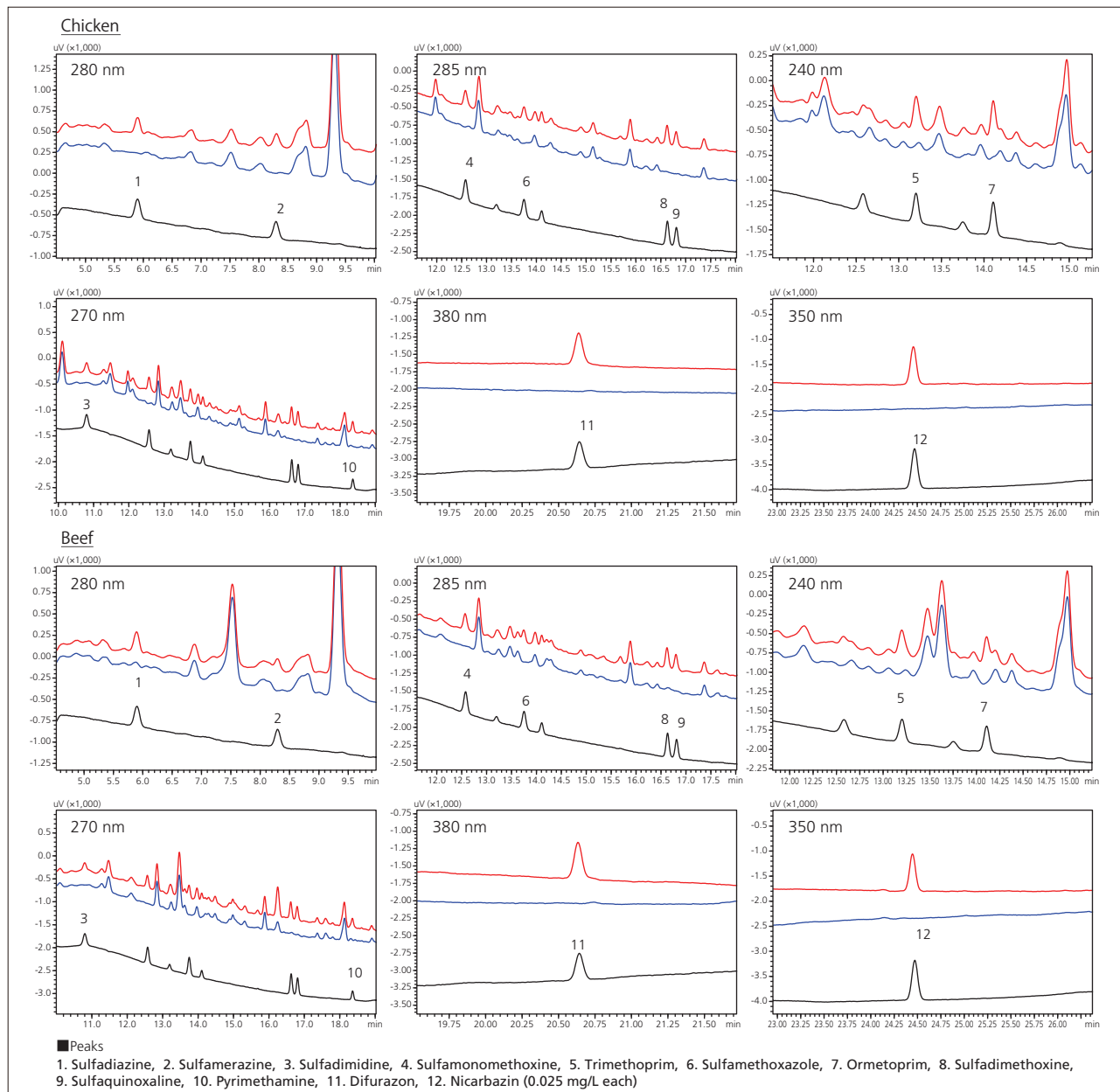

Fig. 2 Chromatograms of Chicken and Beef:
Matrix Standard Solution (Red Line), Matrix Solution (Blue Line), Neat Standard Solution (Black Line)

First Edition: Oct. 2016



For Research Use Only. Not for use in diagnostic procedure.

This publication may contain references to products that are not available in your country. Please contact us to check the availability of these products in your country.

The content of this publication shall not be reproduced, altered or sold for any commercial purpose without the written approval of Shimadzu. Company names, product/service names and logos used in this publication are trademarks and trade names of Shimadzu Corporation or its affiliates, whether or not they are used with trademark symbol "TM" or "®". Third-party trademarks and trade names may be used in this publication to refer to either the entities or their products/services. Shimadzu disclaims any proprietary interest in trademarks and trade names other than its own.

The information contained herein is provided to you "as is" without warranty of any kind including without limitation warranties as to its accuracy or completeness. Shimadzu does not assume any responsibility or liability for any damage, whether direct or indirect, relating to the use of this publication. This publication is based upon the information available to Shimadzu on or before the date of publication, and subject to change without notice.

Shimadzu Corporation
www.shimadzu.com/an/

Application News

MultiNA

No. MultiNA-013

Microchip Electrophoresis-Based Quantitative Determination of Composition of Blended Meat

LI Lixiao

Analytical Instruments Dept. Analytical Application Center Shimadzu (China) Co., LTD

Introduction

Adulterations of meat which jeopardize customer's health, benefit and confidence were disclosed recently in the world. For example, fake beef were made from horse and pork which are cheaper materials. It is difficult to distinguish meat species with vision and smell. To detect meat species, molecular biological approach is used based on specific DNA profiles of different varieties. With PCR primer designing towards to variety's specific DNA sequence, qualitative determination is achieved by evaluating PCR product size with electrophoresis. However, due to the strong sensitive of PCR approach, there is a risk of false positive with only qualitative determination. Therefore, quantitative determination is strongly required to obtain correct results for meat detection. In this report, a method for quantitative determination of composition of blended meat was developed based on microchip electrophoresis. With this method, blended meat of beef and pork were successfully determined quantitatively.

Experimental

Principle

For PCR, the relationship between the amount of PCR product of target gene and initial template DNA is shown in the following:

$$X_n = X_0(1 + E)^n$$

X_n is the amount of PCR product of target gene with n cycles, n is PCR cycle number, X_0 is the amount of initial template DNA. E is efficiency of PCR which is affected by temperature, primer and polyase. If the effect of E term is negligible with the same temperature, primer and polyase, X_n has the linear relationship with X_0 .

On the other hand, Shimadzu microchip electrophoresis MCE 202 MultiNA with quartz microchip using a standard DNA sample as internal standard can measure the amount of PCR product. In this study, sample was pretreated with Shimadzu Ampdirect kit which can eliminate PCR inhibitor. Due to the same pretreated and extracted method for all samples, obtained DNA amount is linearly dependent on the amount of sample. Thereby, quantitative determination of the amount of sample was realized by MultiNA.

Instrument

MCE-202 MultiNA

Reagent

1mol/l-Tris-HCl Buffer Solution (pH 8.0), 1L nacalai tesque, Code:35435-11

0.5mol/l-EDTA Solution (pH 8.0), 1L nacalai tesque, Code:14347-21

5mol/l-Sodium Chloride Solution, 1L nacalai tesque, Code:31334-51

10%-SDS Solution, 100 mL nacalai tesque, Code:30562-04

Proteinase K (powder) 100 mg SIGMA, Code:P6556(100mg)

Ampdirect Plus (For International) WAKO pure chem. Code: 604-21469

Shimadzu corp.,Code: S241-08800-99

IMMOLASE™ DNA Polymerase BIOLINE, Code: BIO-21046

DNA-500 KIT (1000 analyses) Shimadzu corp.,

Code: 292-27910-91

SYBR Gold Life Technologies,

Code: S-11494

25bp DNA Ladder Life Technologies,

Code: 10597-011

TE buffer (pH 8.0) nacalai tesque, Code: 32739-31

Sample

The composition of pork, beef and blended meat of pork and beef are shown in Table 1.

Table 1. The composition of sample

No.	Beef /g	Prok /g
1	0.50	0
2	0.40	0.10
3	0.30	0.20
4	0.20	0.30
5	0.10	0.40
6	0	0.50

Pretreatment and PCR condition

Sample preparation and reaction conditions are shown in Figure 1.

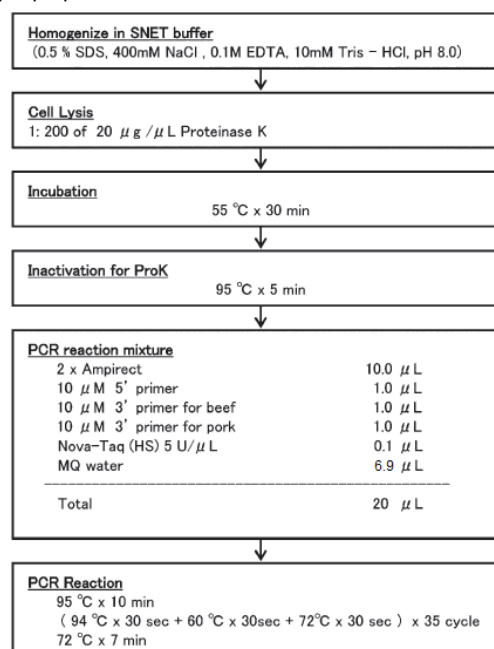
Figure 1. Sample preparation and reaction conditions

Application News

MultiNA

No. MultiNA-013

Microchip Electrophoresis-Based Quantitative Determination of Composition of Blended Meat

Lixiao Li

Analytical Instruments Dept., Analytical Application Center, Shimadzu (China) Co., LTD

Result and discussion

Gel diagram and electropherogram of determination of beef and pork with different composition by MultiNA are shown in Figures 2 and 3. The result suggested that the specific fragment of beef and pork were successfully amplified, in addition, size of these fragments were detected by MultiNA and agreement with expected value. Furthermore, the relationship between the concentration of pork PCR product and pork weigh is shown in Figure 4. It is indicated that the concentration of pork PCR product has the linear relationship with pork weigh. Moreover, the concentration of beef PCR product has the linear relationship with beef weigh as well shown in Figure 4. It is showed that experimental result is agreement with theoretical equation, and quantification determination of meat was achieved by this method.

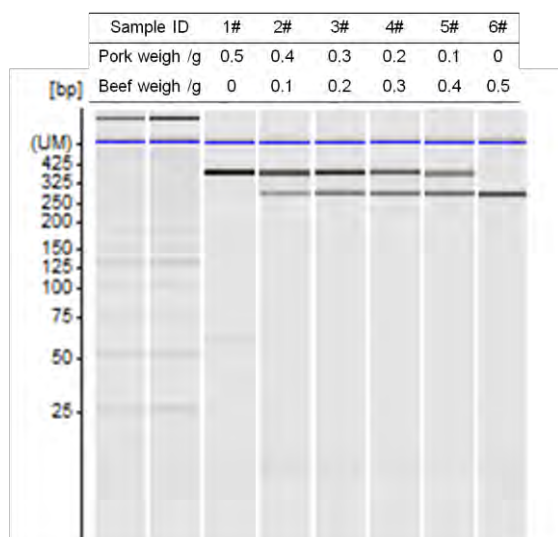

Figure 2. Gel diagram of determination of beef and pork with different composition by MultiNA.

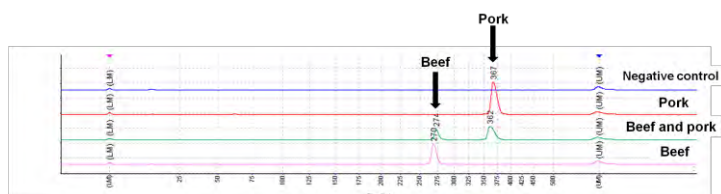

Figure 3. Electropherogram of determination of beef and pork with different composition by MultiNA.

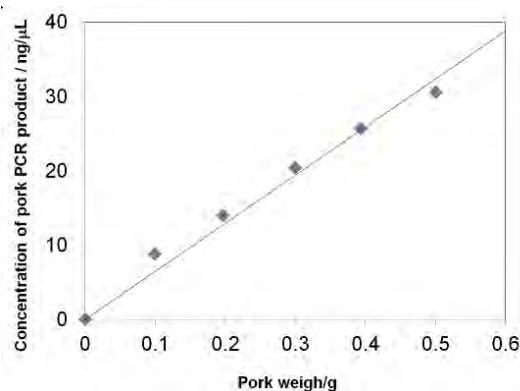

Figure 4. The relationship between concentration of pork PCR product and pork weigh.

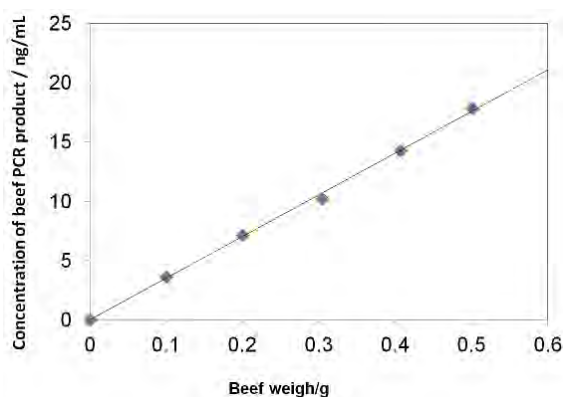

Figure 5. The relationship between concentration of beef PCR product and beef weigh.

Conclusion

In conclusion, a method for quantitatively determining blended meat was successfully developed. This method can be applied to further confirm positive samples of quality determination for meat, and it is a powerful approach to detect adulterations with different species.

Determination of chemical contaminants in marine fish by GCMS/MS using QuEChERS as an extraction method

ASMS 2015 TP 338

Ankush Bhone, Durvesh Sawant, Dheeraj Handique,
Prashant Hase, Sanket Chiplunkar, Ajit Datar,
Jitendra Kelkar and Pratap Rasam
Shimadzu Analytical (India) Pvt. Ltd.,
1 A/B Rushabh Chambers, Makwana Road, Marol,
Andheri (E), Mumbai-400059, Maharashtra, India.

Determination of chemical contaminants in marine fish by GCMS/MS using QuEChERS as an extraction method

Introduction

As Persistent Organic Pollutants (POPs) are environmental contaminants with a strong potential for bioaccumulation, these chemicals are expected to be present in farm animals and food products of animal origin.^[1] In recent years, the occurrence of various POPs, in the marine environment has received much attention with regards to their effect on human health. Especially in India, marine water is contaminated due to uncontrolled disposal from industries and domestic waste. Hence the fish obtained from it has high risk of contamination. Evidently, it becomes necessary to have sensitive, accurate, reliable, reproducible and fast analytical method to quantify these POPs in marine fish at ppb levels. Fish is a complex matrix and hence requires selective extraction and extensive cleanup such as QuEChERS (Quick Easy Cheap Effective Rugged Safe) to ensure trace level detection with adequate precision and accuracy. In this study, Shimadzu GCMS-TQ8040 was used in Multiple Reaction Monitoring (MRM) mode to analyze POPs like



Figure 1. Prawns

Organo-Chlorine Pesticides (OCP), Polycyclic Aromatic Hydrocarbons (PAH) and Poly-Chlorinated Biphenyls (PCB).

Prawns (Figure 1) sample purchased from local market was extracted, spiked and analyzed for obtaining LOD, LOQ, precision and recovery.

Method of analysis

Extraction of pesticides from prawns

Extraction of pesticides was done using modified AOAC QuEChERS method, as given below^[2]

Determination of chemical contaminants in marine fish by GCMS/MS using QuEChERS as an extraction method

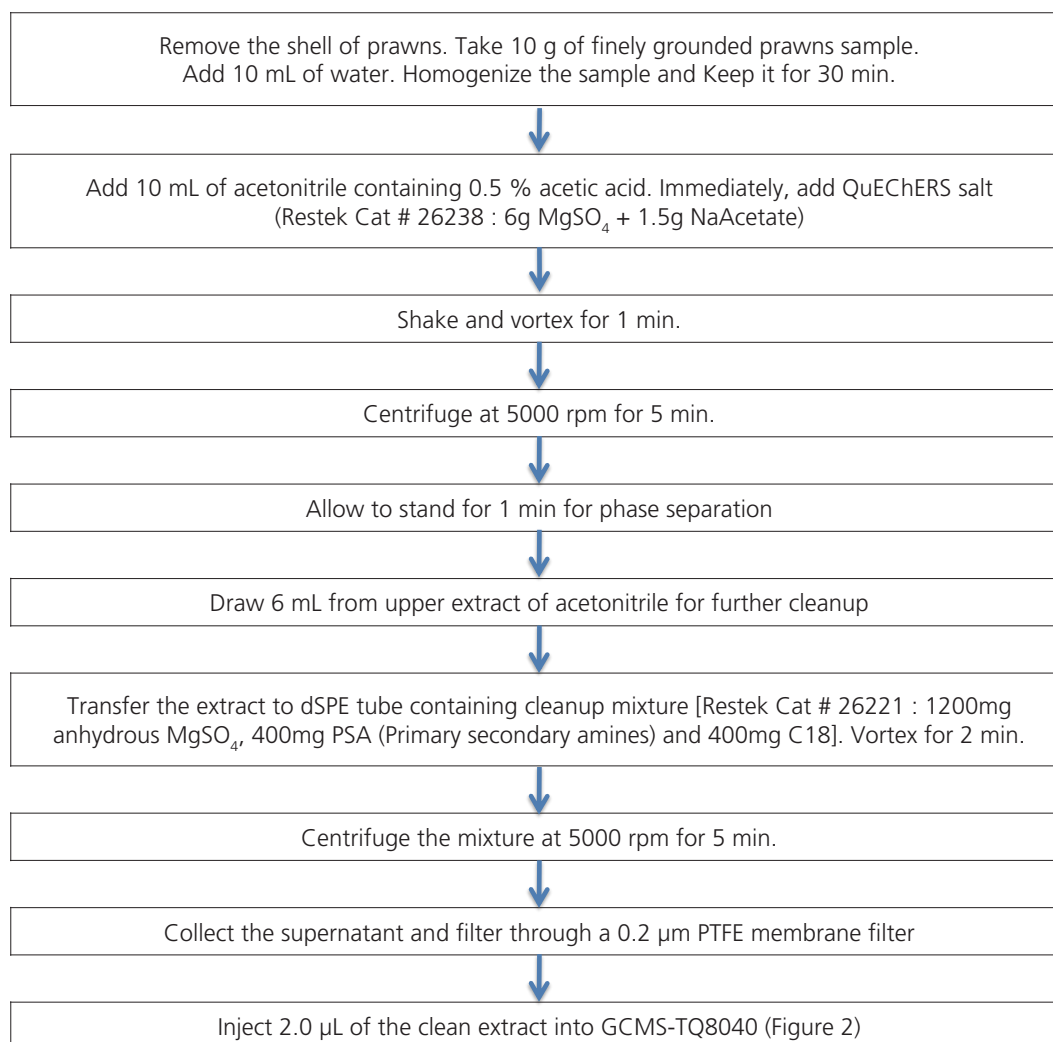

MRM method development

Individual mixtures of OCP, PAH and PCB standards were procured from Restek®. For OCP, the MRM transitions existing in Smart Database were used. For PAH, they were obtained from existing application data and imported in Smart Database. In case of PCB, MRMs were optimized. For optimization, about 1 ppm standard mixtures of PCB was analyzed using scan mode. Retention times of individual components were identified and precursor ions were selected. Using selected precursor ion, product ion scan was performed with different Collision Energies (CE). For each component of PCB, MRM transitions with

appropriate CEs were determined (Refer Figure 3). All the above steps were simplified with the help of Smart MRM optimization tool. These MRM transitions for PCB were then registered to Smart Database containing OCP and PAH. From this, the final method with optimum segments (Refer Figure 4) and minimum three MRM transitions per compound was generated. The mixture of OCP, PAH and PCB was analyzed using the created method as shown in Table 2 and the MRM chromatogram for the same is shown in Figure 5.

Determination of chemical contaminants in marine fish by GCMS/MS using QuEChERS as an extraction method



Figure 2. GCMS-TQ8040 Triple quadrupole system by Shimadzu

Key Features of GCMS-TQ8040

- Smart Productivity** : Analysis of 400 pesticides that used to require 2 or 3 methods, can now be accomplished in a single acquisition method by the new firmware protocol.
- Smart Operation** : Smart MRM technology creates optimal MRM methods automatically. The “MRM Optimization Tool” automates best MRM transitions for new compounds.
- Smart Performance** : ASSP achieves high sensitivity at scan speeds of 20,000 u/second. Fastest MRM 800 trans/sec. Single GC/MS mode with the maximum possible sensitivity and repeatability.

GCMS/MS Analytical Conditions

The analysis was carried out on Shimadzu GCMS-TQ8040 as per the conditions given in Table 1.

Table 1. Analytical conditions

Chromatographic parameters			
Column	: Rxi-5Sil MS (30 m L x 0.25 mm I.D. x 0.25 µm)		
Injection Mode	: Splitless		
Sampling Time	: 2.00 min		
Split Ratio	: 5.0		
Carrier Gas	: Helium		
Flow Control Mode	: Linear Velocity		
Linear Velocity	: 40.2 cm/sec		
Column Flow	: 1.2 mL/min		
Injection Volume	: 1.0 µL		
Injector Type	: High Pressure Injection		
Total Program Time	: 45.87 min		
Column Temp. Program			
	Rate (°C /min)	Temperature (°C)	Hold time (min)
		70.0	2.00
	25.00	150.0	0.00
	3.00	200.0	0.00
	8.00	280.0	10.00

Determination of chemical contaminants in marine fish by GCMS/MS using QuEChERS as an extraction method

Mass Spectrometry parameters

Ion Source Temp.	: 230.0 °C
Interface Temp.	: 280.0 °C
Ionization Mode	: EI (Electron Ionization)
Acquisition Mode	: MRM

Results

Prawns sample was extracted to prepare matrix blank, which was spiked with various concentration levels of POPs to prepare matrix match or post-extraction spike linearity. Using this linearity parameters like LOD, LOQ, precision were studied. Against this linearity, pre-extraction spike was analyzed to study the recoveries.

Table 2. Method creation using Smart MRM feature of GCMS-TQ8040

Type of compounds	Condition	Intermediate requirement	Step.1	Step.2	Step.3
PCB	No information about transitions	Measure in Scan mode and Determine Pre-cursor ion	MRM Optimization Tool Create Batch sequence and Method file of several Collision Energy automatically.	MRM Optimization Tool Analyze acquired data files, and select the best transitions and collision energy automatically. And the result can be exported to Smart MRM database on a mouse click.	Method creation using Smart Database
PAH	Known MRM transitions but, Collision energies are not optimized				
OCP	Present in Smart Pesticide Database				

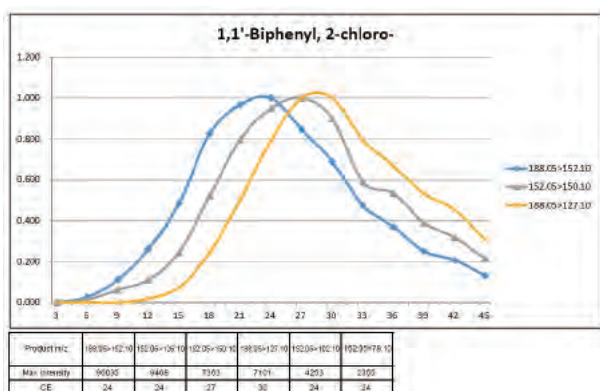

Figure 3. CE Optimization using Smart MRM optimization tool

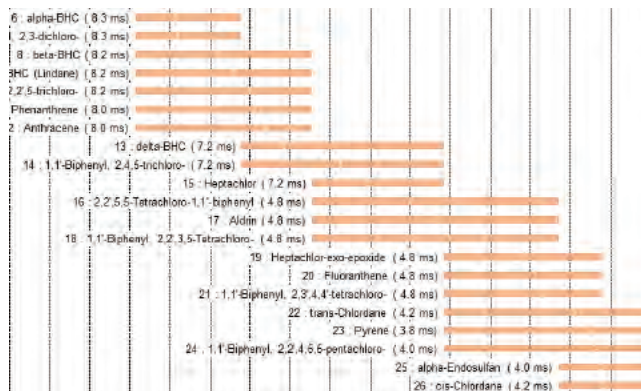

Figure 4. Optimum segmented method created using Smart Database

Determination of chemical contaminants in marine fish by GCMS/MS using QuEChERS as an extraction method

Relative Standard Deviation (% RSD) for 5 ppb standard solution (n=5) was less than 15 % for all components. Calibration plot of matrix match standards ranging from 1 ppb to 50 ppb concentration level showed linear response with r^2 more than 0.995. Recoveries for the prawns

sample spiked with 5 ppb standard mixture were in the range of 70 to 130 %. On the basis of statistical data obtained as shown in Table 3, the method was proved to be highly selective, sensitive and accurate.

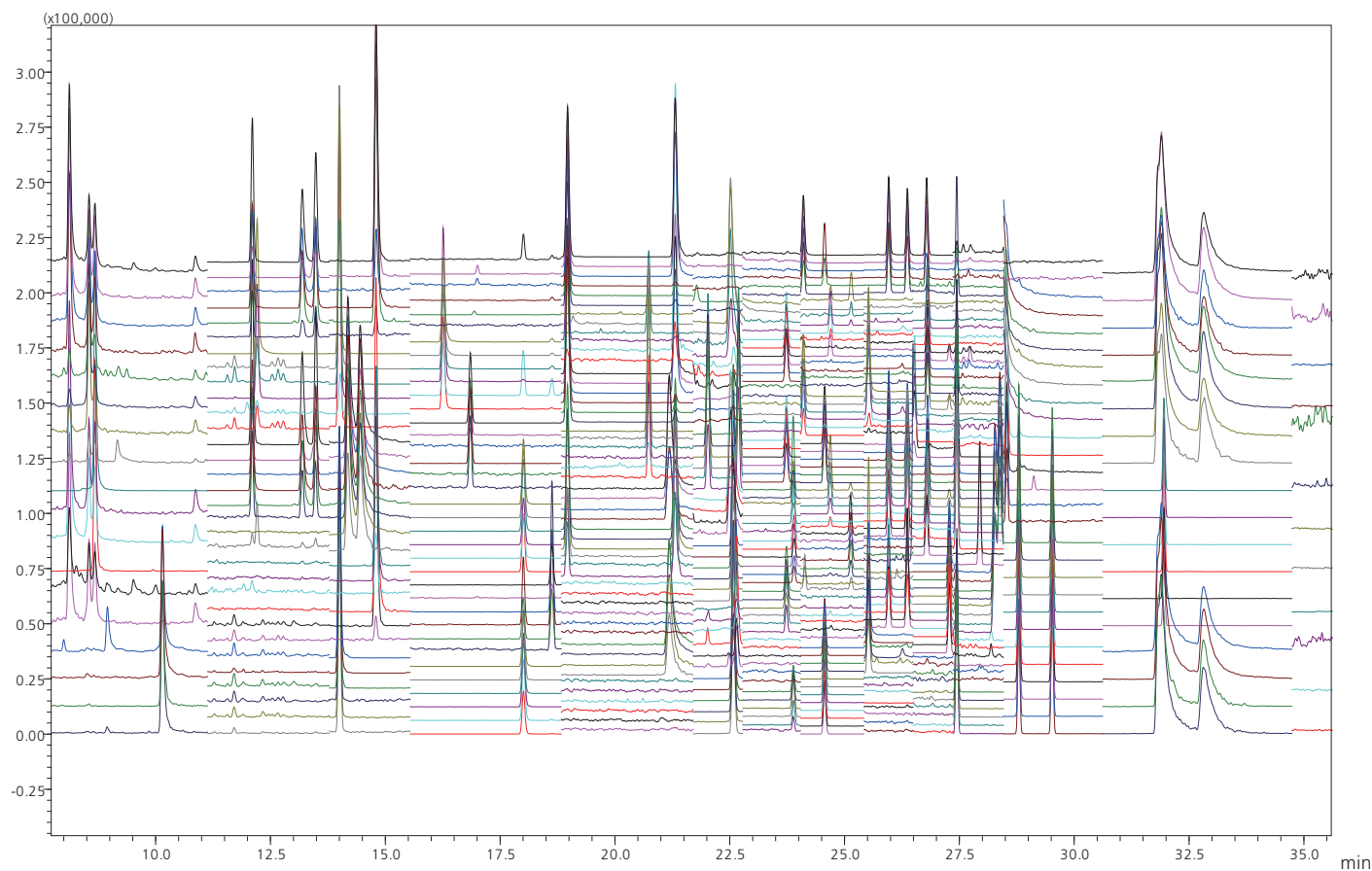

Figure 5. MRM Chromatogram for 10 ppb POPs mixture in matrix

Determination of chemical contaminants in marine fish by GCMS/MS using QuEChERS as an extraction method

Table 3. Quantitation results

ID	POPs	Retention time (min)	Target MRM (m/z)	r ²	S/N at 5 ppb LOQ level	% RSD at LOQ level (n=5)	% Recovery at LOQ
1	Naphthalene	5.41	128.10>128.10	0.9993	2261.7	3.97	117
2	Acenaphthylene	8.09	152.10>152.10	0.9994	349.37	5.46	94
3	Acenaphthene	8.53	153.10>153.10	0.9999	16.05	1.74	104
4	Fluorene	10.11	166.10>166.10	0.9996	98.46	8.96	96
5	Phenanthrene	14.12	178.10>178.10	1.0000	22.5	3.00	111
6	Anthracene	14.39	178.10>178.10	1.0000	31.09	5.13	95
7	Fluoranthene	21.23	202.10>202.10	1.0000	112.84	5.22	107
8	Pyrene	22.59	202.10>202.10	1.0000	55.95	7.10	102
9	Benz[a]anthracene	28.44	228.10>228.10	0.9950	17.2	4.25	124
10	Chrysene	28.44	228.10>228.10	0.9948	21.66	4.47	131
11	Benzo[k]fluoranthene	32.00	252.10>252.10	0.9999	999.8	4.80	85
12	Benzo[b]fluoranthene	32.01	252.10>252.10	0.9998	303.42	7.99	91
13	Benzo[a]pyrene	32.97	252.10>252.10	0.9993	88.39	9.18	79
14	Indeno[1,2,3-cd]pyrene	37.37	276.10>276.00	0.9996	22.22	7.19	70
15	Dibenz(a,h)anthracene	37.45	278.10>278.10	0.9948	36.15	12.28	94
16	Benzo[g,h,i]Perylene	38.42	276.10>276.10	0.9996	918.4	9.98	70
17	1,1'-Biphenyl, 2-chloro-	8.67	188.05>152.10	0.9998	3181.75	3.25	95
18	1,1'-Biphenyl, 2,3-dichloro-	12.19	222.00>152.10	0.9999	691.78	1.48	92
19	1,1'-Biphenyl, 2,2',5-trichloro-	13.99	255.95>186.00	0.9999	1516.47	1.01	93
20	1,1'-Biphenyl, 2,4,5-trichloro-	16.25	255.95>186.00	0.9999	582.39	2.17	85
21	2,2',5,5'-Tetrachloro-1,1'-biphenyl	18.00	289.90>220.00	0.9999	1326.79	2.16	86
22	1,1'-Biphenyl, 2,2',3,5-Tetrachloro-	18.96	289.90>220.00	0.9998	597.52	4.12	87
23	1,1'-Biphenyl, 2,3',4,4'-tetrachloro-	21.29	289.90>219.90	1.0000	117.87	2.57	80
24	1,1'-Biphenyl, 2,2',4,5,5-pentachloro-	22.57	325.90>255.90	0.9999	1487.66	5.86	73
25	1,1'-Biphenyl, 2,2',3,4,5-pentachloro-	23.73	325.90>255.90	0.9998	263.7	6.44	75
26	2,3,3',4,6'-Pentachloro-1,1'-biphenyl	24.09	325.90>255.80	0.9997	303.94	1.99	80
27	2,2',3,5,5',6'-Hexachloro-1,1'-biphenyl	24.56	359.85>289.80	0.9999	635.77	4.58	70
28	alpha-BHC	12.15	180.90>144.90	0.9999	740.26	4.36	106
29	beta-BHC	13.23	180.90>144.90	0.9999	424.32	1.78	113
30	gamma-BHC (Lindane)	13.57	180.90>144.90	0.9999	484.21	3.37	106
31	delta-BHC	14.83	180.90>144.90	0.9997	132.15	4.84	100
32	Heptachlor	16.92	271.80>236.90	1.0000	376.67	7.29	98
33	Aldrin	18.71	262.90>193.00	0.9997	62.23	3.17	78
34	Heptachlor-exo-epoxide	20.82	352.80>262.90	0.9998	132.2	6.57	114
35	trans-Chlordane	22.10	372.80>263.90	0.9999	424.26	7.84	90
36	cis-Chlordane	22.69	372.80>263.90	1.0000	388	7.73	82
37	alpha-Endosulfan	22.74	194.90>160.00	0.9999	11.86	11.71	97
38	Dieldrin*	23.95	262.90>193.00	0.9997	162.75	10.58	78
39	p,p'-DDE	23.99	246.00>176.00	1.0000	205.29	3.00	86
40	Endrin*	24.78	262.90>191.00	1.0000	184.28	8.87	107
41	beta-Endosulfan*	25.22	194.90>160.00	0.9988	24.94	11.52	107
42	p,p'-DDD	25.63	235.00>165.00	1.0000	365.71	4.30	109
43	Endosulfan sulfate	26.61	271.80>236.90	0.9988	183.35	11.75	95
44	p,p'-DDT	26.86	235.00>165.00	1.0000	101.05	5.24	103

Note *: For these compounds LOQ was 10 ppb

Key : RAH PCB OCP

Determination of chemical contaminants in marine fish by GCMS/MS using QuEChERS as an extraction method

Conclusion

- Shimadzu GCMS-TQ8040 with Smart MRM feature was able to optimize MRM transitions with ease.
- New Smart Database tool creates method with optimum segments leading to increased dwell-time, which resulted in achieving high sensitivity for trace level quantitation of POPs in complex matrix like prawns.
- The MRM method developed for POPs can be used for screening of pesticides in various marine fish products. For 90 % of the POPs, LOQ of 5 ppb was achieved.

References

- [1] Weiss, J., Paepke, O. and Bergman, A. 2005. A worldwide survey of polychlorinated dibenzo-p-dioxins, dibenzofurans, and related contaminants in butter. *Ambio* 34(8):22-30.
- [2] Pesticide Residue in Foods by Acetonitrile Extraction and Partitioning with Magnesium Sulfate (AOAC Official Method 2007.01), (2007), 06.

Application News

No. C104

Liquid Chromatography Mass Spectrometry

Analysis of Diarrhetic Shellfish Toxin Using Triple Quadrupole LC/MS/MS (LCMS-8050)

The Japanese Ministry of Health, Labour and Welfare (JMHLW) specified in July, 1980 that the mouse bioassay (MBA) be used as the official method for diarrhetic shellfish toxin, and that the permissible exposure limit be 0.05 MU per gram of edible shellfish*. Shellfish in which the toxin exceeds this limit are prohibited from being sold at market according to the Japanese Food Sanitation Law Article 6, Item 2.

Due to significant technological advances since 1980, the sensitivity and accuracy obtained using the MBA method are significantly inferior compared to the high-precision, high-sensitivity possible using liquid chromatography mass spectrometry analytical instrumentation, which is currently used for this application. A complete transition to instrumental analysis for lipophilic marine biotoxins is scheduled to be implemented by January 2015 throughout the EU.

Based on this international trend, the JMHLW is currently considering migration to an instrumental analysis assay and setting new reference values to be used with instrumental analysis, in addition to the introduction of the Codex standard for okadaic acids (OA, Reference 1).

Table 1 CODEX Standard 292-2008

	Reference Value
OA Acids (OA and DTX group)	Permissible ingestion limit of 0.16 mg OA per kg of edible shellfish

Fig. 1 shows examples of LC/MS/MS high-sensitivity analysis of okadaic acid (OA), dinophysistoxin 1 (DTX1) and pectenotoxins (PTX1, 2, 6) and yessotoxin 1 (YTX1). Thus, it is possible to conduct high-sensitivity, high-separation analysis of each component.

Fig. 2 and Fig. 3 show MRM chromatograms of standard samples of OA and DTX1, respectively.

* The amount of toxin resulting in the death of two out of three mice following intraperitoneal administration of the equivalent of 20 g per edible shellfish.

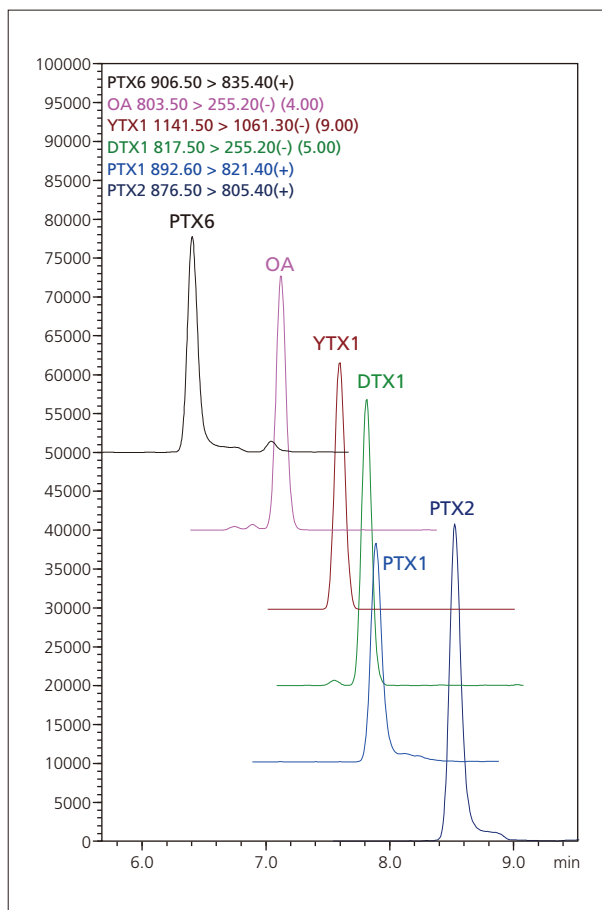

Fig. 1 MRM Chromatograms of Diarrhetic Shellfish Toxin (1 ng/mL)

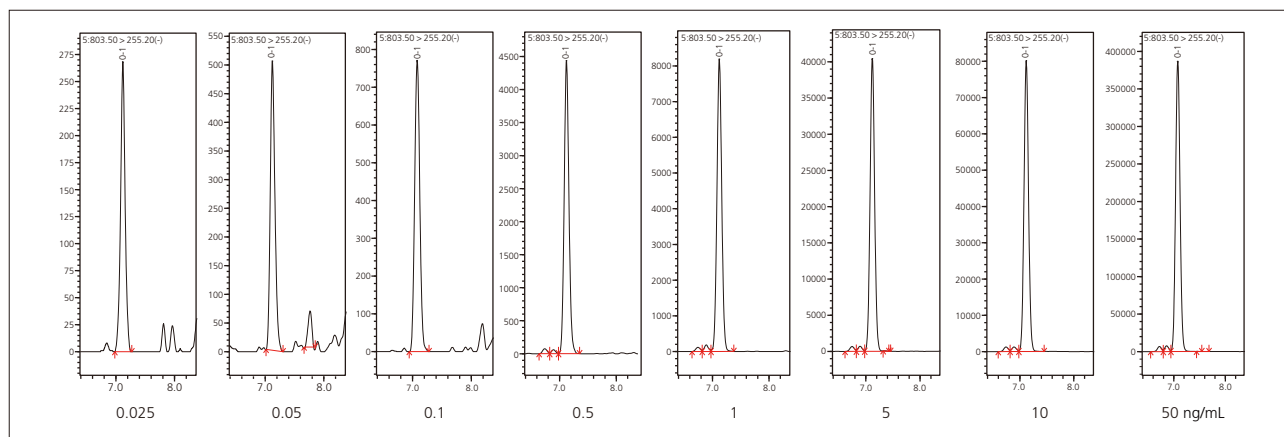

Fig. 2 MRM Chromatograms of Okadaic Acid (OA)

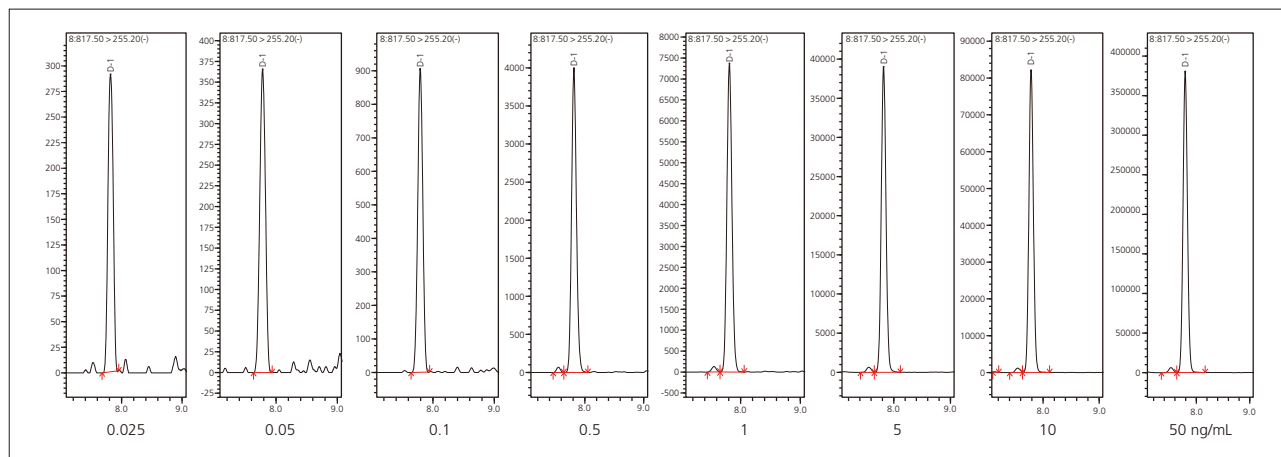

Fig. 3 MRM Chromatograms of Dinophysistoxin 1 (DTX1)

In addition, the calibration curves of OA and DTX1 are shown in Fig. 4. In both cases, the coefficient of determination R^2 was greater than 0.9999, indicating excellent linearity. Comparable linearity was also obtained for the other four substances.

Thus, instrumental analysis of shellfish by LC/MS/MS offers high sensitivity and accuracy, making it a highly effective analytical method. For this reason it is attracting attention as an alternative to the traditional MBA method.

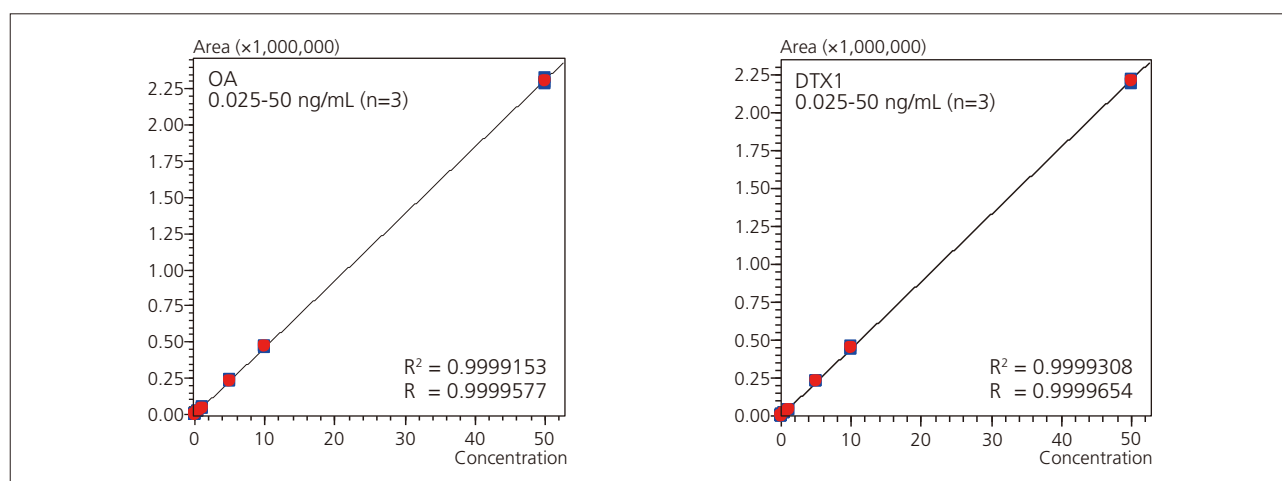

Fig. 4 Calibration Curves of OA and DTX1

Table 2 Analytical Conditions

Column	: InertSustain C8 (50 mm L. × 2.1 mm I.D., 3 μm)
Mobile Phases	: A 2 mmol/L Ammonium Formate – Water (pH adjusted to 8.5 with ammonia water) : B Methanol
Time Program	: 20 %B (0 min) – 100 %B (10 min) – 20 %B (10.01 min) – STOP (15 min)
Flowrate	: 0.2 mL/min
Column Temperature	: 40 °C
Injection Volume	: 10 μL
Probe Voltage	: +4.0 kV/-3.0 kV (ESI-positive / negative mode)
DL Temperature	: 200 °C
Block Heater Temperature	: 400 °C
Interface Temperature	: 350 °C
Nebulizing Gas Flow	: 3 L/min
Drying Gas Flow	: 10 L/min
Heating Gas Flow	: 10 L/min
MRM Transition	: (+) PTX6 906.50 > 835.40, PTX1 892.60 > 821.40, PTX2 876.50 > 805.40 : (-) OA 803.50 > 255.20, YTX1 1141.50 > 1061.30, DTX1 817.50 > 255.20

The diarrhetic shellfish toxin standards were provided courtesy of Dr. Toshiyuki Suzuki of the Japanese National Research Institute of Fisheries Science.

Reference 1: July, 2014, Food Safety Commission of Japan "Natural Poison Evaluation Report – Okadaic Acid Group Among Bivalves"
<http://www.fsc.go.jp/fscis/evaluationDocument/list?itemCategory=009>

Application News

No. AD-0153

Halal Authentication Analysis / LCMS-8060

Highly-Sensitive Detection of Multiple Porcine-Specific Peptides in Processed Foods by LC/MS/MS Method

Udi Jumhawan, Jie Xing & Zhaoqi Zhan

Application Development & Support Centre, Shimadzu (Asia Pacific) Pte Ltd, Singapore

Introduction

In recent years, unauthorized blending of undeclared materials into food products has been a major concern among consumers. Such action violates customer rights based upon economical and safety values and it is also a critical problem for communities with ethical and religious beliefs [1,2]. Both accidental and intentional adulteration of pork meat into food products are significant issue affecting Muslims and Jews as they have dietary restrictions on foods containing pork and its-by-product, such as gelatin. Particularly for Muslims, those restrictions are part of Islamic law concerning Halal (permissible) and Haram (non-permissible) foods. With an estimated 1.6 billion Muslims worldwide, development of sensitive method for detection of porcine materials in food products is indispensable. Various approaches and targets have been utilized to trace porcine materials in processed foods including pork DNA by qPCR [3] and PCR-MCE [4]. However, DNA is prone to thermal degradation thus its viability remains dubious after food processing (cooking). In recent years, porcine-specific peptide markers were discovered and utilized for detection of pork in food [5-8]. In this Application News, a highly sensitive LC/MS/MS method is described for ensuring halal food integrity by targeting more heat-stable porcine-specific peptide markers in processed foods.

Experimental

Preparation of meat and processed food samples

The experimental procedure is modified based upon previous reports [5-8] and consists of four steps as follows: protein extraction, trypsin digestion, SPE clean-up and analysis of porcine-specific peptide markers on LC/MS/MS. The workflow of protein extraction, reduction, alkylation and digestion is displayed in **Figure 1**. Raw meats of pork, chicken and beef were used in method development to confirm the porcine-specific peptides and obtain optimized MRMs and retentions. The targeted samples are processed foods. Nine processed food products

were obtained from local supermarket. It is to note that the supplementary addition of 20 μ L dithiothreitol is to consume the unreacted iodoacetamide. The obtained tryptic digestion solution is cleaned up using SPE (solid phase extraction) approach prior to LC/MS/MS analysis. The details of the procedure are shown in **Figure 2**.

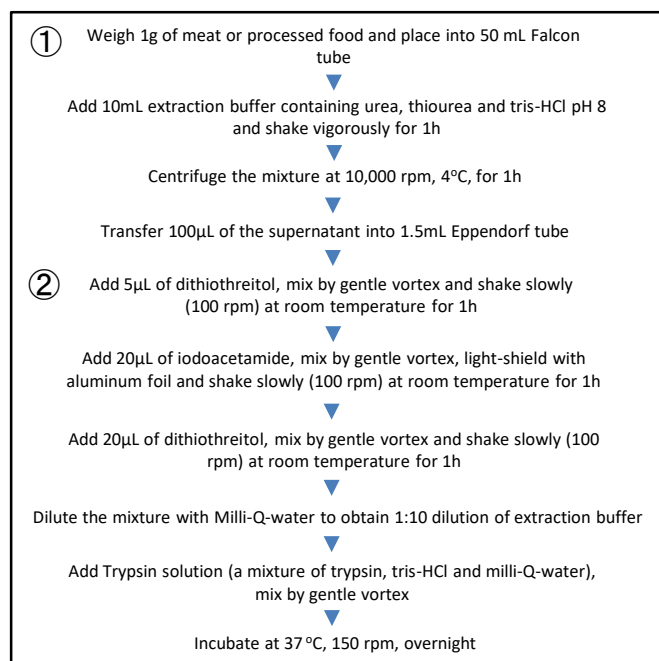

Figure 1. Workflow of protein extraction ①, reduction, alkylation, and digestion ②

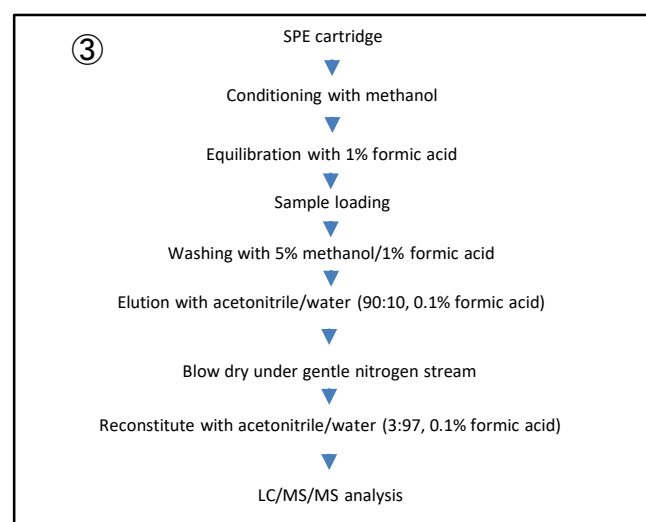

Figure 2. Workflow of SPE clean up procedure of trypsin digested proteins extracted from processed food or raw meat

LC/MS/MS analytical conditions

A high sensitive triple quadrupole system, LCMS-8060, coupled with a Nexera X2 UHPLC system was utilized to establish detection and semi-quantitation of porcine-specific peptides in processed food. A reversed phase Phenomenex column which has been described suitable for peptide mapping was used. The details of the UHPLC and MS/MS parameters are summarized in **Table 1**.

Table 1. Analytical conditions for detection and semi quantitation of porcine-specific peptides on LCMS-8060

Column	Aeris Peptide 1.7 μ m XB-C18 100Å (150 mm x 2.1 mm I.D.)
Mobile Phase	A: Water with 0.1% formic acid B: Acetonitrile with 0.1% formic acid
Elution Program	Gradient elution, 3%B (0min) \rightarrow 45%B (12min) \rightarrow 70%B (12.01–14min) \rightarrow 3%B (14.50–18min)
Flow Rate	0.3 mL/min
Oven Temp.	50 $^{\circ}$ C
Injection	5 μ L
Interface	Heated ESI
MS Mode	MRM, Positive mode
Block Temp.	400 $^{\circ}$ C
DL Temp.	250 $^{\circ}$ C
Interface Temp.	300 $^{\circ}$ C
Nebulizing gas	N ₂ , 3 L/min
Drying gas	N ₂ , 10 L/min
Heating Gas	Zero air, 10 L/min

Results and discussion

MRM-based method for detection of porcine-specific peptides

A number of porcine-specific peptides has been discovered by several researchers in past years [5-8]. The peptide markers for pork as well as other meat species were adopted in establishment of MRM based method on LC/MS/MS to achieve high sensitivity for inspection of blending pork or concerned meat species in Halal food. To enhance the detection reliability, this study incorporates all the known peptide markers reported previously [5-8] into a single LC/MS/MS method. A total of seven peptide markers was targeted and utilized.

Due to the unavailability of authentic peptide standards, development of MRM method was conducted according to the strategy shown in **Figure 3**. The targeted peptide sequences in FASTA format was retrieved from UniProt protein database and then submitted into Skyline software to obtain predicted MRM transitions and collision energies (CE). This simplified and speed it up greatly method development on LC/MS/MS. The predicted MRM parameters were imported into the LabSolutions, where MRM optimization were performed using the auto MRM optimization program. **Table 2** and **Figure 4** show the seven porcine-specific peptides and MRM method established on LCMS-8060. The peptide markers were found with good sensitivity using 5 μ L injection volume compared to that of higher volumes applied in previous reports (40-50 μ L) [5-6].

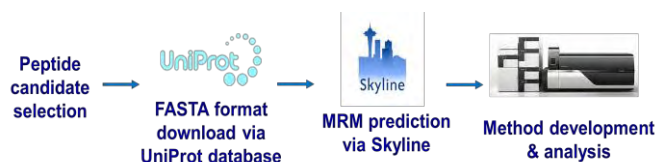

Figure 3. Schematic procedure of MRM method development of peptides from digested proteins with assistance of Skyline program.

Table 2. Porcine-specific peptides and MRM based method on LCMS-8060

Protein	UniProt accession No.	Peptide marker (short sequence)	Precursor ion & charges	Number of MRM	RT (min)
Troponin T	Q75NG7	YDII	453.8++	5	6.52
Myosin-1 & Myosin-4	Q9TV61/62	SALA	376.1+++	6	3.25
Myosin-4	Q9TV62	TLAF	534.3++	6	8.14
L-lactate dehydrogenase A chain	P00339	LVVI	450.3++	4	5.44
Serum albumin	P08835	EVTE	412.2++	4	3.99
		FVIE	388.8++	5	6.68
		TVLG	647.9++	3	8.01

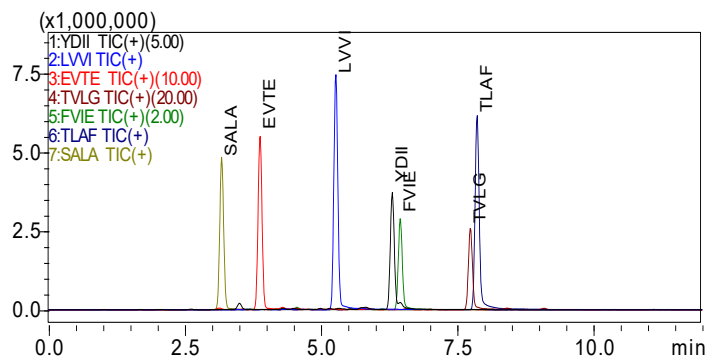

Figure 4. Total MRM chromatograms of seven porcine-specific marker peptides detected in trypsin-digested extract of raw pork meat.

Specificity of porcine-specific peptide markers

The specificity of the seven porcine-specific peptides were verified with beef and chicken meats following the exact same sample preparation and analysis conditions. The criteria included at least three MRM transitions, their ratios and RT. All the seven peptide markers were not detected in beef sample. However, as shown in **Figure 5**, one peptide peak in chicken meat was overlapped with porcine peptide which identified as LVVITAGAR. This particular peptide from L-lactate dehydrogenase protein in pork has identical amino acid composition to that of the same peptide in chicken (LVIVTAGAR) as shown with the same ion mass (m/z) [7]. However, based on Skyline MRM prediction, the difference in amino acid sequence among these peptides resulted in one unique product ion: 588.35 for pork and 574.35 for chicken.

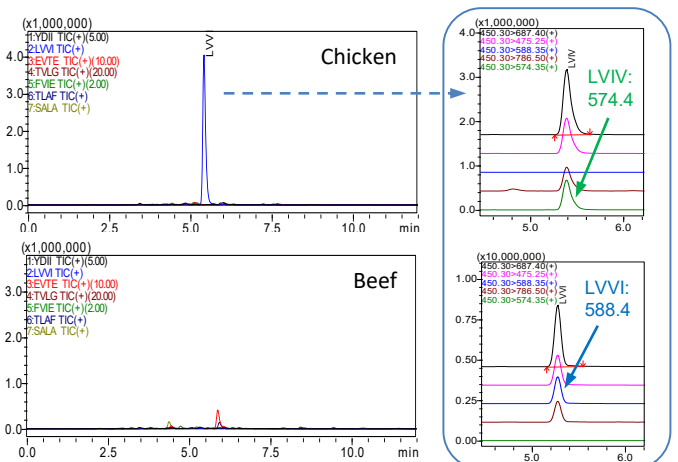

Figure 5. Specificity of porcine peptide markers in chicken and pork (Left). The sequence of LVVI marker peptide (LVVITAGAR) in chicken is actually different from pork (LVVITAGAR), which could be differentiated from MRM (right)

The prediction was confirmed (Figure 5 right) and thereby verified method selectivity to pinpoint species-specific peptide marker.

Thermolability test of porcine-specific peptide markers

To investigate viability of the seven peptide markers after food processing (cooking), raw pork meat was subjected to heat treatment at 200°C for 30 minutes before sample pre-treatment. The results indicated that these porcine-specific peptide markers exhibited certain depleted levels upon heat treatment but all of the peptide markers could be detected firmly. Furthermore, processed food products were also treated at 200°C for 30 minutes and the results showed that the levels of the peptide markers remained in the samples were feasible for detection of pork by the established LC/MS/MS method (Table 3).

Screening analysis of porcine-specific peptides in processed foods

Table 3 shows the results of screening analysis of five non-halal and four halal-certified processed food products using the established method aiming for halal testing application. All the samples were pre-treated at 200°C for 30 minutes before extraction, digestion and purification. This is to verify the feasibility of the method for cooked and processed food.

Table 3. Results of screening analysis of porcine-specific peptides in processed food products (Note: the peptide markers are indicated with first four letters of amino acid composition)

Halal label	Processed food	Porcine-specific peptide markers (n=2)						
		YDII	LVVI	EVTE	TVLG	FVIE	TLAF	SALA
H A L A L	1 Chicken-Beef sausage	ND	ND	ND	ND	ND	ND	ND
	2 Lamb-Chicken sausage	ND	ND	ND	ND	ND	ND	ND
	3 Canned corned beef	ND	ND	ND	ND	ND	ND	ND
	4 Canned mutton curry	ND	ND	ND	ND	ND	ND	ND
N O N H A L A L	5 Chicken sausage	+	+	+	ND	+	ND	+
	6 Pork sausage	+	+	+	+	+	+	+
	7 Canned corned pork	+	+	+	+	+	+	+
	8 Pork meatball	+	+	+	+	+	+	+
	9 Noodle seasoning	+	+	+	+	+	+	+

(+) detected based on 3 MRM transitions RT matching; ND, not detected.

All the seven porcine-specific peptide markers were detected in all the processed samples with pork material (samples No. 5-9). None of the seven porcine-specific peptide markers was detected in the Halal certified samples (sample No. 1-4). However, five peptide markers were detected in chicken sausage (sample No. 5), which was not a Halal certified product. Following the confirmation criteria (RT matching with positive control, signal-to-ratio (S/N)>3, and at least 3xMRM transitions) the detection of the

five porcine-specific peptides were confirmed. This may be resulted from cross-contamination due to non-halal sample handling during product manufacturing.

Detection limit of pork in processed foods

To evaluate the sensitivity of the method for screening analysis, it is important to know the detection limit in terms of content level of pork materials in processed food. To estimate the detection limit and confirmation reliability of the method, cooked pork meat (200°C, 30 minutes) was pre-spiked into halal-certified mutton curry (sample No. 4) in four spiking percentages from 0.1% to 5.0% (wt) before sample preparation. The results of the spiked samples are summarized in Table 4.

Three porcine-specific peptide markers YDII, LVVI and SALA were detected for all spiking levels including the 0.1% (wt) with S/N >= 3. The results were reproducible among four separate sample preparations and analyses in different days (inter-day). Peptide FVIE and EVTE had detection limits of about 0.5% and 1%, respectively. Peptide EVTE could be detected at only 5% spiking level whereas peptide TVLG could not be detected. This suggests that the detection sensitivity of the seven porcine-specific peptide markers are very different in processed food. It was found in thermolability tests that peptide YDII is most thermostable while the other six peptides are less stable at 200°C.

Table 4. Detection limit of porcine-specific peptides in spiked Halal food sample

Peptide marker	Spiking percentage of cooked pork (% wt) (n=4)			
	0.1	0.5	1.0	5.0
YDII	+	+	+	+
LVVI	+	+	+	+
EVTE	ND	ND	ND	+
TVLG	ND	ND	ND	ND
FVIE	ND	+	+	+
TLAF	ND	ND	+	+
SALA	+	+	+	+

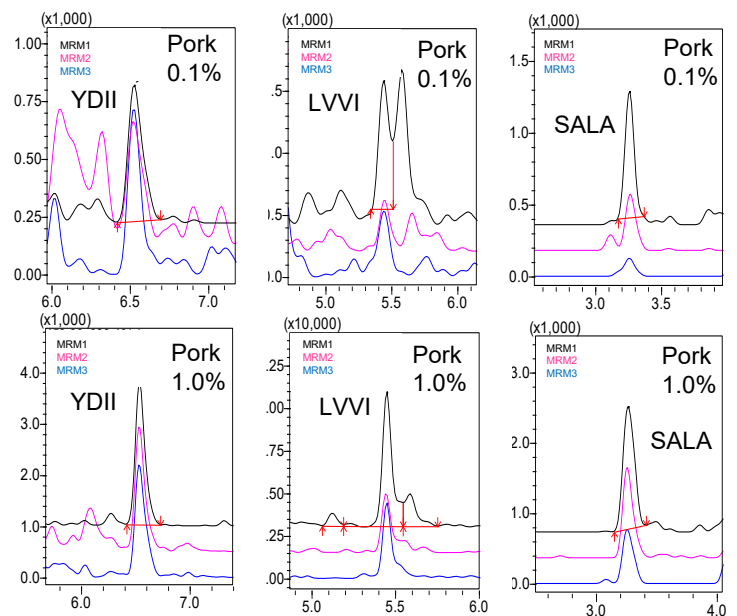

Figure 6. Detection of porcine-specific peptide markers YDII, LVVI and SALA in certified Halal food matrix spiked with cooked (200°C) pork at 0.1% and 1% (wt).

The detection sensitivities of the seven peptide markers are different depending on the food processing and cooking conditions. The additional heating treatment of all raw meats and processed foods at 200°C under dry air in this study is considerably a severe condition which lead to degradation of proteins. The detection results under this experiment condition indicate the method is applicable and feasible for halal testing of various processed and cooked foods.

Semi-quantitative screening of pork blended in processed food

The four porcine-specific peptides YDII, LVVI, SALA and FVIE, which are more sensitive for detection of pork in processed food, are further evaluated for semi-quantitative screening. As shown in **Figure 7** and **Table 5**, linear relationship exists between peak area and content level of spiked pork (cooked at 200°C) in processed canned mutton curry (Halal certified). The linearity (R^2) is equal to or greater than 0.995 for the four peptide markers in the testing range. The quantitative results also exhibit acceptable repeatability with RSD of both peak area and concentration (spiking percentage) within acceptable value which is under 16%.

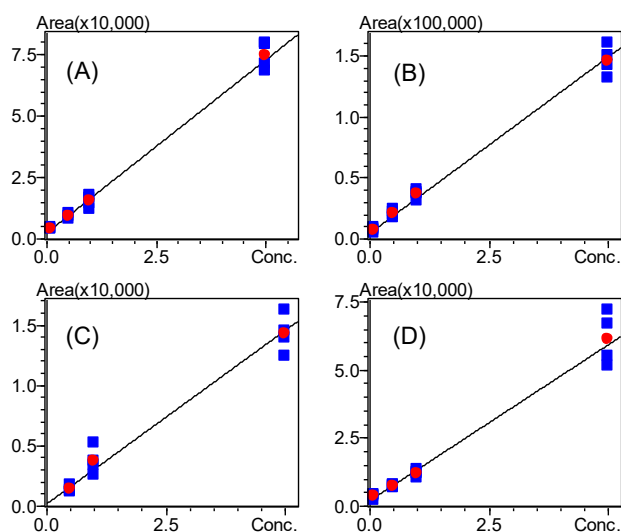

Figure 7. Linear relationship between peak area of four porcine-specific peptides and percentage (%) of cooked pork spiked in canned mutton curry. (A) YDII, (B) LVVI, (C) FVIE, (D) SALA. The blue and red dots represent repeated and average values, respectively.

In summary, the established MRM-based method on a LC/MS/MS platform offers a highly sensitive and selective approach to detect and monitor the presence of porcine-specific markers for semi-quantitation of the amount of pork in processed foods. The established method from sample preparation to LC/MS/MS analysis exhibits excellent reliable sensitivity, which is potentially able to support halal testing in processed food products. Analysis of various food matrices will be performed in the future.

Table 5. Calibration curves of four peptide markers in spiked samples

Peptide marker	Range (%)	Linearity	Repeatability at 1% (n=6)	
		(R^2)	Area RSD (%)	Conc. RSD (%)
YDII	0.1-5	0.997	11.3	13.6
LVVI	0.1-5	0.998	9.3	11.0
FVIE	0.5-5	0.995	14.4	15.3
SALA	0.1-5	0.998	8.3	10.1

Conclusions

Despite its tedious sample preparation procedure, porcine-specific peptides are far more prominent targets for developing halal testing method, since peptides are more heat-stable than DNA, the common target for detection of pork in foods. With remarkable sensitivity and selectivity, this LC/MS/MS method provides a more robust approach to detect as low as 0.1% (wt) of porcine material blended in processed food.

References

1. N. A. Fadzilliah, Y. B. Che Man, M. A. Jamaludin, S. Ab. Rahman and H. A. Al-Kahtani, 2011 2nd International Conference on Humanities, Historical and Social Sciences, PEDR vol.17 (2011), 159-163.
2. M. Eaqub Ali & M. Kashif & Kamal Uddin & U. Hashim & S. Mustafa & Yaakob Bin Che Man, Food Anal. Methods, ISSN 1936-9751, Springer (2012)
3. Soares, S., Amaral, J. S., Oliveira, M. B., Mafra, I, Meat Sci (2013) 94: 115–120.
4. D. Kesuma, L. G-S Lim & Z. Zhan, "Ensuring Halal Food Integrity by Detection of Pork DNA in Processed Meat on PCR-MultiNA Platform", Application News AD-0120 (Shimadzu) 2016
5. von Bargaen, C., Dojahn, J., Waidelich, D., Humpf, H.U., Brockmeyer, J., J Agric Food Chem (2013) 61: 11986–11994.
6. von Bargaen, C., Brockmeyer, J., Humpf, H.U., J Agric Food Chem (2014) 62: 9428–9435
7. Sarah, S.A., Faradalila, W.N., Salwani, M.S., Amin, I., Karsani, S.A., Sazili, A.Q., Food Chem (2016) 199: 157-164
8. Barnes, A.J., Loftus, N.J., Iida, J., "Cooked meat product analysis by LCMS/MS to determine between animal species using proteotypic peptide quantitative proteomic analysis", ASMS 2015, WP099

Disclaimer: The data and instruments presented in this Application News are intended for Research Use Only (RUO). Not for use in diagnostic procedures.

Development of Sensitive and Selective Methods for Identification of Marine Toxins by Liquid Chromatography Tandem Mass Spectrometry

ASMS 2017 TP-211

Manami Kobayashi¹ ; Junichi Masuda¹;
Yoshihiro Hayakawa²

¹ Shimadzu Corporation, Kanagawa, JAPAN;

² Shimadzu Corporation, Kyoto, JAPAN

Development of Sensitive and Selective Methods for Identification of Marine Toxins by Liquid Chromatography Tandem Mass Spectrometry

Introduction

Over many decades, marine toxins have been monitored by the mouse bioassay (MBA) for the food safety purpose in many countries. In place of MBA, liquid chromatography (LC) with mass spectrometry (MS) is expected to use for the analysis of the marine toxins, deemed superior to the MBA in the point of sensitivity and accuracy.

Our purpose is establishment of the analytical conditions using Liquid Chromatography Tandem Mass Spectrometry for three groups of marine toxins of which each structure and property is different.

The target three groups of marine toxins are diarrhetic shellfish poisoning (DSP) toxins as okadaic acid (OA) and dinophysistoxins (DTX1 and DTX2), ciguatera fish poisoning (CFP) as ciguatoxin 3C (CTX3C), and globefish poisoning as tetrodotoxin (TTX).

Since globefish poisoning, tetrodotoxin (TTX) have been reported to be detected from the bivalves in a certain sea area near New Zealand and European coast, it's argued internationally to add TTX to the shellfish poisoning toxin.

Paralytic Shellfish Poisoning (PSP)	Diarrhetic Shellfish Poisoning (DSP)	Ciguatera Fish Poisoning (CFP)
Serious effects. Fatal toxic symptoms.	Diarrhea and/or vomiting. Not so serious conditions.	Fatal toxic symptoms (in the limited area)
LC-MS/MS in Japan & EU	MBA in Japan Fluorescence HPLC method in addition to MBA in EU and the USA (AOAC 2005.06 & 2011.02)	Review of regulatory frameworks
OA: 0.16 mg OA eq/ kg *1.	4 MU/g as MBA STX 0.8 mg STX eq /kg *1 (as 2 HCl)	

*1 CODEX STAN 292-2008.

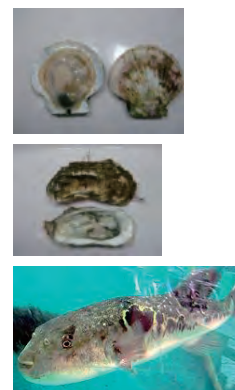

Experimental

Standard Solutions

Standard solutions of OA, DTX1 and DTX2 were purchased from NRC (Canada).

CRM-OA-c (Lot #20070328), CRM-DTX1 (Lot #20071024), CRM-DTX2 (Lot #20150819)

Standard of CTX3C and TTX were purchased from Wako Chemical Industry (JAPAN).

Ciguatoxin CTX-3C 100 ng, Wako Chemical # 030-21581

Tetrodotoxin TTX 1 mg, Wako Chemical # 206-11071

Methanol including 0.1% formic acid was used for dilution of standard mixture from above.

Each structure of marine toxins compound is shown in Figure 1 as below.

Development of Sensitive and Selective Methods for Identification of Marine Toxins by Liquid Chromatography Tandem Mass Spectrometry

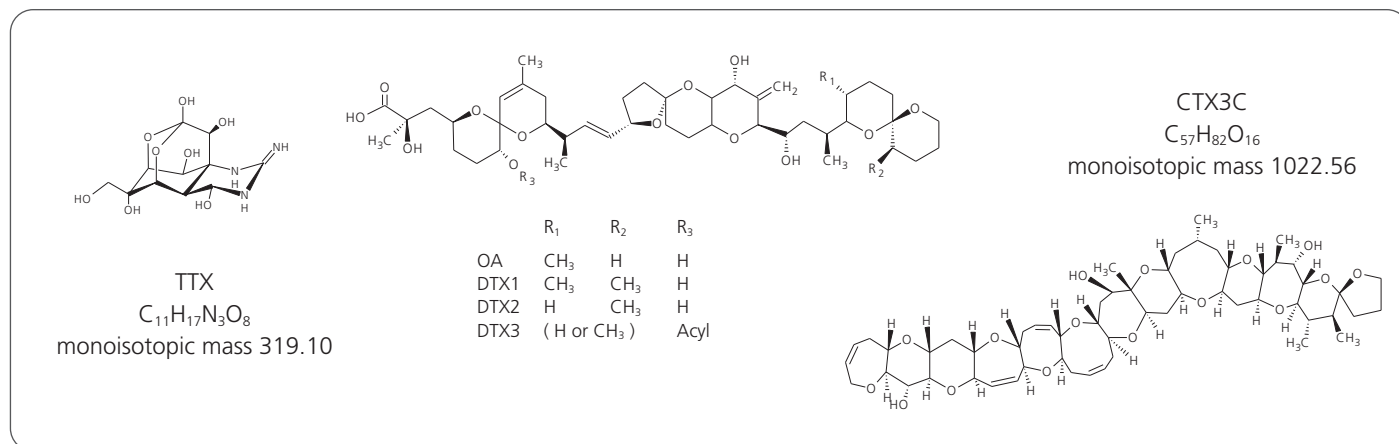

Figure 1. Structure of marine toxins



LCMS-8050 Triple quadrupole mass spectrometer

LC/MS/MS analysis

With the shift from the MBA toward to the instrumental method, the simultaneous analytical method of DSP and PSP has been eager to be utilized; however DSP is generally hydrophobic, while PSP mostly hydrophilic. It is relatively hard to analyze simultaneously both DSP and PSP with reversed phase mode.

Our purpose in this study is evaluation of potential analytical condition such as,

- 1) The simultaneous analytical method for DSP and PSP with a multi mode ODS column.
- 2) Reversed phase condition for DSP (acidic and neutral conditions)
- 3) Specified method for PSP, especially TTX with a HILIC mode column.

Development of Sensitive and Selective Methods for Identification of Marine Toxins by Liquid Chromatography Tandem Mass Spectrometry

Table 1 Analytical Conditions

	Condition	1	2	3	4
HPLC	Instrument	UHPLC Nexera X2 (Shimadzu)			
	Target compounds	TTX OA, DTX1, DTX2, CTX3C	OA, DTX1, DTX2, CTX3C	OA, DTX1, DTX2, CTX3C	TTX
	Total run time (min)	40	17.5	17.5	15
	Column	Scherzo SM-C18 (150×2 mm, 3 μm) Imtakt	L-column2 ODS (75×2.1 mm, 2 μm) CERI	L-column2 ODS (75×2.1 mm, 2 μm) CERI	InertSustain Amide PEEK (150×2.1 mm, 3 μm) GL Sciences
	Mobile phase A	0.05% formic acid water	2 mM ammonium formate with 50 mM formic acid	2 mM ammonium formate	0.1% formic acid water
	Mobile phase B	Acetonitrile with 0.05% formic acid	Acetonitrile / Water : 95 / 5 (v/v) including 2 mM ammonium formate with 50 mM formic acid	Acetonitrile / Water : 95 / 5 (v/v) including 2 mM ammonium formate	Acetonitrile with 0.1% formic acid
	Time program	B conc. 0% (0-2 min) → 100% (30-35min) → 0% (35.01 – 40 min)	B conc. 40% (0-2.5 min) → 100% (7.5-12.5 min) → 40% (12.51 – 17.5 min)	B conc. 40% (0-2.5 min) → 100% (7.5-12.5 min) → 40% (12.51 – 17.5 min)	B conc. 100% (0-3 min) → 5% (10 min) → 100% (10.01 – 15 min)
	Flow rate (mL/min)	0.2	0.2	0.2	0.4
	Column Temp. (°C)	25	30	30	30
	Injection Volume	5 μL			
MS	Instrument	LCMS-8050 (Shimadzu)			
	Ionization	Heated ESI (+/-)			Heated ESI (+)
	Mode	MRM			
	CID gas pressure	330 kPa			
	Temperatures	HESI:350°C / Desolvation line:200°C / Heat block:400°C			
Gas flow	Nebulizing gas (N ₂) : 2.5 L/min Heating gas (Air) : 15 L/min Drying gas (N ₂) : 5 L/min				

Development of Sensitive and Selective Methods for Identification of Marine Toxins by Liquid Chromatography Tandem Mass Spectrometry

Result and discussion

Mass Spectra of CTX3C

With electro spray ionization (ESI) on LC-MS/MS, since DSP and CFP are lipophilic toxins, various ions represented by sodium adduct and dehydrated ion are observed at positive mode (as $[M+Na]^+$, $[M+K]^+$, $[M+H-H_2O]^+$). While, OA and DTX1, DTX2 are monitored

as simple mass peak at negative mode. Under this observation, precursor ion of OA and DTX1, DTX2 were selected as deprotonated molecule at negative mode.

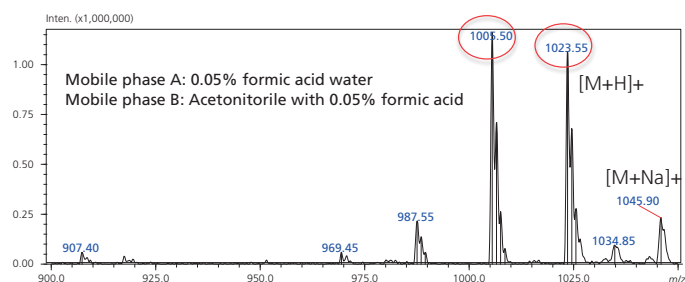

Since deprotonated molecule of CTX are weak signal at negative mode, its precursor ion were evaluated as protonated molecule or sodium adducted ion depending on the mobile phase constitutions at positive mode. It was observed that sodium adducted ion decreased with acetonitrile rather than methanol as mobile phase solvent.

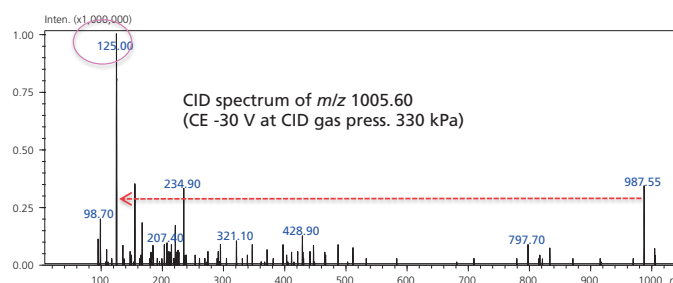
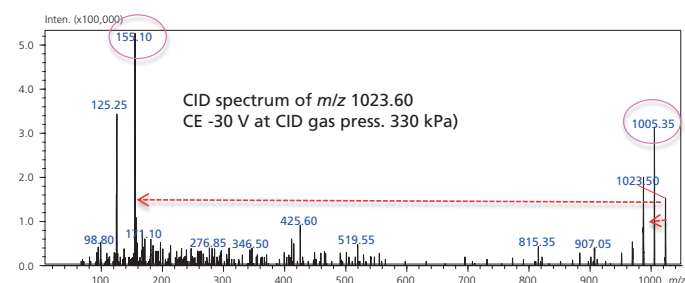

Figure 2. Mass spectra of CTX3C

MRM chromatograms of standard solution

With multi mode ODS column, both of the separation and sensitivity of 5 compounds (TTX, OA, DTX1, DTX2 and CTX) was successfully optimized. TTX is hard to retain in reversed phase mode due to its hydrophilicity. Thus, hydrophilic interaction (HILIC) mode

is alternative choice in comparison with another condition in the point of separation and sensitivity. As a result of evaluation using several types of columns, we found the InertSustain Amide column gave the better result of TTX analysis than other columns.

Development of Sensitive and Selective Methods for Identification of Marine Toxins by Liquid Chromatography Tandem Mass Spectrometry

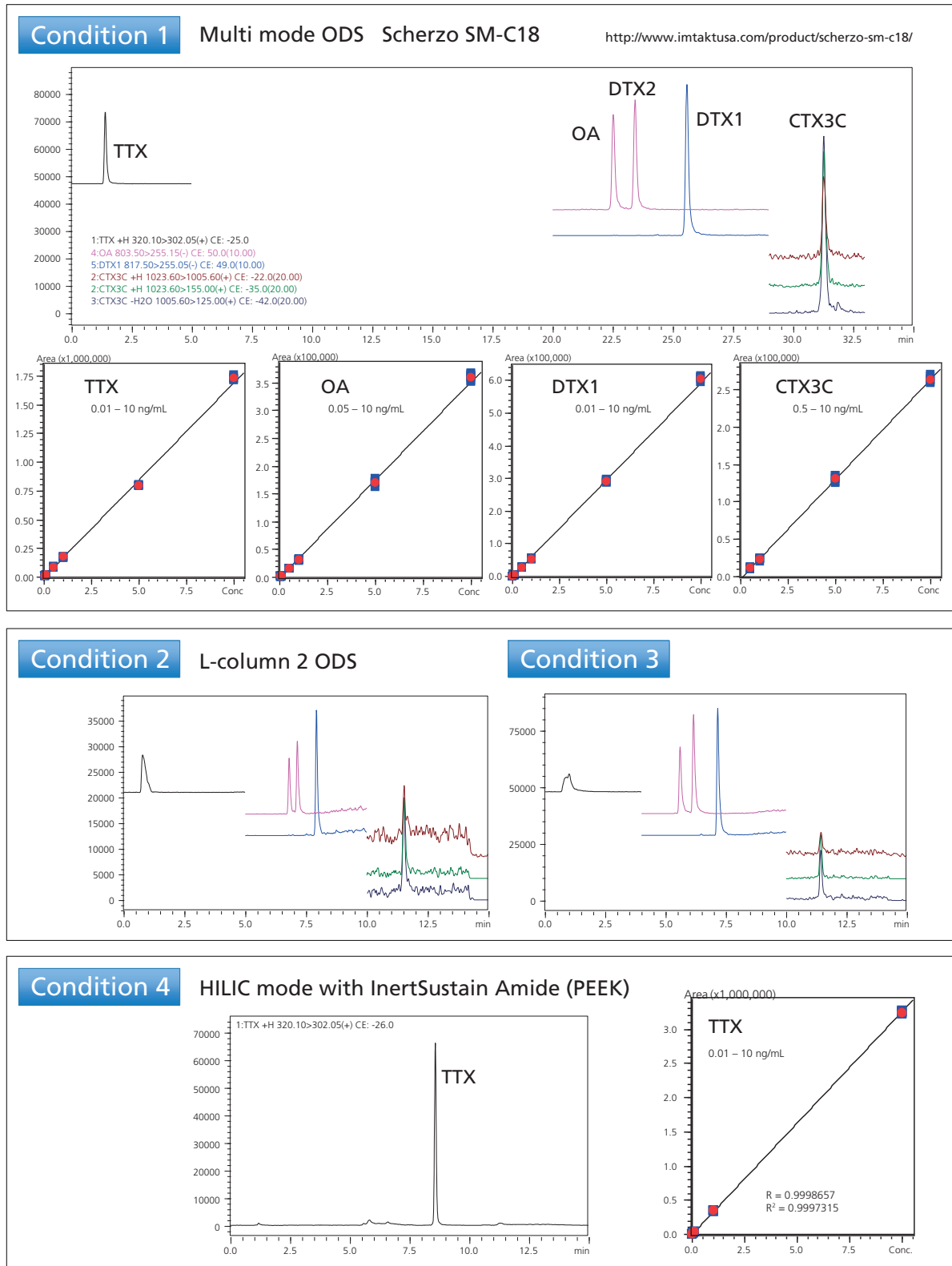

Figure 3. MRM Chromatograms (each, 1 ng/mL) and Calibration curves

Development of Sensitive and Selective Methods for Identification of Marine Toxins by Liquid Chromatography Tandem Mass Spectrometry

Evaluation of SPE pretreatment (Collaborated with Biotage®)

Preliminary evaluation of recovery with two different type of SPE cartridges were performed for sample preparation using two major toxic compounds (OA,DTX1). Schematic pretreatment protocol for each SPE is illustrated in figure 4.

The recovery of representative two compound above is shown in Table 2. The 66 ~ 83% of recovery was achieved with OA and DTX1 in the fraction of Elution 1 to 2, respectively using ISOLUTE® C18(EC) and EVOLUTE® EXPRESS ABN SPE.

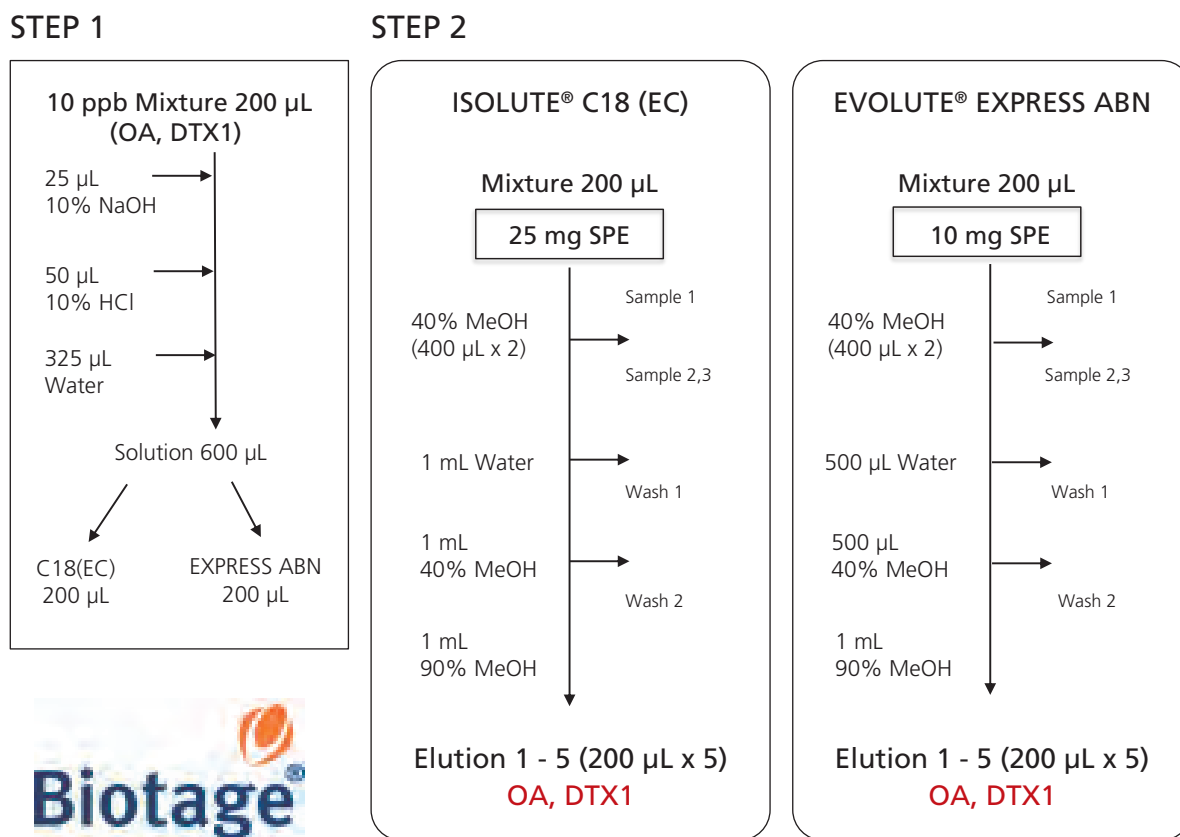

Figure 4. Protocol of SPE

Table 2 Recovery (%) with each SPE cartridge

	C18 (EC)	EXPRESS ABN
OA	66	74
DTX1	72	83

Development of Sensitive and Selective Methods for Identification of Marine Toxins by Liquid Chromatography Tandem Mass Spectrometry

Summary and Conclusion

- Survey of analytical conditions indicates that the Multi mode ODS column gives better result of separation for 5 representative toxins (TTX, OA, DTX1, DTX2 and CTX3C) than other mode. The Summary is shown in Table 3.
- HILIC mode is alternative selection for TTX due to its good peak shape and retention.
- These results suggest Multi mode or HILIC are ways to achieve general condition including additional toxin, especially PSP.
- Pre-treatment with Biotage® SPEs were evaluated and good recovery was obtained.
- Development of sample clean up protocol as well as the evaluation of matrix effect has been continuously investigated with Biotage®.

Table 3 LOD (ppb) of each toxin with four condition

	+/-	Transition (m/z)	1	2	3	4
TTX	+	320.10>302.05	0.01	-	-	0.01
OA	-	803.50>255.15	0.05	0.05	0.05	-
DTX2	-	803.50>255.15	0.05	0.05	0.05	-
DTX1	-	817.50>255.05	0.01	0.05	0.01	-
CTX3C	+	1023.60>1005.60	0.5	1	0.5	-
	+	1023.60>155.00	0.5	0.5	0.5	-
	+	1005.60>125.00	0.5	0.5	0.5	-

Acknowledgement: Authors appreciate collaboration and great discussion with Dr Kato and Mrs. Kaneko, Biotage® Japan.

Application News

No. C161

Liquid Chromatograph Mass Spectrometry

Multi-Residue Veterinary Drug Analysis of >200 Compounds using MRM Spectrum Mode by LC-MS/MS

Veterinary drugs are used for therapeutic, metaphylactic, prophylactic and growth promotion purposes. To provide an assurance that food from animals is safe with regards to residues of veterinary medicines, regulatory authorities have established Maximum Residue Limits (MRL's) for certain drugs in target tissues and animal species. Some pharmacologically active compounds identified by regulatory authorities have been prohibited and their hazardousness at all levels are being considered (EU regulation EC 37/2010; Commission Decision 2003/181/EC; 21CFR Part 556 Tolerances for Residues of New Animal Drugs in Food). In this article, we describe how a triple quadrupole mass spectrometer, which is both highly sensitive and selective, contributes to reducing false positive and false negative reporting when using a measurement mode called MRM Spectrum mode. MRM Spectrum mode acquires a high number of fragment ion transitions for each target compound and generates fragmentation spectra that can be used in routine library searching and compound verification using reference library match scores.

David Baker ^{*1}, Laetitia Fages ^{*2}, Eric Capodanno ^{*2}, Neil Loftus ^{*1}
^{*1}: Shimadzu, Manchester, UK
^{*2}: Phytocontrol, Nimes, France

■ Samples and Analysis Conditions

Samples of beef, egg, honey, milk and salmon were extracted and spiked with veterinary drugs in the calibration range of 0.001 to 0.1 mg/kg. Repeatability was assessed at low and high concentrations. Samples were measured using Shimadzu's Nexera X2 UHPLC and LCMS-8060 triple quadrupole mass spectrometer (Table 1 and 2). Over 200 veterinary drugs were targeted and over 2,000 MRM transitions in both ESI +/- were monitored during a gradient elution time of 12 minutes.

Table 1 UHPLC Conditions

Liquid chromatography			
UHPLC	Nexera LC system		
Analytical column	Restek Biphenyl (100 × 2.1, 2.7 μm)		
Column temperature	40 °C		
Flow rate	0.4 mL/minute		
Solvent A	0.1 % formic acid 0.5 mM ammonium formate solution		
Solvent B	0.1 % formic acid in methanol		
Binary Gradient	Time (mins)	%B	Time (mins) %B
	0.00	2	14.60 2
	12.50	100	17.50 Stop
	14.50	100	

Table 2 MS/MS Acquisition Parameters

Mass spectrometry	
Mass spectrometer	Shimadzu LCMS-8060
Pause time/dwell time	1 msec/3 msec
Polarity switching time	Pos/neg switching time set to 5 msec
Scope	218 drugs in positive ion mode (including internal standards) 11 drugs in negative ion mode Structure Analytics (in house development tool)
Source temperatures (interface; heat block; DL)	350 °C; 300 °C; 150 °C
Gas flows (nebulising; heating; drying)	3 L/min; 10 L/min; 10 L/min

■ Advantages of MRM Spectrum Mode

The measurement method can be easily set using the MRM optimization tool and measurement window (MRM Synchronization) settings of LabSolutions LCMS. The method achieves high data densities and a high data sampling rate across each elution peak. This approach generates a consistent loop time and sampling rate producing reliable quantitation and peak integration. It also provides great operator-friendliness in routine simultaneous analysis of veterinary drugs by enhancing flexibility in qualifier and quantifier ion selection. The number of fragment ion transitions generated from a single precursor ion is limited only by the chemical structure of the veterinary drug.

■ Results

MRM Spectrum mode was used to acquire a high number of fragment ion transitions for each veterinary drug target. For chlortetracycline, 11 precursor-fragment ion transitions were acquired using optimized collision energies (Fig. 1). Acquiring a high number of fragment ion transitions enables generation of fragmentation spectra which can be used in library searching and compound verification for each veterinary drug. (Chlortetracycline is a tetracycline class of antimicrobials. According to the Sixth ESVAC report published in 2016, of the overall sales of antimicrobials in the 29 EU countries in 2014, the largest amount, expressed as a proportion of mg/PCU, was accounted for by tetracyclines (33.4 %). This is followed by penicillins (25.5 %) and sulfonamides (11.0 %). Chlortetracycline was selected as a representative target).

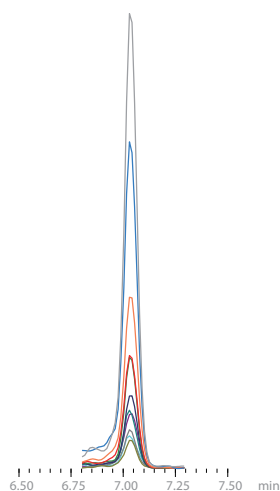

Compound name Chlortetracycline
Accurate mass 479.1216 [M+H]⁺
Formula C₂₂H₂₃ClN₂O₈
CAS 57-62-5

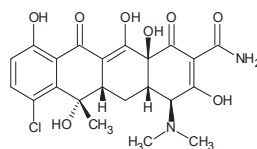

MRM Spectrum Mode

11 MRM's acquired for chlortetracycline at 10pg/uL in egg.

1:479.10>444.00 (+)	CE: -23V	7:479.10>300.80(+)	CE: -45V
2:479.10>461.95 (+)	CE: -35V	8:479.10>287.90(+)	CE: -53V
3:479.10>154.00 (+)	CE: -34V	9:479.10>274.95(+)	CE: -44V
4:479.10>98.05(+)	CE: -45V	10:479.10>370.95(+)	CE: -31V
5:479.10>260.05(+)	CE: -60V	11:479.10>285.85(+)	CE: -56V
6:479.10>303.05(+)	CE: -37V		

MRM Spectrum mode

Higher specificity
Higher reporting confidence
Library searchable fragment data.

The number of precursor-fragment ion transitions monitored is limited only by the structural chemistry of the molecule. Typically more than 10 precursor-fragment ion transitions were monitored for each veterinary drug.

Fig. 1 Utilization of MRM Spectrum Mode (Chlortetracycline)

Fig. 2 shows the MRM reference spectrum for chlortetracycline with assigned fragment structures. The MRM Spectrum mode is a measurement mode which combines MRM with the generation of a product ion spectrum. The product ion spectrum can be used for compound identification by searching a library.

As the collision energy was optimized for each fragment ion to generate a product ion spectrum, the library spectrum is highly specific and selective.

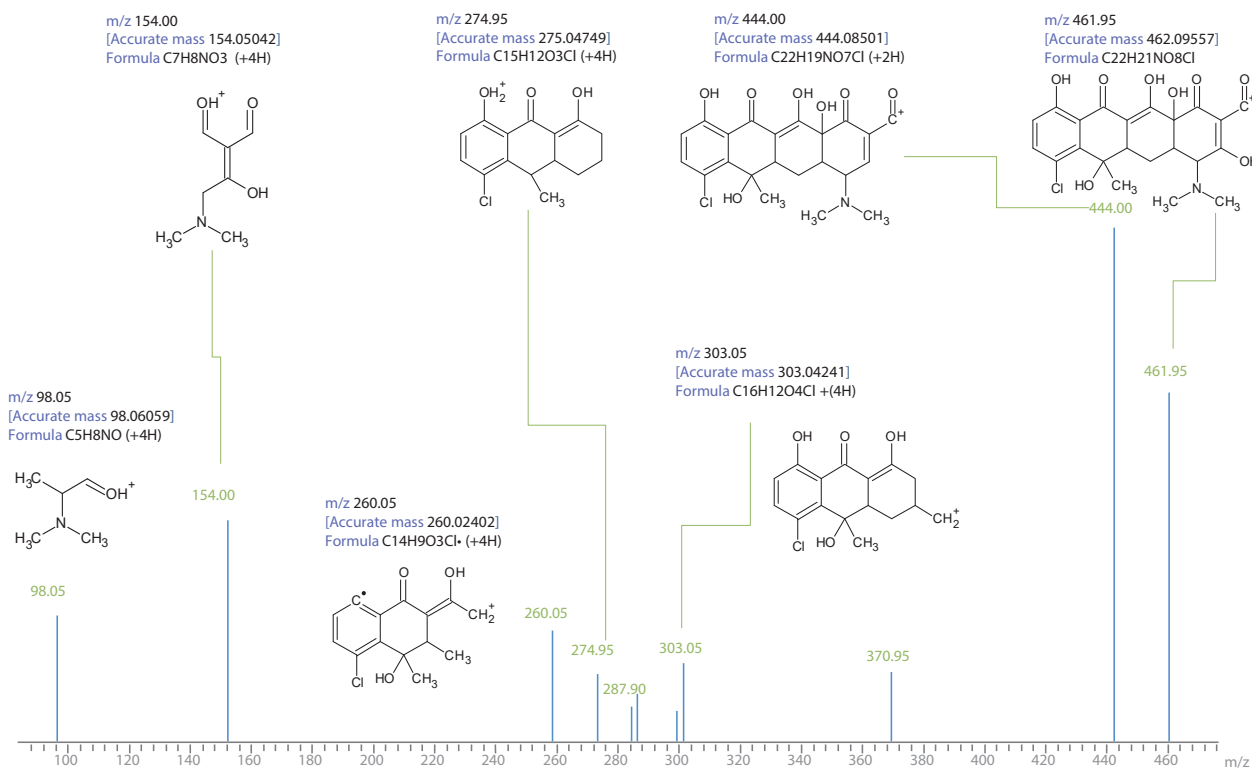

Fig. 2 MRM Reference Spectrum with Assigned Fragment Structures (Chlortetracycline)

Library Identification using MRM Spectrum Mode

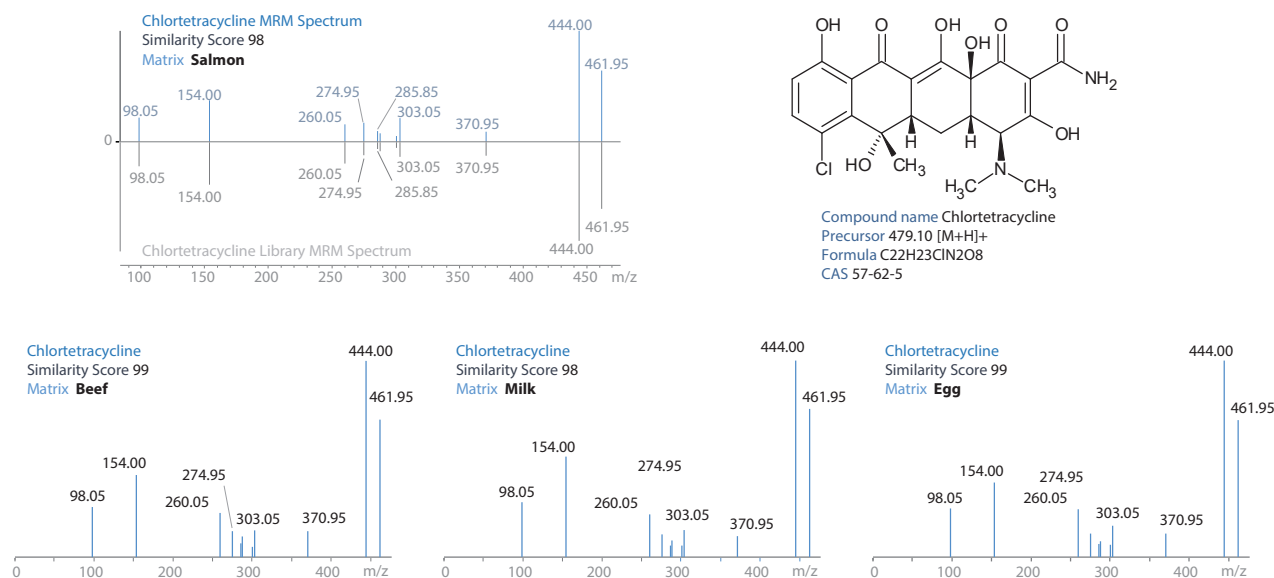
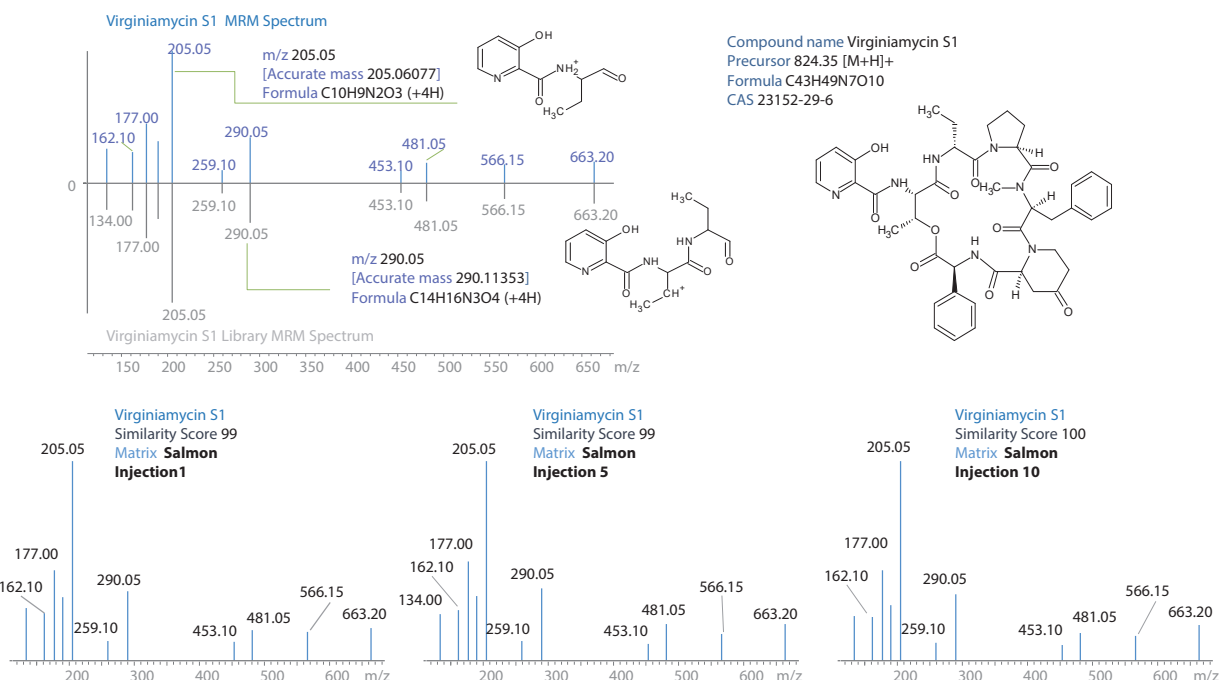

Fig. 3 Library Searchable MRM Spectra in Different Matrices Spiked at 10 pg/μL (Chlortetracycline)

Fig. 4 shows the MRM spectra and the n=10 measurement results of four compounds for salmon extract spiked with virginiamycin S1 at a concentration of 10 pg/μL. The library match score was above 99 in all injections (MRM spectra of injections 1, 5 and 10 are

indicated). Also, the %RSD for oxytetracycline, sulfadimethoxine, ormetoprim, and virginiamycin spiked into salmon extract (n=10; 10 pg/μL) acquired using a conventional 2-MRM method was compared with that of the MRM spectrum method.



Compound name	Oxytetracycline		Sulfadimethoxine		Ormetoprim		Virginiamycin	
Number of MRM's	2MRM's	8MRMs	2MRM's	11MRMs	2MRM's	11MRMs	2MRM's	11MRMs
Mean peak area								
Quantitation ion	1890170	1729171	7809989	7227748	8291171	8160952	2232967	1956045
%RSD	3.74	3.04	1.49	1.46	1.54	1.18	0.91	1.65

Fig. 4 MRM Spectra and n=10 Results of Salmon Extract Spiked with Virginiamycin S1 at 10 pg/μL

Quantitation Results using MRM Spectrum Mode

To assess the robustness of the MRM Spectrum mode, the same sample was repeatedly injected. The method used complies with the identification criteria set out in the EU guidelines SANTE/11945/2015 that require the retention time and the ion ratio from at least 2 MRM ion ratios to be within acceptable tolerance limits. The absolute response and signal variability were

compared to those of the MRM Spectrum mode (Fig. 4). Both methods resulted in a variance of less than 4 %RSD (n=10 for each method; 10 pg/uL spiked into salmon matrix). Fig. 5 indicates MRM spectra and the calibration curve obtained for sulfamerazine as an example of quantitation results.

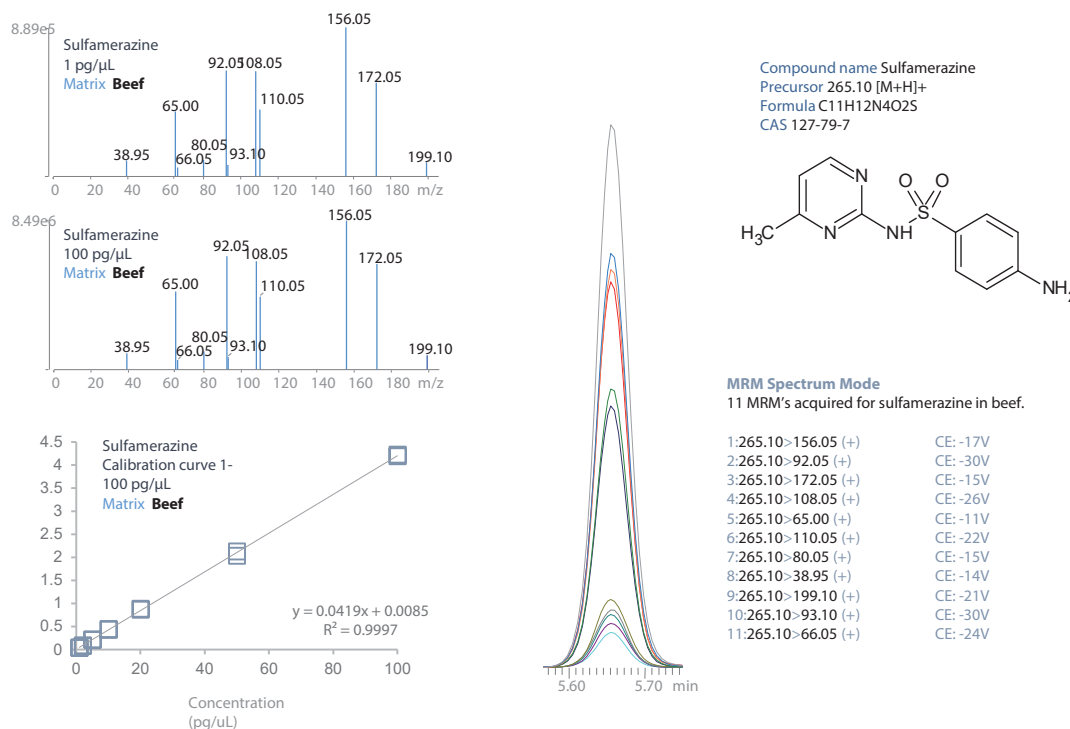

Fig. 5 MRM Spectra and Calibration Curve of Sulfamerazine (1 pg/uL to 100 pg/uL)

Conclusion

The level of confidence in compound identification and verification was increased by using a higher number of MRM transitions for each veterinary drug target and thereby reducing false negative and false positive reporting. Although the number of transitions for each target is dependent upon the chemical structure of the target, typically more than 10 transitions can be monitored for each compound. MRM Spectrum mode combines conventional quantitation with the

generation of a high quality product ion spectrum which can be used to achieve highly reliable compound identification and verification by library searching. In this research, use of the MRM Spectrum mode was examined by quantifying and identifying 212 veterinary drugs (the method included 2,009 MRM transitions). Limits of detection, linearity or repeatability were not compromised compared to a conventional 2-MRM method.

Application News

No. AD-0120

Halal Authentication Analysis / MultiNA

Sensitive Detection of Pork DNA in Processed Meat products on PCR-MultiNA Platform

Djohan Kesuma, Leonard Guan Seng Lim* & Zhaoqi Zhan

Application Development & Support Centre, Shimadzu (Asia Pacific) Pte Ltd, Singapore

*ITS Student, Nanyang Technological University (NTU), SPMS-CBC, Singapore

Introduction

The authentication of species content in processed meat and food products is implemented in many countries for various reasons such as economic and cultural beliefs [1, 2]. Such identification is of importance in various religious communities where consumption of a particular species of meat is prohibited. Based on Islamic Shari'ah (law), the term Halal is often used in reference to food and drinks, where they are permissible for Muslims to consume. The most common example of non-halal (Haram) food is pork. In this Application News, a highly sensitive method is described for detection of pig DNA in processed food such as sausages. It is based on DNA extraction and species-specific PCR amplification of pork specific, followed by microchip electrophoresis detection on MultiNA [3]. This PCR-MultiNA method is highly sensitive in detecting the extracted pork DNA fragment, with housekeeping fragments as confirmation.

Experimental

Reagents / Kits

- DNeasy mericon™ Food Kit (50) from QIAGEN
- PCR Mastermix Pod: Pork from NeoGen Corporation
- DNA-500 Reagent Kit for MultiNA from Shimadzu
- SYBR Gold nucleic acid gel stain from *Life Technologies*
- 25 base-pair ladder from Invitrogen

Analytical Conditions for PCR Products

- Instrument : MCE-202 MultiNA
- Analysis Mode : DNA 500 On-Chip Mode

Procedure for detection of Pork DNA

The process workflow is described in Figure 1. It consists of three steps: (1) extraction of DNA from sausage sample, (2) species-specific PCR amplification of the extracted DNA and (3) detection of the pork DNA fragment by microchip electrophoresis on MultiNA.

DNA extraction from sausage sample was carried out using DNeasy mericon Food Kit from QIAGEN in accordance with the protocol of the kit [4]. The extracted DNA sample was amplified via PCR using BioKits PCR Mastermix Pod, pork specific obtained from Neogen Corporation [5]. DNA amplification was carried out in a 25 µL volume reaction mixture, which contained 19.9 µL of Pork PCR mastermix, 0.1 µL of NovaTaq™ Hot Start DNA polymerase from Novagen, 4 µL of TE buffer and 1 µL of the DNA extract. The amplification was run using the following program: 94°C for 10 minutes for activation of Hot Start Taq, followed by 30 cycles at 94°C for 15 seconds, 64°C for 15 seconds, and 72°C for 15 seconds, and ended by the extension step at 72°C for 3 minutes. The PCR products were held at 4°C until subjecting to microchip electrophoresis on MultiNA. The amplified PCR products were then analysed using Shimadzu MCE-202 MultiNA.

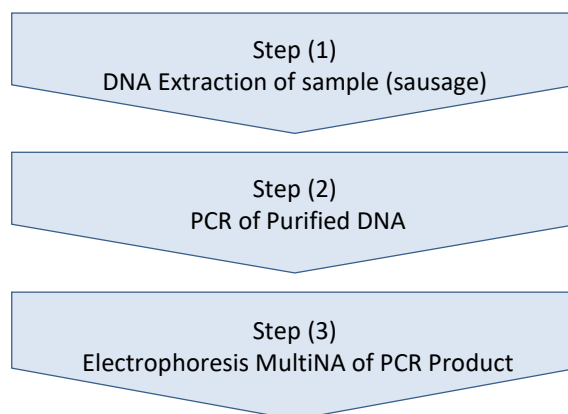

Figure 1: Experimental procedure for detection of Pork DNA on MultiNA

Results and Discussion

PCR-MultiNA procedure: The BioKits PCR Mastermix Pod is used normally with agarose gel electrophoresis for detection of the targeted species DNA [5]. Instead of the agarose gel electrophoresis, microchip electrophoresis (MCE) was used to detect the DNA fragment on MultiNA in this work [3]. The advantages of the MCE method are high detection sensitivity, easy quantitation, fast and fully-automated operation. The PCR tubes after PCR process of food samples can be loaded onto the MultiNA directly. The subsequent analysis for detection of targeted species DNA is carried out in a fully-automated manner from adding reagents, system checking, ladder calibration to batch sample measurement on the MultiNA. The results are displayed in electropherogram (Figure 2). The precise area of the

electropherogram peak of pork DNA (314 bp) can be obtained, which is proportional to the amount of the DNA molecules in the sample.

Figure 2 shows that the PCR Mastermix, pork specific, amplified the pork DNA fragment 313 bp (target size: 314 bp) and the housekeeping fragment 395 bp (target size: 380-420 bp) in pork sausage sample selectively. In the DNA extract of chicken sausage, pork DNA fragment was not detected. The only observed fragment was the housekeeping DNA at 418 bp. A negative control of PCR mixture without any template DNA was included as blank.

The accuracy and reproducibility of the PCR-MultiNA method are summarized in Table 1. The targeted pork DNA fragment is 314 bp. The measured size is at 314-324 bp, which is within the accuracy specification of MultiNA ($\pm 5\%$). The reproducibility of the method is at 0.2%~1.0%.

Table 1: Accuracy and reproducibility of PCR-MultiNA procedure for detection of pork DNA using Neogen Biokits PCR Mastermix

Pork Content	Repeat No. (n)	Measured Ave (bp)	Accuracy, Ave (%)	RSD (%)
100%	4	317.7	101.2	0.74
3% & 5%	3	316.3	100.7	1.02
1%	3	316.7	100.8	0.18
0.5%	4	320.3	102.0	0.95
0.1%	5	322.0	102.5	0.54

Sensitivity: Pork sausage was spiked into halal certified chicken sausage to prepare spiked samples with pork content in 0.1%~5%(wt) for testing the detection sensitivity and reliability of the method. The results (Figure 3, Table 1) show that the PCR-MultiNA method established is able to detect pork DNA fragment (314 bp) in chicken sausage spiked with pork sausage at level as low as 0.1 % firmly. Furthermore, the peak areas of five measurements of 0.1% pork-spiked chicken sausage samples prepared in different days are considerably consistent with a CV (Coefficient of Variation) of 40.6%. For 0.5% pork-spiked chicken samples, the CV of four measurements are 20.7%. A correlation between peak area and content of pork in the sample is plotted in Figure 4, which reveals that the peak area increases proportionally with the pork content at a low range (0.1%~1%). Based on this finding, it is possible to establish at least a semi-quantitation method to detect the presence and content level of pork in processed food.

Conclusions

Using Neogen Biokits PCR Mastermix Pod, pork specific (314 bp), a highly sensitive procedure for detection of pork in processed meat and food products was established on a PCR-MultiNA platform. The microchip electrophoresis and fluorescence detection of MultiNA exhibits the advantages of high sensitivity, reliability and easiness in operation. The method can detect as low as 0.1% (wt) of pork sausage spiked in halal certified chicken sausage sample.

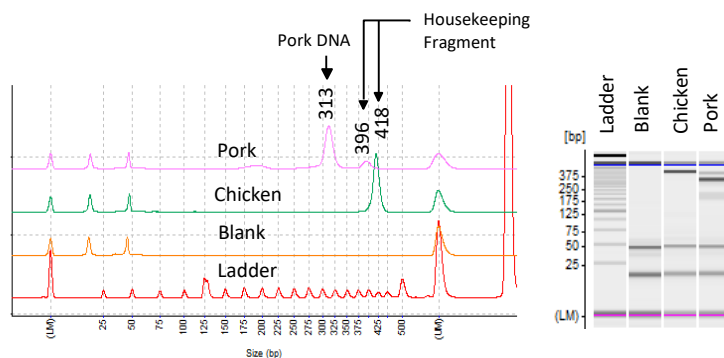

Figure 2: Electropherograms (EC) of PCR product of food samples (left), Detected peaks are pork DNA fragment (~313bp), housekeeping fragments (pork~395bp, chicken~418bp) and DNA ladders. A gel imaging display converted from EC (right).

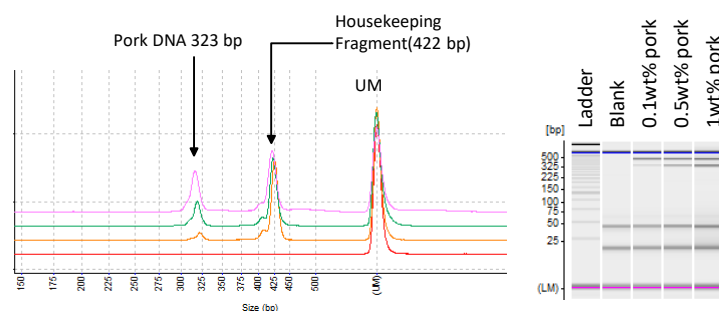

Figure 3: Detection of pig DNA fragment (~313bp) in chicken sausage samples spiked with 0% (blank), 0.1%, 0.5% and 1% of pork sausage (from bottom to top).

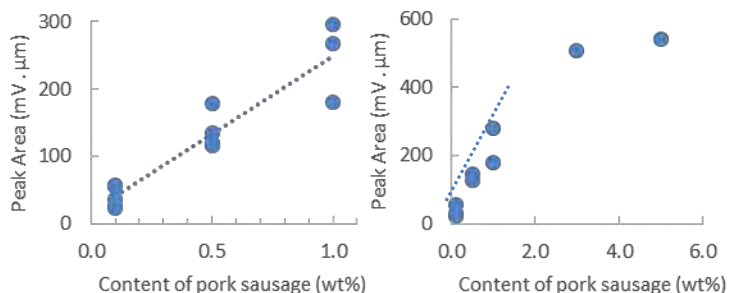

Figure 4: Correlation of area of electropherogram peak with content of pork sausage spiked in chicken sausage sample on PCR-MultiNA using Biokits PCR Mastermix Pod.

References:

1. S. Edris, M.H.Z. Mutwakil, O.A., Abuzinadah, H.E. Mohammed, A. Ramadan, N.O. Hadalla, A.M. Shokry, S.M.Hassan, R.M. Shoaib, F.M. El-Doomyati and A. Bahieldin, *Life Sci. Journal*, 2012; 9(4), 5831-5837.
2. Fajardo, V., González, I., Rojas, M., García, T. & Martín, R. 2010, A review of current trends in Food Science & Technology, 2010. 21(8): p. 408-421.
3. Application Notes 11, Rapid Identification of Meat Species with MCE-202 "MultiNA", Shimadzu.
4. DNeasy[®] *mericon*[™] Food Handbook, QIAGEN Sample & Assay Technologies. 2010.
5. Biokits Animal Speciation Selection Module, Neogen[®] Corporation 2013, 8 – 10.

Note: The Application and Shimadzu Instruments are for research use only, not for use in diagnostic procedures.

Application News

No. C99

Liquid Chromatography Mass Spectrometry

Quantitative Analysis of Veterinary Drugs Using the Shimadzu LCMS-8050 Triple Quadrupole Mass Spectrometer

Foods in which chemical residues, like pesticides, feed additives, and veterinary drugs found in excess of maximum residue levels have been banned from sale in many countries around the world. Compounds that are subject to residue standards vary widely and the list is expected to grow. Because of this, there is a need for a

highly sensitive and rapid analytical technique to analyze as many of these compounds as possible in a single run. This Application News introduces an example of the high-sensitivity analysis of 89 veterinary drugs in a crude extract of livestock and fishery products.

Sample Preparation

The typical samples used in the analysis of veterinary drugs contain large amounts of lipids because they are commonly meat and fish samples. Sample preparation is extremely important to ensure excellent sensitivity and repeatability. To avoid the typical time-consuming and laborious solid phase extraction sample preparation procedure, the QuEChERS method, which is typically used for the preparation of vegetables, was selected to simplify sample preparation.

The QuEChERS method normally consists of two steps, the first is an acetonitrile extraction and the second a cleanup step, but this time only the acetonitrile extraction step was used.

* QuEChERS Extraction Salts kit: Restek Q-sep™ AOAC2007.01

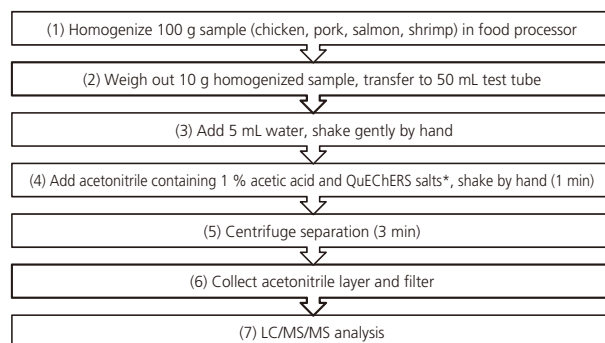

Fig. 1 Sample Preparation Procedure

Improved Peak Shape Using Sample / Water Co-Injection

When conducting reversed phase chromatography, the peaks of polar compounds may split or collapse depending on the relationship between the sample solvent and mobile phase. In cases where the sample solvent is rich in organic solvent, the elution strength must be lowered (by substitution or dilution) with the addition of water. As the pretreated sample solvent in this analysis consists of 100 % acetonitrile, injection in that state into the LC/MS will result in split peaks for some of the substances (Fig. 2 left).

To eliminate as much of the time and effort typically associated with sample preparation, the pretreatment features of the autosampler (SIL-30A) were utilized to conduct co-injection of sample and water, which resulted in improved peak shapes.

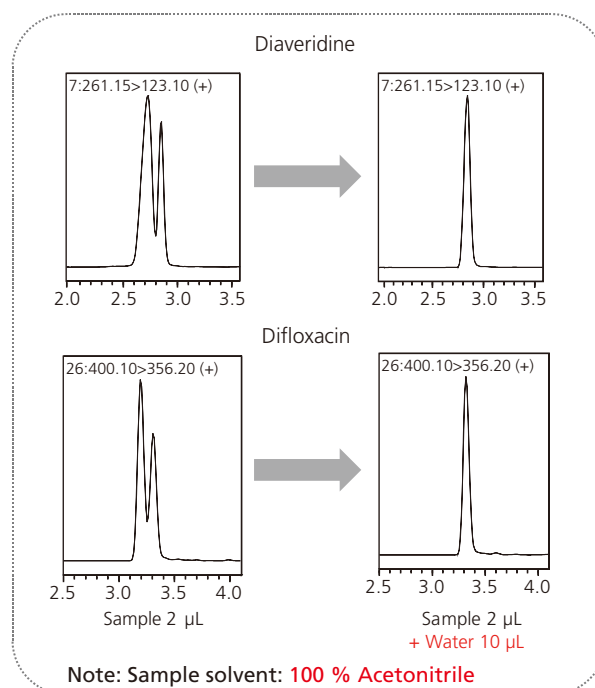
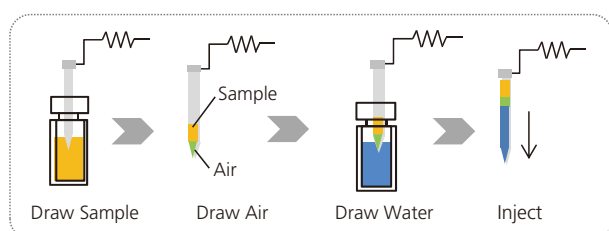

Fig. 2 Comparison of Peak Shape

MRM Analysis of Matrix Standards

Fig. 3 shows the MRM chromatogram of the matrix standard solution consisting of the sample solution with added standard solution (data obtained using pork extract solution). Table 1 shows the lower limits of quantitation for the standard solution without added matrix and with added matrix, respectively. In a crude extract obtained by acetonitrile extraction alone, sensitivity was comparable to that obtained for most of

the compounds using only standard solution. Although there were several compounds for which the lower limit of quantitation was different in the standard solution than the matrix-added solution, rather than attributing this to matrix effects, it is thought to be caused by elevated background due to ions derived from contaminating components (Refer to Fig. 5).

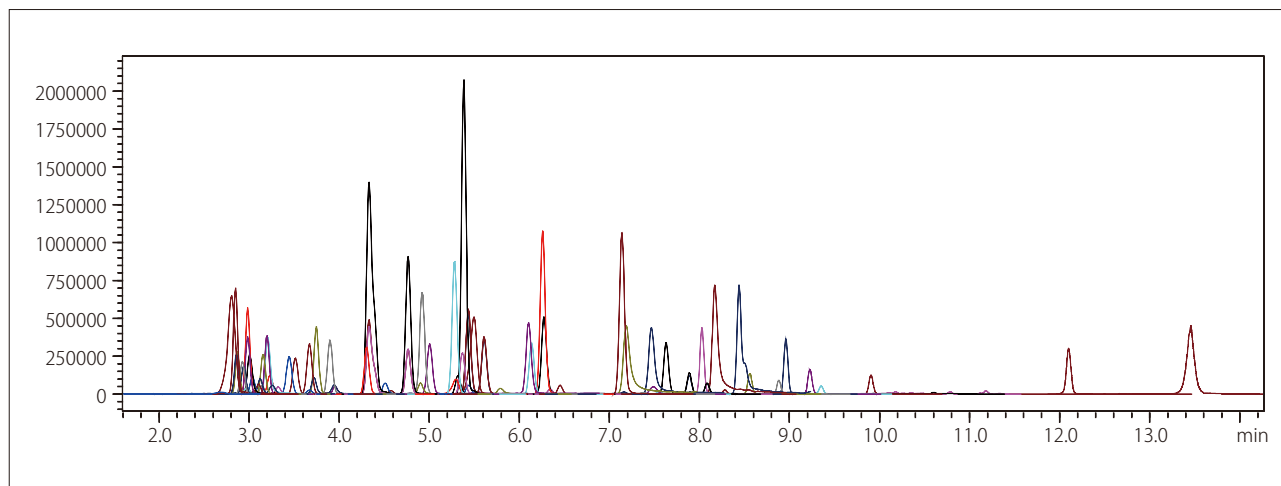

Fig. 3 MRM Chromatograms of 89 Veterinary Drugs (10 µg/L pork extract solution with added standard solution)

Table 1 LOQs of Veterinary Drugs in Neat Standards and Matrix Standards and Calibration Range of Veterinary Drugs in Matrix Standards

	Std. Solution		Matrix-Added Std. Solution			Std. Solution		Matrix-Added Std. Solution	
	Min. Conc.	Max. Conc.	Min. Conc.	Max. Conc.		Min. Conc.	Max. Conc.	Min. Conc.	Max. Conc.
Gentamicin	0.5	50	1	50	Sulfachloropyridazine	0.02	20	0.02	20
Sulfanilamide	1	50	1	50	Sulfadimethoxine	0.02	10	0.02	10
Levamisole	0.05	50	0.05	50	Tylosin	0.05	50	0.05	50
Lincomycin	0.01	10	0.01	10	Sulfamethoxazole	0.02	10	0.1	10
5-Propylsulfonyl-1-benzimidazole-2-amine	0.05	10	0.05	10	Sulfaethoxypyridazine	0.02	10	0.02	10
Diaveridine	0.01	10	0.01	10	Tiamulin	0.01	50	0.01	50
Trimethoprim	0.02	20	0.02	20	Florfenicol	0.5	50	10	50
Marbofloxacin	0.01	50	0.01	50	2-Acetylaminio 5-nitrothiazole	0.05	50	0.05	50
Sulfisomidine	0.02	20	0.02	20	Sulfatroxazole	0.01	5	0.01	5
Norfloracin	0.5	50	0.5	50	Leucomycin	0.01	50	0.01	50
Ormetoprim	0.02	10	0.02	10	Sulfisoxazole	0.01	50	0.05	50
Thiabendazole	0.01	10	0.01	10	Oxolinic acid	0.01	50	0.1	50
Ciprofloxacin	0.05	10	0.5	10	Chloramphenicol	0.5	50	1	50
Neospiramycin I	0.01	10	0.05	10	Clorsulon	0.5	50	1	50
Danofloxacin	0.1	10	0.1	10	Sulfabenzamide	0.01	10	0.01	10
Enrofloxacin	0.05	50	0.1	50	Ethopabate	0.01	10	0.01	10
Oxytetracycline	0.01	50	0.1	50	Sulfadoxine	0.02	20	0.02	20
Xylazine	0.01	10	0.01	10	Sulfaquinoxaline	0.02	10	0.02	10
Orbifloxacin	0.05	50	0.05	50	Prednisolone	0.1	20	0.05	20
Sulfacetamide	1	50	1	50	Ofloxacin	0.5	50	0.5	50
Clenbuterol	0.01	10	0.01	10	Flubendazole	0.01	50	0.01	50
Tetracycline	0.05	50	0.01	50	Methylprednisolone	0.5	50	0.5	50
Spiramycin I	0.01	50	0.01	50	Nalidixic acid	0.01	50	0.01	50
Sarafloxacin	0.5	50	0.5	50	Dexamethasone	0.5	50	0.5	50
Difloxacin	0.05	50	0.1	50	Flumequine	0.01	50	0.01	50
Sulfadiazine	0.02	20	0.1	20	Benzyloxyphenoxymethyl penicillin	0.5	50	0.5	50
Sulfathiazole	0.02	20	0.1	20	Sulfantran	0.2	50	0.2	50
Sulfapyridine	0.02	20	0.1	20	Sulfabromomethazine	0.01	50	0.01	50
Carbadox	0.05	10	0.05	10	beta-Trenbolone	0.02	50	0.1	50
Pyrimethamine	0.02	20	0.02	20	Emamectin B1a	0.01	50	0.01	50
Sulfamerazine	0.02	20	0.02	20	alpha-Trenbolone	0.02	50	0.1	50
Chlortetracycline	0.1	50	0.1	50	Piromidic acid	0.01	50	0.05	50
Tilmicosin	0.1	50	0.1	50	Zeranol	1	50	0.1	50
Thiamphenicol	1	50	1	50	Ketoprofen	0.01	50	0.05	50
Sulfadimidine	0.02	20	0.02	20	Testosterone	0.01	10	0.05	10
Sulfamethoxydiazine	0.01	10	0.02	10	Famphur	0.05	50	0.05	50
Sulfamethoxyypyridazine	0.02	20	0.02	20	Fenobucarb (BPMC)	0.01	50	0.01	50
Sulfisozole	0.01	50	0.01	50	Clostebol	0.05	50	0.05	50
Trichlorfon (DEP)	0.05	50	0.05	50	Dichlofenac	0.01	50	0.01	50
Sulfamonomethoxine	0.02	20	0.02	20	Melengestrol Acetate	0.05	50	0.05	50
Furazolidone	1	50	1	50	Temephos (Abate)	0.01	50	0.5	50
Difurazone	0.05	50	0.05	50	Allethrin	0.1	50	1	50
Erythromycin A	0.01	50	0.01	50	Cloasantel	0.01	10	0.01	10
Cefazolin	0.5	50	0.5	50	Monensin	0.01	10	0.01	10

(Unit: µg/L)

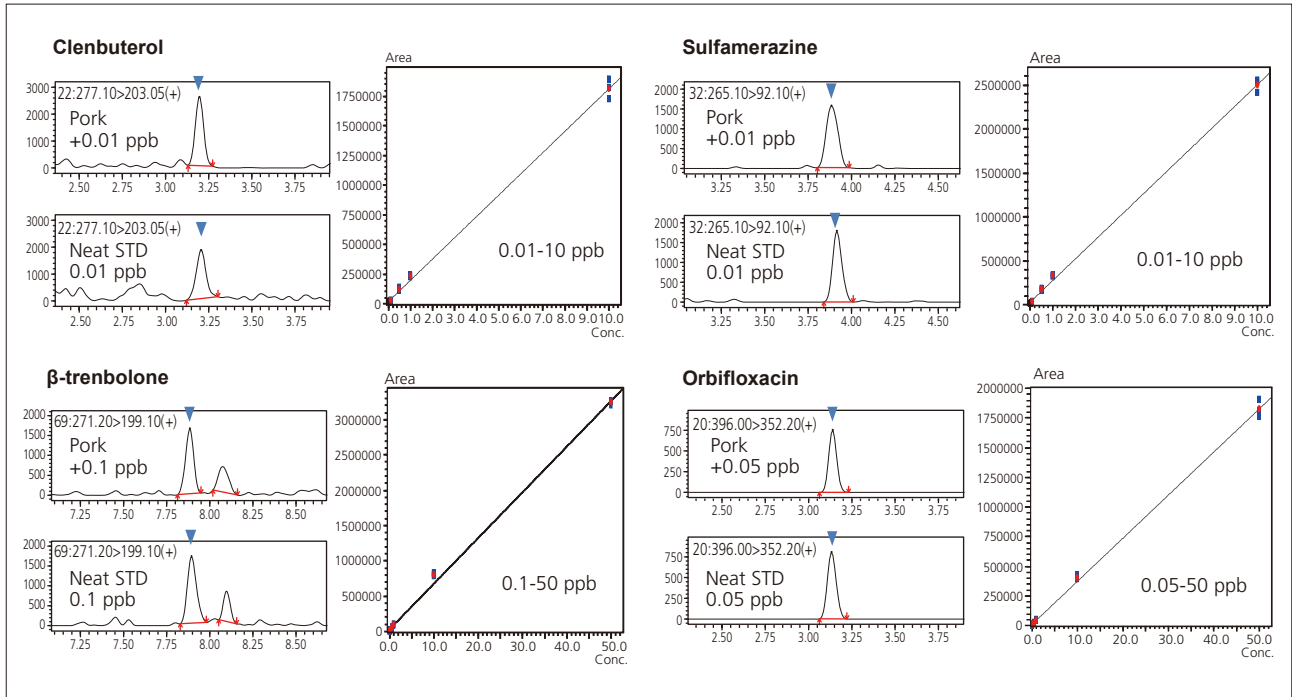

Fig. 4 MRM Chromatograms in the Vicinity of the LOQ and Calibration Curves of Typical Compounds

Recoveries of Veterinary Drugs in Crude Extracts from Livestock and Fishery Products (Matrix Effect Verification)

We examined whether or not the matrix affected measurement of actual samples. This time, four types of food product samples were used, including shrimp, chicken meat, pork, and salmon. Standard solution was added to the acetonitrile extraction solution of each of these to obtain a final concentration of 10 μ g/L, after

which the rates of recovery were determined. The results indicated that 90 % of the compounds were recovered at rates of 70 to 120 % and measurement was accomplished without any adverse matrix effects even though the crude extract solution was subjected only to acetonitrile extraction.

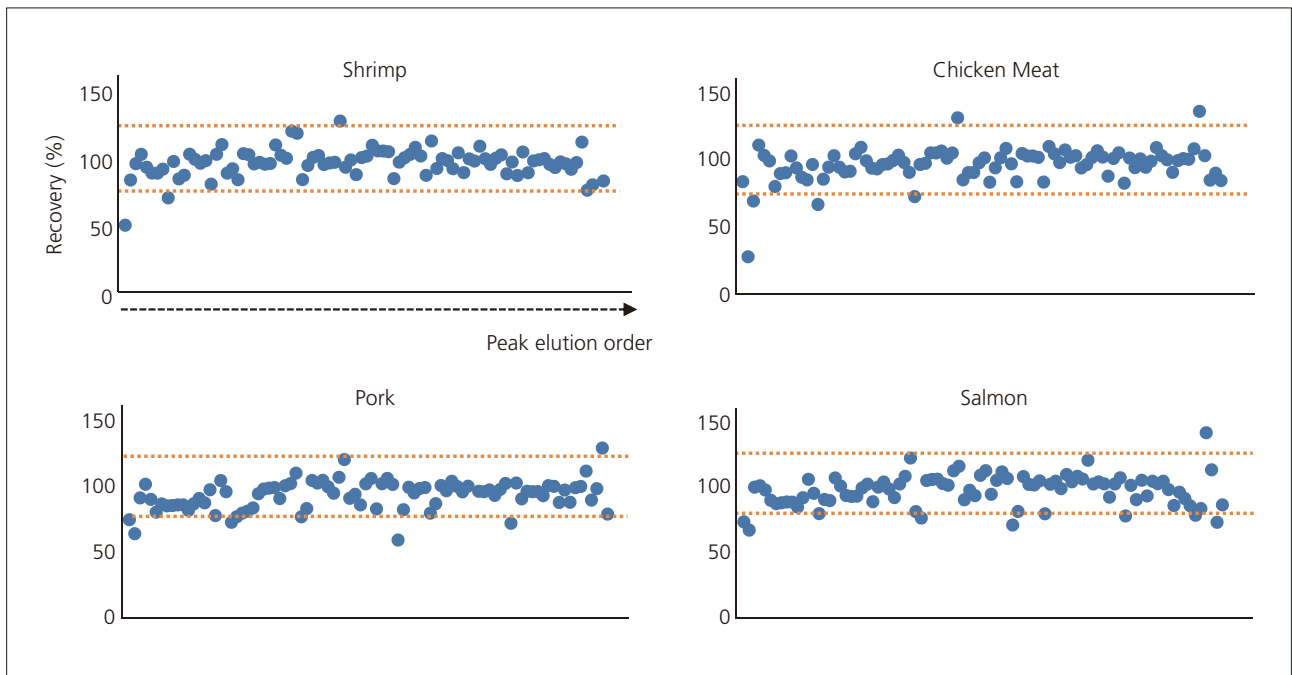

Fig. 5 Recoveries of Veterinary Drugs in Each of the Matrices

Acetonitrile Extraction Efficiency Using QuEChERS Method

To check the efficiency of acetonitrile extraction by the QuEChERS method, standard solution was added at stage (2) of Fig. 1 to obtain a concentration of 10 µg/L, and the recoveries were determined. Good recoveries of approximately 80 % were obtained in cases both

with and without the addition of matrix. However, relatively poor recoveries were seen for highly polar compounds such as tetracycline and quinolone. For these compounds, it is necessary to examine the use of a separate extraction solvent and extraction reagent.

Table 2 Recoveries (Pre-Spike)

Recovery	Without Matrix	With Matrix (Pork)	Compounds with Poor Recovery
< 50 %	17 (19 %)	13 (15 %)	Tetracyclines Quinolones
50 % - 70 %	1 (1 %)	8 (9 %)	
> 70 %	71 (80 %)	68 (76 %)	

Robustness

We checked the long-term stability of the instrument using a solution of pork crude extract (spiked with 10 µg/L standard solution). Even after continuous

measurement of an extremely complex matrix over a period of 3 days, we were able to obtain stable data.

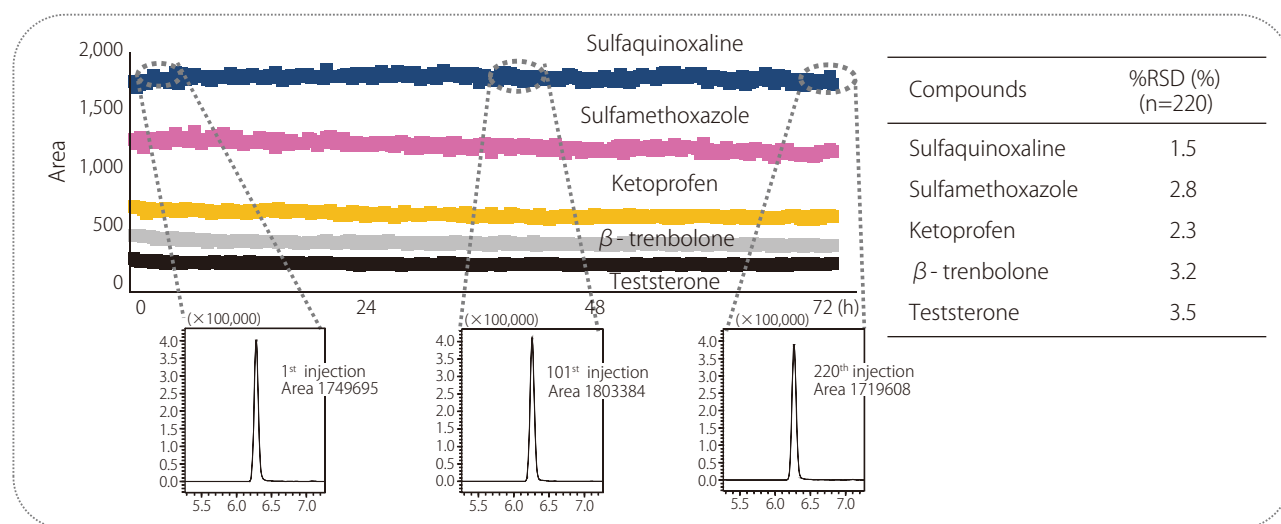

Fig. 6 Area Plot and %RSD of Typical Compounds with Continuous Analysis

Table 3 Analytical Conditions

Column	: Shim-pack XR-ODS II (75 mm × 2.0 mm I.D., 2.2 µm)
Mobile Phase A	: 0.1 % Formic Acid - Water
Mobile Phase B	: Acetonitrile
Time Program	: 1 %B (0 min) → 15 %B (1 min) → 40 %B (6 min) → 100 %B (10-13 min) → 1 %B (13.01-16 min)
Flowrate	: 0.2 mL/min.
Injection Volume	: 2 µL (2 µL sample solution + 10 µL water)
Oven Temperature	: 40 °C
Ionization Mode	: ESI (Positive / Negative)
Probe Voltage	: +2.0 kV / -1.0 kV
Nebulizing Gas Flow	: 3.0 L/min.
Drying Gas Flow	: 10.0 L/min.
Heating Gas Flow	: 10.0 L/min.
Interface Temperature	: 400 °C
DL Temperature	: 200 °C
Block Heater Temperature	: 400 °C

Abstract

In this article, a method for the determination of nitrofuran metabolite residues in fish matrix was established using Shimadzu's Ultra-High Performance Liquid Chromatograph (UHPLC) LC-30A in conjunction with its Triple Quadrupole Mass Spectrometer LCMS-8045. After sample preparation, they were separated by UHPLC LC-30A in 3.0 minutes and then quantitatively analyzed using the Triple Quadrupole LCMS-8045. 3-amino-2-oxazolone (AOZ), 3-amino-5-morpholinomethyl-2-oxazolidinone (AMOZ), 1-amino-hydantoin (AHD), and semicarbazide (SEM) showed good linearity over the range of 0.05-20 ng/mL and their correlation coefficients were all greater than 0.9970. The precision experiments were performed with mixed standard solutions of concentrations 0.05 and 2.0 ng/mL. The results showed that the relative standard deviations for the retention times and peak areas obtained from 6 consecutive injections were 0.09 - 0.18% and 0.85 - 1.99% respectively, indicating good precision.

Nitrofurans are a class of synthetic antimicrobials drugs which inhibits the activity of acetyl-coenzyme A and interfere with the metabolism of sugar in microbes. Nitrofurans are very unstable and can easily be converted into metabolites. In the body of animals, nitrofuran drugs are rapidly decomposed into metabolites, which are subsequently bound to the membrane proteins. As the metabolites of nitrofurans are relatively stable and are associated with carcinogenic effects, the level of nitrofuran metabolites are often monitored in food safety tests. There are four common derivatives of nitrofuran metabolites, including: 3-amino-2-oxazolone (AOZ), 3-amino-5-morpholinomethyl-2-oxazolidinone (AMOZ), 1-amino-hydantoin (AHD) and semicarbazide (SEM).

In this article, a high-sensitivity detection method using Shimadzu UHPLC coupled with Triple Quadrupole LCMS-8045 is established for the assay of nitrofuran metabolite residues AOZ, AMOZ, AHD and SEM in fish matrix. This method was developed with reference to the standard method GB/T 21311-2007 and is aimed to serve as a reference method for regulatory testing.

EXPERIMENTAL

Instrumentation

This experiment was performed on a Shimadzu UHPLC LC-30A in conjunction with Triple Quadrupole Mass Spectrometer LCMS-8045. The specific configurations includes LC-30ADx2 solvent delivery pumps, DGU-20A_{SR} online degassing unit, SIL-30AC autosampler, CTO-30AC column oven, CBM-20A system controller, LCMS-8045 triple quadrupole mass spectrometer and LabSolutions Ver. 5.86 chromatography workstation.

Analytical Conditions

LC Chromatography (LC) Conditions

Column	: Shim-pack GISS C18 Column (2.1 mm I.D.x100 mm L., 1.9 μm)
Mobile phase	: Solvent A: 0.01% formic acid in water Solvent B: 0.01% formic acid in acetonitrile
Flow rate	: 0.50 mL/min
Column Temp.	: 40 °C
Injection volume	: 10 μL
Elution method	: Gradient elution with an initial ratio of 10% B

Table 1 General gradient elution program

Time (min)	Module	Command	Value (%)
1.50	Pumps	Pump B Conc.	80
1.51	Pumps	Pump B Conc.	10
3.00	Controller	Stop	

Mass Spectrometry (MS) Conditions

Analytical Instrument : LCMS-8045
 Ion Source : ESI+
 Nebulizer gas flowrate : 3.0 L/min
 Heating gas flow rate : 15.0 L/min
 Interface Temp. : 400 °C
 DL Temp. : 250 °C
 Heating block Temp. : 450 °C
 Needle offset distance : +3.0 mm
 Drying gas flow rate : 5.0 L/min
 Dwell Time : 22 ms
 Scan mode : Multiple Reaction Monitoring (MRM) with parameters shown in Table 2

SEM, were individually weighed and dissolved in a mixture of acetone/methanol (1:1) to prepare a single-standard stock solution at a concentration of 0.5 mg/mL. Subsequently, the stock solution was diluted with methanol to 100 ng/mL and further diluted with water to prepare a series of mixed standard working solutions at concentrations of 0.050, 0.10, 0.20, 0.50, 1.0 and 2.0 ng/mL.

Sample was prepared with reference to “GB/T 21311-2007: Determination of residues of nitrofuran metabolites in foodstuffs of animal origin HPLC-MS/MS method”.

Standards and Sample Preparation

Preparation of standard solutions: an appropriate amount of nitrofuran derivatives, i.e., AOZ, AMOZ, AHD and

RESULTS AND DISCUSSION

MRM Chromatogram of Standard Samples

The MRM chromatogram of standard sample is shown in Figure 1.

Table 2 Compound information and MRM parameters

Number	Analyte	CAS.	Precursor ion	Product ion	Q1 Pre Bias (V)	CE (V)	Q3 Pre Bias (V)
1	SEM	57-56-7	209.05	166.10 192.05	-14.0 -15.0	-9.0 -13.0	-17.0 -21.0
2	AOZ	80-65-9	236.10	134.00 104.10	-11.0 -17.0	-11.0 -22.0	-23.0 -11.0
3	AHD	2827-56-7	249.00	134.05 104.15	-26.0 -17.0	-12.0 -23.0	-25.0 -21.0
4	AMOZ	43056-63-9	335.15	291.10 262.10	-16.0 -24.0	-12.0 -18.0	-30.0 -30.0

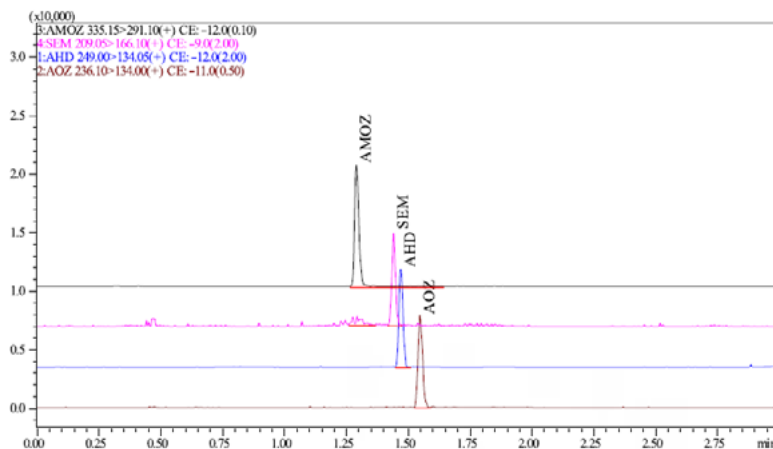

Figure 1 MRM chromatogram of 0.5 ng/mL standard sample

Calibration curve and linearity

The mixed standard working solutions at concentrations of 0.050, 0.10, 0.20, 0.50, 1.0, 2.0, 5.0, 10.0, and 20 ng/mL were prepared and determined according to the analytical conditions described previously. A calibration curve was created using the external standard method and shown in Figure 2. The linearity of the method was good in the range of 0.005-20 ng/mL. The linear equations, the corresponding linear range and correlation coefficient are shown in Table 3.

Limit of detection and limit of quantitation

For the injection and analysis of the mixed standard solution of concentration

0.05 ng/mL, the results for the limit of detection (S/N=3, LOD) and the limit of quantitation (S/N=10, LOQ) are shown in Table 4.

Precision experiment

The mixed standard solutions at two concentrations were consecutively injected for 6 times to test the precision. The repeatability results of retention time and peak area are shown in Table 5. The relative standard deviations of the retention time and peak area for standards at two concentrations were 0.09-0.18% and 0.85-1.99%, respectively, indicating good precision.

Table 3 Parameters of the calibration curve

Number	Analyte	Calibration curve	Linear range (ng/mL)	Accuracy (%)	Correlation coefficient (r)
1	SEM	$Y = (8892.23)X + (-316.210)$	0.050-20	93.2-111.6	0.9970
2	AOZ	$Y = (42020.9)X + (65.5028)$	0.050-20	94.0-108.4	0.9986
3	AHD	$Y = (10603.3)X + (-260.028)$	0.050-20	95.5-102.1	0.9996
4	AMTZ	$Y = (242918)X + (-322.397)$	0.050-20	94.5-103.8	0.9996

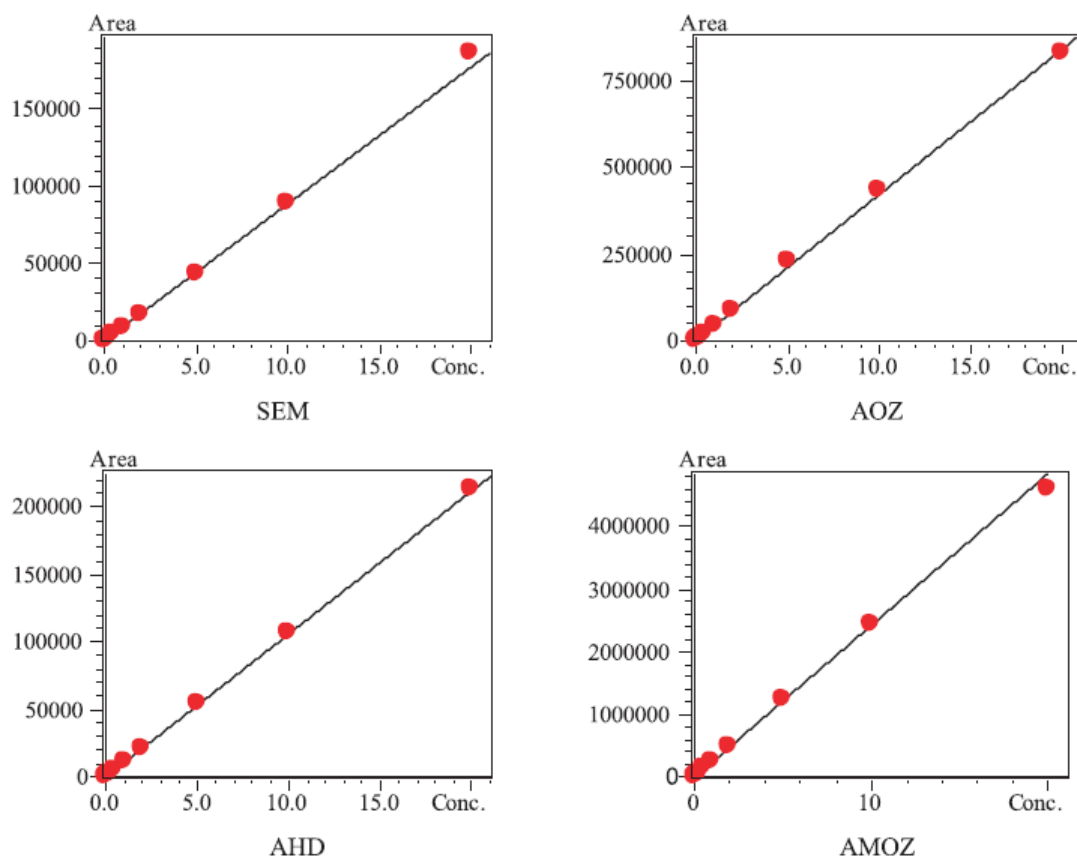

Figure 2 Standard calibration cure

Table 4 Limit of detection and limit of quantification

No.	Analyte	S/N ratio	Limit of detection (ng/mL)	Limit of quantification (ng/mL)	Correlation coefficient (r)
1	SEM	10	0.015	0.05	0.9970
2	AOZ	156	0.00096	0.0032	0.9986
3	AHD	150	0.0010	0.0033	0.9996
4	AMAZ	633	0.00024	0.00079	0.9996

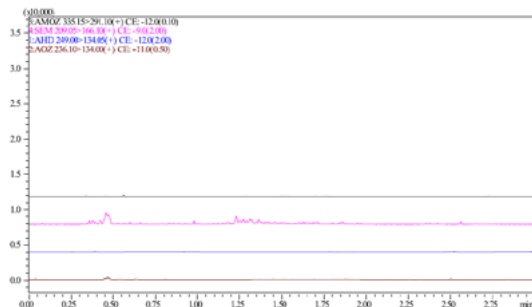

Figure 3 Chromatogram of blank matrix

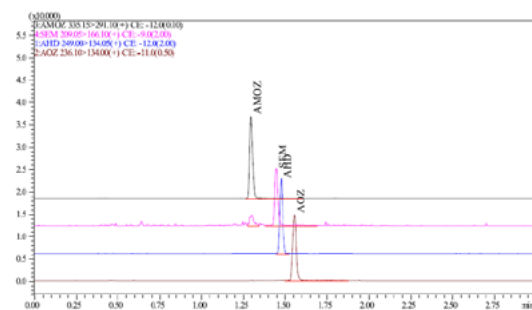

Figure 4 Chromatogram of matrix spike samples (1.0 ng/mL)

Table 5 Repeatability results of retention time and peak area (n=6)

Analyte	RSD% (0.5 ng/mL)		RSD% (2 ng/mL)	
	R.T.	Area	R.T.	Area
SEM	0.14	1.99	0.09	1.86
AOZ	0.13	1.94	0.12	1.65
AHD	0.18	1.97	0.14	1.61
AMAZ	0.18	1.97	0.09	0.85

Recovery tests

Blank fish sample was extracted according to the sample preparation method. The mixed standard solution was added with a spiked content of 1.0 µg/kg to give a final injection concentration of 1.0ng/mL. The chromatogram of blank matrix was shown in Figure 3 and the chromatogram of matrix spike samples was shown in Figure 4.

CONCLUSION

The nitrofuran metabolites in the fish matrix were determined using a Shimadzu UHPLC LC-30A in conjunction with a triple quadrupole LCMS-8045. In reference to “GB/T 21311-2007: Determination of residues of nitrofuran metabolites in foodstuffs of animal origin HPLC-MS/MS method”, the measurement of AOZ, AMAZ, AHD and SEM showed good linearity in the range of 0.05-20 ng/mL, and their correlation coefficients were all greater than 0.9970. This method is fast and simple, with high sensitivity and selectivity, which meets the current requirements for the determination of nitrofuran metabolite residues in foodstuffs of animal origin.

Determination of Sulfonamide Residues in Pork Using LCMS-8045

Liu Zhao
Shimadzu (China), Shanghai Analysis Center

Application News
SSL-CA14-359

Abstract

This application news demonstrates a method for determination of sulfonamide residues in pork using Shimadzu's ultra-high performance liquid chromatograph (UHPLC) LC-30A together with the triple quadrupole mass spectrometer LCMS-8045. The linearity of the 11 sulfonamides was excellent and their correlation coefficients were all greater than 0.999. The limit of detection was 0.002 to 0.026 $\mu\text{g/L}$, and its limit of quantitation was 0.006 to 0.080 $\mu\text{g/L}$. The matrix spike recovery rate was between 86.6 and 119.8%. As this method meets the requirements in terms of lower limit of detection of 0.5 $\mu\text{g/kg}$ as specified in the Department of Agriculture's announcement No. 1025-23-2008, it can be used to quickly and accurately determine sulfonamide residues in pork.

Sulfonamides (SAs) refer to synthetic antibiotics with sulfanilamide structures and it can be used to suppress most gram-positive bacteria and some gram-negative bacteria. When used in combination with antibacterial synergists, such as trimethoprim, SAs can enhance the antibacterial effect and expand the scope of treatment. Due to their advantages of having wide antibacterial spectra, strong curative effect and low cost, SAs are widely used in the prevention and treatment of diseases. However, one of its main drawbacks is that it can easily bring about side effects such as allergies and hematopoietic disorders, thereby causing a gradual reduction in clinical applications and usage. Instead, SAs are widely used in livestock breeding and aquaculture. Most of these drugs cannot be fully metabolized in animals and these SA residues can enter human body through the food chain, thus causing harm to human health. At present, the European Union, the United States, and Japan all list SAs as drugs with a restricted use in animal husbandry, with the maximum amount of SA residues generally limited to 50–100 $\mu\text{g/kg}$. China has also established relevant standards for detection of SA residues in animal-derived food, such as GB 29694-2013 "Determination of 13 Types of SA Residues in Animal-Derived Food Using High Performance Liquid Chromatography", GB 21316-2007 "Determination of SA Residues in Animal-Derived Food Using Liquid

Chromatography-Mass Spectrometry/Mass Spectrometry", and SN/T 4057-2014 "Determination of SA Residues in Animal-Derived Food for Export Using Immunoaffinity Column Chromatography-HPLC and LC-MS/MS Method".

In reference to the sample preparation method No. 1025-23-2008 listed by the Department of Agriculture "Detection of SA Residues in Animal-Derived Food Using Liquid Chromatography-Tandem Mass Spectrometry", this application news demonstrates the use of Shimadzu's Ultra-High Performance Liquid Chromatograph (UHPLC) LC-30A together with the triple quadrupole mass spectrometer LCMS-8045 to determine SA residues in pork.

EXPERIMENTAL Instrumentation

The experiment employed Shimadzu's UHPLC LC-30A and triple quadrupole mass spectrometer LCMS-8045. The configurations are two LC-30AD pumps, DGU-20A_{SR} online degassing unit, SIL-30AC autosampler, CTO-30AC column oven, CBM-20A system controller, LCMS-8045 triple quadrupole mass spectrometer and LabSolutions Ver. 5.86 chromatographic workstation.

Analytical Conditions

Liquid Chromatography (LC) Conditions

Column	: Shim-pack XR-ODS III (2.0 mm I.D.x50 mm L., 1.6 µm)
Mobile phase	: Mobile phase A-0.1% formic acid in water, Mobile phase B-methanol
Flow rate	: 0.3 mL/min
Column Temp.	: 40 °C
Injection volume	: 5 µL
Elution method	: Gradient elution program with the initial concentration of Mobile Phase B at 10%. Refer to Table 1 for detailed gradient elution program.

Table 1 Time program

Time (min)	Module	Command	Value (%)
0.20	Pumps	Pump B Conc.	10
1.00	Pumps	Pump B Conc.	30
2.00	Pumps	Pump B Conc.	30
4.00	Pumps	Pump B Conc.	90
5.00	Pumps	Pump B Conc.	90
5.01	Pumps	Pump B Conc.	10
8.00	Controller	Stop	

Mass Spectrometry (MS) Conditions

Ion sources	: ESI
Interface temperature	: 300 °C
DL temperature	: 250 °C
Mode	: Multiple reaction monitoring (MRM)
Nebulizing gas flow rate	: 3.0 L/min
Drying gas flow rate	: 10.0 L/min
Heated gas flow rate	: 10.0 L/min
MRM transition	: Refer to Table 2

Sample Preparation

There were 11 SA substances in total, including sulfathiazole, sulfapyridine, sulfamethiazole, sulfamethazine/ sulfadimidine, sulfameter/ sulfamethoxydiazine, sulfamethoxy pyridazine, sulfachloropyridazine, sulfamethoxazole, sulfisoxazole, sulfamethoxine, and sulfaquinolaxine were prepared.

Preparation of standard solutions: mixed standard stock solutions at a concentration of 10 mg/L were prepared using acetonitrile. The mixed standard stock solutions were subsequently diluted with a methanol/water solution (V/V, 10:90) to obtain mixed standard working solutions at concentrations of 0.1, 0.5, 1, 5, 10, and 50 µg/L.

Preparation of sample: samples were prepared and injected for analysis according to the sample extraction and clean-up method listed in the Department of Agriculture's No. 1025-23-2008 "Detection of SA Residues in Animal-Derived Food Using Liquid Chromatography-Tandem Mass Spectrometry".

RESULTS AND DISCUSSION

MRM Chromatograms of Standard Samples

MRM chromatograms of mixed standard samples are shown in Figure 1.

Calibration and Linearity

The mixed standard calibration solutions at concentrations of 0.1, 0.5, 1, 5, 10, and 50 µg/L were prepared and determined according to analytical conditions described previously. Linearity was good over the concentration range of 0.1-10 µg/L and 0.1-50 µg/L where the external standard method was used to generate the calibration curve. Linear equation, linear range, and coefficients of the determination are shown in Table 3.

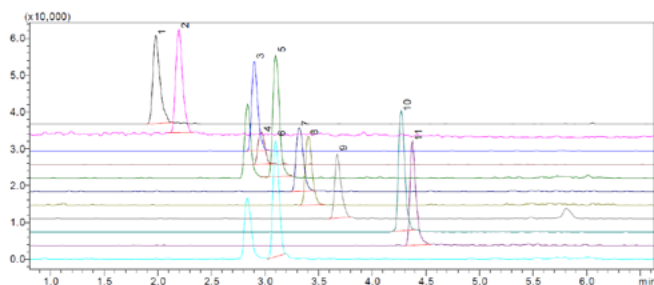

Figure 1 MRM chromatogram of mixed standard sample (0.5 µg/L)

(1. Sulfathiazole; 2. Sulfapyridine; 3. Sulfamethiazole; 4. Sulfamethazine/sulfadimidine; 5. Sulfameter/sulfamethoxydiazine; 6. Sulfamethoxyypyridazine; 7. Sulfachloropyridazine; 8. Sulfamethoxazole; 9. Sulfisoxazole; 10. Sulfamethoxine; 11. Sulfaquinoxaline)

Table 2 MRM transition

No.	Analyte	Precursor Ion	Product Ion	Q1 Pre Bias (V)	CE (V)	Q3 Pre Bias (V)
1	Sulfathiazole	256.10	156.05*	-28.0	-16.0	-29.0
			108.10	-18.0	-25.0	-21.0
2	Sulfapyridine	250.15	156.05*	-28.0	-17.0	-29.0
			184.00	-12.0	-17.0	-19.0
3	Sulfamethiazole	271.05	156.05*	-13.0	-14.0	-29.0
			108.10	-13.0	-27.0	-21.0
4	Sulfamethazine/sulfadimidine	279.20	186.10*	-14.0	-18.0	-19.0
			156.00	-30.0	-20.0	-28.0
5	Sulfameter/sulfamethoxydiazine	281.15	156.05*	-30.0	-18.0	-30.0
			108.15	-20.0	-28.0	-20.0
6	Sulfamethoxyypyridazine	281.15	156.10*	-30.0	-18.0	-30.0
			108.10	-20.0	-27.0	-20.0
7	Sulfachloropyridazine	285.05	156.10*	-14.0	-14.0	-29.0
			108.00	-14.0	-27.0	-21.0
8	Sulfamethoxazole	254.10	156.05*	-29.0	-16.0	-30.0
			108.10	-12.0	-24.0	-21.0
9	Sulfisoxazole	268.10	156.10*	-29.0	-14.0	-28.0
			113.15	-13.0	-15.0	-22.0
10	Sulfamethoxine	311.15	156.10*	-15.0	-23.0	-30.0
			108.05	-15.0	-30.0	-22.0
11	Sulfaquinoxaline	301.15	156.10*	-15.0	-17.0	-29.0
				-15.0	-27.0	-19.0

Note: * indicates quantification ion

Table 3 Parameters for calibration curve (linear regression, the weight coefficient was 1/C)

No.	Compound	Calibration Curve	Linear Range (ng/mL)	Accuracy (%)	Correlation Coefficient (r)
1	Sulfathiazole	Y = (208213) X + (3090.87)	0.1~50	81.9~106.9	0.9994
2	Sulfapyridine	Y = (244596) X + (-547.080)	0.1~10	91.9~104.1	0.9998
3	Sulfamethiazole	Y = (183474) X + (-83.6554)	0.1~10	95.6~104.9	0.9999
4	Sulfamethazine/sulfadimidine	Y = (163835) X + (1324.90)	0.1~10	89.2~108.3	0.9997
5	Sulfameter/sulfamethoxydiazine	Y = (250149) X + (5313.05)	0.1~10	88.5~108.1	0.9997
6	Sulfamethoxyypyridazine	Y = (242793) X + (4103.03)	0.1~10	95.2~103.3	0.9996
7	Sulfachloropyridazine	Y = (157837) X + (175.633)	0.1~10	95.0~104.5	0.9998
8	Sulfamethoxazole	Y = (154848) X + (4259.61)	0.1~50	82.0~109.0	0.9991
9	Sulfisoxazole	Y = (145057) X + (1448.37)	0.1~50	94.9~106.6	0.9999
10	Sulfamethoxine	Y = (245919) X + (11612.2)	0.1~50	97.3~103.3	0.9999
11	Sulfaquinoxaline	Y = (200233) X + (6393.09)	0.1~50	88.1~104.2	0.9997

Limit of Detection and Limit of Quantitation

Pork samples were treated according to the method specified in the previous section to obtain spiked samples at a concentration of 0.5 µg/L. After injection and analysis, the lower limit of detection (LOD, S/N=3) and the lower limit of quantitation (LOQ, S/N=10) for 11 SAs were calculated as shown in Table 4.

Precision Test

Mixed standard solutions at various concentrations were injected consecutively 6 times to determine precision. Repeatability results of retention time and peak area are shown in Table 5. The relative standard deviations of retention time and

peak area were within ranges of 0.02 to 0.13% and 0.66 to 5.15%, respectively, indicating good precision.

Matrix Spike Samples Test

Pork samples were treated according to the method specified in the previous section to obtain a blank matrix, which was then used to prepare spiked samples at a concentration of 0.5 µg/L for injection and analysis. The spike recovery rate of samples ranged from 86.6 to 119.8%. The chromatograms of the blank matrix are shown in Figure 2, while the chromatograms of the spiked samples are shown in Figure 3.

Table 4 Limit of detection and limit of quantification for 11 SAs

No.	Compound Name	Limit of Detection (µg/L)	Limit of Quantitation (µg/L)
1	Sulfathiazole	0.002	0.006
2	Sulfapyridine	0.010	0.032
3	Sulfamethiazole	0.002	0.006
4	Sulfamethazine/sulfadimidine	0.006	0.017
5	Sulfameter/ sulfamethoxydiazine	0.025	0.076
6	Sulfamethoxy pyridazine	0.026	0.080
7	Sulfachloropyridazine	0.003	0.011
8	Sulfamethoxazole	0.021	0.062
9	Sulfisoxazole	0.004	0.014
10	Sulfamethoxine	0.002	0.008
11	Sulfaquinoxaline	0.009	0.028

Table 5 Repeatability results of retention time and peak area (n=6)

No.	Compound Name	RSD% (1 µg/L)		RSD% (10 µg/L)	
		R.T.	Area	R.T.	Area
1	Sulfacetamide	0.13	2.62	0.07	0.92
2	Sulfathiazole	0.08	2.47	0.05	1.28
3	Sulfapyridine	0.13	2.39	0.05	1.00
4	Sulfamethiazole	0.03	1.86	0.04	0.83
5	Sulfamethazine/sulfadimidine	0.09	4.95	0.05	0.66
6	Sulfameter/sulfamethoxydiazine	0.05	1.33	0.03	1.56
7	Sulfamethoxy pyridazine	0.04	5.15	0.03	1.72
8	Sulfachloropyridazine	0.07	2.11	0.03	1.04
9	Sulfamethoxazole	0.03	3.44	0.04	0.91
10	Sulfisoxazole	0.03	2.46	0.03	1.31
11	Sulfamethoxine	0.01	1.29	0.03	1.41
12	Sulfaquinoxaline	0.06	1.91	0.02	1.26

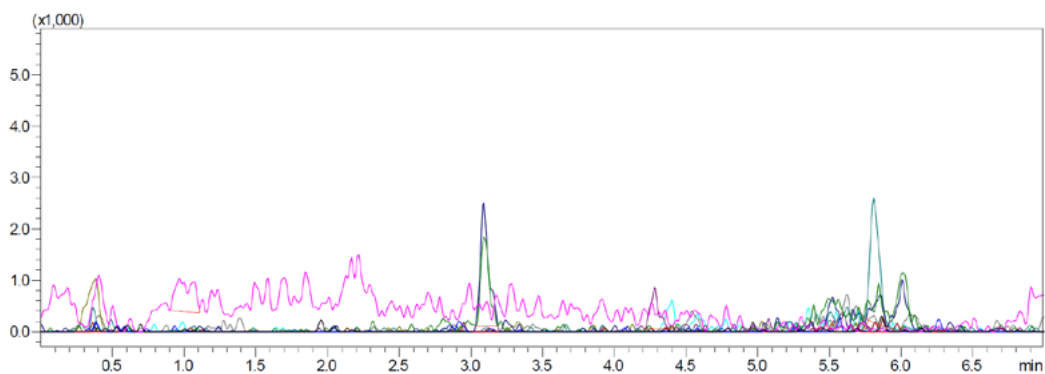

Figure 2 Chromatogram of blank matrix

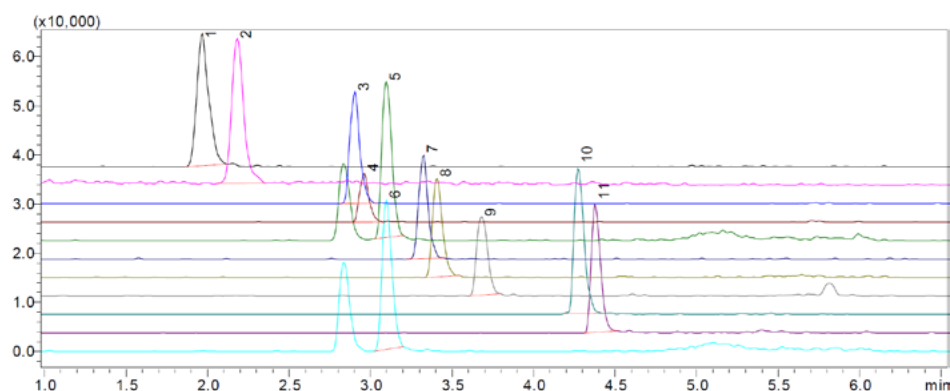

Figure 3 Chromatogram of spike recovery test

(1. Sulfathiazole; 2. Sulfapyridine; 3. Sulfamethiazole; 4. Sulfamethazine/sulfadimidine; 5. Sulfamer/sulfamethoxydiazine; 6. Sulfamethoxypyridazine; 7. Sulfachloropyridazine; 8. Sulfamethoxazole; 9. Sulfisoxazole; 10. Sulfamethoxine; 11. Sulfaquinoxaline)

Table 6 Results of spiked sample recovery

No.	Compound Name	Measured Concentration (µg/L)	Recovery (%)
1	Sulfathiazole	0.599	119.8
2	Sulfapyridine	0.553	110.6
3	Sulfamethiazole	0.509	101.8
4	Sulfamethazine/sulfadimidine	0.468	93.6
5	Sulfamer/sulfamethoxydiazine	0.494	98.8
6	Sulfamethoxypyridazine	0.508	101.6
7	Sulfachloropyridazine	0.479	95.8
8	Sulfamethoxazole	0.513	102.6
9	Sulfisoxazole	0.515	103.0
10	Sulfamethoxine	0.433	86.6
11	Sulfaquinoxaline	0.478	95.6

CONCLUSION

In the determination of SA residues in pork using Shimadzu's UHPLC LC-30A coupled with the triple quadrupole mass spectrometer LCMS-8045, the linearity of each of these 11 SAs was good, and their correlation coefficients were all greater than 0.999. The limit of detection was 0.002 to 0.026 µg/L, and its limit of quantification was 0.006 to 0.080 µg/L. The matrix spike recovery rate was between 86.6 and 119.8%. As this method meets the requirements of lower limit of detection of 0.5 µg/kg as specified in the Department of Agriculture's No. 1025-23-2008 "Detection of SA Residues in Animal-Derived Food Using Liquid Chromatography-Tandem Mass Spectrometry", it can be used to detect SA residues in pork.

Determination of Quinolone Antibiotic Residues in Chicken by Ultra-High Performance Liquid Chromatograph Coupled with Triple Quadrupole Mass Spectrometer

Haitao Meng
Shimadzu (China), Shanghai Analysis Center

Application News
SSL-CA14-397

Abstract

A method was developed for the determination of 12 quinolone antibiotics in chicken using Shimadzu's ultra-high performance liquid chromatograph LC-30A coupled with triple quadrupole mass spectrometer LCMS-8045. The analysis of 12 antibiotics was completed within 9 min and the correlation coefficients of the calibration curves were all above 0.997. The mixed standard solutions with various concentrations of antibiotics were tested in 6 replicates. The relative standard deviations of retention time and peak area of the 12 target compounds were 0.03 - 0.27% and 1.13 - 4.93%, respectively, and the precision was good. The range of matrix spike recovery was 91.90 - 108.60% at different concentrations. The method can be applied to the simultaneous detection of 12 quinolone antibiotic residues in chicken.

Quinolones (QNs) are synthetic drugs with broad-spectrum bactericidal effect. Due to their strong antibacterial activity and wide spectrum range, they are widely used in the prevention and treatment of various infectious diseases in human beings, poultry and livestock. However, drug overdose or improper use will lead to a high level of QNs residues in animals, especially for food-producing animals. In addition to the immediate and direct toxic effects of QNs on human body, the long-term consumption of animal-derived food containing QNs can readily induce drug resistance, thus affecting the clinical efficacy of QNs on human body. Therefore, the issue of QN residues has raised more and more concerns. The U.S., Japan, E.U. and China have regulated the maximum residue limit of QNs in food and it varies according to the different classification, properties and characteristics of QNs and is in the range of 10-6000 µg/kg.

Chicken is a meat widely consumed in China, so the determination of QNs residues in chicken is of great significance. High performance liquid chromatography-tandem mass spectrometry is a rapid developing analytical technology in recent years. With its ability to perform highly sensitive and selective quantitative and qualitative analyses as well as provide high accuracy for antibiotic compounds in complex matrices, it is the preferred

technique for ultra-trace residue analysis. A method was established in this application news for determination of 12 QNs antibiotics in chicken using a Shimadzu UHPLC LC-30A coupled with Triple Quadrupole Mass Spectrometer LCMS-8045.

EXPERIMENTAL

Instrumentation

The experiment employed Shimadzu's UHPLC LC-30A and triple quadrupole mass spectrometer LCMS-8045. The specific configurations are two LC-30AD pumps, DGU-20A5 online degassing unit, SIL-30AC autosampler, CTO-30A column oven, CBM-20A system controller, LCMS-8045 triple quadrupole mass spectrometer and LabSolutions Ver. 5.86 chromatographic workstation.

Analytical Conditions

Liquid Chromatography (LC) Conditions

Column	: Shim-pack GISS (2.1 mm I.D. x 100 mm L, 1.9 µm)
Mobile phase	: Phase A - 0.2% formic acid in water Phase B - acetonitrile/methanol (6:4)
Flow rate	: 0.40 mL/min
Column Temp.	: 40 °C
Injection volume	: 10 µL
Elution method	: Gradient elution with the initial concentration of Mobile Phase B at 10%. Refer to Table 1 for elution program.

Table 1 Time program

Time (min)	Module	Command	Value (%)
4.50	Pumps	Pump B Conc.	40
4.60	Pumps	Pump B Conc.	95
5.50	Pumps	Pump B Conc.	95
5.60	Pumps	Pump B Conc.	10
9.00	Controller	Stop	

Mass Spectrometry (MS) Conditions

Mass Spectrometer	: LCMS-8045
Ion sources	: ESI (+)
Heating gas	: Air 10.0 L/min
Nebulizing gas	: Nitrogen 3.0 L/min
Drying gas	: Nitrogen 10.0 L/min
Collision gas	: Argon
Interface temp.	: 300 °C
DL temp.	: 250 °C
Heater temp.	: 400 °C
Mode	: Multiple reaction monitoring (MRM)
Dwell time	: 15 ms
Delay time	: 3 ms
MRM parameters	: Refer to Table 2

Table 2 MRM optimized parameters

No.	Analyte	CAS No.	Precursor Ion	Product Ion	Q1 Pre Bias (V)	CE (V)	Q3 Pre Bias (V)
1	Pipemidic Acid	51940-44-4	304.1	286.1*	-16	-21	-20
				215.1	-30	-38	-24
2	Enoxacin	84294-96-2	321.1	303.1*	-13	-22	-11
				232.1	-13	-35	-16
3	Ofloxacin	82419-36-1	362.1	318.2*	-12	-21	-22
				261.1	-12	-29	-18
4	Norfloxacin	70458-96-7	320.0	302.1*	-11	-22	-21
				231.1	-11	-39	-24
5	Pefloxacin	149676-40-4	334.1	316.1*	-28	-23	-22
				290.1	-13	-18	-14
6	Ciprofloxacin	93107-08-5	332.0	314.1*	-11	-16	-24
				231.0	-11	-37	-25
7	Lomefloxacin	98079-52-8	352.1	265.1*	-16	-25	28
				308.1	-16	-17	-21
8	Danofloxacin	119478-55-6	358.1	340.1*	-14	-24	-12
				255.1	-14	-40	-17
9	Enrofloxacin	93106-60-6	360.1	316.2*	-12	-20	-11
				342.1	-12	-20	-11
10	Cinoxacin	28657-80-9	263.0	245.0*	-28	-15	-26
				217.0	-28	-23	-22
11	Oxolinic Acid	14698-29-4	262.1	244.0*	-17	-18	-26
				216.1	-30	-28	-23
12	Flumequine	42835-25-6	262.1	244.1*	-16	-16	-17
				202.0	-16	-36	-22

Note: * indicates quantification ion

Standard Solution Preparation

Quinolone standards were weighed and dissolved in methanol to prepare mixed standard stock solutions of 1.0mg/ml. The mixed standard solutions were stored at -18 °C. Accurate volumes of mixed standard stock solution were added to blank chicken extract solutions to prepare mixed standard working solutions with concentrations of 0.2, 0.5, 1, 5, 10, 20 and 50 ng/mL.

Sample Preparation Method

Chicken samples were prepared with reference to the national standard GB/T 21312-2007 "Analysis of 14 Quinolone in Food of Animal Origin by High Performance Liquid Chromatography Tandem Mass Spectrometry".

5.0g (accurate to 0.1g) of homogeneous chicken sample was weighed in a 50mL polypropylene centrifuge tube. 20mL of 0.1m/L EDTA-McIlvaine buffer solution was added. The mixture was vortexed, ultrasonically extracted for 10 mins and centrifuged at 10,000 rpm

for 5 mins. The extraction was repeated 3 times in total and the supernatant was combined.

SPE clean-up was performed using HLB SPE cartridges (200mg, 6mL). The SPE was first activated with 6mL of methanol and 6mL of water before use. 6mL of extracted supernatant was added to the SPE column and rinse with 2mL of 5% methanol solution. The filtrate was discarded and the SPE column drained. Elution of SPE was carried out with 6mL of methanol. The eluate was collected and completely dried with nitrogen. The dried extract was reconstituted with 1ml of mobile phase and vortexed. The reconstituted extracts were filtered through a 0.22µm filter membrane and injected into LC-MS/MS for analysis.

RESULTS AND DISCUSSION

MS Scan and Product Ion Scan of Standard Samples

The Q1 MS scan and product ion scan of the quinolone drugs are shown in Figures 1-12.

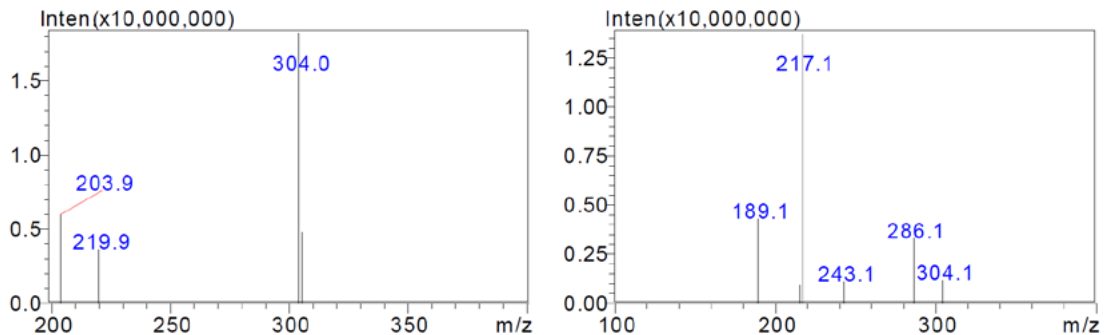

Figure 1 Q1 MS Scan (left) and product ion scan (CE value-20 V, right) of piperidic acid

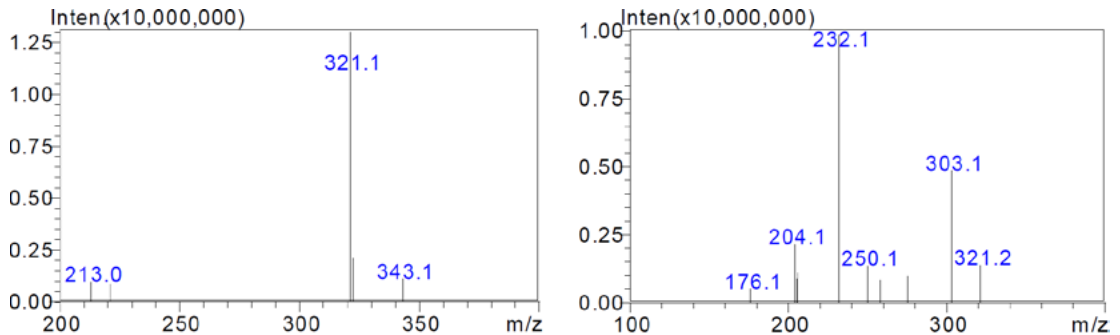

Figure 2 Q1 MS Scan (left) and product ion scan (CE value-30 V, right) of enoxacin

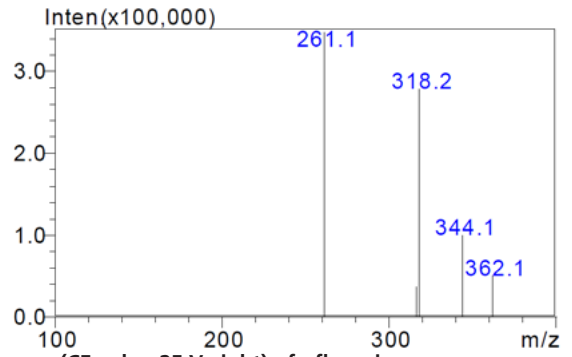
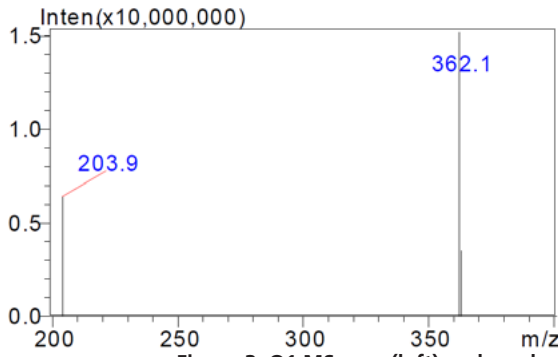

Figure 3 Q1 MS scan (left) and product ion scan (CE value-25 V, right) of ofloxacin

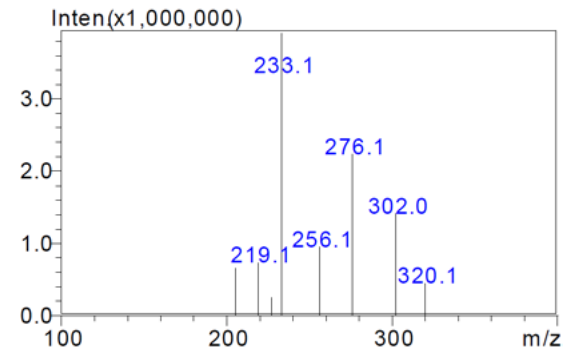
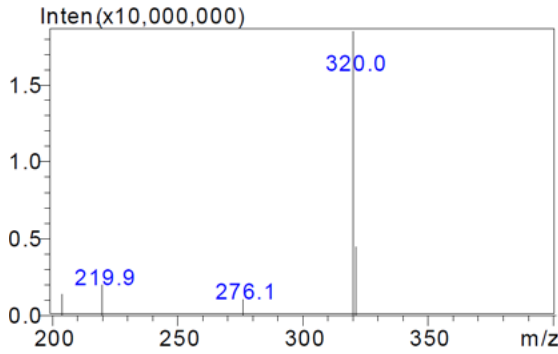

Figure 4 Q1 MS scan (left) and product ion scan (CE value-25 V, right) of norfloxacin

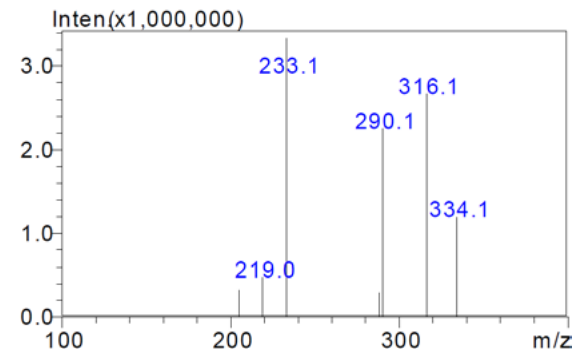
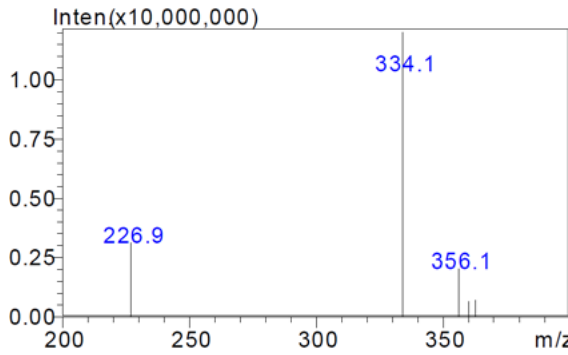

Figure 5 Q1 MS scan (left) and product ion scan (CE value-25 V, right) of pefloxacin

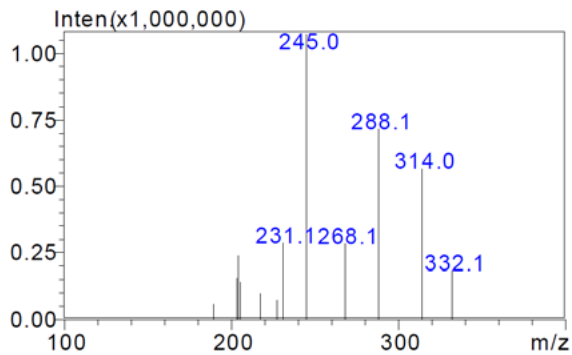
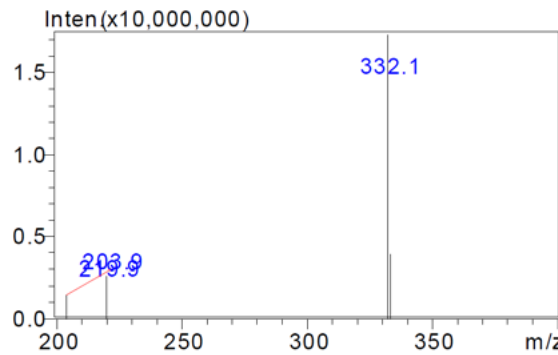

Figure 6 Q1 MS scan (left) and product ion scan (CE value-25 V, right) of ciprofloxacin

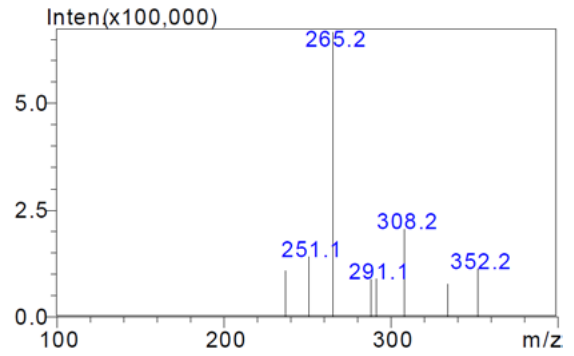
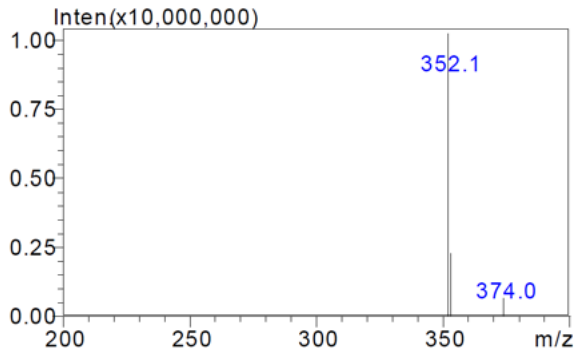

Figure 7 Q1 MS scan (left) and product ion scan (CE value-25 V, right) of lomefloxacin

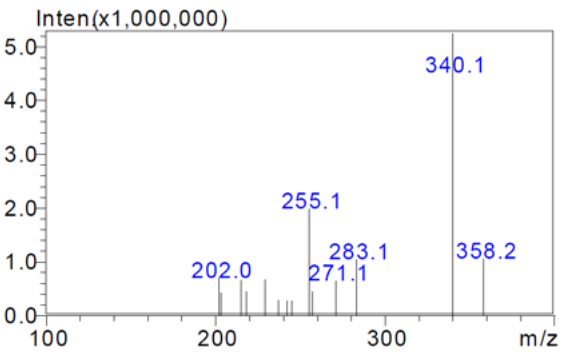
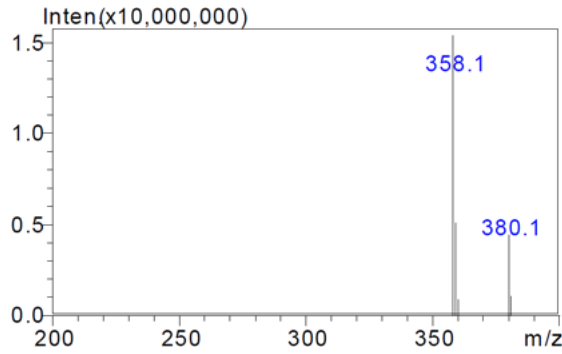

Figure 8 Q1 MS scan (left) and product ion scan (CE value-25 V, right) of danofloxacin

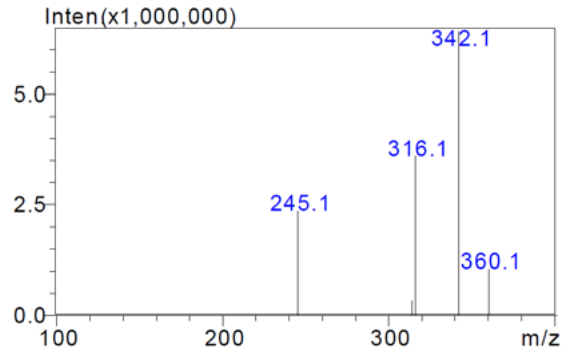
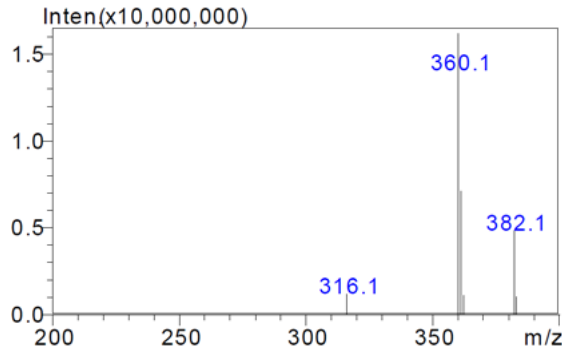

Figure 9 Q1 MS scan (left) and product ion scan (CE value-25 V, right) of enrofloxacin

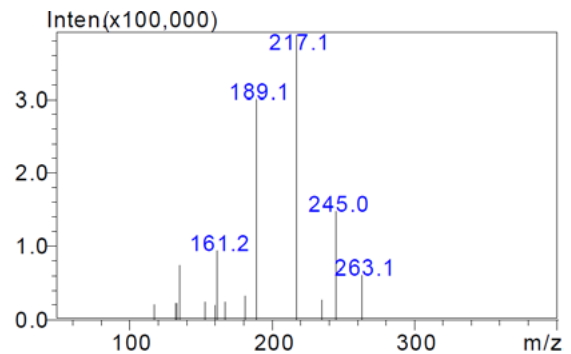
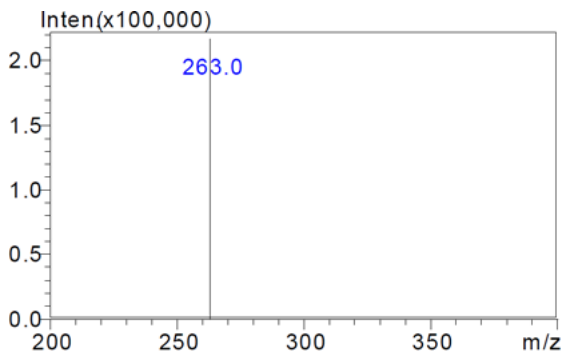

Figure 10 Q1 MS scan (left) and product ion scan (CE value-30 V, right) of cinoxacin

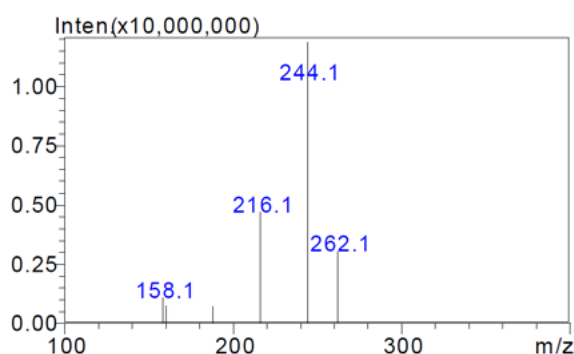
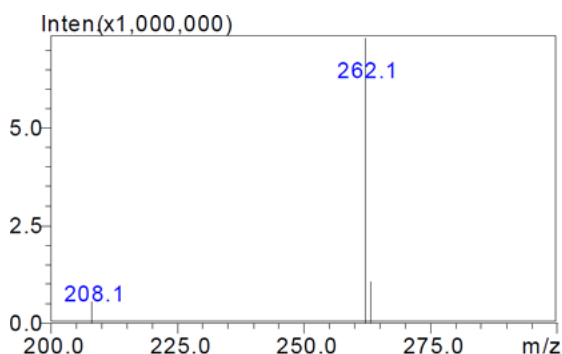

Figure 11 Q1 MS scan (left) and product ion scan (CE value=25 V, right) of oxolinic acid

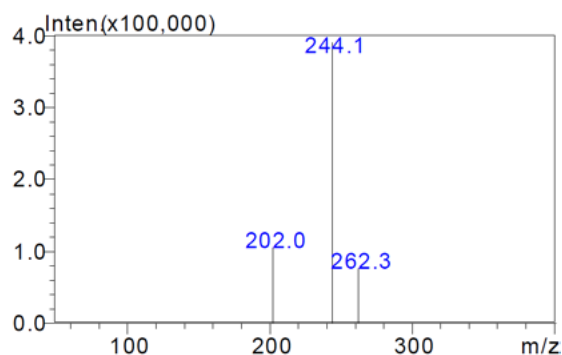
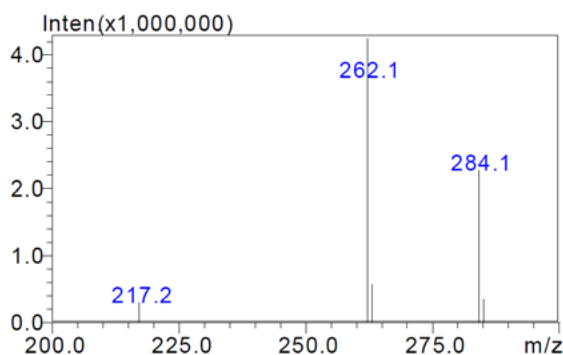

Figure 12 Q1 MS scan (left) and product ion scan (CE value=35 V, right) of flumequine

MRM chromatograms of 12 quinolone standard solutions (1 ng/mL)

The MRM chromatograms of the quinolone drugs are shown in Figure 13.

Calibration and linearity

About 60mL of combined liquid extract was collected after the extraction of 5.0g chicken sample with EDTA-McIlvaine buffer solution. The combined liquid extract went through similar SPE clean-up as described previously and was reconstituted to give 10mL of blank chicken extraction solution. The mixed standard calibration solutions of concentrations 0.2, 0.5, 1, 5, 10, 20 and 50 ng/mL were prepared by diluting appropriate amounts of the standard stock solution (1mg/mL) with the blank chicken extract solution. A calibration curve was plotted showing concentration of working solution against peak area (see Figure 13). The linearity was good and the linear equation and correlation coefficient are shown in Table 3.

Precision test

The retention times and peak areas of the mixed standard working solutions at different concentrations (6 replicates for each concentration) were determined to evaluate the precision. The repeatability results of retention time and peak area are shown in Table 4. The results indicate that the relative standard deviations of retention time and peak area of standard samples at different concentrations are 0.03 - 0.27 % and 1.13 - 4.93% respectively, showing good precision.

Sensitivity test

To determine the sensitivity, a low concentration (0.2ng/mL) mixed standard antibiotics solution was prepared and analyzed. The signal-to-noise (S/N) ratio, limit of detection (LOD) and limit of quantitation (LOQ) was determined with the use of RMS calculation method and LabSolutions Ver. 5.86. The S/N ratio, LOD and LOQ of the 12 compounds are shown in Table 5.

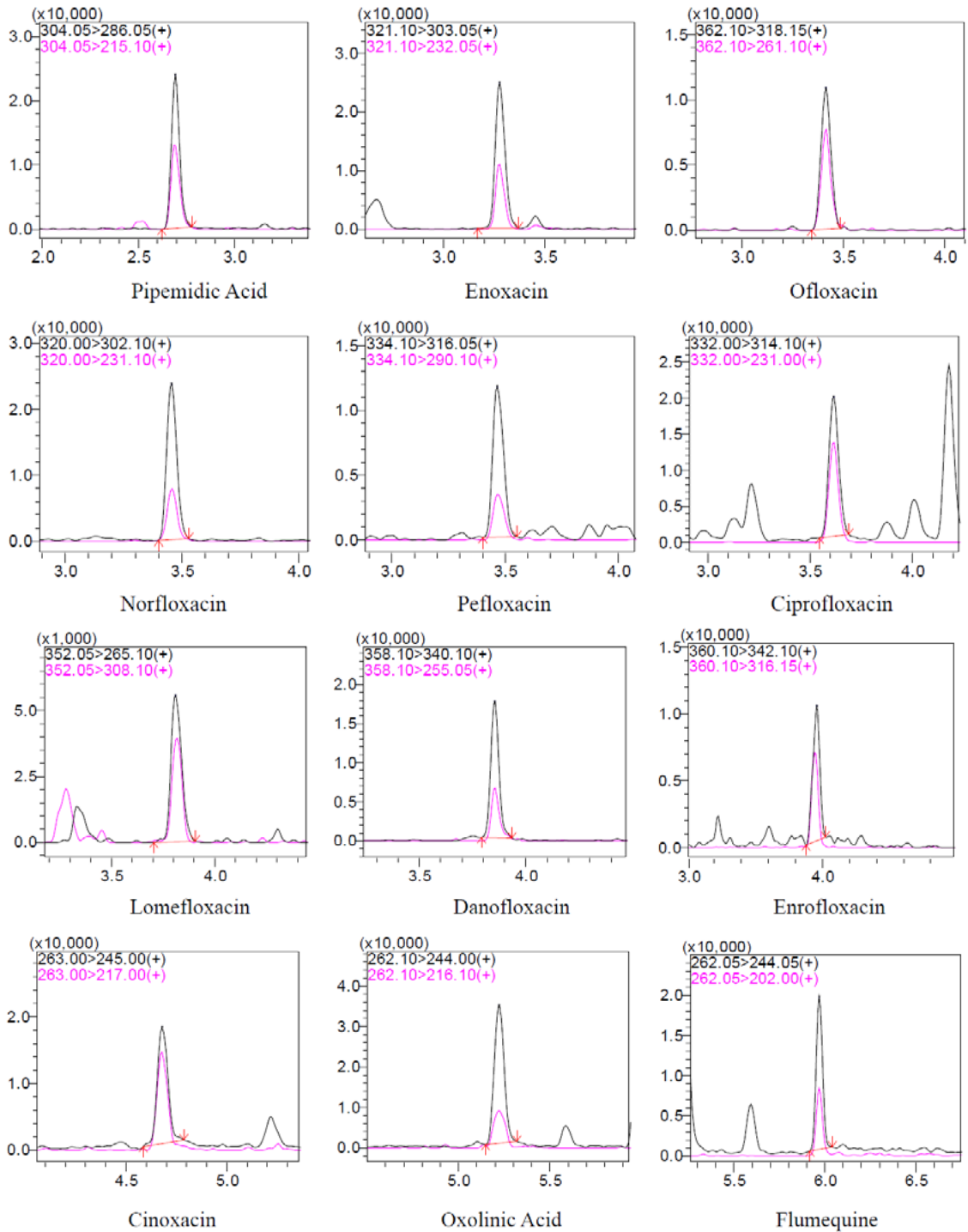

Figure 13 Standard curves of 12 quinolones

Table 3 Calibration curve

Analyte	Calibration Curve	Linear Range (ng/mL)	Correlation Coefficient (r)	Accuracy (%)
1 Pipemidic Acid	$Y = (76616.3) X + (-2517.68)$	0.2-50	0.9998	96.1-104.1
2 Enoxacin	$Y = (75235.4) X + (832.686)$	0.2-50	0.9996	87.9-109.4
3 Ofloxacin	$Y = (30271.5) X + (-849.705)$	0.2-50	0.9998	90.9-106.6
4 Norfloxacin	$Y = (64434.1) X + (1680.13)$	0.2-50	0.9988	85.7-112.4
5 Pefloxacin	$Y = (30801.7) X + (579.667)$	0.2-50	0.9990	89.5-109.8
6 Ciprofloxacin	$Y = (58040.6) X + (4785.98)$	0.2-50	0.9990	90.7-114.2
7 Lomefloxacin	$Y = (19629.0) X + (-749.499)$	0.2-50	0.9997	89.8-107.5
8 Danofloxacin	$Y = (44434.3) X + (911.073)$	0.2-50	0.9995	91.1-110.6
9 Enrofloxacin	$Y = (23178.6) X + (76.5354)$	0.2-50	0.9975	87.2-111.3
10 Cinoxacin	$Y = (69528.6) X + (284.320)$	0.2-50	0.9995	92.1-111.6
11 Oxolinic acid	$Y = (124807) X + (4369.16)$	0.2-50	0.9999	87.5-113.0
12 Flumequine	$Y = (18436.0) X + (814.851)$	0.2-50	0.9987	91.2-108.2

Table 4 Repeatability results of retention time and peak area (n=6)

Compound Name	RSD% (0.2 ng/mL)		RSD% (10 ng/mL)		RSD% (50 ng/mL)	
	R.T.	Area	R.T.	Area	R.T.	Area
Pipemidic Acid	0.23	4.93	0.21	2.54	0.24	1.85
Enoxacin	0.16	3.73	0.18	1.21	0.19	1.79
Ofloxacin	0.27	4.93	0.17	1.59	0.18	1.66
Norfloxacin	0.17	4.91	0.16	1.92	0.19	1.13
Pefloxacin	0.16	4.77	0.17	2.06	0.19	2.01
Ciprofloxacin	0.07	3.88	0.15	1.34	0.18	2.29
Lomefloxacin	0.15	3.37	0.15	1.70	0.18	1.45
Danofloxacin	0.17	3.23	0.15	2.61	0.16	3.74
Enrofloxacin	0.23	4.88	0.13	3.16	0.15	1.81
Cinoxacin	0.10	3.32	0.11	1.40	0.10	1.34
Oxolinic acid	0.09	2.15	0.09	1.69	0.07	1.44
Flumequine	0.04	3.43	0.03	3.37	0.03	2.00

Table 5 Signal-to-noise ratio (S/N), LOD and LOQ

Compound	Concentration Level (ng/mL)	S/N	Limit of Detection (ng/L)	Limit of Quantitation (ng/L)
Pipemidic Acid	0.20	15.43	0.04	0.13
Enoxacin	0.20	31.11	0.02	0.07
Ofloxacin	0.20	21.89	0.03	0.10
Norfloxacin	0.20	39.04	0.02	0.06
Pefloxacin	0.20	19.21	0.04	0.12
Ciprofloxacin	0.20	56.02	0.01	0.04
Lomefloxacin	0.20	39.68	0.02	0.06
Danofloxacin	0.20	29.48	0.02	0.07
Enrofloxacin	0.20	13.34	0.05	0.16
Cinoxacin	0.20	29.57	0.07	0.21
Oxolinic acid	0.20	44.84	0.02	0.05
Flumequine	0.20	18.66	0.03	0.09

Matrix spike test

A matrix spike using the blank chicken sample was prepared accordingly to give spiked sample at concentrations of 0.5 ng/mL, 10 ng/mL and 40 ng/mL. 3 replicates were tested and the average results are shown in Table 6. The test results indicate that the spike recovery of the 12 samples of antibiotics were 91.90–108.60%.

CONCLUSION

A method was established for the determination of quinolone antibiotics in chicken using Shimadzu UHPLC LC-30A coupled with triple quadrupole mass spectrometer LCMS-8045. This method analyzed 12 antibiotics within 9 min, and the correlation coefficients of the

calibration curve are all above 0.997. The mixed standard antibiotics solutions at concentrations of 0.2 ng/mL, 10 ng/mL and 50 ng/mL were tested in 6 replicates. The relative standard deviations of retention time and peak area of the 12 target compounds are 0.03-0.27 % and 1.13-4.93% respectively, showing good precision. The chicken sample matrix at spiked concentrations of 0.5 ng/mL, 10 ng/mL and 40 ng/mL were tested in 3 replicates, and the spike recovery was 91.90-108.60%. The described method is fast and ensures high sensitivity and excellent reproducibility. It can be used for the determination of various antibiotic residues in chicken.

Table 6 Results of spike-recovery test

No.	Compound Name	Spiked Sample Concentration (0.5 ng/mL)		Spiked Sample Concentration (10 ng/mL)		Spiked Sample Concentration (40 ng/mL)	
		Average (ng/mL)	Recovery (%)	Average (ng/mL)	Recovery (%)	Average (ng/mL)	Recovery (%)
1	Pipemidic Acid	0.54	108.60	10.22	102.20	39.02	97.55
2	Enoxacin	0.50	100.23	9.72	97.23	37.34	93.38
3	Ofloxacin	0.51	101.93	9.59	95.90	38.84	97.08
4	Norfloxacin	0.48	96.35	9.82	98.20	37.16	92.90
5	Pefloxacin	0.47	94.08	10.01	100.08	37.37	93.43
6	Ciprofloxacin	0.47	94.23	9.90	99.03	37.12	92.83
7	Lomefloxacin	0.46	93.70	9.33	93.40	38.51	96.30
8	Danofloxacin	0.47	93.05	9.72	97.20	36.77	91.90
9	Enrofloxacin	0.48	95.85	9.86	98.63	39.70	99.25
10	Cinoxacin	0.48	95.78	9.82	98.25	37.71	94.28
11	Oxolinic acid	0.50	100.65	10.24	102.45	39.36	98.43
12	Flumequine	0.50	100.50	10.05	100.60	39.40	98.50

Highly sensitive and rapid analysis of synthetic dyes in sea food by LC/MS/MS

ASMS 2017 MP 189

Shailendra Rane¹, Ashutosh Shelar¹, Shailesh Damale¹,
Rashi Kochhar¹, Purshottam Sutar¹, Deepti Bhandarkar¹,
Anant Lohar¹, Ajit Datar¹, Pratap Rasam¹, Jitendra Kelkar¹
and Devika Tupe²

¹ Shimadzu Analytical (India) Pvt. Ltd., 1 A/B Rushabh
Chambers, Makwana Road, Marol, Andheri (E),
Mumbai-400059, Maharashtra, India.

² Institute of Bioinformatics and Biotechnology,
Savitribai Phule Pune University, Ganesh khind Road,
Pune-411007, Maharashtra, India.

Highly sensitive and rapid analysis of synthetic dyes in sea food by LC/MS/MS

Introduction

Synthetic dyes like malachite green, crystal violet are used for wide range of industrial applications. However, they are also used in aquaculture due to their anti-bacterial and anti-fungal properties. They are cheap, very effective and readily available, but due to their toxic effects to humans, these dyes are banned in the EU and US regions with zero tolerance policy. ^{[1][2]}

Here, LC/MS/MS method has been developed for quantitation of malachite green, leucomalachite green, crystal violet and leucocrystal violet from sea food sample using LCMS-8045, a triple quadrupole mass spectrometer from Shimadzu Corporation, Japan.

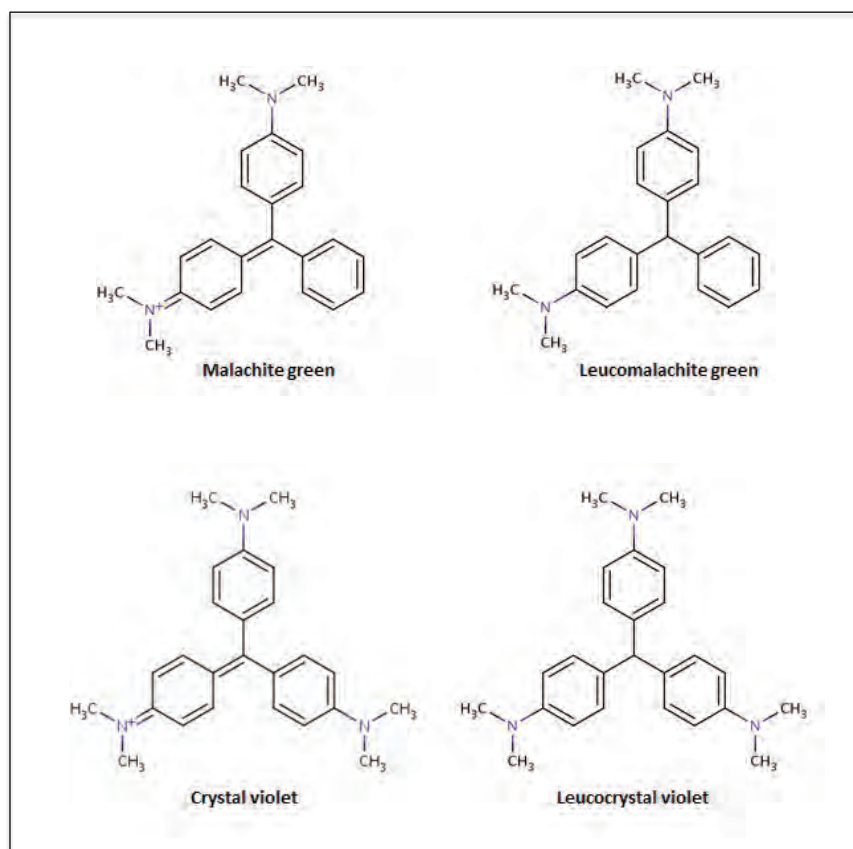

Figure 1. Structure of synthetic dyes

Highly sensitive and rapid analysis of synthetic dyes in sea food by LC/MS/MS

Methods and materials

Sample preparation

Synthetic dye (Figure 1) standards procured from Sigma-Aldrich were used for the analysis. All individual standard stocks were prepared in the acetonitrile. Further mixture of all dyes were prepared in acetonitrile. This stock was serially diluted to prepare calibration levels ranging from 0.05 ppb to 10 ppb in acetonitrile for solvent standard and in matrix for matrix matched standard calibration.

Analysis of these dyes is difficult due to their instability. These synthetic dyes readily undergo oxidation-reduction reaction hence to stabilize them ascorbic acid as an anti-oxidant was added prior to the sample extraction. [3] For sample analysis, commercially available shrimp sample

was purchased and used for analysis. Sample was crushed and transferred to 15 mL centrifuge tube to which 10 mL of acidified acetonitrile and 1 mL of 1M solution of ascorbic acid was added. It was kept on mechanical shaker for 15 min for proper extraction of dyes. Sample were centrifuged for 10 min at 3000 rpm at 4 °C. Then the supernatant layer was transferred to 50 mL tube containing 20 mL McIlvaine's buffer. Phenomenex Strata SCX SPE cartridges were used for sample clean up. Methanol containing 1% triethylamine and 0.5% formic acid was used as an elution solvent for SPE. After clean up, sample were injected on LCMS-8045.



Figure 2. Nexera with LCMS-8045

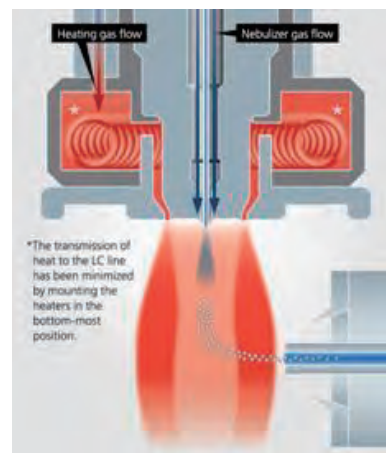

Figure 3. Heated ESI probe

LCMS-8045 triple quadrupole mass spectrometer by Shimadzu (shown in Figure 2), sets a new benchmark in triple quadrupole technology with an unsurpassed sensitivity (UFsensitivity), ultra fast scanning speed of 30,000 u/sec (UFscanning) and polarity switching speed of 5 msec (UFswitching). This system ensures highest quality of data, with very high degree of reliability.

In order to improve ionization efficiency, the newly developed heated ESI probe (shown in Figure 3) combines high-temperature gas with the nebulizer spray, assisting in the desolvation of large droplets and enhancing ionization. This development allows high-sensitivity analysis of a wide range of target compounds with considerable reduction in background.

Highly sensitive and rapid analysis of synthetic dyes in sea food by LC/MS/MS

LC/MS/MS analysis

Malachite green, leucomalachite green, crystal violet and leucocrystal violet were simultaneously analyzed using Ultra High Performance Liquid Chromatography (UHPLC) Nexera coupled with LCMS-8045 triple quadrupole system (Shimadzu Corporation, Japan). The details of analytical conditions are given in Table 1.

Table 1. Optimized LC/MS/MS conditions for dyes analysis

Column	: Shim-pack GISS (75mm L X 3.0mm I.D, 3 μm)
Mobile phase A	: 2 mM ammonium formate + 0.002 % formic acid in water.
	: B: 2 mM ammonium formate + 0.002 % formic acid in methanol
Flow rate	: 0.4 mL/min
Gradient program (B %)	: 0-0.5 min → 30 (%); 0.5-3 min → 30-95 (%); 3-4 min → 95 (%); 4-4.2 min → 30 (%); 4.2-6.5 min → 30 (%)
Injection volume	: 10 μL
Column temperature	: 40 °C
MS interface	: Electro Spray Ionization (ESI)
Nitrogen gas flow	: Nebulizing gas 3 L/min; Drying gas 10 L/min.
Zero air flow	: Heating gas 10 L/min.
MS temperature	: Desolvation line 150 °C; Heating block 400 °C; Interface 300 °C

Table 2. MRM transition of synthetic dyes

Sr.No.	Name of compound	Precursor m/z	Product 1 m/z	Product 2 m/z
1	Malachite green	329.25	313.15	208.10
2	Leucomalachite green	331.20	239.10	316.20
3	Crystal violet	372.35	356.20	340.15
4	Leucocrystal violet	374.30	358.25	239.15

Results

The LC/MS/MS method was developed for trace level quantitation of malachite green, leucomalachite green, crystal violet and leucocrystal violet in marine product. All MRM transitions were optimized with the help of auto optimization feature of LabSolutions.

Analysis was performed using aqueous as well as matrix matched standards. The MRM transition used for these analysis are given in Table 2. Linearity solutions were prepared from 0.05 to 0.5 ppb and acquired using external calibration method and result of linearity are tabulated in

Table 3. Overlay of 0.05 ppb standards are shown in Figure 4. Matrix matched calibration levels were prepared and injected in the same concentration range. A control shrimp sample was extracted as per the same procedure. The Figure 5 shows overlay of chromatograms of blank, control sample and 0.05 ppb matrix matched standard clearly indicates that there no matrix interference. The calibration curve of for all four dyes are shown in Figure 6 and the correlation coefficient >0.99 was obtained for all compounds.

Highly sensitive and rapid analysis of synthetic dyes in sea food by LC/MS/MS

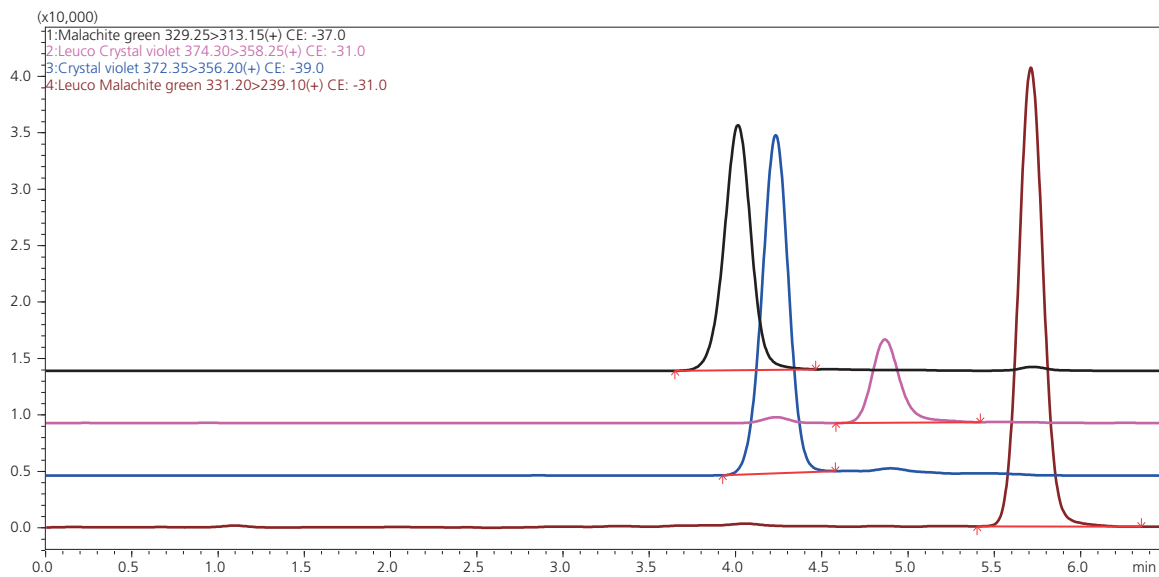

Figure 4. Chromatogram of solvent standard of 0.05 ppb

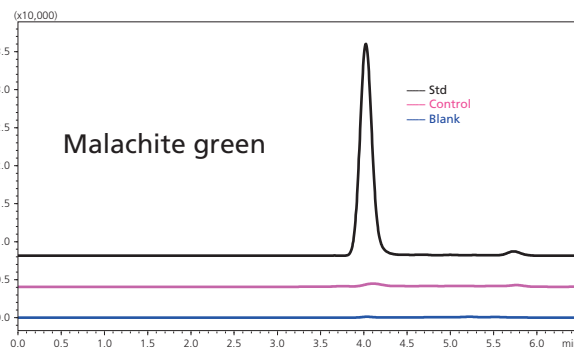
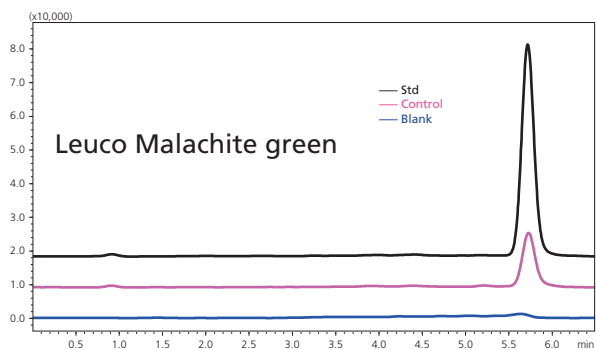
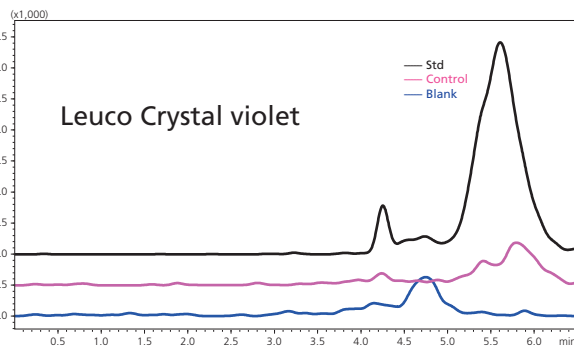
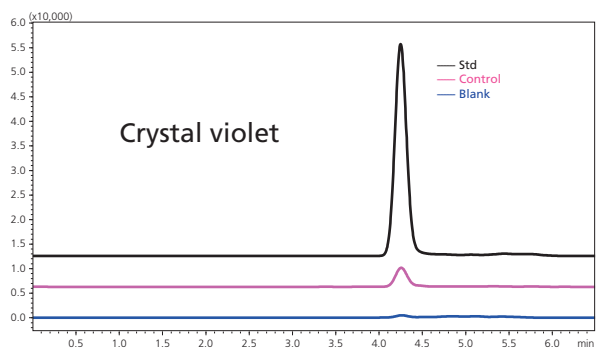

Figure 5. Overlay of chromatograms of blank, control and 0.05 ppb matrix standard

Highly sensitive and rapid analysis of synthetic dyes in sea food by LC/MS/MS

In earlier study it was observed that leuco malachite green and leuco crystal violet metabolite were not stable for long period of time in water or methanol even at -20 °C and oxidizes into non leuco form, hence aprotic solvent is used to prepare standards and at the same time ascorbic

acid was used as an antioxidant. SPE cartridge was used for extraction has strong cation exchange sorbent, since most of the dyes carry positive charge and due to this their retention was better which helps in reduction of matrix interference.

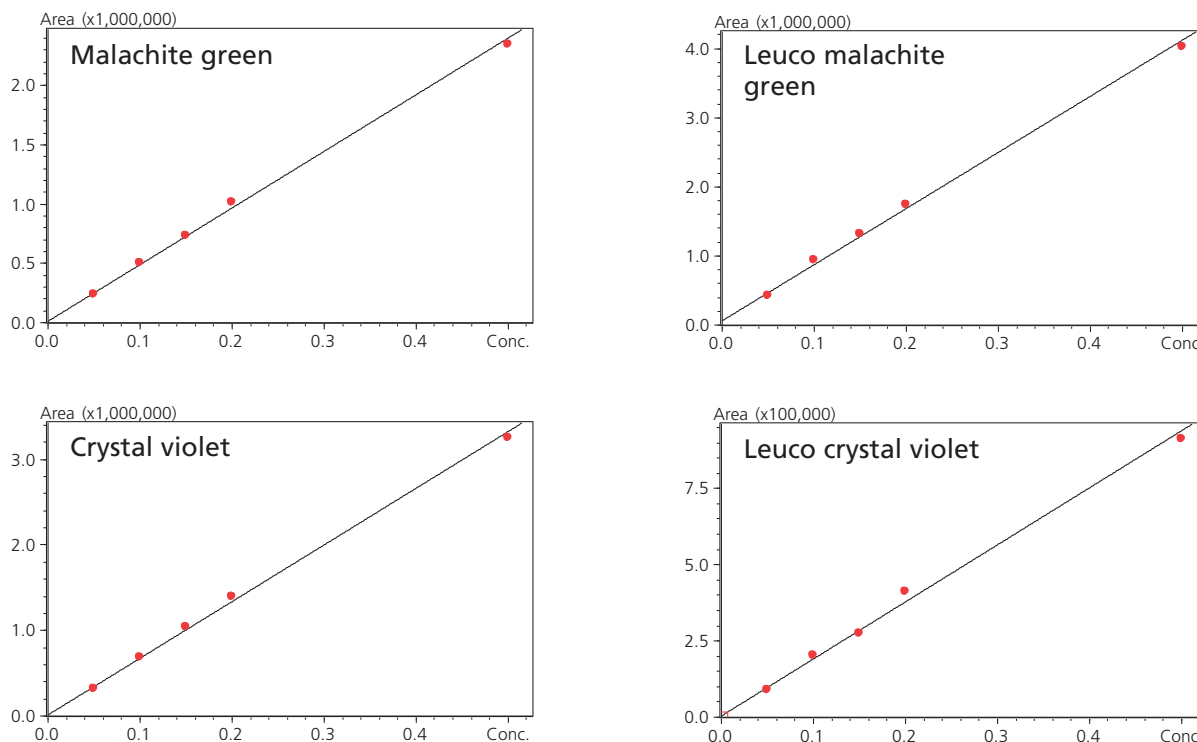

Figure 6. Calibration curves of dyes

Table 3. Linearity and recovery of dyes

Sr.No.	Name of compound	Linearity range (ppb)	Correlation coefficient (r^2)	% Recovery at 0.05 ppb
1	Malachite green	0.05-0.5	0.9974	80.21
2	Leucomalachite green	0.05-0.5	0.9960	112.00
3	Crystal violet	0.05-0.5	0.9977	95.00
4	Leucocrystal violet	0.05-0.5	0.9930	81.00

Highly sensitive and rapid analysis of synthetic dyes in sea food by LC/MS/MS

Conclusion

- A highly sensitive and rapid method for analysis of crystal violet, leuco crystal violet, malachite green and leuco malachite green was developed.
- Simple SPE method for the determination of malachite green, crystal violet and other synthetic dyes in seafood coupled with LC/MS/MS detection.
- Less matrix interference and sensitive LC/MS/MS instrument enabled lower detection limits and better recovery.

Reference

- [1] A A Bergwerff, P Scherpenisse. J Chromatogr B: Anal Technol Biomed Life Sci. 788: 351-359
[2] Lopez-Gutierrez et al. Anal Methods. 5: 3434–3449, 2013.
[3] J C Hashimoto et al. J AOAC Int. 95: 913–922, 2012.

Disclaimer: The products and applications in this presentation are intended for Research Use Only (RUO). Not for use in diagnostic procedures.

First Edition: June, 2017

Application News

No. C99

Liquid Chromatography Mass Spectrometry

Quantitative Analysis of Veterinary Drugs Using the Shimadzu LCMS-8050 Triple Quadrupole Mass Spectrometer

Foods in which chemical residues, like pesticides, feed additives, and veterinary drugs found in excess of maximum residue levels have been banned from sale in many countries around the world. Compounds that are subject to residue standards vary widely and the list is expected to grow. Because of this, there is a need for a

highly sensitive and rapid analytical technique to analyze as many of these compounds as possible in a single run. This Application News introduces an example of the high-sensitivity analysis of 89 veterinary drugs in a crude extract of livestock and fishery products.

Sample Preparation

The typical samples used in the analysis of veterinary drugs contain large amounts of lipids because they are commonly meat and fish samples. Sample preparation is extremely important to ensure excellent sensitivity and repeatability. To avoid the typical time-consuming and laborious solid phase extraction sample preparation procedure, the QuEChERS method, which is typically used for the preparation of vegetables, was selected to simplify sample preparation.

The QuEChERS method normally consists of two steps, the first is an acetonitrile extraction and the second a cleanup step, but this time only the acetonitrile extraction step was used.

* QuEChERS Extraction Salts kit: Restek Q-sep™ AOAC2007.01

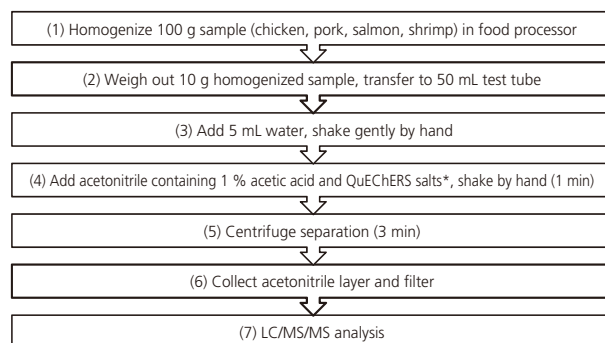

Fig. 1 Sample Preparation Procedure

Improved Peak Shape Using Sample / Water Co-Injection

When conducting reversed phase chromatography, the peaks of polar compounds may split or collapse depending on the relationship between the sample solvent and mobile phase. In cases where the sample solvent is rich in organic solvent, the elution strength must be lowered (by substitution or dilution) with the addition of water. As the pretreated sample solvent in this analysis consists of 100 % acetonitrile, injection in that state into the LC/MS will result in split peaks for some of the substances (Fig. 2 left).

To eliminate as much of the time and effort typically associated with sample preparation, the pretreatment features of the autosampler (SIL-30A) were utilized to conduct co-injection of sample and water, which resulted in improved peak shapes.

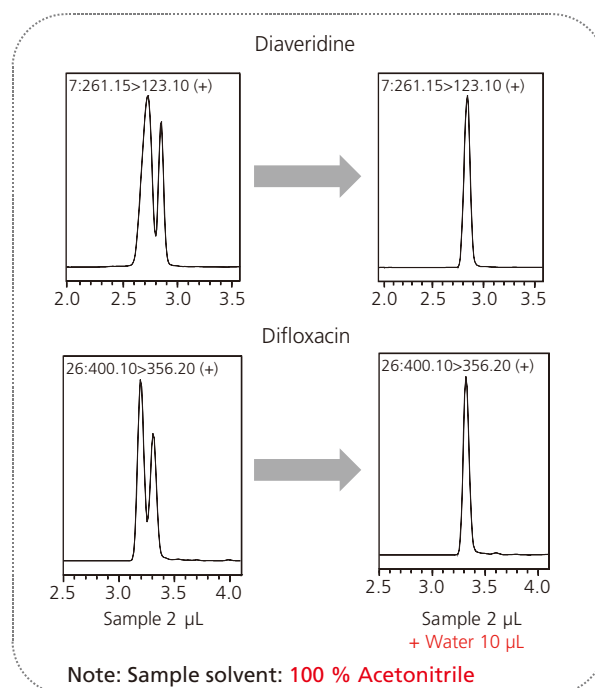
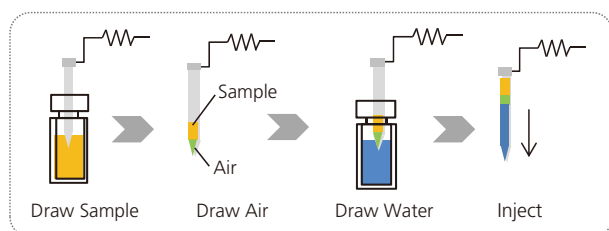

Fig. 2 Comparison of Peak Shape

MRM Analysis of Matrix Standards

Fig. 3 shows the MRM chromatogram of the matrix standard solution consisting of the sample solution with added standard solution (data obtained using pork extract solution). Table 1 shows the lower limits of quantitation for the standard solution without added matrix and with added matrix, respectively. In a crude extract obtained by acetonitrile extraction alone, sensitivity was comparable to that obtained for most of

the compounds using only standard solution. Although there were several compounds for which the lower limit of quantitation was different in the standard solution than the matrix-added solution, rather than attributing this to matrix effects, it is thought to be caused by elevated background due to ions derived from contaminating components (Refer to Fig. 5).

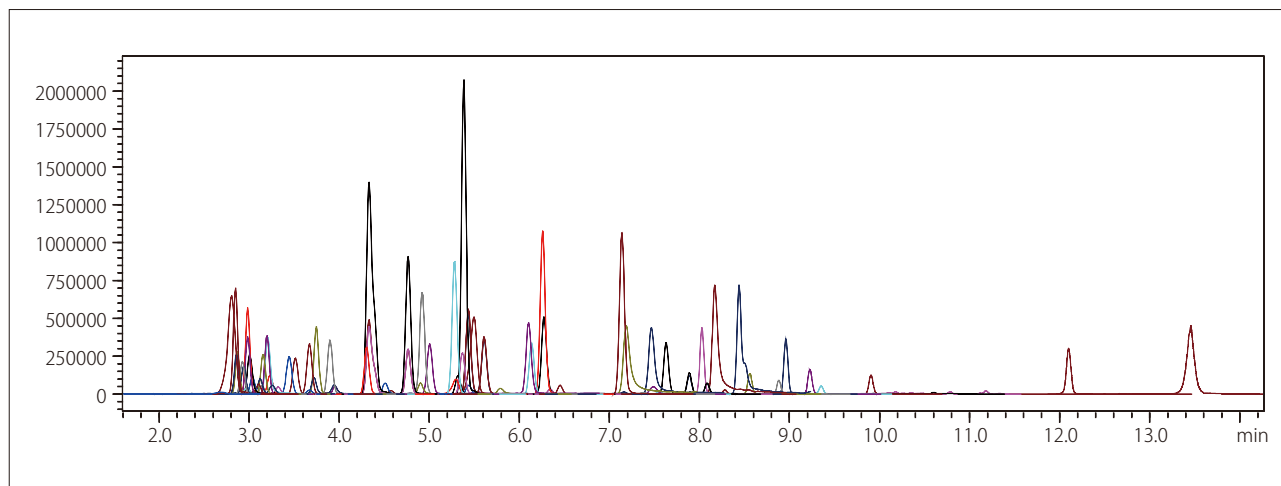

Fig. 3 MRM Chromatograms of 89 Veterinary Drugs (10 µg/L pork extract solution with added standard solution)

Table 1 LOQs of Veterinary Drugs in Neat Standards and Matrix Standards and Calibration Range of Veterinary Drugs in Matrix Standards

	Std. Solution		Matrix-Added Std. Solution			Std. Solution		Matrix-Added Std. Solution	
	Min. Conc.	Max. Conc.	Min. Conc.	Max. Conc.		Min. Conc.	Max. Conc.	Min. Conc.	Max. Conc.
Gentamicin	0.5	50	1	50	Sulfachloropyridazine	0.02	20	0.02	20
Sulfanilamide	1	50	1	50	Sulfadimethoxine	0.02	10	0.02	10
Levamisole	0.05	50	0.05	50	Tylosin	0.05	50	0.05	50
Lincomycin	0.01	10	0.01	10	Sulfamethoxazole	0.02	10	0.1	10
5-Propylsulfonyl-1-benzimidazole-2-amine	0.05	10	0.05	10	Sulfaethoxypyridazine	0.02	10	0.02	10
Diaveridine	0.01	10	0.01	10	Tiamulin	0.01	50	0.01	50
Trimethoprim	0.02	20	0.02	20	Florfenicol	0.5	50	10	50
Marbofloxacin	0.01	50	0.01	50	2-Acetylaminio 5-nitrothiazole	0.05	50	0.05	50
Sulfisomidine	0.02	20	0.02	20	Sulfatroxazole	0.01	5	0.01	5
Norfloracin	0.5	50	0.5	50	Leucomycin	0.01	50	0.01	50
Ormetoprim	0.02	10	0.02	10	Sulfisoxazole	0.01	50	0.05	50
Thiabendazole	0.01	10	0.01	10	Oxolinic acid	0.01	50	0.1	50
Ciprofloxacin	0.05	10	0.5	10	Chloramphenicol	0.5	50	1	50
Neospiramycin I	0.01	10	0.05	10	Clorsulon	0.5	50	1	50
Danofloxacin	0.1	10	0.1	10	Sulfabenzamide	0.01	10	0.01	10
Enrofloxacin	0.05	50	0.1	50	Ethopabate	0.01	10	0.01	10
Oxytetracycline	0.01	50	0.1	50	Sulfadoxine	0.02	20	0.02	20
Xylazine	0.01	10	0.01	10	Sulfaquinoxaline	0.02	10	0.02	10
Orbifloxacin	0.05	50	0.05	50	Prednisolone	0.1	20	0.05	20
Sulfacetamide	1	50	1	50	Ofloxacin	0.5	50	0.5	50
Clenbuterol	0.01	10	0.01	10	Flubendazole	0.01	50	0.01	50
Tetracycline	0.05	50	0.01	50	Methylprednisolone	0.5	50	0.5	50
Spiramycin I	0.01	50	0.01	50	Nalidixic acid	0.01	50	0.01	50
Sarafloxacin	0.5	50	0.5	50	Dexamethasone	0.5	50	0.5	50
Difloxacin	0.05	50	0.1	50	Flumequine	0.01	50	0.01	50
Sulfadiazine	0.02	20	0.1	20	Benzyloxyphenoxymethyl penicillin	0.5	50	0.5	50
Sulfathiazole	0.02	20	0.1	20	Sulfantran	0.2	50	0.2	50
Sulfapyridine	0.02	20	0.1	20	Sulfabromomethazine	0.01	50	0.01	50
Carbadox	0.05	10	0.05	10	beta-Trenbolone	0.02	50	0.1	50
Pyrimethamine	0.02	20	0.02	20	Emamectin B1a	0.01	50	0.01	50
Sulfamerazine	0.02	20	0.02	20	alpha-Trenbolone	0.02	50	0.1	50
Chlortetracycline	0.1	50	0.1	50	Piromidic acid	0.01	50	0.05	50
Tilmicosin	0.1	50	0.1	50	Zeranol	1	50	0.1	50
Thiamphenicol	1	50	1	50	Ketoprofen	0.01	50	0.05	50
Sulfadimidine	0.02	20	0.02	20	Testosterone	0.01	10	0.05	10
Sulfamethoxydiazine	0.01	10	0.02	10	Famphur	0.05	50	0.05	50
Sulfamethoxy-pyridazine	0.02	20	0.02	20	Fenobucarb (BPMC)	0.01	50	0.01	50
Sulfisozole	0.01	50	0.01	50	Clostebol	0.05	50	0.05	50
Trichlorfon (DEP)	0.05	50	0.05	50	Dichlofenac	0.01	50	0.01	50
Sulfamonomethoxine	0.02	20	0.02	20	Melengestrol Acetate	0.05	50	0.05	50
Furazolidone	1	50	1	50	Temephos (Abate)	0.01	50	0.5	50
Difurazone	0.05	50	0.05	50	Allethrin	0.1	50	1	50
Erythromycin A	0.01	50	0.01	50	Cloasantel	0.01	10	0.01	10
Cefazolin	0.5	50	0.5	50	Monensin	0.01	10	0.01	10

(Unit: µg/L)

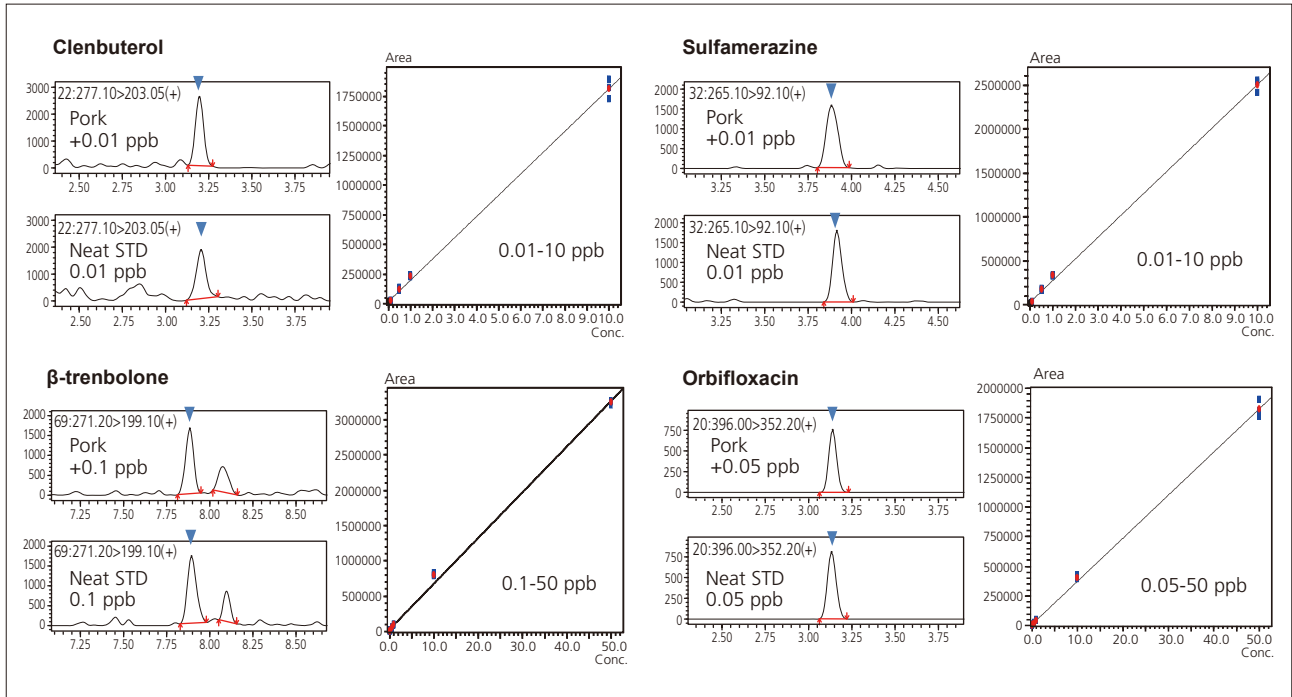

Fig. 4 MRM Chromatograms in the Vicinity of the LOQ and Calibration Curves of Typical Compounds

■ Recoveries of Veterinary Drugs in Crude Extracts from Livestock and Fishery Products (Matrix Effect Verification)

We examined whether or not the matrix affected measurement of actual samples. This time, four types of food product samples were used, including shrimp, chicken meat, pork, and salmon. Standard solution was added to the acetonitrile extraction solution of each of these to obtain a final concentration of 10 µg/L, after

which the rates of recovery were determined. The results indicated that 90 % of the compounds were recovered at rates of 70 to 120 % and measurement was accomplished without any adverse matrix effects even though the crude extract solution was subjected only to acetonitrile extraction.

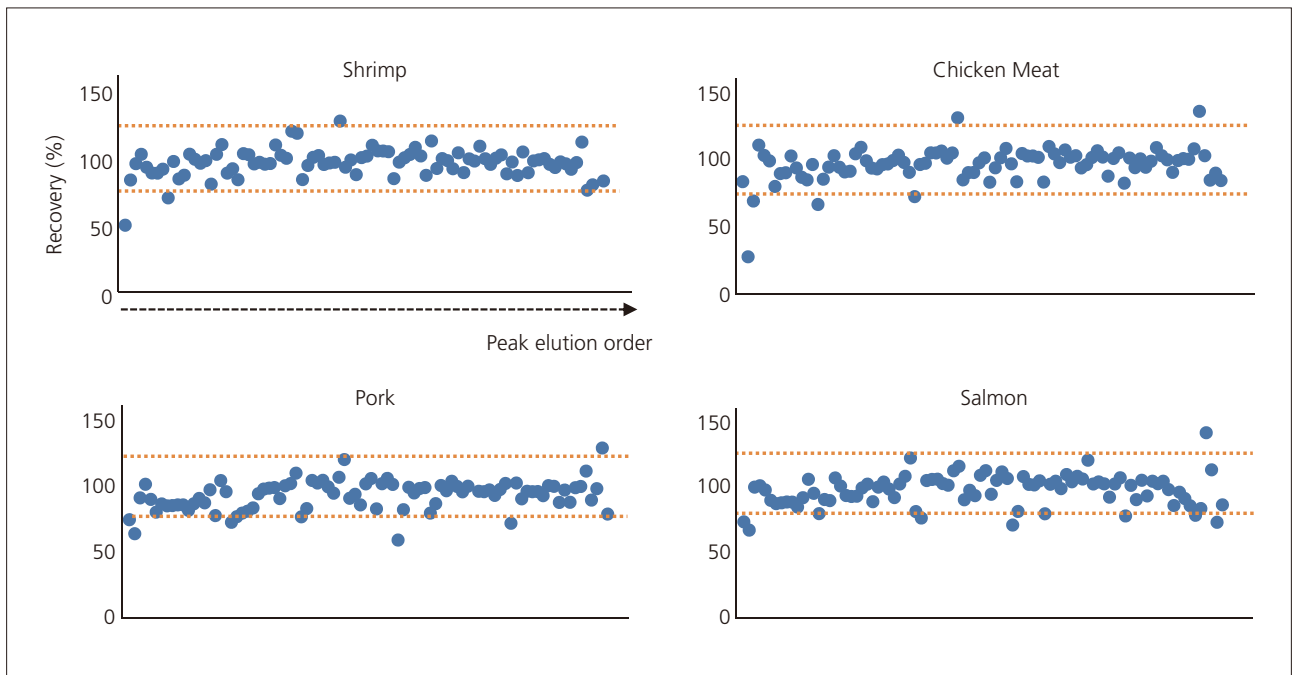

Fig. 5 Recoveries of Veterinary Drugs in Each of the Matrices

Acetonitrile Extraction Efficiency Using QuEChERS Method

To check the efficiency of acetonitrile extraction by the QuEChERS method, standard solution was added at stage (2) of Fig. 1 to obtain a concentration of 10 µg/L, and the recoveries were determined. Good recoveries of approximately 80 % were obtained in cases both

with and without the addition of matrix. However, relatively poor recoveries were seen for highly polar compounds such as tetracycline and quinolone. For these compounds, it is necessary to examine the use of a separate extraction solvent and extraction reagent.

Table 2 Recoveries (Pre-Spike)

Recovery	Without Matrix	With Matrix (Pork)	Compounds with Poor Recovery
< 50 %	17 (19 %)	13 (15 %)	Tetracyclines Quinolones
50 % - 70 %	1 (1 %)	8 (9 %)	
> 70 %	71 (80 %)	68 (76 %)	

Robustness

We checked the long-term stability of the instrument using a solution of pork crude extract (spiked with 10 µg/L standard solution). Even after continuous

measurement of an extremely complex matrix over a period of 3 days, we were able to obtain stable data.

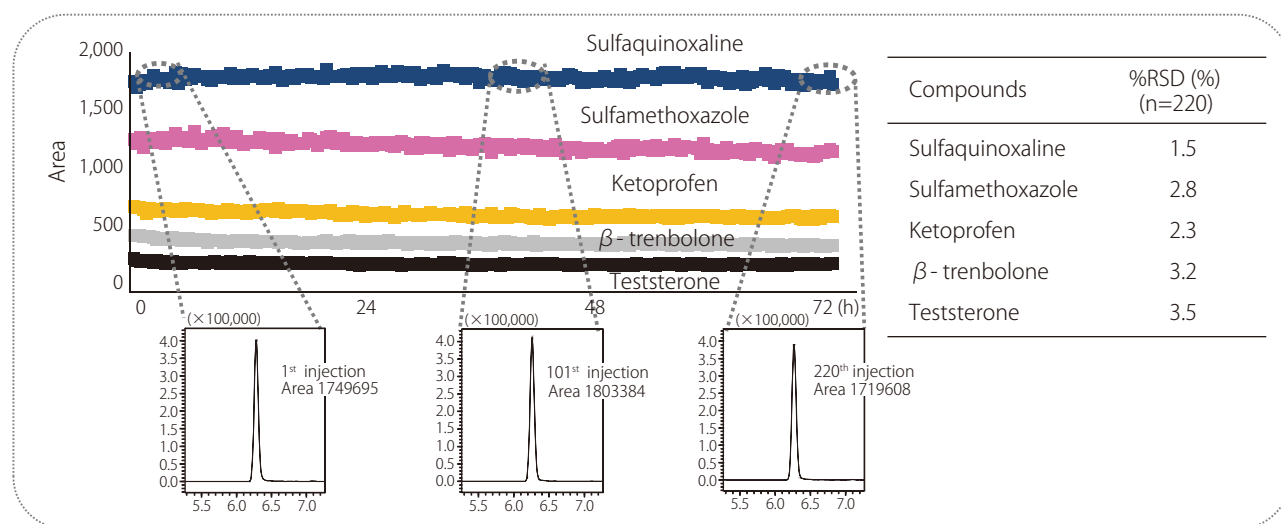

Fig. 6 Area Plot and %RSD of Typical Compounds with Continuous Analysis

Table 3 Analytical Conditions

Column	: Shim-pack XR-ODS II (75 mm × 2.0 mm I.D., 2.2 µm)
Mobile Phase A	: 0.1 % Formic Acid - Water
Mobile Phase B	: Acetonitrile
Time Program	: 1 %B (0 min) → 15 %B (1 min) → 40 %B (6 min) → 100 %B (10-13 min) → 1 %B (13.01-16 min)
Flowrate	: 0.2 mL/min.
Injection Volume	: 2 µL (2 µL sample solution + 10 µL water)
Oven Temperature	: 40 °C
Ionization Mode	: ESI (Positive / Negative)
Probe Voltage	: +2.0 kV / -1.0 kV
Nebulizing Gas Flow	: 3.0 L/min.
Drying Gas Flow	: 10.0 L/min.
Heating Gas Flow	: 10.0 L/min.
Interface Temperature	: 400 °C
DL Temperature	: 200 °C
Block Heater Temperature	: 400 °C

[← Return to main page](#)

Vegetables, Fruits and Spices



1. A High Sensitivity LC/MS/MS Method with QuEChERS Sample Pre-treatment for Analysis of Aflatoxins in Peanut Butter Samples
2. Determination of Phthalates in Vegetables by GPC–GCMS
3. Taking Advantage of the Contaminant Library
4. Efficient Analysis of Residual Pesticides in Foods Using High-Sensitivity GC-MS/MS
5. Quantitative Analysis of Highly Polar Pesticides in Food Using SFC/MS
6. Improved Detection of Pesticide Residues in Botanicals by LCMS
7. Fast GC-MS/MS Analysis Of Multicomponent Pesticide Residues (360) In Food Matrix
8. Multi-Residue Analysis of 18 Regulated Mycotoxins by LC/MS/MS
9. Multi-residue Analysis of 18 Regulated Mycotoxins by LC-MS/MS (2)
10. Multi-Residue Analysis of 210 Pesticides in Food Samples by Triple Quadrupole UHPLC-MS/MS
11. Expanding Capabilities in Multi-Residue Pesticide Analysis Using The LCMS-8060
12. Analysis of Nivalenol, Deoxynivalenol, 3-Acetyldeoxynivalenol and 15-Acetyldeoxynivalenol Using Triple Quadrupole LC/MS/MS (LCMS-8050)
13. Rapid analysis of polychlorinated biphenyls (PCBs) in vegetables by QuEChERS-based extraction and GPC–GCMS
14. Using the Nexera UC Online SFE-SFC-MS System to Analyze Residual Pesticides in Agricultural Products
15. Applying 'MRM Spectrum Mode' and Library Searching for Enhanced Reporting Confidence in Routine Pesticide Residue Analysis
16. Residual Pesticides Analysis of Botanical Ingredients Using Gas Chromatography Triple Quadrupole Mass Spectrometry
17. Expanding Capabilities in Multi-Residue Pesticide Analysis Using The LCMS-8060
18. Highly Polar Pesticide Multi-Residue Analysis in Food Safety by LC-MS/MS
19. Simultaneous Analysis of 16 Sweeteners Using Triple Quadrupole LC/MS/MS [LCMS-8050]
20. Simultaneous Analysis of Nine Sweeteners Using Triple Quadrupole LC/MS/MS (LCMS-8040)
21. Determination of Avermectin Drug Residues in Vinegar Using LCMS-8045
22. A Sensitive and Repeatable Method for Characterization of Sulfonamides and Trimethoprim in Honey using QuEChERS Extracts with LC-MS/MS

A High Sensitivity LC/MS/MS Method with QuEChERS Sample Pre-treatment for Analysis of Aflatoxins in Peanut Butter Samples

ASMS 2015 WP074

Yin Ling Chew¹; Jie Xing¹; Zhi Wei Ting¹;
Jun Xiang Lee^{*2}; Zhaoqi Zhan¹

¹Shimadzu (Asia Pacific) Pte Ltd, Singapore,
118264 SINGAPORE;

²School of Physical & Mathematical Sciences, Nanyang
Technological University, Singapore 637371,

*Student

A High Sensitivity LC/MS/MS Method with QuEChERS Sample Pre-treatment for Analysis of Aflatoxins in Peanut Butter Samples

Introduction

Aflatoxins are metabolites produced by fungi (*Aspergillus flavus* and *Aspergillus parasiticus*) in high humidity environment in crops such as maize nuts and processed food. Aflatoxin contamination in food is monitored with strict regulations worldwide due to high toxicity of the compounds [1]. Recently, several media reports revealed the exceed levels of aflatoxins found in peanut butters in the USA and Taiwan. Aflatoxins in food have been

analyzed by LC/MS/MS using various sample pre-treatment methods. We describe a high sensitivity LC/MS/MS method for quantitative analysis of aflatoxins in peanut butters using QuEChERS sample pre-treatment procedure [2], as opposed to the use of immunoaffinity column or other methods for sample pre-treatment which are more expensive and tedious. High sensitivity and good recoveries were achieved using this LC/MS/MS method.

Experimental

A mixed standard of aflatoxin B1, B2, G2 and G2 was obtained from Supelco. A stock solution was prepared using methanol as the diluent, from which calibrant series and spiked samples were prepared. The QuEChERS kits were purchased from RESTEK. Two grams of peanut butter was first extracted with the extraction kits followed by cleaning up using dSPE tubes. The procedure was adjusted and optimized to obtain highest recovery. A

LCMS-8050 triple quadrupole LC/MS/MS (Shimadzu Corporation, Japan) was used in this work. A C18 column (Kinetex, 2.1 x 100mm, 1.7 μ m) was used for fast separation of aflatoxins using a gradient elution program. The method development and performance evaluation were carried out using spiked aflatoxins in peanut butter samples. Table 1 shows the analytical conditions on LCMS-8050.

Table 1: LC/MS/MS analytical conditions of aflatoxins on LCMS-8050

Column	Kinetex C18 (2.1mmI.D x 100mmI.D, 1.7 μ m)
Flow rate	0.5 mL/min
Mobile phase	A: 5mM ammonium acetate in water with 0.1% FA B: 5mM ammonium acetate in MeOH
Oven temp.	40 °C
Injection vol.	5 μ L
Elution mode	Gradient elution, B%: 5% (0 to 0.5 min) \rightarrow 50% (4 to 5.5 min) \rightarrow 85% (6 to 7.5 min) \rightarrow 5% (8.1 to 10 min)
Interface	ESI
MS mode	Positive, MRM, 2 transitions for each compound
Interface temp.	350 °C
Block temp.	400 °C
DL temp.	250 °C
CID gas	Ar (350 kPa)
Nebulizing gas flow	3.0 mL/min
Drying gas flow	10.0 L/min
Heating gas flow	10.0 L/min

A High Sensitivity LC/MS/MS Method with QuEChERS Sample Pre-treatment for Analysis of Aflatoxins in Peanut Butter Samples

Results and Discussion

QuEChERS sample pre-treatment

Hexane was used in the procedure to remove fats, oils and non-polar components from the peanut butter samples. The extraction step was completed using Q-sep QuEChERS extraction salt packet (4 g MgSO₄, 1 g NaCl, 1 g trisodium citrate dehydrate, 0.5 g disodium hydrogen citrate). Dispersive SPE tube containing MgSO₄, PSA and C18 was used in the clean-up process to remove remaining water, organic acid and non-polar components respectively. The process of the sample preparation is illustrated in Figure 1.

Method Development

Automated MRM optimisation of aflatoxins was carried out using the LabSolutions workstation. The precursors of aflatoxins B1, B2, G1 and G2 were their protonated ions (m/z 313.1, m/z 315.1, m/z 329.1 and m/z 331.1, respectively). Two MRM transitions of every aflatoxin were chosen as quantifier and confirmation ion (Table 2). A peanut butter matrix free from aflatoxins was used as a "blank" and matrix for the preparation of post-spiked calibrants to build calibration curves. The blank and every post-spiked calibrant was injected thrice and the average area was calculated to obtain reliable results. A chromatogram of spiked sample is shown in Figure 2. Linear calibration curves were obtained for all four aflatoxin compounds. Good linearity with correlation coefficient (r^2) greater than 0.999 across the range of 10 pg/mL - 10 ng/mL was obtained. The calibration curves of aflatoxins spiked in peanut butter matrix are shown in Figure 3.

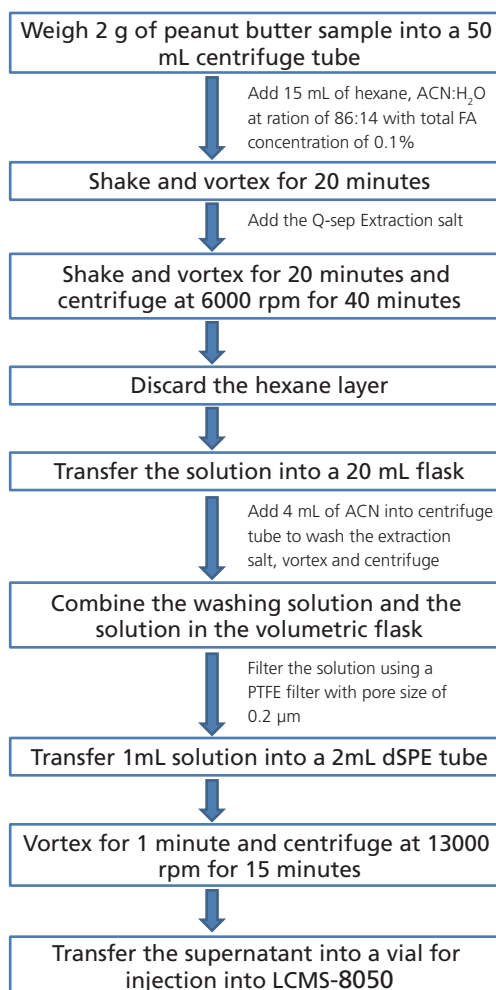

Figure 1: Flow chart of sample pretreatment for aflatoxins in peanut butter by modified QuEChERS method.

Table 2: LC/MS/MS analytical conditions of LCMS-8050 for aflatoxins

Compound	MRM (m/z)	CID Voltage (V)		
		Q1	CE	Q3
Aflatoxin B1	313.1>241.0*	-15	-37	-26
	313.1>213.0	-15	-46	-22
Aflatoxin B2	315.1>259.1*	-15	-30	-28
	315.1>287.0	-15	-27	-20
Aflatoxin G1	329.1>243.0*	-30	-27	-27
	329.1>200.0	-30	-42	-21
Aflatoxin G2	331.1>245.0*	-16	-33	-25
	331.1>189.0	-16	-42	-19

*MRM transitions used as quantifiers.

A High Sensitivity LC/MS/MS Method with QuEChERS Sample Pre-treatment for Analysis of Aflatoxins in Peanut Butter Samples

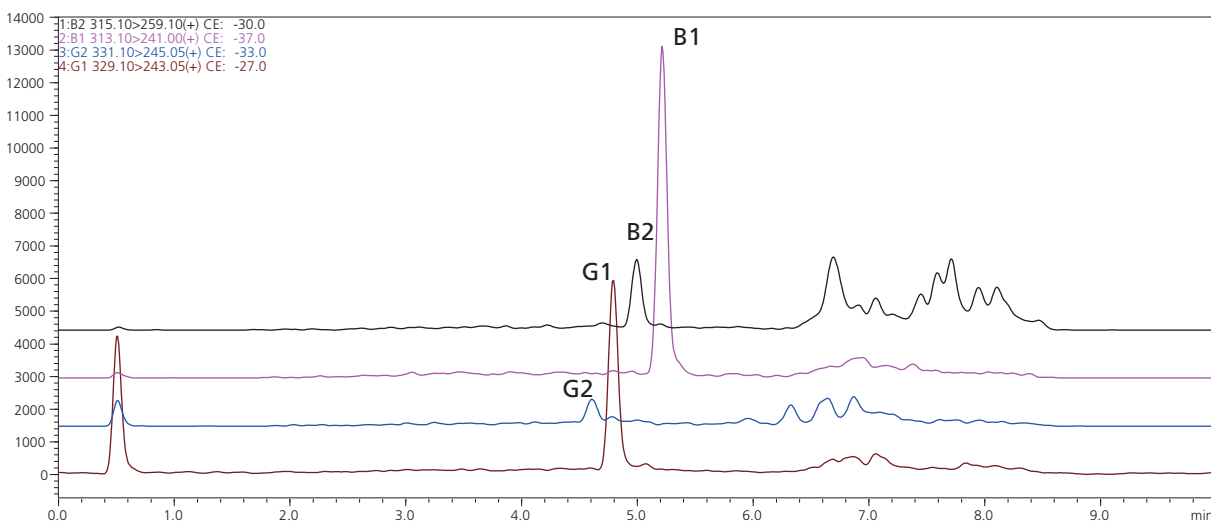

Figure 2: MRM chromatograms of aflatoxins spiked in peanut butter sample (B1 and G1 at concentration of 100 pg/mL; B2 and G2 at concentration of 30 pg/mL).

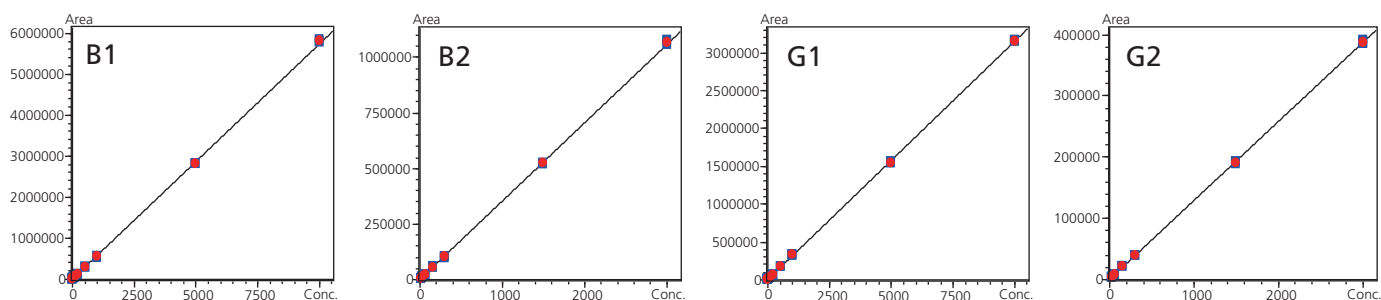

Figure 3: Calibration curves of aflatoxins B1, B2, G1 and G2 in peanut butter matrix.

Table 3: LOD, LOQ and repeatability of aflatoxin spiked samples at different concentrations

Compound	Concentration range (pg/mL)	%RSD (n=6)						LOQ	LOD	r2
		15 ppt	30 ppt	50 ppt	60 ppt	100 ppt	200 ppt			
B1	10 - 10000			2.71		2.22	1.20	4.6	1.5	0.9995
B2	11 - 3000	7.73	7.51		2.96			8.7	2.9	0.9997
G1	10 - 10000			2.21		1.82	1.21	4.2	1.4	0.9995
G2	30 - 3000		12.12		9.10			22.4	7.4	0.9995

A High Sensitivity LC/MS/MS Method with QuEChERS Sample Pre-treatment for Analysis of Aflatoxins in Peanut Butter Samples

Method Performance Evaluation

As shown in Table 4, the LOD and LOQ of aflatoxins in peanut butter matrix are lower than 7.4 pg/mL and 22.4 pg/mL respectively. The repeatability of the method was evaluated using using spiked samples at lower concentrations. The peak area %RSD of aflatoxins were found to be lower than 7.5% except for G2 with %RSD of 12.1%.

The matrix effect was evaluated by using the average of spiked samples injected thrice at different concentrations. The recoveries of aflatoxins were determined by using a duplicate set of samples at different concentrations. Each duplicate was obtained from the average of three injections. The results are shown in Table 4.

Table 4: Matrix effects of the MRM method for aflatoxins in spiked peanut butter samples

Concentration (pg/mL)	Matrix effect (%)		Concentration (pg/mL)	Matrix effect (%)	
	B1	G1		B2	G2
50	78.35	80.63	60	72.31	70.14
100	71.88	71.24	150	73.81	74.72

Table 5: Recoveries of aflatoxins in spiked peanut butter samples

Compound	Recovery (%)							
	30 pg/mL		50 pg/mL		60 pg/mL		200 pg/mL	
	Dup 1	Dup 2	Dup 1	Dup 2	Dup 1	Dup 2	Dup 1	Dup 2
B1			70.24	74.00			81.52	80.49
B2	65.22	71.20			87.40	85.12		
G1			90.92	95.11			77.47	79.38
G2	79.97	79.58			87.76	86.52		

Analysis of aflatoxins in actual samples

Three peanut butter samples from local supermarket were analysed using the established MRM method. The results showed that aflatoxins were found in two of the samples (Table 6). While the aflatoxins in sample M is within the

EU regulatory limits (sum of aflatoxins below 4 µg/kg), the aflatoxin B1 amount in sample UL exceeds the allowed concentration (aflatoxin B1 below 2 µg/kg).

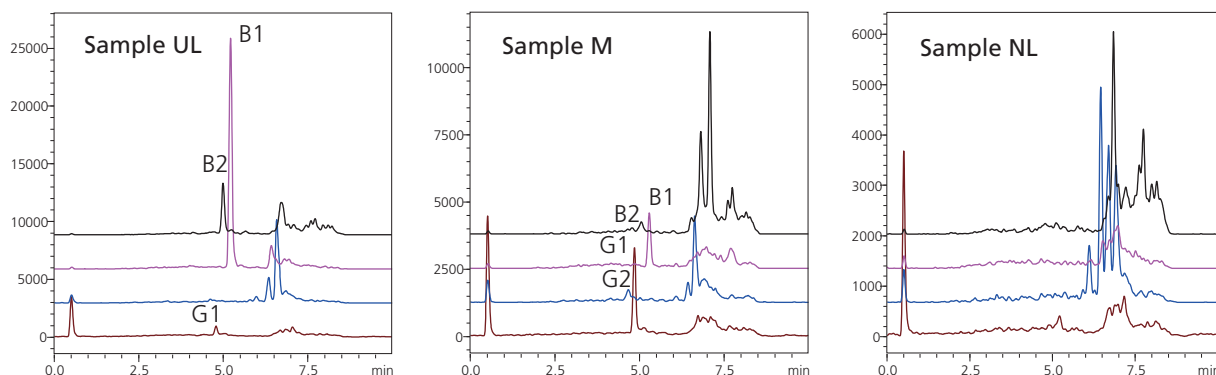

Figure 4: Chromatograms of peanut butter samples.

A High Sensitivity LC/MS/MS Method with QuEChERS Sample Pre-treatment for Analysis of Aflatoxins in Peanut Butter Samples

Table 6: The amount of aflatoxins found in peanut butter samples from supermarket

Sample	Concentration (ng/g)			
	B1	B1	G1	G2
UL	2.09	0.79	0.03	Not detected
M	0.16	0.06	0.50	0.18
NL	Not detected	Not detected	Not detected	Not detected

Conclusions

A high sensitivity LC/MS/MS method with QuEChERS for sample pre-treatment was established using Shimadzu LCMS-8050 system. The QuEChERS sample preparation method was proven effective and easy to operate. The method performance including sensitivity, linearity,

repeatability, matrix effect and recovery were carried out and the results confirm that the method is feasible and reliable for determination of aflatoxins in peanut butter samples.

References

- (1) Pereira, V.; Fernandes, J.; Cunha, S. *Trends in Food Science & Technology* 2014, 36, 96-136.
- (2) Liu, Y.; Han, S.; Lu, M.; Wang, P.; Han, J.; Wang, J. *Journal of Chromatography B* 2014, 970, 68-76.

Determination of Phthalates in vegetables by GPC–GCMS

ASMS 2016 WP 213

Xi ZHANG¹, Guixiang YANG¹, Jun FAN², Taohong HUANG²

¹ Shimadzu (China) CO.LTD, beijing;

² Shimadzu (China) CO.LTD, shanghai

Determination of Phthalates in vegetables by GPC-GCMS

Introduction

Phthalates (PAEs) are a class of compounds which can be added to plastics to increase its flexibility, transparency, durability and longevity. They can be used in electronics industry, agriculture adjuvant, building materials, toys, food packaging materials and textiles etc. Because of its medium viscosity, high stability, low volatility, easily accessible, low cost and other features, they are currently the most widely used plasticizer.

In 2011 PAEs events broke out in Taiwan drinks, and in 2012 the same thing happened to a certain brand of liquor. And recently it was reported that “vegetables wrapped in tape” in the supermarkets may contain PAEs. And this caused more and more consumers pay great

attention to the PAEs.

PAEs were classified as one kind of suspected environmental hormone. Their toxicity is mainly estrogen and anti-androgen activity which can cause endocrine disorder and reproductive function hinder in the organism. Therefore, PAEs had been restricted used in the relevant national standards such as drinking water, toys, packaging materials and food etc.

In this report a method was developed using Shimadzu’s GPC-GCMS to determine 22 kinds of PAEs in vegetables. This method is sensitive, easy to operate and can be applied to quickly detect PAEs in vegetables.

Experimental

Instrument:

Shimadzu GPC-GCMS



Figure 1 Shimadzu GPC-GCMS

Determination of Phthalates in vegetables by GPC-GCMS

Experimental conditions:

GPC conditions:	
Chromatographic column	: Shodex CLNpak EV-200 (2.1 mm×150 mm)
Mobile phase	: acetone/cyclohexane (3/7, V/V)
Flow rate	: 0.1 mL/min
Column temperature	: 40°C
Sample size	: 20 µL
GCMS conditions:	
Chromatographic column	: inert quartz tube: 5 m×0.53 mm
Precolumn	: WondaCap WAX, 5m×0.25 mm×0.25 µm
Analytical column	: WondaCap WAX, 25m×0.25 mm×0.25 µm
Column oven temperature	: 82°C(5min)_8°C/min_150°C(0min)_25°C/min_240°C(5min)
Injection temperature	: 120°C(5min)_100°C/min_280°C(15.8min)
Pressure	: 120kPa(0min)_100kPa/min_180kPa(4.4min)_(-49.8 kPa/min)_120kPa (15.9min)
Purge flow	: 5.0mL/min_(-10mL/min)_0 mL/min(6min)_10mL/min_5mL/min (15.1min)
Sampling time	: 7min
Solvent cut time	: 9.7min
Interface temperature	: 250°C
Ion source temperature	: 200°C
Acquisition mode	: SIM, acquisition conditions are shown in Table 1

Sample pretreatment:

Weigh accurately 1.0 g grinded vegetables into 25 mL centrifuge tube, add 5 mL Water, mix and exact for 30 min. Then add 2 mL Hexane, mix and vortex for 3 min, then take the supernatant fluid for sample analysis.

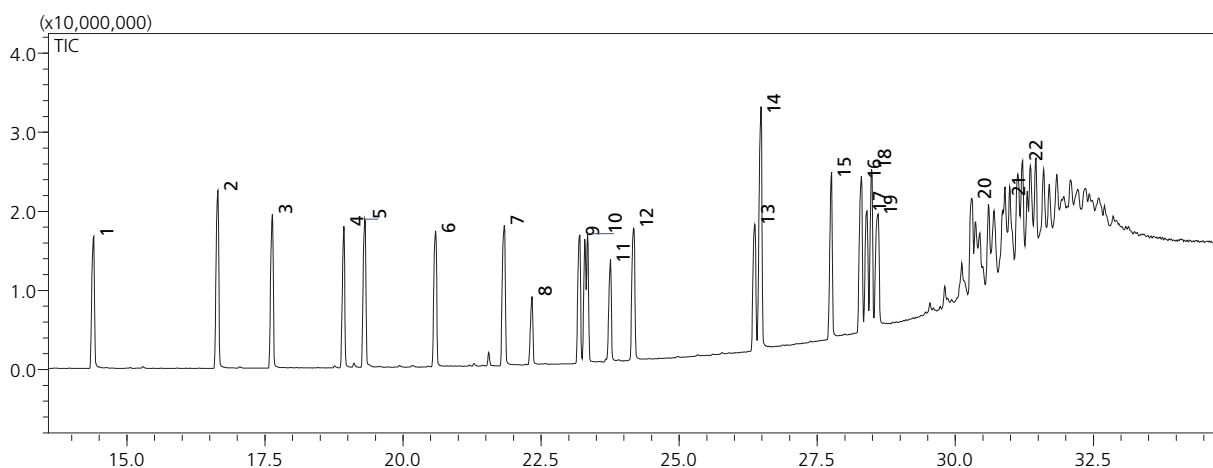

Figure 2 Total Ion Chromatogram of standard sample (1.0 mg/L)

Determination of Phthalates in vegetables by GPC-GCMS

Table 1 Characteristic fragment ions of PAEs(m/z)

No.	Compound name	CAS	R.T.	Target Ion	Ref. Ion 1	Ref. Ion 2
1	DMP	131-11-3	14.400	163	133	194
2	DEP	84-66-2	16.642	149	177	176
3	DIPRP	605-45-8	17.633	149	209	150
4	DAP	131-17-9	18.925	149	104	189
5	DPRP	131-16-8	19.308	149	209	191
6	DIBP	84-69-5	20.583	149	167	205
7	DBP	84-74-2	21.833	149	205	223
8	DMEP	117-82-8	22.333	149	104	176
9	DIPP	605-50-5	23.192	149	219	237
10	BMPP	146-50-9	23.342	167	149	251
11	DEEP	605-54-9	23.750	149	104	176
12	DPP	131-18-0	24.175	149	219	237
13	DHXP	84-75-3	26.367	149	233	251
14	BBP	85-68-7	26.475	149	91	206
15	DBEP	117-83-9	27.750	149	101	193
16	DCHP	84-61-7	28.292	149	167	249
17	DHP	3648-21-3	28.392	265	149	247
18	DEHP	117-81-7	28.483	279	149	167
19	DPHP	84-62-8	28.592	225	104	153
20	DNOP	117-84-0	30.292	149	261	279
21	DINP	68515-48-0	30.908	293	149	127
22	DIDP	26761-40-0	31.217	307	149	141

Result

Calibration curve & Repeatability

Dilute the standard stock solution into 0.005, 0.05, 0.1, 0.5, 1.0 µg/mL. Some of the calibration curves obtained are shown in Figure 2. The correlation coefficients are >0.999, the RSD% of 7 consecutive tests of 0.05 µg/mL

standard samples are less than 5 % and the detection limit calculated according to the data of 0.005 µg/mL standard sample (3 S/N) are below 3 µg/mL.

Sample & recovery results

Add PAEs standard (0.1, 0.2, and 0.4 mg/kg) into sample (lettuce, canola and celery) before sample pretreatment in accordance with the processing steps and calculate recovery rate. The results were between 60 % ~ 130 %.

Determination of Phthalates in vegetables by GPC-GCMS

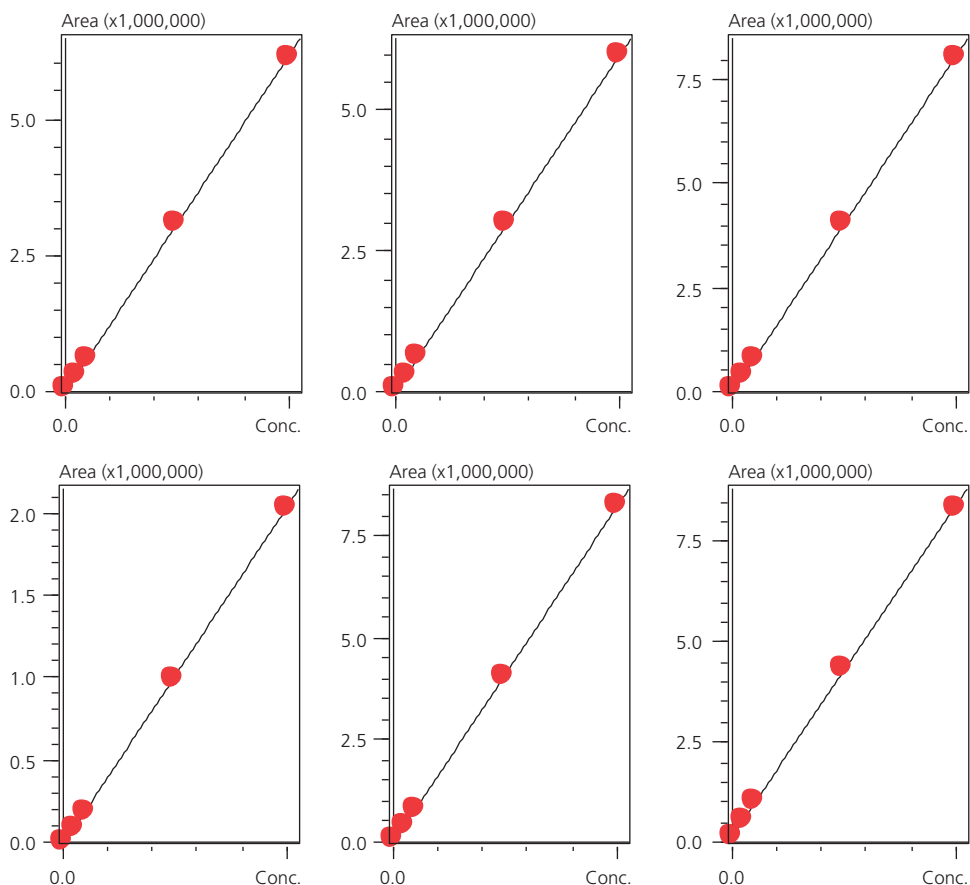

Figure 3 Calibration curve of some compounds

Conclusions

A quick, easy and reliable method for determination PAEs in vegetables by Shimadzu's GPC-GCMS is developed. This method is sensitive, easy to operate and can be applied to quickly detect PAEs in vegetables.

Disclaimer: The products and applications in this presentation are intended for Research Use Only (RUO). Not for use in diagnostic procedures.

First Edition: June, 2016

Application News

No. A535

Spectrophotometric Analysis

Taking Advantage of the Contaminant Library

Accuracy and speed are necessary when determining the cause of contaminants. There are many causes of contamination that lead to complaints, such as contamination originating from a company's own production line to consumers inadvertently introducing contaminants themselves, and therefore contaminant analysis requires considerable knowledge and experience.

This article introduces an example of contaminant analysis using a contaminant library that consolidates Shimadzu's experience and analysis know-how.

S. Iwasaki

Contaminant Library Overview

The contaminant library can be used in the same way as the standard library by adding it as an option to the LabSolutions IR software, which performs instrument control and data analysis on Shimadzu's FTIR instruments. Unlike commercially-available libraries that only contain data on single components, this contaminant library contains as many as 485 entries including mixtures such as actually collected contaminants (provided by water supply and food companies) and gaskets, and therefore achieves a remarkably improved search accuracy. Furthermore, while conventional contaminant libraries have only provided notation of component names, which made identifying the source of contaminants difficult, this library employs notation that allows inference of contamination sources.

In addition to infrared spectra obtained through measurement using a single reflection ATR attachment, the contaminant library contains detailed information including sample images, major elements, color, shape, hardness, and metallic luster. Since all included samples have also undergone EDX analysis, the corresponding EDX profile database can be viewed as a PDF file for samples that appear in the contaminant library search results. This contains the qualitative profile and quantitative analysis results.

Example of Contaminant Analysis

FTIR analysis was performed on contaminant 1 detected on a production line. Table 1 lists the instruments and analysis conditions. Fig. 1 shows the measurement result and search result from the contaminant library. With the top search result being bone particle, the contaminant was considered a mixture of calcium phosphate and protein. The peak around 1750 cm⁻¹ (C=O group derivative) present in contaminant 1 can be considered to be due to the influence of cooking oil.

Fig. 2 shows the EDX profile database of bone particle, which was indicated in the library search result. Performing EDX analysis enabled verification of the presence of Ca and P, which are the main components of bone. Since this corroborates the FTIR analysis results, this example demonstrates the benefits of analysis using both FTIR and EDX instruments.

Table 1 Instruments and Analysis Conditions

Instruments	: IRAffinity-1S, MIRacle10 (Diamond prism)
Resolution	: 4 cm ⁻¹
Accumulation	: 40
Apodization	: Happ-Genzel
Detector	: DLATGS

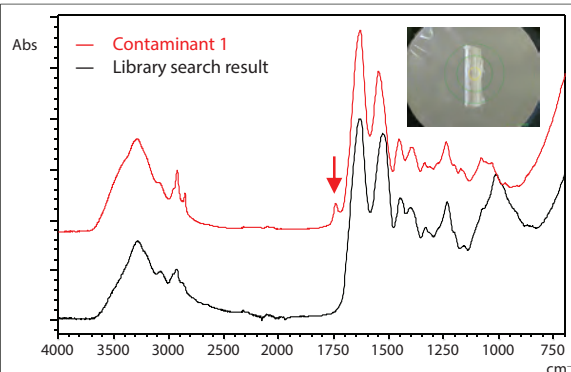

Library information: Bone particle_white Materials; Bone particle (Calcium phosphate, Protein) Major elements; Ca, P, S
Color; White Shape; Stick Hardness; Hard
Metallic luster; No Technique; ATR (Diamond)

Fig. 1 Measurement Result and Search Result of Contaminant 1

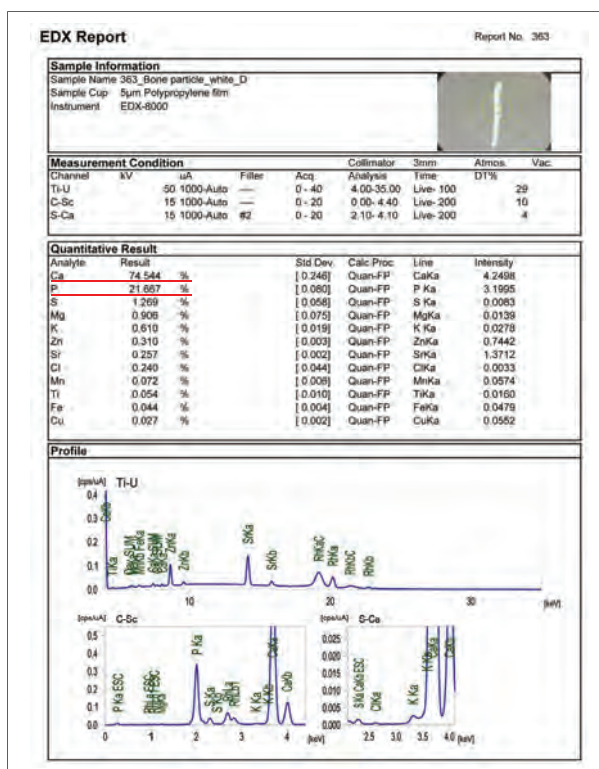

Fig. 2 EDX Profile Database of "Bone Particle"

Next, FTIR analysis was performed on contaminant 2 that was detected on a food production line. Fig. 3 shows the measurement result and the search result from the contaminant library. The top search result was a cluster of starch. While this contains starch, cooking oil, and protein, since the peak around 1750 cm⁻¹ (C=O group derivative) is hardly visible in contaminant 2 we can deduce that even if cooking oil was present in the contaminant, it would be minute.

Fig. 4 shows the EDX profile database of the cluster of starch that was indicated in the library search result. While salt (NaCl) was detected in the database, presumably from Na and Cl contained in food, almost no metallic elements were detected in contaminant 2. This leads to the possibility that contaminant 2 is an ingredient whose main components are starch and protein.

Lastly, Table 2 lists an example of data in the contaminant library.

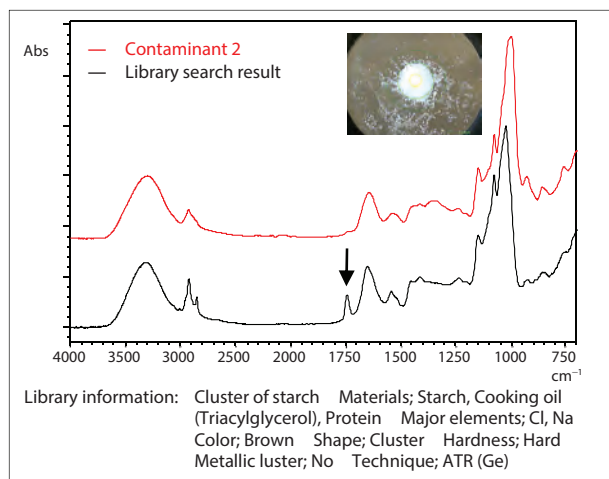

Fig. 3 Measurement Result and Search Result of Contaminant 2

Conclusion

While the data included in this library is useful for contaminant analysis since it contains the analysis results of actual contaminants, even higher accuracy in analysis can be achieved through the accumulation of samples detected as contaminants in a custom user library. The EDX-FTIR contaminant finder/material inspector software, EDXIR-Analysis, which was released in 2016, contains data files of

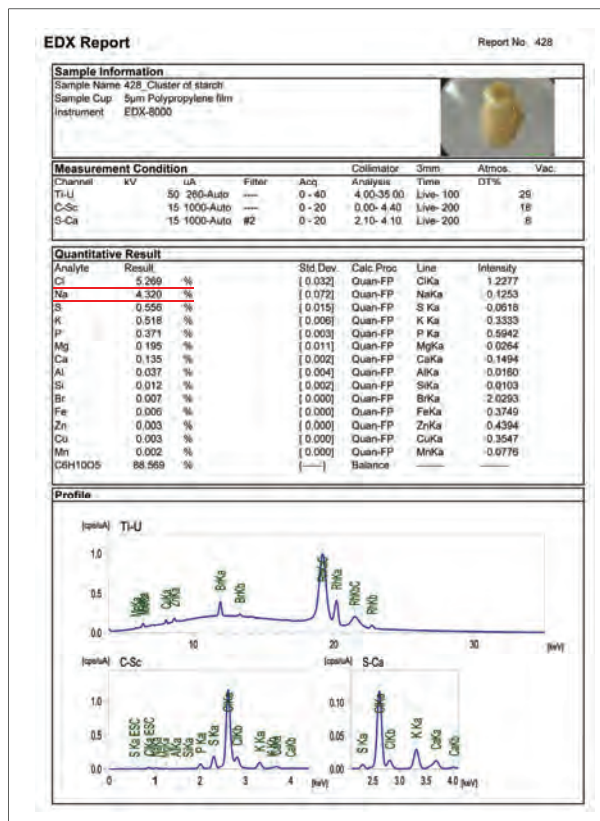

Fig. 4 EDX Profile Database of "Cluster of starch"

both FTIR and EDX analyses enabling integrated analysis using both data types. As demonstrated in the example of contaminant 1, in some cases performing EDX analysis may provide useful information for contaminant samples that prove difficult to identify with FTIR analysis alone. In contaminant analysis, a multifaceted approach which covers both organic and inorganic contaminants is very effective. For details, refer to Application News No. A522A.

Table 2 Example of Data in the Contaminant Library

	Name	Comment
Water Supply-Related Contaminants	Pipe slip packing	Pipe slip packing Materials; Polyethylene (PE) Major elements; below 1% Color; Black Shape; Resin/Ring Hardness; Hard Metallic luster; No Technique; ATR (Ge)
	Sealing tape	Sealing tape Materials; Polytetrafluoroethylene (PTFE) Major elements; F Color; White Shape; Film Hardness; Soft Metallic luster; No Technique; ATR (Ge)
	Coating of inner wall_1	Coating of inner wall_1 Materials; Polystyrene (PS), Acrylic resin Major elements; Cl Color; Brown Shape; Fragment Hardness; Soft Metallic luster; No Technique; ATR (Ge)
	Mold	Mold Materials; Protein, Silicate Major elements; below 1% Color; Brown Shape; Mold Hardness; Soft Metallic luster; No Technique; ATR (Ge)
Food-Related Contaminants	Coating in pump_white	Coating in pump_white Materials; Polyamide (Nylon 11), Titanium dioxide (TiO ₂) Major elements; Ti, Na Color; White Shape; Scraping Hardness; Brittle Metallic luster; No Technique; ATR (Ge)
	Piece of plant material	Piece of plant material Materials; Plant epidermis (Cellulose), Vegetable fat (Triacylglycerol) Major elements; Cl, Na Color; Brown Shape; Cluster Hardness; Soft Metallic luster; No Technique; ATR (Ge)
	White hair	White hair Materials; Human hair (Protein) Major elements; S Color; White Shape; Fiber Hardness; Soft Metallic luster; No Technique; ATR (Ge)
	Nail	Nail Materials; Nail (Keratin) Major elements; S Color; White Shape; Fragment Hardness; Hard Metallic luster; No Technique; ATR (Ge)
	Bone particle_brown	Bone particle_brown Materials; Bone particle (Calcium phosphate, Protein) Major elements; Ca, P, Mg Color; Brown Shape; Stick Hardness; Hard Metallic luster; No Technique; ATR (Ge)
	Stapler1	Stapler1 Materials; Zinc stearate (Adsorbate on metal surface) Major elements; Fe, P Color; Black Shape; Stick Hardness; Hard Metallic luster; Yes Technique; ATR (Ge)
	Glass fragment	Glass fragment Materials; Glass (SiO ₂) Major elements; Pb, Si, K, Na, Zn Color; Transparency Shape; Cluster Hardness; Hard Metallic luster; No Technique; ATR (Ge)
	Stainless steel_1	Stainless steel_1 Materials; Unidentified (Adsorbate on metal surface) Major elements; Fe, Cr, Ni, Mn Color; Silver Shape; Metal Hardness; Hard Metallic luster; Yes Technique; ATR (Ge)

First Edition: Mar. 2017



For Research Use Only. Not for use in diagnostic procedure.

This publication may contain references to products that are not available in your country. Please contact us to check the availability of these products in your country.

The content of this publication shall not be reproduced, altered or sold for any commercial purpose without the written approval of Shimadzu. Company names, product/service names and logos used in this publication are trademarks and trade names of Shimadzu Corporation or its affiliates, whether or not they are used with trademark symbol "TM" or "™". Third-party trademarks and trade names may be used in this publication to refer to either the entities or their products/services. Shimadzu disclaims any proprietary interest in trademarks and trade names other than its own.

The information contained herein is provided to you "as is" without warranty of any kind including without limitation warranties as to its accuracy or completeness. Shimadzu does not assume any responsibility or liability for any damage, whether direct or indirect, relating to the use of this publication. This publication is based upon the information available to Shimadzu on or before the date of publication, and subject to change without notice.

Shimadzu Corporation
www.shimadzu.com/an/

GC-MS

Gas Chromatograph Mass Spectrometer

Efficient Analysis of Residual Pesticides in Foods Using High-Sensitivity GC-MS/MS

In the analysis of residual pesticides in foods, periodic maintenance is required. This includes the replacement of insert liners and column cutting due to the impact of impurities originating in the foods. However, because of issues such as the time for maintenance procedures and the cost of consumables, there is a need to reduce the frequency of maintenance as much as possible.

The GCMS-TQ8050, a high-sensitivity GC-MS/MS, can detect trace ions with high sensitivity, so high quantitative accuracy is obtained even for trace components. Using the high-sensitivity TQ8050, existing lower limits of quantitation can be obtained with small injection volumes. Further, reducing the injection volume lessens the analysis burden on parts such as insert liners, columns, and the ion source, which, in turn, reduces the frequency of maintenance. This Application Data Sheet presents the analysis results of pesticide standard samples and actual tomato samples, under conditions in which the injection volume is reduced to 1/4 the conventional amount, using the GCMS-TQ8050.

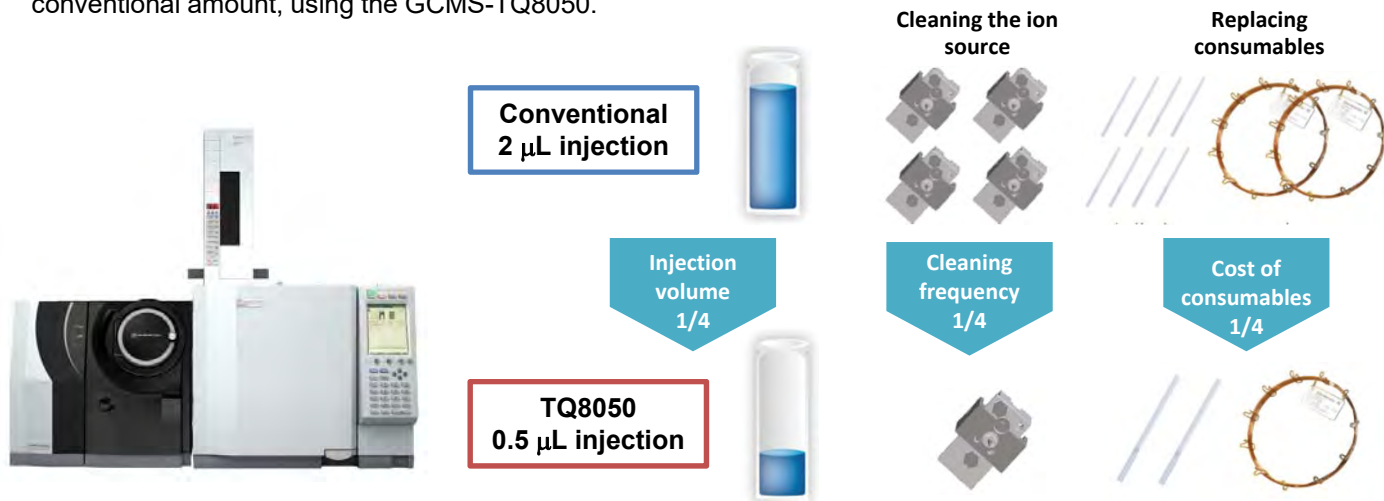

Fig. 1: GCMS-TQ8050, a High-Sensitivity GC-MS/MS

Fig. 2: Reduced Maintenance Frequency Due to Reduced Injection Volume

Experiment

As the standard samples, pesticide standard mixed solutions (Hayashi Pure Chemical Ind. Ltd. PL2005 Pesticides GC/MS Mix I, II, III, IV, V, VI, and 7) were prepared to achieve final concentrations between 5 ng/mL and 100 ng/mL. At this point, as a virtual matrix, polyethylene glycol 300 was added to ensure a concentration of 200 µg/mL. In addition, as an actual sample for the spike recovery test, the pesticide standard mixed solution was spiked with a tomato extract solution to ensure a concentration of 10 ng/mL.

Smart Pesticides Database Ver. 2 was used to create the analytical method. In this experiment, in order to reduce the injection volume, the analysis was performed with a 0.5 µL injection using a 5 µL syringe.

Table 1 Analytical Conditions

GC-MS:	GCMS-TQ8050	MS	
Column:	SH-Rxi®-5Sil MS (30 m long, 0.25 mm I.D., df = 0.25 µm) (Shimadzu GLC, P/N 221-75954-30)	Interface Temp.:	250 °C
Glass Insert:	Topaz single taper with wool (Shimadzu GLC, P/N 23336)	Ion Source Temp.:	230 °C
Syringe for Injection:	AOC-20i 5 µL syringe (Shimadzu GLC, P/N: 221-75173)	Ionization Method:	EI
		Measurement Mode:	MRM
GC			
Injection Port Temp.:	250 °C		
Column Oven Temp.:	50 °C (1 min) → (25 °C /min) → 125 °C → (10 °C /min) → 300 °C (15 min)		
Injection Mode:	Splitless		
High-Pressure Injection:	250 kPa (1.5 min)		
Injection Volume:	0.5 µL		
Carrier Gas Control:	Linear velocity (47.2 cm/sec)		

Analysis Results

The injection volume was reduced to 1/4 the conventional amount, and a 5 ng/mL standard sample was analyzed repeatedly (N = 5). Both sensitivity and repeated analysis accuracy were confirmed. Fig. 3 shows the distribution of area repeatability for a total of 387 components. Favorable results were obtained, with a %RSD of 10 % or less for 95 % of the components, and 20 % or less for 98 % of the components.

In addition, pesticides were spiked to the actual tomato sample, and the quantified values in the actual sample were confirmed. Fig. 4 shows the distribution of the recovery rates calculated from these quantitative results, and Fig. 5 shows typical pesticide chromatograms. For approximately 80 % of the components, a favorable recovery rate between 70 % and 120 % was obtained.

From these results, it is evident that using the high-sensitivity GC-MS/MS, sufficient quantitative accuracy can be obtained even at low concentrations, even when the injection volume is reduced. Reducing the injection volume reduces the frequency of instrument maintenance, enabling more efficient operation.

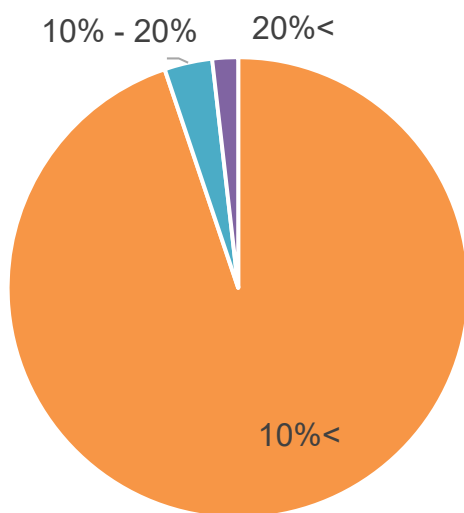

Fig. 3: Distribution of Area Repeatability (%RSD) for a 5 ppb Pesticide Standard Sample

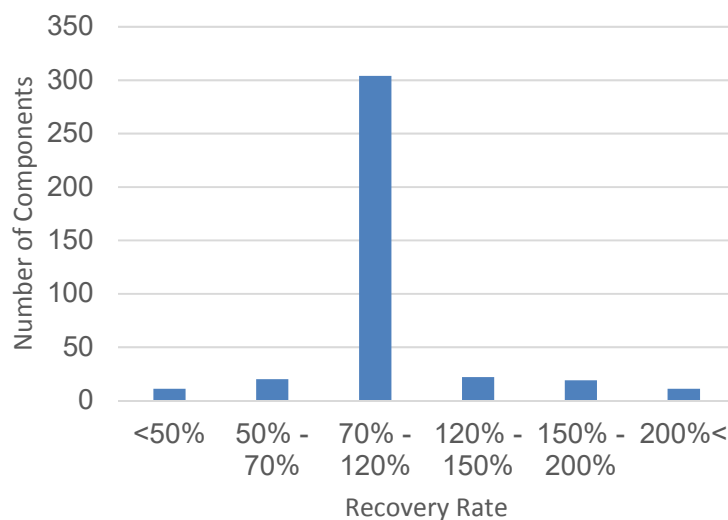
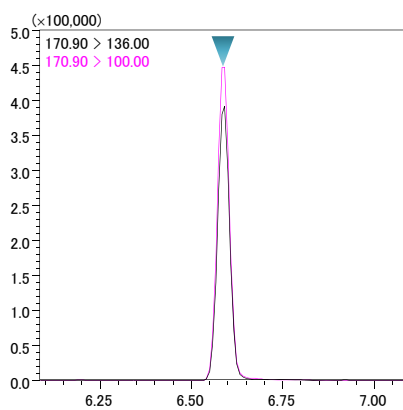
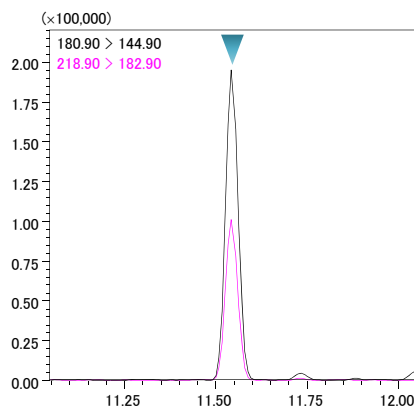

Fig. 4: Distribution of Spike Recovery Rates for an Actual Tomato Sample



Dichlobenil



delta-BHC

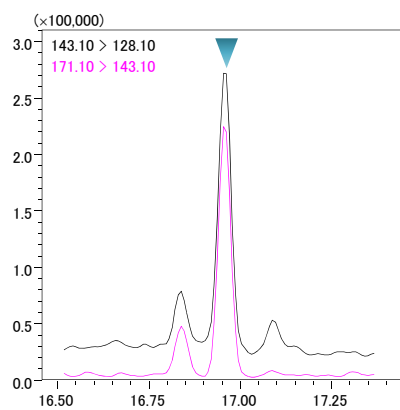

Resmethrin-1, 2

Fig. 5: Typical Chromatograms for Pesticides in an Actual Tomato Sample

First Edition: March, 2018



Shimadzu Corporation

www.shimadzu.com/an/

For Research Use Only. Not for use in diagnostic procedures.

This publication may contain references to products that are not available in your country. Please contact us to check the availability of these products in your country.

The content of this publication shall not be reproduced, altered or sold for any commercial purpose without the written approval of Shimadzu. Company names, products/service names and logos used in this publication are trademarks and trade names of Shimadzu Corporation, its subsidiaries or its affiliates, whether or not they are used with trademark symbol "TM" or "®".

Third-party trademarks and trade names may be used in this publication to refer to either the entities or their products/services, whether or not they are used with trademark symbol "TM" or "®".

Shimadzu disclaims any proprietary interest in trademarks and trade names other than its own.

The information contained herein is provided to you "as is" without warranty of any kind including without limitation warranties as to its accuracy or completeness. Shimadzu does not assume any responsibility or liability for any damage, whether direct or indirect, relating to the use of this publication. This publication is based upon the information available to Shimadzu on or before the date of publication, and subject to change without notice.

Application News

No. C162

Liquid Chromatograph Mass Spectrometry

Quantitative Analysis of Highly Polar Pesticides in Food Using SFC/MS

Since achieving sufficient retention and favorable separation in normal batch analysis of highly polar pesticides has proved difficult due to their chemical characteristics, a number of individual analysis methods are employed for LC/MS/MS analysis. To rectify this situation, EURL-SRM (Stuttgart, Germany), an EU Reference Laboratories member in charge of individual analysis method development, is developing a batch analysis method called "QuPpe (Quick Polar Pesticides)" for highly polar pesticides that are difficult to analyze using pretreatment with the QuEChERS method as well as normal batch analysis methods. This method proposes multiple methods to suit each sample and target chemical compound (M. Anastassiades et al; QuPpe of EURL-SRM (Version 9.1; 2016)).

Until now, analysis of highly polar pesticides using LC/MS/MS has used a variety of separation methods including HILIC mode, mixed mode, normal phase, and reversed phase. However, all of these methods have restrictions on the chemical compounds that can be analyzed together and this remains a problem. On the contrary, supercritical fluid chromatography (SFC) has the advantage of being able to separate a wide array of chemical compounds at once due to the characteristics of the mobile phase that is used. In addition, since the separation behavior with SFC differs from that with LC even when using a column of the same separation mode, SFC may be effective for the analyses of chemical compounds for which retention and separation are difficult in LC. This article introduces an example of batch analysis of highly polar pesticides using SFC.

Y. Fujito, D. Baker, A. Barnes, C. Titman, J. Horner, N. Loftus

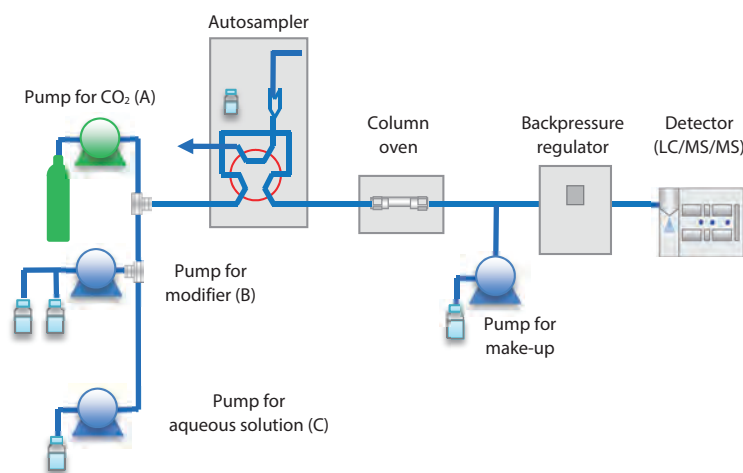

Fig. 1 SFC/MS System Configuration Diagram

In this experiment, an examination of adding a small amount of water to a modifier was performed for the purpose of eluting and separating highly polar pesticides. In order to simplify this examination, a low-pressure gradient pump (LPG) was used as pump B and the modifier was automatically prepared by mobile phase blending.

Table 1 SFC/MS Analysis Conditions

Supercritical fluid chromatography		Mass spectrometry	
SFC	Nexera UC system	LC-MS/MS	LCMS-8060
Analytical column	Restek Ultra Silica (150 × 2.1 mm 3 μm)	Ionisation mode	Heated ESI
Column temperature	50 °C	Scan speed	15,000 u/sec
Flow rate	0.8 mL/min (0.6 mL/min 13-22 min)	MRM Dwell time	3 msec
Pump A	CO ₂	Pause time	1 msec
Pump B (modifier solvent)	Acetonitrile + 0.5 % formic acid + 10 mM ammonium formate	Interface temp.	300 °C
Pump C (modifier solvent)	Water + 0.5 % formic acid + 10 mM ammonium formate	Heating block	350 °C
Pump D (make up solvent)	Methanol	Desolvation line	250 °C
Makeup solvent flow rate	0.2 mL/min		

Examination of SFC Separation Conditions

Normally, SFC performs gradient separation using supercritical carbon dioxide and an organic solvent (such as methanol and acetonitrile), which is referred to as a modifier. However, some highly polar chemical compounds exhibit strong retention in columns resulting in cases where separation and elution is insufficient even with 100% organic solvent. In this experiment, since a number of highly polar pesticides could not be eluted with 100% organic solvent, separation was examined by adding a small amount of water to the modifier.

Supercritical carbon dioxide has low polarity and low miscibility with water. This means that only a limited amount of water can be added to the modifier (normally about 0.1 to 10%). We therefore examined separation behavior by adding water by the amount equivalent to 0.2, 4, 6, 8, and 10% to the modifier. Through examination based on the peak profiles and separation patterns of the eluted components, we adopted a water content of 6%. However, there were chemical compounds that could not be eluted even with this condition.

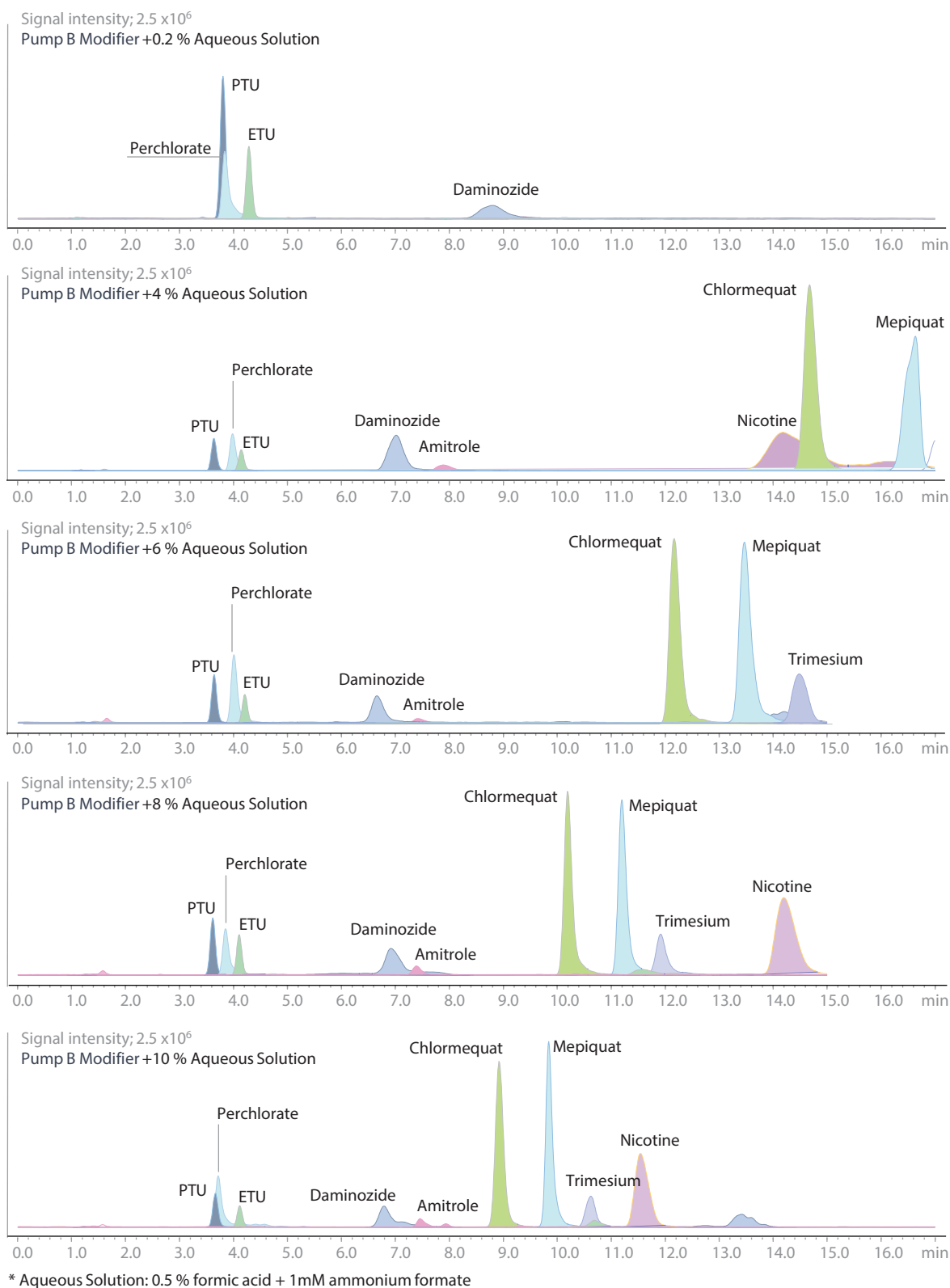

Fig. 2 Effect of Water on Separation Behavior of Highly Polar Pesticides in SFC/MS

■ Optimization of SFC Separation Conditions

When we examined addition of water to the modifier, we were able to confirm elution of most chemical compounds with the 6% aqueous solution. However, nicotine and kasugamycine, which both exhibit strong retention, could not be eluted. Any further addition of aqueous solution in the presence of carbon dioxide adversely affects gradient accuracy and may impair the stability of the analysis method. For this reason, aqueous solution was added using a separate pump (pump C) after the modifier reached 100% (Fig. 4).

This allowed elution of the remaining highly polar pesticides and enabled batch separation of the highly polar pesticides from logP-3.47 to 1.96.

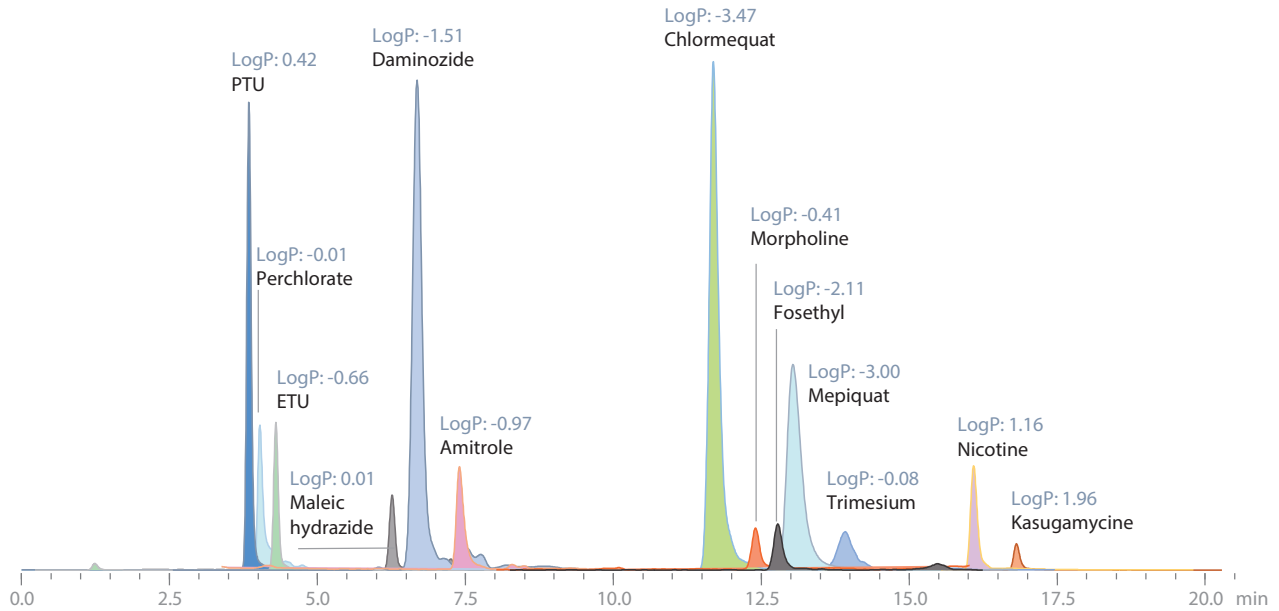
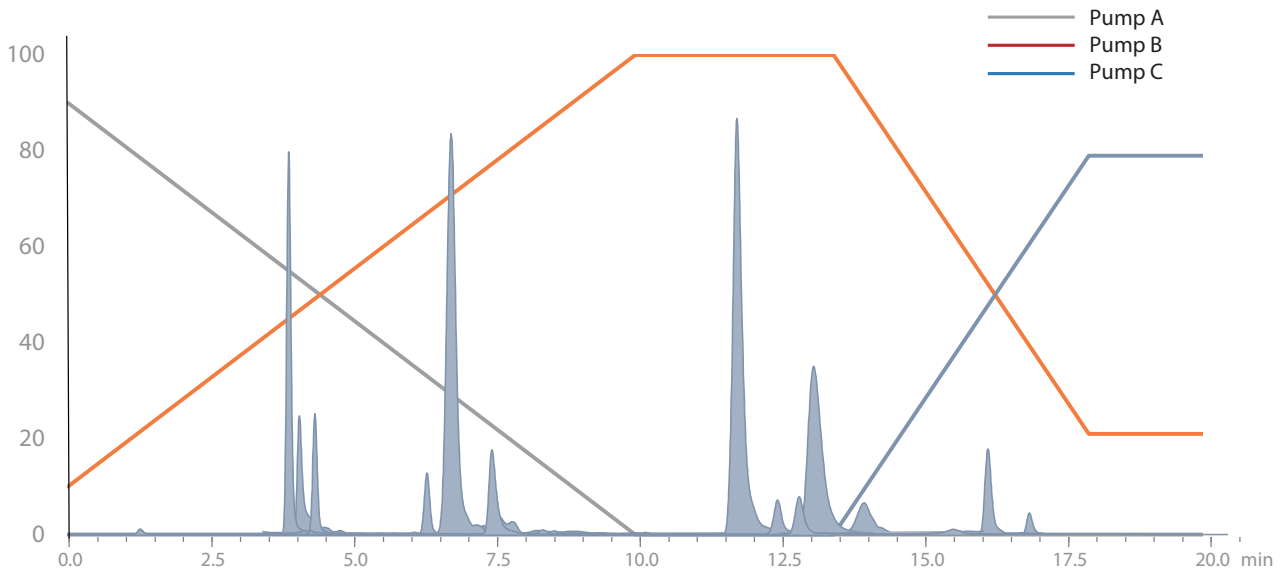

Fig. 3 MRM Chromatogram of Highly Polar Pesticides Using SFC-MS
(Addition of 200 ppb Pesticide Standard Solution into Flaxseed Extract Using QuPPE)



The initial SFC/MS conditions;

Pump A 90% : Carbon Dioxide

Pump B 10% : 6% Water in Acetonitrile containing 0.5% formic acid and 10 mM ammonium formate

Pump C 0% : Aqueous solution containing 0.5% formic acid + 10 mM ammonium formate

Fig. 4 Ternary Gradient Program

Sample Preparation and Analysis

Flaxseed and lemon were used as food samples and extraction was performed using a method compliant with QuPPE. (The extracts were provided by Concept Life Sciences, a contract analytical laboratory located in the U.K.) Standard solution of highly polar pesticides was added to these matrix solutions, which were then directly injected into the SFC-MS/MS.

Quantitative Analysis of Highly Polar Pesticides

In order to verify the quantitative performance of the developed SFC/MS analysis method, matrix calibration curves were created using each food extract to which standard solution of the highly polar pesticides was added. The calibration curve range was 10 to 200 ppb and accuracy was verified using the internal standard method regarding components for which an internal standard substance labeled with a stable isotope was obtained.

The calibration curve created for each sample showed favorable linearity for all chemical compounds regardless of the sample matrix.

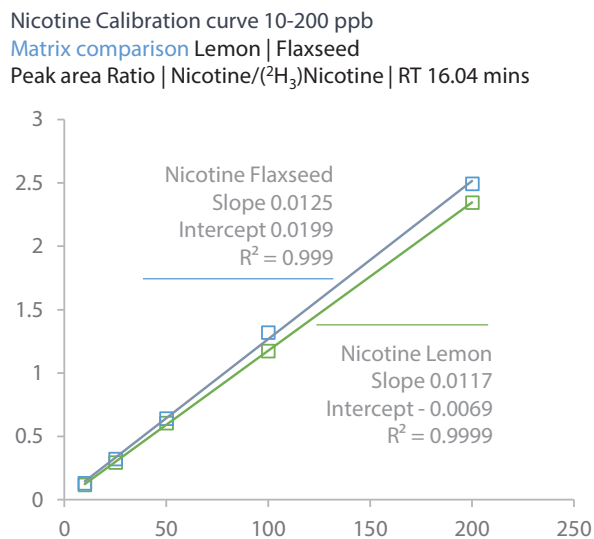
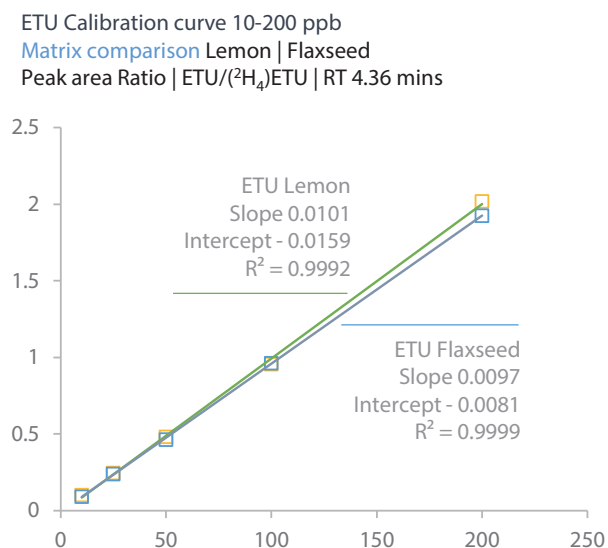

Fig. 5 Matrix Calibration Curves of Representative Highly Polar Pesticides (ETU: fast eluting compound, Nicotine: slow eluting compound, Samples: lemon, flaxseed)

Table 2 Calibration Curve Linearity and Repeatability at 100 ppb of Eight Highly Polar Pesticide Components

Compound	RT (min)	Internal Standard	IS RT (min)	Quan MRM	%RSD 100ppb	R ²
Perchlorate	3.95	¹⁸ O ₄ Perchlorate	3.91	99.00 > 82.90	4.98	0.968
ETU	4.36	² H ₄ ETU	4.26	103.10 > 44.05	4.84	0.999
Maleic hydrazide	6.28	² H ₂ Maleic hydrazide	6.28	113.00 > 67.10	6.81	0.997
Chlormequat	11.58	² H ₄ Chlormequat	11.54	121.90 > 58.10	1.75	1.000
Fosethyl	12.50	² H ₁₅ Fosethyl	12.50	109.00 > 80.95	6.78	0.999
Morpholine	12.19	² H ₈ Morpholine	12.23	87.90 > 70.05	10.74	0.996
Mepiquat	12.72	² H ₃ Mepiquat	12.69	114.30 > 98.10	7.66	0.998
Nicotine	16.06	² H ₃ Nicotine	16.03	163.00 > 130.00	2.31	0.999

First Edition: Nov. 2017



For Research Use Only. Not for use in diagnostic procedure.

This publication may contain references to products that are not available in your country. Please contact us to check the availability of these products in your country.

The content of this publication shall not be reproduced, altered or sold for any commercial purpose without the written approval of Shimadzu. Shimadzu disclaims any proprietary interest in trademarks and trade names used in this publication other than its own. See <http://www.shimadzu.com/about/trademarks/index.html> for details.

The information contained herein is provided to you "as is" without warranty of any kind including without limitation warranties as to its accuracy or completeness. Shimadzu does not assume any responsibility or liability for any damage, whether direct or indirect, relating to the use of this publication. This publication is based upon the information available to Shimadzu on or before the date of publication, and subject to change without notice.

Shimadzu Corporation

www.shimadzu.com/an/

Application News

No.L512

High Performance Liquid Chromatography

Analysis of Mycotoxins in Grain Using Mycotoxin Screening System

Mycotoxins are chemical products produced by organisms in the fungus kingdom and are toxic to humans, animals, and crops. As an example, aflatoxins are a type of mycotoxin that are some of the most carcinogenic naturally occurring substances in the world. They are classified as Group 1 carcinogens (carcinogenic to humans) by the WHO International Agency for Research on Cancer (IARC), and subject to strict regulations in many countries and regions of the world.

This Application News describes the screening analysis for mycotoxins in grain products (soft wheat flour and rice flour) using the i-Series Solution Package mycotoxin screening system.

■ i-Series Solution Package Mycotoxin Screening System

The screening system comprises a compact and easy to use integrated i-Series HPLC system together with analysis methods including sample pretreatment methods. The system comes ready to use and capable of data acquisition and analysis, including columns and method files designed for mycotoxin analysis, an instruction manual with analysis methods, and report templates. For screening applications, the system can determine whether mycotoxin levels in food are in excess of reference levels.

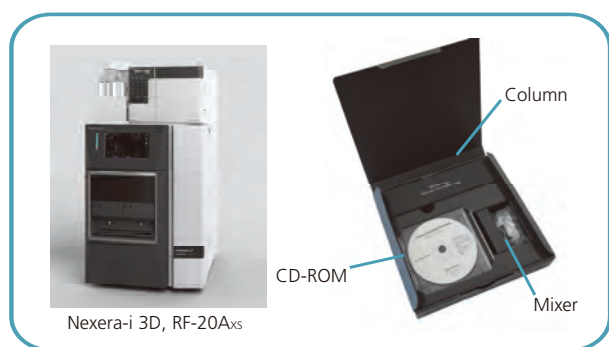

Fig. 1 Mycotoxin Screening System

Currently, HPLC and LC/MS are the most common techniques used to identify aflatoxins in food. With HPLC, fluorescent derivatization is often performed to improve sensitivity, though disadvantages of derivatization procedures are the time required and their complexity. Meanwhile, though LC/MS is more selective in terms of sensitivity, major financial investment into system is required.

The i-Series Solution Package comes with a built-in PDA detector, and can be further enhanced with an RF-20Axs fluorescence detector that offers world-class sensitivity. The package can also detect aflatoxins directly without derivatization.

■ Analysis of a Standard Solution

Mycotoxin targets of the screening system are shown in Table 1, chemical structures of some of these targets are shown in Fig. 2, and analytical conditions are shown in Table 2. The package includes analysis method files that eliminate the need to configure analytical conditions. An RF-20Axs was used to perform analysis with on-time excitation wavelength/emission wavelength switching.

Table 1 Screening Target Compounds

	Mycotoxin	Abbreviation	Matrix
1	Aflatoxin M ₁	AFM ₁	Milk
2	Aflatoxin G ₂	AFG ₂	Grain
3	Aflatoxin G ₁	AFG ₁	
4	Aflatoxin B ₂	AFB ₂	
5	Aflatoxin B ₁	AFB ₁	
6	Zearalenone	ZON	
7	Ochratoxin A	OTA	
8	Nivalenol	NIV	
9	Deoxynivalenol	DON	Apple
10	Patulin	PAT	

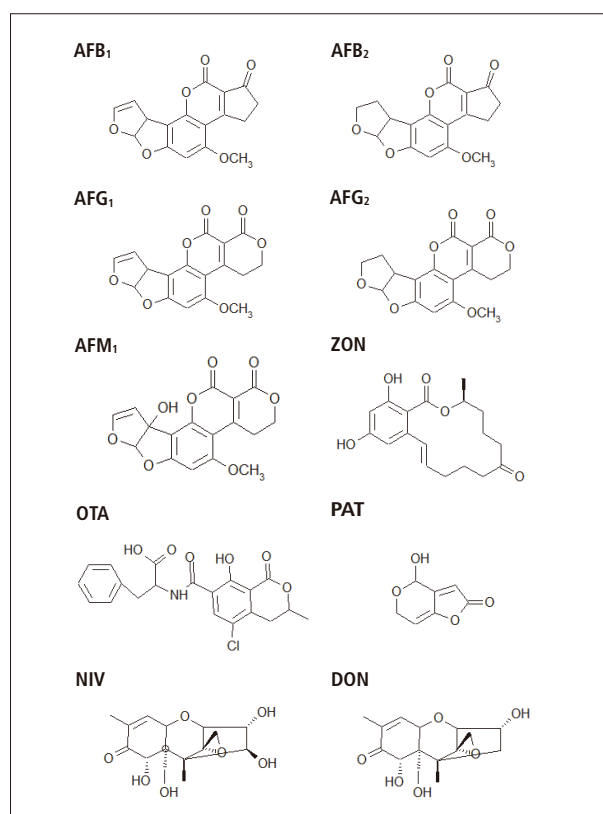

Fig. 2 Target Mycotoxin Structures

Table 2 Analytical Conditions

System	: Nexera-i 3D, RF-20Axs
Column	: Shim-pack GIST C18 (75 mm L. x 3.0 mm I.D., 2 µm)
Mobile Phase	: A) 20 mmol/L (Sodium) phosphate buffer (pH 2.5) B) Acetonitrile C) Methanol (Gradient elution)
Flowrate	: 1.0 mL/min
Column Temp.	: 55 °C
Injection Vol.	: 10 µL
Detection (RF-20Axs)	: AFB ₁ , AFB ₂ , AFG ₁ , AFG ₂ , AFM ₁ : Ex 365 nm, Em 450 nm : OTA, ZON : Ex 320 nm, Em 465 nm
Detection (Nexera-i 3D)	: NIV, DON : 220 nm (ch 1) : PAT : 276 nm (ch 2)

Although regulatory limits for mycotoxin levels in food can vary by country and region, the screening system is compatible with the strictest regulatory limits that are found in the EU (excluding regulatory limits in baby food). Chromatograms of a standard mixture with mycotoxin levels equivalent to EU reference levels¹⁾ is shown in Fig. 3.

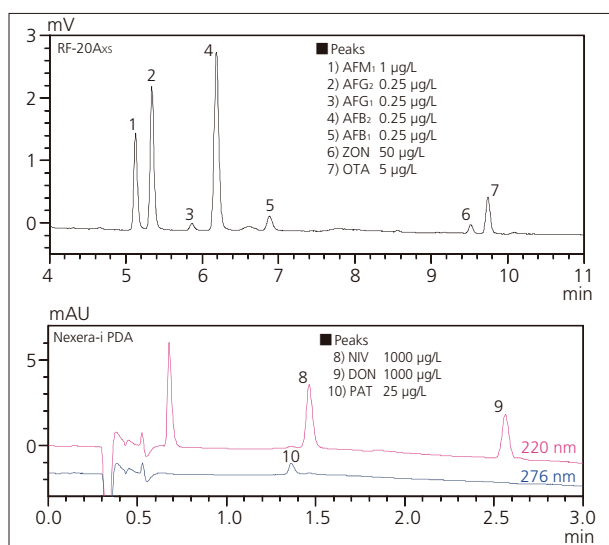

Fig. 3 Chromatograms of a Standard Mixture

■ Analysis of Mycotoxins in Grain

This section describes an analysis of milled grains after pretreatment. Fig. 4 shows an overview of the sample pretreatment method. Further details can be found in the mycotoxin screening system instruction manual. Chromatograms of pretreated samples of soft wheat flour and rice flour and of pretreated samples of soft wheat flour and rice flour spiked with a standard mixture of mycotoxins that are produced in grains (shown among the screening target compounds listed in Table 1) are shown in Fig. 5 and Fig. 6.

Comparing the area of each peak in the standard mixture that contains mycotoxins at EU reference levels and each peak in the flour samples allows identification of whether the mycotoxins present in flour samples are in excess and violation of reference levels. The system makes this determination without the need for complex analysis of results by the user, allowing for easy screening of target compounds.

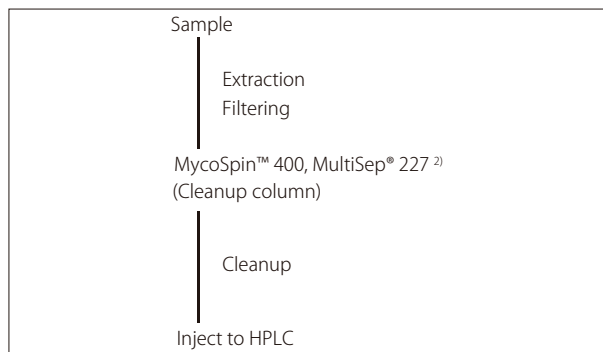

Fig. 4 Sample Pretreatment

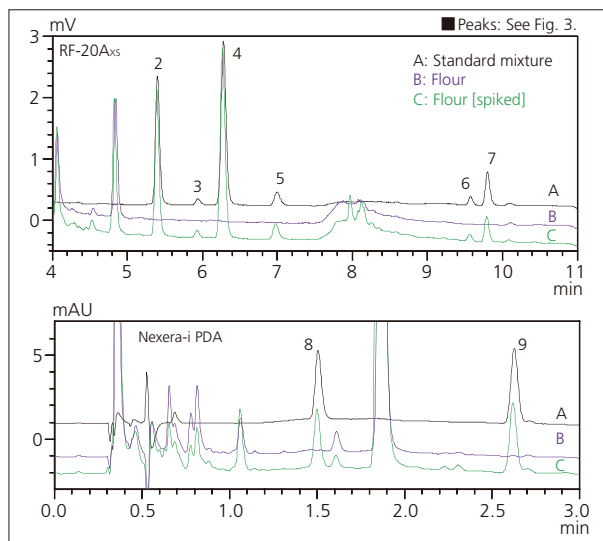

Fig. 5 Chromatograms of Soft Wheat Flour

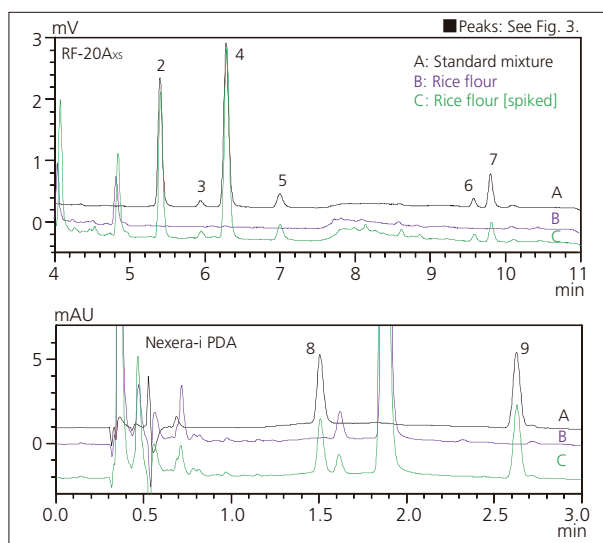

Fig. 6 Chromatograms of Rice Flour

Footnotes

- 1) Converted concentrations in the standard mixture were obtained according to a pretreatment method described in the i-Series Solution Package Mycotoxin Screening System instruction manual.
- 2) MycoSpin™ 400 and MultiSep® 227 are registered trademarks of Romer Labs.

Improved Detection of Pesticide Residues in Botanicals by LCMS

ASMS 2018

Jeffrey H. Dahl and Tairo Ogura
Shimadzu Scientific Instruments, Columbia Maryland

Improved Detection of Pesticide Residues in Botanicals by LCMS

Introduction

Pesticides and other chemicals are used in the production of many agricultural products, including botanicals for use as dietary supplements. Supplements are widely used but their raw materials, often sourced from remote locations, are subjected to fewer regulatory controls than staple foods. To ensure quality the US FDA requires identity and

quality testing, but most botanicals do not have specific regulations. To analyze complex botanicals for residual chemicals such as pesticides, LC-MS-MS is needed for high sensitivity, high confidence results. We developed an LCMS method with improved detection sensitivity for chemical residues in botanicals.

Photo credits: Echinacea, Giancarlo Dessi; Cayenne, H. Zell; Valerian, Lairich Rig; Ginseng, National Institute of Korean Language; Tumeric, Simon A. Eugster; Passionflower, Bob Peterson; St Johns Wort, Glyn Baker. All photos obtained through wikimedia commons under creative commons attribution-share alike 2.0 or higher



Echinacea E. purpurea



Cayenne Capsicum annuum



Valerian Valeriana officinalis



Passionflower (tea) Passiflora sp.



Turmeric Curcuma Longa



Korean Ginseng Panax ginseng



St. Johns Wort Hypericum perforatum

Figure 1 A selection of popular dietary supplements tested. Various parts of the above-pictured plants may be used in actual dietary supplement formulations.

Improved Detection of Pesticide Residues in Botanicals by LCMS

Method

Representative samples of powdered botanicals were removed from their gelatin capsules, homogenized and extracted with acetonitrile accompanied by shaking and sonication. Samples were additionally cleaned up using dispersive solid phase extraction to remove unwanted matrix components. Analysis was carried out by LC-MS-MS

using a triple quadrupole mass spectrometer. The mass spectrometer interface parameters were carefully adjusted to improve the signal for the majority of the analytes. Spiking experiments were used to determine recovery and matrix-matched standards were used to prepare calibration curves.

Table 1 Instrument parameters used for analysis

LC Column	: Raptor ARC18 (2.1×150 mm, 2.7 μm)
Mobile Phase A	: 0.1% Formic Acid with 5 mM Am. Formate
Mobile Phase B	: Methanol
Flow Rate	: 0.5 mL/min
Probe Voltage	: +0.5 kV or -0.5kV
Interface Temp	: 100 °C
Nebulizing Gas	: 3 L/min
Drying Gas	: 10 L/min
DL Temp	: 100 °C
Heat Block Temp	: 100 °C

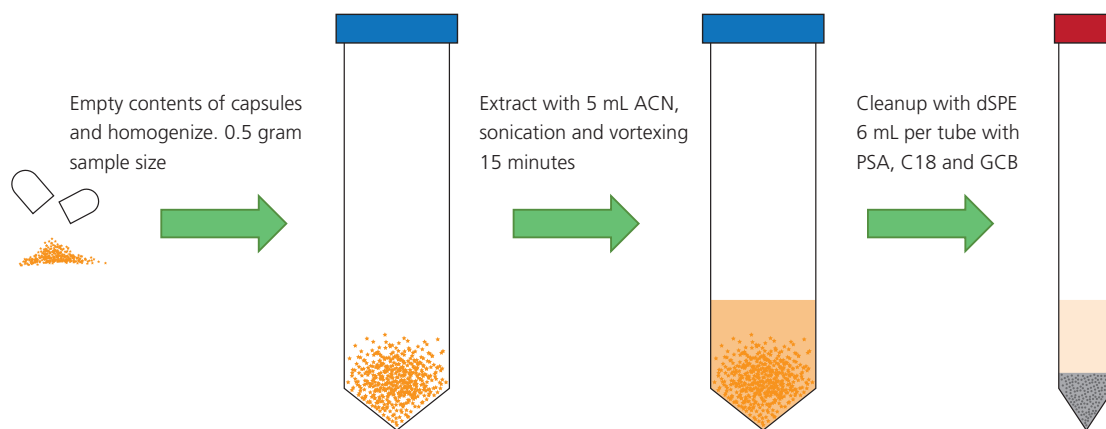

Figure 2 Sample preparation of botanicals for LC-MS analysis

Results and Discussion

Eight popular botanical supplements were selected for testing, including Cayenne, Valerian, Passionflower tea, Korean Ginseng, St. John's Wort, Tumeric and two varieties of Echinacea. The Tea and Echinacea variety 1 were labeled as organic, while the other supplements were not labeled as organic. For each sample, a single-point standard addition sample at 500 ng/g dried material was prepared in addition to check matrix-specific effects. Compared with a conventional method, we found significant improvement in instrument response for many

analytes by careful adjustment of interface temperature and spray voltage. For quantitation, matrix matched calibration curves were linear within the quantitation limits established for each compound, which was compound dependent. Detection limits and quantitation limits were required to have 3:1 and 10:1 signal to noise respectively, and quantitation limits were required to have less than 20% RSD in triplicate injections. Using our newly developed method, we are able to characterize the extent of residual pesticides t in popular botanicals.

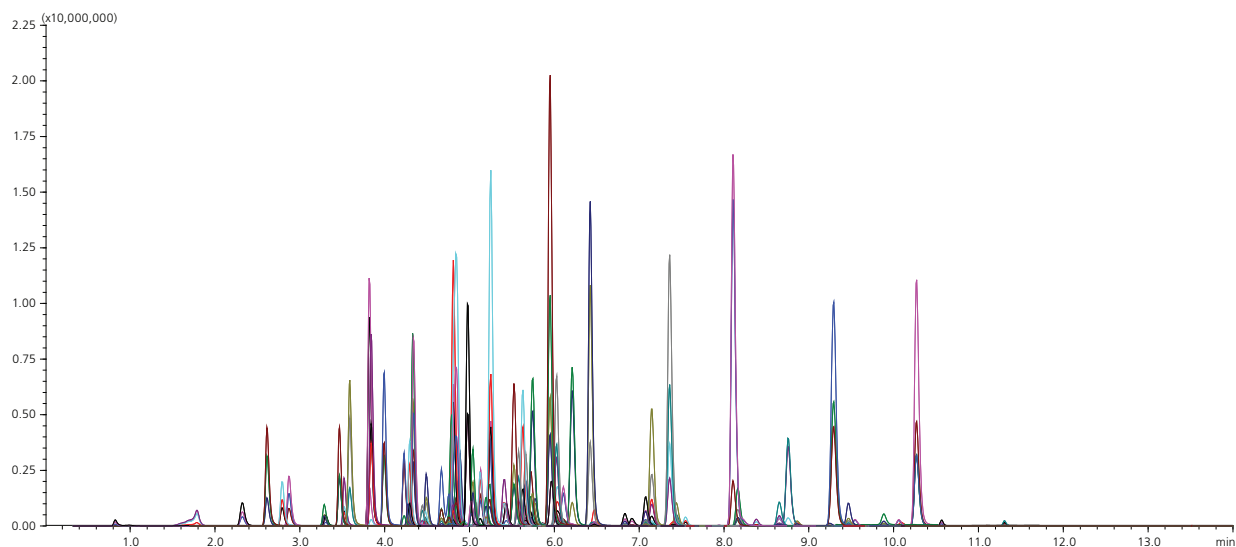

Figure 3 Representative chromatogram of pesticides spiked into a sample of Korean Ginseng at the 500 ng/g of dried material level.

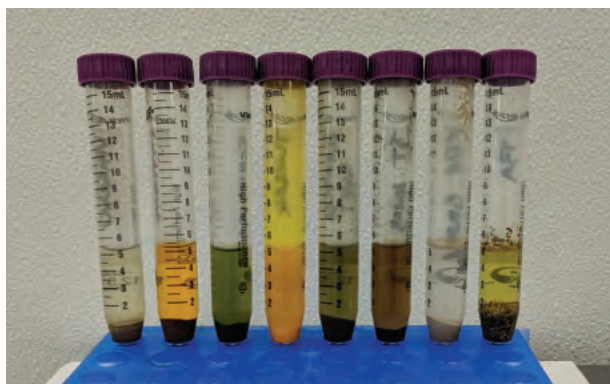

Figure 4 Acetonitrile extracts (before dSPE cleanup) of various botanicals. From left: Valerian, Cayenne, Echinacea-1, Tumeric, Echinacea-2, St. John's Wort, Korean Ginseng, and Passionflower Tea.

Improved Detection of Pesticide Residues in Botanicals by LCMS

Table 2 Chemical residues detected in botanical extracts. Values reported in ng/g dry material.

	Cayenne	Echinacea-1	Echinacea-2	Korean Ginseng	St. John's Wort	Passionflower tea	Tumeric	Valerian root
Azoxystrobin	15	ND	ND	7	ND	ND	ND	ND
Carbaryl	ND	ND	ND	ND	ND	35	ND	ND
Carbofuran	3.7	ND	ND	ND	ND	ND	ND	ND
Chlorpyrifos	ND	ND	ND	ND	ND	ND	9.4	ND
Cypermethrin	140	ND	ND	ND	ND	ND	ND	ND
Dimethomorph	ND	ND	ND	36	ND	ND	ND	ND
Imidacloprid	11	ND	ND	ND	ND	ND	ND	ND
Metalaxyl	ND	ND	ND	ND	ND	ND	8.3	ND
Methoprene	196	ND	ND	ND	ND	ND	ND	ND
Novaluron	24	ND	ND	ND	ND	ND	ND	ND
Propiconazole	ND	ND	ND	24	ND	ND	ND	ND
Pyraclastrobin	6.5	ND	ND	ND	ND	ND	ND	ND
Tebuconazole	59	ND	ND	4.8	ND	ND	ND	ND
Trifloxystrobin	10	ND	ND	ND	ND	ND	ND	ND

Table 3 List of compounds measured and limits of quantitation in ng/g.

Abamectin	30	Daminozide	15	Hexythiazox	15	Propiconazole	60
Acephate	5	Deltamethrin	30	Imazalil	10	Propoxur	2
Acequinocyl	60	Diazinon	<2	Imidacloprid	4	Pyraclastrobin	10
Acetamiprid	<2	Dichlorvos	15	Kresoxim-methyl	4	Pyrethrin I	100
Aldicarb	<2	Dimethoate	<2	Malathion	2	Pyridaben	2
Allethrin	50	Dimethomorph	5	Metalaxyl	2	Resmethrin	35
Azoxystrobin	4	Dinotefuran	2	Methiocarb	4	Spinetoram	2
Bifenazate	2	Dodemorph	4	Methomyl	<2	Spinosad	<2
Bifenthrin	4	Endosulfan-sulfate	4	Methoprene	50	Spirodiclofen	10
Boscalid	4	Ethoprophos	2	Mevinphos	4	Spiromesifen	20
Buprofezin	<2	Etofenprox	4	MGK-264	500	Spirotetramat	2
Carbaryl	10	Etoxazole	<2	Myclobutanil	10	Spiroxamine	2
Carbofuran	<2	Fenhexamid	20	Naled	2	Tebuconazole	2
Chlorantraniliprole	2	Fenoxycarb	2	Novaluron	15	Tebufenozide	5
Chlorpyrifos	10	Fenpyroximate	10	Oxamyl	2	Teflubenzuron	15
Clofentazine	4	Fensulfothion	5	Paclobutrazol	2	Tetrachlorvinphos	4
Clothianidin	4	Fenthion	10	Permethrin	10	Tetramethrin	4
Coumaphos	4	Fenvalerate	100	Phenothrin	10	Thiacloprid	<2
Cyantraniliprole	2	Fipronil	2	Phosmet	10	Thiamethoxam	<2
Cyfluthrin	500	Fonicamid	25	Piperonyl butoxide	5	Thiophanate-methyl	5
Cypermethrin	60	Fludioxonil	2	Pirimicarb	2	Trifloxystrobin	<2
Cyprodinil	10	Fluopyram	2	Prallethrin	10		

Improved Detection of Pesticide Residues in Botanicals by LCMS

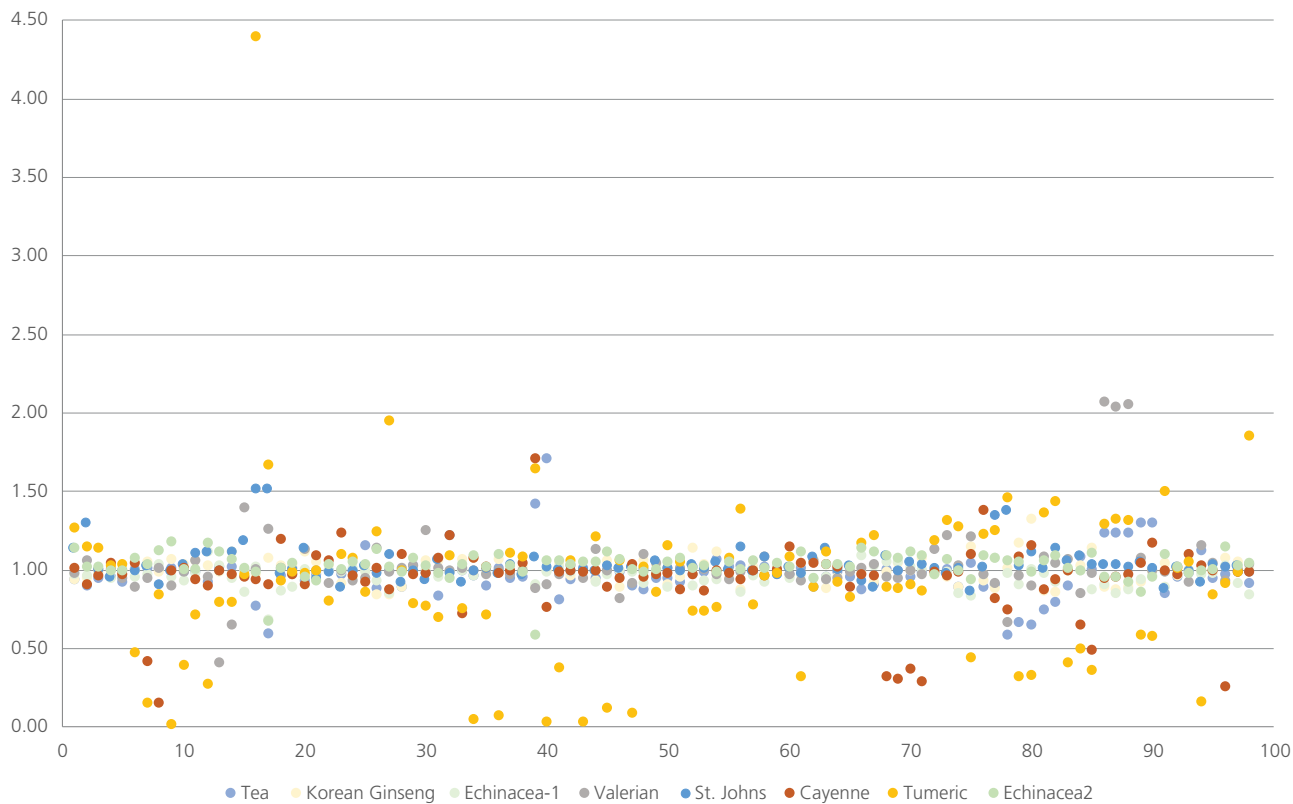

Figure 5 Recovery for each analyte in a 500 ng/g spike of each sample. Turmeric and Cayenne had the greatest number of analytes with low recovery, due to signal suppression.

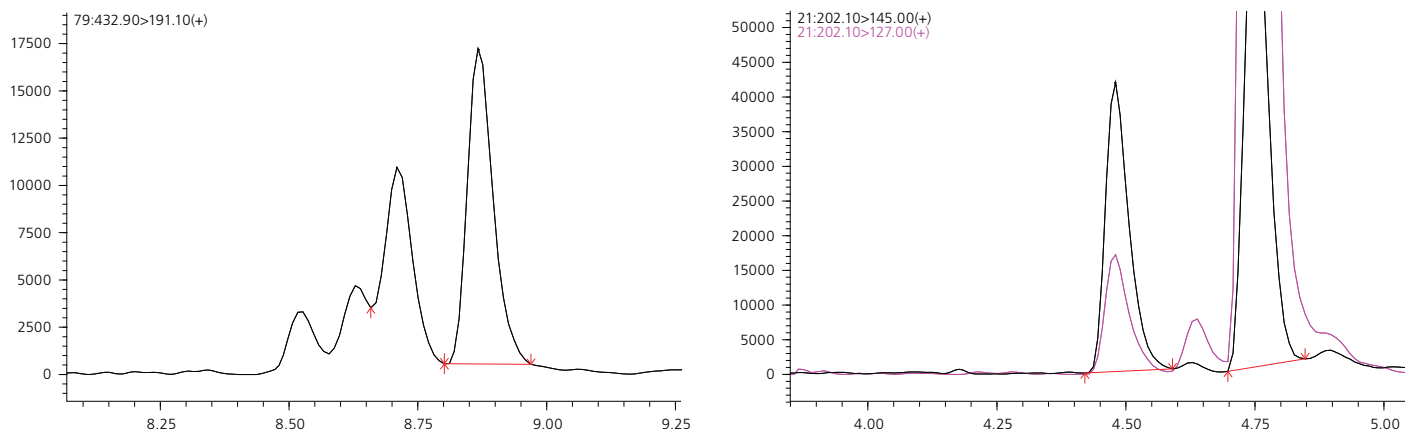

Figure 6 (Left) Cypermethrin (four isomers) detected in Cayenne sample.
(Right) Carbaryl detected in organic passionflower tea sample.

Improved Detection of Pesticide Residues in Botanicals by LCMS

Conclusion

We developed a high performance method for sensitive detection of pesticides in popular botanical supplements with a simple sample preparation and applied the method to measure pesticides in selected botanical products offered for retail sale. We found matrix effects to be minimal with the exception of Tumeric and Cayenne. For these matrices, additional sample cleanup may be useful to minimize signal suppression by the matrix.

Several pesticides were detected in some of the dietary supplements. Cayenne had the greatest number of detections and with the highest levels approaching 200 ng/g. Significantly, the Passionflower tea, which was labeled as organic, was found to contain 35 ng/g carbaryl. Our rapid, sensitive, and selective method is well-suited to high throughput detection of pesticide residues in popular botanical products.

First Edition: June, 2018



Shimadzu Corporation
www.shimadzu.com/an/

For Research Use Only. Not for use in diagnostic procedures.

This publication may contain references to products that are not available in your country. Please contact us to check the availability of these products in your country.

The content of this publication shall not be reproduced, altered or sold for any commercial purpose without the written approval of Shimadzu. Company names, products/service names and logos used in this publication are trademarks and trade names of Shimadzu Corporation, its subsidiaries or its affiliates, whether or not they are used with trademark symbol "TM" or "®".

Third-party trademarks and trade names may be used in this publication to refer to either the entities or their products/services, whether or not they are used with trademark symbol "TM" or "®".

Shimadzu disclaims any proprietary interest in trademarks and trade names other than its own.

The information contained herein is provided to you "as is" without warranty of any kind including without limitation warranties as to its accuracy or completeness. Shimadzu does not assume any responsibility or liability for any damage, whether direct or indirect, relating to the use of this publication. This publication is based upon the information available to Shimadzu on or before the date of publication, and subject to change without notice.

Fast GC-MS/MS Analysis Of Multicomponent Pesticide Residues (360) In Food Matrix

ASMS 2015 WP 053

Hendrik J. Schulte¹, Hans-Ulrich Baier¹, Stéphane Moreau¹,
Klaus Bollig²

¹ Shimadzu Europa GmbH, Duisburg, Germany;

² Shimadzu Deutschland GmbH, Duisburg, Germany

Fast GC-MS/MS Analysis Of Multicomponent Pesticide Residues (360) In Food Matrix

Introduction

Contamination of food products with pesticides is a growing concern because of recognized adverse health effects, increasing world-wide usage of pesticides, and increasing imports of raw foodstuffs from foreign sources. Consequently, the number of samples as well as monitored pesticides became significantly higher in the last decade. To handle this high sample load, a Quick, Easy and Cheap cleanup procedure called QuEChERS was established[1]. Unfortunately, samples prepared by this method contain large matrix signals which can complicate accurate pesticide quantification by MS alone. As a consequence of matrix effects in MS, tandem MS/MS instruments using multiple reaction mechanisms (MRM), have more frequently been adopted in recent years, as it increases selectivity and sensitivity. Besides matrix interference, short

analysis times are more frequently needed when handling large sample numbers in routine work. The use of narrow bore capillary columns has been shown to be a powerful tool to dramatically reduce the analysis time while maintaining chromatographic resolution in different GCMS applications[2]. In fast GC experiments typically peak width at half height (FWHM) was reduced to ~1 sec therefore requiring ultra fast scanning and polarity switching. As a result of the ultra fast GC and selectivity of tandem MS increases in laboratory efficiency can be gained in addition to reduced working costs. In this work ultra fast GC-MS/MS analysis was tested by analyzing 360 pesticides in apple QuEChERS extract in less than 10 minutes.

Methods and Materials

Sample preparation

Apple extract was used as test sample matrix. The sample matrix was extracted and subjected to cleanup using the well-established QuEChERS procedure. The calibration curve had 6-points (0.5 ppb to 100 ppb) by spiking the blank sample matrix using internal standard technique. The spiked solution contained overall 360 different pesticides and TPP as internal standard.

Table 1: GC Analytical Conditions

Instrument	: GCMS-TQ8040 (Shimadzu, Japan)
Software	: GCMSSolution 4.2 with SmartMRM and MRM Optimization Tool
Injector	: Optic-4, IP deactivated liner with glass insert
PTV Programme	: 70 °C, 15 °C/s to 280 °C, 1.2 min, 15 °C/s to 320 °C, 6 min
Split	: Splitless Injection (1.3 min)
Injection Volume	: 1 µL
Column	: 5 MS 20m, 0.18 mm, 0.18 µm
GC Oven	: 80 °C, 1 min, 35 °C/min to 210 °C, 25 °C/min to 320 °C, 2 min

Fast GC-MS/MS Analysis Of Multicomponent Pesticide Residues (360) In Food Matrix

Table 2: MS Analytical Conditions (GCMS-TQ8040)

Transfer Line	: 300 °C
Ion Source	: 200 °C
Emission Current	: 100 µA
Ionization Mode	: EI, 70 eV
Mass Resolution	: Q1 0.8 Da, Q3 at 3.0 Da (FWHM)
CID Gas	: Argon (200 kPa)
Loop Time	: 0.18 s
Acquisition Mode	: MRM
Min Dwell time per MRM	: 3 ms
Processing Window	: ±0.1 min

Sample measurement

The Shimadzu GCMS-TQ8040 equipped with the GLScience multi-mode inlet Optic-4 and an AOC-5000 Plus was used for sample measurement. MRMs and collision energies (CE) were taken from Shimadzu's SmartDB for pesticides. MRMs and CEs for pesticides missing in the database were determined by the fully automatic MRM Optimization Tool available in the latest version of

GCMSsolution (version 4.3). SmartMRM was utilized for the measurement time optimization. The algorithm guaranteed a processing time window not less than 12 seconds for each compound and a dwell time per MRM of at least 3 msec. All compounds were measured with one quantifier and one qualifier. Tables 1 & 2 provide detailed summary of analytical conditions.

Results

Figure 1 shows the full chromatogram of the measured 360 pesticides in which all compounds elute in less than 10 minutes. Moreover, a strong tendency for co-elution is evident with an accelerated GC gradient. To enable meaningful data analysis in such a highly compressed time window, the use of tandem MS triple quadrupole technology is essential.

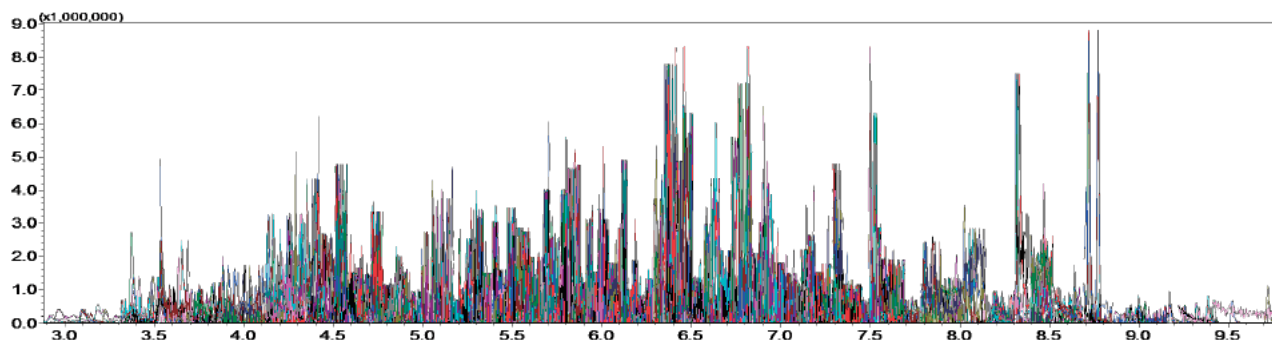

Figure 1: Chromatogram 360 Pesticides In Apple Matrix

Fast GC-MS/MS Analysis Of Multicomponent Pesticide Residues (360) In Food Matrix

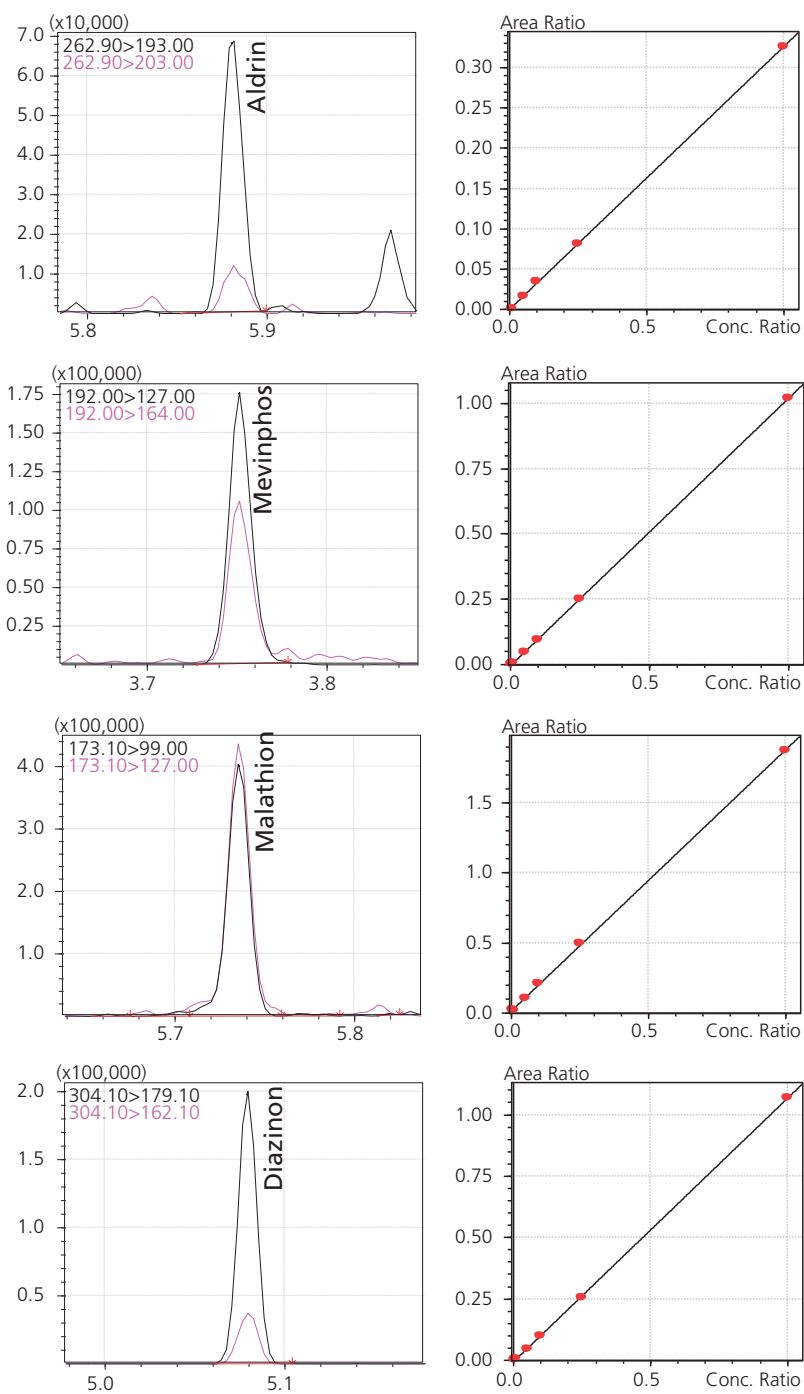

Figure 2: Calibration Curve (0.5 ppb – 100 ppb) and Peak Profile at 5 ppb (Aldrin, Malathion, Mevinphos and Diazinon)

Fast GC-MS/MS Analysis Of Multicomponent Pesticide Residues (360) In Food Matrix

Results shown in figure 1 were obtained using a 5ms 20 m, 0.18 mm, 0.18 μ m fast GC column. It is noteworthy that there are columns available, which have lower dimensions and offer even faster chromatographic results. Using fast GC columns, two main properties need to be taken into account when choosing ideal separation conditions. On the one hand the lower inner diameter and higher possible heating rates enable sharpened peaks and consequently higher S/N ratios. On the other hand the peak capacity decreases by lowering the column dimensions, which results in lower absolute sample amounts and reduced sensitivity[3]. Therefore, in this work an intermediate

column was used which provided decreased analysis time whilst maintaining high sensitivity.

Calibration curve results were therefore determined with the aforementioned intermediate column. Matrix calibration curves (0.5 ppb – 100 ppb) were measured for all 360 pesticides. The linear correlation factor was higher than 0.9980 for every compound. Nearly all components were detectable at the lowest concentration of 0.5 ppb. Figure 2 shows peak profiles and calibration curves for some typical pesticides. As already indicated by the correlation factor, linearity was very good for all compounds.

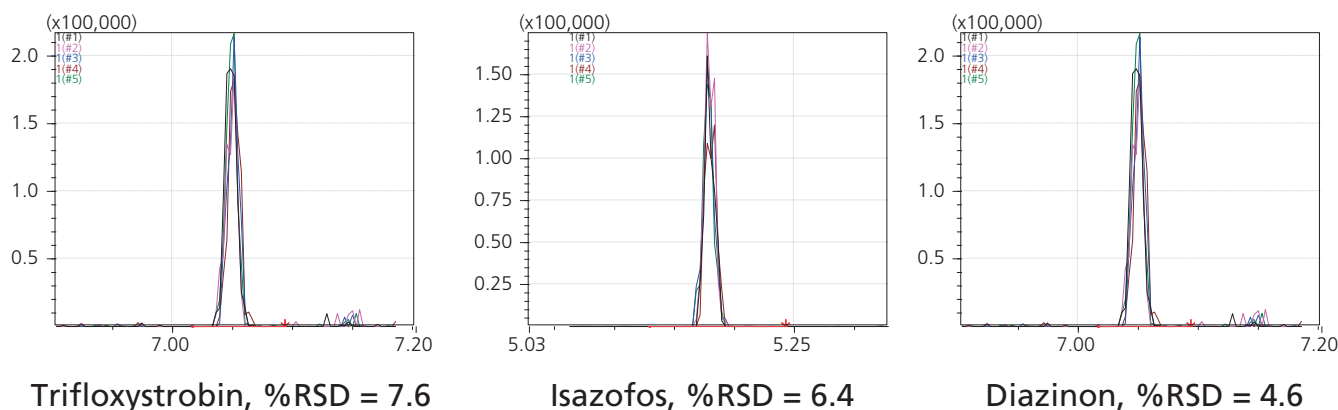

Figure 3: Superimposition of 5 unsmoothed peaks and RSD% of 3 compounds measured at 3 ms dwell time

Peak widths at half maximum (FHMW) were typically less than 1 sec using fast GC separation compared to standard GC. Furthermore, it was known that for good reproducibility, at least 10 data points per peak are needed[4]. To enable this number of data points a loop time of 0.18 s was chosen. In some parts of the chromatogram up to 30 compounds eluted in the same processing window and for each compound two transitions (1 Quantifier and 1 Quantifier) were needed. Consequently, dwell time per MRM was in some cases reduced to as short as 3 msec. Figure 3 shows

superimposed chromatograms and %RSD of three different peaks measured with a dwell time of 3 msec. It was therefore evident that %RSDs for these peaks are within acceptable limits even with such short dwell times. This degree of high precision was found for most of the compounds, and for all compounds %RSD values were below 15%. It is thought that compounds exhibiting worse precision was caused by active sites in liner or column. Therefore further optimization of the sample introduction by improved liner deactivation will help to improve %RSD for these few compounds.

Fast GC-MS/MS Analysis Of Multicomponent Pesticide Residues (360) In Food Matrix

Conclusions

This study shows the successful combination of fast GC and tandem mass spectrometry. It was possible to determine 360 pesticides spiked in a QuEChERS apple extract with excellent calibration curve linearity and good reproducibility in less than 10 minutes. The shown application can help to increase routine laboratory efficiency.

Literature

- [1] QuEChERS, European Standard, EN 15662,
- [2] Baier, H.-U. In *Practical Gas Chromatography: A Comprehensive Reference*; Dettmer-Wilde, K.; Engewald, W., Eds.; **2014**; Chapter 12; *to be published*,
- [3] Mondello, L. et al., *Journal of Chromatography A*, **2004**, *1035*, 237-247,
- [4] Mastovska, K., Lehotay, S. J.; *Journal of Chromatography A*, **2003**, *1000*, 153–180.

Application News

No. C138

Liquid Chromatography Mass Spectrometry

Multi-Residue Analysis of 18 Regulated Mycotoxins by LC/MS/MS

D. Baker¹, C. Titman¹, J. Horner², N. Loftus¹:

¹ Shimadzu UK, ² Scientific Analysis Laboratories

Mycotoxins are one of the most important contaminants in food and feed due to their widespread distribution in the environment and toxic effects on humans and animals.¹⁾ Structurally, mycotoxins are a very diverse group with a wide range of physicochemical properties and low molecular weights.²⁾ They are produced by fungi (mould) frequently found on agricultural produce, and are often not visible to the naked eye.³⁾ Some of the most commonly contaminated food stuffs include wheat, oats, rye, corn, barley, rice, nuts and milk.⁴⁾

Due to the risks posed by mycotoxins in food they are regulated globally, including, the EU, US, China, Singapore and Brazil.⁵⁾ In the EU, reporting limits are harmonised in Regulation (EC) No 1886/2006 (amended by (EC) No 1126/2007) and sampling and analysis in Regulation (EC) No 401/2006.

LC/MS/MS is the technique most commonly employed for mycotoxin quantitation in order to achieve the necessary low reporting limits in complex food and feed matrices.

Experimental

Solvent extracts were provided by Scientific Analysis Laboratories (SAL, UK) following validated extraction protocols. Samples were analysed using the Nexera UHPLC and the LCMS-8060 triple quadrupole detector (Table 1). Calibration was performed using ¹³C internal standards spiked during sample extraction. All MRM transitions and associated internal standards for each compound are listed in Table 2. All solvents used during analysis were LCMS quality from Sigma-Aldrich.

Due to the wide range of physical and chemical properties of mycotoxins, different LC/MS/MS methods are typically developed for small groups of compounds with similar properties.

In this application paper a single LC/MS/MS method has been developed for the determination of 18 mycotoxins in food safety. Limits of quantification were at or below the maximum levels set in the EC/1886/2006 document. The scope of the method included Aflatoxins (B1, B2, G1, G2), Fumonisin (B1, B2, B3), Ochratoxin A (OTA) and Trichothecenes (3-acetyldeoxynivalenol (3AcDON), 15-acetyldeoxynivalenol (15AcDON), Deoxynivalenol (DON), Diacetoxyscripanol (DAS), Fusarenon-X (FUS X), HT-2, Neosolaninol (NEO), Nivalenol (NIV), T2, Zearalenone (ZON)) with an analysis cycle time of 12.5 minutes.

Table 1 Analytical Conditions

UHPLC	: Nexera LC System
Mobile Phase	: A; Water with additives B; Methanol with additives
Column	: Reversed phase column (100 mm L x 2.1 mm I.D.)
Column Temperature	: 40 °C
Flowrate	: 0.4 mL/minute
Gradient	: B. Conc 15 % (0 min) → 25 % (1 min) → 40 % (2 min) → 41 % (4.5 min) → 100 % (7.5 - 10.0 min) → 15 % (10.10 min) → Stop (12.5 min)
LC-MS/MS	: LCMS-8060
Dwell Time	: 10 to 40 msec.
Pause Time	: 1 msec.
Ionisation Mode	: ESI +/-
Polarity Switching	: 5 msec.

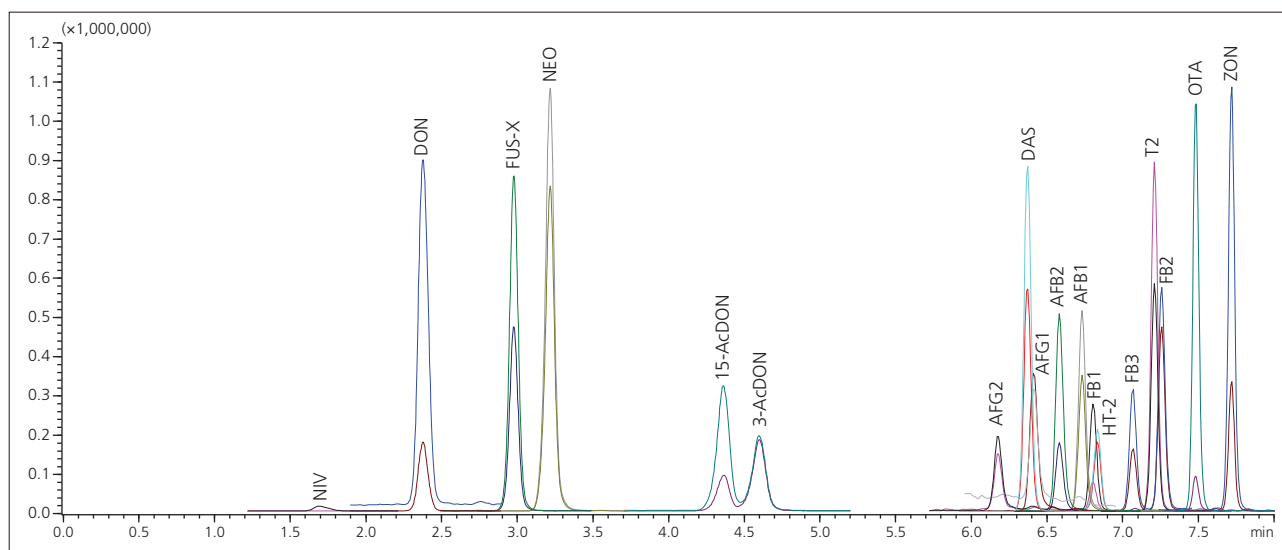

Fig. 1 MRM Chromatograms of 18 Mycotoxins

AFB1 (aflatoxin B1; 1 µg/kg), AFB2 (aflatoxin B2; 1 µg/kg), AFG1 (aflatoxin G1; 1 µg/kg), AFG2 (aflatoxin G2; 1 µg/kg), OTA (ochratoxin A; 4 µg/kg), FB1 (fumonisin B1; 100 µg/kg), FB2 (fumonisin B2; 100 µg/kg), FB3 (fumonisin B3; 100 µg/kg), 15-AcDON (15-acetyldeoxynivalenol; 100 µg/kg), 3-AcDON (3-acetyldeoxynivalenol; 100 µg/kg), DON (deoxynivalenol; 100 µg/kg), DAS (diacetoxyscripanol; 100 µg/kg), FUS-X (fusarenon-X; 100 µg/kg), HT-2 (100 µg/kg), T-2 (100 µg/kg), NEO (neosolaninol; 100 µg/kg), NIV (nivalenol; 100 µg/kg), ZON (zearalenone; 100 µg/kg).

For clarity only 2 MRM transitions are displayed per compound and the following MRM chromatograms were changed; neosolaninol (x0.3), T2 (x0.3), aflatoxins (x3), fumonisins (x2).

Table 2 All MRM's Measured in the Mycotoxin Method and Corresponding Calibration Range and R² Result

Compound name	Parent ion	Ret. Time (mins)	MRM 1	MRM 2	MRM 3	ISTD	Calibration range µg/kg	R ²
1 Aflatoxin B1	[M+H] ⁺	6.773	313 > 241	313 > 285	313 > 269	¹³ C Aflatoxin B1	0.1 - 10	0.9988
2 Aflatoxin B2	[M+H] ⁺	6.621	315 > 259	315 > 287	315 > 243	¹³ C Aflatoxin B2	0.1 - 10	0.9995
3 Aflatoxin G1	[M+H] ⁺	6.453	329 > 243	329 > 200		¹³ C Aflatoxin G1	0.1 - 10	0.9998
4 Aflatoxin G2	[M+H] ⁺	6.219	331 > 245	331 > 285		¹³ C Aflatoxin G2	0.1 - 10	0.9965
5 Ochratoxin A	[M+H] ⁺	7.509	404 > 239	404 > 221	404 > 358	¹³ C Ochratoxin A	0.4 - 40	0.9969
6 Fumonisin B1	[M+H] ⁺	6.811	722 > 352	722 > 334	722 > 704	¹³ C Aflatoxin B2	10 - 1000	0.9937
7 Fumonisin B2	[M+H] ⁺	7.260	706 > 318	706 > 354	706 > 688	¹³ C Aflatoxin B2	10 - 1000	0.9998
8 Fumonisin B3	[M+H] ⁺	7.073	706 > 318	706 > 354	706 > 688	¹³ C Aflatoxin B2	10 - 1000	0.9991
9 Deoxynivalenol	[M+H] ⁺	2.372	297 > 279	297 > 249		¹³ C Deoxynivalenol	10 - 1000	0.9992
10 Diacetoxyscirpenol	[M+NH ₄] ⁺	6.349	384 > 229	384 > 307	384 > 247	¹³ C T2 Toxin	10 - 1000	0.9994
11 T2	[M+NH ₄] ⁺	7.206	484 > 185	484 > 215	484 > 245	¹³ C T2 Toxin	10 - 1000	0.9989
12 HT-2	[M+Na] ⁺	6.822	447 > 345	447 > 285		¹³ C T2 Toxin	10 - 1000	1.0000
13 Nivalenol	[M-CH ₃ COO] ⁻	1.684	371 > 281	371 > 311		¹³ C HT-2	10 - 1000	0.9991
14 Neosolaniol	[M+NH ₄] ⁺	3.227	400 > 215	400 > 305	400 > 185	¹³ C Deoxynivalenol	10 - 1000	0.9995
15 Fusarenon X	[M+H] ⁺	2.986	355 > 247	355 > 277		¹³ C Deoxynivalenol	10 - 1000	0.9987
16 Zearalenone	[M-H] ⁻	7.711	317 > 175	317 > 131	317 > 273	¹³ C T2 Toxin	10 - 1000	0.9985
17 15-Acetyldeoxynivalenol	[M+H] ⁺	4.406	339 > 261	339 > 297		¹³ C Deoxynivalenol	10 - 1000	1.0000
18 3-Acetyldeoxynivalenol	[M+H] ⁺	4.618	339 > 261	339 > 297		¹³ C Deoxynivalenol	10 - 1000	0.9986
19 ¹³ C HT-2	[M+NH ₄] ⁺	6.844	464 > 278					
20 ¹³ C T2	[M+NH ₄] ⁺	7.228	508 > 322					
21 ¹³ C Aflatoxin B1	[M+H] ⁺	6.754	330 > 301					
22 ¹³ C Aflatoxin B2	[M+H] ⁺	6.614	332 > 303					
23 ¹³ C Aflatoxin G1	[M+H] ⁺	6.435	346 > 212					
24 ¹³ C Aflatoxin G2	[M+H] ⁺	6.219	348 > 259					
25 ¹³ C Ochratoxin A	[M+H] ⁺	7.516	424 > 250					

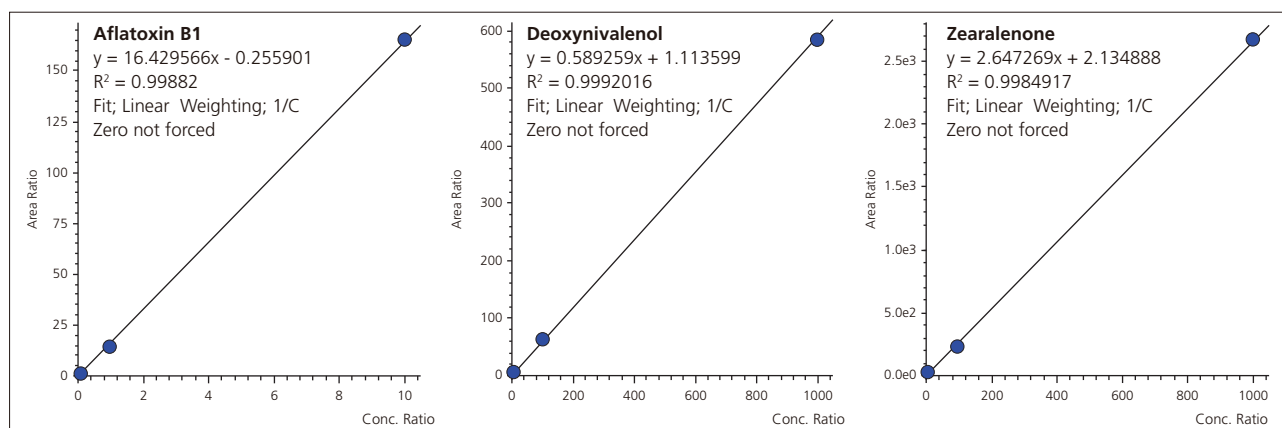

Fig. 2 Calibration Curves for Selected Compounds
Calibration Curves for Aflatoxin (0.1 – 10 µg/kg), Deoxynivalenol (10 – 1000 µg/kg), and Zearalenone (10 – 1000 µg/kg).

Conclusions

In this study a single method has been developed for the analysis of 18 regulated mycotoxins with an injection to injection cycle time of 12.5 minutes. This method achieves the required EU reporting limits (between 0.1 -10 µg/kg) with linear regression

coefficients R² typically greater than 0.998 (Fig. 2 and Table 1). The LC mobile phase, column and gradient were all optimised and provided chromatographic resolution of 15-acetyldeoxynivalenol and 3-acetyldeoxynivalenol.

References

- 1) A. Rahmani, S. Jinap, and F. Soleimany. 2009. Qualitative and Quantitative Analysis of Mycotoxins. Comprehensive reviews in food science and food safety. 8: 202-251.
- 2) M. E. Zain. 2011. Impact of mycotoxins on humans and animals. Journal of Saudi Chemical Society. 15 (2): 129-144.
- 3) M. Sameni, A. Dübecke and J. F. Weber. 2014. Simultaneous Multi- Residue Determination of Mycotoxins in Foods Using LC-MS/MS. Journal of Environmental & Analytical Toxicology. 5 (2): 1000259
- 4) J. W. Bennett and M. Klich. 2003. Mycotoxins. Clinical Microbiology Reviews. 16 (3): 497-516
- 5) Mycotoxins regulations for Food. http://www.mycotoxins.info/myco_info/consum_regu.html Accessed 6th September 2016

First Edition: Oct. 2016



For Research Use Only. Not for use in diagnostic procedure.

This publication may contain references to products that are not available in your country. Please contact us to check the availability of these products in your country.

The content of this publication shall not be reproduced, altered or sold for any commercial purpose without the written approval of Shimadzu. Company names, product/service names and logos used in this publication are trademarks and trade names of Shimadzu Corporation or its affiliates, whether or not they are used with trademark symbol "TM" or "®". Third-party trademarks and trade names may be used in this publication to refer to either the entities or their products/services. Shimadzu disclaims any proprietary interest in trademarks and trade names other than its own.

The information contained herein is provided to you "as is" without warranty of any kind including without limitation warranties as to its accuracy or completeness. Shimadzu does not assume any responsibility or liability for any damage, whether direct or indirect, relating to the use of this publication. This publication is based upon the information available to Shimadzu on or before the date of publication, and subject to change without notice.

Application News

No. C165

LC-MS/MS

Multi-residue analysis of 18 regulated mycotoxins by LC-MS/MS (2)

Fusarium mycotoxins are a structurally diverse group of secondary metabolites known to contaminate a diverse array of food and feed resulting in a risk for human and animal health. European guidance legislation has set maximum levels for mycotoxins in food and feed to minimize the impact to human and animal health. The most toxicologically important Fusarium mycotoxins are trichothecenes (including deoxynivalenol (DON) and T-2 toxin (T-2)), zearalenone (ZON) and fumonisin B1 (FB1).

In this work, a single LC-MS/MS method has been developed for the determination of 18 mycotoxins in food safety. Limits of quantification were at or below the maximum levels set in the EC/1886/2006 document. The scope of the method included aflatoxins (B1, B2, G1, G2), fumonisins (B1, B2, B3), ochratoxin A (OTA) and trichothecenes (3-acetyldeoxynivalenol (3-AcDON), 15-acetyldeoxynivalenol (15-AcDON), deoxynivalenol (DON), diastoxyscripanol (DAS), fusarenon-X (FUS X), HT-2, neosolanin (NEO), nivalenol (NIV), T2, zearalenone (ZON)) with an analysis cycle time of 12.5 minutes.

Materials and Methods

Solvent extracts were provided by Concept Life Sciences following validated extraction protocols. Samples were measured using a Nexera UHPLC and the LCMS-8060 triple quadrupole detector (Table 1). To separate out the three pairs of regioisomers (3-AcDON/15-AcDON, FB2/FB3, and FA2/FA3) a pentafluorophenyl (PFP) column was used and compared against a C18 material. To enhance signal response a series of mobile phase additives were considered including ammonium acetate, ammonium fluoride, ammonium formate and acetic acid solutions.

In this work, ammonium fluoride solution and ammonium fluoride with acetic acid solution was the preferred solvent system as it resulted in a considerable enhancement of signal intensity in positive ion mode for all mycotoxins. Calibration was performed using ¹³C internal standards spiked during sample extraction. All solvents used during analysis were LCMS quality from Sigma-Aldrich.

David Baker*¹, Christopher Titman*¹, Neil Loftus*¹, Jonathan Horner*²

*¹: Shimadzu, Manchester, UK

*²: Concept Life Sciences, Cambridge, UK

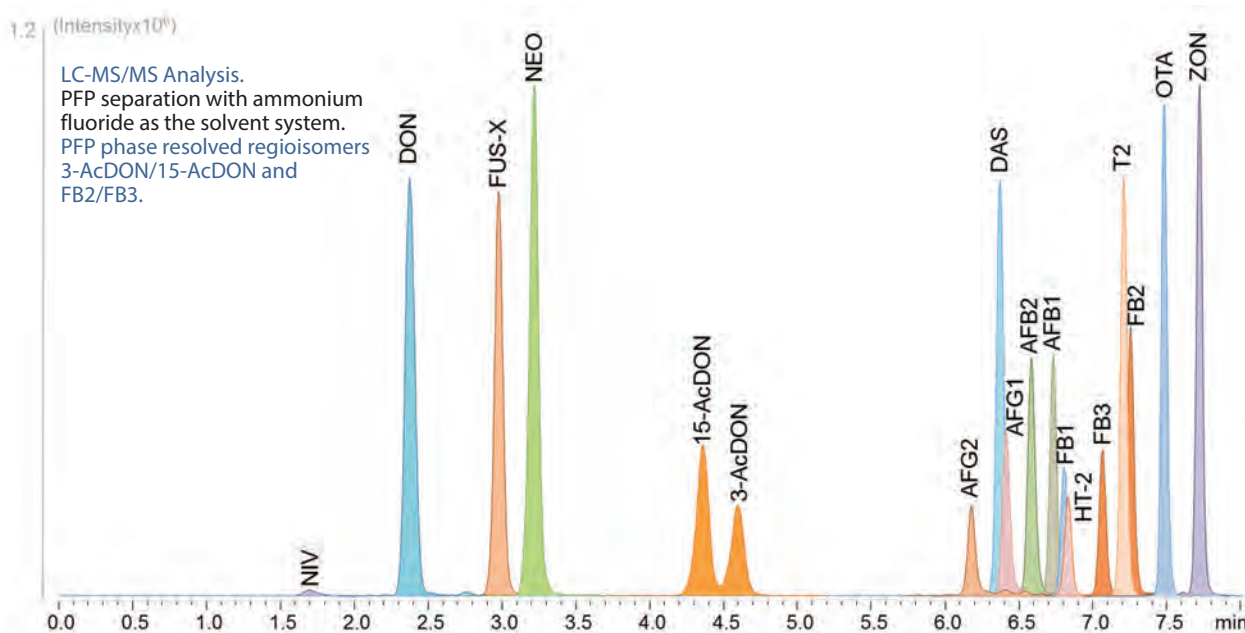

Fig. 1 MRM chromatograms of 18 mycotoxins using a PFP bonded phase.

AFB1 (aflatoxin B1; 1 µg/kg; rescaled x3), AFB2 (aflatoxin B2; 1 µg/kg; rescaled x3), AFG1 (aflatoxin G1; 1 µg/kg; rescaled x3), AFG2 (aflatoxin G2; 1 µg/kg; rescaled x3), OTA (ochratoxin A; 4 µg/kg), FB1 (fumonisin B1; 100 µg/kg; rescaled x2), FB2 (fumonisin B2; 100 µg/kg; rescaled x2), FB3 (fumonisin B3; 100 µg/kg; rescaled x2), 15-AcDON (15-acetyldeoxynivalenol; 100 µg/kg), 3-AcDON (3-acetyldeoxynivalenol; 100 µg/kg), DON (deoxynivalenol; 100 µg/kg), DAS (diastoxyscripanol; 100 µg/kg), FUS-X (fusarenon-X; 100 µg/kg), HT-2 (100 µg/kg), T-2 (100 µg/kg; rescaled x0.3), NEO (neosolanin; 100 µg/kg; rescaled x0.3), NIV (nivalenol; 100 µg/kg), ZON (zearalenone; 100 µg/kg)

Influence of ammonium fluoride on ion signal intensity

Ammonium fluoride solution has a high gas-phase basicity and known to be effective in improving sensitivity for small molecules in negative mode LC-MS. However, ammonium fluoride has also been shown to enhance sensitivity in positive ion mode. Compared to standard mobile phases used for mycotoxin analysis the addition of ammonium fluoride has a positive impact on ion signal intensity.

Fig.2 indicates that ammonium fluoride markedly increases ion signal intensity compared to other solvent systems. All chromatograms are normalized to the same signal intensity. Ammonium fluoride delivered higher ion signal response for mycotoxins in positive ion mode compared to other mobile phase solvent system (Fig. 2a).

Table 1 Analytical Conditions

UHPLC	Nexera X2 LC system
Analytical column	Mastro PFP (100 mmL. x 2.1 mm I.D., 3 μm)
Column temperature	40 °C
Flow rate	0.4 mL/min
Solvent A	0.15 mmol/L ammonium fluoride aqueous solution
Solvent B	0.15 mM ammonium fluoride methanol solution with 2 % acetic acid
Binary Gradient	B conc. 15 % (0 min) - 25 % (1 min) - 40 % (2 min) - 41 % (4.5 min) - 100 % (7.5 - 10 min) - 15 % (10.1 min) - Stop (12.5 min)
Mass spectrometer	Shimadzu LCMS-8060
Pause time/Dwell time	1 msec/10-40 msec
Polarity switching time	Pos/neg switching time set to 5 msec
Source temperatures (interface; heat block; DL)	300 °C; 400 °C; 250 °C
Gas flows (nebulising; heating; drying)	3 L/min; 10 L/min; 10 L/min

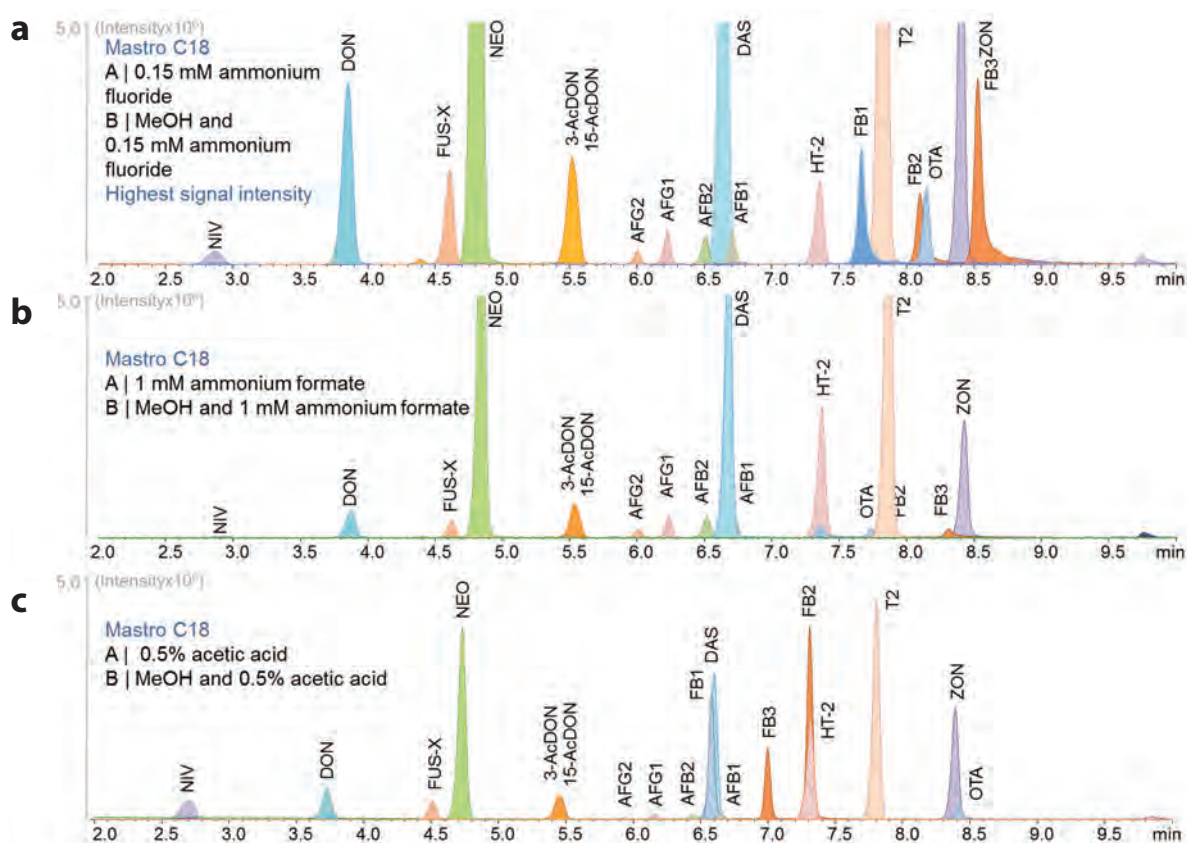

Fig. 2 Comparison of MRM Chromatograms of 18 Mycotoxins under the Different Mobile Phase Conditions (Mastro C18 Column)
a: Mobile Phase A = 0.15 mM Ammonium Fluoride Aqueous Solution, Mobile Phase B = 0.15 mM Ammonium Fluoride Methanol Solution
b: Mobile Phase A = 1 mM Ammonium Formate Aqueous Solution, Mobile Phase B = 1 mM Ammonium Formate Methanol Solution
c: Mobile Phase A = 0.5 % Acetic Acid Aqueous Solution, Mobile Phase B = 0.5 % Acetic Acid Methanol Solution

Fig. 3 shows 18 mycotoxins separated on a PFP phase compared to a C18 bonded material using ammonium fluoride as the mobile phase. PFP phases delivered near baseline resolution of 3- and 15-acetyldeoxynivalenol

which is not possible on a C18 phase (C18 material can still be used due to preferential ionisation of 3-AcDON in negative ion mode).

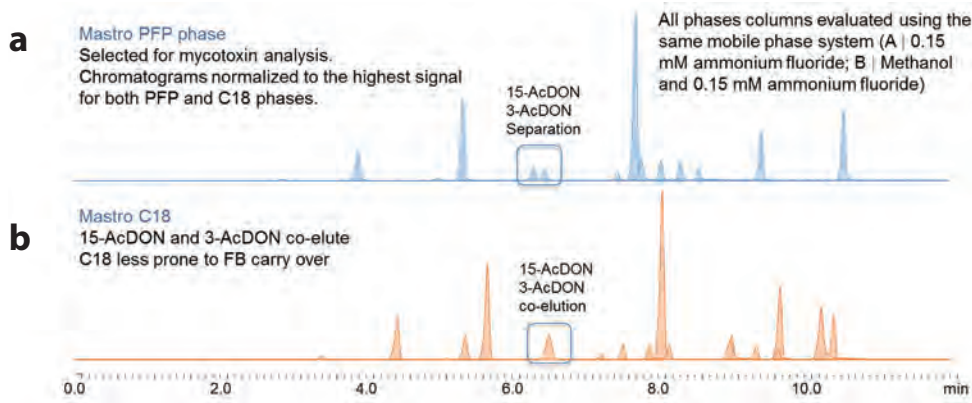

Fig. 3 Comparison of MRM Chromatograms of 18 Mycotoxins Using Different Columns
Mobile Phase A = 0.15 mM Ammonium Fluoride Aqueous Solution,
Mobile Phase B = 0.15 mM Ammonium Fluoride Methanol Solution (for Both Columns)
a: Mastro PFP Column, b: Mastro C18 Column

■ Analysis of sample matrices

To separate the regioisomers 3-AcDON/15-AcDON and FB2/FB3 several PFP phases were evaluated including Mastro PFP, Kinetix PFP, Discovery HS F5 PFP and ACE PFP. Compared to a C18 bonded phase, the PFP phases delivered near baseline resolution of the regioisomers 3-AcDON/15-AcDON and FB2/FB3 but required a modification of the mobile phase to reduce FB carry over (2 % acetic acid was added to the mobile phase to

negate the effects of FB's carry over).

Fig. 4 shows the analysis of a mixed spice extract and a pepper extract spiked with Aflatoxins B1, B2, G1, G2 (2.5 µg/kg) and Ochratoxin A (10 µg/kg) using ammonium fluoride solution in the mobile phase. Repeatedly injecting the extracts resulted in a %RSD typically below 10 % (n=12) for Aflatoxins B1, B2, G1, G2 (2.5 µg/kg) and Ochratoxin A (10 µg/kg).

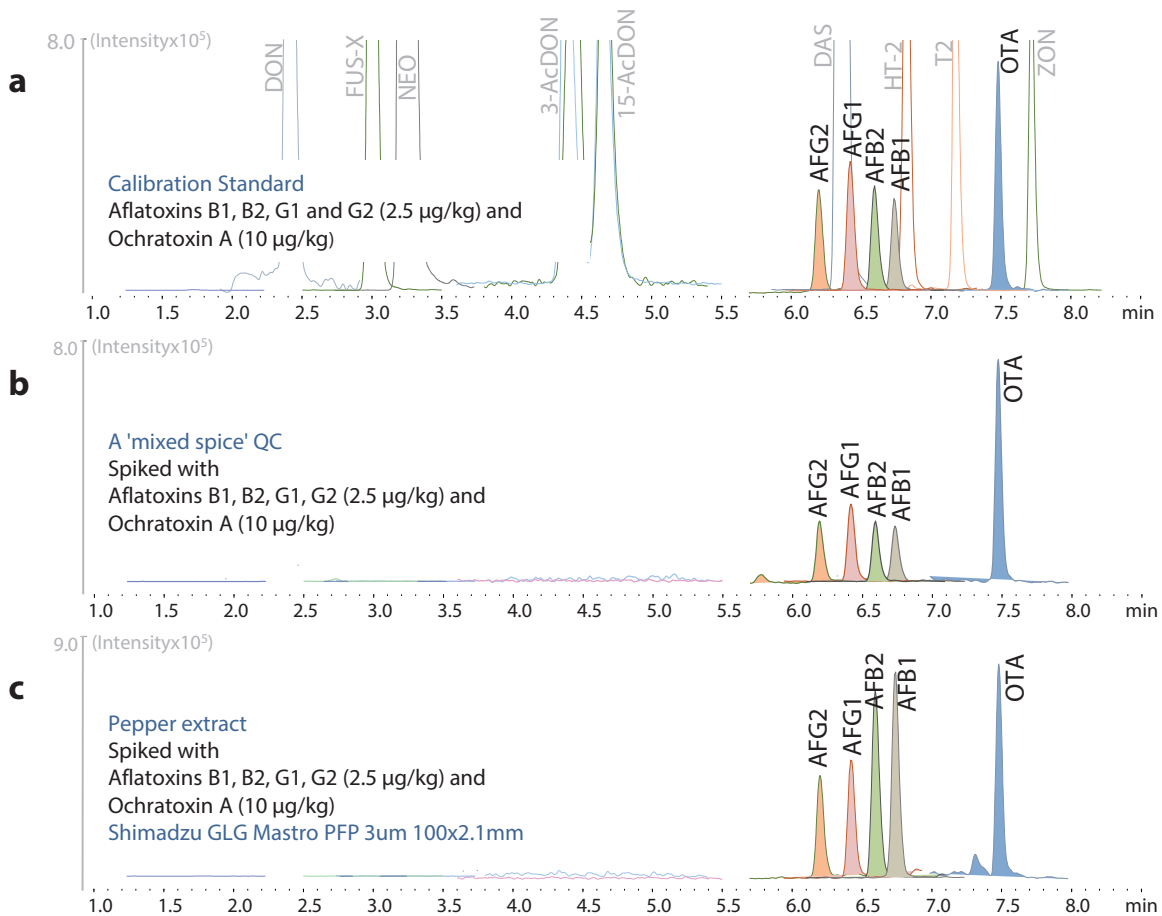

Fig. 4 Chromatograms of the Mycotoxin Standard Solution, Mixed Spice Extract, and Pepper Extract Spiked with Aflatoxins B1, B2, G1, G2 (2.5 µg/kg) and Ochratoxin A (10 µg/kg)
a: Mycotoxin Standard Solution, b: Mixed Spice Extract, c: Pepper Extract

Table 2 MRM's of mycotoxins in positive and negative mode ionisation.

Compound name	Parent ion	RT	MRM 1	MRM 2	Internal Standard	Calibration range (µg/kg)	R ²
Aflatoxin B1	[M+H] ⁺	6.773	313 > 241	313 > 285	¹³ C Aflatoxin B1	0.1 - 10	0.9988
Aflatoxin B2	[M+H] ⁺	6.621	315 > 259	315 > 287	¹³ C Aflatoxin B2	0.1 - 10	0.9995
Aflatoxin G1	[M+H] ⁺	6.453	329 > 243	329 > 200	¹³ C Aflatoxin G1	0.1 - 10	0.9998
Aflatoxin G2	[M+H] ⁺	6.219	331 > 245	331 > 285	¹³ C Aflatoxin G2	0.1 - 10	0.9965
Ochratoxin A	[M+H] ⁺	7.509	404 > 239	404 > 221	¹³ C Ochratoxin A	0.4 - 40	0.9969
Fumonisin B1	[M+H] ⁺	6.811	722 > 352	722 > 334	¹³ C Aflatoxin B2	10 - 1000	0.9937
Fumonisin B2	[M+H] ⁺	7.26	706 > 318	706 > 354	¹³ C Aflatoxin B2	10 - 1000	0.9998
Fumonisin B3	[M+H] ⁺	7.073	706 > 318	706 > 354	¹³ C Aflatoxin B2	10 - 1000	0.9991
Deoxynivalenol	[M+H] ⁺	2.372	297 > 279	297 > 249	¹³ C Deoxynivalenol	10 - 1000	0.9992
Diacetoxyscirpenol	[M+NH ₄] ⁺	6.349	384 > 229	384 > 307	¹³ C T-2 Toxin	10 - 1000	0.9994
T-2	[M+NH ₄] ⁺	7.206	484 > 185	484 > 215	¹³ C T-2 Toxin	10 - 1000	0.9989
HT-2	[M+Na] ⁺	6.822	447 > 345	447 > 285	¹³ C T-2 Toxin	10 - 1000	1.0000
Nivalenol	[M+CH ₃ COO] ⁻	1.684	371 > 281	371 > 311	¹³ C HT-2	10 - 1000	0.9991
Neosolaniol	[M+NH ₄] ⁺	3.227	400 > 215	400 > 305	¹³ C Deoxynivalenol	10 - 1000	0.9995
Fusarenon X	[M+H] ⁺	2.986	355 > 247	355 > 277	¹³ C Deoxynivalenol	10 - 1000	0.9987
Zearalenone	[M-H] ⁻	7.711	317 > 175	317 > 131	¹³ C T2 Toxin	10 - 1000	0.9985
15-Acetyldeoxynivalenol	[M+H] ⁺	4.406	339 > 261	339 > 297	¹³ C Deoxynivalenol	10 - 1000	1.0000
3-Acetyldeoxynivalenol	[M+H] ⁺	4.618	339 > 261	339 > 297	¹³ C Deoxynivalenol	10 - 1000	0.9986
¹³ C HT-2	[M+NH ₄] ⁺	6.844	464 > 278				
¹³ C T-2	[M+NH ₄] ⁺	7.228	508 > 322				
¹³ C Aflatoxin B1	[M+H] ⁺	6.754	330 > 301				
¹³ C Aflatoxin B2	[M+H] ⁺	6.614	332 > 303				
¹³ C Aflatoxin G1	[M+H] ⁺	6.435	346 > 212				
¹³ C Aflatoxin G2	[M+H] ⁺	6.219	348 > 259				
¹³ C Ochratoxin A	[M+H] ⁺	7.516	424 > 250				

Conclusions

Ammonium fluoride as a solvent system results in a higher signal response for mycotoxins in positive ion detection.

To negate any possible carry over effects with fumonisin's 2 % acetic acid was added to the mobile phase.

PFP bonded phases deliver a separation of mycotoxin regioisomers which can be applied routinely.

This method results in higher sensitivity for mycotoxins and can be applied to both PFP and C18 phases in routine quantitation with a cycle time of 12.5 minutes.

Multi-Residue Analysis of 210 Pesticides in Food Samples by Triple Quadrupole UHPLC-MS/MS

David R. Baker¹, Chris Titman¹, Alan J. Barnes¹, Neil J. Loftus¹, Alexander Mastoroudes², Simon Hird³

¹Shimadzu Corporation, Manchester, UK

²Kings College London, London, UK

³Food and Environment Research Agency, York, UK

Abstract

Pesticides and their metabolites are of great concern to society as they are harmful to human health, pollute natural resources and disturb the equilibrium of the ecosystem. Consequently, stricter food safety regulations are being enforced around the world, placing pesticide analysis laboratories under increasing pressure to expand the list of targeted pesticides, detect analytes at lower levels and with greater precision, reduce analysis turnaround times, and all the while maintaining or reducing costs. In this study a method was successfully developed for the quantitation of 210 commonly analysed pesticides in food samples using the Nexera UHPLC and LCMS-8040. Initial validation was performed to demonstrate instrument capabilities. Limits of detection (LOD) for 90 % of compounds were less than 0.001 mg kg⁻¹ (1 ppb) and all compounds were less than 0.01 mg kg⁻¹ (10 ppb) for both the quantifying and qualifying transitions using only a 2 µL injection. Repeatability at the 0.01 mg kg⁻¹ reporting level was typically less than 5 %RSD for compounds and correlation coefficients were typically greater than 0.997 in a variety of studied food extracts. Consequently, the LCMS-8040 is ideally suited for routine monitoring of pesticides below the 0.01 mg kg⁻¹ default level set by EU and Japanese legislation.

Keywords: Pesticides; Multi-residue analysis; LCMS-8040; Food safety; Fruit; Vegetables

1. Introduction

Pesticide residues in food continue to be the target of studies due to the uncertainty concerning adverse effects that those residues may have on human health after a lengthy exposure at low levels. More than 1000 active ingredients have been utilised and are formulated in thousands of different commercial products. They include a variety of compounds, mainly insecticides, herbicides and fungicides, as well as their metabolites, with very different physico-chemical characteristics and large differences in polarity, volatility and persistence.¹ Consequently, in order to ensure food safety for consumers and to facilitate international trade, regulatory bodies around the world have established maximum residue levels (MRLs) for pesticide residues in food commodities; that is, the maximum amount of pesticide residue and its toxic metabolites that might be expected on a commodity if good agricultural practice was adhered to during the use of the pesticide.²

In the European Union regulation 396/2005/EC was implemented in 2008 harmonising pesticide MRLs in all member states for 435 pesticide active substances in 378 commodities.³ This EU regulation covers pesticides both currently and formerly used in agriculture in or outside the EU. For pesticide and food commodity combinations not listed in the regulation a default MRL of 0.01 mg kg⁻¹ applies (Art 18(1b) of European Union Regulation No 396/2005).³ In general, MRLs in the European Food regulation are in the range 0.01 - 10 mg kg⁻¹ depending on the pesticide-commodity combination, with the lowest levels set for banned pesticides. For vegetables, fruits and cereals intended for the production of baby foods, Directive 2006/141/EC requires that baby food contains no detectable levels of pesticide residues defined as < 0.01 mg kg⁻¹ and prohibits the use of certain very toxic

pesticides in the production of infant foods and establishes even lower MRLs for a few other very toxic pesticides.⁴ Regulatory bodies around the world, as in the EU, have produced similar guidelines. In the US, tolerances for more than 450 pesticides and other ingredients are stated in the electronic Code of Federal Regulations (US Environmental Protection Agency Office of Pesticide Programs) and are enforced by the US FDA.⁵ Japan's positive list system for agricultural chemical residues in foods, introduced in 2006, contains MRLs for over 400 pesticides in various commodities.⁶ China published national standard GB 2763-2005 in 2005 and more recently GB 28260-2011 which was introduced in 2012 and specifies 181 MRLs for 85 pesticides in food.^{7,8}

Consequently, pesticide analysis laboratories are under increasing pressure to expand the list of targeted pesticides, detect analytes at lower levels and with greater precision, reduce analysis turnaround times and reduce usage of hazardous solvents while maintaining or reducing costs. Pesticide residues were traditionally analysed mainly by GC-based multi-residue methods often with MS detection. However, many modern



(semi)polar compounds and/or ionic compounds could not be analysed in this way due to poor thermal stability or volatility without the need for derivatisation.⁹ Recent improvements in liquid chromatography - tandem mass spectrometry, combined with the discussed pitfalls of GCMS, have meant LCMSMS has become a vital technique. LC-triple quadrupole mass spectrometry enables highly selective and sensitive analysis and is well suited to the multi-class analysis of large numbers of pesticides at trace levels.

In this work, we discuss the development of a multi-residue pesticide method for 210 pesticides using the Nexera UHPLC and LCMS-8040 triple quadrupole. Pesticides were matrix-matched in food matrix (lettuce, pear and dried fruit) following QuEChERS sample preparation. The method was evaluated in matrix to ensure that the necessary reporting limits were obtained according to the various regulatory guidelines around the world with acceptable precision, in addition to ensuring chromatographic resolution of pesticide isomers with identical SRM transitions.

2. Experimental

A stock of pesticides was obtained from the Food and Environment Agency, UK, at a concentration of 0.01 mg kg⁻¹ (for each pesticide) in acetone:acetonitrile 1:1. Linearity was investigated over a nine-point calibration with samples ranging from 0.5 µg kg⁻¹ - 0.2 mg kg⁻¹ (0.5 – 200 ppb) analysed in duplicate; calibration samples were injected once in increasing order and once in decreasing order. Linearity was assessed with four calibration curves prepared by serial dilution of: (1) acetonitrile, (2) dried fruit extract, (3) lettuce extract and, (4) pear extract. Instrumental area repeatability was determined by replicate (n=6) injection of pear matrix at 0.01 mg kg⁻¹. LC-MS mobile phase solvents and additives were all of LC-MS quality and purchased from Sigma-Aldrich.

Food extracts were supplied by the Food and Environment Agency, UK, following established QuEChERS protocols. QuEChERS is acronym for Quick Easy Cheap Effective Rugged Safe and is a widely used sample preparation technique for the extraction of pesticides from food. Food samples included dried fruit, lettuce and pear, with the final extracts prepared in 100% acetonitrile.

LC Parameters

UHPLC:	Nexera UHPLC system		
Column:	Shim-pack XR-ODS III (150 x 2 mm, 2.2 µm particle size)		
Column temp.:	40 °C		
Mobile phase:	A = Water with 5 mM ammonium formate and 0.01 % formic acid B = Methanol with 5 mM ammonium formate and 0.01 % formic acid		
Gradient:	Time (min)	A%	B%
	0	5	95
	16	0	100
	18	0	100
	18.1	5	95
	20	5	95
Flow rate:	0.4 mL min ⁻¹		
Injection volume:	32 µL (stacked injection: 2µL sample + 30µL water)		
Needle wash:	1000 µL Methanol		

MS Parameters

MS:	LCMS-8040 triple quadrupole mass spectrometer
Ionisation:	ESI - Positive and negative (15 msec. polarity switch)
SRM:	Dwell time 5 msec. Pause time 1 msec.
Desolvation line:	250 °C
Heating block:	400 °C
Drying gas:	15 L min ⁻¹
Nebulising gas:	2 L min ⁻¹
SRM optimisation:	1:1 water:methanol with 10mM ammonium acetate Flow rate: 0.5mL min ⁻¹ Flow injection analysis (No column fitted) 0.2 µL (0.01 mg kg ⁻¹ pesticide standard solution)
Mobile phase screening:	Carrier 1:1 water:methanol Flow rate: 0.3mL min ⁻¹ Flow injection analysis (No column fitted) 5µL injection (0.01 mg kg ⁻¹ pesticide standard solution) 1µL air gap (see text for mobile phase compositions)

Pesticide limits of detection were calculated based on the method described by the US-EPA in Title 40 Code of Federal Regulation Part 136,¹⁰ using a standard deviation of 7 replicates in pear matrix at a concentration value that corresponds to an instrument signal to noise ratio in the range of 2.5 to 5 and a Student's t 99% confidence interval:

$$MDL = St(n - 1, 1 - \alpha = 0.99) \times s.d.$$

Where, $t(n-1, 1-\alpha=0.99)$ = Student's t value for the 99% confidence level with n-1 degrees of freedom (t = 3.14 for 7 replicates), n = number of replicates, and s.d. = standard deviation of the replicate analyses.

3. Results and discussion

3.1 SRM optimisation

Target precursor and product ions were selected based on recommendations from the Food and Environment Agency, UK, and data from the EURL DataPool.¹¹ Typically the protonated or deprotonated molecule was used for the precursor ion. In order to try to prevent interference of SRM transitions from matrix, product ions greater than m/z 100 were selected where possible as they are typically more diagnostic.¹² Analyte specific MS parameters (Q1 pre-bias (V), Q3 pre-bias (V) and collision energy) were optimised using automated flow injection analysis. Briefly, this involves placing pesticide standards into the auto-sampler, from where they are then rapidly injected into the MS with a different parameter optimised on each injection. Each compound was optimised in only a few minutes using the automated software provided in LabSolutions. This allowed large numbers of compounds to be optimised overnight; this is in stark contrast to traditional time-consuming infusion in order to optimise parameters. The compounds studied and their associated transitions are shown in Table 1.

Table 1 - Studied compounds and their chemical formulas, CAS numbers, SRMs, retention times, limits of detection and R²

Compound	Formula	CAS	Transition 1	Transition 2	Pear extract				
					RT (min.)	Transition 1 LOD (ppb)	Transition 2 LOD (ppb)	%RSD (10ppb)	R ²
Avermectin B1a	C48H72O14	71751-41-2	891 > 305	891 > 567	16.4	0.35	0.56	5.0	0.9975
Acephate	C4H10NO3PS	30560-19-1	184 > 143	184 > 49	3.0	0.17	0.31	1.0	0.9999
Acetamiprid	C10H11CIN4	135410-20-7	223 > 126	223 > 99	7.2	0.50	1.00	1.1	0.9979
Acrinathrin	C26H21F6NO5	101007-06-1	559 > 208	559 > 181	16.1	1.32	2.36	4.4	0.9990
Alachlor	C14H20CINO2	15972-60-8	270 > 238	270 > 162	13.4	0.09	0.26	1.5	0.9995
Aldicarb	C7H14N2O2S	116-06-3	208 > 116	208 > 89	8.5	0.05	0.10	1.7	0.9998
Aldicarb sulfone	C7H14N2O4S	1646-88-4	240 > 223	240 > 86	4.3	0.17	0.13	1.8	0.9999
Aldicarb sulfoxide	C7H14N2O3S	1646-87-3	207 > 89	207 > 132	3.9	0.22	0.36	2.3	1.0000
Amidosulfuron	C9H15N5O7S2	120923-37-7	370 > 261	370 > 139	9.3	0.14	0.22	2.8	0.9984
Asulam	C8H10N2O4S	3337-71-1	231 > 156	231 > 92	3.4	0.72	2.03	3.8	0.9979
Atrazine	C8H14CIN5	1912-24-9	216 > 174	216 > 104	11.1	0.10	0.22	2.4	0.9989
Azinphos-methyl	C10H12N3O3PS2	86-50-0	318 > 132	318 > 77	11.8	0.50	0.50	2.7	0.9903
Azoxystrobin	C22H17N3O5	131860-33-8	404 > 372	404 > 344	12.1	0.03	0.30	2.1	0.9989
Bendiocarb	C11H13NO4	22781-23-3	224 > 109	224 > 167	9.8	0.10	0.09	1.5	0.9996
Benthiavdicarb-isopropyl	C18H24FN3O3S	177406-68-7	382 > 180	382 > 116	12.7	0.12	0.41	0.9	0.9997
Bispyribac sodium	C19H17N4NaO8	125401-92-5	453 > 297	453 > 179	12.1	1.41	5.43	7.4	0.9954
Boscalid	C18H12Cl2N2O	188425-85-6	343 > 307	343 > 140	12.5	0.81	1.19	4.6	0.9968
Bromoxynil*	C7H3Br2NO	1689-84-5	274 > 79	276 > 81	9.9	2.24	2.61	4.5	0.9968
Bromuconazole	C13H12BrCl2N3O	116255-48-2	376 > 159	376 > 70	13.0	0.72	1.79	2.9	0.9994
Butachlor	C17H26CINO2	23184-66-9	312 > 238	312 > 57	15.3	0.29	0.39	1.6	0.9998
Butocarboxim	C7H14N2O2 S	34681-10-2	208 > 75	208 > 191	8.4	0.13	0.87	3.1	0.9999
Butocarboxim sulfone	C7H14N2O4S	34681-23-7	223 > 106	223 > 166	4.1	2.63	3.23	9.7	0.9949
Butocarboxim sulfoxide	C7H14N2O3S	34681-24-8	207 > 88	207 > 75	3.7	0.22	0.21	1.9	0.9999
Carbaryl	C12H11NO2	63-25-2	202 > 145	202 > 127	10.3	0.13	0.22	2.4	0.9988
Carbendazim	C9H9N3O2	10605-21-7	192 > 160	192 > 132	7.1	0.50	1.00	1.1	0.9996
Carbofuran	C12H15NO3	1563-66-2	222 > 165	222 > 123	11.1	0.12	0.18	0.7	0.9993
Carboxin	C12H13NO2S	5234-68-4	236 > 143	236 > 87	10.2	0.09	0.25	0.9	0.9991
Chlorantraniliprole*	C18H14BrCl2N5O2	500008-45-7	482 > 284	482 > 177	11.8	0.50	1.00	2.3	0.9979
Chlorfenvinfos	C12H14Cl3O4P	470-90-6	361 > 155	361 > 99	14.0	0.28	0.49	2.3	0.9966
Chloridazon	C10H8CIN3O	1698-60-8	222 > 92	222 > 104	7.2	0.20	0.18	3.2	0.9990
Chlorotoluron	C10H13CIN2O	15545-48-9	213 > 72	213 > 46	10.8	0.05	0.13	1.3	0.9967
Chromafenozide	C24H30N2O3	143807-66-3	395 > 175	395 > 91	13.0	0.05	0.60	1.0	0.9977
Clethodim	C17H26CINO3S	99129-21-2	360 > 164	360 > 268	14.7	0.08	0.45	0.7	0.9970
Clofentezine	C14H8Cl2N4	74115-24-5	303 > 138	303 > 102	14.4	4.03	5.76	9.5	0.9967
Clothianidin	C6H8CIN5O2S	210880-92-5	250 > 132	250 > 169	6.5	0.25	0.12	1.6	0.9978
Cyazofamid	C13H13CIN4O2S	120116-88-3	325 > 108	325 > 261	13.3	0.39	3.74	2.4	0.9964
Cycloxydim	C17H27NO3S	101205-02-1	326 > 280	326 > 180	14.8	0.33	0.73	1.0	0.9989
Cyflufenamid	C20H17F5N2O2	180409-60-3	413 > 295	413 > 241	14.2	0.27	0.29	2.9	0.9982
Cymoxanil	C7H10N4O3	57966-95-7	199 > 128	199 > 111	7.7	2.99	3.52	5.5	0.9960
Cyproconazole	C15H18CIN3O	113096-99-4	292 > 70	292 > 125	12.8	0.41	0.60	3.5	0.9988
Cyprodinil	C14H15N3	121552-61-2	226 > 93	226 > 108	13.9	0.89	0.91	1.3	0.9990
Cyromazine	C6H10N6	66215-27-8	167 > 85	167 > 125	2.2	2.57	4.79	7.4	0.9994
Demeton-S-methyl sulfoxide	C6H15O4PS2	301-12-2	247 > 169	247 > 109	5.0	0.01	0.03	1.2	0.9999
Demeton-S-methyl sulfone	C6H15O5PS2	17040-19-6	263 > 169	263 > 109	5.3	0.03	0.10	3.1	0.9999
Desmedipham	C16H16N2O4	13684-56-5	318 > 182	318 > 136	11.6	0.08	0.33	0.5	0.9971
Diclobutrazol	C15H19Cl2N3O	75736-33-3	328 > 70	330 > 70	13.8	0.17	0.20	2.7	0.9988

Table 1 – Continued...

Compound	Formula	CAS	Transition 1	Transition 2	Pear extract				
					RT (min.)	Transition 1 LOD (ppb)	Transition 2 LOD (ppb)	%RSD (10ppb)	R ²
Diethofencarb	C14H21NO4	87130-20-9	268 > 226	268 > 124	12.2	0.06	0.12	2.2	0.9996
Difenoconazole	C19H17Cl2N3O3	119446-68-3	406 > 251	406 > 188	14.5	0.18	0.53	2.6	0.9994
Diflubenzuron	C14H9ClF2N2O2	35367-38-5	311 > 158	311 > 141	13.5	2.21	7.48	9.2	0.9936
Dimethoate	C5H12NO3PS2	60-51-5	230 > 125	230 > 199	7.0	0.05	0.07	1.6	0.9997
Dimethomorph	C21H22ClNO4	110488-70-5	388 > 301	388 > 165	12.7	0.29	0.41	2.5	0.9991
Dimoxystrobin	C19H22N2O3	149961-52-4	327 > 205	327 > 116	13.7	0.12	0.14	0.5	0.9997
Dinotefuran	C7H14N4O3	165252-70-0	203 > 129	203 > 157	3.9	0.10	0.22	2.9	0.9994
Disulfoton sulfoxide	C8H19O3PS3	2497-07-6	291 > 213	291 > 97	10.8	0.05	0.15	2.6	0.9980
Diuron	C9H10Cl2N2O	330-54-1	233 > 72	235 > 72	11.4	0.09	0.26	0.6	0.9971
DMPF	C10H14N2	33089-74-6	163 > 107	163 > 122	4.8	1.00	2.00	2.5	0.9910
Dodine	C15H33N3O2	2439-10-3	228 > 71	228 > 60	13.5	0.30	0.54	1.7	0.9946
Epoxiconazole	C17H13ClFN3O	135319-73-2	330 > 121	330 > 101	13.3	0.12	0.37	2.5	0.9998
Ethiofencarb	C11H15NO2S	29973-13-5	226 > 107	226 > 169	10.6	0.18	0.59	0.7	0.9994
Ethiofencarb sulfone	C11H15NO2S2	53380-23-7	275 > 107	275 > 201	6.2	0.02	0.16	0.9	0.9999
Ethiofencarb sulfoxide	C11H15NO3S	53380-22-6	242 > 107	242 > 185	6.5	0.02	0.02	0.9	0.9999
Ethirimol	C11H19N3O	23947-60-6	210 > 140	210 > 98	10.8	0.14	0.24	1.8	0.9977
Etofenprox	C25H28O3	80844-07-1	394 > 177	394 > 359	16.9	0.03	0.06	3.1	0.9983
Fenamidone	C17H17N3OS	161326-34-7	312 > 92	312 > 236	12.4	0.06	0.18	1.9	0.9988
Fenamiphos	C13H22NO3PS	22224-92-6	304 > 217	304 > 202	13.5	0.05	0.28	1.9	0.9970
Fenamiphos sulfone	C13H22NO5PS	31972-44-8	336 > 266	336 > 188	10.2	0.31	0.25	4.3	0.9961
Fenamiphos sulfoxide	C13H22NO4PS	31972-43-7	320 > 108	320 > 171	10.0	0.18	0.52	3.3	0.9976
Fenbuconazole	C19H17ClN4	114369-43-6	337 > 125	337 > 70	13.4	0.23	0.40	5.0	0.9964
Fenhexamid	C14H17Cl2NO2	126833-17-8	302 > 97	302 > 55	13.1	0.75	0.95	0.9	0.9944
Fenoxycarb	C17H19NO4	79127-80-3	302 > 88	302 > 116	13.6	0.10	0.20	2.4	0.9989
Fenpropimorph	C20H33NO	67564-91-4	304 > 147	304 > 117	14.1	0.05	0.13	1.6	0.9995
Fenproximate	C24H27N3O4	111812-58-9	422 > 366	422 > 215	15.9	0.02	0.17	1.2	0.9997
Fenthion sulfoxide	C10H15O4PS2	3761-41-9	295 > 109	295 > 280	10.1	0.18	0.27	1.5	0.9985
Fenthion sulfone	C10H15O5PS2	3761-42-0	311 > 109	311 > 125	10.4	3.75	3.61	9.8	0.9974
Fipronil*	C12H4Cl2F6N4OS	120068-37-3	435 > 330	435 > 250	13.5	0.11	0.35	4.1	0.9998
Fluazifop acid*	C15H12F3NO4	69335-91-7	328 > 282	328 > 91	11.8	0.55	3.61	7.1	0.9983
Fluazinam*	C13H4Cl2F6N4O4	79622-59-6	463 > 416	463 > 398	15.2	0.20	0.27	2.7	0.9994
Fludioxonil*	C12H6F2N2O2	131341-86-1	247 > 126	247 > 180	12.4	1.00	1.00	4.2	0.9974
Flufenacet	C14H13F4N3O2S	142459-58-3	364 > 152	364 > 194	13.2	0.04	0.06	1.6	0.9986
Flufenoxuron	C21H11ClF6N2O3	101463-69-8	489 > 158	489 > 141	15.7	0.24	0.63	8.2	0.9989
Fluometuron	C10H11F3N2O	2164-17-2	233 > 72	233 > 46	10.6	0.12	0.14	1.3	0.9996
Fluopicolide	C14H8Cl3F3N2O	239110-15-7	383 > 173	383 > 145	12.7	0.05	0.17	2.1	0.9967
Fluoxastrobin	C21H16ClFN4O5	361377-29-9	459 > 427	459 > 188	13.1	0.19	0.22	1.7	0.9987
Fluroxypyr*	C7H5Cl2FN2O3	69377-81-7	253 > 195	255 > 197	7.8	1.13	1.75	5.7	0.9993
Flutriafol	C16H13F2N3O	76674-21-0	302 > 70	302 > 123	11.1	0.29	0.43	3.2	0.9984
Fosthiazate	C9H18NO3PS2	98886-44-3	284 > 104	284 > 228	10.7	0.05	0.12	2.7	0.9985
Furathiocarb	C18H26N2O5S	65907-30-4	383 > 195	383 > 252	15.1	0.07	0.13	1.8	1.0000
Halofenozide	C18H19ClN2O2	112226-61-6	331 > 105	331 > 275	12.3	0.05	0.05	1.7	0.9947
Halosulfuron-methyl*	C13H15ClN6O7S	100784-20-1	435 > 182	437 > 182	11.5	0.30	0.96	3.1	0.9968
Haloxypop acid*	C15H11ClF3NO4	69806-34-4	360 > 288	362 > 290	13.3	6.20	6.86	13.4	0.9999
Heptenophos	C9H12ClO4P	23560-59-0	251 > 127	251 > 89	11.4	0.15	1.36	4.7	0.9982
Hexythiazox	C17H21ClN2O2S	78587-05-0	353 > 228	353 > 168	15.6	2.25	1.02	4.5	0.9956

Table 1 – Continued...

Compound	Formula	CAS	Transition 1	Transition 2	Pear extract				
					RT (min.)	Transition 1 LOD (ppb)	Transition 2 LOD (ppb)	%RSD (10ppb)	R ²
Imazalil	C14H14Cl2N2O	35554-44-0	297 > 159	297 > 69	11.8	0.30	0.48	3.5	0.9988
Imidacloprid	C9H10ClN5O2	138261-41-3	256 > 209	256 > 175	6.4	0.50	0.50	1.9	0.9966
Indoxacarb	C22H17ClF3N3O7	144171-61-9	528 > 203	528 > 150	14.5	0.40	0.37	3.9	0.9964
Ioxynil*	C7H3I2NO	1689-83-4	370 > 127	370 > 215	11.0	0.12	1.00	3.6	0.9961
Iprovalicarb	C18H28N2O3	140923-17-7	321 > 119	321 > 203	13.1	0.06	0.23	2.5	0.9981
Isazofos	C9H17ClN3O3PS	42509-80-8	314 > 120	314 > 162	12.9	0.04	0.13	2.2	0.9994
Isocarbofos	C11H16NO4PS	24353-61-5	307 > 231	307 > 121	11.4	0.07	0.12	2.7	0.9991
Isufenphos	C15H24NO4PS	25311-71-1	346 > 245	346 > 217	14.3	0.17	0.13	1.7	0.9991
Isufenphos-methyl	C14H22NO4PS	99675-03-3	332 > 231	332 > 273	13.8	0.03	0.13	1.2	0.9996
Isoproc carb	C11H15NO2	2631-40-5	194 > 95	194 > 137	11.1	0.20	0.49	1.9	0.9990
Isoprothiolane	C12H18O4S2	50512-35-1	291 > 189	291 > 231	12.6	0.10	0.09	0.9	0.9994
Isoproturon	C12H18N2O	34123-59-6	207 > 72	207 > 46	11.3	0.10	0.11	1.7	0.9996
Isoxaben	C18H24N2O4	82558-50-7	333 > 165	333 > 150	12.6	0.02	0.06	0.9	0.9989
Kresoxim-methyl	C18H19NO4	143390-89-0	314 > 116	314 > 206	13.8	0.15	0.18	3.3	0.9991
Lenacil	C13H18N2O2	2164-08-1	235 > 153	235 > 136	11.2	0.18	0.64	2.2	0.9987
Linuron	C9H10Cl2N2O2	330-55-2	249 > 160	249 > 182	12.2	3.15	3.20	3.7	0.9979
Lufenuron*	C17H8Cl2F8N2O3	103055-07-8	509 > 339	509 > 175	15.2	0.35	2.39	3.8	0.9918
Malathion	C10H19O6PS2	121-75-5	348 > 127	348 > 331.2	12.6	0.04	0.31	1.0	0.9989
Mandipropamid	C23H22ClNO4	374726-62-2	412 > 328	412 > 356	12.5	0.11	0.45	4.2	0.9991
Mecarbam	C10H20NO5PS2	2595-54-2	330 > 227	330 > 97	13.2	0.15	0.30	2.0	0.9992
Meipanipirim	C14H13N3	110235-47-7	224 > 106	224 > 77	13.1	0.19	0.39	3.6	0.9993
Mepronil	C17H19NO2	55814-41-0	270 > 119	270 > 91	12.7	0.05	0.07	1.1	0.9972
Mesosulfuron-methyl	C17H21N5O9S2	208465-21-8	504 > 182	504 > 83	10.9	0.27	0.96	3.4	0.9996
Metaflumizone	C24H16F6N4O2	139968-49-3	507 > 178	507 > 287	15.1	2.63	3.42	6.6	0.9986
Metalaxyl	C15H21NO4	57837-19-1	280 > 220	280 > 192	11.3	0.04	0.06	1.9	0.9998
Metamitron	C10H10N4O	41394-05-2	203 > 175	203 > 104	7.0	0.21	0.44	2.3	0.9990
Metconazole	C17H22ClN3O	125116-23-6	320 > 70	322 > 125	14.2	0.10	0.30	3.6	0.9976
Methabenzthiazuron	C10H11N3OS	18691-97-9	222 > 165	222 > 150	11.1	0.11	0.19	0.9	0.9989
Methamidophos	C2H8NO2PS	10265-92-6	142 > 94	142 > 125	2.3	0.06	0.69	1.3	0.9991
Methiocarb	C11H15NO2S	2032-65-7	226 > 121	226 > 169	12.3	0.10	0.28	2.9	0.9948
Methiocarb sulfoxide	C11H15NO3S	2635-10-1	242 > 122	242 > 170	6.9	0.04	0.15	1.5	0.9996
Methomyl	C5H10N2O2S	16752-77-5	163 > 88	163 > 106	5.0	0.10	0.10	0.8	0.9996
Methoxyfenozide	C22H28N2O3	161050-58-4	369 > 149	369 > 313	12.7	0.50	1.00	1.7	0.9980
Metobromuron	C9H11BrN2O2	3060-89-7	259 > 148	259 > 91	10.9	0.35	0.63	3.2	0.9987
Metolachlor	C15H22ClNO2	51218-45-2	284 > 252	284 > 176	13.4	0.06	0.31	1.5	0.9962
Metolcarb	C9H11NO2	1129-41-5	166 > 109	166 > 94	9.1	0.12	0.29	2.4	0.9996
Metosulam	C14H13Cl2N5O4S	139528-85-1	418 > 175	418 > 140	10.1	0.24	0.23	2.2	0.9968
Metoxuron	C10H13ClN2O2	19937-59-8	229 > 72	229 > 156	8.7	0.04	0.30	1.4	0.9997
Metrafenone	C19H21BrO5	220899-03-6	409 > 209	409 > 227	14.4	0.09	0.10	1.3	0.9993
Metsulfuron-methyl	C14H15N5O6S	74223-64-6	382 > 167	382 > 77	9.2	0.19	0.97	1.2	0.9982
Mevinphos	C7H13O6P	7786-34-7	225 > 127	225 > 193	7.1	0.05	0.16	2.5	0.9998
Molinate	C9H17NOS	2212-67-1	188 > 126	188 > 55	12.9	2.08	1.25	3.1	0.9956
Monocrotophos	C7H14NO5P	6923-22-4	224 > 193	224 > 127	5.6	0.72	1.35	4.8	0.9991
Monuron	C9H11ClN2O	150-68-5	199 > 72	199 > 46	9.4	0.13	0.21	1.6	0.9995
Myclobutanil	C15H17ClN4	88671-89-0	289 > 70	289 > 125	12.8	0.23	0.44	2.6	0.9990
Neoquassin	C22H30O6	76-77-7	391 > 373	391 > 207	10.2	0.29	1.63	2.3	0.9970

Table 1 – Continued...

Compound	Formula	CAS	Transition 1	Transition 2	Pear extract				
					RT (min.)	Transition 1 LOD (ppb)	Transition 2 LOD (ppb)	%RSD (10ppb)	R ²
Nitenpyram	C11H15ClN4O2	120738-89-8	271 > 126	271 > 225	4.7	0.15	0.29	2.6	1.0000
Nuarimol	C17H12ClFN2O	63284-71-9	315 > 252	315 > 81	12.2	0.75	2.66	2.8	0.9990
Omethoate	C5H12NO4PS	1113-02-6	214 > 125	214 > 183	3.6	0.16	0.18	1.6	0.9998
Oxadixyl	C14H18N2O4	77732-09-3	296 > 279	296 > 219	9.0	0.25	0.26	1.7	0.9999
Oxamyl	C7H13N3O3S	23135-22-0	237 > 72	237 > 90	4.6	0.03	0.10	1.5	0.9999
Paclobutrazol	C30H40Cl2N6O2	76738-62-0	294 > 70	294 > 125	12.6	0.18	2.74	2.4	0.9982
Penconazole	C13H15Cl2N3	66246-88-6	284 > 70	284 > 159	13.9	0.17	0.20	2.6	0.9992
Pencycuron	C19H21ClN2O	66063-05-6	329 > 125	329 > 218	14.4	0.03	0.39	1.5	0.9992
Phenmedipham	C16H18N2O4	13684-63-4	318 > 168	318 > 136	11.8	0.36	0.32	1.0	0.9949
Phenthoate	C12H17O4PS2	2597-03-7	321 > 79	321 > 247	13.7	0.32	0.55	2.3	0.9993
Phorate sulfone	C7H17O5PS2	2588-04-7	293 > 171	293 > 97	11.0	0.51	0.26	3.4	0.9964
Phorate sulfoxide	C7H17O4PS2	2588-05-8	277 > 97	277 > 199	10.8	0.26	0.13	0.9	0.9979
Phosphamidon	C10H19ClNO5P	297-99-4	300 > 174	300 > 127	9.3	0.10	0.19	1.0	0.9998
Phoxim	C12H15N2O3PS	14816-18-3	299 > 77	299 > 129	14.1	0.25	0.30	2.0	0.9992
Picolinafen	C19H12F4N2O2	137641-05-5	377 > 238	377 > 145	15.2	0.26	1.38	5.4	0.9999
Picoxystrobin	C18H16F3NO4	117428-22-5	368 > 145	368 > 205	13.5	0.12	0.17	1.3	0.9994
Pirimicarb	C11H18N4O2	23103-98-2	239 > 72	239 > 182	10.8	0.05	0.10	2.1	0.9996
Pirimicarb-desmethyl	C10H16N4O2	152-16-9	225 > 72	225 > 168	8.5	0.04	0.04	1.7	0.9996
Prochloraz	C15H16Cl3N3O2	67747-09-5	376 > 308	376 > 70	14.3	0.10	0.19	2.8	0.9987
Profenofos	C11H15BrClO3PS	41198-08-7	375 > 305	375 > 347	15.0	0.30	0.38	2.6	0.9997
Promecarb	C12H17NO2	2631-37-0	208 > 109	208 > 151	12.5	0.44	0.42	3.1	0.9993
Prometryn	C10H19N5S	7287-19-6	242 > 158	242 > 200	13.1	0.07	0.08	1.6	0.9998
Propamocarb free base	C9H20N2O2	24579-73-5	189 > 102	189 > 74	3.1	0.23	0.22	1.4	0.9984
Propaquizafop	C22H22ClN3O5	111479-05-1	444 > 100	44 > 371	15.2	0.15	0.85	1.2	0.9990
Propiconazole	C15H17Cl2N3O2	60207-90-1	342 > 159	342 > 69	14.0	0.23	0.60	3.6	0.9998
Propoxur	C11H15NO3	114-26-1	210 > 111	210 > 168	9.7	0.07	0.08	2.6	0.9998
Propyzamide	C12H11Cl2NO	23950-58-5	256 > 190	258 > 192	12.7	1.83	1.94	6.0	0.9915
Prosulfuron	C15H16F3N5O4S	94125-34-5	420 > 141	420 > 167	11.7	0.43	0.82	2.0	0.9940
Prothioconazole	C14H15Cl2N3OS	178928-70-6	312 > 70	314 > 70	13.4	0.16	0.50	2.3	0.9952
Pymetrozine	C10H11N5O	123312-89-0	218 > 105	218 > 79	5.0	0.05	0.39	2.9	0.9994
Pyraclostrobin	C19H18ClN3O4	175013-18-0	388 > 194	388 > 163	14.2	0.50	1.00	1.9	0.9996
Pyrethrin I	C21H28O3	121-21-1	329 > 161	329 > 105	15.9	0.25	1.20	2.3	0.9998
Pyrethrin II	C22H28O5	121-29-9	373 > 161	373 > 133	14.6	0.70	2.27	4.2	0.9992
Pyrimethanil	C12H13N3	53112-28-0	200 > 107	200 > 82	12.3	0.10	0.50	0.9	0.9999
Pyriproxyfen	C20H19NO3	95737-68-1	322 > 96	322 > 185	15.5	0.07	0.10	0.6	0.9999
Quassia	C22H28O6	76-78-8	389 > 223	389 > 163	9.1	0.57	0.80	2.7	0.9968
Quinmerac	C11H8ClNO2	90717-03-6	222 > 204	222 > 141	6.8	0.09	0.45	1.8	0.9966
Quinoxifen	C15H8Cl2FNO	124495-18-7	308 > 197	308 > 162	15.6	0.18	0.23	3.2	0.9998
Rimsulfuron	C14H17N5O7S2	122931-48-0	432 > 182	432 > 325	10.0	0.31	0.64	2.8	0.9989
Rotenone	C23H22O6	83-79-4	395 > 213	395 > 192	13.5	0.44	0.52	3.5	0.9976
Spinosyn A	C41H65NO10	131929-60-7	733 > 142	733 > 98	14.1	0.03	0.19	1.6	0.9997
Spinosyn D	C42H67NO10	131929-63-0	747 > 142	747 > 98	14.6	0.20	0.97	3.3	1.0000
Spiromesifen	C23H30O4	283594-90-1	388 > 273	388 > 371	15.6	0.05	0.34	2.3	0.9998
Spiroxamine	C18H35NO2	118134-30-8	298 > 144	298 > 100	11.7	0.08	0.18	2.1	0.9999
Sulcotrione	C14H13ClO5S	99105-77-8	329 > 139	329 > 69	7.5	0.70	5.00	4.3	0.9969
Tebuconazole	C16H22ClN3O	107534-96-3	308 > 70	310 > 70	13.9	0.10	0.34	2.1	0.9993

Table 1 – Continued...

Compound	Formula	CAS	Transition 1	Transition 2	Pear extract				
					RT (min.)	Transition 1 LOD (ppb)	Transition 2 LOD (ppb)	%RSD (10ppb)	R ²
Tebufenozide	C22H28N2O2	112410-23-8	353 > 133	353 > 297	13.5	0.04	0.10	1.5	0.9980
Tebufenpyrad	C18H24ClN3O	119168-77-3	334 > 117	334 > 147	15.2	0.30	0.28	0.9	0.9998
Teflubenzuron*	C14H6Cl2F4N2O2	83121-18-0	379 > 339	379 > 359	15.3	0.29	0.40	3.6	0.9973
Terbufos sulfone	C9H21O4PS3	56070-16-7	321 > 97	321 > 171	12.1	0.55	0.52	3.8	0.9956
Terbufos sulfoxide	C9H21O3PS3	10548-10-4	305 > 187	305 > 97	12.1	0.09	0.09	1.3	0.9989
Tetraconazole	C13H11Cl2F4N3O	112281-77-3	372 > 159	372 > 70	13.2	0.29	0.55	2.6	0.9950
Thiabendazole	C10H7N3S	148-79-8	202 > 175	202 > 131	8.2	2.50	2.50	1.5	0.9987
Thiacloprid	C10H9ClN4S	111988-49-9	253 > 126	253 > 90	7.9	0.10	0.50	1.0	0.9991
Thiamethoxam	C8H10ClN5O3S	153719-23-4	292 > 211	292 > 181	5.3	0.04	0.08	2.4	0.9995
Thiodicarb	C10H18N4O4S3	59669-26-0	355 > 88	355 > 108	10.6	0.08	0.18	1.1	0.9991
Thiophanate-methyl	C12H14N4O4S2	23564-05-8	343 > 151	343 > 311	9.7	0.25	0.62	1.1	0.9967
Tolfenpyrad	C21H22ClN3O2	129558-76-5	384 > 197	384 > 91	15.3	0.28	0.73	3.0	0.9983
Triadimefon	C14H16ClN3O2	43121-43-3	294 > 69	294 > 197	12.8	0.24	0.31	2.6	0.9985
Triadimenol	C14H18ClN3O2	55219-65-3	296 > 70	298 > 70	13.1	0.24	0.54	3.7	0.9982
Triasulfuron	C14H16ClN5O5S	82097-50-5	402 > 141	402 > 167	9.6	0.42	0.36	1.5	0.9993
Triazamate acid*	C11H18N4O3S	112143-82-5	287 > 198	287 > 170	10.1	0.09	0.26	4.4	0.9996
Triazophos	C12H16N3O3PS	24017-47-8	314 > 162	314 > 119	12.9	0.02	0.12	1.5	0.9992
Triclopyr*	C7H4Cl3NO3	55336-06-3	256 > 198	254 > 196	11.1	1.95	1.81	8.9	0.9969
Tricyclazole	C9H7N3S	41814-78-2	190 > 136	190 > 163	8.3	0.10	0.20	2.3	0.9993
Trifloxystrobin	C20H19F3N2O4	141517-21-7	409 > 186	409 > 145	14.6	0.02	0.05	1.2	0.9994
Triflumizole	C15H15ClF3N3O	68694-11-1	346 > 278	346 > 43	14.8	0.09	0.09	1.3	0.9996
Triflumuron*	C15H10ClF3N2O3	64628-44-0	357 > 154	357 > 176	14.2	1.76	3.12	4.6	0.9991
Triforine	C10H14Cl6N4O2	26644-46-2	435 > 390	437 > 392	11.7	0.92	3.53	4.8	0.9963
Triticonazole	C17H20ClN3O	131983-72-7	318 > 70	320 > 70	13.2	0.40	0.41	1.9	0.9993
Zoxamide	C14H16Cl3NO2	156052-68-5	336 > 187	336 > 159	14.0	0.09	0.29	1.3	0.9951
2,4-D*	C8H6Cl2O3	94-75-7	219 > 161	219 > 125	10.3	1.09	5.00	9.7	0.9980

* Negative electrospray ionisation

3.2 Rapid screening of different mobile phase compositions on signal response

The signal intensity in LCMS can be strongly influenced by the mobile phase composition. In order to optimise the signal intensity, pesticides were added into vials containing different mobile phase compositions and injected into the interface with no column installed. The Nexera auto-sampler was setup to inject an air gap both before and after the injected sample in order to prevent the sample mixing with carrier mobile phase. This approach enables a large number of potential mobile phase compositions to be screened in a short automated period of time and without the need to manually change mobile phases. Ten different mobile phase compositions were tested, including: ammonium acetate, ammonium formate, formic acid, acetic acid, and ammonium formate with formic acid in water:methanol or acetonitrile 1:1. A total of 23 different pesticides were assessed, selected to include a range of different polarities and both positively and negatively ionised compounds. The different mobile phases tested and their peak area response, relative to the

highest peak area response obtained for that compound, are shown in Table 2.

As expected with multi residue methods, there was not one optimum mobile phase for all pesticides. Overall, the lowest signal was achieved for mobile phases containing water:methanol only, and the mobile phase containing water:acetonitrile 10 mM ammonium acetate. Negatively ionised compounds (fludioxinil and ioxynil) provided superior responses in water:methanol 10mM ammonium acetate, while the addition of either formic acid or acetic acid decreased response. The highest signals were typically found in 10 mM ammonium formate, 10mM ammonium acetate, and 10 mM ammonium formate with 0.1 % formic acid. The effect of methanol and acetonitrile in the mobile phase was also investigated. Comparison of 10mM ammonium formate in methanol and acetonitrile showed that intensities were typically lower with the use of acetonitrile. Similarly the use of ammonium acetate in methanol and acetonitrile presented the same trend. The same observation with regards to methanol and acetonitrile for pesticide analysis have been reported by others.¹³

Table 2 - Results of rapid mobile phase screening using flow injection analysis for 23 pesticides. All peaks areas were normalised against the maximum peak area achieved for that compound. Accordingly, 100 % indicates the highest peak area achieved and is highlighted.

Compound	H ₂ O:MeOH	H ₂ O:MeOH 0.05% Formic acid	H ₂ O:MeOH 0.1% Formic acid	H ₂ O:MeOH 0.2% Formic acid	H ₂ O:MeOH 5mM Ammonium acetate	H ₂ O:MeOH 10mM Ammonium acetate	H ₂ O:MeOH 20mM Ammonium acetate	H ₂ O:MeOH 50mM Ammonium acetate	H ₂ O:MeCN 10mM Ammonium acetate	H ₂ O:MeOH 10mM Ammonium formate	H ₂ O:MeCN 10mM Ammonium formate	H ₂ O:MeOH 0.1% Acetic acid	H ₂ O:MeOH 0.1% Formic acid 50mM ammonium formate
Atrazine	52	100	99	88	52	71	66	62	48	80	50	52	87
Azinphos-methyl	14	32	32	27	75	98	87	59	26	100	26	30	96
Azoxystrobin	27	30	29	25	69	87	77	58	65	100	82	29	99
Carbendazim	66	100	91	92	37	42	38	32	26	71	36	64	81
Chlorantraniliprole	100	46	52	41	69	81	92	69	27	91	60	94	56
Cyprodinil	66	94	88	86	55	63	57	41	51	100	82	67	78
Difenoconazole	27	85	90	72	70	100	92	73	59	99	62	61	90
Fludioxinil	69	42	38	37	74	100	95	84	60	94	81	55	76
Imazalil	85	69	62	63	66	78	73	62	51	100	68	58	74
ioxynil	100	47	41	43	41	60	60	51	34	62	53	55	53
Isoproturon	28	34	34	30	74	93	84	75	78	100	90	30	98
Metalaxyl	30	31	31	25	68	92	81	76	79	100	87	31	92
Myclobutanil	15	71	75	57	65	100	91	73	23	86	25	58	84
Pirimicarb	82	85	76	78	66	90	80	68	68	100	80	66	78
Pirimicarb-desmethyl	72	90	81	83	64	85	74	67	64	100	82	70	86
Prochloraz	38	100	94	89	47	65	56	45	45	61	46	64	64
Pyraclostrobin	33	32	30	27	62	78	70	55	61	100	82	26	93
Pyrimethanil	54	100	92	91	54	65	54	31	48	92	74	62	76
Tebufenozide	28	40	40	36	70	88	78	65	73	96	84	33	100
Thiabendazole	96	100	91	89	58	69	61	48	37	99	60	67	84
Thiacloprid	16	28	28	25	53	59	45	32	34	86	49	18	100
Thiophanate methyl	24	21	24	17	62	77	62	44	34	98	43	31	100
Triadimenol	17	96	100	81	56	88	86	74	44	79	46	66	74
Minimum	14	21	24	17	37	42	38	31	23	61	25	18	53
Maximum	100	100	100	92	75	100	95	84	79	100	90	94	100
Average	50	64	62	57	61	80	72	58	49	91	63	52	83

3.3 Performance Optimising Injection Sequence (POISe)

In reversed phase UHPLC, early eluting compounds typically display the greatest peak distortion. Peak distortion is a particular problem in pesticide analysis as samples are typically extracted by QuEChERS, with samples diluted in 100% acetonitrile (a strong eluting solvent). To solve this issue, laboratories may decide to dilute the acetonitrile extracts in water before LCMS injection. However, doing so adds an additional sample preparation step and dilution in water can also negatively affect the stability of some analytes.¹⁴

To minimise peak dispersion with the injection of acetonitrile extracts, one potential solution is the use of a band compression technique.¹⁵ Band compression is achieved by injecting a band of weak eluting solvent onto the column after the analytes. As the analyte and the weak eluting solvent bands travel towards the column, minute mixing occurs. Therefore, the analytes are dissolved in a weak eluting solvent when they reach the column leading to isocratic band compression.

The performance optimising injection sequence (POISe) was evaluated by injecting between 5 – 40 μL of water following a 3 μL injection of pear extract in 100% acetonitrile. This was achieved using the Nexera auto-sampler (SIL-30AC) pre-treatment program to perform this function.

Figure 1 shows the injection of pear extract *with* and *without* the performance optimising injection sequence. Using POISe, band dispersion was minimised considerably for early eluting pesticides, with peak widths reduced by 5-69%. The optimum amount of water to inject following the sample was found to be 30 μL . Increasing this volume to 40 μL did not provide any significant improvements. Early eluting compounds are affected by the injection of a weak eluting solvent band to a much larger extent in comparison to analytes with higher retention factors. This improvement is due to the reduction in the sample solvent elution strength, which has a large impact on the early eluting compounds. Whereas, analytes with higher retention factors will experience some degree of band compression in the mobile phase already. Table 3 lists the peak width for 11 early eluting compounds. Compounds are arranged in retention time order to show the improvement using the POISe on early eluting analytes.

(A) 3 μL pear extract injection *without* the POISe

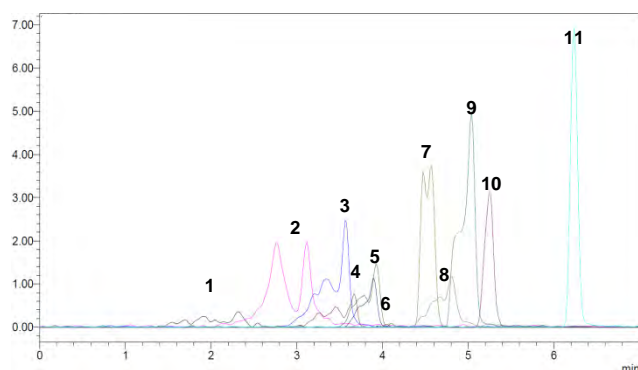

(B) 3 μL pear extract injection *with* the POISe (30 μL water)

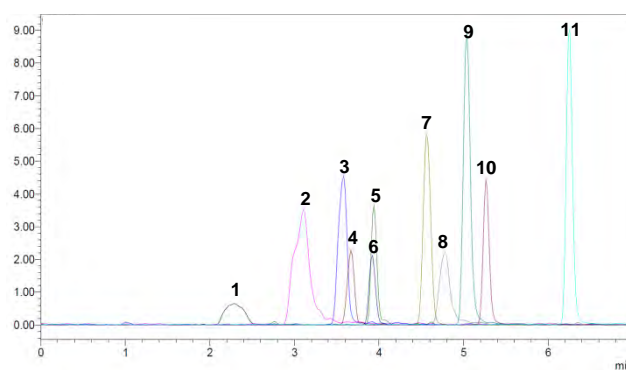

Figure 1 – Pear extract (0.050 mg kg^{-1}) injected without (A) and with (B) the performance optimising injection sequence

Table 3 – Peak widths obtained with and without the performance optimising injection sequence

No.	Compound	Peak width (min.)		Peak width change (%)
		Without POISe	With POISe	
1	Methamidophos	1.193	0.466	-60.9
2	Propamocarb	0.937	0.473	-49.5
3	Omethoate	0.773	0.247	-68.0
4	Butocarboxim sulfoxide	0.664	0.205	-69.1
5	Aldicarb sulfoxide	0.545	0.195	-64.2
6	Dinotefuran	0.460	0.247	-46.3
7	Oxamyl	0.317	0.248	-21.8
8	DMPF	0.309	0.254	-17.8
9	Demeton-S-methyl sulfoxide	0.418	0.271	-35.2
10	Demeton-S-methyl sulphone	0.277	0.248	-10.5
11	Ethiofencarb sulphone	0.233	0.220	-5.6

3.4 UHPLC gradient optimisation

Based on the results of the mobile phase screening investigation (section 3.2) the three superior compositions were tested: 1) 10 mM ammonium formate, 2) 10 mM ammonium acetate and 3) 10 mM ammonium formate with 0.1 % formic acid. Separation was achieved using a Shim-Pack XR-ODS III, 2.0 x 150 mm, 2.2 μ m particle size. Ammonium formate was found to be the most effective compromise for all 210 compounds in terms of signal to noise ratios and peak shapes.

However two problems with ammonium formate were observed; early elution of asulum and poor peak shape of propamocarb. Consequently, 0.01 % formic acid was tested and found to increase the retention of asulum, and improve the peak shape of propamocarb. The addition of acid was found to shorten the retention time of cyromazine (RT 2.2 min.), yet this retention time was still in excess of 2 column volumes as required in quality control procedures for pesticide residues analysis in food and feed.¹³

A number of pesticide isomers have identical transitions and consequently must be separated chromatographically. Employing a 16 minute gradient resulted in resolution greater than 1 between all necessary pesticides including: butocarboxim sulphoxide / aldicarb sulphoxide, ethiofencarb sulphone / methiocarb sulphone, diuron / fluometronsulam and desmedipham / phenmedipham. Figure 2 highlights the excellent peak shapes achieved on the Nexera UHPLC.

3.5 Final method performance

In order to assess the performance of the LCMS-8040 for real samples, limits of detection, linearity and repeatability were

determined in food extracts. Linearity was assessed from 0.5 – 200 ppb in four types of sample: (1) acetonitrile, (2) dried fruit extract, (3) lettuce extract and, (4) pear extract. All 210 pesticides achieved excellent correlation coefficients greater than 0.99 in all four types of matrix with typical values greater than 0.997. Correlation coefficients are listed in Table 1 for all pesticides in pear extract, and the calibration curves of eight selected pesticides shown in Figure 3.

Pesticide limits of detection were calculated based on the method described by the US-EPA (see experimental section). Limits of detection were assessed for both the quantifying transition and the qualifying transition and are listed in Table 1. All of the studied pesticides presented LODs less than the 0.01 mg kg⁻¹ reporting level for both transition 1 and 2.

A limit of detection less than 0.001 mg kg⁻¹ (1ppb) was achieved for the quantifying transition and less than 0.002 mg kg⁻¹ (2 ppb) for the qualifying transition for 90 % of compounds: thereby highlighting the excellent sensitivity of the LCMS-8040 for pesticide analysis. Furthermore, these limits of detection were achieved with an injection volume of only 2 μ L. Therefore, detection limits could be reduced even further with larger injection volumes. An injection volume of 2 μ L was used in the study to allow the injection of 100 % acetonitrile extracts without detriment to early eluting peak shapes.

Repeatability was assessed at the 0.01 mg kg⁻¹ reporting level as peak area %RSD for six replicate injections in pear extracts. Repeatability less than 5 %RSD was achieved for 92 % of the 210 pesticides studied. All of the studied compounds presented repeatability less than 10 %RSD, with exception of haloxyfop acid (13.4 %).

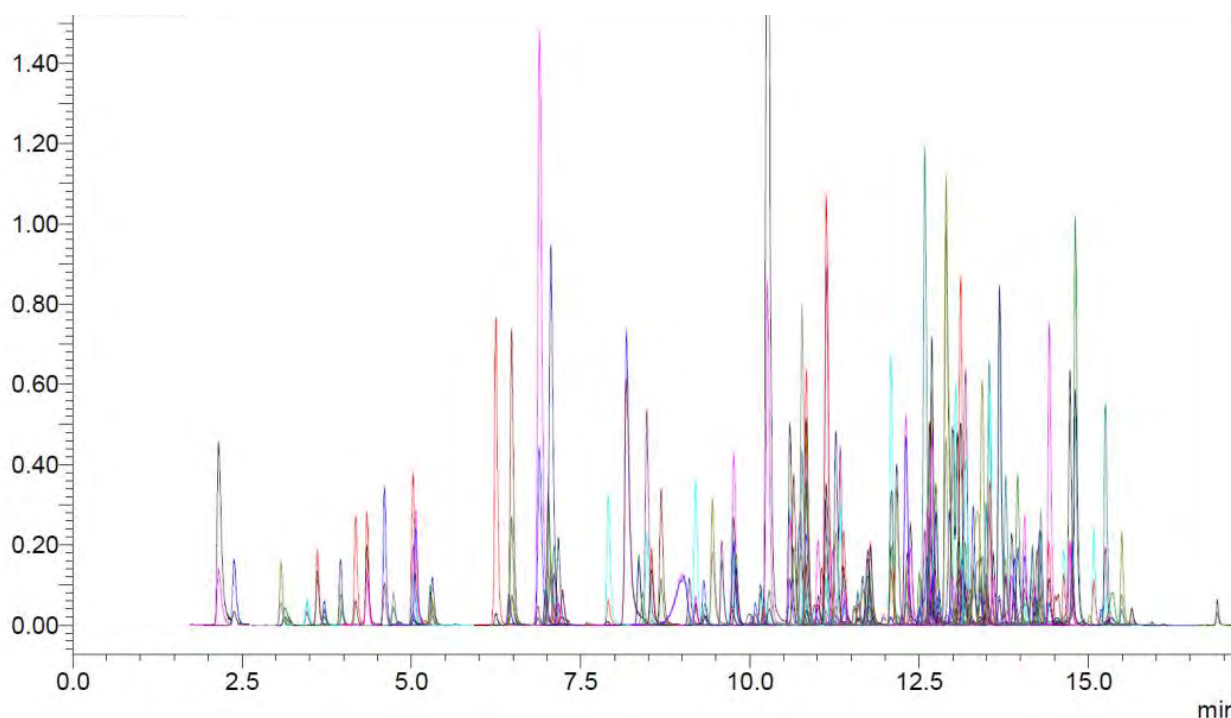

Figure 2 – Extracted ion chromatogram of 210 pesticides using the Shimadzu Nexera UHPLC and the Shimadzu LCMS-8040; 2 μ L injection of a 0.05 mg kg⁻¹ standard solution.

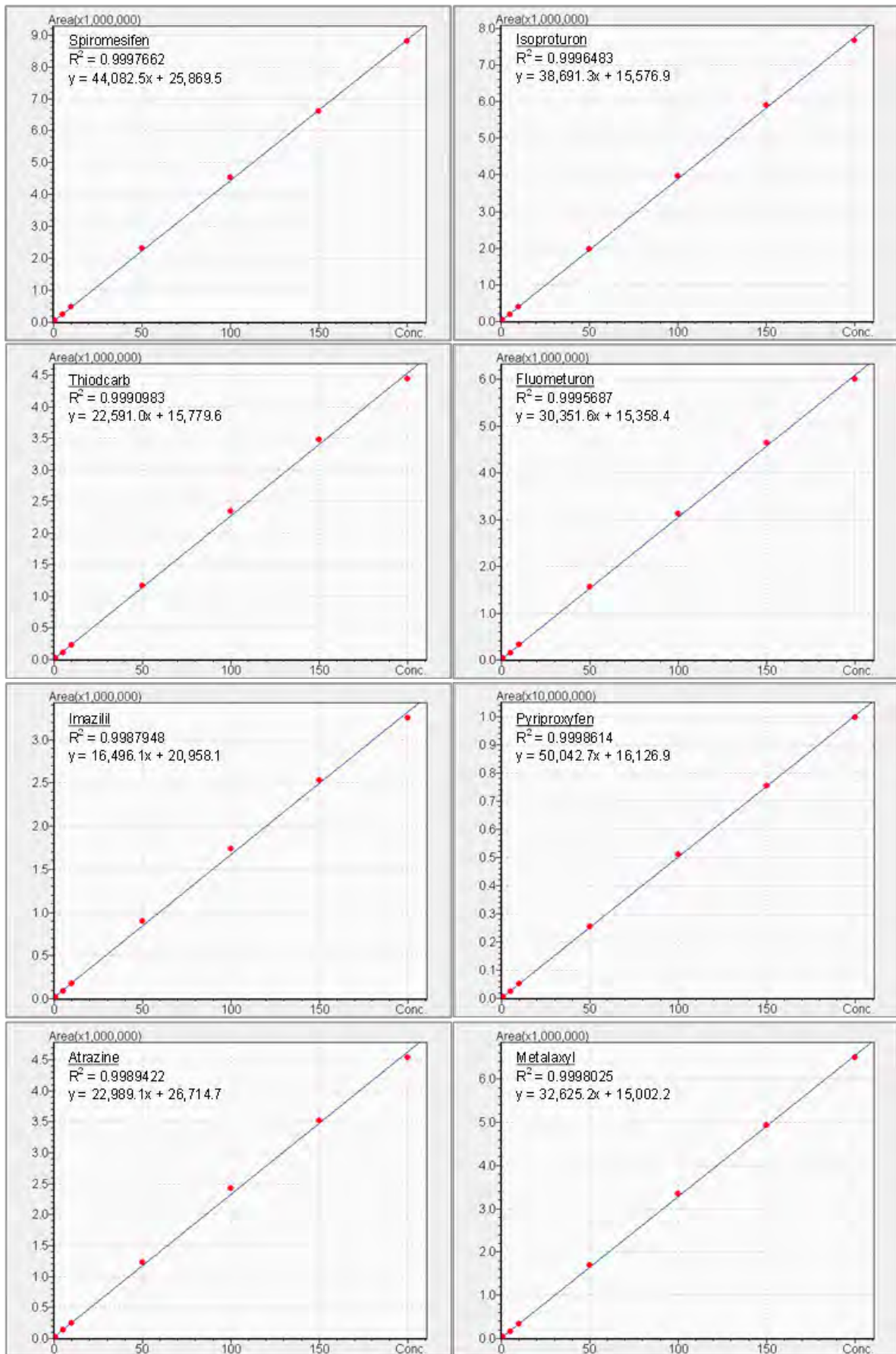

Figure 3 – Calibration curves, $0.5 \mu\text{g kg}^{-1}$ - 0.2mg kg^{-1} (0.5 – 200 ppb), of eight pesticides in pear matrix

4. Conclusion

The results of the developed methodology show that the Shimadzu LCMS-8040 triple quadrupole can achieve excellent sensitivity, linearity and repeatability in food extracts for over 200 commonly analysed pesticides. Limits of detection were less than 0.01 mg kg⁻¹ (10 ppb) for both the quantifying and qualifying transitions for all compounds studied, while for 90% of compounds was less than 0.001 mg kg⁻¹ (1ppb) (quantifying transition) and 0.002 mg kg⁻¹ (2 ppb) (qualifying transition); therefore providing excellent response, especially given that the injection volume was only 2µL. The sensitivity of the LCMS-8040 was able to meet the 0.01 mg kg⁻¹ (10 ppb) requirements of regulatory guidelines such as those established by the EU and Japan. Repeatability at the 0.01 mg kg⁻¹ reporting level was less than 5% for nearly all compounds and correlation coefficients greater than 0.99 for all compounds in a variety of food samples. Consequently the LCMS-8040 is ideally suited for routine monitoring of pesticides in regulatory laboratories.

Acknowledgements

The authors wish to thank the staff at the Food and Environment Agency, UK, for providing food sample extracts and pesticide reference standards.

5. References

1. H. V. Botitsi, S. D. Garbis, A. Economou and D. F. Tsiipi, *Mass Spectrometry Reviews* 2011, 30, 907-939.
2. C. Solera, J. Mañesa and Y. Picó, *Critical Reviews in Analytical Chemistry* 2008, 38, 93-117.
3. Commission Regulation (EC). 2005. No 396/2005 of the European Parliament and of the Council, maximum residue levels of pesticides in or on food and feed of plant and animal origin. *Official Journal of the European Union*, L 70: 1-16
4. Commission Directive 2006/141/EC of 22 December 2006 on infant formulae and follow-on formulae and amending Directive 1999/21/EC. *Official Journal of the European Union* L401: 1-33.
5. US Environmental Protection Agency, Electronic code of federal regulation: Title 40: Part 180 - tolerances and exemptions for pesticide chemical residues in food. http://www.ecfr.gov/cgi-bin/text-idx?c=ecfr&tpl=/ecfrbrowse/Title40/40cfr180_main_02.tpl
6. Japanese Ministry of Health, Labour and Welfare, Department of Food Safety. 2006. Director Notice about Analytical Methods for Residual Compositional Substances of Agricultural Chemicals, Feed Additives, and Veterinary Drugs in Food (Syoku-An No. 0124001 January 24, 2005; amendments May 26, 2006).
7. Republic of China National Standard GB 2763-2005. 2005. Maximum residue limits for pesticides in food, Ministry of Health of the People's Republic of China and Ministry of Agriculture of the People's Republic of China.
8. Republic of China National Standard GB 28260-2011. 2011. Maximum residue limits for 85 pesticides in food, Ministry of Health of the People's Republic of China and Ministry of Agriculture of the People's Republic of China
9. L. Alder, K. Greulich, G. Kempe and B. Vieth, *Mass Spectrometry Reviews* 2006, 25, 838-865
10. US Environmental Protection Agency, Procedure 40 CFR, Part 136, Appendix B.
11. EURL datapool, EU Reference Laboratories, <http://www.eurl-pesticides-datapool.eu>
12. European Commission, SANCO. 2011. Method validation and quality control procedures for pesticide residues analysis in food and feed, Document SANCO/12495/2011
13. C. Jansson, T. Pihlström, B.-G. Österdahl and K. E. Markides, *Journal of Chromatography A* 2004, 1023, 93-104.
14. K. Maštovská and S. J. Lehotay, *Journal of Chromatography A* 2004, 1040, 259-272
15. A. C. Sanchez, J. A. Anspach and T. Farkas, *Journal of Chromatography A* 2012, 1228, 338-348

Application News

No. C136

Liquid Chromatography Mass Spectrometry

Expanding Capabilities in Multi-Residue Pesticide Analysis Using The LCMS-8060

David R. Baker¹, Laëtitia Fages², Eric Capodanno², Neil Loftus¹
¹Shimadzu Corporation, UK; ²Phytocontrol, France

■ Abstract

With an increasing global population, food security is increasingly under threat and there is a growing challenge for agriculture to produce more food, safely and more sustainably. The use of herbicides, insecticides, and fungicides reduce crop losses both before and after harvest, and increase crop yields. However, pesticide residues resulting from the use of plant protection products on crops may pose a risk to human health and require a legislative framework to monitor pesticide residues in food.

National programs for pesticide monitoring in the US, Europe and Japan have set Maximum Residue Levels (MRL's) or tolerance information (EPA) for pesticides in food products. A default value of 0.01 mg/kg is applied for MRL enforcement, which therefore requires highly sensitive and specific analytical technologies to monitor an increasing number of pesticides.

This application note describes the expanded capability of the LCMS-8060 to help accelerate method development workflows and support increased pesticide monitoring programs. Using the Shimadzu Pesticide MRM Library (the Library includes information on 766 certified reference materials) a single multi-residue LC/MS/MS method was developed for 646 pesticides (3 MRM transitions for over 99 % targeted pesticides resulting in 1,919 transitions in total, with a polarity switching time of 5 msec).

Keywords: Pesticides; food safety; LCMS-8060; Pesticide MRM Library, 776 compound library

■ Introduction

There are more than 1,000 pesticides used globally on soil and crops. With the ever increasing international trade of the food industry, regulatory bodies around the world have increased the number of regulated pesticides and the maximum residue levels (MRLs) allowed in food commodities. In the EU, regulation 396/2005/EC and its annexes set MRLs for over 500 pesticides in 370 food products.¹⁾ In the US, tolerances for more than 450 pesticides and other ingredients are established by the US EPA²⁾ and Japan's positive list system for agricultural chemical residues in foods contains MRLs for over 400 pesticides in various commodities.³⁾

National pesticide monitoring programs create new challenges for food safety laboratories as the number of pesticides required for analysis is increasing together with an expanded range of food products.

In this application paper we present the development of a LC-MS/MS method for screening and quantifying over 646 pesticides in a single method. The method

was quickly and efficiently set up using the Shimadzu Pesticide MRM Library. For each target pesticide analysis, up to 3 MRMs (Multiple Reaction Monitoring) transitions were imported from the library. 3 MRMs transitions provided additional data confidence in reporting results in comparison to the conventional 2 transitions used in most methods. As the LCMS-8060 has a high data acquisition speed 1,919 transitions were acquired using a polarity switching speed of 5 msec over a 10.5 minutes gradient elution.

To evaluate the method QuEChERS extracts of mint, tomato and apple were provided by a commercial laboratory as raw acetonitrile extracts and spiked with 646 pesticides (data is presented on the mint extract as it is the more complex sample matrix). The method was evaluated in matrix to ensure that the reporting limits were in agreement with recognised MRL's.

■ Experiment

Food extracts of mint, tomato and apple were supplied by Phytocontrol, France, following established QuEChERS protocols. Final extracts were prepared in acetonitrile without any dilution. Certified reference materials for the Shimadzu Pesticide MRM Library were obtained from ACSD, France as stock solutions. All solvents were of LCMS quality purchased from Sigma-Aldrich.

A six point calibration curve from 0.002 - 0.1 mg/kg (2 - 100 pg/ μ L) were generated using internal standard method. Two internal standards (Atrazine-d5 and Diuron-d6) were spiked in during the auto-sampler sequence for quantitation.

The robustness of the LCMS-8060 was assessed by peak area response for 646 pesticides spiked into mint, tomato and apple matrix extracts at 0.05 mg/kg.

■ LC/MS/MS method development

The Shimadzu Pesticide MRM Library has 766 pesticides in its database (Application News No. C135). For each pesticide several MRM's are included in the database and in this analysis the default value used was 3 MRM's. For this method, 1,919 transitions were selected in both positive and negative ionisation mode using a switching time of 5 msec (1,819 MRM transitions were in positive mode and 100 MRM transitions in negative mode).

To optimize ion source conditions (for example, DL temperature, interface temperature, heating block temperature, heating gas flow, drying gas flow and nebulizer gas flow) the interface setting software was used. This tool provides an optimized response for all compounds.

Table 1 LC and MS/MS Acquisition Parameters

Liquid chromatography		Mass spectrometry	
UHPLC	Nexera LC system	LC/MS/MS	LCMS-8060
Analytical column	Restek Raptor Biphenyl (2.1 mm I.D. × 100 mm L., 2.7 μm)	Ionisation mode	Heated electrospray
Column temperature	35 °C	Polarity switching time	5 msec
Flow rate	0.4 mL/min	Pause time	1 msec
Solvent A	2 mmol/L ammonium formate + 0.002 % formic acid - Water	Total MRM transitions	1,919 (1,819 positive; 100 negative)
Solvent B	2 mmol/L ammonium formate + 0.002 % formic acid - Methanol	MRM Dwell	4 msec (target ion); 1 msec (reference ion)
Binary Gradient B.Conc.	3 % (0 min) - 10 % (1.00 min) - 55 % (3.00 min) - 100 % (10.50 - 12.00 min) - 3 % (12.01 - 15.00 min)	Interface temperature	350 °C
Injection volume	2 μL sample (plus 40 μL water)	Heating block	300 °C
		Desolvation line	150 °C
		Heating gas	10 L/min
		Drying gas	10 L/min
		Nebulizer gas	3 L/min

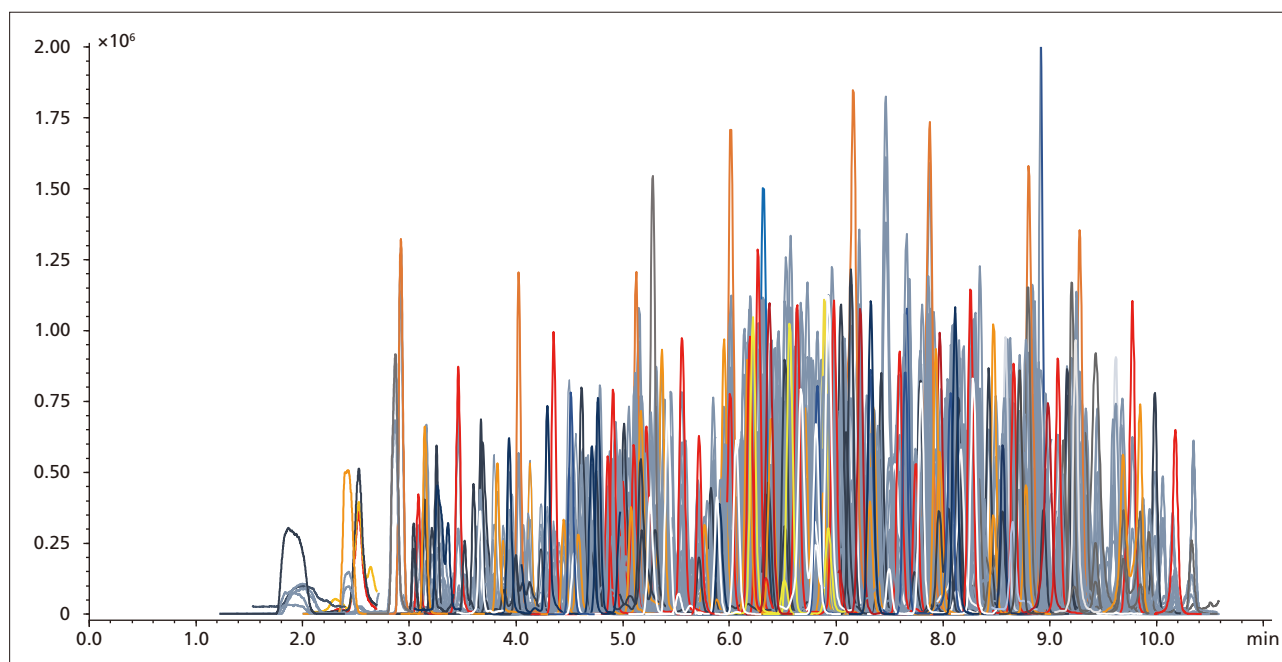

Fig. 1 MRM chromatograms of 646 pesticides spiked into a mint extract at 0.01 mg/kg (Up to 3 MRMs per compound and 5 msec polarity switching time).

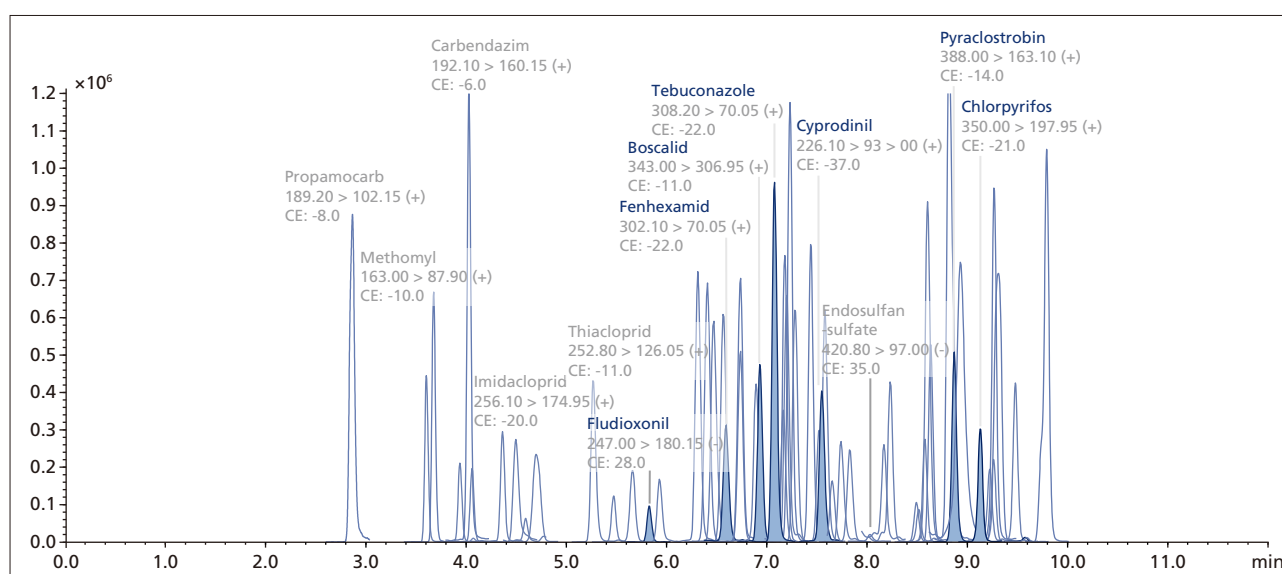

Fig. 2 MRM chromatograms for pesticides most commonly detected in plant products listed in the 2015 European Food Safety Journal. In this report, residues exceeding the legal limits were related to 58 different pesticides. Compounds such as boscalid, chlorpyrifos, cyprodinil, fenhexamid, fludioxonil, pyraclostrobin and tebuconazole (highlighted in the MRM chromatogram) are some of the most frequently detected compounds present in more than 4 % of the samples analyzed.

The MRM chromatograms show the response to each pesticide spiked into a food matrix at the default MRL of 0.01 mg/kg.

Results and Discussion

Shimadzu Pesticide MRM Library

(Application News No. C135)

A flexible tool for expanding capabilities in pesticide monitoring programs

The Pesticide MRM Library has been created using 766 certified reference materials and is designed to help accelerate method development and compound management.

The library contains an average of 8 optimized MRM transitions for each compound (including positive and negative ion modes). In total, more than 6,000 MRM transitions are held within the 766 compound library. The library itself documents CAS#, formula, activity, mono-isotopic mass and adduct masses, rank of MRM transitions, synonyms, InChI, InChIKey, compound names translation (Japanese and Chinese) and links to websites offering further information (for example; alanwood.net, PAN pesticide database, Chemical Book, ChemSpider).

The library also serves as a powerful data repository for reporting and checking pesticide data sources.

Creating flexible pesticide monitoring methods

Building a new LC/MS/MS method

To create new pesticide LC/MS/MS methods the user simply needs to select the target compounds from the library, identify the required number of MRMs for each compound and confirm the analytical column for the analysis. (The new method can be used to expand current capabilities or to create focused methods with a limited number of pesticides). The new method is simply imported into LabSolutions.

As the LCMS-8060 has a high data acquisition speed of 30,000 u/sec, high sensitivity and a polarity switching speed of 5 msec, the capabilities of the library can be expanded to meet the future needs of any laboratory.

Expanded capability of the LCMS-8060

The LCMS-8060 has a data acquisition speed of 30,000 u/sec which creates new opportunities for expanding compound lists.

As one example, between 6.45 and 6.60 minutes 25 pesticide compounds elute (Fig. 3). Even with high data density acquisitions the average variation in peak area response was less than 3 %RSD (varying between 1.1 - 5.9 %RSD).

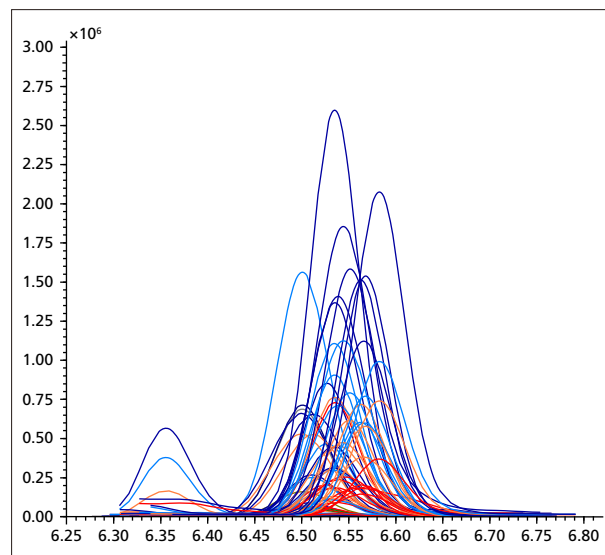

Fig. 3 The LCMS-8060 can acquire MRM data at a high speeds and enables precise quantitation even with high data density. Between 6.45 and 6.60 minutes 25 compounds were monitored (Table 2).

Table 2 Peak area variation (%RSD; n=6) for 25 pesticides eluting over a nine-second time window (6.45 - 6.60 minutes) spiked into a mint matrix extract at the reporting limit of 0.01 mg/kg.

Compound Name	CAS number	Formula	M	Polarity	MRM Quantitation Ion	RT	Average Peak Area	%RSD (n=6)
Trinexapac-ethyl	95266-40-3	C13H16O5	252.0998	+	252.90 > 69.05	6.45	1,780,015	3.1
lprovalicarb	140923-17-7	C18H28N2O3	320.2100	+	321.20 > 119.15	6.46	1,442,486	2.8
Dodemorph	1593-77-7	C18H35NO	281.2719	+	282.30 > 116.15	6.47	658,920	4.2
Fluopyram	658066-35-4	C16H11ClF6N2O	396.0464	+	397.00 > 145.00	6.47	2,439,146	1.9
Flutolanil	66332-96-5	C17H16F3NO2	323.1133	+	324.10 > 242.00	6.48	3,372,285	2.7
Trifloxysulfuron	145099-21-4	C14H14F3N5O6S	437.0617	+	438.00 > 182.15	6.48	1,822,340	2.5
Azaconazole	60207-31-0	C12H11Cl2N3O2	299.0228	+	300.00 > 159.00	6.50	1,580,445	2.0
Terbutryn	886-50-0	C10H19N5S	241.1361	+	242.10 > 157.95	6.50	755,446	3.4
Prometryn	7287-19-6	C10H19N5S	241.1361	+	242.10 > 158.00	6.50	1,300,193	2.6
Azimsulfuron	120162-55-2	C13H16N10O5S	424.1026	+	425.10 > 182.10	6.50	2,498,050	1.8
Metominostrobin	133408-50-1	C16H16N2O3	284.1161	+	285.10 > 193.95	6.51	2,929,500	1.7
Thifluzamide	130000-40-7	C13H6Br2F6N2O2S	525.8421	+	528.60 > 148.05	6.51	193,982	5.9
Nicarbazin	330-95-0	C13H10N4O5	302.0651	-	301.10 > 137.15	6.52	973,101	2.6
Bromobutide	74712-19-9	C15H22BrNO	311.0885	+	312.10 > 194.10	6.53	1,829,781	2.1
Saflufenacil	372137-35-4	C17H17ClF4N4O5S	500.0544	+	501.00 > 198.00	6.53	465,224	2.3
Cyproconazole	94361-06-5	C15H18ClN3O	291.1138	+	292.10 > 70.05	6.54	1,174,967	1.7
Clomazone	81777-89-1	C12H14ClNO2	239.0713	+	239.90 > 125.00	6.54	3,409,656	1.7
Fensulfothion	115-90-2	C11H17O4PS2	308.0306	+	309.00 > 281.00	6.54	4,267,514	1.4
Oxasulfuron	144651-06-9	C17H18N4O6S	406.0947	+	407.10 > 150.15	6.54	2,911,533	1.1
Rimsulfuron	122931-48-0	C14H17N5O7S2	431.0569	+	432.00 > 182.00	6.55	4,722,065	1.8
Fenthion-oxon	6552-12-1	C10H15O4PS	262.0429	+	263.10 > 231.00	6.55	3,075,195	1.4
Nitrothal-isopropyl	10552-74-6	C14H16NO6Na	317.0875	+	295.10 > 230.95	6.56	2,199,581	3.0
Chlorantraniliprole	500008-45-7	C18H14BrCl2N5O2	480.9708	+	483.90 > 452.90	6.57	2,407,025	2.7
Fipronil-sulfone	120068-36-2	C12H4Cl2F6N4O2S	451.9336	-	451.00 > 414.90	6.57	2,843,708	2.0
Valifenalate	283159-90-0	C19H27ClN2O5	398.1608	+	399.20 > 155.00	6.59	3,845,335	1.9

Final method performance for 646 pesticides

In order to test the performance of the developed method, linearity, repeatability and longer term robustness were assessed for all 646 pesticides.

Linearity

Linearity was assessed over a six point calibration curve from 0.002 - 0.1 mg/kg (2 - 100 pg/μL). All 646 pesticides achieved excellent R² values greater than 0.99 in both tomato and mint spiked extracts with typical values greater than 0.996. Calibration curves were generated using a linear curve fit type and 1/C weighting. Typical calibration curve data is presented below in Fig. 4.

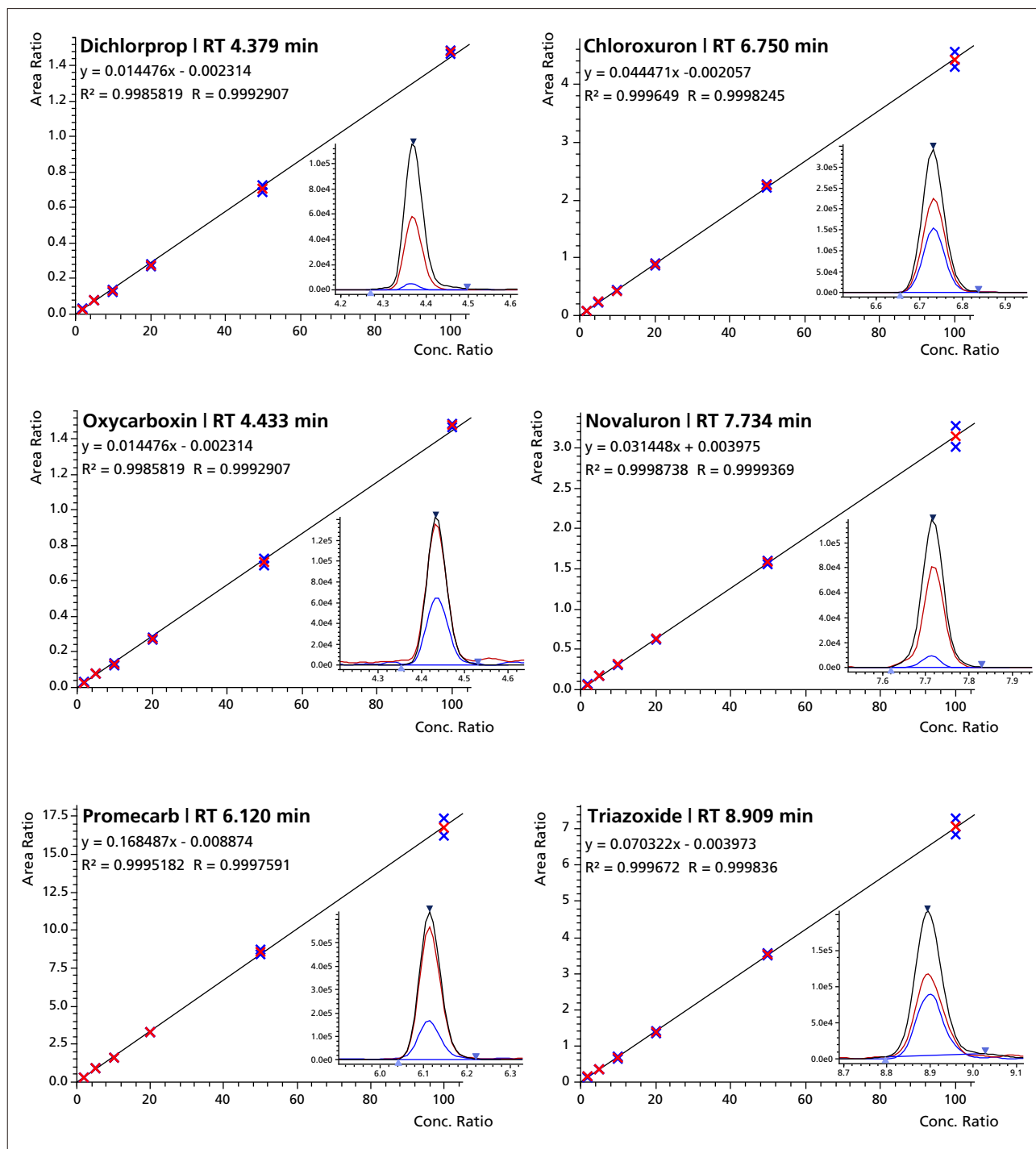

Fig. 4 Calibration curves for selected pesticides spiked into a mint matrix extract in the range 0.002 - 0.1 mg/kg. The quantitation MRM chromatogram is shown in black (qualifier ion MRM chromatograms are shown in red and blue).

Repeatability

To assess the robustness of the system and the developed method during routine analysis, repeat injections of a mint matrix sample spiked with 646 pesticides at 0.05 mg/kg, were analyzed over a 24 hour period.

The results for selected compounds are displayed below in Fig. 5.

Compounds were selected throughout the run at equidistant points (closest elution points to 3, 4, 5, 6, 7, 8, 9 and 10 minutes), including positive and negative ion detection, (Table 3).

The peak area variance was less than 5.7 % for all pesticides measured.

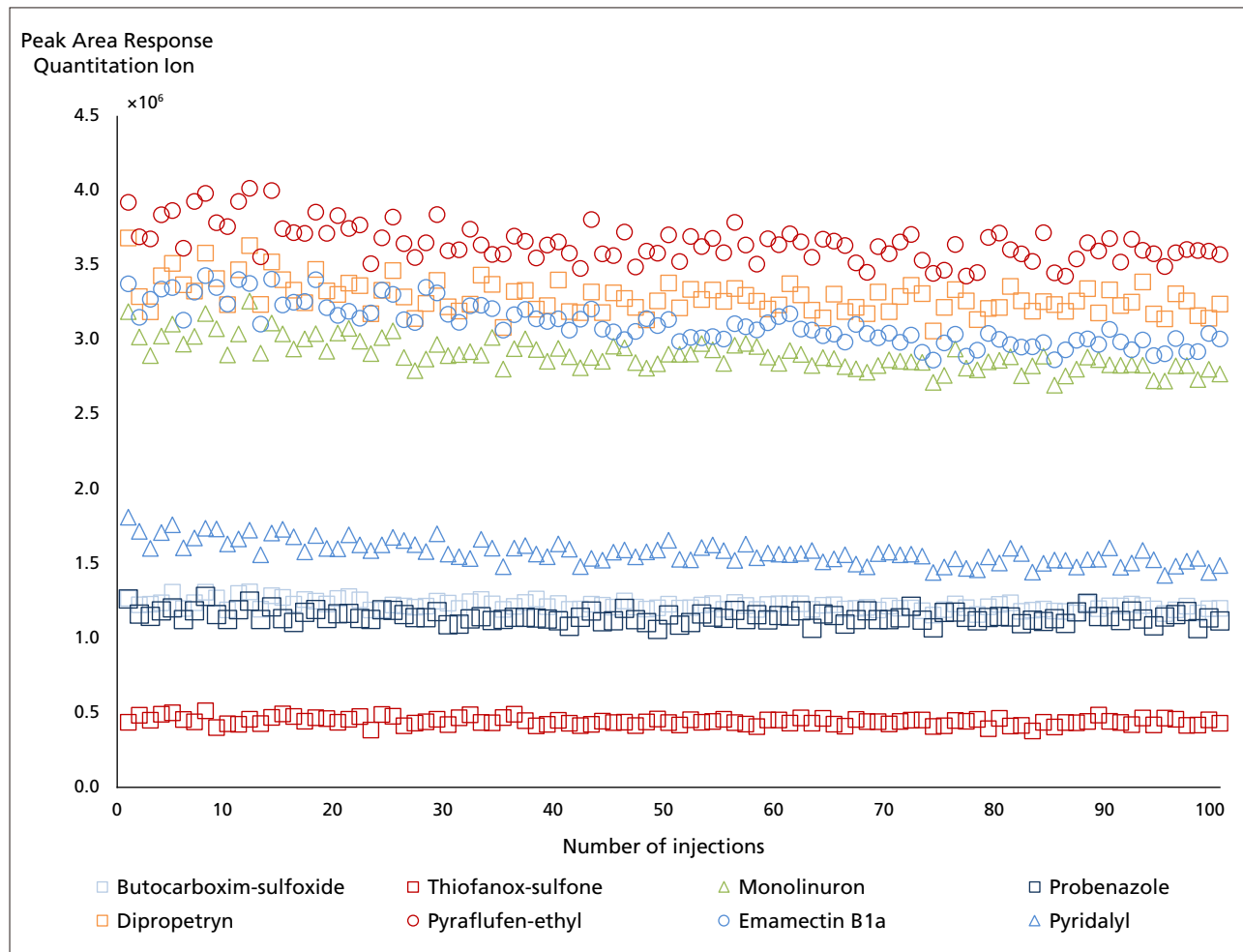

Fig. 5 Peak area response for several pesticides following 100 repeat injections of a 0.05 mg/kg spiked into mint matrix extract.

Table 3 Peak area variance for selected following the repeated injection of a 0.05 mg/kg spiked into mint matrix extract (number of sample replicates was 100; the analysis sequence was 24 hours).

Compound Name	CAS Number	Formula	M	Polarity	MRM Quantitation Ion	RT (mins)	Average Peak Area	%RSD (n=100)
Butocarboxim-sulfoxide	34681-24-8	C7H14N2O3S	206.0725	+	207.10 > 75.10	3.042	1,220,391	2.6
Thiofanox-sulfone	39184-59-3	C9H18N2O4S	250.0987	+	268.10 > 57.00	4.001	442,724	5.7
Monolinuron	1746-81-2	C9H11ClN2O2	214.0509	+	215.10 > 99.10	4.985	2,904,116	3.7
Probenazole	27605-76-1	C10H9NO3S	223.0303	+	224.00 > 41.05	5.995	1,145,189	3.5
Dipropetryn	4147-51-7	C11H21N5S	255.1518	+	256.20 > 144.05	6.999	3,289,597	3.4
Pyraflufen-ethyl	129630-19-9	C15H13Cl2F3N2O4	412.0204	+	413.00 > 339.00	8.004	3,653,333	3.5
Emamectin B1a	138511-97-4	C56H81NO15	1007.5606	+	886.40 > 158.20	9.008	3,109,562	4.5
Pyridalyl	179101-81-6	C18H14Cl4F3NO3	488.9680	-	491.90 > 109.05	10.171	1,579,422	5.0

Response to differing matrices

One of the major challenges in the quantitative LC/MS/MS analysis for pesticides in food is that compound and matrix-dependent response suppression or enhancement may occur. Although matrix effects can affect the peak area response between different food types following a QuEChERS extraction protocol, the peak area variance should be minimized within a single matrix.

Food extracts of apple, mint and tomato following QuEChERS extraction were spiked with 646 pesticides at 0.05 mg/kg and were repeatedly injected on the LCMS-8060 (n=100 repeat injections for each matrix; 300 injections in the same batch sequence). Fig. 6 shows the response for 3 selected pesticides analyzed in a single batch sequence corresponding to a 72 hour analysis sequence. Within a matrix, variance was less than 5.9 %RSD for all compounds.

Although the absolute peak area changes with different food matrices, the response between injection 1 and injection 100 for 2 pesticides (probenazole and dipropetryn) within a single matrix has a variance less than 5.7 %RSD.

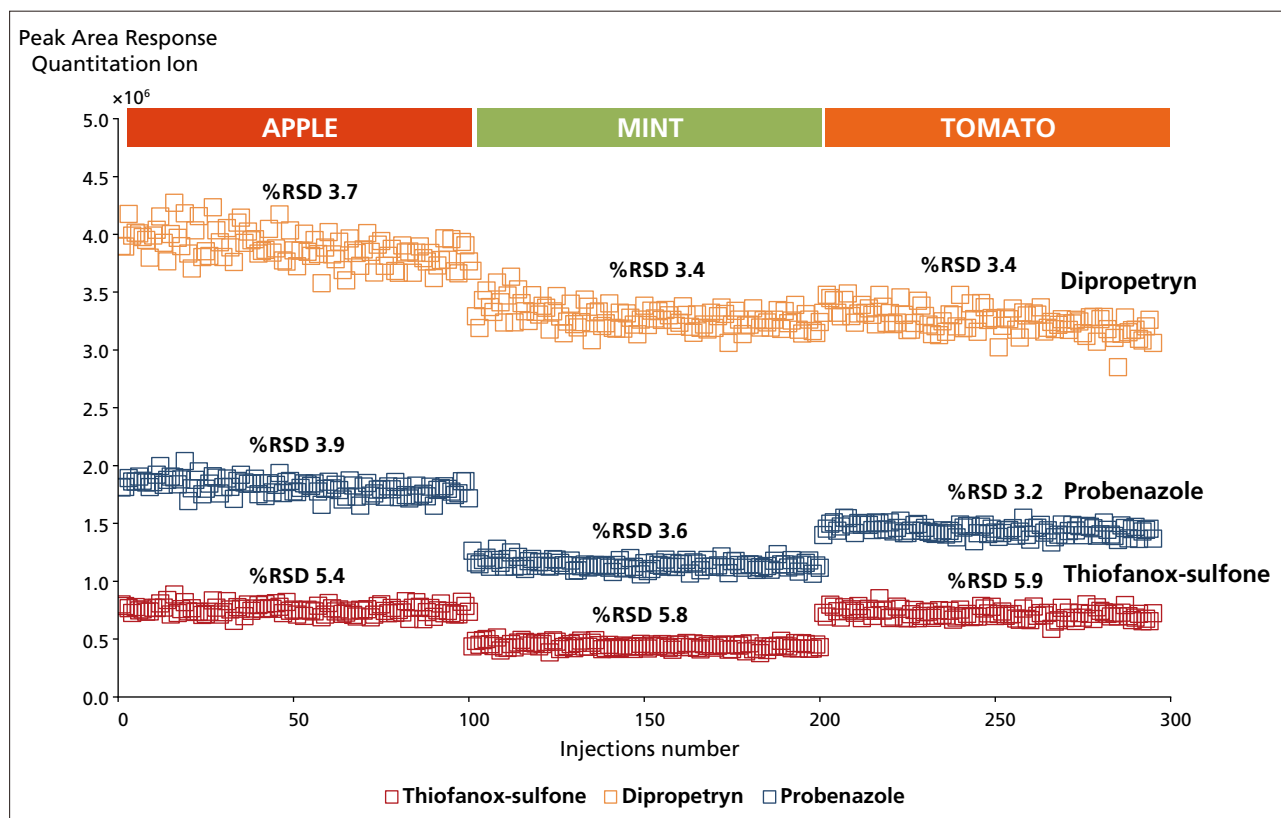

Fig. 6 Peak area response for three pesticides spiked into apple, mint and tomato matrix extracts at 0.05 mg/kg over 72 hours. As in Fig. 5, compounds were selected to reflect peak area response throughout the chromatographic run (Table 3).

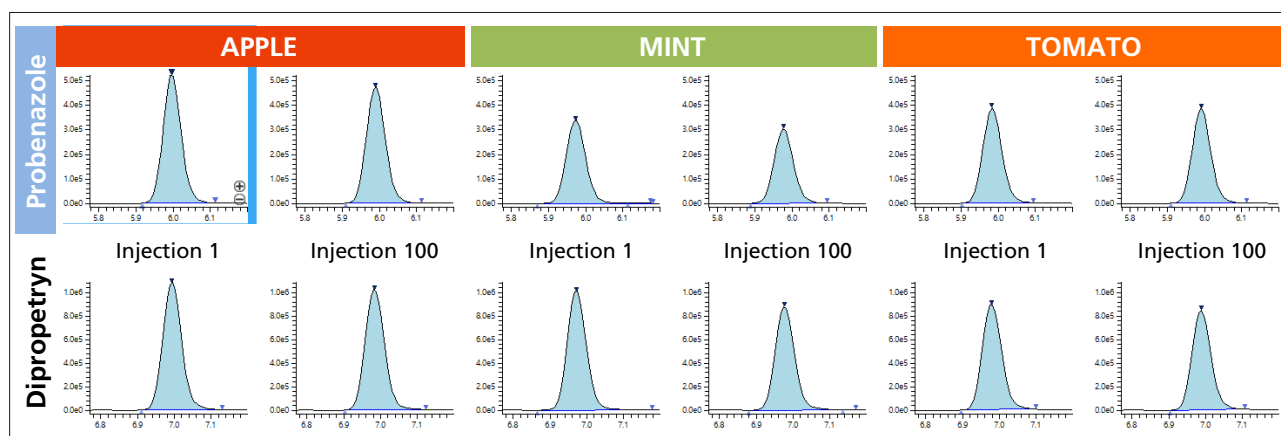

Fig. 7 MRM chromatograms for probenazole (RT 5.995 minutes) and dipropetryn (RT 6.999 minutes) for injection 1 and injection 100 spiked into apple, mint and tomato matrix extracts. The extracts were spiked at 0.05 mg/kg and analyzed over 72 hours.

Reducing matrix effects by extensively diluting the sample

The need to test for more pesticides in a wider range of samples at high sensitivity is very challenging as matrix effects from the sample extraction will influence both ion suppression and enhancement. Ion suppression can lead to errors in the detection capability, accuracy and precision of the method.

To reduce the effect of interfering compounds in the quantitation of complex samples extensive sample dilution is now widely used in routine analysis. It is an approach which is simple to build into multi-residue extraction methods and is cost effective.

This approach leads to greater robustness as a consequence of a reduced sample injection in the LC/MS/MS, higher data quality and increased instrument uptime.

Fig. 8 shows the results of diluting a matrix sample spiked at 0.005 mg/kg with dilution factors of 1:5, 1:10, 1:20, 1:50 and 1:100.

As matrix effects can be both significant and variable for different compounds Table 4 shows recovery data for a series of pesticides diluted from 0 to a dilution factor of 1:100.

Matrix suppression was reduced for most compounds when the sample was diluted 1:10 with recoveries in the range of 70 - 120 % with an associated repeatability RSDr ≤ 20 %. Relative standard deviations in relation to the mean values were typically less than 10 %.

Diluting the sample by a factor of 20 or 50 resulted in acceptable signal suppression from the matrix.

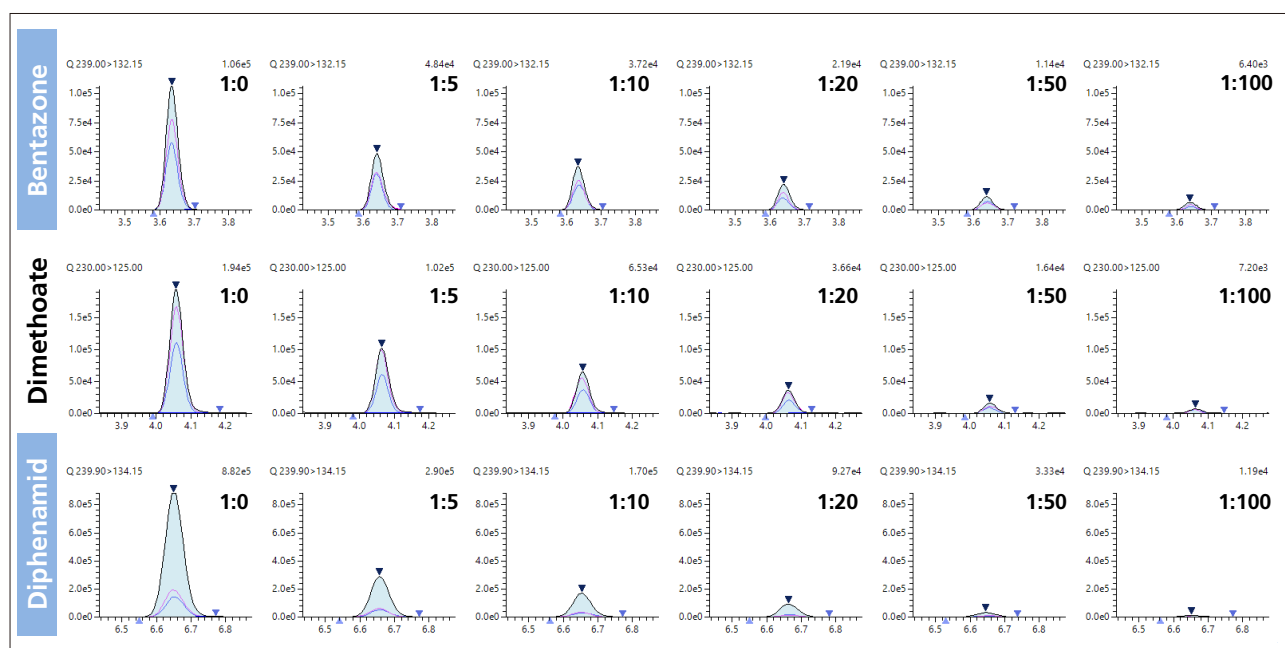

Fig. 8 MRM chromatograms for 3 selected compounds spiked into a mint extract at 0.005 mg/kg and diluted 1:5, 1:10, 1:20, 1:50 and 1:100 with water.

Table 4 Diluting a sample matrix extract spiked with 0.005 mg/kg with water reduced matrix ion suppression.

Compound	CAS	Formula	M	Dilution series					
				0	1:5	1:10	1:20	1:50	1:100
Bentazone	25057-89-0	C10H12N2O3S	240.0569	32.1	44.6	65.5	72.7	91.7	98.1
Demeton-S-methyl-sulfone	17040-19-6	C6H15O5PS2	262.0099	51.1	78.5	89.6	91.1	114.2	116.8
Dimethoate	60-51-5	C5H12NO3PS2	228.9996	36.2	65.3	88.5	92.2	92.4	94.2
Isocarbamid	30979-48-7	C8H15N3O2	185.1164	28.8	57.1	81.8	98.7	102.5	96.4
Vamidothion	2275-23-2	C8H18NO4PS2	287.0415	53.6	76.3	98.2	98.5	101.5	114.1
Thiazafurion	25366-23-8	C6H7F3N4OS	240.0293	32.8	62.9	80.5	84.2	87.1	97.4
Demeton-S-methyl	919-86-8	C6H15O3PS2	230.0200	57.8	82.1	93.1	87.6	108.5	102.4
Sebuthylazine	7286-69-3	C9H16ClN5	229.1094	28.7	53.3	69.8	79.8	88.5	95.8
Flutriafol	76674-21-0	C16H13F2N3O	301.1027	27.3	46.1	71.4	76.1	81.8	87.3
Furametpyr	123572-88-3	C17H20ClN3O2	333.1244	48.3	69.8	86.9	86.2	97.6	101.9
Fenobucarb	3766-81-2	C12H17NO2	207.1259	60.9	79.2	100.7	96.1	102.8	103.9
Benodanil	15310-01-7	C13H10INO	322.9807	50.9	69.8	86.3	96.5	102.4	94.8
Terbuthylazine	5915-41-3	C9H16ClN5	229.1094	50.4	66.6	83.2	87.2	89.8	91.0
Dimethachlor	50563-36-5	C13H18ClNO2	255.1026	75.1	86.1	106.0	107.1	106.2	108.0
Dimethenamid	87674-68-8	C12H18ClNO2S	275.0747	72.6	84.9	102.9	100.0	103.6	97.3
Furalaxyl	57646-30-7	C17H19NO4	301.1314	82.2	89.1	106.6	108.6	106.2	102.4
Bixafen	581809-46-3	C18H12Cl2F3N3O	413.0310	66.8	79.3	99.0	95.6	103.7	97.1
Triflumuron	64628-44-0	C15H10ClF3N2O3	358.0332	54.2	71.8	95.5	84.9	95.3	101.7
Epoxiconazole	133855-98-8	C17H13ClFN3O	329.0731	61.6	77.2	98.8	95.3	90.0	101.2
Teflubenzuron	83121-18-0	C14H6Cl2F4N2O2	379.9742	41.8	50.9	80.1	86.8	100.0	97.7

■ Conclusion

A fast, selective and highly sensitive method has been developed for the quantitation of 646 pesticides using a single method with 1,919 transitions (corresponding to up to 3 MRM transitions per compound) and a LC gradient time of only 10.5 minutes.

As the LCMS-8060 has a rapid polarity switching time of 5 msec, the single multi-residue LC/MS/MS method supported the analysis of 34 pesticides in negative ion mode and 612 compounds in positive ion mode.

The enhanced performance and higher sensitivity of the LCMS-8060 has created new opportunities in sample dilution to reduce ion signal suppression and matrix effects. For most compounds a dilution factor of 1:20 or 1:50 was sufficient to provide recoveries in the range 70 - 120 %.



■ References

1. Commission Regulation (EC). 2005. No 396/2005 of the European Parliament and of the Council, maximum residue levels of pesticides in or on food and feed of plant and animal origin. Official Journal of the European Union, L 70: 1-16
2. US Environmental Protection Agency, Electronic code of federal regulation: Title 40: Part 180 - tolerances and exemptions for pesticide chemical residues in food. http://www.ecfr.gov/cgi-bin/text-idx?c=ecfr&tpl=/ecfrbrowse/Title40/40cfr180_main_02.tpl
3. Japanese Ministry of Health, Labour and Welfare, Department of Food Safety. 2006. Director Notice about Analytical Methods for Residual Compositional Substances of Agricultural Chemicals, Feed Additives, and Veterinary Drugs in Food (Syoku-An No. 0124001 January 24, 2005; amendments May 26, 2006).

For Research Use Only. Not for use in diagnostic procedure.

This publication may contain references to products that are not available in your country. Please contact us to check the availability of these products in your country.

The content of this publication shall not be reproduced, altered or sold for any commercial purpose without the written approval of Shimadzu. Company names, product/service names and logos used in this publication are trademarks and trade names of Shimadzu Corporation or its affiliates, whether or not they are used with trademark symbol "TM" or "@". Third-party trademarks and trade names may be used in this publication to refer to either the entities or their products/services. Shimadzu disclaims any proprietary interest in trademarks and trade names other than its own.

The information contained herein is provided to you "as is" without warranty of any kind including without limitation warranties as to its accuracy or completeness. Shimadzu does not assume any responsibility or liability for any damage, whether direct or indirect, relating to the use of this publication. This publication is based upon the information available to Shimadzu on or before the date of publication, and subject to change without notice.

Application News

No. C103

Liquid Chromatography Mass Spectrometry

Analysis of Nivalenol, Deoxynivalenol, 3-Acetyldeoxynivalenol and 15-Acetyldeoxynivalenol Using Triple Quadrupole LC/MS/MS (LCMS-8050)

Nivalenol and deoxynivalenol are mycotoxins which are produced by the fusarium fungi. A provisional reference value of 1.1 ppm was established in Japan for deoxynivalenol (Notification No. 0521001 issued by the Pharmaceutical and Food Safety Bureau, Japanese Ministry of Health, Labour and Welfare on May 21, 2002). The test methods specified for deoxynivalenol are HPLC for both qualitative and quantitative analysis, and LC/MS for verification testing (Notification No.

0717001 issued by the Dept. of Food Safety, Pharmaceutical and Food Safety Bureau, Japanese Ministry of Health, Labour and Welfare on July 17, 2003).

This paper describes an LC-MS/MS method for high-sensitivity simultaneous analysis of the four compounds, nivalenol, deoxynivalenol and the deoxynivalenol metabolites, 3-acetyl-deoxynivalenol and 15-acetyl-deoxynivalenol.

■ Analysis of a Standard Mixture

Fig. 1 shows the chromatograms obtained using a 2 μ L injection of the four-component standard mixture (each 10 ppb), and Table 1 shows repeatability of retention time and peak areas for the four substances, respectively, using six repeat measurements.

Nivalenols are detected using the heated electrospray ionization (hESI) method in negative mode. Although water and acetonitrile alone can be used as the LC eluent for LC/MS analysis, higher sensitivity was obtained for each compound by adding low-concentration ammonium acetate (in this case, 0.5 mmol/L) to eluent A. Fig. 1 shows the mass chromatograms for the highest sensitivity MRM transitions for each compound. The analytical conditions are shown in Table 2.

Next, six repeat analyses of a 10 ppb standard solution were conducted, corresponding to approximately 1/100 the concentration of the provisional reference value. The relative standard deviations (%RSD) for the measured retention times and peak areas are shown in Table 1. Good repeatability was obtained for both retention time and peak area.

Table 1 Repeatability (10 ppb, n=6)

	R.T. %RSD	Area %RSD
Nivalenol	0.04	2.57
Deoxynivalenol	0.04	6.52
15-Acetyldeoxynivalenol	0.06	4.09
3-Acetyldeoxynivalenol	0.05	2.58

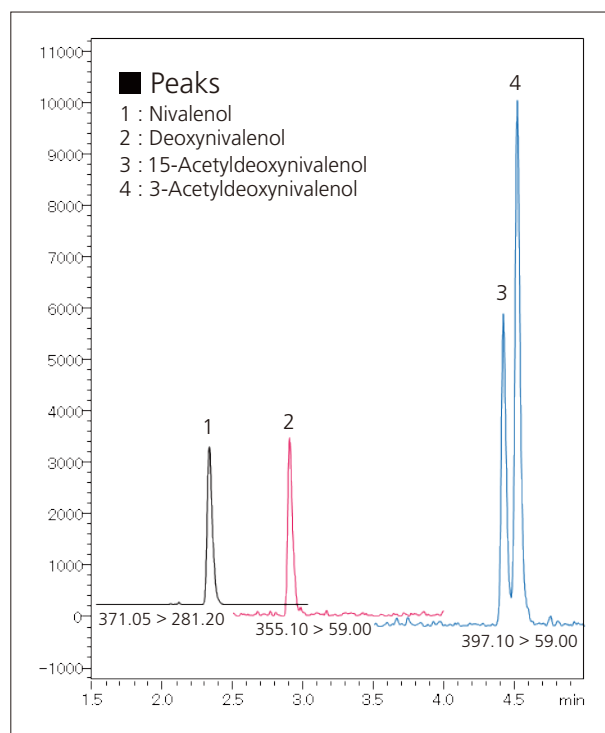

Fig. 1 MRM Chromatograms of a Standard Mixture (10 ppb each)

■ Linearity of Calibration Curves

Fig. 2 shows the calibration curves generated using the analytical conditions of Table 2. Excellent linearity with a coefficient of determination greater than $R^2 = 0.999$

was obtained for calibration curves using a concentration range from 1 to 250 ppb for each component.

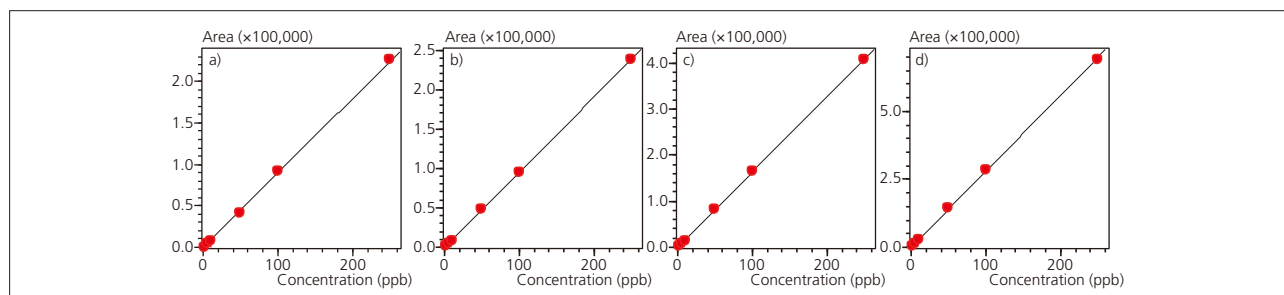

Fig. 2 Linearity of Calibration Curves: a) Nivalenol b) Deoxynivalenol c) 15-Acetyldeoxynivalenol d) 3-Acetyldeoxynivalenol

■ Analysis of Wheat

Fig. 3 describes the sample pretreatment procedure for wheat. The wheat extract solution was purified using either the MultiSep #227 multi-function column (Romer Labs) or the Autoprep MF-T column (Showa Denko K.K.). The chromatograms generated using the samples prepared using the MultiSep #227 (unspiked samples) and the standard-spiked samples, respectively, are shown in Fig. 4. The standard mixture was added to obtain a final concentration of 25 ppb for the four components (about 1/40 of the provisional reference

value), respectively. No large contaminant peaks were detected in the chromatograms of the pretreated samples. Furthermore, although deoxynivalenol was detected, it was at a level below that of the provisional reference value. The spike-and-recovery rates for the four components were excellent, from 101 to 107 %, without any particular matrix effects. Even in samples pretreated using Autoprep MF-T, comparable spike-and-recovery test results were obtained.

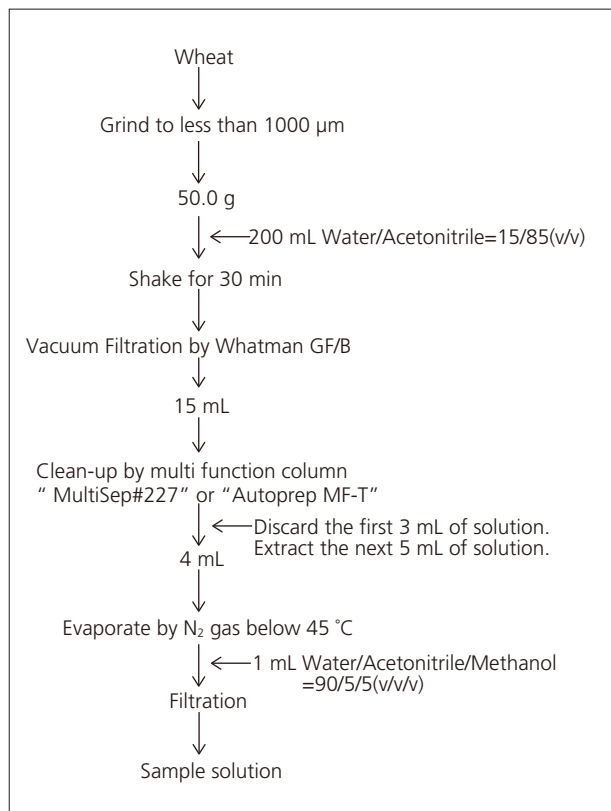

Fig. 3 Pretreatment

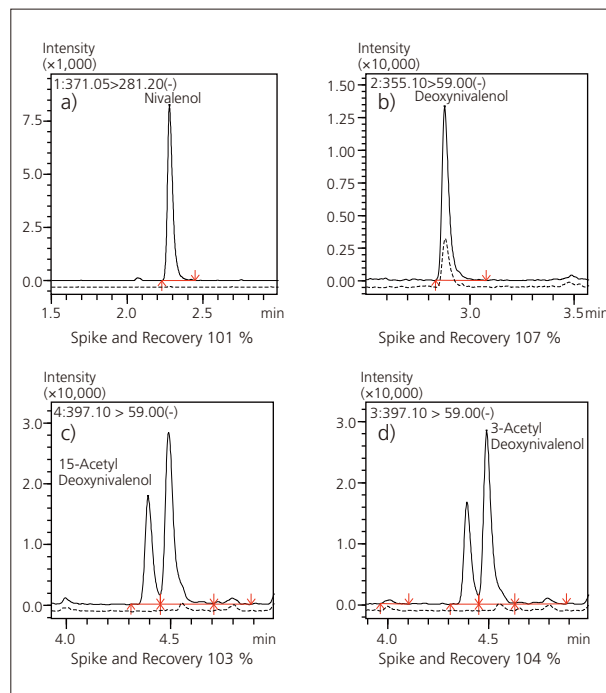

Fig. 4 Chromatograms of Wheat (Dotted line: Unspiked Sample, Solid line: Spiked at 25 ppb each)
a) Nivalenol b) Deoxynivalenol
c) 15-Acetyldeoxynivalenol d) 3-Acetyldeoxynivalenol

Table 2 Analytical Conditions

Column	: Shim-pack XR-ODS III (150 mm L. × 2.0 mm I.D., 2.2 μm)		
Mobile Phases	: A 0.5 mmol/L Ammonium Acetate - Water : B Acetonitrile		
Time Program	: 5 %B (0 min) → 45 %B (5.0 min) → 95 %B (5.01-7.0 min) → 5 %B (7.01 min) → STOP (12 min)		
Flowrate	: 0.3 mL/min		
Column Temperature	: 40 °C		
Injection Volume	: 2 μL		
Probe Voltage	: -3.0 kV (ESI-negative mode)		
DL Temperature	: 100 °C		
Block Heater Temperature	: 200 °C		
Interface Temperature	: 200 °C		
Nebulizing Gas Flow	: 2 L/min		
Drying Gas Flow	: 10 L/min		
Heating Gas Flow	: 10 L/min		
MRM Transition	: Nivalenol	371.05 > 281.20	CE: 16.0 V
	: Deoxynivalenol	355.10 > 59.00	CE: 22.0 V
	: 15-Acetyldeoxynivalenol	397.10 > 59.00	CE: 22.0 V
	: 3-Acetyldeoxynivalenol	397.10 > 59.00	CE: 26.0 V

Rapid analysis of polychlorinated biphenyls (PCBs) in vegetables by QuEChERS-based extraction and GPC–GCMS

ASMS 2015 ThP 041

Xizhi Wang, Shiheng Luo, Feifei Tian, Jun Fan,
Guixiang Yang, Taohong Huang, Shin-ichi Kawano,
Yuki Hashi
Shimadzu Global COE, Shimadzu (China) Co.,Ltd., CHINA

Rapid analysis of polychlorinated biphenyls (PCBs) in vegetables by QuEChERS-based extraction and GPC–GCMS

Overview

7 kinds of PCBs in two complicated matrix—carrot and ginger were analyzed by gel permeation chromatography coupled with gas chromatography-mass spectrometry (GPC–GCMS), which could remove majority of macromolecules such as oil and pigment.

Introduction

Polychlorinated biphenyls (PCBs), one of the most famous “dirtydozen” persistent organic pollutants (POPs) with carcinogenicity, teratogenicity and mutagenicity, are used to be produced and commercially used as mixtures. Because of their specific properties such as good stability, low volatility, insulativity and non-flammability, PCBs have been applied in a series of industrial applications such as coating, links, flame retardants, paints, electronic appliances, heat-transfer systems and hydraulic fluids.

Even PCBs were banned by most countries as early as 1970s, they can still be detected in air, soil, water, sediment and biota at a global scale, even in remote areas such as the polar regions, deep seas and high mountains. In this research, carrot and ginger were selected as representative samples analyzed by on-line GPC-GCMS system characterized by remove macromolecules for further purification.

Methods

Sample Preparation

The purification procedure was referenced to the QuEChERS method: 10g crushed sample, vortex in 10 mL acetonitrile, add 4 g of $MgSO_4$ and 1 g of NaCl; vortex mixed for 1 min and centrifuged for 10 min at 3000 rpm;

2 mL of the upper layer was transferred into a 5 mL centrifuge tube containing 150 mg of $MgSO_4$ and 25 mg of PSA, after vortex mixing for 1 min, centrifuged for 10 min at 3000 rpm and was ready for injection.

GPC-GCMS Analysis

Instrument	: GPC-GCMS (Shimadzu Corporation, Japan)
GPC system condition	
Column	: Shodex CLNpak EV-200 (2.1mm x 150mm)
Mobile phase	: acetone/ cyclohexane (3/7, v/v)
Flow rate	: 0.1 mL/min
Sample volume	: 10 μ L

Rapid analysis of polychlorinated biphenyls (PCBs) in vegetables by QuEChERS-based extraction and GPC–GCMS

GCMS system	
Retention gap	: 5 m x 0.53 mm
Pre-column	: Rtx-5 MS, 5 m x 0.25 mm x 0.25 µm
Analytical column	: Rtx-5 MS, 25m x 0.25mm x 0.25µm
Temp. program	: 82 °C (5 min)_8 °C/min_300 °C (7.75 min)
PTV injection temperature program	: 120 °C (5 min)_100 °C/min_250 °C (33.7min)
Injection pressure program	: 120 kPa (0 min)_100 kPa/min _180 kPa (4.4 min)_ (-49.8 kPa/min)_120 kPa (33.8 min)
Purge program	: 5.0 mL/min_(-10 mL/min)_ 0 mL/min (6 min)_ 10 mL/min_5 mL/min (5 min)
Sampling time	: 7 min
Solvent cut time	: 9.7 min
Interface temperature	: 300 °C
Ion source temperature	: 200 °C
Acquisition mode	: SIM

Table 1 GCMS parameters for PCBs

No.	Compound	CAS	Retention time	Quantitation ions	Qualification ions 1	Qualification ions 2
1	PCB28 (2,4,4'-Trichlorobiphenyl)	7012-37-5	20.74	256	258	186
2	PCB52 (2,2',5,5'-Tetrachlorobiphenyl)	35693-99-3	21.65	292	220	290
3	PCB101 (2,2',4,5,5'-Pentachlorobiphenyl)	37680-73-2	23.88	326	254	328
4	PCB118 (2,3',4,4',5-Pentachlorobiphenyl)	31508-00-6	25.42	326	328	324
5	PCB138 (2,2',3,4,4',5'-Hexachlorobiphenyl)	35065-28-2	25.96	360	362	290
6	PCB153 (2,2',4,4',5,5'-Hexachlorobiphenyl)	35065-27-1	26.63	360	362	290
7	PCB180 (2,2',3,4,4',5,5'-Heptachlorobiphenyl)	35065-29-3	28.23	396	394	324

Results

The results of this research indicated that the relative coefficients of the 7 kinds of PCBs ranged from 1 to 500 µg/L were above 0.998. Precision (n=6) of this method was measured by analyzing the sample at 1 µg/L. The overall RSDs of analysis were below 5%. The limit of detection (LOD; S/N=3) of most compounds were below 0.05 µg/L. Commercially available carrot and ginger

were used for recovery test, spiked concentration was 10 µg/kg and the recoveries of carrot were between 97% and 125% and those of ginger were between 85% and 104%. The developed method in this study was proved to be reliable and accurate, and permits rapid determination of PCBs can be easily applied for quality control of vegetables.

Rapid analysis of polychlorinated biphenyls (PCBs) in vegetables by QuEChERS-based extraction and GPC–GCMS

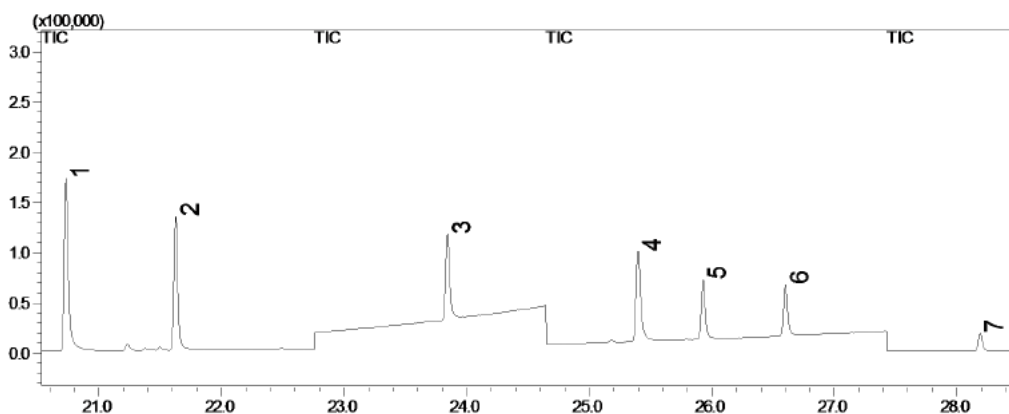

Figure 1 SIM chromatograms of PCBs (10 ng/mL)

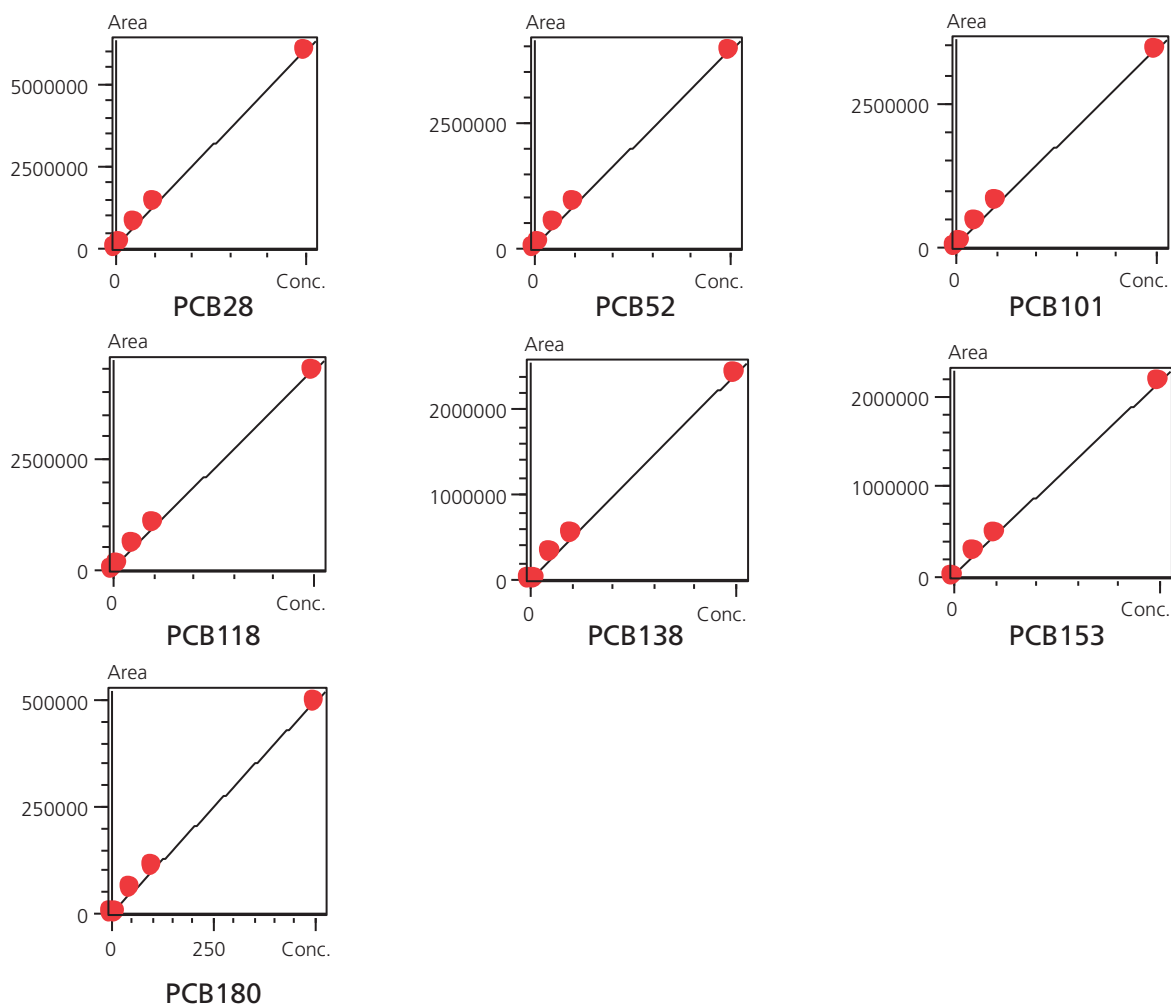

Figure 2 Calibration curve

Rapid analysis of polychlorinated biphenyls (PCBs) in vegetables by QuEChERS-based extraction and GPC–GCMS

Table 2 Relative coefficients, limit of detection (LOD, S/N=3) and recovery of the 7 kinds of PCBs

No.	Compound	Relative coefficients	LOD (µg/L)	Recovery	
				Carrot	Ginger
1	PCB28	0.9990	0.02	100.54	104.39
2	PCB52	0.9991	0.01	97.76	101.63
3	PCB101	0.9991	0.02	98.01	84.13
4	PCB118	0.9991	0.05	99.22	95.70
5	PCB138	0.9989	0.02	108.86	87.79
6	PCB153	0.9996	0.02	116.63	92.21
7	PCB180	0.9994	0.07	125.67	84.94

Table 3 Precision of PCBs (1 ng/mL each, n=6)

No.	Compound	Area						RSD (%)
		1	2	3	4	5	6	
1	PCB28	20882	21137	21076	21016	20311	21474	1.83
2	PCB52	13494	13944	13702	13926	13942	13706	1.33
3	PCB101	11428	11678	11653	11397	11349	11558	1.21
4	PCB118	13891	14251	13501	13602	14160	14300	2.45
5	PCB138	5965	5993	5557	5777	5800	5861	2.70
6	PCB153	5469	5470	5063	5148	5364	5091	3.58
7	PCB180	1141	1082	1044	1061	1109	1100	3.20

Table 4 Sample test result

No.	Compound	Carrot	Ginger
1	PCB28	N.D	N.D
2	PCB52	N.D	N.D
3	PCB101	N.D	N.D
4	PCB118	N.D	N.D
5	PCB138	N.D	N.D
6	PCB153	N.D	N.D
7	PCB180	N.D	N.D

N.D.: Not detected

Rapid analysis of polychlorinated biphenyls (PCBs) in vegetables by QuEChERS-based extraction and GPC–GCMS

Conclusions

Using the online GPC-GC/MS to analyse 7 kinds of PCBs in carrot and ginger, the method has the advantages of simple operation, high sensitivity and excellent precision.

Application News

No.L497

Supercritical Fluid Extraction / Chromatography

Using the Nexera UC Online SFE-SFC-MS System to Analyze Residual Pesticides in Agricultural Products

The Nexera UC online SFE-SFC-MS system combines supercritical fluid extraction (SFE) and supercritical fluid chromatography (SFC) in one online system, so that the entire process from extraction of target components to acquisition of data can be performed completely automatically. Furthermore, the system can add polar organic solvents (modifiers) to the supercritical carbon dioxide fluid during SFE and SFC, so that the system can be used to extract and analyze components with a wide range of polarities.

Meanwhile, ever since the positive list system was enacted in 2006 in Japan for residual pesticides in foods, which applies to more than 800 types of pesticides, there has been increasing demand for a system able to simultaneously analyze multiple pesticides with a wide range of properties, including pretreating samples.

This article describes an example of using the Nexera UC online SFE-SFC-MS system to analyze residual pesticides in agricultural products.

Online SFE-SFC-MS System

The operating principle of the Nexera UC online SFE-SFC-MS system is shown in Fig. 1. The extraction vessel filled with the sample is placed in the SFE unit and heated to an internal temperature of 40 °C (Fig. 1A). Then supercritical carbon dioxide fluid is pumped into the extraction vessel. After filling the vessel, the flow is stopped to allow static extraction of target components (Fig. 1B). After static extraction, the fluid is pumped through the extraction vessel for dynamic extraction (Fig. 1C). During dynamic extraction, extracted substances flow from the extraction vessel and into the analytical column. However, due to the high level of contaminant components in agricultural products, passing all the extract substances through the analytical column or mass spectrometer could damage the column or contaminate the mass spectrometer. Therefore, the Nexera UC online SFE-SFC-MS system splits the flow to send only a portion of the substances extracted from dynamic extraction through the analytical column. After dynamic extraction, fluid is only sent through the analytical flow line, where the analytical column is used for gradient separation and the mass spectrometer for detecting the target components (Fig. 1D).

Sample Preparation

The QuEChERS is a well-known method that prioritizes simplicity and speed and is commonly used to pretreat agricultural products for residual pesticide analysis. However, the method involves many steps, such as adding reagents, solvent extraction, purification by dispersive solid phase extraction, and centrifugal separation. In contrast, the online SFE-SFC-MS system requires only mixing 1 g of agricultural product crushed with 1 g of a dehydrating agent* and placing the mixture in the extraction vessel, as shown in Fig. 2. Consequently, the system improves analytical productivity, reduces the environmental impact, and also avoids human errors involved in the pretreatment steps. Using a dedicated rack changer, the system can continuously extract and analyze up to 48 samples at a time.

* "Miyazaki Hydro-Protect" Patent No. 3645552

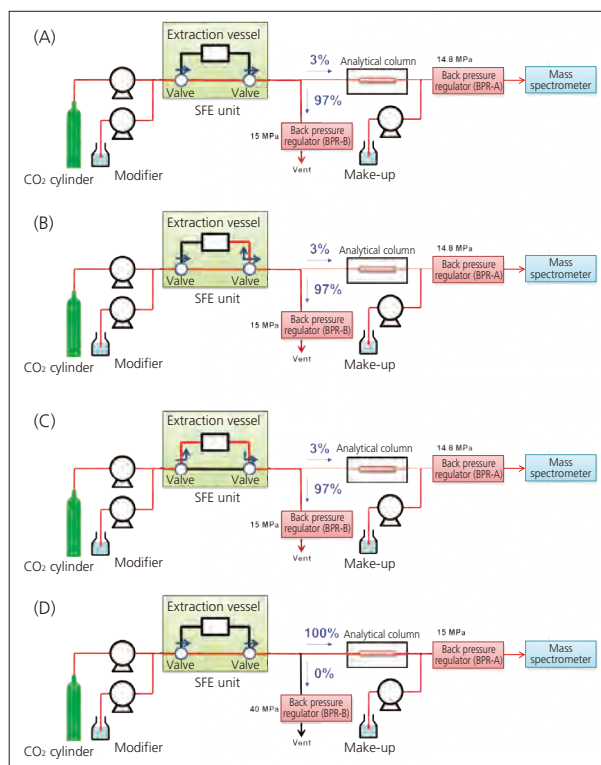

Fig. 1 Analysis Flow by Online SFE-SFC-MS

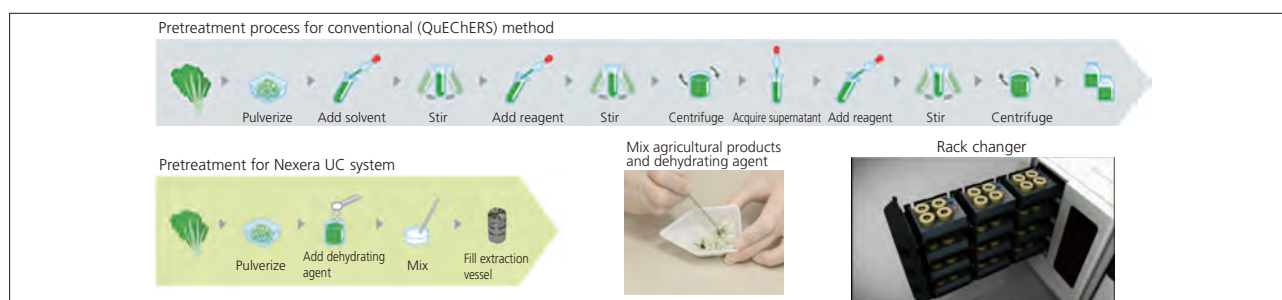

Fig. 2 Sample Preparation

Table 1 Analytical Conditions

[SFE]	[SFC]
Solvent : A) Super critical fluid of CO ₂ B) 0.1 % Ammonium formate in methanol	Column : Shim-pack UC-RP (250 mm L. × 4.6 mm I.D., 5 μm)
Flowrate : 5 mL/min	Mobile Phase : A) Super critical fluid of CO ₂ B) 0.1 % Ammonium formate in methanol
Extraction : 0-3 min. Static mode (B.Conc. 5 %) 3-6 min. Dynamic mode (B.Conc. 5 %)	Time Program : B.Conc. 0 % (0 min.) → 10 % (11 min.) → 30 % (14 min.) → 40 % (14.01-17 min.)
Extraction Vessel Temp. : 40 °C	Flowrate : 3 mL/min
BPR Pressure : A) 14.8 MPa, B) 15 MPa (split rate: 3 %)	Make-up : 0.1 % Ammonium formate in methanol (0.1 mL/min.)
Make-up : 0.1 % Ammonium formate in methanol (0.4 mL/min.)	Column Temp. : 40 °C
	BPR Pressure : A) 15 MPa, B) 40 MPa
	Detector : LCMS-8050 MRM mode

■ Analysis of Standard Mixture of Pesticides

The standard mixture sample of 510 pesticide components were mixed with a dehydrating agent and analyzed using the analytical conditions indicated in Table 1. Fig. 3 shows the results. Using the system, we were able to accomplish the entire process, from extraction to data acquisition, in about 45 minutes per analysis. For 327 components, we obtained good repeatability for the concentration range from 1 to 100 ng/g (less than 30 %RSD for relative standard deviation for peak area at respective concentrations) and good linearity (contribution ratio of at least R² = 0.99). Table 2 also shows how pesticides with a wide range of polarities were analyzed with good repeatability and linearity.

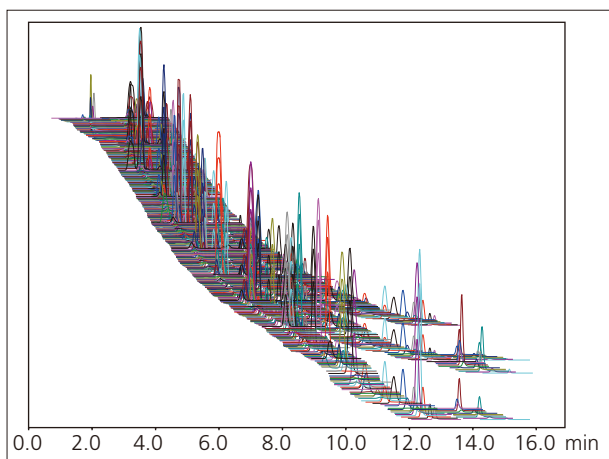

Fig. 3 Mass Chromatogram of Standard Pesticide Mixture Solution

Table 2 Repeatability and Linearity for Representative Pesticides

Compounds	LogPow	Repeatability (%RSD, n=5)	Range (ng/g)	R ²
Ethofenprox	6.9	6.1	1-100	0.9991
Hexaflumuron	5.68	6.8	1-100	0.9992
Benzofenap	4.69	1.4	2-200	0.9990
Mepronil	3.66	4.6	1-100	0.9993
Prometryn	3.34	2.7	1-100	0.9994
Fenamidone	2.8	3.0	2-200	0.9991
Ethylchlozate	2.5	3.0	1-100	0.9996
Imazosulfuron	1.6	6.2	1-100	0.9998
Bensulfuron methyl	0.79	8.1	1-100	0.9996
Primisulfuron methyl	0.2	5.5	1-100	0.9994
Halosulfuron methyl	-0.02	5.5	1-100	0.9996
Azimsulfuron	-1.4	4.2	1-100	0.9998

<Acknowledgments>

This Application News bulletin includes results obtained in cooperation with Osaka University, Kobe University, and the Miyazaki Agricultural Research Institute from the program for the "Development of Systems and Technology for Advanced Measurement and Analysis," sponsored by the Japan Science and Technology Agency (JST). We are deeply grateful to all those involved.

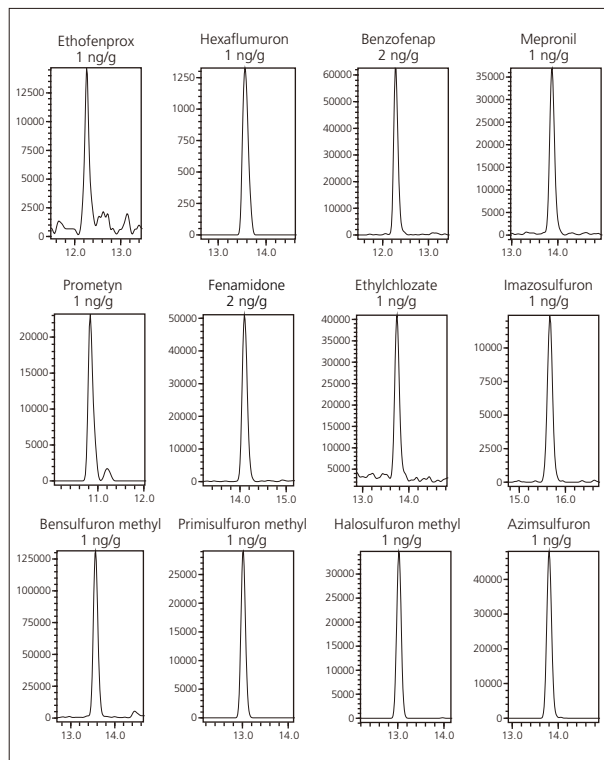

Fig. 4 MRM Chromatograms of Representative Pesticides

■ Analysis of a Tomato

Analysis of 10 ng/g of 510 pesticide components added to a tomato resulted in good repeatability (less than 20 %RSD for the relative standard deviation of the peak area) and a good recovery rate (70 to 120 %) for 248 components. Plots of LogPow and recovery rate results are shown in Fig. 5. It shows that pesticides with a wide range of polarities were analyzed with good recovery.

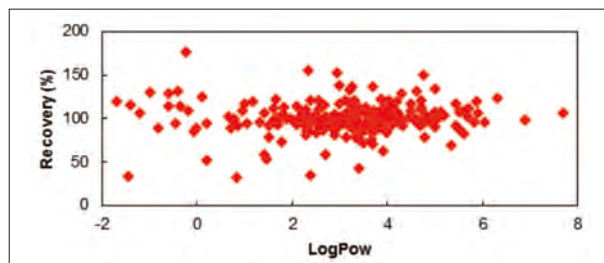

Fig. 5 LogPow vs. Recovery Rate for Tomato Analysis

Application News

No. C154

Liquid Chromatography Mass Spectrometry

Applying 'MRM Spectrum Mode' and Library Searching for Enhanced Reporting Confidence in Routine Pesticide Residue Analysis

David R. Baker¹, Chris Titman¹, Jonathan Horner², Neil Loftus¹
¹Shimadzu Corporation, UK; ²Scientific Analysis Laboratories, UK

Abstract

To help reduce the incidence of false positive and false negative reporting in pesticide residue monitoring routine multiple-reaction monitoring (MRM) methods have been enhanced to monitor a higher number of fragment ion transitions to increase specificity and reporting confidence. In this workflow, typically 6-10 fragment ion transitions were monitored for each target pesticide as opposed to a conventional approach using 2-3 fragment ions. By acquiring a high number of fragment ion transitions, each target pesticide had a corresponding fragmentation spectra which could be used in routine library searching and compound verification using reference library match scores. This 'MRM Spectrum Mode' was applied to quantify and identify 193 pesticides using 1,291 MRM transitions without compromising limits of detection, linearity or repeatability.

Introduction

Multiple Reaction Monitoring (MRM) based LC-MS/MS techniques are widely used on triple quadrupole platforms for targeted quantitation as a result of high selectivity, sensitivity and robustness. In a regulated environment such as food safety there is a growing need to enhance the capability in routine monitoring programs by increasing the number of pesticides measured in a single analysis and at the same time delivering the highest confidence in compound identification to reduce false detect reporting. For pesticide analysis in the EU, identification criteria in SANTE/11945/2015 requires the retention time and the ion ratio from at least 2 MRM transitions to be within acceptable tolerance limits.¹ However, even applying this criteria it is well reported that false positives can occur in certain pesticide/commodity combinations.²⁻⁴

To reduce false negative and false positive reporting a higher number of MRM transitions were used for each target pesticide to increase the level of confidence in assay specificity. The number of fragment ion transitions monitored for each target pesticide was dependent upon the chemical structure with typically between 6-10 fragment ions for each compound. MRM Spectrum mode combines conventional MRM quantitation with the generation of a high quality MRM product ion spectrum which can be used in routine library searching and compound verification and identification.

In this application paper we present the development of a method for 193 pesticides, with 1,291 MRM transitions, and a 15 minute cycle time. In order to acquire this number of MRM transitions using a short run time a 3 msec dwell time was applied to each MRM transition and a 5 msec polarity switch was used. On average 7 MRM transitions were applied to each compound. The method was quickly set up using the Shimadzu Pesticide Method Package, a data base with more than 750 pesticides and over 6,000 MRM transitions designed to accelerate method set-up and help compound verification. MRM Spectrum mode was also compared to a conventional pesticide monitoring method with 2 MRMs per compound (386 MRMs in total) in order to assess the effect on data quality when adding additional MRM transitions to the method. Several different food commodities were analysed with varying complexity (turmeric, plum, peppermint, parsnip, cherry, lime, pumpkin, tomato, potato). Data was processed using LabSolutions Insight software which provides automated library searching of target MRM spectrum.

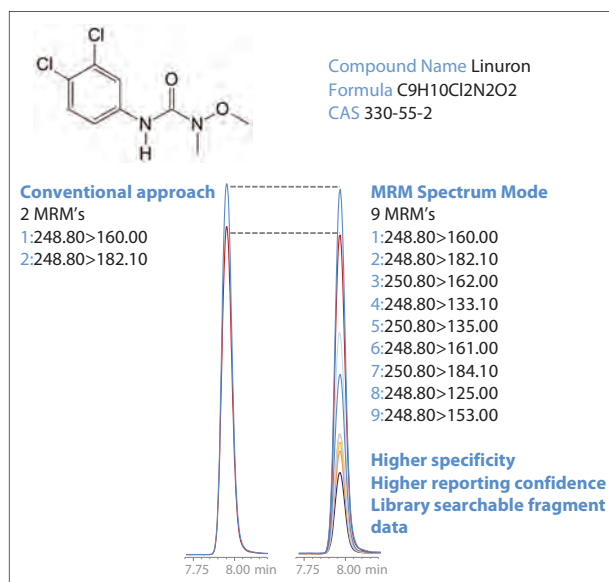

Fig. 1 Using a higher number of fragment ions in MRM data acquisition increases the specificity of detection and reduces false negative and false positive reporting. In the case of linuron, 9 precursor-fragment ion transitions were used to increase confidence in assay specificity. There is no compromise in data quality between methods despite a higher number of fragment ions monitored. Signal intensity, linearity, reproducibility are in good agreement between both methods.

Experimental

Pesticide spiked samples, extracted using established QuEChERS based methods, were provided by Scientific Analysis Laboratories, UK. In order to test the performance of the MRM Spectrum Mode database and library searching a number of matrices were tested including turmeric, plum, peppermint, parsnip, cherry, lime, pumpkin, tomato and potato. Final extracts were prepared in acetonitrile without any dilution and directly injected into the LC-MS/MS. A water co-injection method, performed automatically in the auto-sampler, was used to improve early eluting peak shapes in addition to a sub 2 micron particle size column to improve peak capacity (Table 1).

Calibration curves were prepared in the range 0.01 to 0.2 mg/kg. Repeatability of the method was tested using avocado matrix at 0.1 mg/kg. In the final method samples were analysed in ESI +/- using a polarity switching time of 5 msec.

On average 7 MRM transitions were applied to each compound, with more than 10 MRM transitions applied to 34 compounds. All MRM transitions were acquired throughout the MRM window without the need for triggering thresholds. The method includes a total of 1,291 MRM transitions for 193 pesticides in a run time of only 15 minutes. A dwell time of 3 msec was applied to every MRM transition. In order to evaluate the data quality from the MRM Spectrum Mode method, the same method was set up with 2 MRMs applied to each compound (386 MRMs in total) using the same acquisition method (Table 2).

LabSolutions software was used to automatically optimize the fragmentation for all pesticides and generate a MRM Spectrum mode method. The MRM Spectrum Mode method for library searching and compound verification could be simply and quickly set up using the Shimadzu pesticide database. This database contains more than 6,000 MRM transitions for over 750 pesticides.

LabSolutions Insight v3.0 software was used to review quantitative data and MRM Spectrum mode library searching with advanced filtering tools to review by exception and to reduce false detect reporting.

Table 1 LC acquisition parameters

Liquid chromatography		
UHPLC	Nexera LC system	
Analytical column	HSS T3 (100 × 2.1, 1.7 μm)	
Column temperature	40 °C	
Flow rate	0.4 mL/minute	
Solvent A	5 mmol/L ammonium formate and 0.004 % formic acid	
Solvent B	5 mmol/L ammonium formate and 0.004 % formic acid in methanol	
Binary Gradient	Time (mins)	%B
	1.50	35
	11.50	100
	13.00	100
	13.01	3
	15.00	Stop
Injection volume	0.1 μL (plus 30 μL water)	

Table 2 MS/MS methods used to acquire data in MRM Spectrum Mode and a conventional MRM method with 2 MRM transitions per compound. As part of the comparative study, the same LC conditions were used for both methods.

LC-MS/MS Mass spectrometry	MRM Spectrum Mode: generating library searchable spectra	2 MRM method
Target number of compounds	193	193
Total number of MRM transitions	1,291 transitions (1,229 in ESI+ and 62 in ESI-)	386 (374 in ESI+ and 12 in ESI-)
Pause time/dwell time	1 msec./3 msec.	1 msec./3 msec.
Ionisation mode	ESI +/-	ESI +/-
Polarity switching time	5 msec	5 msec
Interface temperature	350 °C	350 °C
Heat block temperature	300 °C	300 °C
Desolvation line temperature	150 °C	150 °C
Nebulising gas	3 L/min	3 L/min
Heating gas	10 L/min	10 L/min
Drying gas	10 L/min	10 L/min

Results and Discussion

In developing monitoring programs for chemical contamination methods are designed to determine a list of known analytes with a focus on delivering a rapid, cost-effective analysis that generates no false-negative or false-positive results. Guidelines for compound identification have been published by the EU in directive SANTE/11945/2015. This identification criteria requires at least two MRM transitions with an ion ratio and retention time within defined tolerance limits.

To help reduce false detect reporting in pesticide monitoring programs, a MRM method was developed with a higher number of MRM transitions for each target pesticide to increase the level of confidence in assay specificity. By combining multiple MRM transitions for a compound into a product ion spectrum, pesticide identification can be verified and confirmed against a MS/MS reference spectral library. Using MRM Spectrum mode can help markedly reduce false detect reporting without affecting the data quality for optimized quantitation or identification.

Fig. 2, shows the MRM chromatogram for all 193 pesticides spiked at 0.010 mg/kg measured with MRM Spectrum mode. Using this mode 1,291 MRM transitions were measured for 193 pesticides. Despite the high data density acquired with MRM Spectrum Mode (for example, 151 MRM transitions were registered in the same time window during the analysis, see Fig. 3) sensitivity was not affected by the high data acquisition rate.

Method performance

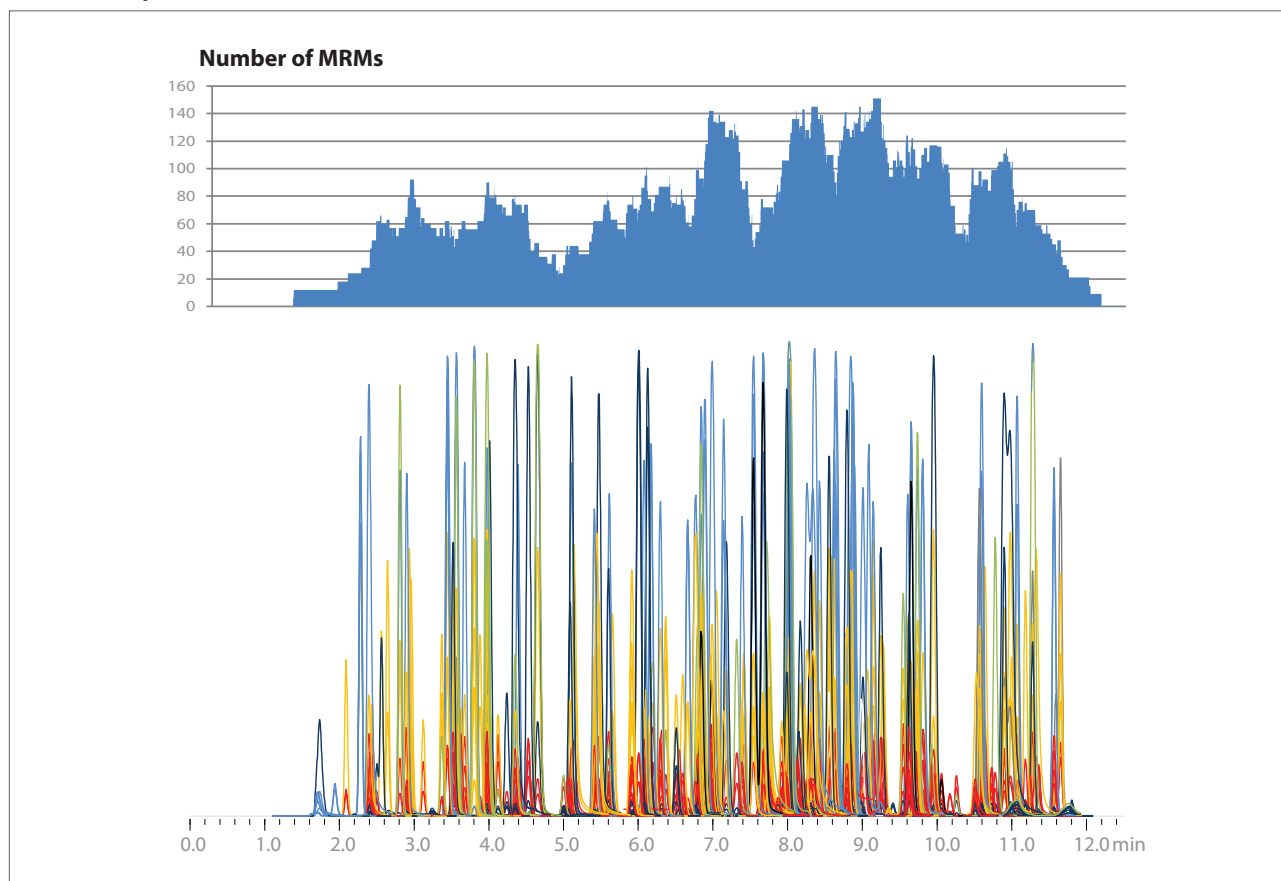

Fig. 2 Histogram showing the number of MRM transitions monitored at each time point and chromatogram showing all 193 target compounds. The highest number of overlapping MRM's acquired was 151. Even at such a high data sampling rate the response was in agreement with a conventional 2 MRM method with peak area variation less than 5.2% (n=5). This data is displayed below in more detail, Fig. 3.

Table 3 Between 8.80 mins and 9.30 mins 151 MRM transitions in both positive and negative ion were monitored. Peak area repeatability for the 22 compounds eluting in this time period is shown below.

	Ret. Time	# MRMs	Polarity	Peak Area %RSD (n=5)
Dichlofluanid	8.80	6	ESI+	2.2
Dichlofluanid 2	8.80	6	ESI+	3.4
Dichlofluanid 1	8.80	5	ESI+	2.6
Fluoxastrobin	8.82	12	ESI+	2.0
Fenhexamid	8.83	11	ESI+	2.2
Iprovalicarb	8.88	6	ESI+	2.3
Spirotetramat	8.89	6	ESI+	2.6
Azinphos-ethyl	8.90	5	ESI+	3.1
Chromafenozide	8.91	5	ESI+	3.2
Triticonazole	8.93	5	ESI+	2.1
Cyazofamid	9.01	5	ESI+	2.1
Prothioconazole desthio	9.07	10	ESI+	1.9
Diflubenzuron	9.09	4	ESI+	2.0
Pyrifenox	9.11	8	ESI+	2.0
Dodemorph	9.17	6	ESI+	2.1
Fenoxycarb	9.17	6	ESI+	2.0
Rotenone	9.17	6	ESI+	2.4
Fipronil	9.20	10	ESI-	5.2
Bixafen	9.25	8	ESI-	2.8
Tebufozozide	9.27	6	ESI+	3.9
Bensulide	9.27	6	ESI+	2.6
Neburon	9.30	9	ESI+	1.7
		Total MRM's 151		Average 2.6 %RSD

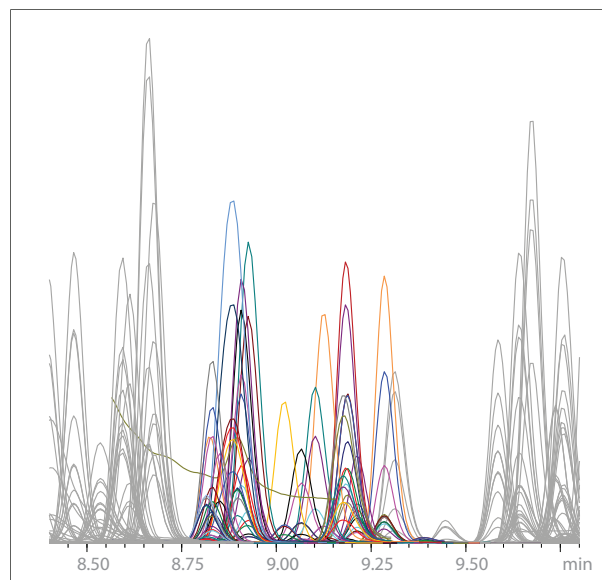

Fig. 3 Between 8.80 mins and 9.30 mins 151 MRM transitions in both positive and negative ion were monitored. During this time period 22 target pesticides eluted with a peak area variation less than 5.2 % RSD. Data was acquired in an avocado sample matrix at a concentration of 0.1 mg/kg.

Method performance

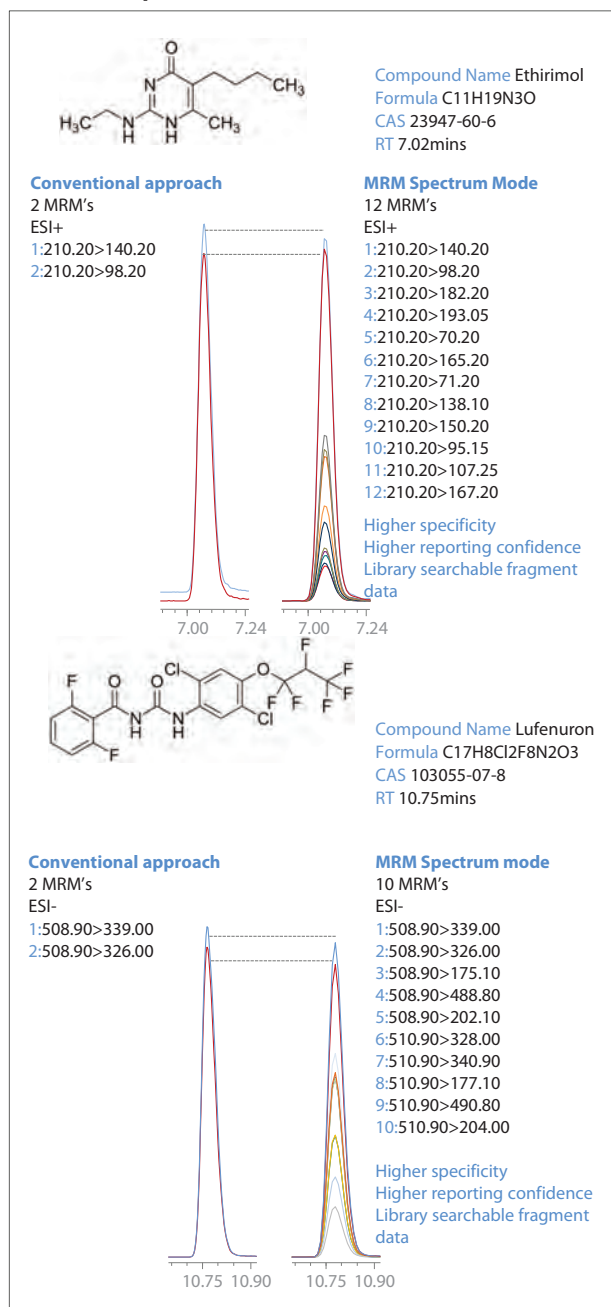

Fig. 4 MRM chromatograms for ethirimol (positive ion) and lufenuron (negative ion) acquired using a conventional 2 fragment ion MRM method and compared to a method with a higher number of precursor-fragment ions to increase confidence in assay specificity and reporting.

Despite acquiring a higher number of MRM transitions the library searchable MRM approach (acquiring 1,291 transitions in a single method) results in the same signal intensity compared to a conventional 2 fragment ion MRM method (acquiring 386 MRM transitions in a single method). The repeatability for each MRM method was evaluated by repeatedly injecting (n=5) an avocado extract corresponding to a concentration of 0.1 mg/kg. In each MRM method the %RSD was less than 3.5% for both compounds.

To minimize the possibility of false positive and false negative reporting LC-MS/MS methods were developed with a high number of MRM transitions for each pesticide. The performance of this approach was compared with a conventional MRM method monitoring 2 transitions for each pesticide.

In Fig. 4, the MRM chromatograms for 2 compounds, ethirimol and lufenuron, are shown for the same sample extract acquired using different MRM methods (the sample is avocado spiked at 0.1 mg/kg). The MRM chromatograms show un-smoothed data and are scaled to the same signal intensity for each compound. Ethirimol and lufenuron elute at 7.02 and 10.75 mins corresponding to time windows of high data density with more than one hundred MRM transitions monitored in the same time segment. However, regardless of the high number of fragment ions monitored, the absolute signal intensity for both approach's is near identical in positive and negative ion mode.

Fig. 5 shows the correlation between the peak areas for all pesticides measured using 2 different MRM methods. The linear regression curve shows a good agreement between the peak areas measured for all pesticides spiked into sample matrix with a slope value near unity and an intercept near zero.

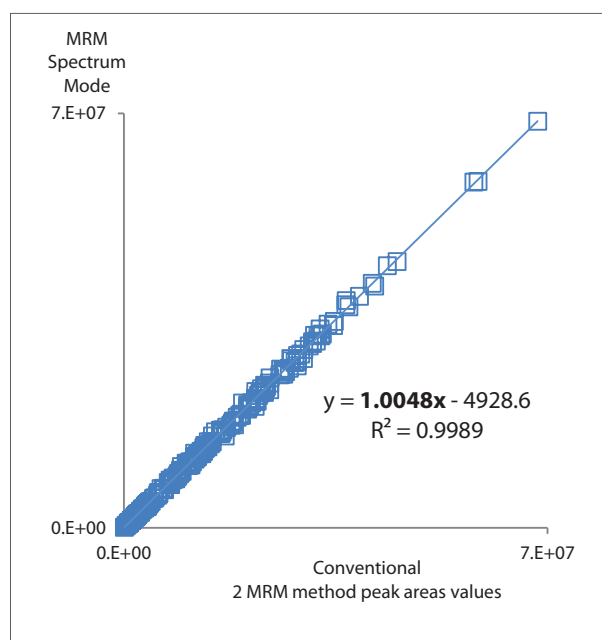

Fig. 5 Absolute peak area response for all 193 pesticides acquired using a conventional MRM method with 386 transitions compared to a MRM method with 1,291 transitions designed for library searchable verification. Both approaches result in near identical peak areas regardless of the number of fragment ions used to verify and identify each pesticide.

Spectrum based identification

In this study, the number of qualifier fragment ion transitions was increased for each pesticide and the combined transitions were used to create a MRM product ion spectrum. This product ion spectrum derived from MRM acquisitions was used in conventional library matching routines comparing against a reference spectrum to generate a similarity score.

In Fig. 6, demeton-S-methyl sulphone was to highlight library matching in different matrices including cumin, potato, mucuna pruriens powder, tomato, black pepper, peppermint tea and turmeric. Even in the presence of complex spice matrices the library matching approach identified demeton-S-methyl sulphone with a high similarity score and a high degree of confidence for data reporting.

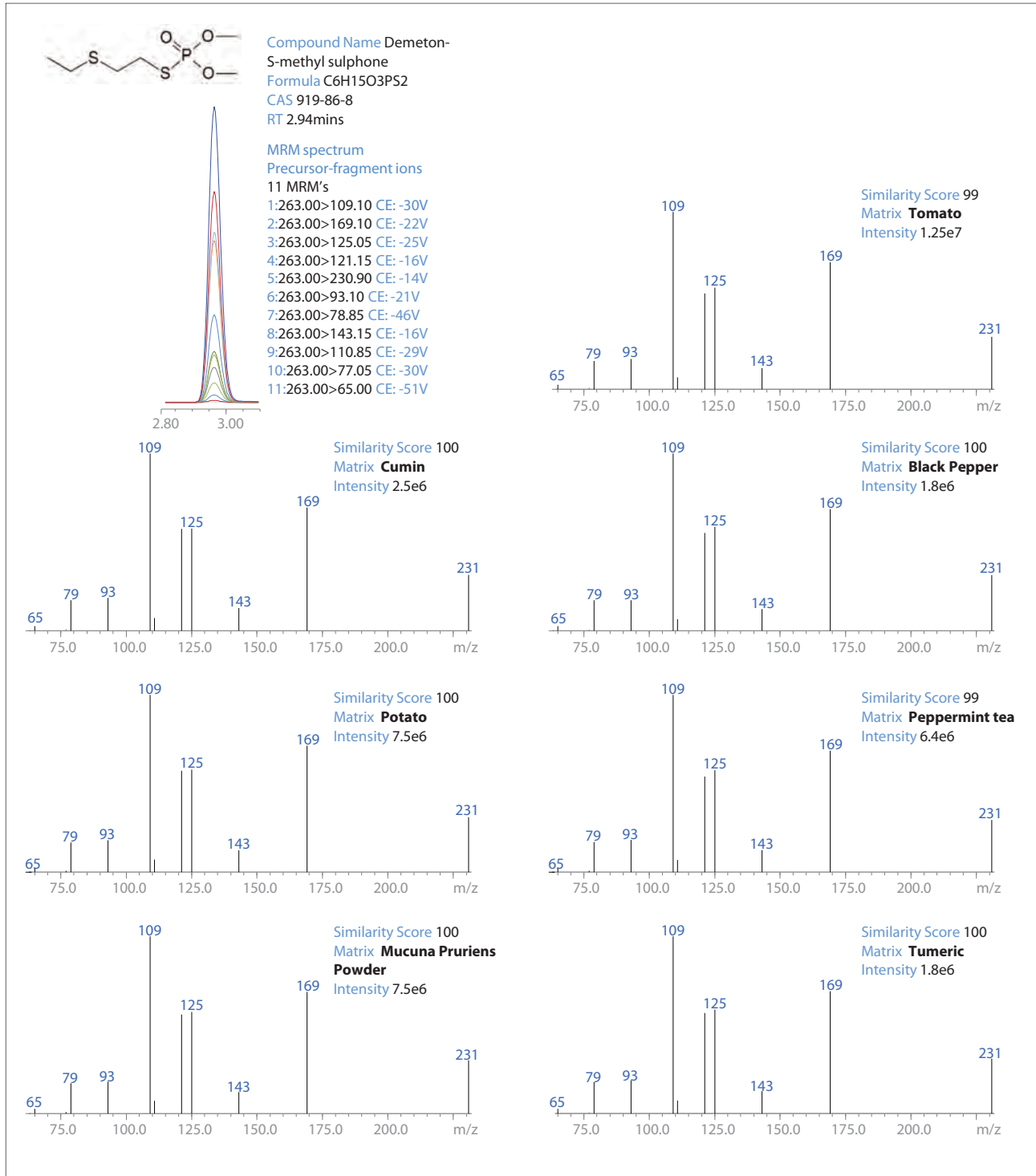

Fig. 6 MRM spectrum identification in different matrices for demeton-S-methyl sulphone

■ Spectrum based identification

To increase the confidence in reporting results the number of qualifier transitions was increased for each pesticide and the combined MRM transitions were used to create a product ion spectrum. This MRM product ion spectrum can then be automatically compared against a reference spectrum to generate a product ion spectrum match score using conventional library matching.

Fig. 7 highlights the advantage of using a library searchable fragment ion spectrum in identifying and quantifying desmedipham and phenmedipham. Both desmedipham and phenmedipham share several common fragment ions and have similar retention times. Using MRM Spectrum Mode and comparing to a library searchable spectra, both desmedipham and phenmedipham are positively identified (fragment ions at m/z 154 and 182 are absent in product ion spectrum for phenmedipham).

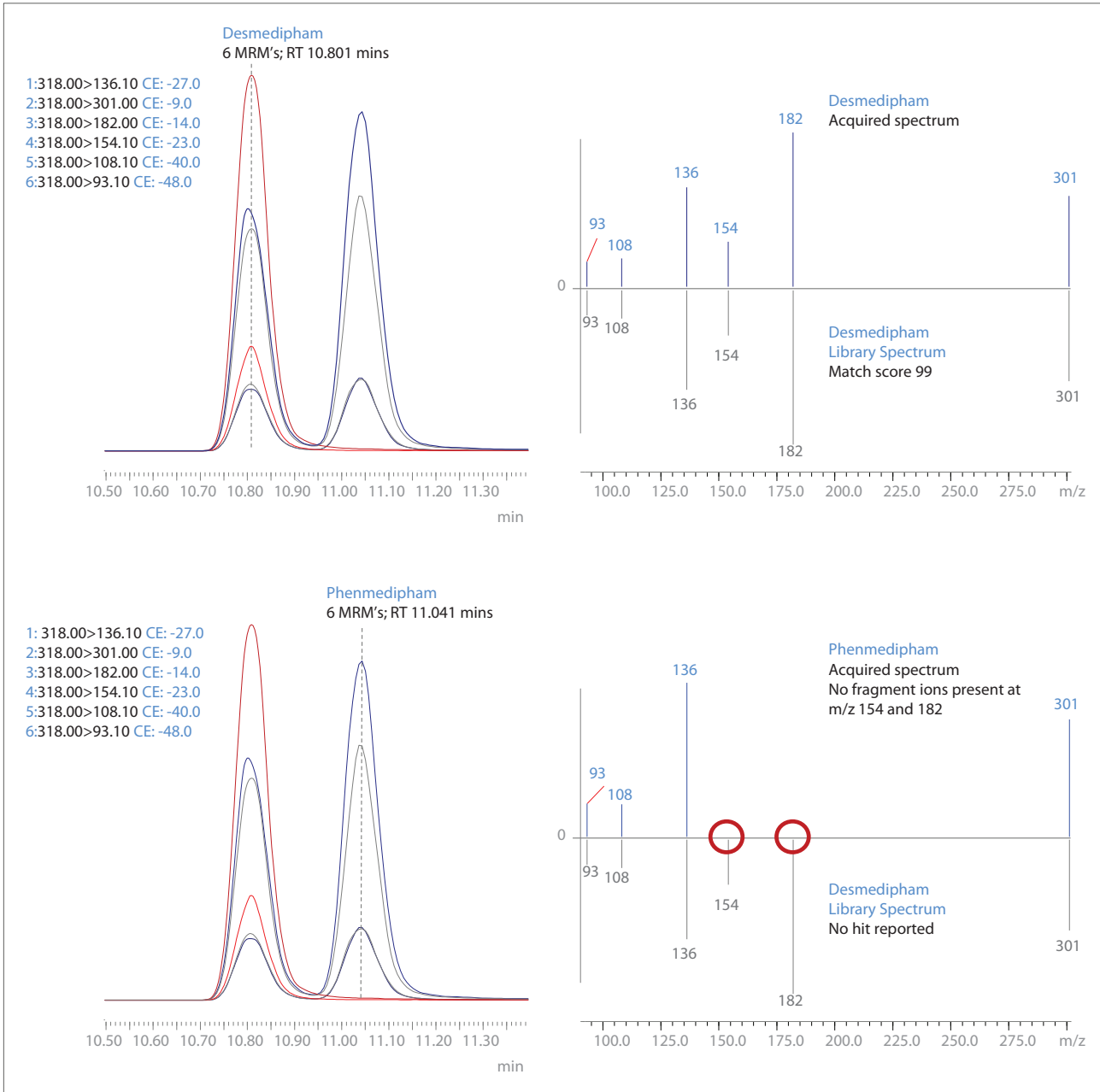

Fig. 7 MRM chromatogram for desmedipham and phenmedipham spiked into a cumin extract at 0.1 mg/kg. As phenmedipham shares common transitions and elutes at a similar retention time as desmedipham the MRM spectrum can be used to distinguish between both pesticides to avoid false positive reporting.

Quantitation

As one example, carbendazim was spiked into a matrix at three different concentration levels. In Fig. 8, all MRM transitions were detected even at the reporting level of 0.010mg/kg with a signal to noise for all fragment ion transitions greater than 9. The response was linear for all transitions throughout the calibration range (0.010-0.200mg/kg) as shown Fig. 9.

The limit on the number of MRM transitions used to generate a product ion spectrum is dependent on the chemical structure of the pesticide molecule. In the case of carbendazim, several bonds could be broken using collision energies between 10-60V resulting in a product ion spectrum of 12 fragment ions. The product ion spectrum can then be used for library search and analyte confirmation as shown in Fig. 10. For each calibration level ranging from 0.010-0.200mg/kg the library similarity score was greater than 99 confidently confirming the target analyte. The advantage of this technique is that library searchable product ion spectrum data is used in target compound identification without compromising sensitivity, accuracy and robustness in quantitative data reporting.

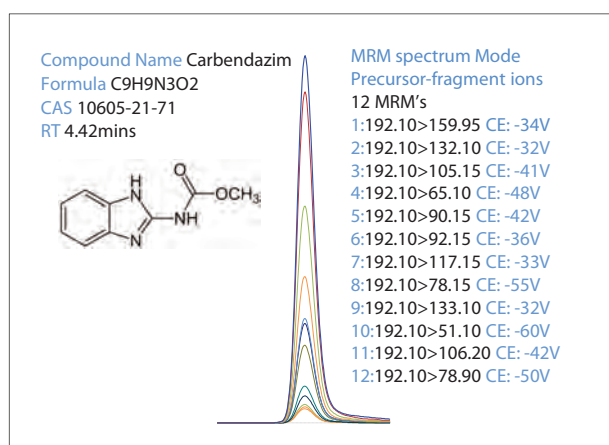

Fig. 8 By applying a range of collision energies to carbendazim 12 precursor-fragment ions are generated. MRM 192.10>159.95 was used in generating sensitive and robust quantitation whilst the product ion spectrum using all 12 fragment ions was used in confirming peak identification.

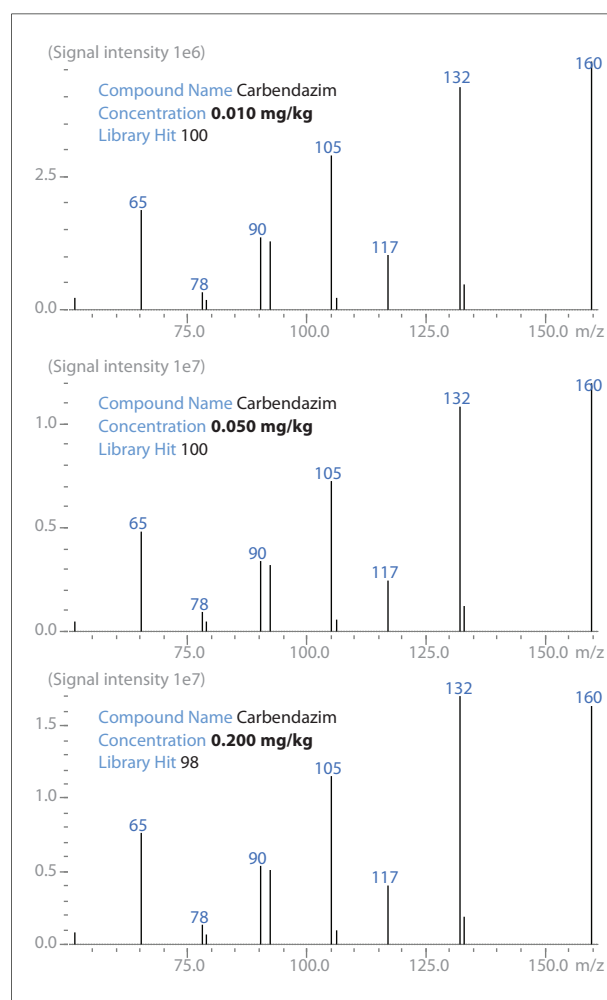

Fig. 10 MRM Product ion spectrum data for carbendazim in 3 calibration levels (0.010-0.200mg/kg) spiked into a food matrix was compared with an authentic library spectrum of carbendazim. In all library searches the similarity score was greater than 99 indicating a very high confidence in compound verification and reporting.

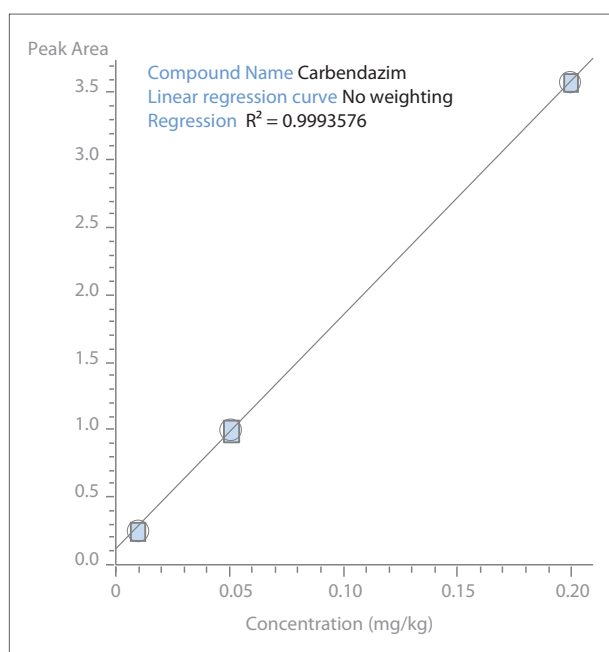

Fig. 9 Calibration curve for carbendazim using the optimized quantitation ion transition (MRM 192.10>159.95). The response was linear for all calibration and QC samples. All 12 fragment ions were above a signal to noise ratio of 10 even at the reporting level of 0.010mg/kg.

Data Reporting

Automated reference library matching and quantitation results can be simply viewed using LabSolutions Insight software (Fig 11).

LabSolutions Insight software helps to review by exception and to reduce false positive reporting by verifying compound identification using library matching scores and retention time variation from a calibration standard.

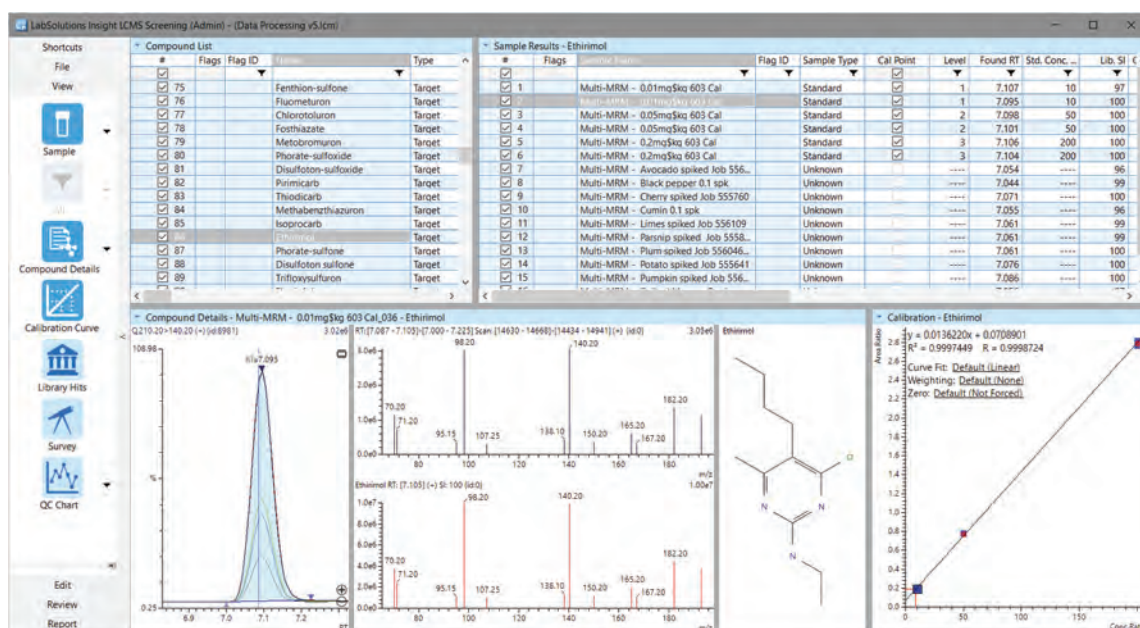

Fig. 11 LabSolutions Insight software helps to review quantitative and reference library matching results quickly and easily. Flexible filtering and sorting tools can be used to help reduce reporting false detects, especially in high throughput laboratories by filtering results based upon a similarity score with a reference library product ion spectrum.

Conclusions

False positive results are a major issue for all pesticide residue monitoring laboratories. EU regulations require that retention time and the ion ratio between 2 MRM transitions are within a set threshold. However, even applying this criteria false positives may occur for certain pesticide/commodity combinations.

In this application paper, we have applied MRM Spectrum Mode to identify and quantify 193 target pesticides in a number of different sample matrices. The library score is used as an additional identification criterion in order to improve identification confidence.

Acquisition of the MRM Spectrum mode method (1,291 MRM transitions) did not compromise data quality when compared to a conventional 2 MRM per compound method (386 MRM transitions) with consistent signal response and repeatability in both methods. The MRM product ion spectrums were demonstrated to be consistent across the linear range and between different matrices. The method acquired data in both positive and negative ion modes with a polarity switching time of 5 msec enabling fast cycle times and a high data collection rate.

All 1,291 MRM transitions were acquired throughout the MRM window. No 'triggering' of MRM transitions was necessary due to the short dwell times that were applied using the LCMS-8060. Therefore, MRM transitions can be swapped between qualifier and qualifier if needed and the peak shape of the additional MRM transitions can be assessed.

References

- European Commission SANTE/11945/2015. Guidance document on analytical quality control and method validation procedures for pesticides residues analysis in food and feed.
- Schürmann A., Dvorak V., Crüzer C., Butcher P., Kaufmann A., False-positive liquid chromatography/tandem mass spectrometric confirmation of sebutylazine residues using the identification points system according to EU directive 2002/657/EC due to a biogenic insecticide in tarragon. *Rapid Communications Mass Spectrometry*, Volume 23, Issue 8, April 2009, Pages 1196-1200.
- Kaufmann A., Butcher P., Maden K., Widmer M., Giles K., Uriá D.. Are liquid chromatography/electrospray tandem quadrupole fragmentation ratios unequivocal confirmation criteria? *Rapid Communications, Mass Spectrometry*, Volume 23, Issue 7, April 2009, Pages 985-998.
- Pozo Ó., Sancho J., Ibáñez M., Hernández F., Niessen W., Confirmation of organic micropollutants detected in environmental samples by liquid chromatography tandem mass spectrometry: Achievements and pitfalls, *TrAC Trends in Analytical Chemistry*, Volume 25, Issue 10, November 2006, Pages 1030-1042.

First Edition: Mar. 2017



For Research Use Only. Not for use in diagnostic procedure.

This publication may contain references to products that are not available in your country. Please contact us to check the availability of these products in your country.

The content of this publication shall not be reproduced, altered or sold for any commercial purpose without the written approval of Shimadzu. Company names, product/service names and logos used in this publication are trademarks and trade names of Shimadzu Corporation or its affiliates, whether or not they are used with trademark symbol "TM" or "®". Third-party trademarks and trade names may be used in this publication to refer to either the entities or their products/services. Shimadzu disclaims any proprietary interest in trademarks and trade names other than its own.

The information contained herein is provided to you "as is" without warranty of any kind including without limitation warranties as to its accuracy or completeness. Shimadzu does not assume any responsibility or liability for any damage, whether direct or indirect, relating to the use of this publication. This publication is based upon the information available to Shimadzu on or before the date of publication, and subject to change without notice.

Shimadzu Corporation

www.shimadzu.com/an/

Technical Report

Residual Pesticides Analysis of Botanical Ingredients Using Gas Chromatography Triple Quadrupole Mass Spectrometry

Riki Kitano¹, Tairo Ogura¹, Nicole Lock¹, Robert Clifford¹, Julie Kowalski², Jack Cochran², Dan Li²

Abstract:

Dietary supplements, which are consumed worldwide, are made from various botanical ingredients. To be safe from pesticides exposure, residual pesticides must be monitored by chromatographic instrumentation. Issues arise however, due to the fact these botanical samples are dried and cause large interferences in the chromatography. This study shows that the modified QuEChERS method combined with GC-MS/MS achieves consistent pesticides monitoring in botanical ingredients.

Keywords: botanical, QuEChERS, pesticides, GC-MS/MS

1. Introduction

The use of dietary supplements is increasing in the United States. These dietary supplements are made from various dried botanicals and residual pesticides and because of that, they have to be monitored to ensure their quality and prevent exposure. The ingredients are dried which requires the standard QuEChERS methods¹⁾ to be modified to overcome this difficulty. Gas chromatography is best technique to separates multi components including coextracted interferences, and because the triple quadrupole mass spectrometry (GC-MS/MS) is highly sensitive this allows analysis of trace level contamination. In this study, we analyzed over 200 compounds simultaneously using a triple quadrupole gas chromatograph mass spectrometer with the modified QuEChERS method.

2. Materials and Methods

Pesticides standards, internal standards, quality control standards and QuEChERS kit were obtained from Restek:

- GC Multiresidue Pesticide Kit (Cat.#: 32562)
- GCMS Internal Standard Mix (Cat.#: 33267)
- SV Internal Standard Mix (Cat.#: 31206)
- Q-sep QuEChERS Extraction Kit (Original) (Cat.#: 23991)

The total number of targets was 232 compounds (220 pesticides, 6 internal standards, and 6 quality control standards). Ginseng, which can be purchased in any store, was used as a matrix. Using this ginseng, matrix-matched calibration standards (1 to 200 ng/mL) and fortified samples (each two 10 and 50 ng/g) were prepared. Calibration curves were generated by internal standard method, weighted 1/C and the internal standard was PCB52.

A MRM analytical method was created using the Smart Pesticides Database (Shimadzu). This database has retention indices for all registered compounds, and retention times can be predicted by running an *n*-alkane sample mixture (AART: Automatic Adjustment of Retention Time). According to estimated retention times, Smart MRM[®] creates an optimum data acquisition time program (Fig. 1).

2-1. Extraction and Clean-up Procedure

- ▶ Weigh 1.0 ± 0.05 g ground ginseng powder into 50 mL polypropylene centrifuge tube.
- ▶ Add 10 mL HPLC-grade water and vortex the tube vigorously.
- ▶ Add 10 mL of the ACN/IS Extraction Solvent.
- ▶ Allow the tube to sit for 15 min.
- ▶ Add 4 g anhydrous $MgSO_4$ and 1 g NaCl.
- ▶ Shake the tube vigorously on a mechanical shaker for 30 min.
- ▶ Centrifuge the 50 mL tubes at 3000–4500 rpm \times 5 min.
- ▶ Condition the GCB/PSA (0.25 g/0.5 g) SPE columns with \sim 250 mg anhydrous Na_2SO_4 on top using 3 column volumes of acetone.
- ▶ Insert a collection rack consisting of 15 mL disposable glass centrifuge tube on a SPE vacuum manifold.
- ▶ Add 1.25 mL of the ACN extract.
- ▶ Rinse with 1 mL acetone.
- ▶ Elute with 12 mL of 3:1 v/v acetone:toluene.
- ▶ Evaporate (50 °C) the eluent to \sim 100 μ L gently.
- ▶ Add 500 μ L of toluene to the Blank/fortified samples, calibration standard solutions to matrix matched calibration standards.
- ▶ Add 20 μ L quality control standards (12.5 μ g/mL) and \sim 50 mg of anhydrous $MgSO_4$ to all samples.
- ▶ Vortex for 5 sec.
- ▶ Centrifuge the tubes at 3000 g \times 5 min.
- ▶ Transfer the toluene extract using a Pasteur pipette to ALS GC vials.





Fig. 1 Data Acquisition Time Program Created by Smart MRM

2-2. Analytical Condition

System Configuration

GC-MS/MS	: GCMS-TQ8040 (Shimadzu)
Auto Injector	: AOC-20i + 20s (Shimadzu)
Column	: SH-Rxi-5MS 30 m x 0.25 mm I.D., df = 0.25 μ m (Shimadzu, P/N: 221-75940-30) with Rxi guard column 5 m x 0.25 mm I.D. (Restek, Cat.#: 10029)
Glass Liner	: Sky Liner, Splitless Single Taper Gooseneck w/Wool (Restek, Cat.#: 23336.5)
Software	: GCMSsolution Ver. 4.42

GC

Injection Temp.	: 250 $^{\circ}$ C
Oven Temp.	: 90 $^{\circ}$ C (1 min), 30 $^{\circ}$ C/min to 130 $^{\circ}$ C, 10 $^{\circ}$ C/min to 330 $^{\circ}$ C (2 min)
Total GC Time	: 24.33 min
Carrier Gas Control	: Linear Velocity (55 cm/sec)
Injection Mode	: Splitless with high pressure injection (250 kPa, 1.5 min)
Injection Volume	: 2 μ L

MS

Interface Temp.	: 290 $^{\circ}$ C
Ion Source Temp.	: 230 $^{\circ}$ C
Ionization Mode	: EI (ionization voltage: 70 eV)
Acquisition Mode	: MRM (2 transitions for each compound)
Resolution	: Unit (Q1) – Low (Q3)
Loop Time	: 0.4 sec

3. Result and Discussion

3-1. Matrix Matched Calibration

The chromatogram in Fig. 2 shows a 10 ng/mL matrix matched calibration standard. Of the 232 compounds, 230 could be detected in ± 0.1 min of estimated retention time by AART. The remaining two compounds, 1,4-Dichlorobenzene-d4 and Naphthalene-d8 of six quality control standards, had eluted before 4 min. Although retention times were shifted, they were with identified within about ± 0.2 min of estimated.

Calibration curves were generated from matrix matched calibration standards, then back calculation and linearity were evaluated.

Back calculation was performed by calculating the concentration of each calibration point, and if the concentration exceeds $\pm 20\%$ of

theoretical value, the calibration point would be interpolated with the nearest two points. Over 93% of the compounds with concentration of 1 ng/mL were within $\pm 20\%$ of theoretical calculations and all compounds of concentration 20 to 200 ng/mL were within $\pm 20\%$ (Fig. 3).

This modified QuEChERS method contains dilution steps, and samples will be diluted by quarter. To quantify 10 ng/g concentration, 2 ng/g or lower calibration point are required. Even at low concentrations, the calibration curves show good linearity (Fig. 4) and all coefficients of determination (220 pesticides) were greater than 0.99.

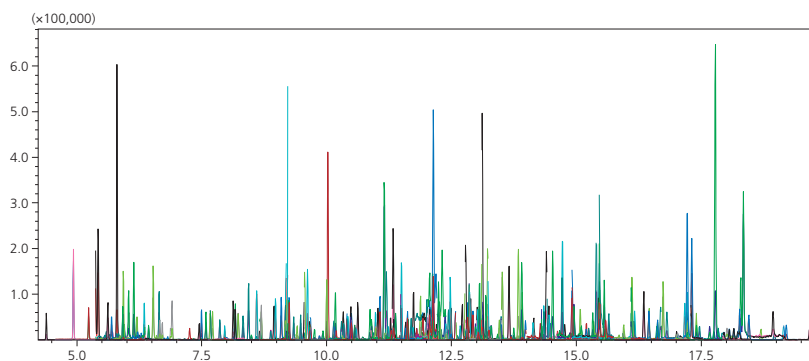

Fig. 2 MRM Chromatogram of 10 ng/mL Matrix Matched Calibration Standard (Internal standards and quality control standards are not displayed.)

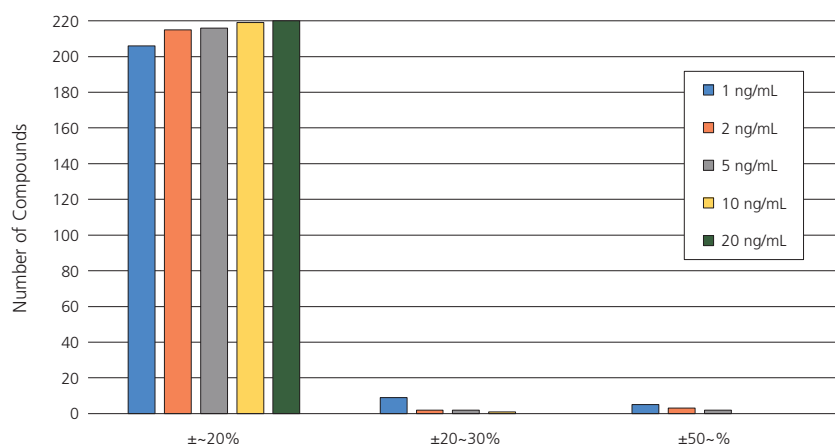

Fig. 3 Difference Between Back Calculation and Theoretical Concentration

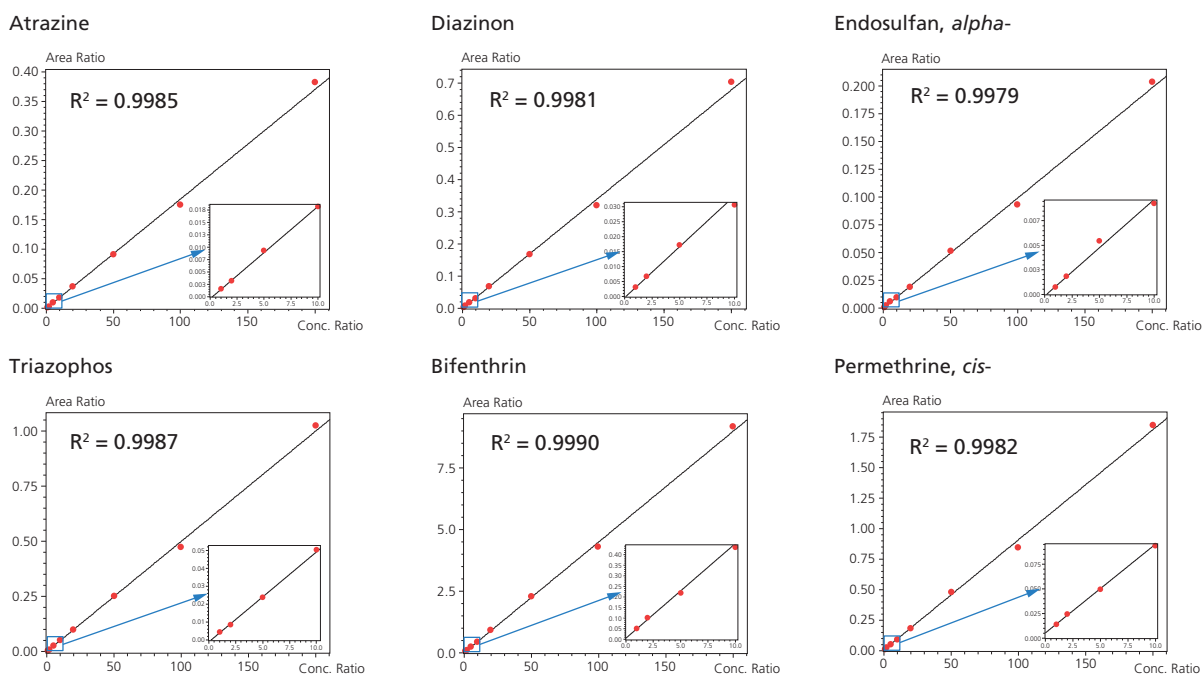

Fig. 4 Calibration Curves of Representative Six Compounds

3-2. Recovery of Fortified Sample

Each two 10 ng/g and 50 ng/g fortified samples were prepared (10 ng/g-1, 10 ng/g-2, 50 ng/g-1, 50 ng/g-2) and these recovery rates were evaluated from the average of three successive data points for each samples.

Of the compounds, 85% showed good recovery within the range of 70 to 120% on 10 ng/g-1 and 50 ng/g-2. As mentioned previously, fortified samples were diluted to 2.5 ng/mL and 12.5 ng/mL. Since calibration curves showed good linearity at low concentration and modified QuEChERS method suppressed interference, good recovery result were achieved. (Some compounds were not quantified correctly because the matrix for the calibration standards originally contained them. Y-intercept were lifted up and this shift might cause incorrect quantification, especially at low concentration. From the standard addition method, 16 pesticides were detected with more than 10 ng/g in matrix.)

In this study, recovery results were rechecked and combined with qualitative information, the relative ion ratio. Ion ratios between the target and reference were compared to that of the 100 ng/g standard and evaluated according to SANCO/12571/2013²¹. This mentions that the use of relative ratio $\pm 30\%$ as a criteria is recommended.

Table 1 shows recovery and relative ion ratio for all compounds and Fig. 5 shows the combination map of recovery and relative ion ratio, which was generated from this table. Of the compounds, 76% in the 10 ng/g-1 were within $\pm 30\%$ on relative ion ratio with good recovery of between 70 to 120%. For 50 ng/g-2, 83% of the compounds were within a $\pm 30\%$ relative ion ratio. And here, compounds which showed poor recovery and/or over $\pm 30\%$ relative ion ratio were examined (Page 7).

Table 1 Recovery and Relative Ion Ratio; Relative ion ratios were calculated by those of 100 ng/mL standard solution.

ID	Compound Name	Transitions				Recovery (Average of n = 3)				Relative Ion Ratio (Average of n = 3)			
		Target	CE	Reference	CE	10 ng/g-1	10 ng/g-2	50 ng/g-1	50 ng/g-2	10 ng/g-1	10 ng/g-2	50 ng/g-1	50 ng/g-2
1	2,3,5,6-Tetrachloroaniline	228.9 > 158.0	18	230.9 > 158.0	22	72.5	67.0	61.4	68.8	93.6	97.2	98.9	101.1
2	2,4'-Methoxychlor	227.1 > 121.1	16	228.1 > 122.1	16	83.0	101.1	86.5	80.2	94.7	105.0	104.6	106.7
3	2-Phenylphenol	170.1 > 141.1	24	170.1 > 115.1	28	72.7	72.3	63.2	69.0	113.1	112.9	99.1	102.1
4	3,4-Dichloroaniline	161.0 > 99.0	22	161.0 > 126.0	14	74.5	66.2	56.4	64.4	103.8	105.5	105.8	106.0
5	4,4'-Dichlorobenzophenone	139.0 > 111.0	14	139.0 > 75.0	26	77.4	83.2	73.5	73.8	97.5	104.7	102.0	100.3
6	4,4'-methoxychlor olefin	308.0 > 238.1	16	310.0 > 238.1	20	84.4	94.8	85.7	83.0	99.4	101.0	100.0	98.4
7	Acequinocyl deg.	342.2 > 188.1	14	342.2 > 160.1	22	105.3	269.8	201.1	115.2	61.2	62.8	90.7	64.0
8	Acetochlor	223.1 > 132.1	22	223.1 > 147.1	10	77.5	88.3	77.4	77.1	109.0	104.1	102.8	106.2
9	Acrinathrin	289.1 > 93.0	14	181.1 > 152.1	26	102.5	121.4	91.0	82.4	87.0	94.7	92.3	95.1
10	Alachlor	188.1 > 160.1	10	188.1 > 132.1	18	74.1	87.2	77.8	74.1	114.7	107.2	97.3	103.5
11	Aldrin	262.9 > 191.0	34	262.9 > 193.0	28	86.0	66.9	65.2	74.3	79.8	101.1	104.6	93.2
12	Allidochlor	132.1 > 56.0	8	132.1 > 49.0	24	71.8	64.5	59.0	65.9	123.7	118.4	113.4	117.2
13	Antraquinone	208.1 > 180.1	10	208.1 > 152.1	22	0.0	126.7	47.4	48.0	97.0	83.6	90.4	94.0
14	Atrazine	200.1 > 104.1	18	200.1 > 122.1	8	77.8	94.0	83.3	78.6	105.3	110.1	92.5	100.6
15	Azinphos-ethyl	160.1 > 132.1	4	160.1 > 77.0	18	91.4	115.5	94.5	86.5	102.1	94.8	100.0	98.7
16	Azinphos-methyl	160.1 > 132.1	6	160.1 > 77.0	20	84.1	124.7	93.0	83.3	89.6	103.3	98.2	100.0
17	Benfluralin	292.1 > 264.0	8	292.1 > 160.0	22	78.4	77.0	64.5	70.7	97.7	89.1	96.8	95.3
18	BHC, alpha-	180.9 > 144.9	16	218.9 > 182.9	8	62.5	50.4	58.2	66.1	99.0	104.0	99.2	104.3
19	BHC, beta-	180.9 > 144.9	16	218.9 > 182.9	8	69.6	87.6	76.8	71.8	102.2	102.9	98.9	104.1
20	BHC, delta-	180.9 > 144.9	16	218.9 > 182.9	8	28.6	87.6	69.0	67.8	102.5	104.3	106.4	104.2
21	BHC, gamma-	180.9 > 144.9	16	218.9 > 182.9	8	64.1	73.3	62.0	69.8	94.8	93.9	103.1	102.8
22	Bifenthrin	181.1 > 166.1	12	181.1 > 179.1	12	84.6	99.2	89.3	81.4	97.0	104.4	116.7	105.9
23	Bioallethrin	123.1 > 81.1	10	136.1 > 93.1	14	81.7	100.7	83.6	71.9	463.4	563.8	200.4	228.1
24	Biphenyl	154.1 > 128.1	22	154.1 > 115.1	24	90.0	67.9	56.2	65.1	105.5	105.1	106.3	106.0
25	Bromfeninfos-methyl	294.9 > 109.0	16	296.9 > 109.0	16	85.5	98.5	84.2	77.6	103.5	92.2	100.9	102.7
26	Bromfeninfos	266.9 > 159.0	14	268.9 > 161.0	16	78.4	97.8	88.2	79.2	102.1	94.7	100.9	102.3
27	Bromophos	330.9 > 315.9	14	328.9 > 313.9	18	70.9	86.2	77.2	76.4	104.6	98.6	97.2	98.6
28	Bromophos-ethyl	358.9 > 302.9	16	302.9 > 284.9	18	78.0	86.9	76.5	75.8	91.9	89.6	98.5	98.4
29	Bromopropylate	340.9 > 182.9	18	340.9 > 184.9	20	85.8	104.5	94.3	85.6	101.4	100.9	101.0	99.2
30	Bupirimate	273.1 > 108.1	16	273.1 > 193.1	8	94.4	102.8	92.2	87.0	82.0	98.3	98.1	92.8
31	Captafol	79.0 > 77.0	14	79.0 > 51.0	20	N.D.	N.D.	N.D.	N.D.	N.D.	N.D.	N.D.	N.D.
32	Captan	149.1 > 105.1	4	149.1 > 79.1	14	90.7	95.3	83.4	75.3	232.6	240.2	118.7	135.5
33	Carbophenothion	341.9 > 157.0	14	341.9 > 199.0	8	81.9	97.6	84.2	79.2	58.6	66.3	80.4	91.6
34	Carfentrazone-ethyl	340.1 > 312.1	14	312.1 > 151.1	24	85.3	100.6	94.0	87.3	81.5	81.8	101.9	94.7
35	Chlorbendise	125.0 > 99.0	18	127.0 > 89.0	18	80.3	83.4	73.5	71.8	86.9	93.5	96.8	99.3
36	Chlordane, cis-	374.8 > 265.9	26	372.8 > 265.9	22	76.4	84.2	76.6	77.1	94.8	99.2	105.3	101.1
37	Chlordane, trans-	374.8 > 265.9	26	372.8 > 265.9	22	76.6	77.3	75.9	72.9	96.3	106.5	103.2	102.7
38	Chlorfenapyr	247.1 > 227.0	16	247.1 > 200.0	24	84.3	114.9	87.1	85.0	51.3	71.3	112.2	98.6
39	Chlorfenson	175.0 > 111.0	12	301.9 > 175.0	8	77.0	89.1	81.4	76.4	99.5	100.6	100.5	98.0
40	Chlorfenvinphos, (E)-	323.0 > 267.0	16	267.0 > 159.0	18	110.3	114.8	74.7	72.9	270.4	484.8	103.9	99.9
41	Chlorfenvinphos, (Z)-	323.0 > 267.0	16	267.0 > 159.0	18	85.5	96.6	82.7	78.5	105.8	101.5	104.8	101.2
42	Chlorobenzilate	251.0 > 139.0	14	139.0 > 75.0	26	87.5	106.9	88.9	80.3	98.3	92.0	100.1	101.1
43	Chloroneb	206.0 > 141.0	20	193.0 > 113.0	18	65.4	59.8	59.8	68.6	111.1	110.8	107.9	105.9
44	Chlorothalonil	263.9 > 168.0	24	263.9 > 228.8	18	N.D.	N.D.	5.2	N.D.	N.D.	N.D.	82.3	N.D.
45	Chlorpropham	213.1 > 171.1	6	127.1 > 92.0	18	77.7	81.7	72.5	73.3	99.6	101.7	99.0	101.4
46	Chlorpyrifos	313.9 > 257.9	14	313.9 > 285.9	8	71.2	77.8	74.9	74.2	100.5	93.8	93.6	95.7
47	Chlorpyrifos-methyl	285.9 > 93.0	22	287.9 > 93.0	22	77.0	89.3	73.1	75.3	92.9	91.7	102.6	98.0
48	Chlorthal-dimethyl	298.9 > 220.9	24	300.9 > 222.9	26	78.8	81.9	77.3	73.7	90.7	95.7	96.1	99.9
49	Chlorthiophos-1	256.9 > 239.0	14	256.9 > 193.0	22	91.4	108.5	84.2	83.5	8.4	49.4	77.2	68.6
50	Chlorthiophos-2	324.9 > 268.9	14	268.9 > 205.0	18	76.1	96.8	84.6	80.0	73.8	79.3	95.8	101.5
51	Chlorthiophos-3	324.9 > 268.9	14	268.9 > 205.0	18	78.4	100.2	86.8	77.8	92.6	85.9	100.8	97.8
52	Chlozolinate	258.9 > 188.0	14	330.9 > 258.9	6	75.6	82.2	75.9	76.1	91.7	98.3	103.8	104.3
53	Clomazone	204.1 > 107.0	20	204.1 > 78.0	26	72.7	72.2	70.9	74.9	100.7	99.6	101.8	98.6
54	Coumaphos	362.0 > 109.0	16	362.0 > 226.0	14	90.1	110.4	98.2	89.7	84.4	84.7	94.5	94.9
55	Cycloate	154.2 > 72.0	6	215.1 > 154.2	4	69.8	66.7	61.2	69.5	89.3	89.9	93.3	94.0
56	Cyfluthrin-1	226.1 > 206.1	14	163.1 > 127.1	6	92.8	111.7	98.2	92.1	105.2	118.8	100.9	96.1
57	Cyfluthrin-2	226.1 > 206.1	14	163.1 > 127.1	6	92.5	113.1	91.9	90.2	124.6	121.5	105.1	97.6
58	Cyfluthrin-3	226.1 > 206.1	14	163.1 > 127.1	6	81.4	96.8	92.5	81.7	117.8	160.7	124.5	128.0
59	Cyfluthrin-4	226.1 > 206.1	14	163.1 > 127.1	6	76.5	95.7	106.8	88.7	167.1	159.4	121.8	126.4
60	Cyhalothrin, lambda-	208.1 > 181.1	8	197.1 > 141.0	12	88.4	108.0	92.1	85.5	99.2	113.2	99.5	96.9
61	Cypermethrin-1	163.1 > 127.1	6	163.1 > 109.1	22	96.0	113.8	94.6	89.9	108.8	93.7	117.4	111.3
62	Cypermethrin-2	163.1 > 127.1	6	163.1 > 109.1	22	89.6	119.7	98.0	88.7	99.2	113.1	94.8	100.1
63	Cypermethrin-3	163.1 > 127.1	6	163.1 > 109.1	22	75.9	124.9	103.1	96.9	126.1	114.1	96.6	104.1
64	Cypermethrin-4	163.1 > 127.1	6	163.1 > 109.1	22	76.6	100.1	84.6	81.5	115.3	119.9	124.9	120.1
65	Cyprodinil	224.1 > 197.1	22	224.1 > 131.1	14	82.0	88.9	80.0	71.2	138.1	117.5	100.5	112.6
66	DDD, o,p'-	235.0 > 165.0	24	235.0 > 199.0	16	83.6	96.0	79.8	75.3	87.0	86.6	100.1	99.1
67	DDD, p,p'-	235.0 > 165.0	24	235.0 > 199.0	16	80.2	94.6	83.6	78.2	104.4	98.8	102.6	104.3
68	DDE, o,p'-	246.0 > 176.0	30	248.0 > 176.0	28	73.7	83.1	75.7	71.7	101.7	97.9	99.0	100.3
69	DDE, p,p'-	246.0 > 176.0	30	317.9 > 248.0	24	76.9	99.7	76.2	73.5	101.1	93.8	98.8	98.3
70	DDT, o,p'-	235.0 > 165.0	24	235.0 > 199.0	16	79.0	89.1	78.0	74.3	93.9	97.6	100.1	101.2
71	DDT, p,p'-	235.0 > 165.0	24	235.0 > 199.0	16	75.2	95.1	80.7	75.8	96.8	95.0	102.9	97.7
72	Deltamethrin	252.9 > 93.0	20	252.9 > 171.9	8	83.8	109.4	92.2	85.3	99.9	99.3	102.5	99.7
73	Di-allate-1	234.1 > 150.0	20	234.1 > 192.1	14	75.3	66.5	63.3	70.7	93.8	93.0	100.9	103.3
74	Di-allate-2	234.1 > 150.0	20	234.1 > 192.1	14	72.4	65.1	63.0	70.5	88.9	107.7	100.0	94.1
75	Diazinon	304.1 > 179.1	10	304.1 > 162.1	8	76.4	70.3	69.5	74.4	62.3	80.6	97.9	86.4
76	Dichlobenil	170.9 > 100.0	24	170.9 > 136.0	14	71.2	65.3	58.2	65.4	96.5	97.4	96.5	98.2
77	Dichlofluanid	223.9 > 123.1	8	223.9 > 77.0	28	65.0	71.1	57.8	56.9	75.4	87.4	94.4	101.7
78	Dicloran	206.0 > 176.0	10	206.0 > 124.0	24	78.1	76.6	69.7	77.0	79.0	87.7	100.6	91.0

ID	Compound Name	Transitions				Recovery (Average of n = 3)				Relative Ion Ratio (Average of n = 3)			
		Target	CE	Reference	CE	10 ng/g-1	10 ng/g-2	50 ng/g-1	50 ng/g-2	10 ng/g-1	10 ng/g-2	50 ng/g-1	50 ng/g-2
79	Dieldrin	276.9 > 241.0	8	262.9 > 193.0	34	80.2	80.3	89.0	85.0	154.2	185.9	102.7	91.4
80	Dimethachlor	197.1 > 148.1	10	199.1 > 148.1	10	78.4	90.6	77.9	76.8	99.6	89.1	100.2	101.6
81	Diphenamid	239.1 > 167.1	8	239.1 > 72.0	16	94.7	96.0	88.3	79.8	126.1	123.6	112.2	115.5
82	Diphenylamine	169.1 > 66.0	24	169.1 > 77.0	28	78.2	74.6	65.6	71.1	85.3	99.9	98.3	100.6
83	Disulfoton	186.0 > 153.0	6	186.0 > 97.0	16	71.4	66.2	64.6	78.9	142.4	124.1	107.9	85.8
84	Edifenphos	173.0 > 109.0	10	310.0 > 173.0	14	82.6	103.7	91.0	83.6	97.9	94.6	100.3	98.2
85	Endosulfan ether	240.9 > 205.9	16	238.9 > 203.9	16	62.7	64.4	67.2	69.5	126.7	95.3	104.8	101.2
86	Endosulfan sulfate	271.8 > 236.9	18	386.8 > 252.9	16	83.8	88.4	87.0	85.1	42.5	55.6	83.3	85.8
87	Endosulfan, <i>alpha</i> -	194.9 > 160.0	8	194.9 > 125.0	24	74.0	80.0	75.6	80.7	77.6	76.9	92.3	83.4
88	Endosulfan, <i>beta</i> -	194.9 > 160.0	8	194.9 > 125.0	24	83.1	99.4	81.6	81.7	102.1	67.3	93.2	100.2
89	Endrin	262.9 > 193.0	28	262.9 > 228.0	22	84.1	89.9	77.2	75.3	50.2	49.4	85.3	88.2
90	Endrin aldehyde	249.8 > 214.9	26	344.9 > 244.9	16	N.D.	N.D.	N.D.	N.D.	N.D.	N.D.	N.D.	N.D.
91	Endrin ketone	316.9 > 244.9	20	314.9 > 242.9	18	73.4	91.5	84.1	88.0	108.9	95.4	107.6	101.9
92	EPN	169.1 > 140.9	8	169.1 > 77.0	22	90.3	107.4	89.2	82.3	94.3	102.9	100.2	98.8
93	Ethalfuralin	276.0 > 202.0	18	316.1 > 276.0	10	73.3	67.7	63.0	67.1	95.2	96.4	100.9	100.6
94	Ethion	230.9 > 129.0	24	230.9 > 174.9	14	81.4	97.1	84.2	77.9	118.3	108.6	101.8	102.6
95	Etofenprox	163.1 > 135.1	10	163.1 > 107.1	18	87.1	101.1	95.6	87.3	97.4	103.1	98.8	97.8
96	Etridiazole	210.9 > 182.9	10	210.9 > 139.9	22	70.0	60.1	58.0	66.9	88.2	102.0	102.0	100.4
97	Fenamiphos	303.1 > 195.1	8	288.1 > 260.1	6	88.7	104.6	99.3	87.1	120.9	106.0	96.8	100.1
98	Fenarimol	251.0 > 139.0	14	330.0 > 139.0	8	83.9	106.7	96.5	89.4	97.4	92.6	99.3	96.0
99	Fenchlorphos	284.9 > 269.9	16	286.9 > 271.9	18	80.5	81.4	71.5	74.8	89.8	83.8	99.1	97.2
100	Fenitrothion	277.0 > 260.0	6	260.0 > 125.1	12	78.0	89.3	79.3	75.8	104.9	99.2	111.4	109.6
101	Fenpropathrin	265.1 > 210.1	12	265.1 > 89.0	28	90.3	102.8	96.8	88.2	68.9	75.9	90.9	94.4
102	Fenson	141.0 > 77.0	16	267.9 > 141.0	6	78.3	88.0	77.9	74.5	91.3	92.7	100.8	96.8
103	Fenthion	278.0 > 169.0	14	278.0 > 125.0	20	80.4	81.9	78.2	76.0	93.9	96.0	102.2	104.1
104	Fenvalerate-1	225.1 > 147.1	10	419.1 > 225.1	6	82.2	100.7	94.6	88.9	95.5	92.4	103.2	99.3
105	Fenvalerate-2	225.1 > 147.1	10	419.1 > 225.1	6	75.7	106.7	93.1	86.5	73.5	70.0	86.2	89.7
106	Fipronil	366.9 > 212.9	30	368.9 > 214.9	30	92.8	113.2	99.5	82.8	93.8	96.2	88.0	96.7
107	Fluazifop-P-butyl	282.1 > 91.0	18	383.1 > 282.1	14	77.4	94.0	89.0	80.6	101.9	96.4	99.6	100.5
108	Fluchloralin	306.0 > 264.0	8	326.0 > 63.0	16	76.4	78.4	76.9	75.1	95.8	96.0	90.4	96.5
109	Flucythrinate-1	157.1 > 107.1	12	199.1 > 107.1	22	86.9	111.9	95.6	87.3	119.8	120.4	107.1	105.2
110	Flucythrinate-2	157.1 > 107.1	12	199.1 > 107.1	22	89.4	111.0	96.0	86.6	105.1	108.4	102.6	104.6
111	Fludioxonil	248.0 > 127.0	26	248.0 > 154.0	20	94.1	110.3	96.5	86.1	91.9	101.1	98.1	96.0
112	Fluquinconazole	340.0 > 298.0	20	340.0 > 313.0	14	85.2	107.0	98.9	88.9	97.7	98.5	101.4	101.1
113	Fluridone	328.1 > 259.0	24	328.1 > 127.0	24	91.5	117.7	100.3	91.4	80.1	77.3	93.4	95.7
114	Flusilazole	233.1 > 165.1	14	233.1 > 152.1	14	78.1	93.3	84.9	83.2	105.9	91.5	94.8	95.4
115	Flutolanil	173.0 > 95.0	26	281.1 > 173.0	12	84.1	108.0	93.4	84.7	104.1	101.1	100.0	99.8
116	Flutriafol	219.1 > 123.1	14	219.1 > 95.0	28	82.9	109.6	89.8	84.2	120.1	115.2	103.9	103.9
117	Fluvalinate-1, <i>tau</i> -	250.1 > 55.0	18	250.1 > 200.1	16	86.7	112.8	91.9	85.5	79.4	79.9	90.8	90.4
118	Fluvalinate-2, <i>tau</i> -	250.1 > 55.0	18	250.1 > 200.1	16	90.4	112.0	89.1	83.9	89.6	95.5	102.5	104.7
119	Folpet	259.9 > 130.0	14	261.9 > 130.0	18	65.2	82.9	72.8	67.0	97.2	89.1	99.1	98.3
120	Fonofos	246.0 > 137.1	6	246.0 > 109.1	18	76.6	74.7	65.8	71.4	106.8	97.6	102.1	101.2
121	Heptachlor	271.8 > 236.9	20	273.8 > 238.9	16	68.6	65.4	65.0	68.6	92.3	102.0	104.0	101.2
122	Heptachlor- <i>exo</i> -epoxide	352.8 > 262.9	14	352.8 > 316.9	10	81.1	80.4	71.8	79.1	33.7	39.0	88.6	71.5
123	Hexachlorobenzene	283.8 > 248.8	24	283.8 > 213.8	28	45.7	28.8	48.1	62.3	101.4	100.7	102.7	99.3
124	Hexazinone	171.1 > 71.0	16	171.1 > 85.0	16	93.2	112.9	96.1	88.2	105.3	101.3	104.0	105.2
125	Iodofenphos	376.9 > 361.8	22	376.9 > 331.8	32	80.0	86.8	75.8	74.2	83.8	102.3	97.3	97.1
126	Iprodione	314.0 > 245.0	12	314.0 > 56.0	22	110.5	156.0	102.0	89.9	91.0	99.9	102.2	107.0
127	Isazofos	257.0 > 162.0	8	257.0 > 119.0	18	80.0	87.4	74.4	74.7	109.5	107.1	96.0	102.6
128	Isodrin	192.9 > 157.0	20	262.9 > 192.9	28	76.4	73.7	67.4	71.2	88.2	99.0	110.1	98.6
129	Isopropalin	280.1 > 238.1	8	280.1 > 133.1	18	76.5	88.1	73.6	71.4	89.8	82.7	97.9	106.1
130	Lenacil	153.1 > 136.1	14	153.1 > 82.1	16	85.1	103.2	97.5	85.7	109.0	108.9	124.1	111.8
131	Leptophos	376.9 > 361.9	24	374.9 > 359.9	24	86.8	102.6	89.0	82.6	95.4	99.8	101.9	103.0
132	Linuron	248.0 > 61.0	16	250.0 > 61.0	16	68.3	84.7	77.7	77.9	98.3	83.1	105.8	108.6
133	Malathion	173.1 > 99.0	14	158.1 > 125.0	10	79.9	87.3	77.6	75.3	95.2	97.4	101.3	100.9
134	Metalaxyl	249.2 > 190.1	8	249.2 > 146.1	22	83.5	88.7	89.5	81.1	103.0	122.4	104.0	100.7
135	Metazachlor	209.1 > 132.1	18	211.1 > 132.1	20	83.3	93.2	83.8	80.1	97.8	100.1	101.6	104.8
136	Methacrifos	208.0 > 180.0	8	240.0 > 208.0	4	75.6	68.7	62.9	67.2	93.3	89.0	95.3	101.8
137	Methoxychlor	227.1 > 169.1	24	227.1 > 212.1	14	82.8	101.8	90.8	83.5	109.0	108.5	103.5	103.2
138	Metolachlor	238.1 > 162.1	12	238.1 > 133.1	26	77.0	89.0	77.9	75.4	104.8	96.6	101.4	102.3
139	Mevinphos-1	192.0 > 127.0	12	127.0 > 95.0	18	75.7	70.7	64.1	71.4	95.8	104.8	103.6	102.2
140	MGK 264-1	164.1 > 93.0	10	164.1 > 80.0	24	112.8	102.9	86.2	81.3	92.5	104.4	108.1	104.7
141	MGK 264-2	164.1 > 98.0	12	164.1 > 67.0	8	74.8	89.7	79.3	78.2	116.0	100.8	93.7	96.0
142	Mirex	271.8 > 236.8	18	273.8 > 238.8	18	71.4	80.4	73.6	71.2	99.9	97.3	100.7	99.6
143	Myclobutanil	179.1 > 125.0	14	179.1 > 152.0	8	83.7	104.4	90.8	84.1	122.4	127.5	112.5	108.8
144	N-(2,4-dimethylphenyl) formamide	149.1 > 106.1	16	149.1 > 121.1	6	86.6	88.5	73.0	71.4	334.2	367.6	157.5	169.6
145	Nitralin	316.1 > 274.0	8	274.0 > 169.0	12	101.1	116.0	95.4	87.2	98.7	104.0	106.2	97.4
146	Nitrofen	202.0 > 139.0	24	282.9 > 253.0	12	83.4	91.9	85.9	77.0	89.0	95.2	99.6	104.3
147	Nonachlor, <i>cis</i> -	406.8 > 299.9	24	406.8 > 334.9	16	80.0	91.3	79.8	77.0	59.7	48.5	84.3	87.0
148	Nonachlor, <i>trans</i> -	406.8 > 299.9	24	406.8 > 334.9	16	74.8	86.0	80.8	78.2	58.4	72.4	82.3	84.6
149	Norflurazon	303.0 > 145.0	22	145.0 > 95.0	18	94.7	111.0	98.7	85.0	92.7	95.4	99.2	100.8
150	Oxadiazon	258.0 > 175.0	8	302.0 > 175.0	14	78.8	88.7	84.7	76.9	95.1	101.4	100.4	103.2
151	Oxyfluorfen	361.0 > 300.0	14	361.0 > 317.0	6	101.4	106.2	90.9	80.4	91.2	97.7	101.4	102.1
152	Paclobutrazol	236.1 > 125.0	14	236.1 > 167.0	10	92.2	116.7	92.8	86.1	98.0	86.2	100.9	100.1
153	Parathion	291.1 > 137.0	6	291.1 > 81.0	24	99.8	96.8	80.7	76.0	100.1	115.2	104.9	108.1
154	Parathion-methyl	263.0 > 109.0	14	263.0 > 246.0	6	85.5	91.6	74.2	77.4	71.7	69.8	96.2	93.7
155	Pebulate	161.1 > 128.1	6	128.1 > 57.0	6	64.1	59.1	56.9	66.7	115.3	111.1	101.3	101.7
156	Penconazole	248.1 > 157.1	26	159.1 > 123.1	22	90.9	92.6	75.3	75.4	90.0	94.4	97.6	97.5

ID	Compound Name	Transitions				Recovery (Average of n = 3)				Relative Ion Ratio (Average of n = 3)			
		Target	CE	Reference	CE	10 ng/g-1	10 ng/g-2	50 ng/g-1	50 ng/g-2	10 ng/g-1	10 ng/g-2	50 ng/g-1	50 ng/g-2
157	Pendimethalin	252.1 > 162.1	10	252.1 > 191.1	8	84.0	84.2	73.9	73.8	89.5	98.9	102.2	104.0
158	Pentachloroaniline	262.9 > 191.9	22	264.9 > 193.9	18	23.6	83.6	52.0	72.4	99.4	99.0	101.1	98.8
159	Pentachloroanisole	279.9 > 236.8	26	279.9 > 264.8	12	69.0	65.8	60.2	67.9	102.8	93.3	101.7	101.4
160	Pentachlorobenzene	249.9 > 214.9	18	249.9 > 176.9	26	59.9	27.0	47.6	62.0	104.3	113.2	108.4	104.3
161	Pentachlorobenzonitrile	274.8 > 239.8	18	272.8 > 202.9	30	69.3	65.6	63.2	68.7	90.1	88.2	96.3	95.7
162	Pentachlorothiobanisole	295.8 > 262.9	14	295.8 > 245.8	30	55.8	75.7	62.7	69.7	92.4	96.3	94.9	93.5
163	Permethrine, cis-	183.1 > 153.1	14	183.1 > 168.1	14	86.6	112.1	96.8	87.5	101.7	108.3	99.5	100.2
164	Permethrine, trans-	183.1 > 153.1	14	183.1 > 168.1	14	96.0	131.5	97.0	88.4	100.4	98.3	103.6	102.4
165	Perthane	223.2 > 167.1	14	223.2 > 193.1	28	85.3	92.7	81.9	78.1	97.1	106.8	102.3	100.3
166	Phenothrin-1	183.1 > 153.1	14	183.1 > 168.1	14	N.D.	N.D.	N.D.	84.8	N.D.	N.D.	111.5	92.4
167	Phenothrin-2	183.1 > 153.1	14	183.1 > 168.1	14	100.7	113.7	95.7	86.7	101.4	112.1	105.1	100.1
168	Phorate	260.0 > 75.0	8	231.0 > 129.0	24	74.3	63.8	61.9	69.7	92.7	116.3	99.8	101.6
169	Phosalone	182.0 > 102.0	14	182.0 > 111.0	14	86.3	101.6	93.9	84.4	117.0	123.8	101.2	104.5
170	Phosmet	160.0 > 77.0	24	160.0 > 105.0	18	86.7	105.4	92.6	83.0	100.8	100.1	103.5	101.2
171	Piperonyl butoxide	176.1 > 131.1	12	176.1 > 117.1	20	84.1	112.8	92.1	85.9	104.9	118.6	102.2	102.3
172	Pirimiphos ethyl	304.1 > 168.1	12	318.1 > 166.1	12	78.1	94.3	79.1	73.8	83.5	84.4	97.4	105.8
173	Pirimiphos-methyl	290.1 > 125.0	22	290.1 > 233.1	12	80.4	88.9	78.5	76.1	93.3	92.5	101.2	99.4
174	Pretilachlor	262.1 > 202.1	10	238.1 > 162.1	10	77.0	95.2	86.0	79.7	109.6	79.5	93.4	102.5
175	Prochloraz	180.1 > 138.1	12	180.1 > 69.0	20	68.1	110.1	85.4	81.5	106.2	102.1	91.1	91.2
176	Procymidone	283.0 > 96.0	10	285.0 > 96.0	10	12.4	140.1	78.8	79.4	103.0	101.7	104.7	101.8
177	Prodiamine	321.1 > 279.1	6	321.1 > 203.1	10	86.1	94.7	81.6	78.3	88.5	88.3	93.6	99.0
178	Profenofos	338.9 > 268.9	18	336.9 > 266.9	14	87.1	93.5	90.0	85.6	107.6	107.6	93.3	91.1
179	Profluralin	318.1 > 199.1	16	318.1 > 55.0	22	66.3	64.9	65.7	74.8	105.2	95.9	97.6	91.7
180	Propachlor	176.1 > 57.0	8	176.1 > 77.0	24	74.9	76.4	67.3	71.4	114.9	106.5	103.8	102.7
181	Propanil	217.0 > 161.0	10	160.9 > 126.0	18	93.5	105.3	91.4	78.7	100.7	106.9	95.8	104.6
182	Propargite	173.1 > 135.1	16	173.1 > 107.1	24	88.0	98.7	90.8	85.5	120.0	122.8	74.1	66.1
183	Propisochlor	223.1 > 132.1	20	223.1 > 147.1	8	83.7	90.8	79.4	77.9	91.0	100.1	98.4	101.0
184	Propyzamide	172.9 > 109.0	26	172.9 > 74.0	28	83.0	91.4	77.1	76.5	98.7	100.0	108.7	106.3
185	Prothiofos	266.9 > 238.9	10	309.0 > 238.9	14	74.3	88.9	78.0	73.9	102.4	94.4	102.7	101.2
186	Pyraclufos	194.0 > 138.0	22	360.1 > 194.0	14	91.6	111.4	97.0	87.0	84.1	89.9	99.3	100.1
187	Pyrazophos	221.1 > 193.1	12	221.1 > 149.1	14	88.7	111.9	97.3	86.1	101.7	96.0	99.9	103.7
188	Pyridaben	147.1 > 117.1	22	147.1 > 132.1	14	87.5	106.4	92.5	84.1	99.2	105.1	102.0	102.5
189	Pyridaphenthion	340.0 > 199.1	8	199.1 > 92.0	16	100.2	120.0	95.0	89.3	114.1	129.2	109.5	107.5
190	Pyrimethanil	198.1 > 118.1	28	198.1 > 158.1	18	74.4	82.5	75.3	73.2	95.2	99.1	96.4	98.5
191	Pyriproxyfen	136.1 > 96.0	14	226.1 > 186.1	14	81.3	91.9	92.8	84.4	59.7	78.1	88.1	84.8
192	Quinalphos	146.1 > 118.0	10	146.1 > 91.0	24	71.7	86.6	79.6	72.9	204.6	155.7	122.4	117.8
193	Quintozene	294.8 > 236.8	16	264.8 > 236.8	10	61.7	0.0	18.5	71.1	100.1	100.7	101.5	100.3
194	Resmethrin-1	171.1 > 128.1	12	171.1 > 143.1	6	N.D.	N.D.	N.D.	N.D.	N.D.	N.D.	N.D.	N.D.
195	Resmethrin-2	171.1 > 143.1	6	171.1 > 128.1	14	85.8	96.4	85.8	78.1	86.0	97.9	95.6	100.0
196	Sulfotep	322.0 > 294.0	4	322.0 > 202.0	10	79.1	71.8	65.5	71.8	94.6	98.9	98.0	95.0
197	Sulprofos	322.0 > 156.0	8	156.0 > 108.0	28	80.7	97.3	86.0	83.2	101.1	95.9	97.3	95.1
198	Tebuconazole	250.1 > 125.1	22	250.1 > 153.1	12	76.8	82.9	68.1	71.6	112.5	96.6	98.9	98.1
199	Tebufenpyrad	333.1 > 171.1	20	333.1 > 276.1	8	87.7	105.2	96.7	84.7	97.6	97.3	94.6	95.6
200	Tecnazene	260.9 > 202.9	14	202.9 > 85.0	24	78.8	59.9	59.7	72.4	93.9	99.1	96.8	95.8
201	Tefluthrin	177.0 > 127.1	16	177.0 > 137.1	16	79.0	81.2	67.5	72.5	92.6	94.9	101.0	98.3
202	Terbacil	161.0 > 88.0	20	117.0 > 76.0	8	97.5	111.6	86.5	82.0	81.8	77.9	92.5	96.1
203	Terbufos	231.0 > 128.9	26	231.0 > 174.9	14	78.8	80.6	65.2	70.3	111.6	100.1	102.8	104.7
204	Terbutylazine	229.1 > 173.1	6	214.1 > 71.0	16	94.9	91.0	77.6	77.1	82.6	91.6	99.7	103.3
205	Tetrachlorvinphos	328.9 > 109.0	20	330.9 > 109.0	22	87.4	102.5	87.3	81.0	96.0	93.6	99.9	96.6
206	Tetradifon	355.9 > 159.0	18	355.9 > 228.9	12	84.1	96.6	93.6	88.5	87.9	103.1	102.9	96.7
207	Tetramethrin-1	164.1 > 107.1	14	164.1 > 77.0	22	N.D.	N.D.	100.5	94.8	N.D.	N.D.	106.5	114.1
208	Tetramethrin-2	164.1 > 107.1	14	164.1 > 77.0	22	103.2	129.6	98.4	88.4	115.2	117.0	107.9	113.8
209	THPI	151.1 > 79.0	18	151.1 > 77.0	28	79.4	85.0	81.5	78.2	104.7	104.1	103.6	108.0
210	Tolclofos-methyl	264.9 > 93.0	24	264.9 > 219.9	22	72.8	78.6	72.6	73.8	98.8	100.9	102.3	103.6
211	Tolyfluanid	238.0 > 137.1	14	181.1 > 138.1	10	66.8	79.8	65.9	64.1	118.7	117.3	114.3	107.4
212	Transfluthrin	163.1 > 127.1	6	163.1 > 143.1	16	84.2	85.7	77.1	77.6	106.3	115.0	97.7	99.0
213	Triadimefon	208.1 > 111.0	22	208.1 > 127.0	14	88.4	98.2	86.7	80.5	99.5	103.9	97.9	104.7
214	Triadimenol	168.1 > 70.0	10	128.1 > 65.0	22	N.D.	N.D.	101.2	94.2	N.D.	N.D.	80.9	85.6
215	Tri-allate	268.1 > 184.0	20	270.1 > 186.0	20	80.0	75.6	68.6	74.6	102.4	85.9	94.6	98.1
216	Triazophos	257.0 > 162.0	8	257.0 > 134.0	22	89.7	112.4	94.8	86.4	95.9	80.8	90.3	88.2
217	Tricyclazole	189.0 > 161.9	12	189.0 > 135.0	18	91.5	95.7	84.5	81.8	105.9	118.7	105.2	97.3
218	Triflumizole	278.1 > 73.0	6	206.1 > 186.1	8	87.2	88.2	71.5	76.8	83.2	110.9	97.0	99.2
219	Trifluralin	306.1 > 264.1	8	306.1 > 160.1	22	79.9	73.6	64.4	72.5	92.7	100.3	100.8	101.1
220	Vinclazolin	285.0 > 212.0	12	212.0 > 172.0	16	86.3	92.8	79.9	80.7	84.3	96.4	104.2	103.3
QC-1	1,4-Dichlorobenzene-d4	150.0 > 78.0	24	115.1 > 78.0	12	—	—	—	—	—	—	—	—
QC-2	Acenaphthene-d10	164.0 > 160.0	30	164.0 > 134.0	38	—	—	—	—	—	—	—	—
QC-3	Chrysene-d12	240.0 > 236.0	30	240.0 > 212.0	24	—	—	—	—	—	—	—	—
QC-4	Naphthalene-d8	136.0 > 84.0	22	136.0 > 82.0	28	—	—	—	—	—	—	—	—
QC-5	Perylene-d12	264.0 > 263.0	34	264.0 > 262.0	24	—	—	—	—	—	—	—	—
QC-6	Phenanthrene-d10	188.0 > 160.0	24	187.0 > 159.0	18	—	—	—	—	—	—	—	—
IS-1	2,2',5'-Trichlorobiphenyl	255.9 > 186.0	26	257.9 > 186.0	26	—	—	—	—	—	—	—	—
IS-2	2,4,4'-Trichlorobiphenyl	255.9 > 186.0	26	257.9 > 186.0	26	—	—	—	—	—	—	—	—
IS-3	2,2',5,5'-Tetrachlorobiphenyl	257.0 > 222.0	12	292.0 > 220.0	26	—	—	—	—	—	—	—	—
IS-4	Triphenylmethane	244.1 > 167.1	16	244.1 > 165.1	26	—	—	—	—	—	—	—	—
IS-5	Triphenylphosphate	215.1 > 168.1	16	325.1 > 169.1	20	—	—	—	—	—	—	—	—
IS-6	Tris(1,3-dichloroisopropyl)phosphate	379.0 > 159.0	12	381.0 > 159.0	12	—	—	—	—	—	—	—	—

Compounds outside the red box (Fig. 5) were classified to four groups.

Group A showed low recovery; this group consisted mainly of compounds which have low boiling point. They may have been lost in the evaporation step. Group B showed high relative ion ratios and this was caused by interference from matrix. Group C showed high recov-

ery; this group consisted of 10 ng/g fortified sample. Some of these were in matrix originally and quantified incorrectly. Others caused by their transitions which had low response and low stability. Group D showed low relative ion ratio. It was necessary to set higher response transitions. By modifying some procedures and parameters, positions of these compounds may improve.

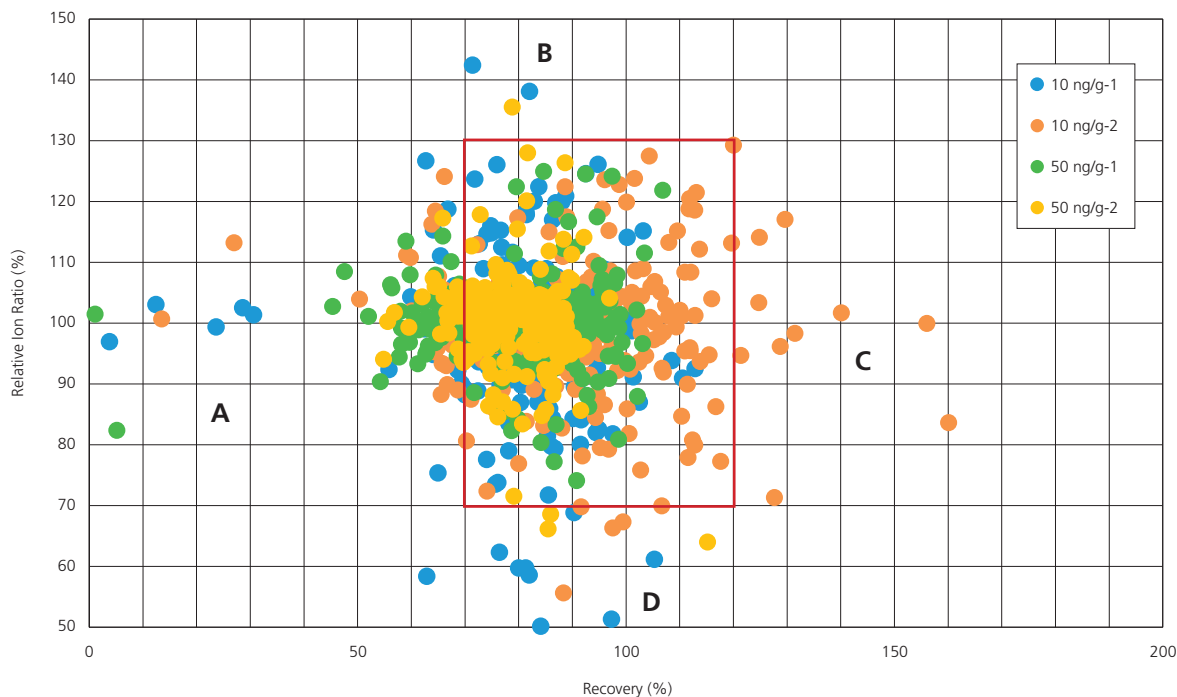

Fig. 5 Combination Map Between Recovery and Ion Ratio (Average of $n = 3$ for Each Fortified Samples)
Red box shows the area of 70–120% recovery and $\pm 30\%$ relative ion ratio.

4. Conclusion

This study shows that the modified QuEChERS method combined with GC-MS/MS achieved consistent pesticides monitoring in botanical ingredients.

Although dried sample could make a heavy and difficult matrix, the modified QuEChERS method, SPE column cleanup, and toluene dilution steps suppressed interference from matrix. The GC-MS/MS detected very low amount of pesticides even though the sample was diluted. This analytical method takes only 30 minutes in total run time and covers over 200 pesticides. It provides a high throughput solution in laboratories doing this type of analysis.

Reference

- 1) M. Anastassiades, S. J. Lehotay, D. Štajnbaher, F. J. Schenck, Fast and Easy Multiresidue Method Employing Acetonitrile Extraction/Partitioning and “Dispersive Solid-Phase Extraction” for the Determination of Pesticide Residues in Produce, *J. AOAC Int.*, **86** (2003) 412–431
- 2) European Commission, Health & Consumer Protection Directorate-General, Guidance document on analytical quality control and validation procedures for pesticide residues analysis in food and feed, SANCO/12571/2013

Triple Quadrupole Gas Chromatograph Mass Spectrometer

GCMS-TQ8040

Smart Performance That Boosts Routine Analytical Work

GC-MS/MS is useful for measuring trace quantities of various chemical substances present in a variety of sample types. However, specifying several parameter settings and employing suitable methods are required when using this technique.

Nevertheless, GCMS-TQ8040 can dramatically increase the productivity by automating tedious method creation processes and simultaneously analyzing multiple components with high sensitivity.



Smart Productivity

- Includes a new firmware protocol.
- Simultaneously analyzes a wide range of compounds with high sensitivity and high accuracy.
- Twin Line MS system minimizes the replacement of columns.

Smart Operation

- Smart MRM automatically creates optimized methods.
- Automatically searches for optimal transitions.
- AART function automatically adjusts retention times.

Smart Performance

- Patented high-sensitivity ion source technology offers even higher sensitivity.
- OFF-AXIS Ion Optics reduces noise.
- Capable of performing high-sensitivity analysis even as a single GC-MS system.

GC/MS Residual Pesticides Database

Smart Pesticides Database Ver. 2

Supports the Simultaneous Analysis of 530 Residual Pesticides in Foods via GC-MS(/MS)

Smart Pesticides Database contains the retention indices and transitions for 530 pesticides. Ver. 2 additionally contains measurement ions for SIM mode, so it can be applied to both SIM and MRM analyses. Thanks to the retention indices contained in the database and the AART function, retention times can be revised automatically without the use of pesticide standards.

Furthermore, the Smart MRM/SIM function allows automatic creation of the optimal measurement programs for multicomponent simultaneous analysis using MRM and SIM modes. Lastly, the database can be customized to the GC conditions and the addition of new components.

Compound Name (E)	Ret. Index			Ion1				Ion2				Ion1				Ion2				
	Ret. Index 1	Ret. Index 2	Ret. Index 3	Type	m/z	CE	Ratio	Type	m/z	CE	Ratio	Type	m/z	CE	Ratio	Type	m/z	CE	Ratio	
Hymexazol	1201	1193	1191	T	99.0>71.0	8	100.00	Ref.1	99.0>54.0	26	6.13	T	99.0	100.00	Ref.1	71.0	18.40			
Methamidophos	1240	1231	1229	T	141.0>95.0	8	100.00	Ref.1	141.0>79.0	22	31.28	T	141.0	100.00	Ref.1	94.0	337.84			
Dichlorvos	1248	1244	1243	T	109.0>79.0	8	100.00	Ref.1	185.0>93.0	14	56.91	T	185.0	100.00	Ref.1	109.0	403.23			
Nereistoxin	1285	1284	1274	T	149.1>71.1	8	100.00	Ref.1	149.1>102.1	6	67.94	T	70.0	100.00	Ref.1	149.0	51.20			
Alliodochlor	1290	1288	1283	T	132.1>56.0	8	100.00	Ref.1	138.1>96.0	6	26.15	T	138.0	100.00	Ref.1	173.0	6.98			
Dichlobenil	1348	1345	1335	T	170.9>136.0	14	100.00	Ref.1	170.9>100.0	24	98.06	T	171.0	100.00	Ref.1	173.0	76.00			
EPTC	1359	1358	1353	T	189.1>126.1	4	100.00	Ref.1	189.1>86.0	12	22.96	T	128.0	100.00	Ref.1	189.0	25.60			
Biphenyl	1393	1391	1380	T	154.1>126.1	22	100.00	Ref.1	154.1>115.1	24	74.03	T	154.0	100.00	Ref.1	153.0	37.60			
Propamocarb	1394	1393	1390	T	188.2>72.0	4	100.00	Ref.1	188.2>173.2	4	72.45	T	58.0	100.00	Ref.1	129.0	2.40			
Mevinphos-1	1420	1420	1419	T	127.0>109.0	12	100.00	Ref.1	192.0>127.0	12	61.12	T	127.0	100.00	Ref.1	192.0	31.60			

Verifying the Effectiveness of Recovery Tests of Health Foods

In conducting recovery tests in health foods for 220 pesticides, using the database, recommended pretreatment kit, pretreatment protocol, and certified standard substances, we succeeded in obtaining excellent ratios in over 80 percent of components.

Health foods contain many contaminants. Because it includes transitions for the separation of contaminants, the database minimizes their impact.

Additionally, the database can separate contaminants by allowing analysis with a different column, even if peaks of target pesticides and contaminants overlap. If the database is used in combination with the Twin Line MS system, analysis with different columns can be performed smoothly, without compromising the MS vacuum.

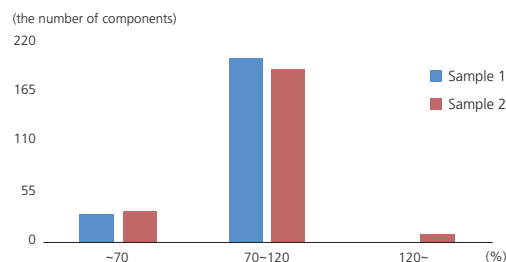

Distribution of rates for two health food samples which were spiked with a pesticide standard sample so as to obtain a final concentration of 2.5 ng/mL each.

First Edition: December, 2016



Shimadzu Corporation

www.shimadzu.com/an/

For Research Use Only. Not for use in diagnostic procedures.

This publication may contain references to products that are not available in your country. Please contact us to check the availability of these products in your country.

The content of this publication shall not be reproduced, altered or sold for any commercial purpose without the written approval of Shimadzu. Company names, products/service names and logos used in this publication are trademarks and trade names of Shimadzu Corporation, its subsidiaries or its affiliates, whether or not they are used with trademark symbol "TM" or "®".

Third-party trademarks and trade names may be used in this publication to refer to either the entities or their products/services, whether or not they are used with trademark symbol "TM" or "®".

Shimadzu disclaims any proprietary interest in trademarks and trade names other than its own.

The information contained herein is provided to you "as is" without warranty of any kind including without limitation warranties as to its accuracy or completeness. Shimadzu does not assume any responsibility or liability for any damage, whether direct or indirect, relating to the use of this publication. This publication is based upon the information available to Shimadzu on or before the date of publication, and subject to change without notice.

Application News

No. C136

Liquid Chromatography Mass Spectrometry

Expanding Capabilities in Multi-Residue Pesticide Analysis Using The LCMS-8060

David R. Baker¹, Laëtitia Fages², Eric Capodanno², Neil Loftus¹
¹Shimadzu Corporation, UK; ²Phytocontrol, France

■ Abstract

With an increasing global population, food security is increasingly under threat and there is a growing challenge for agriculture to produce more food, safely and more sustainably. The use of herbicides, insecticides, and fungicides reduce crop losses both before and after harvest, and increase crop yields. However, pesticide residues resulting from the use of plant protection products on crops may pose a risk to human health and require a legislative framework to monitor pesticide residues in food.

National programs for pesticide monitoring in the US, Europe and Japan have set Maximum Residue Levels (MRL's) or tolerance information (EPA) for pesticides in food products. A default value of 0.01 mg/kg is applied for MRL enforcement, which therefore requires highly sensitive and specific analytical technologies to monitor an increasing number of pesticides.

This application note describes the expanded capability of the LCMS-8060 to help accelerate method development workflows and support increased pesticide monitoring programs. Using the Shimadzu Pesticide MRM Library (the Library includes information on 766 certified reference materials) a single multi-residue LC/MS/MS method was developed for 646 pesticides (3 MRM transitions for over 99 % targeted pesticides resulting in 1,919 transitions in total, with a polarity switching time of 5 msec).

Keywords: Pesticides; food safety; LCMS-8060; Pesticide MRM Library, 776 compound library

■ Introduction

There are more than 1,000 pesticides used globally on soil and crops. With the ever increasing international trade of the food industry, regulatory bodies around the world have increased the number of regulated pesticides and the maximum residue levels (MRLs) allowed in food commodities. In the EU, regulation 396/2005/EC and its annexes set MRLs for over 500 pesticides in 370 food products.¹⁾ In the US, tolerances for more than 450 pesticides and other ingredients are established by the US EPA²⁾ and Japan's positive list system for agricultural chemical residues in foods contains MRLs for over 400 pesticides in various commodities.³⁾

National pesticide monitoring programs create new challenges for food safety laboratories as the number of pesticides required for analysis is increasing together with an expanded range of food products.

In this application paper we present the development of a LC-MS/MS method for screening and quantifying over 646 pesticides in a single method. The method

was quickly and efficiently set up using the Shimadzu Pesticide MRM Library. For each target pesticide analysis, up to 3 MRMs (Multiple Reaction Monitoring) transitions were imported from the library. 3 MRMs transitions provided additional data confidence in reporting results in comparison to the conventional 2 transitions used in most methods. As the LCMS-8060 has a high data acquisition speed 1,919 transitions were acquired using a polarity switching speed of 5 msec over a 10.5 minutes gradient elution.

To evaluate the method QuEChERS extracts of mint, tomato and apple were provided by a commercial laboratory as raw acetonitrile extracts and spiked with 646 pesticides (data is presented on the mint extract as it is the more complex sample matrix). The method was evaluated in matrix to ensure that the reporting limits were in agreement with recognised MRL's.

■ Experiment

Food extracts of mint, tomato and apple were supplied by Phytocontrol, France, following established QuEChERS protocols. Final extracts were prepared in acetonitrile without any dilution. Certified reference materials for the Shimadzu Pesticide MRM Library were obtained from ACSD, France as stock solutions. All solvents were of LCMS quality purchased from Sigma-Aldrich.

A six point calibration curve from 0.002 - 0.1 mg/kg (2 - 100 pg/μL) were generated using internal standard method. Two internal standards (Atrazine-d5 and Diuron-d6) were spiked in during the auto-sampler sequence for quantitation.

The robustness of the LCMS-8060 was assessed by peak area response for 646 pesticides spiked into mint, tomato and apple matrix extracts at 0.05 mg/kg.

■ LC/MS/MS method development

The Shimadzu Pesticide MRM Library has 766 pesticides in its database (Application News No. C135). For each pesticide several MRM's are included in the database and in this analysis the default value used was 3 MRM's. For this method, 1,919 transitions were selected in both positive and negative ionisation mode using a switching time of 5 msec (1,819 MRM transitions were in positive mode and 100 MRM transitions in negative mode).

To optimize ion source conditions (for example, DL temperature, interface temperature, heating block temperature, heating gas flow, drying gas flow and nebulizer gas flow) the interface setting software was used. This tool provides an optimized response for all compounds.

Table 1 LC and MS/MS Acquisition Parameters

Liquid chromatography		Mass spectrometry	
UHPLC	Nexera LC system	LC/MS/MS	LCMS-8060
Analytical column	Restek Raptor Biphenyl (2.1 mm I.D. × 100 mm L., 2.7 μm)	Ionisation mode	Heated electrospray
Column temperature	35 °C	Polarity switching time	5 msec
Flow rate	0.4 mL/min	Pause time	1 msec
Solvent A	2 mmol/L ammonium formate + 0.002 % formic acid - Water	Total MRM transitions	1,919 (1,819 positive; 100 negative)
Solvent B	2 mmol/L ammonium formate + 0.002 % formic acid - Methanol	MRM Dwell	4 msec (target ion); 1 msec (reference ion)
Binary Gradient B.Conc.	3 % (0 min) - 10 % (1.00 min) - 55 % (3.00 min) - 100 % (10.50 - 12.00 min) - 3 % (12.01 - 15.00 min)	Interface temperature	350 °C
Injection volume	2 μL sample (plus 40 μL water)	Heating block	300 °C
		Desolvation line	150 °C
		Heating gas	10 L/min
		Drying gas	10 L/min
		Nebulizer gas	3 L/min

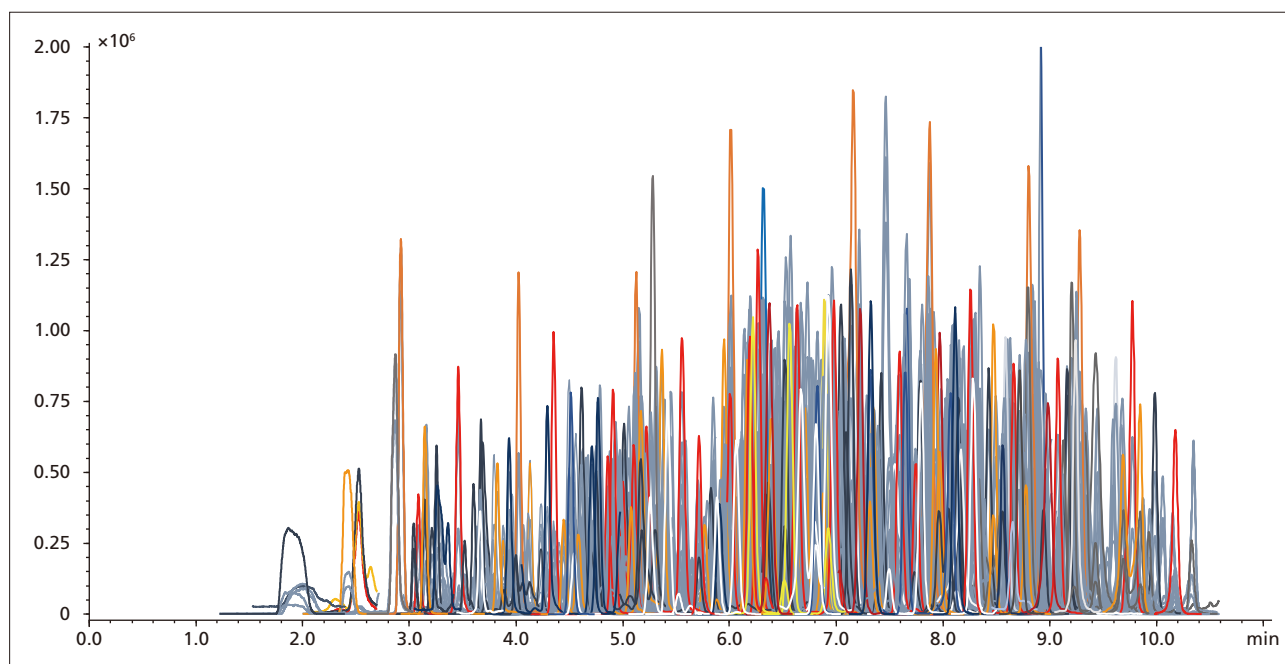

Fig. 1 MRM chromatograms of 646 pesticides spiked into a mint extract at 0.01 mg/kg (Up to 3 MRMs per compound and 5 msec polarity switching time).

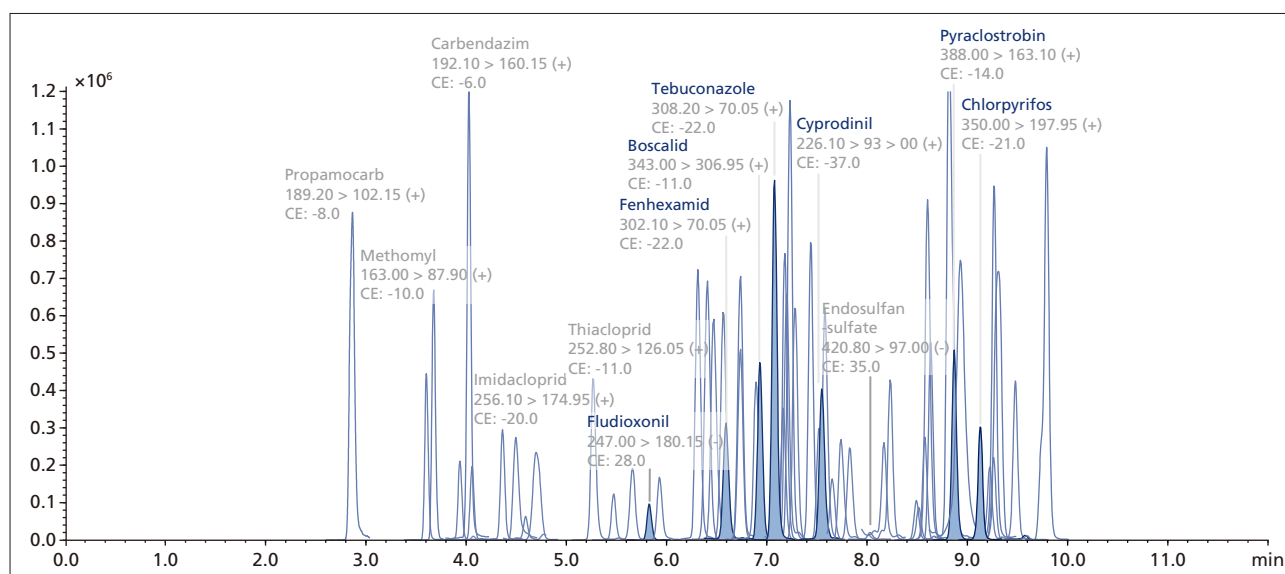

Fig. 2 MRM chromatograms for pesticides most commonly detected in plant products listed in the 2015 European Food Safety Journal. In this report, residues exceeding the legal limits were related to 58 different pesticides. Compounds such as boscalid, chlorpyrifos, cyprodinil, fenhexamid, fludioxonil, pyraclostrobin and tebuconazole (highlighted in the MRM chromatogram) are some of the most frequently detected compounds present in more than 4 % of the samples analyzed.

The MRM chromatograms show the response to each pesticide spiked into a food matrix at the default MRL of 0.01 mg/kg.

■ Results and Discussion

Shimadzu Pesticide MRM Library

(Application News No. C135)

A flexible tool for expanding capabilities in pesticide monitoring programs

The Pesticide MRM Library has been created using 766 certified reference materials and is designed to help accelerate method development and compound management.

The library contains an average of 8 optimized MRM transitions for each compound (including positive and negative ion modes). In total, more than 6,000 MRM transitions are held within the 766 compound library. The library itself documents CAS#, formula, activity, mono-isotopic mass and adduct masses, rank of MRM transitions, synonyms, InChI, InChIKey, compound names translation (Japanese and Chinese) and links to websites offering further information (for example; alanwood.net, PAN pesticide database, Chemical Book, ChemSpider).

The library also serves as a powerful data repository for reporting and checking pesticide data sources.

Creating flexible pesticide monitoring methods

Building a new LC/MS/MS method

To create new pesticide LC/MS/MS methods the user simply needs to select the target compounds from the library, identify the required number of MRMs for each compound and confirm the analytical column for the analysis. (The new method can be used to expand current capabilities or to create focused methods with a limited number of pesticides). The new method is simply imported into LabSolutions.

As the LCMS-8060 has a high data acquisition speed of 30,000 u/sec, high sensitivity and a polarity switching speed of 5 msec, the capabilities of the library can be expanded to meet the future needs of any laboratory.

Expanded capability of the LCMS-8060

The LCMS-8060 has a data acquisition speed of 30,000 u/sec which creates new opportunities for expanding compound lists.

As one example, between 6.45 and 6.60 minutes 25 pesticide compounds elute (Fig. 3). Even with high data density acquisitions the average variation in peak area response was less than 3 %RSD (varying between 1.1 - 5.9 %RSD).

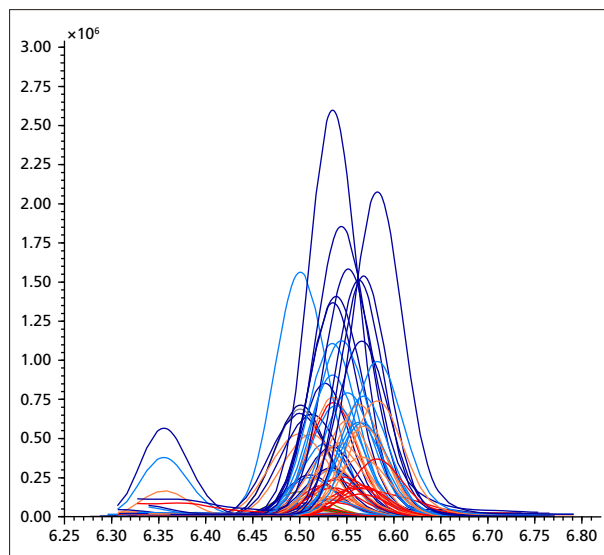

Fig. 3 The LCMS-8060 can acquire MRM data at a high speeds and enables precise quantitation even with high data density. Between 6.45 and 6.60 minutes 25 compounds were monitored (Table 2).

Table 2 Peak area variation (%RSD; n=6) for 25 pesticides eluting over a nine-second time window (6.45 - 6.60 minutes) spiked into a mint matrix extract at the reporting limit of 0.01 mg/kg.

Compound Name	CAS number	Formula	M	Polarity	MRM Quantitation Ion	RT	Average Peak Area	%RSD (n=6)
Trinexapac-ethyl	95266-40-3	C13H16O5	252.0998	+	252.90 > 69.05	6.45	1,780,015	3.1
lprovalicarb	140923-17-7	C18H28N2O3	320.2100	+	321.20 > 119.15	6.46	1,442,486	2.8
Dodemorph	1593-77-7	C18H35NO	281.2719	+	282.30 > 116.15	6.47	658,920	4.2
Fluopyram	658066-35-4	C16H11ClF6N2O	396.0464	+	397.00 > 145.00	6.47	2,439,146	1.9
Flutolanil	66332-96-5	C17H16F3NO2	323.1133	+	324.10 > 242.00	6.48	3,372,285	2.7
Trifloxysulfuron	145099-21-4	C14H14F3N5O6S	437.0617	+	438.00 > 182.15	6.48	1,822,340	2.5
Azaconazole	60207-31-0	C12H11Cl2N3O2	299.0228	+	300.00 > 159.00	6.50	1,580,445	2.0
Terbutryn	886-50-0	C10H19N5S	241.1361	+	242.10 > 157.95	6.50	755,446	3.4
Prometryn	7287-19-6	C10H19N5S	241.1361	+	242.10 > 158.00	6.50	1,300,193	2.6
Azimsulfuron	120162-55-2	C13H16N10O5S	424.1026	+	425.10 > 182.10	6.50	2,498,050	1.8
Metominostrobin	133408-50-1	C16H16N2O3	284.1161	+	285.10 > 193.95	6.51	2,929,500	1.7
Thifluzamide	130000-40-7	C13H6Br2F6N2O2S	525.8421	+	528.60 > 148.05	6.51	193,982	5.9
Nicarbazin	330-95-0	C13H10N4O5	302.0651	-	301.10 > 137.15	6.52	973,101	2.6
Bromobutide	74712-19-9	C15H22BrNO	311.0885	+	312.10 > 194.10	6.53	1,829,781	2.1
Saflufenacil	372137-35-4	C17H17ClF4N4O5S	500.0544	+	501.00 > 198.00	6.53	465,224	2.3
Cyproconazole	94361-06-5	C15H18ClN3O	291.1138	+	292.10 > 70.05	6.54	1,174,967	1.7
Clomazone	81777-89-1	C12H14ClNO2	239.0713	+	239.90 > 125.00	6.54	3,409,656	1.7
Fensulfothion	115-90-2	C11H17O4PS2	308.0306	+	309.00 > 281.00	6.54	4,267,514	1.4
Oxasulfuron	144651-06-9	C17H18N4O6S	406.0947	+	407.10 > 150.15	6.54	2,911,533	1.1
Rimsulfuron	122931-48-0	C14H17N5O7S2	431.0569	+	432.00 > 182.00	6.55	4,722,065	1.8
Fenthion-oxon	6552-12-1	C10H15O4PS	262.0429	+	263.10 > 231.00	6.55	3,075,195	1.4
Nitrothal-isopropyl	10552-74-6	C14H16NO6Na	317.0875	+	295.10 > 230.95	6.56	2,199,581	3.0
Chlorantraniliprole	500008-45-7	C18H14BrCl2N5O2	480.9708	+	483.90 > 452.90	6.57	2,407,025	2.7
Fipronil-sulfone	120068-36-2	C12H4Cl2F6N4O2S	451.9336	-	451.00 > 414.90	6.57	2,843,708	2.0
Valifenalate	283159-90-0	C19H27ClN2O5	398.1608	+	399.20 > 155.00	6.59	3,845,335	1.9

Final method performance for 646 pesticides

In order to test the performance of the developed method, linearity, repeatability and longer term robustness were assessed for all 646 pesticides.

Linearity

Linearity was assessed over a six point calibration curve from 0.002 - 0.1 mg/kg (2 - 100 pg/μL). All 646 pesticides achieved excellent R² values greater than 0.99 in both tomato and mint spiked extracts with typical values greater than 0.996. Calibration curves were generated using a linear curve fit type and 1/C weighting. Typical calibration curve data is presented below in Fig. 4.

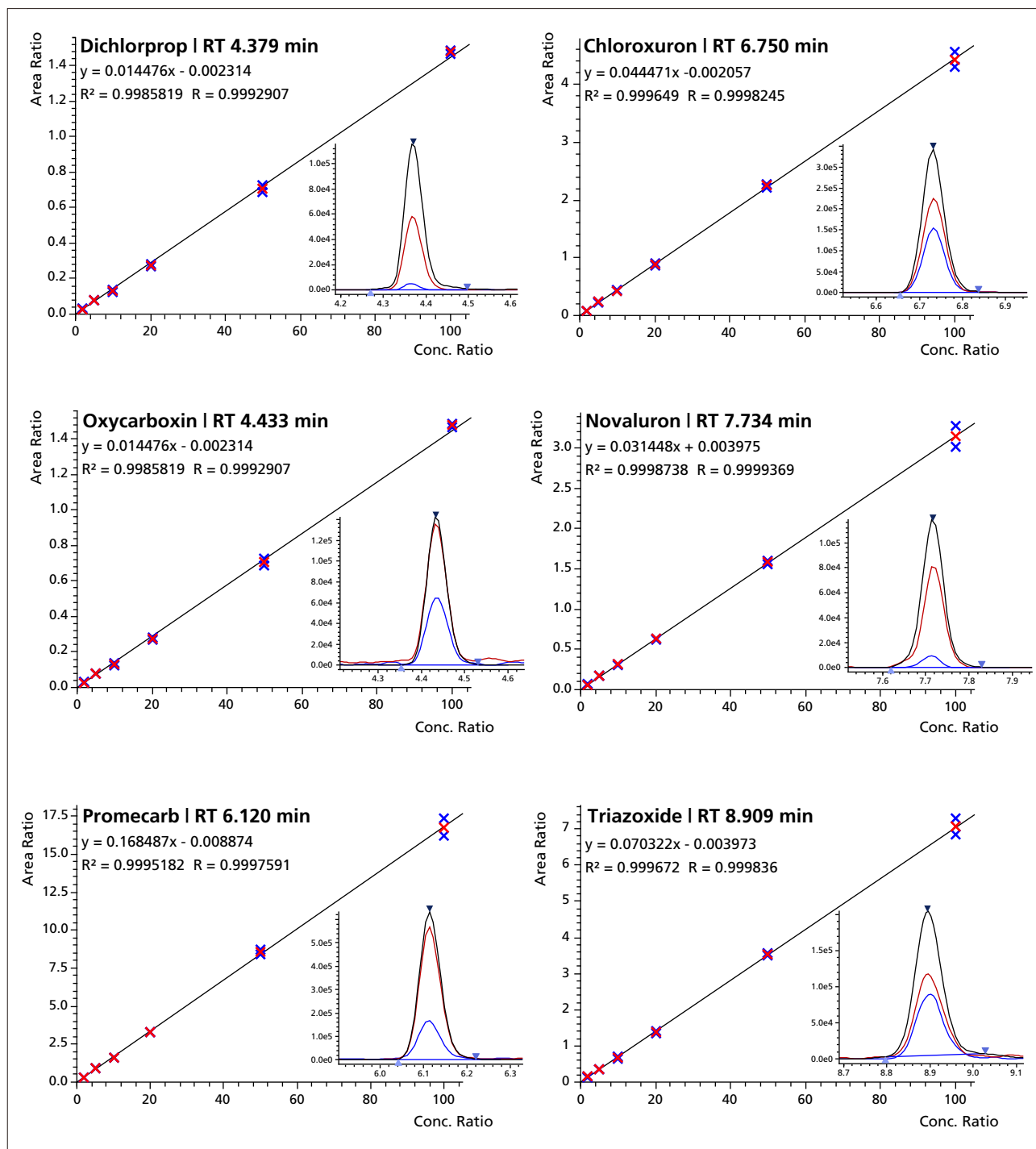

Fig. 4 Calibration curves for selected pesticides spiked into a mint matrix extract in the range 0.002 - 0.1 mg/kg. The quantitation MRM chromatogram is shown in black (qualifier ion MRM chromatograms are shown in red and blue).

Repeatability

To assess the robustness of the system and the developed method during routine analysis, repeat injections of a mint matrix sample spiked with 646 pesticides at 0.05 mg/kg, were analyzed over a 24 hour period.

The results for selected compounds are displayed below in Fig. 5.

Compounds were selected throughout the run at equidistant points (closest elution points to 3, 4, 5, 6, 7, 8, 9 and 10 minutes), including positive and negative ion detection, (Table 3).

The peak area variance was less than 5.7 % for all pesticides measured.

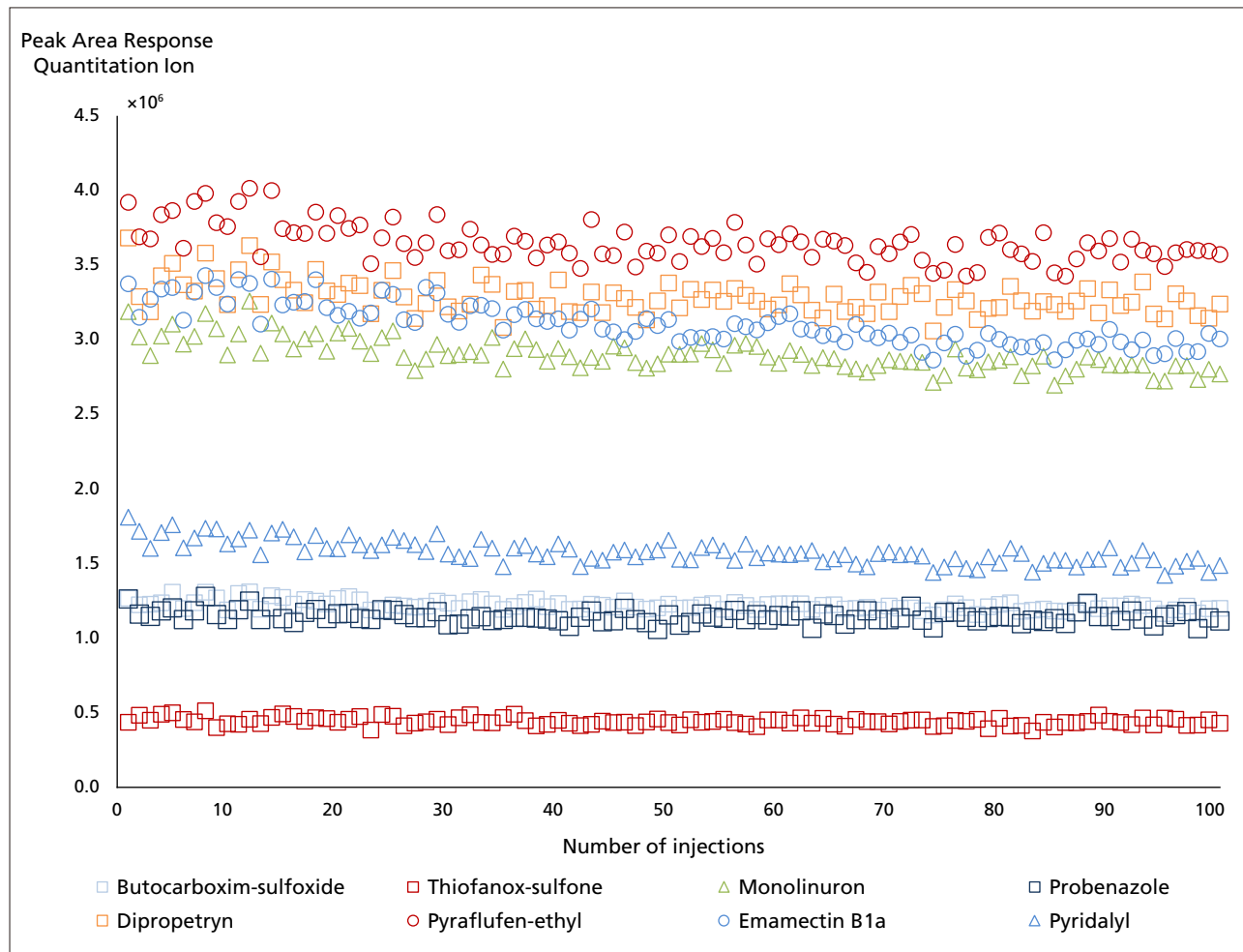

Fig. 5 Peak area response for several pesticides following 100 repeat injections of a 0.05 mg/kg spiked into mint matrix extract.

Table 3 Peak area variance for selected following the repeated injection of a 0.05 mg/kg spiked into mint matrix extract (number of sample replicates was 100; the analysis sequence was 24 hours).

Compound Name	CAS Number	Formula	M	Polarity	MRM Quantitation Ion	RT (mins)	Average Peak Area	%RSD (n=100)
Butocarboxim-sulfoxide	34681-24-8	C7H14N2O3S	206.0725	+	207.10 > 75.10	3.042	1,220,391	2.6
Thiofanox-sulfone	39184-59-3	C9H18N2O4S	250.0987	+	268.10 > 57.00	4.001	442,724	5.7
Monolinuron	1746-81-2	C9H11ClN2O2	214.0509	+	215.10 > 99.10	4.985	2,904,116	3.7
Probenazole	27605-76-1	C10H9NO3S	223.0303	+	224.00 > 41.05	5.995	1,145,189	3.5
Dipropetryn	4147-51-7	C11H21N5S	255.1518	+	256.20 > 144.05	6.999	3,289,597	3.4
Pyraflufen-ethyl	129630-19-9	C15H13Cl2F3N2O4	412.0204	+	413.00 > 339.00	8.004	3,653,333	3.5
Emamectin B1a	138511-97-4	C56H81NO15	1007.5606	+	886.40 > 158.20	9.008	3,109,562	4.5
Pyridalyl	179101-81-6	C18H14Cl4F3NO3	488.9680	-	491.90 > 109.05	10.171	1,579,422	5.0

Response to differing matrices

One of the major challenges in the quantitative LC/MS/MS analysis for pesticides in food is that compound and matrix-dependent response suppression or enhancement may occur. Although matrix effects can affect the peak area response between different food types following a QuEChERS extraction protocol, the peak area variance should be minimized within a single matrix.

Food extracts of apple, mint and tomato following QuEChERS extraction were spiked with 646 pesticides at 0.05 mg/kg and were repeatedly injected on the LCMS-8060 (n=100 repeat injections for each matrix; 300 injections in the same batch sequence). Fig. 6 shows the response for 3 selected pesticides analyzed in a single batch sequence corresponding to a 72 hour analysis sequence. Within a matrix, variance was less than 5.9 %RSD for all compounds.

Although the absolute peak area changes with different food matrices, the response between injection 1 and injection 100 for 2 pesticides (probenazole and dipropetryn) within a single matrix has a variance less than 5.7 %RSD.

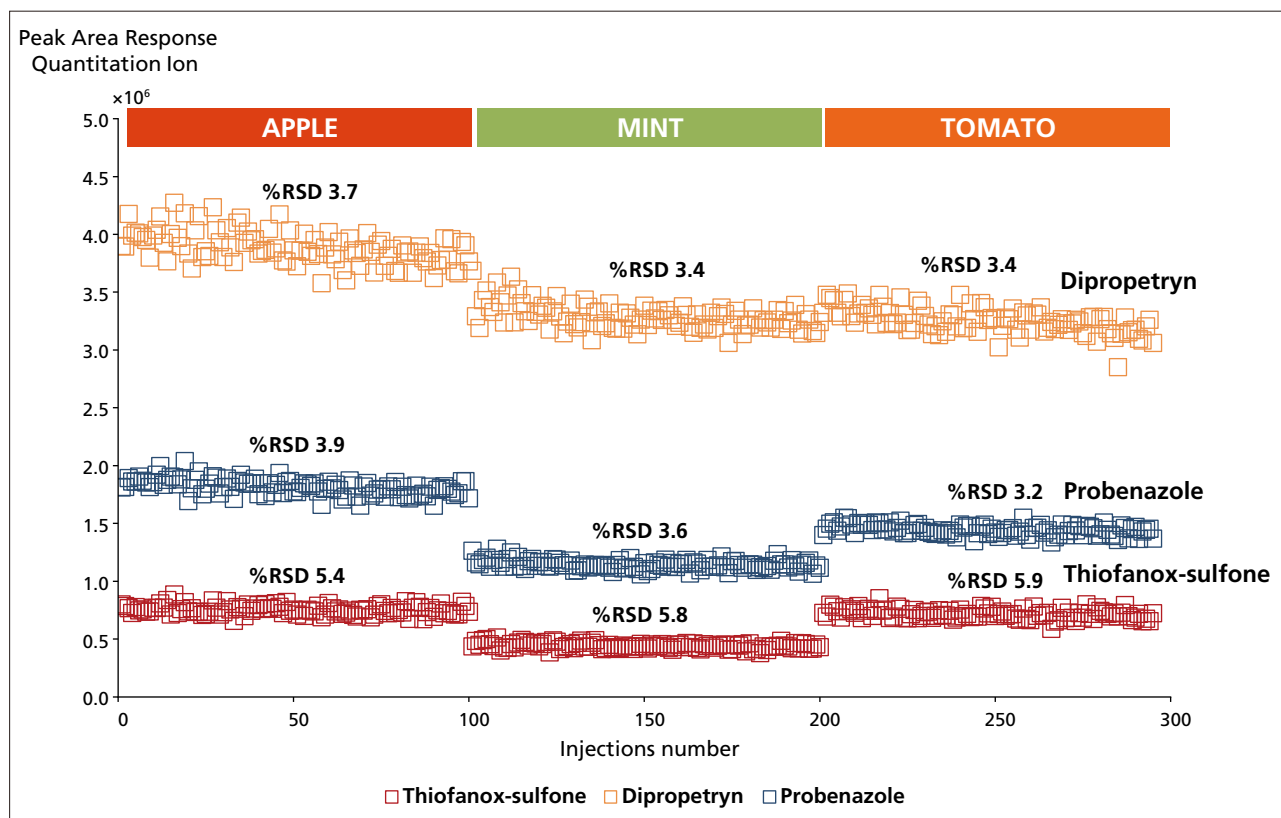

Fig. 6 Peak area response for three pesticides spiked into apple, mint and tomato matrix extracts at 0.05 mg/kg over 72 hours. As in Fig. 5, compounds were selected to reflect peak area response throughout the chromatographic run (Table 3).

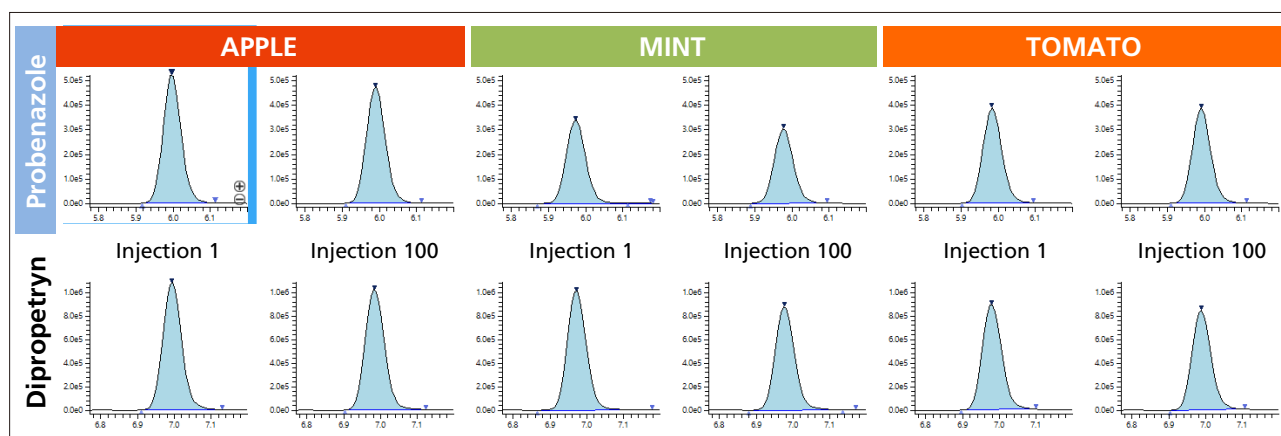

Fig. 7 MRM chromatograms for probenazole (RT 5.995 minutes) and dipropetryn (RT 6.999 minutes) for injection 1 and injection 100 spiked into apple, mint and tomato matrix extracts. The extracts were spiked at 0.05 mg/kg and analyzed over 72 hours.

Reducing matrix effects by extensively diluting the sample

The need to test for more pesticides in a wider range of samples at high sensitivity is very challenging as matrix effects from the sample extraction will influence both ion suppression and enhancement. Ion suppression can lead to errors in the detection capability, accuracy and precision of the method.

To reduce the effect of interfering compounds in the quantitation of complex samples extensive sample dilution is now widely used in routine analysis. It is an approach which is simple to build into multi-residue extraction methods and is cost effective.

This approach leads to greater robustness as a consequence of a reduced sample injection in the LC/MS/MS, higher data quality and increased instrument uptime.

Fig. 8 shows the results of diluting a matrix sample spiked at 0.005 mg/kg with dilution factors of 1:5, 1:10, 1:20, 1:50 and 1:100.

As matrix effects can be both significant and variable for different compounds Table 4 shows recovery data for a series of pesticides diluted from 0 to a dilution factor of 1:100.

Matrix suppression was reduced for most compounds when the sample was diluted 1:10 with recoveries in the range of 70 - 120 % with an associated repeatability RSDr ≤ 20 %. Relative standard deviations in relation to the mean values were typically less than 10 %.

Diluting the sample by a factor of 20 or 50 resulted in acceptable signal suppression from the matrix.

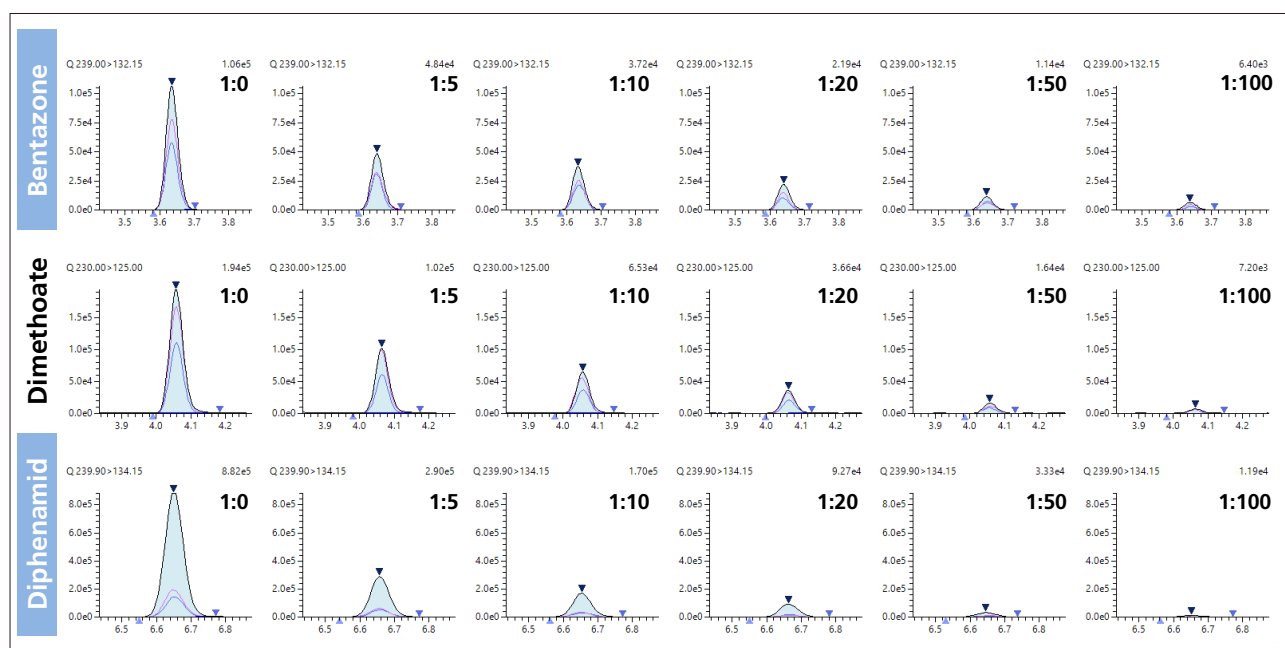

Fig. 8 MRM chromatograms for 3 selected compounds spiked into a mint extract at 0.005 mg/kg and diluted 1:5, 1:10, 1:20, 1:50 and 1:100 with water.

Table 4 Diluting a sample matrix extract spiked with 0.005 mg/kg with water reduced matrix ion suppression.

Compound	CAS	Formula	M	Dilution series					
				0	1:5	1:10	1:20	1:50	1:100
Bentazone	25057-89-0	C10H12N2O3S	240.0569	32.1	44.6	65.5	72.7	91.7	98.1
Demeton-S-methyl-sulfone	17040-19-6	C6H15O5PS2	262.0099	51.1	78.5	89.6	91.1	114.2	116.8
Dimethoate	60-51-5	C5H12NO3PS2	228.9996	36.2	65.3	88.5	92.2	92.4	94.2
Isocarbamid	30979-48-7	C8H15N3O2	185.1164	28.8	57.1	81.8	98.7	102.5	96.4
Vamidothion	2275-23-2	C8H18NO4PS2	287.0415	53.6	76.3	98.2	98.5	101.5	114.1
Thiazafurion	25366-23-8	C6H7F3N4OS	240.0293	32.8	62.9	80.5	84.2	87.1	97.4
Demeton-S-methyl	919-86-8	C6H15O3PS2	230.0200	57.8	82.1	93.1	87.6	108.5	102.4
Sebuthylazine	7286-69-3	C9H16ClN5	229.1094	28.7	53.3	69.8	79.8	88.5	95.8
Flutriafol	76674-21-0	C16H13F2N3O	301.1027	27.3	46.1	71.4	76.1	81.8	87.3
Furametpyr	123572-88-3	C17H20ClN3O2	333.1244	48.3	69.8	86.9	86.2	97.6	101.9
Fenobucarb	3766-81-2	C12H17NO2	207.1259	60.9	79.2	100.7	96.1	102.8	103.9
Benodanil	15310-01-7	C13H10INO	322.9807	50.9	69.8	86.3	96.5	102.4	94.8
Terbuthylazine	5915-41-3	C9H16ClN5	229.1094	50.4	66.6	83.2	87.2	89.8	91.0
Dimethachlor	50563-36-5	C13H18ClNO2	255.1026	75.1	86.1	106.0	107.1	106.2	108.0
Dimethenamid	87674-68-8	C12H18ClNO2S	275.0747	72.6	84.9	102.9	100.0	103.6	97.3
Furalaxyl	57646-30-7	C17H19NO4	301.1314	82.2	89.1	106.6	108.6	106.2	102.4
Bixafen	581809-46-3	C18H12Cl2F3N3O	413.0310	66.8	79.3	99.0	95.6	103.7	97.1
Triflururon	64628-44-0	C15H10ClF3N2O3	358.0332	54.2	71.8	95.5	84.9	95.3	101.7
Epoxiconazole	133855-98-8	C17H13ClFN3O	329.0731	61.6	77.2	98.8	95.3	90.0	101.2
Teflubenzuron	83121-18-0	C14H6Cl2F4N2O2	379.9742	41.8	50.9	80.1	86.8	100.0	97.7

■ Conclusion

A fast, selective and highly sensitive method has been developed for the quantitation of 646 pesticides using a single method with 1,919 transitions (corresponding to up to 3 MRM transitions per compound) and a LC gradient time of only 10.5 minutes.

As the LCMS-8060 has a rapid polarity switching time of 5 msec, the single multi-residue LC/MS/MS method supported the analysis of 34 pesticides in negative ion mode and 612 compounds in positive ion mode.

The enhanced performance and higher sensitivity of the LCMS-8060 has created new opportunities in sample dilution to reduce ion signal suppression and matrix effects. For most compounds a dilution factor of 1:20 or 1:50 was sufficient to provide recoveries in the range 70 - 120 %.



■ References

1. Commission Regulation (EC). 2005. No 396/2005 of the European Parliament and of the Council, maximum residue levels of pesticides in or on food and feed of plant and animal origin. Official Journal of the European Union, L 70: 1-16
2. US Environmental Protection Agency, Electronic code of federal regulation: Title 40: Part 180 - tolerances and exemptions for pesticide chemical residues in food. http://www.ecfr.gov/cgi-bin/text-idx?c=ecfr&tpl=/ecfrbrowse/Title40/40cfr180_main_02.tpl
3. Japanese Ministry of Health, Labour and Welfare, Department of Food Safety. 2006. Director Notice about Analytical Methods for Residual Compositional Substances of Agricultural Chemicals, Feed Additives, and Veterinary Drugs in Food (Syoku-An No. 0124001 January 24, 2005; amendments May 26, 2006).

For Research Use Only. Not for use in diagnostic procedure.

This publication may contain references to products that are not available in your country. Please contact us to check the availability of these products in your country.

The content of this publication shall not be reproduced, altered or sold for any commercial purpose without the written approval of Shimadzu. Company names, product/service names and logos used in this publication are trademarks and trade names of Shimadzu Corporation or its affiliates, whether or not they are used with trademark symbol "TM" or "@". Third-party trademarks and trade names may be used in this publication to refer to either the entities or their products/services. Shimadzu disclaims any proprietary interest in trademarks and trade names other than its own.

The information contained herein is provided to you "as is" without warranty of any kind including without limitation warranties as to its accuracy or completeness. Shimadzu does not assume any responsibility or liability for any damage, whether direct or indirect, relating to the use of this publication. This publication is based upon the information available to Shimadzu on or before the date of publication, and subject to change without notice.

Application News

LCMS

No.C118

Liquid Chromatography Mass Spectrometry

Highly Polar Pesticide Multi-Residue Analysis in Food Safety by LC-MS/MS

 David R. Baker¹, Eric Capodanno², Mikaël Levi³
¹Shimadzu Corporation, UK; ²Phytocontrol, France; ³Shimadzu France, France

Abstract

The analysis of highly polar pesticides by a single LC-MS/MS method is extremely challenging as a consequence of diverse separation and detection behaviour. Conventional approaches in highly polar pesticide analysis often use single residue methods or small group specific methods which are time consuming and limit throughput. In this study, the panel of target analytes selected for analysis included a series of compounds that are typically addressed by multiple methods and workflows; glufosinate, glyphosate, ethephon, fosetyl aluminium, maleic hydrazide, perchlorate, ETU, PTU, nicotine, amitrole, chlormequat, daminozide, diquat, kasugamycine, mepiquat, paraquat and trimesium.

To accelerate turnaround times and increase sample sizes for more complete testing programs two LC-MS/MS methods were developed for the measurement of a range of highly polar pesticides in their underivatised state using the LCMS-8050 triple quadrupole mass spectrometer. All target compounds were quantified at 0.01 mg/kg which is below the European Union maximum residue limit for all studied compounds delivering a measurable impact on sample cycle time and productivity.

Keywords: Highly polar pesticides, LCMS-8050, food safety, glyphosate, diquat, paraquat, perchlorate

Introduction

The use of pesticides in the environment is constantly under review and in recent years regulatory bodies have adopted a hazards-based approach to pesticide regulation leading to an increased use of highly polar pesticides which present lower persistence and toxicity. Enforcing pesticide limits within regulatory limits defined as the maximum residue levels (MRL's; the maximum concentration of pesticide residues permitted in food and feed) requires methods that provide results quickly and accurately for a broad spectrum of chemical structures in a diverse range of food samples.

Pesticide residue monitoring laboratories utilise multi-residue LC-MS/MS methods for the quantification of an ever increasing list of target pesticides. However, the measurement of highly polar pesticides by a single LC-MS/MS method is extremely challenging as a consequence of diverse separation and detection behaviour. For this reason, single residue methods or small group specific methods are often utilised to analyse these compounds, in some cases including the use of pre- or post-column derivatisation. Therefore, there is a clear need to reduce the number of separation methods applied to the analysis of highly polar pesticides to help accelerate sample throughput, reduce the cost platform, simplify analytical workflows and enhance data quality for regulatory reporting limits.

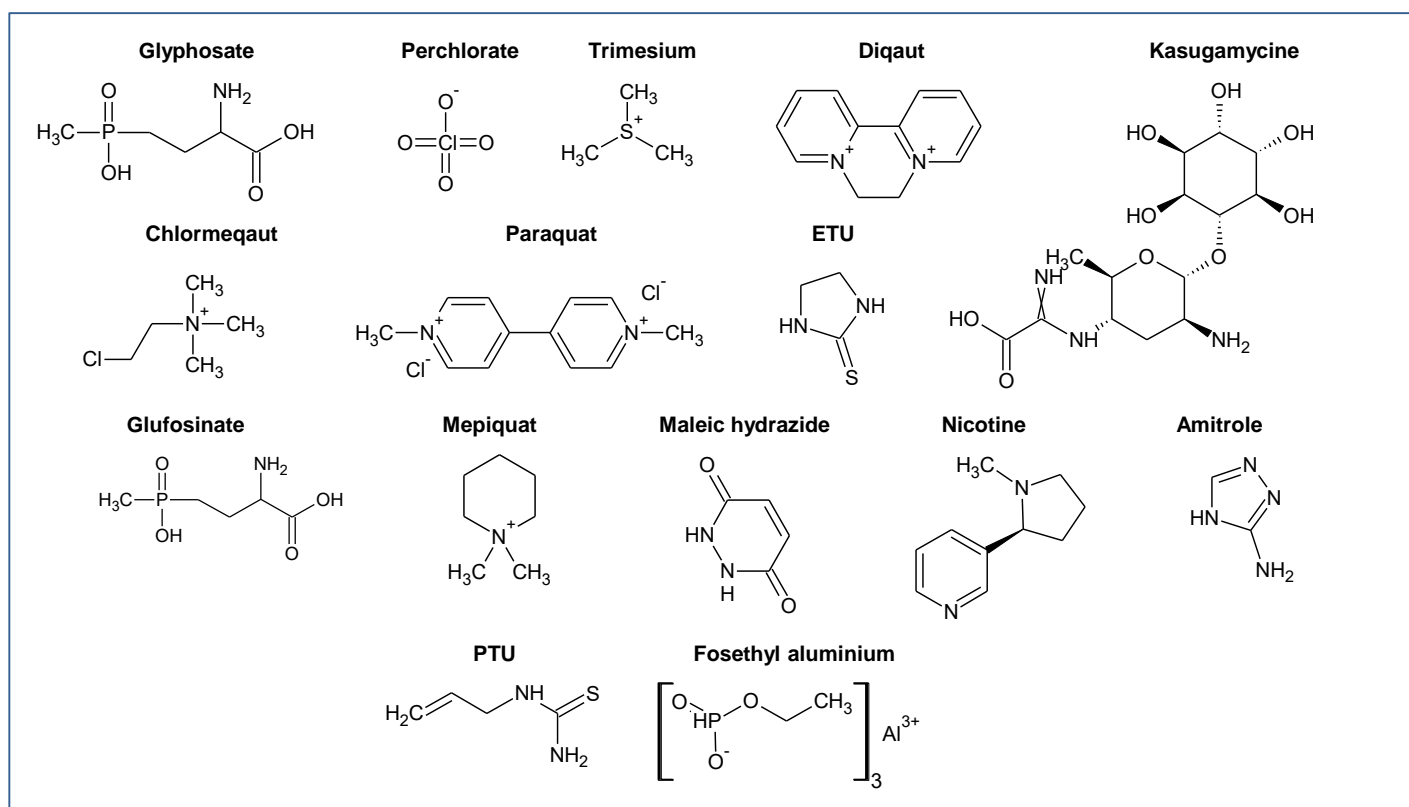

Figure 1. Target analyte structures

The highly polar pesticides targeted in this study included glufosinate, glyphosate, ethephon, fosethyl aluminium, maleic hydrazide, perchlorate, ETU, PTU, nicotine, amitrole, chlomequat, daminozide, diquat, kasugamycine, mepiquat, paraquat and trimesium. Structures for these compounds are displayed in Figure 1. All of the compounds included in this study were polar, characterised with LogKow < 1. The most polar compounds being the cationic quaternary ammonium herbicides diquat (LogKow -4.6) and paraquat (LogKow -4.5). Several of the compounds also have a low molecular mass, for example trimesium (77 g/mol), amitrole (84 g/mol) and ETU (102 g/mol).

The analysis of highly polar pesticides is extensively reported in literature but the methods have been limited to a small number of specific target compounds and not to a group with such a diverse chemical space. For example, a common approach for the analysis of one of the world's biggest selling herbicides glyphosate is typically achieved by FMOc derivatization. This derivatization step is specific for glyphosate, glufosinate and AMPA residues in water and food samples but it is relatively complex, limits throughput and repeatability and reproducibility can suffer due to the derivatisation step.

The aim of this study was to develop a fast, sensitive and simple methodology for a range of challenging highly polar pesticides that require single-residue methods, by as few multi-residue LC-MS/MS runs as possible and without the need for derivatisation. Several different analytical columns and mobile phases were evaluated in this study, in addition to assessing the MS/MS parameters. Isotopically labelled standards were used to compensate for matrix effects. Initial data was collected in food matrix using a triple quadrupole mass spectrometer in MRM mode.

Experimental

Individual reference standards for each compound were provided by Phytocontrol in methanol at a concentration of 10 ng/ μ L. Mobile phase solvents and additives were all LC-MS quality and purchased from Sigma-Aldrich. Apple extracts were provided by Phytocontrol and extracted according to the EURL-SRM QuPPE methodology.¹ Briefly, apple samples (10 g) were prepared by chopping up the sample, freezing, homogenizing with dry ice, adding 1% formic acid in methanol solution (10 mL) and centrifuging (4000 RPM). Linearity was evaluated by spiking sample extracts at the following levels: 0.005, 0.01, 0.02, 0.05, 0.1 and 0.2 mg/kg. Deuterated internal standards were used for calibration. All calibration points were analysed in duplicate. Plastic vials were used for analysis to prevent interaction of certain pesticides (e.g. paraquat, diquat and glyphosate) with glass surfaces.¹

SRM transitions and analyte specific MS parameters (Q1 pre-bias (V), Q3 pre-bias (V) and collision energy) were optimised automatically using the SRM optimisation feature available in LabSolutions software. SRM transitions are listed in Table 2 and Table 3.

Preliminary investigations involved the testing of several different analytical columns: SIELC Obselisc R (150 x 2.1mm, 5 μ m); Hypercarb PGC (100 x 2.1mm, 5 μ m); SeQuant ZIC-HILIC (100 x 2.1mm, 3.5 μ m), SeQuant ZIC-cHILIC (100 x 2.1mm, 3.5 μ m), Scherzo SM-C18 (50 x 2, 3 μ m), Scherzo SW-C18 (50 x 2, 3 μ m), Fortis Phenyl (100 x 2.1mm, 5 μ m), Luna Phenyl-Hexyl (100 x 2.1mm, 3 μ m), and Restek IBD (150 x 2.1mm, 3 μ m). These columns were tested with several different mobile phase additives including acetic acid, formic acid, ammonium formate, ammonium acetate and ammonium hydroxide (depending on appropriate conditions for each column and the progression of results). Reversed phase, HILIC, and mixed mode chromatography were tested depending on the column suitability for each mode. The final LCMS/MS method conditions are listed in Table 1.

Table 1. LC/MS/MS parameters for Method 1 and Method 2

Liquid chromatography				
	Method 1		Method 2	
UHPLC	Nexera UHPLC system		Nexera UHPLC system	
Analytical column	ZIC-HILIC (100 x 2.1mm, 3.5 μ m)		Hypercarb PGC (100mm x 2.1mm, 5 μ m)	
Mobile phase	A = Water 20mM ammonium formate and 0.3% formic acid		A = Water 1% acetic acid	
	B = Acetonitrile		B = Methanol 1% acetic acid	
Gradient	Time (mins)	%B	Time (mins)	%B
	0	97	0	0
	5.8	68	10	30
	9	15	15	35
	10	15	17.5	68
	10	97	18	100
	16	Stop	22	100
			22.1	0
			33	Stop
Column temp.	35°C		35°C	
Injection volume	6 μ L (40 μ L acetonitrile co-injected)		5 μ L	
Flow rate	0.4mL/min		0.3mL/min	
Mass spectrometry				
LC/MS/MS	LCMS-8050			
Ionisation mode	Heated electrospray			
Polarity switching time	5 ms			
Pause time	1 ms			
Dwell times	5-50ms			
Interface temperature	350°C			
Heating block	300°C			
Desolvation line	200°C			
Gas	Heating gas 10 L/min; drying gas 10 L/min; Nebulising gas 3 L/min			

Table 2. Method 1 MS acquisition parameters, retention time and internal standard

Compound	Ret. time (min)	Polarity	SRM transitions	Q1 (V)	CE	Q3 (V)	ISTD	MS1 Res.	MS2 Res.
Amitrole	3.1	Positive	85 > 43	-14	-25	-14	Paraquat d8	Unit	Unit
			85 > 57	-14	-20	-20			
			85 > 58	-14	-23	-22			
Chlormequat	4.1	Positive	122 > 58	-28	-27	-21	Chlormequat d4	Unit	Unit
			122 > 59	-28	-23	-21			
			122 > 63	-28	-22	-23			
Daminozide	2.2	Positive	161 > 143	-16	-14	-25	Chlormequat d4	Unit	Unit
			161 > 44	-16	-22	-16			
			161 > 45	-16	-23	-16			
Diquat	4.0	Positive	183 > 157	-12	-21	-27	Paraquat d8	Unit	Unit
			183 > 78	-12	-39	-12			
			183 > 130	-12	-34	-22			
Kasugamycine	7.8	Positive	380 > 112	-18	-20	-18	Chlormequat d4	Unit	Unit
			380 > 200	-18	-13	-20			
Mepiquat	4.5	Positive	114 > 98	-22	-29	-15	Mepiquat d3	Unit	Unit
			114 > 58	-22	-26	-21			
			114 > 42	-22	-45	-14			
Paraquat	9.0	Positive	186 > 171	-12	-20	-30	Paraquat d8	Unit	Unit
			186 > 77	-12	-45	-27			
			186 > 169	-12	-35	-29			
Trimesium	5.1	Positive	77 > 62	-13	-21	-22	Paraquat d8	Unit	Unit
			77 > 47	-13	-27	-17			
			77 > 45	-13	-45	-16			
Chlormequat d4	4.1	Positive	126 > 58	-21	-29	-21		Unit	Unit
Mepiquat d3	4.5	Positive	117 > 101	-20	-29	-18		Unit	Unit
Paraquat d8	9.0	Positive	193 > 178	-13	-21	-30		Unit	Unit

Table 3. Method 2 MS acquisition parameters, retention time and internal standard

Compound	Ret. time (min)	Polarity	SRM transitions	Q1 (V)	CE	Q3 (V)	ISTD	MS1 Res.	MS2 Res.
Glyphosate	3.7	Positive	170 > 88	-17	-9	-18	Glyphosate C13	Unit	Unit
			170 > 42	-17	-26	-17			
			170 > 60	-17	-16	-24			
Gluphosinate	2.9	Positive	182 > 136	-12	-11	-26	Maleic hydrazide d2	Unit	Unit
			182 > 56	-12	-24	-23			
			182 > 119	-12	-19	-23			
ETU	3.1	Positive	103 > 44	-19	-18	-15	ETU d4	Unit	Unit
			103 > 60	-19	-28	-23			
			103 > 86	-19	-21	-28			
Fosethyl	9.9	Negative	109 > 81	23	13	29	Fosethyl d15	Unit	Unit
			109 > 63	23	25	23			
			109 > 79	23	24	28			
Maleic hydrazide	13.7	Positive	113 > 40	-11	-27	-16	Maleic hydrazide d2	Unit	Unit
			113 > 67	-11	-19	-27			
			113 > 85	-11	-17	-17			
Nicotine	2.0	Positive	163 > 130	-16	-21	-22	Nicotine d3	Unit	Unit
			163 > 117	-16	-25	-20			
			163 > 132	-16	-17	-23			
Perchlorate	30.1	Negative	99 > 83	22	26	30	Perchlorate 18O4	Unit	Unit
			99 > 67	22	37	23			
			101 > 85	22	26	30			
PTU	3.1	Positive	117 > 58	-20	-16	-19	ETU d4	Unit	Unit
			117 > 60	-20	-29	-20			
			117 > 72	-12	-22	-26			
ETU d4	3.0	Positive	107 > 48	-18	-19	-16		Unit	Unit
Fosethyl d5	9.6	Negative	114 > 82	24	15	30		Unit	Unit
Maleic hydrazide d2	13.6	Positive	115 > 42	-11	-20	-17		Unit	Unit
Glyphosate 13C2 15N	3.6	Positive	173 > 91	-11	-8	-19		Unit	Unit
Nicotine d3	1.7	Positive	166 > 130	-30	-22	-21		Unit	Unit
Perchlorate 18O4	30.1	Negative	107 > 89	23	27	30		Unit	Unit

Results and Discussion

Following evaluation of several different analytical columns, mobile phases and mass spectrometer settings, two methods were developed for a range of highly polar pesticides that typically require single residue methods to analyse. A ZIC-HILIC column, a zwitterionic stationary phase covalently attached to porous silica, was used in method 1 to analyse the following; amitrole, chlormequat, daminozide, diquat, kasugamycine, mepiquat, paraquat and trimesium. While a Hypercarb PGC (porous graphitic carbon), which behaves as a strongly retentive alkyl-bonded silica gel, was used in method 2 to analyse the following; glufosinate, glyphosate, ethephon, fosethyl aluminium, maleic hydrazide, perchlorate, ETU, PTU, and nicotine.

Three MRM transitions were acquired for each analyte, with exception of two transitions for kasugamycine. Linearity was evaluated for all compounds in the range 0.005 mg/kg – 0.2 mg/kg (5 – 200 ppb) in apple matrix. The concentration of each calibration level is listed in the experimental section. All seven target compounds achieved excellent correlation coefficients greater than $R^2 > 0.9975$, using internal standards for quantitation, linear fit and 1/C weighting. Calibration curves for several compounds are displayed in Figure 3 (using LC method 1) and Figure 5 (using LC method 2). The linearity results for all target compounds is listed in Table 4.

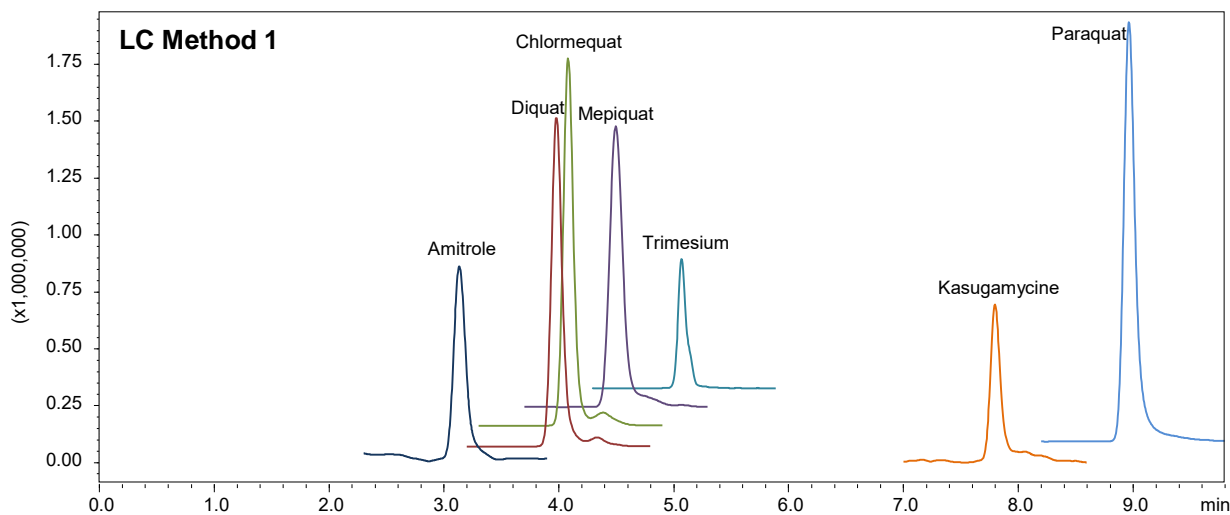

Figure 2. Target analytes at 0.05mg/kg in apple matrix using a ZIC-HILIC based separation (LC Method 1)

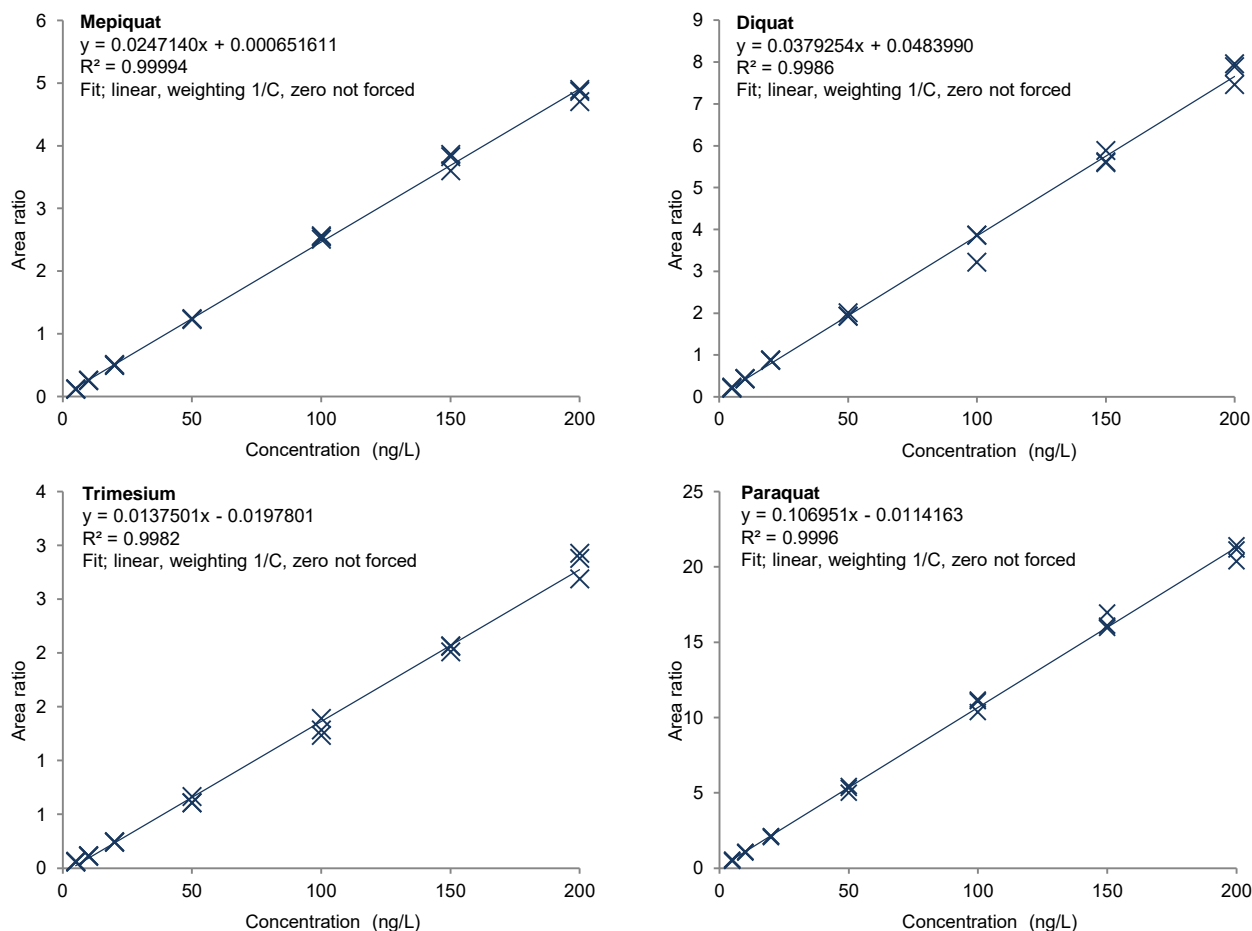

Figure 3. Calibration curves for paraquat, mepiquat, trimesium and diquat using a ZIC-HILIC based separation (LC Method 1)

Figure 2 displays a chromatogram of each compound at 0.05 mg/kg using a ZIC-HILIC based separation (LC method 1) and Figure 4 display a chromatogram using a Hypercarb PGC based separation (LC method 2). All target analytes were identified at 0.01 mg/kg. This concentration is below the European Union (EU) maximum residue limit (MRL) for all of the target analytes in this study. For example, the EU MRL for the following compounds in the majority of commodities is;

glyphosate 0.1 mg/kg, glufosinate 0.1 mg/kg, chlormequat 0.05 mg/kg, paraquat 0.02, mepiquat 0.05 mg/kg, daminozide 0.02 mg/kg and ethephon 0.05 mg/kg.² Consequently, the sensitivity achieved in these methods is far below what is required and therefore dilution of sample extracts is possible in order to reduce matrix effects.

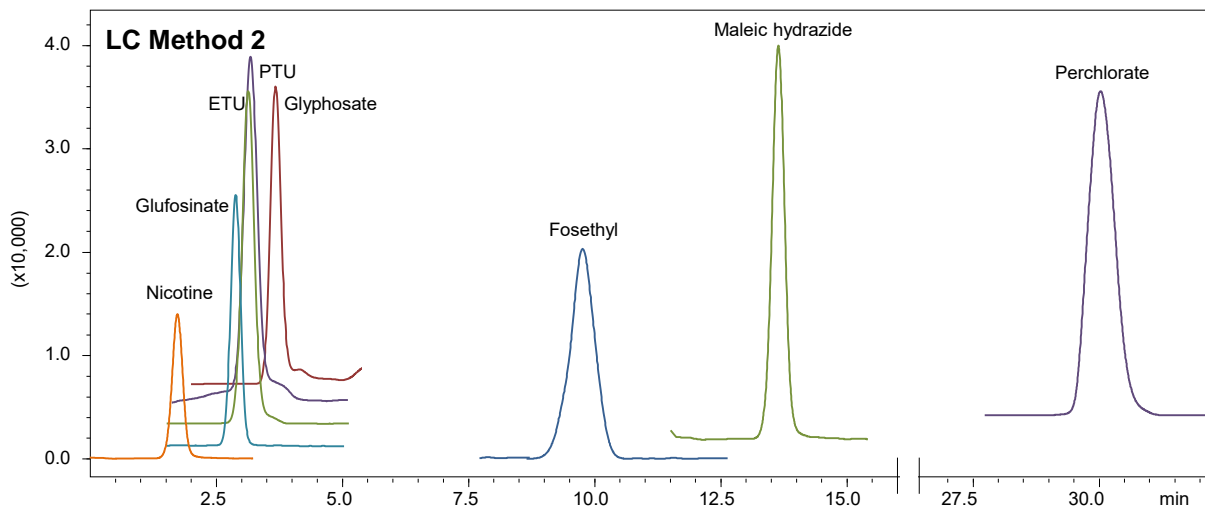

Figure 4. Target analytes at 0.05mg/kg in apple matrix using a Hypercarb PGC based separation (LC Method 2).

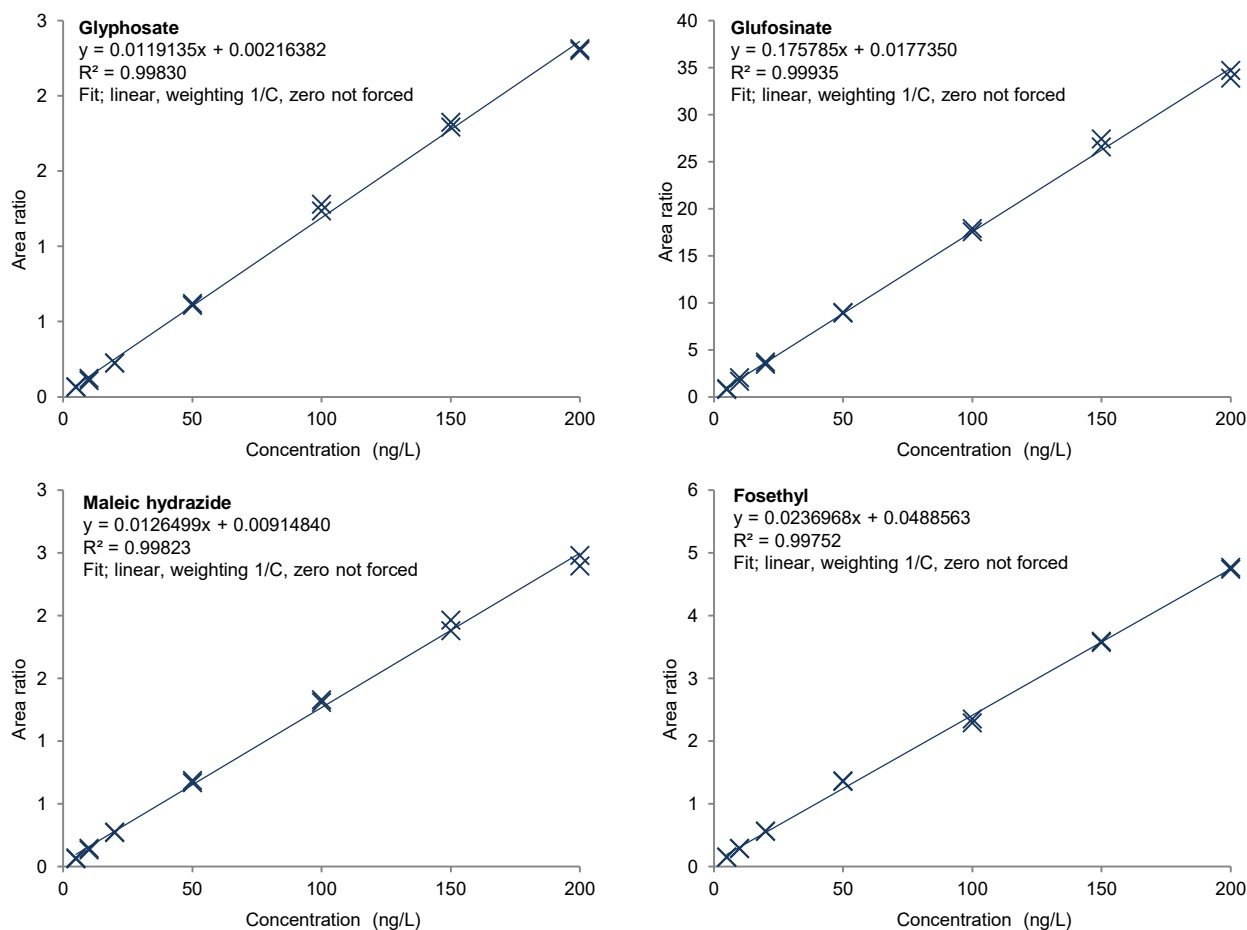

Figure 5. Calibration curves for glyphosate, glufosinate, maleic hydrazide and fosethyl using Hypercarb PGC based separation (LC Method 2)

■ Conclusion

Two LC-MS/MS methods were developed for the measurement of a range of highly polar pesticides in their underivited state using the LCMS-8050 triple quadrupole mass spectrometer. The developed multi-residue methods offer significant time savings in comparison to single residue methods typically used for analyse of these analytes. All compounds were quantified in the range 0.005 – 0.2 mg/kg with correlation coefficients greater than 0.997. The excellent sensitivity achieved, which is most cases is far below the EU MRL, offers the opportunity to dilute sample extracts prior to LC-MS/MS injection in order to reduce matrix effects.

■ References

1. Reference Laboratory for pesticides requiring Single Residue Methods (EURL-SRM). Quick Method for the Analysis of Residues of numerous Highly Polar Pesticides in Foods of Plant Origin involving Simultaneous Extraction with Methanol and LC-MS/MS Determination (QuPPE-Method). 2012. Version 7
2. Commission Regulation (EC). 2005. No 396/2005 of the European Parliament and of the Council, maximum residue levels of pesticides in or on food and feed of plant and animal origin. Official Journal of the European Union, L 70: 1-16. http://ec.europa.eu/sanco_pesticides/public/index.cfm?event=homepage&language=EN

Table 4. Target analytes linearity results using LC method 1 and LC method 2

Compound	R ²	Fit type	Weight	Method
Diquat	0.9986	Linear	1/C	Method 1
Chlormequat	0.9988	Linear	1/C	Method 1
Amitrole	0.9981	Quadratic	1/C	Method 1
Kasugamycine	0.9992	Linear	1/C	Method 1
Daminozide	0.9995	Quadratic	1/C	Method 1
Mepiquat	0.9993	Linear	1/C	Method 1
Paraquat	0.9995	Linear	1/C	Method 1
Trimesium	0.9981	Linear	1/C	Method 1
ETU	0.9998	Linear	1/C	Method 2
Fosethyl	0.9975	Linear	1/C	Method 2
Gluphosinate	0.9993	Linear	1/C	Method 2
Glyphosate	0.9983	Linear	1/C	Method 2
Maleic hydrazide	0.9982	Linear	1/C	Method 2
Nicotine	0.9984	Linear	1/C	Method 2
Perchlorate	0.9998	Linear	1/C	Method 2
PTU	0.9991	Linear	1/C	Method 2

Application News

No. C133

Liquid Chromatography Mass Spectrometry

Simultaneous Analysis of 16 Sweeteners Using Triple Quadrupole LC/MS/MS [LCMS-8050]

Artificial sweeteners such as aspartame, sucralose, and acesulfame potassium fall under the category of designated additives according to Japan's Food Sanitation Act, and prescribed standards are in place for their use in some foods and quantities.

Cyclamate and other artificial sweeteners used in some regions outside Japan are included among undesigned additives in Japan, and inspection is required in specific imported foods.

Consequently, quantitation for large numbers of sweeteners, including not only permitted in Japan but also undesigned, are needed.

Application News C121 described the simultaneous analysis of nine artificial sweeteners including both designated and undesigned additives using an LCMS-8040 triple quadrupole LC/MS/MS system. In this article, we introduce an example of simultaneous analysis of 16 sweeteners using an LCMS-8050.

Standard Mixture Analysis

MRM analysis was performed on 16 sweeteners using the analytical conditions shown in Table 1. Chromatograms of each compound near their lower limit of quantitation are shown in Fig. 1, with calibration curve ranges and correlation coefficients shown in Table 2. Results that met an accuracy of 100 % ±20 % and area repeatability (%RSD) of within 20 % were used for calibration point. Good linearity was obtained for all compounds, with correlation coefficients of 0.997 or higher.

Table 1 Analytical Conditions

Column	: Unison UK-C18 (150 mm L. × 3.0 mm I.D., 3.0 μm)	Injection Volume	: 1 μL
Mobile Phases	: A 5 mmol/L Ammonium formate - Water : B 5 mmol/L Ammonium formate - Methanol	Probe Voltage	: + 4.0 kV (ESI-positive mode) / -3.0 kV (ESI-negative mode)
Gradient	: B.Conc. 0 % (0.0-2.0 min) → 70 % (4.5 min) → 90 % (8.0-12.0 min) → 0 % (12.01-15.0 min)	Nebulizing Gas Flow	: 3 L/min
Flowrate	: 0.4 mL/min	Heating Gas Flow	: 10 L/min
Column Temperature	: 40 °C	Interface Temperature	: 300 °C
		DL Temperature	: 150 °C
		Block Heater Temperature	: 250 °C
		Drying Gas Flow	: 10 L/min

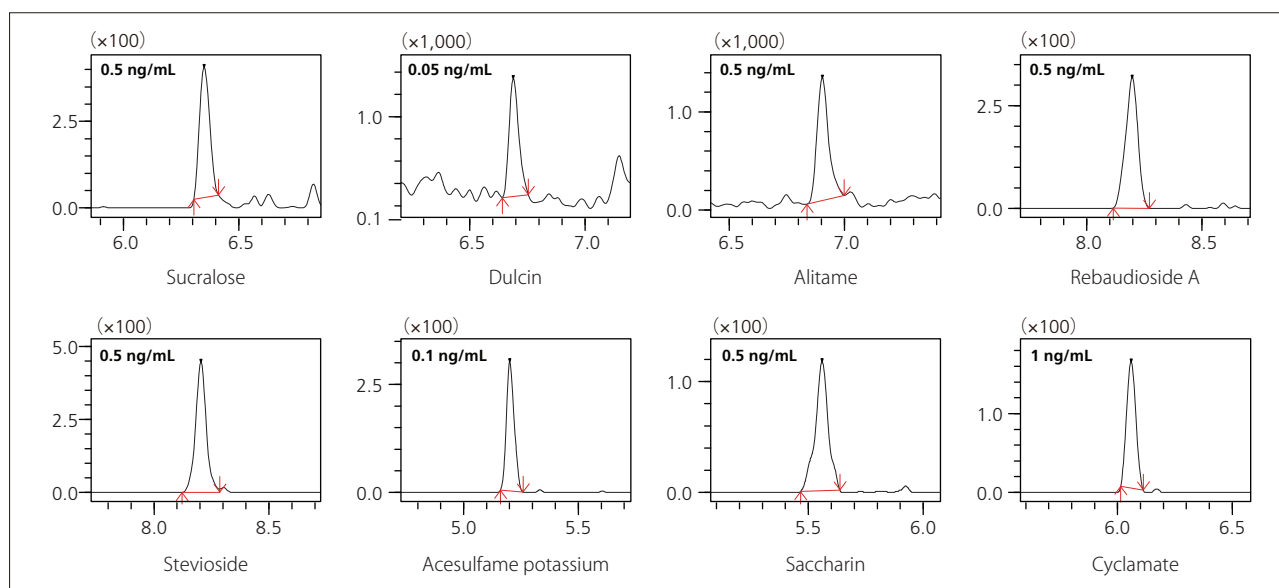

Fig. 1-1 Chromatograms of 16 Sweeteners

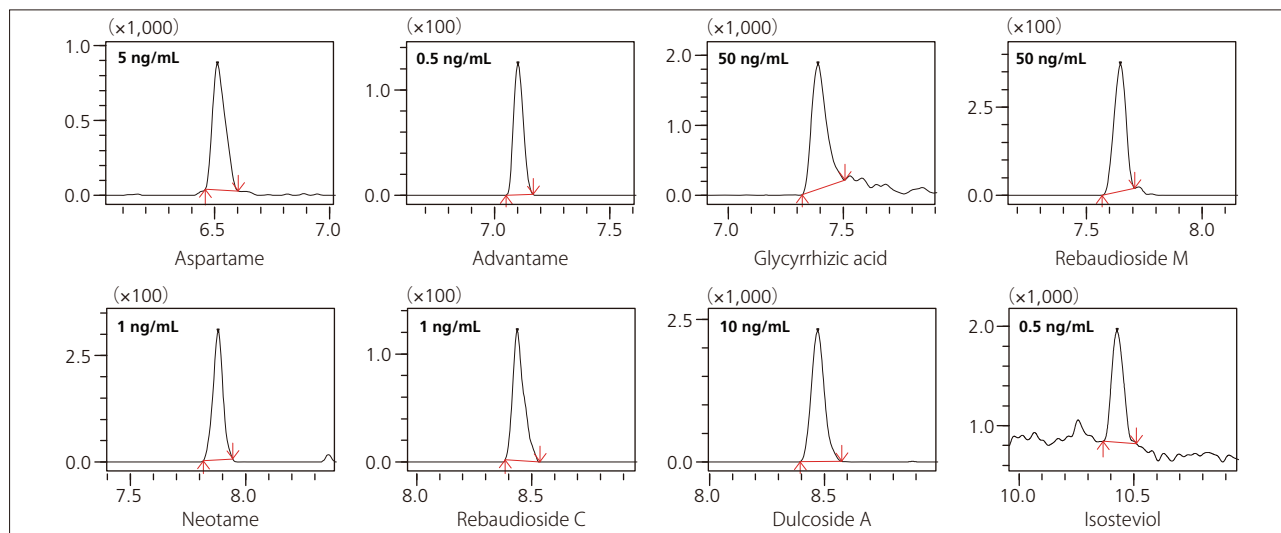

Fig. 1-2 Chromatograms of 16 Sweeteners (continued)

Table 2 Linearity of 16 Sweeteners

Compound Name	Polarity	Transition	Holding Time (min)	Calibration Curve Range (ng/mL)	Correlation Coefficient
Sucralose	+	414.00>199.10	6.36	0.5 - 100	0.999
Dulcin	+	181.20>108.10	6.70	0.05 - 10	0.999
Alitame	+	332.20>129.00	6.92	0.5 - 100	0.999
Rebaudioside A	+	984.50>325.10	8.21	0.5 - 100	0.999
Stevioside	+	822.00>319.30	8.23	0.5 - 100	0.999
Acesulfame potassium	-	161.90>82.00	5.23	0.1 - 10	0.999
Saccharin	-	181.90>42.00	5.58	0.5 - 50	0.997
Cyclamate	-	178.00>80.00	6.08	1 - 100	0.999
Aspartame	-	293.40>261.10	6.53	5 - 100	0.999
Advantame	-	457.30>200.30	7.12	0.5 - 100	0.999
Glycyrrhizic acid	-	821.20>351.10	7.41	50 - 1000	0.999
Rebaudioside M	-	1289.60>802.90	7.66	50 - 1000	0.999
Neotame	-	377.30>200.00	7.90	1 - 100	0.999
Rebaudioside C	-	949.50>787.20	8.46	1 - 100	0.999
Dulcoside A	-	787.50>625.20	8.50	10 - 1000	0.999
Isosteviol	-	317.30>317.30	10.46	0.5 - 1000	0.999

Recovery from Real World Samples

Sweeteners were added to sample solutions prepared according to the procedure shown in Fig. 2, and recovery of these additives was verified by measuring the samples after 100-fold or 1000-fold dilution. The results are shown in Table 3.

Dialysis and solid phase extraction are common methods used in sample pretreatment for sweetener analysis, but these operations have the drawback of being complex, time-consuming, and laborious. Pretreatment by solvent extraction requires no special equipment, and can be performed quickly and simply.

Table 3 Recovery

Compound Name	Additive Concentration	Real World Sample	Dilution Ratio	Recovery (%)
Glycyrrhizic acid	100 µg/mL	Soy sauce	100	85.20
Acesulfame potassium	10 µg/mL	Powdered soft drink	1000	81.21
Aspartame	10 µg/mL	(café au lait)		104.2
Neotame	10 µg/mL	Ketchup	100	108.5

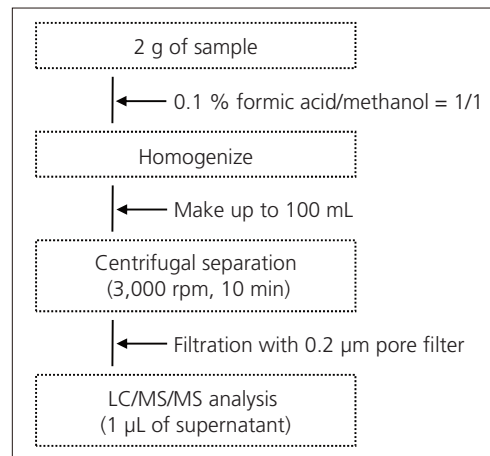

Fig. 2 Pretreatment Workflow

This Application News was prepared with the cooperation of Japan Food Research Laboratories, who provided samples and guidance.

First Edition: Aug. 2016



For Research Use Only. Not for use in diagnostic procedure.

This publication may contain references to products that are not available in your country. Please contact us to check the availability of these products in your country.

The content of this publication shall not be reproduced, altered or sold for any commercial purpose without the written approval of Shimadzu. Company names, product/service names and logos used in this publication are trademarks and trade names of Shimadzu Corporation or its affiliates, whether or not they are used with trademark symbol "TM" or "®". Third-party trademarks and trade names may be used in this publication to refer to either the entities or their products/services. Shimadzu disclaims any proprietary interest in trademarks and trade names other than its own.

The information contained herein is provided to you "as is" without warranty of any kind including without limitation warranties as to its accuracy or completeness. Shimadzu does not assume any responsibility or liability for any damage, whether direct or indirect, relating to the use of this publication. This publication is based upon the information available to Shimadzu on or before the date of publication, and subject to change without notice.

Shimadzu Corporation

www.shimadzu.com/an/

Application News

No. C121

Liquid Chromatography Mass Spectrometry

Simultaneous Analysis of Nine Sweeteners Using Triple Quadrupole LC/MS/MS (LCMS-8040)

Artificial sweeteners such as saccharin sodium, aspartame, sucralose and acesulfame potassium fall under the category of specified additives in Japan's Food Sanitation Act, for which each specified criteria exist for their use in terms of eligible foods and amounts used.

Cyclamate, an artificial sweetener used in some regions of the world outside Japan, is an unspecified additive within Japan, for which inspection is required on specific imported foods.

In light of these situations, there is a demand for analyses of various different sweeteners, not only the quantitative testing of permitted sweeteners but also the testing of unspecified sweetener additives.

This article presents a simultaneous analysis of nine sweeteners including both specified additives and unspecified additives, using the LCMS-8040 high-performance liquid chromatograph-triple quadrupole mass spectrometer.

■ Analysis of a Standard Mixture

Fig. 1 shows chromatograms measured from a 5 μ L injected sample of a 10 ng/mL standard mixture of nine sweeteners, analyzed with the analytical conditions shown in Table 1. Chromatograms at around the lower limit of quantitation (LLOQ) are shown in Fig. 2. The retention time, calibration curve range, and correlation coefficient for each compound are shown in Table 2. A calibration point accuracy of within 100 ± 20 % and a percentage of area repeatability (%RSD) of within 20 % were employed. Good linearity was obtained for all compounds with a correlation coefficient of 0.997 or higher.

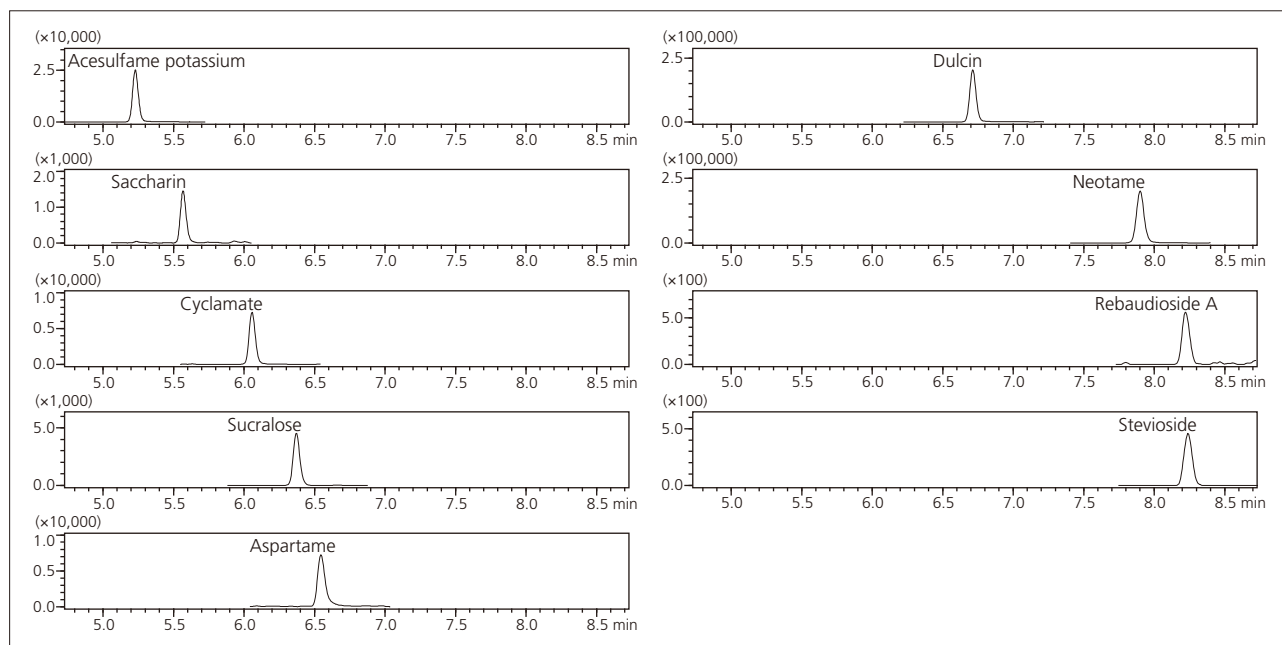

Fig. 1 Chromatograms from a 10 ng/mL Standard Mixture of Nine Sweeteners

Table 1 Analytical Conditions

Column	: Unison UK-C18 (150 mm L. \times 3.0 mm I.D., 3.0 μ m)
Mobile Phases	: A 5 mmol/L Ammonium Formate - Water : B Methanol
Gradient	: B Conc. 0 % (0.0 - 2.0 min) \rightarrow 70 % (4.5 min) \rightarrow 90 % (8.0 - 12.0 min) \rightarrow 0 % (12.01-15.0 min)
Flowrate	: 0.2 mL/min
Column Temperature	: 40 $^{\circ}$ C
Injection Volume	: 5 μ L
Probe Voltage	: + 4.5 kV (ESI-positive mode) / -3.5 kV (ESI-negative mode)
DL Temperature	: 300 $^{\circ}$ C
Block Heater Temperature	: 500 $^{\circ}$ C
Nebulizing Gas Flow	: 3 L/min
Drying Gas Flow	: 15 L/min

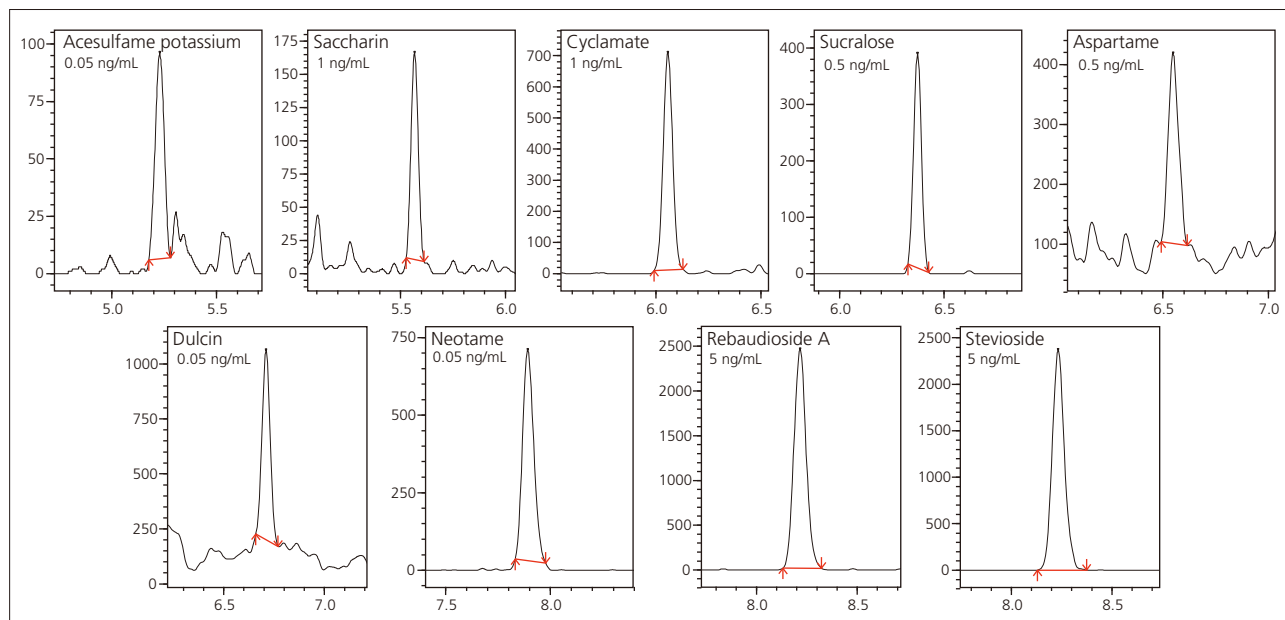

Fig. 2 Chromatograms of Nine Sweeteners at Around LLOQ

Table 2 Linearity of Nine Sweeteners

Compound Name	Polarity	Transition	Retention Time (min)	Calibration Curve Range (ng/mL)	Correlation Coefficient
Acesulfame potassium	-	162.00 > 82.10	5.228	0.05 – 100	0.997
Saccharin	-	182.00 > 42.00	5.561	1 – 100	0.999
Cyclamate	-	178.00 > 80.00	6.057	1 – 100	0.998
Sucralose	+	413.90 > 199.00	6.370	0.5 – 500	0.999
Aspartame	-	293.10 > 261.10	6.543	0.5 – 1000	0.999
Dulcin	+	181.20 > 108.10	6.712	0.05 – 10	0.999
Neotame	+	379.10 > 172.20	7.898	0.05 – 1000	0.999
Rebaudioside A	-	965.30 > 803.40	8.220	5 – 1000	0.999
Stevioside	+	822.30 > 319.20	8.238	5 – 1000	0.999

Recovery from Actual Samples

Seven sweeteners were added to foods (curry paste, rice cake flavored with mugwort, and sponge cake) pretreated by dialysis (Fig. 3), and the matrix effect was evaluated. The recovery of each added sweetener is shown in Table 3. Dulcin was the only sweetener for

which the recovery was calculated based on a 1000-fold dilution of the solution after dialysis treatment, while the recovery of all other sweetener samples was calculated based on 100-fold dilution. The recovery was good with all samples, ranging from 85 to 125 %.

Table 3 Recovery of Seven Added Sweeteners

Compound Name	Added Concentration	Recovery (%)		
		Curry Paste	Rice Cake Flavored with Mugwort	Chocolate Sponge Cake
Acesulfame potassium	5 µg/mL	100.8	94.2	93.7
Saccharin		97.0	87.7	88.3
Cyclamate		99.6	89.3	92.0
Sucralose		96.2	89.6	82.6
Aspartame		94.0	89.4	87.2
Dulcin		110.2	99.5	99.5
Neotame		122.5	106.9	110.0

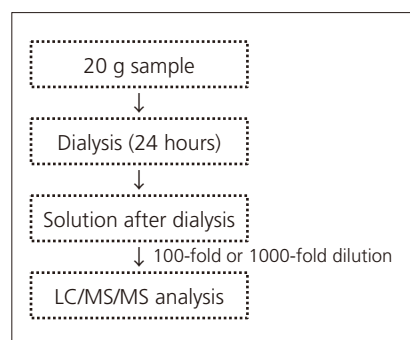

Fig. 3 Workflow of Pretreatment

This Application News was prepared with the cooperation of Tokyo Food Sanitation Association, who provided samples and guidance.

Determination of Avermectin Drug Residues in Vinegar Using LCMS-8045

Song Lun
Shimadzu (China), Shanghai Analysis Center

Application News
SSL-CA14-351

Abstract

This application news describes a method developed for determination of avermectin drug residues in vinegar using Shimadzu's ultra-high performance liquid chromatograph (UHPLC) LC-30A coupled with triple quadrupole mass spectrometer LCMS-8045. The analysis was completed within 6 minutes and the external standard quantification showed good linearity with a correlation coefficient above 0.997. Samples of low, medium and high concentrations were tested in 6 replicates. The relative standard deviations of retention time and peak area were 0.02 to 0.09% and 0.66 to 4.57%, respectively, showing good precision. The limit of detection and limit of quantitation of four avermectin drugs ranged from 0.22 to 0.25 ng/mL and 0.75 to 0.83 ng/mL respectively.

The main varieties of avermectin drugs include avermectin, eprinomectin, doramectin, and ivermectin. Due to their excellent insect repellent properties, these drugs are widely used as anti-parasitic drugs. Although avermectin drugs are pesticides derived from microorganisms, their LD₅₀ in rats is 10 mg/kg, which is similar to that of thiophos pesticides. Therefore, the World Health Organization lists avermectin drugs as highly toxic compounds. The main methods currently used for detection of avermectin drugs include liquid chromatography-ultraviolet detection, liquid chromatography-fluorescence detection, and enzyme-linked immunosorbent assay (ELISA).

In recent years, many reports have used high performance liquid chromatography-tandem mass spectrometry assays in detection of avermectin drug residues. Both ESI and APCI ion sources can be used for LC-MS/MS analysis of avermectin drugs. The limit of detection of four avermectin drugs, avermectin, eprinomectin, doramectin, and ivermectin, specified in China's national standard GB/T 21320-2008 "Determination of Avermectin Residues in Animal-Derived Food Using Liquid Chromatography-Tandem Mass Spectrometry" is 1.5 µg/kg with an ESI source. In the People's Republic of China's entry and exit inspection and quarantine industry standard, SN/T 1973-2007 "Detection of Avermectin Residues in Import and Export Food Using

High Performance Liquid Chromatography-Mass Spectrometry/Mass Spectrometry", the limit of detection of avermectin is 5 µg/kg with an APCI source. When the positive ion scanning mode of ESI is used for analysis, precursor ions of avermectin drugs are more likely to be detected in the form of [M+Na]⁺ ions. However, if the sodium content in extraction matrix is low or if only a trace amount of sodium ions is present in the extraction liquid due to the selected extraction method, a poor linear relationship tends to be observed when the detection is carried out in the form of [M+Na]⁺ ions. For this reason, some literature has suggested using the negative ion mode of APCI to detect the precursor ion [M-H]⁻ to acquire a better linear relationship. Shimadzu China has already published an application report (report No.: AP_News_LCMSMS-050) for LC-MS/MS analysis of avermectin drugs using the ESI source.

In this article, in reference to SN/T 1973-2007 and GB/T 21320-2008, Shimadzu's UHPLC LC-30A coupled with the Triple Quadrupole Mass Spectrometer LCMS-8045 and an APCI source was used to establish a highly sensitive and rapid method for detection of avermectin drug residues in vinegar. The results were superior to the requirements of the above standards and can be used as a reference method by relevant personnel.

EXPERIMENTAL

Instrumentation

The experiment employed Shimadzu's ultra-high performance liquid chromatograph (UHPLC) LC-30A and triple quadrupole mass spectrometer LCMS-8045. The configurations are two LC-30AD pumps, DGU-20A₅ online degassing unit, SIL-30AC autosampler, CTO-30A column oven, CBM-20A system controller, LCMS-8045 triple quadrupole mass spectrometer and LabSolutions Ver. 5.86 chromatography workstation.

Analytical Conditions

Liquid Chromatography (LC) Conditions

Column	: Shim-pack XR-ODS (3.0 mm I.D.x75 mm L., 2.2 μm)
Mobile phase	: Solvent A - 5 mM ammonium acetate in water Solvent B - methanol
Flow rate	: 1.20 mL/min
Column Temp.	: 40 °C
Injection volume	: 20 μL
Elution method	: Gradient elution with initial concentration of mobile phase B at 75%. Refer to Table 1 for time program.

Table 1 Time program

Time (min)	Module	Command	Value (%)
3.00	Pumps	Pump B Conc.	100
4.40	Pumps	Pump B Conc.	100
4.50	Pumps	Pump B Conc.	75
6.00	Controller	Stop	

Mass Spectrometry (MS) Conditions

Analytical Instrument	: LCMS-8045
Ionization mode	: APCI(-)
Ionization Voltage	: -4.5 kV
Nebulizer gas	: Nitrogen 3.0 L/min
Drying gas	: Nitrogen 6.0 L/min
Collision gas	: Argon
Probe temp.	: 350 °C
DL temp.	: 100 °C
Block Heater temp.	: 200 °C
Mode	: Multiple reaction monitoring (MRM)
Dwell time	: 40 ms
Pause time	: 3 ms
MRM transitions	: Refer to Table 2

Standard Solution Preparation

Mixed standard stock solution at a concentration of 1 mg/mL was prepared using acetonitrile and was subsequently diluted with acetonitrile to make a series of standard working solutions at concentrations of 1, 2, 5, 10, 20, 50, 100, 200, and 400 mg/mL.

Sample Preparation Method

Sample was prepared in accordance to the industry standard SN/T 1973-2007 "Detection of Avermectin Residues in Import and Export Food Using High Performance Liquid Chromatography-Mass Spectrometry/Mass Spectrometry".

Table 2 MRM transition

No.	Analyte	Precursor Ion	Product Ion	Q1 Pre Bias (V)	CE (V)	Q3 Pre Bias (V)
1	Avermectin	871.35	565.25*	32.0	21.0	18.0
			229.20	46.0	40.0	50.0
2	Eprinomectin	912.35	565.35*	20.0	29.0	18.0
			270.20	46.0	42.0	50.0
3	Doramectin	897.35	591.35*	16.0	28.0	18.0
			229.20	44.0	43.0	46.0
4	Ivermectin	873.35	567.30*	16.0	28.0	10.0
			229.15	44.0	40.0	50.0

RESULTS AND DISCUSSION

Q1 MS scan and Product Ion Scan of Standard Sample

The Q1 MS scan and product ion scan of the avermectin drugs are shown in Figures 1-4.

MRM Chromatogram of Standard Mixture

The MRM chromatograms of standard samples of the four avermectin drugs are shown in Figure 5.

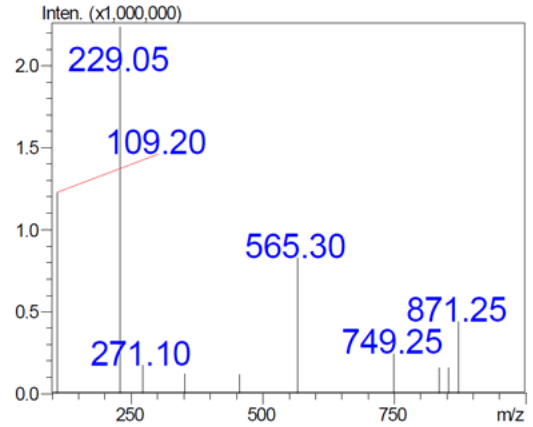
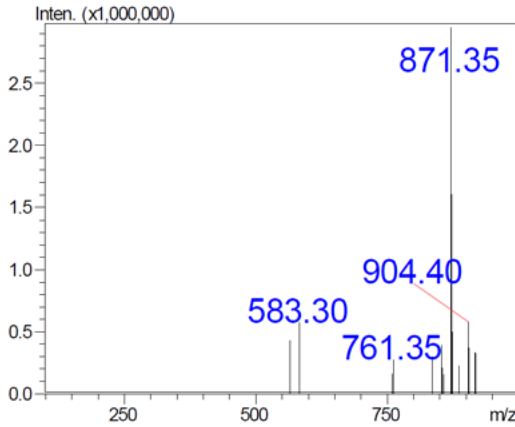

Figure 1 Q1 MS scan (left) and product ion scan (right, CE value is 40V) of avermectin

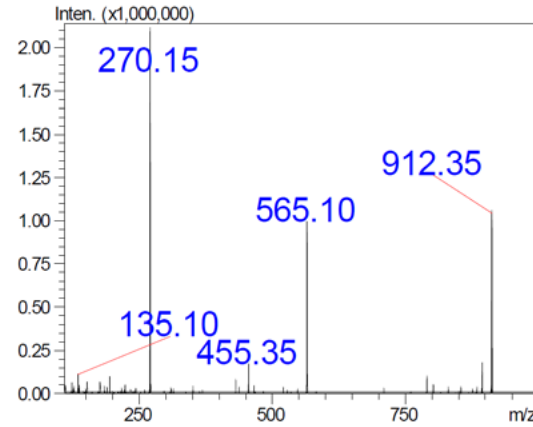
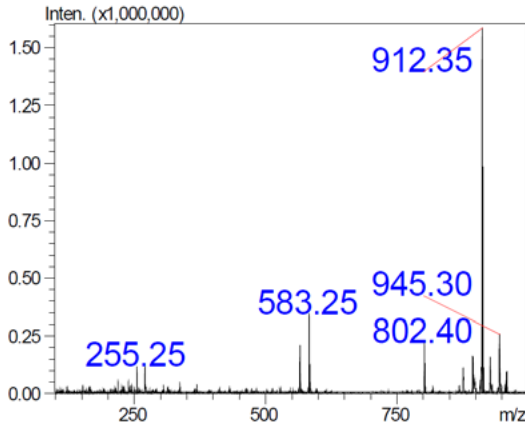

Figure 2 Q1 MS scan (left) and product ion scan (right, CE value is 40V) of eprinomectin

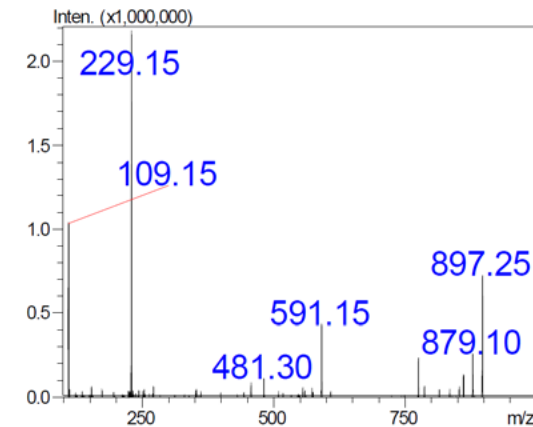
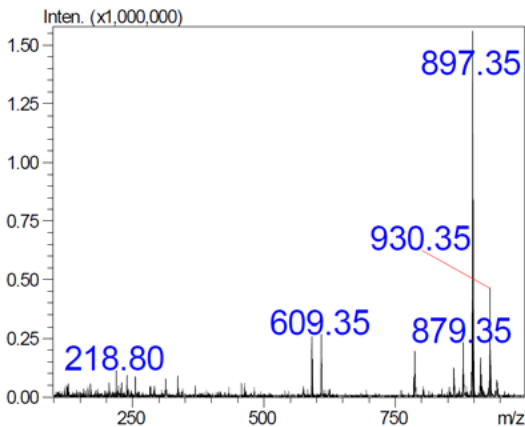

Figure 3 Q1 MS scan (left) and product ion scan (right, CE value is 40V) of doramectin

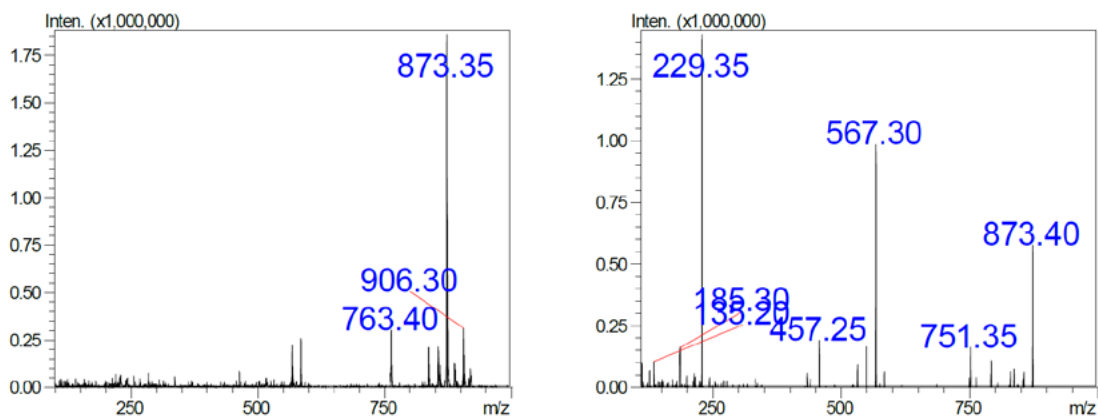

Figure 4 Q1 MS scan (left) and product ion scan (right, CE value is 40V) of ivermectin

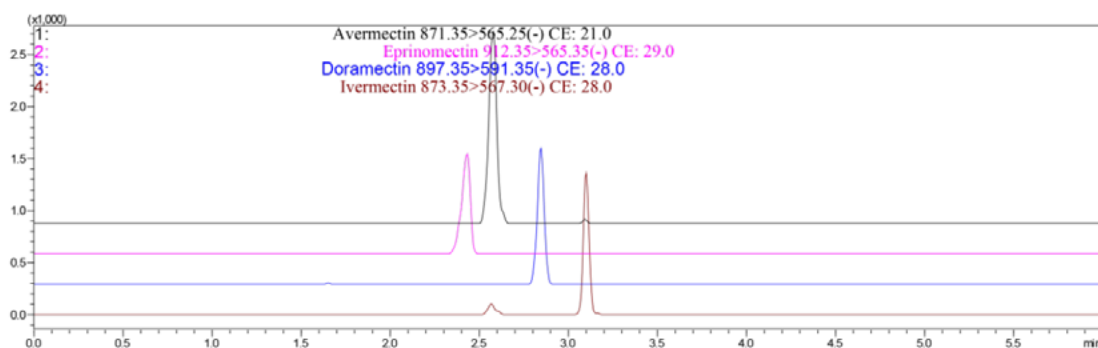

Figure 5 MRM chromatograms of 1 ng/mL standard samples of the four avermectin drugs

Calibration and Linear Range

A series of standard solutions at concentrations of 1, 2, 5, 10, 20, 50, 100, 200, and 400 ng/mL were injected and analyzed based on conditions listed in the previous section. Calibration curves were established by the external standard method and the results are shown in Figures 6-9. The four avermectin drugs showed good linearity within the range of 1 to 400 ng/mL. Linear equation, linear range, and correlation coefficients are shown in Table 3.

Limit of Detection and Limit of Quantitation

Sample solutions at a concentration of 1.0 ng/mL were injected and analyzed. A value equivalent to 3 times the noise

was used as the lower limit of detection (i.e., $S/N = 3$, LOD), while the lower limit of quantitation was 10 times the noise (i.e., $S/N=10$, LOQ). Lower LOD and lower LOQ for the four avermectin drugs are shown in Table 4.

Table 4 Limit of detection and limit of quantitation

Analyte	Limit of Detection (ng/mL)	Limit of Quantification (ng/mL)
Avermectin	0.23	0.77
Eprinomectin	0.25	0.83
Doramectin	0.23	0.76
Ivermectin	0.22	0.77

Table 3 Parameters for calibration curves of 4 avermectin drugs (weight coefficient: $1/C^2$)

Compound	Calibration Curve	Linear Range (ng/mL)	Accuracy (%)	Correlation Coefficient (r)
Avermectin	$Y = (6631.81) X + (-448.237)$	1.00~400.00	0.9977	90.9~107.4
Eprinomectin	$Y = (4314.94) X + (-2460.15)$	1.00~400.00	0.9974	92.0~111.9
Doramectin	$Y = (4740.90) X + (-850.905)$	1.00~400.00	0.9986	91.5~105.4
Ivermectin	$Y = (5160.71) X + (-1877.62)$	1.00~400.00	0.9975	87.1~109.0

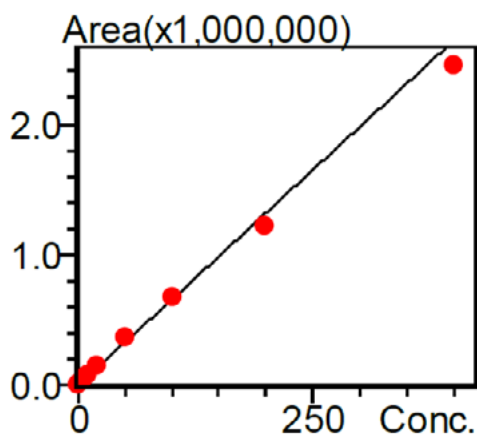

Figure 6 The standard calibration curve of avermectin

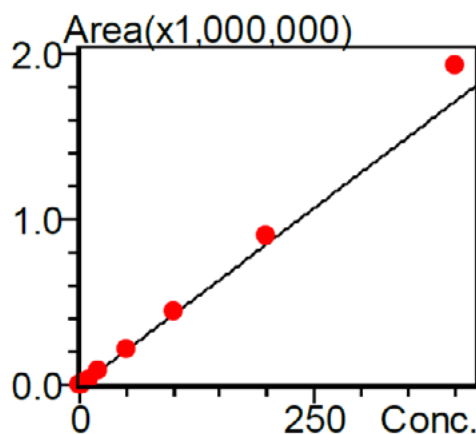

Figure 7 The standard calibration curve of eprinomectin

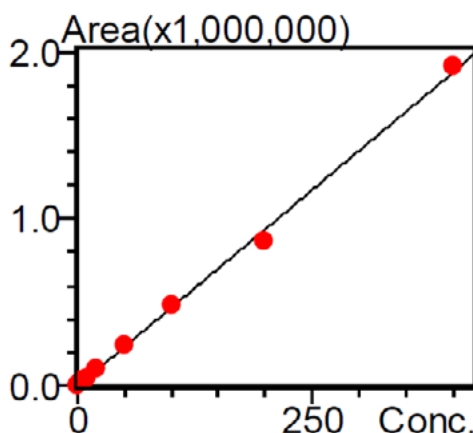

Figure 8 The standard calibration curve of doramectin

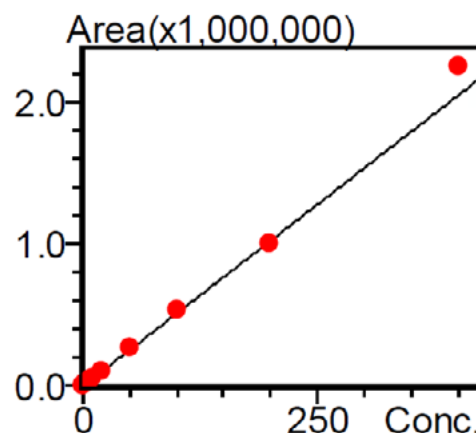

Figure 9 The standard calibration curve of ivermectin

Precision Test

After the mixed standard solutions at concentrations of 10 ng/mL, 100 ng/mL, and 200 ng/mL were analyzed by six consecutive injections, the relative standard deviations of retention time and peak area for the standards at three concentrations were 0.02 to 0.09% and 0.66 to 4.57%, respectively, indicating good precision.

Matrix Effects

Standard mixtures and spiked sample solution were prepared at low, medium

and high concentrations. The matrix effects were assessed by comparing the peak area of the spiked sample solution with that of standard solution at the same concentration. If the obtained results of matrix effects are between 80% and 120%, the matrix effects showed minimal interference on detection of target substances. The experimental results are shown in Table 6. As seen from Table 6, the matrix effects showed minimal interference on detection of target substances.

Table 5 Repeatability results of retention time and peak area (n=6)

Analyte	RSD% (10 ng/mL)		RSD% (100 ng/mL)		RSD% (200 ng/mL)	
	R.T.	Area	R.T.	Area	R.T.	Area
Avermectin	0.03	2.79	0.02	3.18	0.02	0.66
Eprinomectin	0.09	4.57	0.02	1.31	0.05	1.30
Doramectin	0.05	3.76	0.02	2.68	0.02	1.30
Ivermectin	0.03	2.55	0.02	2.92	0.02	0.92

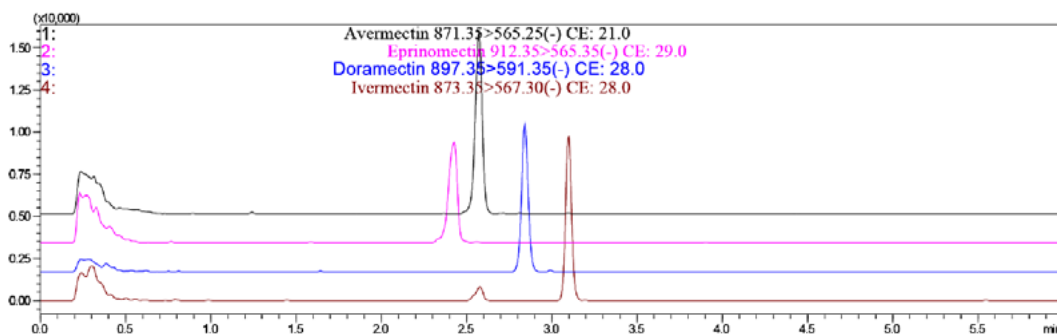

Figure 10 MRM chromatogram of blank vinegar matrix

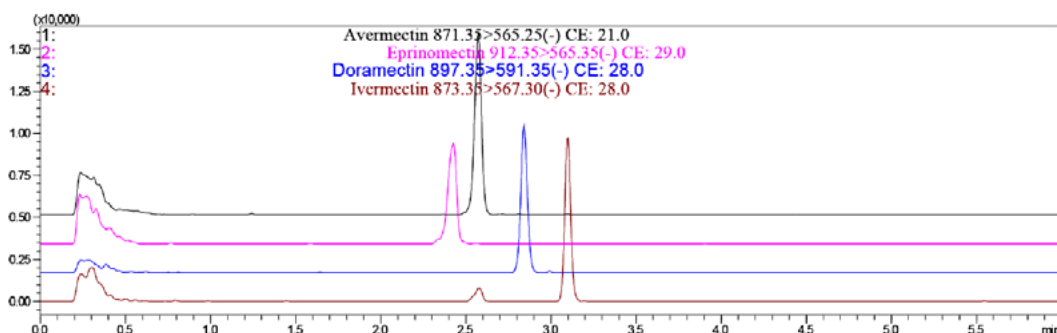

Figure 11 MRM chromatogram of vinegar matrix spike solution (5 ng/mL)

Table 6 Matrix effects

Spiking Concentration (ng/mL)	Avermectin (%)	Eprinomectin (%)	Doramectin (%)	Ivermectin (%)
10	103.8	105.7	117.1	109.7
100	84.5	91.7	101.1	90.6
200	94.7	82.0	118.4	100.4

Matrix Recovery Test

Mixed standards were first added to the blank vinegar samples. The pre-spiked samples were treated according to the method described previously, to give concentrations of pre-spiked samples of 10, 100, and 200 ng/mL.

For the preparation of the post-spiked samples, the blank vinegar sample matrix was first prepared according to the method described in the previous section. Mixed standards were then subsequently

added into the blank vinegar matrix, so that the concentrations of post-spiked samples were 10, 100, and 200 ng/mL.

Both pre-spiked and post-spiked samples were injected and analyzed. The recovery was then calculated as the ratio between the peak area of pre-spiked samples and the peak area of post-spiked samples. The recovery rates obtained at various concentrations are shown in Table 7.

Table 7 Recovery rate

Theoretical Concentration of Sample (ng/mL)	Avermectin (%)	Eprinomectin (%)	Doramectin (%)	Ivermectin (%)
10	77.5	74.3	78.0	71.9
100	81.2	72.8	80.4	75.3
200	88.0	76.4	78.0	77.4

CONCLUSION

This application news demonstrates a method for determination of avermectin drug residues in vinegar using Shimadzu's UHPLC LC-30A coupled with triple quadrupole mass spectrometer LCMS-8045. When quantified by the external standard method, the calibration curves of the method showed adequate linearity with correlation coefficients all above 0.997. Samples of low, medium and high concentrations were tested in 6 replicates. The relative standard deviations of

retention time and peak area were 0.02 to 0.09% and 0.66 to 4.57% respectively, showing good precision. The limit of detection and limit of quantitation ranged from 0.22 to 0.25 ng/mL and 0.75 to 0.83 ng/mL respectively, thus complying with the current requirements for detection of avermectin drug residues in food. This method can provide a reference for relevant personnel in carrying out the detection of avermectin drug residues in food.

A sensitive and repeatable method for characterization of sulfonamides and trimethoprim in honey using QuEChERS extracts with Liquid-Chromatography-Tandem Mass Spectrometry

ASMS 2015 WP 057

Hernando Escobar¹; Jeffrey H.Dahl¹; Eddie Medina¹;
Christopher T. Gilles¹.

¹Shimadzu Scientific Instruments., Columbia, MD

A sensitive and repeatable method for characterization of sulfonamides and trimethoprim in honey using QuEChERS extracts with Liquid-Chromatography-Tandem Mass Spectrometry

Introduction

The antibacterial sulfonamides (SA) and trimethoprim are widely used in veterinary and human medicine. Diverse foods from animals potentially contain residues of these drugs posing possible threats to people by triggering allergic reactions and undesirable increasing of microorganism's drug resistance. Various countries have defined their own maximum residue limits (MRLs) for sulfonamides accepted in honey, There are no MRL's for sulfonamides in honey in the UE but in 2002 a minimum

required performance level (MRPL) was set for analytical methods at a level of 10 µg/kg. HPLC-MS/MS is an effective strategy to characterize and accurately measure those antibiotics considering MRLs and MRPLs in food products from animal origin tend to be continually reduced to preserve human health safety. A selective, fast and sensitive HPLC-MS-MS method has been developed for 15 sulfonamides and trimethoprim.

Materials and Method

Sample preparation

5 grams of honey, spiked with 17 SAs and trimethoprim (Table 1A), were extracted using QuEChERS method following manufacturer's procedure with a final 1:5 extract dilution using methanol. A multiple reaction monitoring MRM method was optimized for quantitation for each sulfonamide compound using a Shimadzu Nexera UHPLC with an LCMS-8050 fast-scanning triple quadrupole mass spectrometer model equipped with

software Labsolution LCMS version 5.65 and electrospray ionization ESI.

Stock standard solutions of each sulfonamide were prepared dissolving appropriate amounts in DMSO and methanol, diluting to 100 ppm and 1 ppm at the end with mobile phase A:B 50:50. Table 1B shows the concentrations at each level used to build calibration curves for external calibration method.

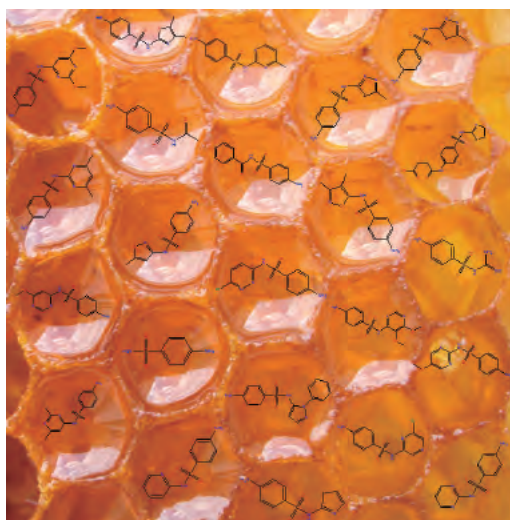

LC conditions

A Kinetex 2.6µ PFP 100 Å column (100 × 2.1 mm) was used at 40 °C, flow rate of 0.5 mL/min, and 10 µL injection volume using QuEChERS extraction method. A binary gradient of 10% methanol (mobile phase A) and methanol, 0.3% formic Acid (mobile phase B) was used with the gradient program described in Table 1C.

A sensitive and repeatable method for characterization of sulfonamides and trimethoprim in honey using QuEChERS extracts with Liquid-Chromatography-Tandem Mass Spectrometry

Mass Spectrometry:

Electrospray ionization was used in positive mode, spray voltage was 4.5 kV, desolvation line temperature was 250 °C, nebulization gas was 2.0 L/min, heater block was 400 °C, and drying gas 15 L/min.

Table 1. A. Sulfonamide compounds used in this study; B. Concentration levels to define calibration curves, and C. HPLC gradient used.

A. Sulfonamides used				B. Calibration Curve		C. LC Gradient	
#	SULFONAMIDE	#	SULFONAMIDE	Level	Conc. (ng/ml)	Time (min)	%B
1	Sulfaguanidine	10	Sulfamethoxypyridazine	1	1000	0	5
2	Sulfacetamide	11	Succinylsulfathiazole	2	500	1	15
3	Sulfadiazine	12	Sulfamethoxazole	3	250	4.5	35
4	Sulfathiazole	13	Trimethoprim	4	125	5	60
5	Sulfapyridine	14	Sulfamonomethoxine	5	62.5	5.01	95
6	Sulfamerazine	15	Sulfisoxazole	6	31.3	5.5	95
7	Sulfamethazine	16	Sulfabenzamide	7	15.6	5.51	5
8	Sulfameter	17	Sulfacozine	8	7.8	7	5
9	Sulfamethizole	18	Sulfadimethoxine	9	3.9		
				10	2		
				11	1		

To implement sulfonamide quantitation, MRM transitions were optimized using a 0.5 µg mixture of SAs, 1 µL injections at 400 µL/min. Three transitions from parent ions and fragments were selected using the optimization tool software.

Results

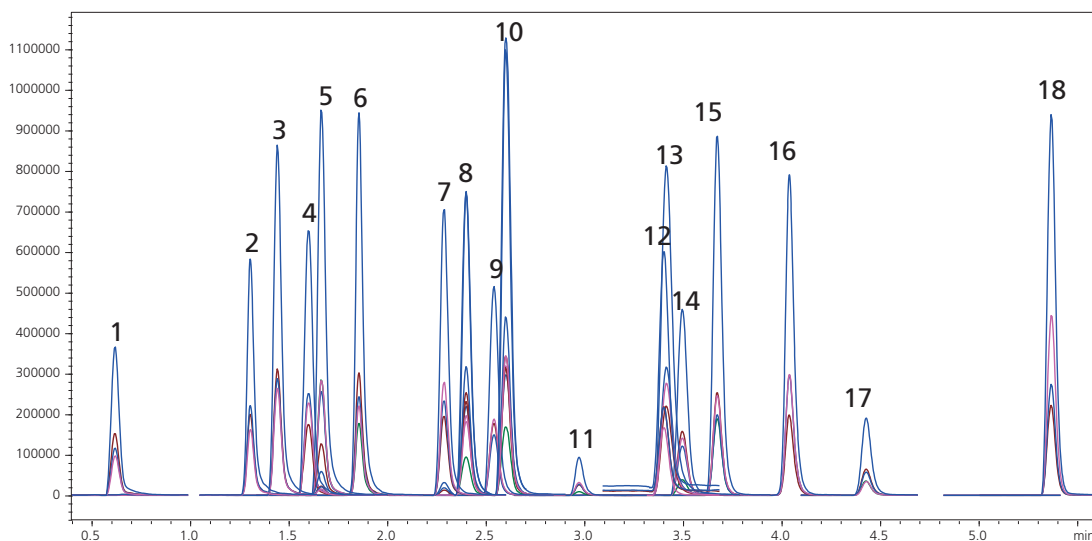

Figure 1. Representative chromatogram of sulfonamide drugs. Standard mixture at 125 pg on-column for each standard. Peak numbers follow the order described for SA compounds in table 1A.

A sensitive and repeatable method for characterization of sulfonamides and trimethoprim in honey using QuEChERS extracts with Liquid-Chromatography-Tandem Mass Spectrometry

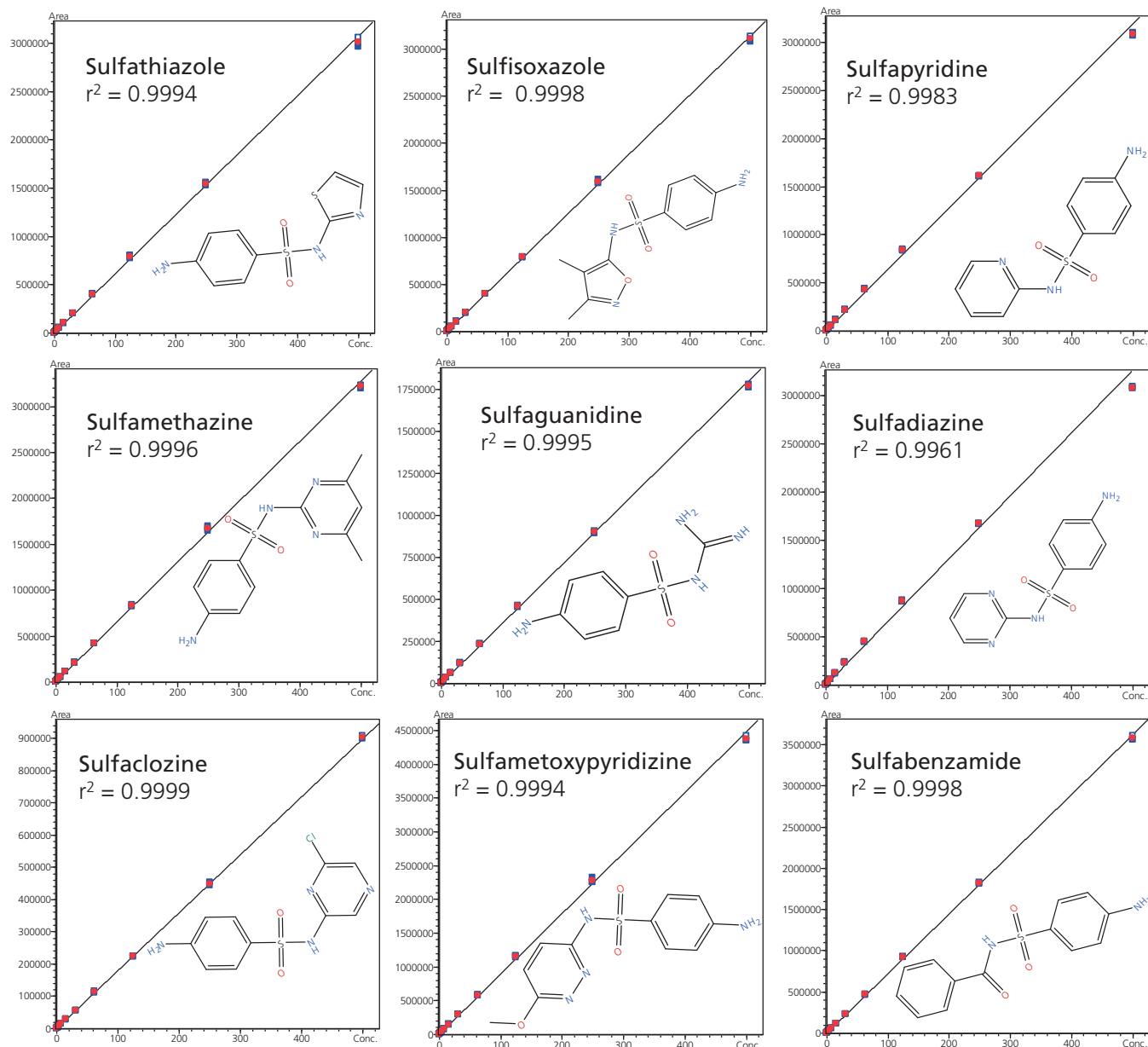
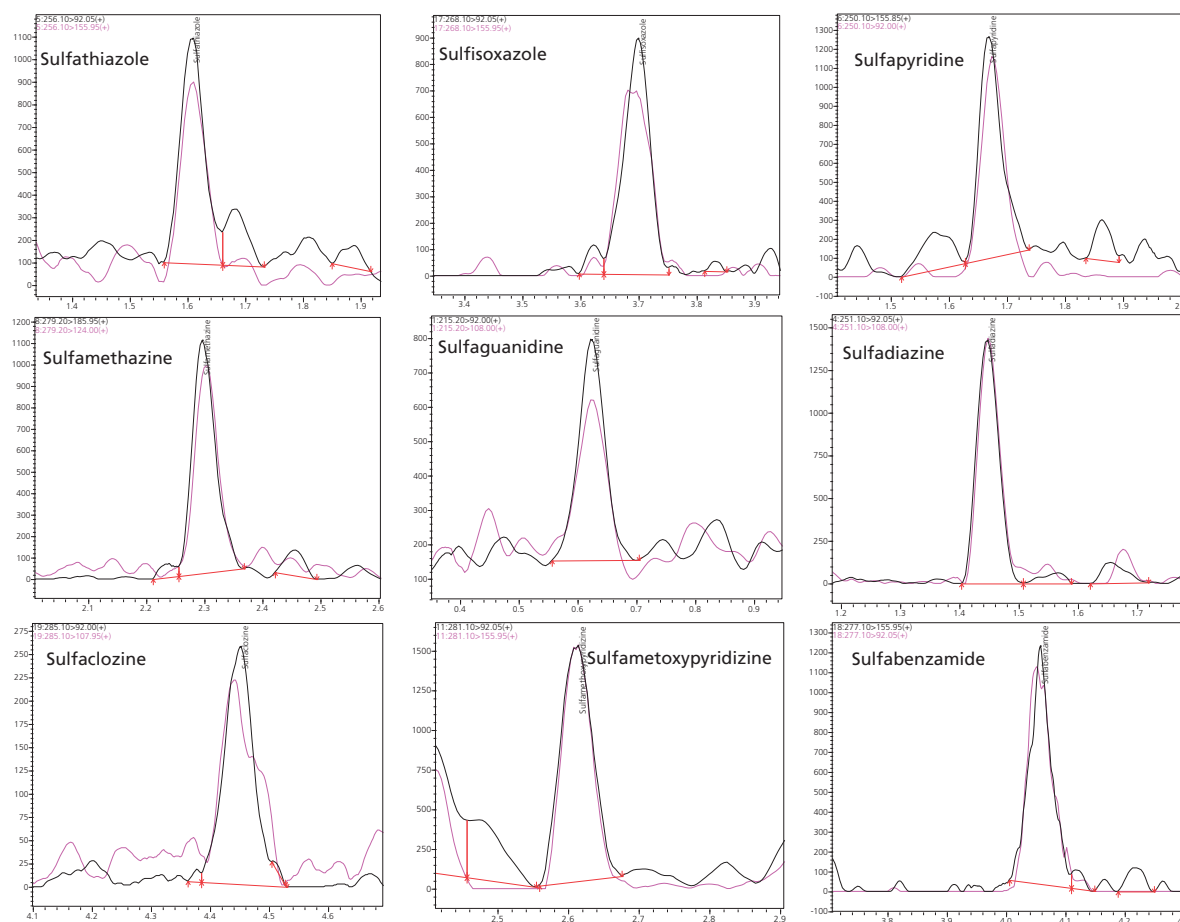

Figure 2. High degree of linearity was observed over the concentration range 0.5–500 pg on column, with values of $r^2 \geq 0.990$ for all analytes.

Authentic SAs standards were fully characterized by HPLC and MS/MS with an MRM optimized assay. The calibration curves of standards in 50% methanol matrix were linear with $r^2 > 0.990$ (Figure 2) in the tested range of 1 to 1000 $\mu\text{g}/\text{Kg}$ (0.5 to 500pg on column). The limits of quantification were 1 $\mu\text{g}/\text{Kg}$ (0.5pg on column) for all

compounds except succinylsulfathiazole and sulfacetamide, which were 2 $\mu\text{g}/\text{Kg}$ (1pg on column). The recovery ranged from 53.9 to 91.4% for all but two compounds measured using drug residue-free organic honey. Succinylsulfathiazole and sulfaguanidine exhibited recovery below 20% using the QuEChERS method for extraction.

A sensitive and repeatable method for characterization of sulfonamides and trimethoprim in honey using QuEChERS extracts with Liquid-Chromatography-Tandem Mass Spectrometry



Level	Sulfathiazole		Sulfisoxazole		Sulfapyridine		Sulfamethazine		Sulfaguanidine		Sulfadiazine		Sulfaclozine		Sulfamethoxyypyridazine		Sulfabenzamide	
	Cal point %RSD	Accuracy %	Cal point %RSD	Accuracy %	Cal point %RSD	Accuracy %	Cal point %RSD	Accuracy %	Cal point %RSD	Accuracy %	Cal point %RSD	Accuracy %	Cal point %RSD	Accuracy %	Cal point %RSD	Accuracy %	Cal point %RSD	Accuracy %
1	1.7	97.8	1.0	98.9	0.5	96.5	0.6	98.1	0.5	98.3	0.4	94.3	0.5	100.4	1.0	97.5	0.8	98.8
2	0.9	100.4	1.4	101.2	0.3	100.6	1.5	101.8	0.7	99.8	0.2	102.3	1.1	99.9	1.9	101.5	0.3	100.3
3	2.1	102.6	0.4	100.3	0.9	105.0	1.1	101.0	0.9	101.2	1.0	106.0	0.8	99.3	1.1	102.8	0.7	101.6
4	1.7	103.6	0.3	102.0	1.3	107.7	0.8	102.5	0.6	103.6	1.5	109.7	1.7	100.0	0.9	102.7	1.2	102.8
5	0.4	106.3	2.0	101.0	1.4	107.8	1.0	102.1	1.7	105.5	1.3	114.0	1.0	98.4	1.5	104.3	1.4	101.7
6	1.6	106.1	3.3	102.6	0.5	110.8	0.9	106.3	1.8	108.3	0.6	116.8	1.5	99.3	3.2	104.0	0.4	104.2
7	3.8	109.4	1.5	101.1	6.3	103.1	0.7	105.8	3.0	113.9	2.8	115.4	3.4	100.9	1.2	108.1	0.6	103.6
8	4.4	108.0	1.2	104.1	8.2	102.2	3.3	103.7	2.3	114.6	1.6	111.9	5.0	98.5	6.3	105.9	3.3	102.6
9	4.4	115.7	1.5	100.2	4.0	104.4	2.0	106.4	6.4	114.3	6.5	110.8	8.1	87.9	2.7	112.3	2.6	104.7
10	3.9	107.4	5.0	88.0	9.2	103.7	15.2	90.6	8.0	114.1	9.1	118.5	8.8	90.9	5.7	121.4	2.7	97.6
11	12.7	114.7	10.5	100.3	6.2	109.9	5.9	100.9	9.9	126.9	16.5	116.5	6.9	95.5	7.3	105.9	6.4	91.3

Figure 3. Representative chromatograms of sulfonamide drugs at lowest concentration showing limit of quantitation and statistics for diverse concentration levels.

A sensitive and repeatable method for characterization of sulfonamides and trimethoprim in honey using QuEChERS extracts with Liquid-Chromatography-Tandem Mass Spectrometry

Conclusions

LC-MS/MS with QuEChERS as extraction method provides a fast, simple, sensitive and accurately measuring for sulfonamide drugs and trimethoprim in honey with an acceptable recovery range. Matrix matched calibration and use of internal standards can be tested to improve performance.

[← Return to main page](#)

Others



1. Analysis of Organophosphorus Pesticides Using Nexis GC-2030
2. Combined Analysis of a Contaminant Using a Compact FTIR and EDX
3. Contaminant Analysis in Food Manufacturing Process by EDX and FTIR
4. Serotype-Level Bacterial Discrimination Using Matrix-Assisted Laser Desorption Ionization Time-of-Flight Mass Spectrometry
5. Simultaneous Analysis of 418 Pesticides Utilizing Smart SIM
6. Fully Automated Derivatization and Quantitation of Glyphosate and AMPA in Beer Using a Standard UHPLC-MS/MS System
7. Determination of Pyrrolizidine Alkaloids in Plant Material Using on-line SPE Coupled to UHPLC-MS/MS
8. Fast and High Sensitivity Analysis of Six Preservatives in Beverages by UHPLC with Photodiode Array Detection
9. Shimadzu Pesticide MRM Library Support for LC/MS/MS
10. Determining Gamma-Hydroxybutyric Acid and its Precursors Gamma-Butyrolactone and 1,4-Butanediol in Suspected Drug-spiked Beverages using LCMS-8045
11. Carbon Dioxide Determination in Beer

Application News

No. G294

Gas Chromatograph

Analysis of Organophosphorus Pesticides Using Nexis GC-2030

Cases have been reported of health problems due to foods contaminated with pesticides, and there is currently heightened interest in food safety countermeasures. Using a detector with high selectivity for specific components, or a mass spectrometer highly capable of qualitative analysis are effective when analyzing trace components in foods and other samples in which there are many impurities.

The FPD-2030 flame photometric detector, which is installed in Nexis GC-2030 gas chromatograph, has the world's highest level of sensitivity* thanks to the optimized nozzle shape and the advanced dual focus system.

In the analysis of pesticides in foods, this detector provides high sensitivity and high stability.

In this Application News, we introduce an analysis of organophosphorus pesticides using Nexis GC-2030 gas chromatograph, which is equipped with the FPD-2030.

*As of February 2017

E. Kobayashi, T. Murata

■ Analysis Results

A mixture standard solution of 54 organophosphorus pesticides* (20 mg/L) was introduced via split injection, and the elution positions of each pesticide were confirmed.

Table 1 Analytical Conditions

Model	: Nexis GC-2030
Detector	: FPD-2030 (P-mode)
Column	: SH-Rtx-1701 (0.25 mm I.D. × 30 m, d.f. = 0.25 μm)
Column Temperature	: 60 °C (2 min) - 25 °C/min - 150 °C (0 min) - 5 °C/min - 200 °C (12 min) - 5 °C/min - 280 °C (7 min) Total 50.6 min
Injection Mode	: Split 1 : 20
Carrier Gas Controller	: Constant Linear Velocity (He)
Linear Velocity	: 30 cm/sec
Injection Temperature	: 250 °C
Detector Temperature	: 275 °C
Injection Volume	: 1 μL

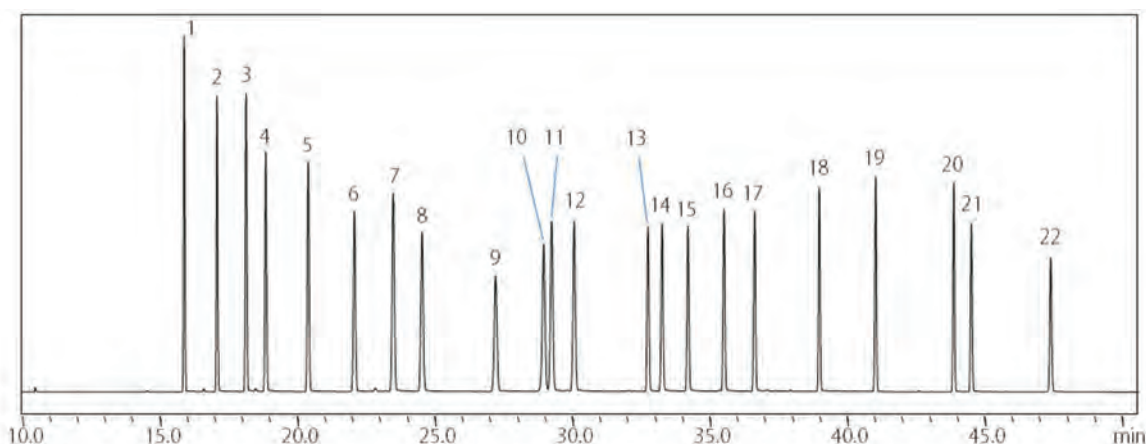

1: Ethoprophos	7: Dimethoate	13: Isofenphos	19: Fensulfothion
2: Phorate	8: Tolclofos-methyl	14: PAP (Phenthoate)	20: EPN
3: Thiometon	9: Chlorpyrifos	15: Prothiofos	21: PMP (Phosmet)
4: Terbufos	10: Formothion	16: DMTP (Mathidathion)	22: Pyraclofos
5: Etrimfos	11: MPP (Fenthion)	17: Butamifos	
6: ECP (Dichlofenthion)	12: MEP (Fenitrothion)	18: Sulprofos	

Fig. 1 Chromatogram of 20 mg/L Organophosphorus Pesticides

Trace Level Analysis

Table 2 and Fig. 2 show the analysis conditions and the chromatogram respectively for a trace level analysis of 5 µg/L organophosphorus pesticides via high-pressure splitless injection.

Table 2 Analysis Conditions for Low-Concentration Organophosphorus Pesticides

Model	: Nexis GC-2030
Detector	: FPD-2030 (P-mode)
Column	: SH-Rtx-1701 (0.25 mm I.D. × 30 m, d.f. = 0.25 µm)
Column Temperature	: 60 °C (1 min) - 20 °C/min - 180 °C (0 min) - 5 °C/min - 200 °C (10 min) - 7 °C/min - 280 °C (5 min) Total 37.4 min
Injection Mode	: High Pressure Splitless (300 kPa, 1 min)
Carrier Gas Controller	: Constan Linear Velocity (He)
Linear Velocity	: 46.8 cm/sec
Injection Temperature	: 260 °C
Detector Temperature	: 300 °C
Injection Volume	: 2 µL

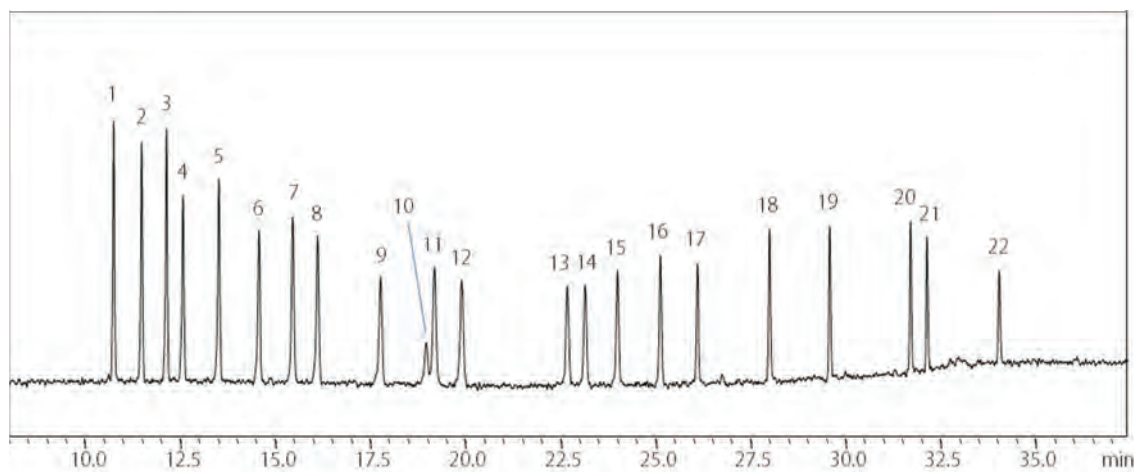

	S/N		S/N
1: Ethoprophos	: 42	12: MEP (Fenitrothion)	: 17
2: Phorate	: 39	13: Isofenphos	: 15
3: Thiometon	: 42	14: PAP (Phenthoate)	: 16
4: Terbufos	: 30	15: Prothiofos	: 18
5: Etrimfos	: 33	16: DMTP (Mathidathion)	: 21
6: ECP (Dichlofenthion)	: 24	17: Butamifos	: 19
7: Dimethoate	: 26	18: Sulprofos	: 25
8: Tolclofos-methyl	: 23	19: Fensulfothion	: 25
9: Chlorpyrifos	: 16	20: EPN	: 25
10: Formothion	: 5	21: PMP (Phosmet)	: 22
11: MPP (Fenthion)	: 18	22: Pyraclofos	: 15

Fig. 2 Chromatogram of Low-Concentration (5 µg/L) Organophosphorus Pesticides

Application News

No. A567

Spectrophotometric Analysis

Combined Analysis of a Contaminant Using a Compact FTIR and EDX

Demands regarding the analysis of contaminants that are mixed in or adhered to products are increasing for food and chemical manufacturers and inspection agencies which are consigned inspections.

This increase in demands has drawn attention to energy dispersive X-ray fluorescence spectrometers (EDX) which are suited to analyzing inorganic elements such as metals and to Fourier transform infrared spectrophotometers (FTIR) which are optimal for the analysis of organic substances such as polymeric compounds. Cases where one sample is analyzed using both instruments are increasing as well. However, data obtained with each instrument requires respective analysis procedures and results are sometimes influenced by the operator's knowledge and experience. It is in light of such situations that Shimadzu developed the EDX-FTIR contaminant finder/material inspector, EDXIR-Analysis™ software. The first in the industry, this software is capable of combining and analyzing data acquired from a Shimadzu EDX and FTIR. Details of the software are introduced in Application News Nos. A522A⁽¹⁾ and A527⁽²⁾. This article introduces an example analysis of a contaminant using the EDX-FTIR combined analysis system shown in Fig. 1.

R. Fuji, T. Nakao



Fig. 1 EDX-FTIR Combined Analysis System

Measurement Sample

A contaminant found in a food production process (Fig. 2) was used as the measurement sample. About 4 mm in size and white on the surface, the sample is hard when handled with tweezers. The sample was measured by fixing it in place using the EDXIR-Holder™ shown in Fig. 3, which is a sample holder/stocker for contaminant measurement and effective for streamlining analysis processes for EDX and FTIR. Details of the EDXIR-Holder are introduced in Application News No. A537⁽³⁾.



Fig. 2 Photograph of Contaminant Found in a Food Production Process

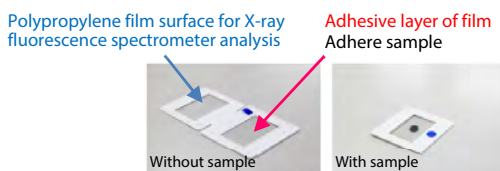

Fig. 3 EDXIR-Holder: Sample Holder/Stocker for Contaminant Measurement

Measurement Using FTIR

IRSpirit™, a compact FTIR, was used for measurement with the QATR™-S single-reflection ATR accessory, which is designed especially for the IRSpirit series, with a diamond prism installed (Fig. 4). Fig. 5 shows the sample set on the instrument and Table 1 lists the measurement conditions that were used. In using the IRSpirit, the dedicated IR Pilot program was used to facilitate measurement. IR Pilot allows operators with minimal FTIR experience to analyze samples by simply selecting the analysis purpose and the accessory. The measured spectrum and the search result from the standards library with the highest similarity are drawn superimposed in Fig. 6. In this case, protein was identified as the best match.



Fig. 4 IRSpirit with QATR-S Single-Reflection ATR Accessory (Diamond prism)

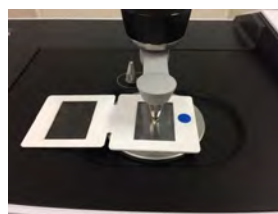

Fig. 5 Sample Set on Instrument

Table 1 Measurement Conditions

Instrument	: IRSpirit-T (KRS-5 window) QATR-S
Resolution	: 4 cm ⁻¹
Accumulation Times	: 20
Apodization Function	: SqrTriangle
Detector	: DLATGS

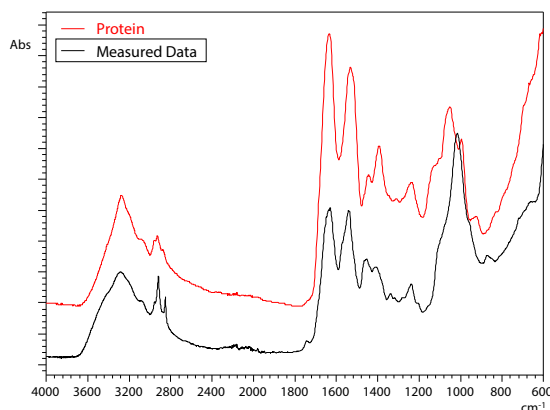

Fig. 6 Infrared Spectra of Measured Data and the Search Result

Measurement Using EDX

Measurement was done using the EDX-7000 energy dispersive X-ray fluorescence spectrometer (Fig.7) according to the measurement conditions listed in Table 2. The sample was set on the instrument as shown in Fig. 8. For measurement using EDX, the EDXIR-Holder is closed and placed so that the side with polypropylene film is facing the X-ray beam source (bottom). The EDXIR-Holder enables easy setting of samples between EDX and FTIR instruments and contributes to alleviating and improving the efficiency of analysis tasks.



Fig. 7 EDX-7000 Energy Dispersive X-Ray Fluorescence Spectrometer

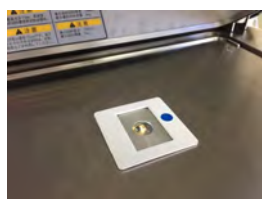

Fig. 8 Sample Set on Instrument

Table 2 Measurement Conditions

Instrument	: EDX-7000
X-Ray Tube Target	: Rh
Voltage / Current	: 50 kV (Al-U) / Auto
Atmosphere	: Vacuum
Analysis Diameter	: 1 mmφ
Filter	: None
Integration Time	: 100 s

Fig. 9 shows the qualitative and quantitative analysis results which indicate that ²⁰Ca and ¹⁵P are the primary elements of the contaminant. Conventionally, the identification of a contaminant requires the analysis of each of the EDX and FTIR measurement results. In this instance however, the EDXIR-Analysis software was used to read and analyze the data acquired from the instruments.

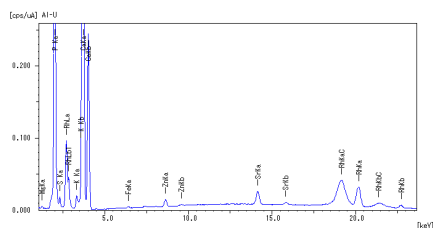

Fig. 9 Qualitative and Quantitative Analysis Results

EDXIR-Analysis, IRTracer, IRAffinity, EDXIR-Holder, IRSpirit and QATR are trademarks of Shimadzu Corporation.

Elements	Ca	P	Mg	K	S	Sr	Zn	Fe
Quantitative Value [wt%]	68.1	28.3	1.8	0.95	0.66	0.09	0.09	0.04

Analysis Using EDXIR-Analysis Software

Analysis was done using the EDXIR-Analysis software. The contaminant library used in analysis was developed by measuring and accumulating data of contaminants provided by water supply organizations and food manufacturers using Shimadzu's EDX and FTIR. Comprising a total of 485 entries, various contaminants such as tap water contaminants and food contaminants are registered.

The hit list shown in Fig. 10 indicates that with a similarity of 0.9160, the most probable match is white bone particle (a mixture of calcium phosphate and protein). Similarity values are within the range from 0 to 1 and larger values indicate that the analyzed data (acquired data) and the hit data (data in the library) are more similar. By comparing the element content and X-ray fluorescence profile of the analyzed data and hit data in Fig. 11 and the infrared spectra in Fig. 12, we can see that the two are highly similar. In addition, images of the sample can be compared as shown in Fig. 13, allowing evaluation of similarity with candidate substances in terms of color, shape, and texture. Based on these various aspects it was concluded that the contaminant is bone.

Rank	Similarity	ID	Sample Name	Comment	Detail
1	0.9160	0162	Contaminants 363_bone_particle_white	Bone particle_white Materials:Bone particle/Calcium phosphate/Protein_Major	
2	0.8120	0163	Contaminants 363_bone_particle_white_D	Bone particle_white Materials:Bone particle/Calcium phosphate/Protein_Major	
3	0.8048	0165	Contaminants 365_bone_particle_brown_D	Bone particle_brown Materials:Bone particle/Calcium phosphate/Protein_Major	
4	0.8796	0164	Contaminants 364_bone_particle_brown	Bone particle_brown Materials:Bone particle/Calcium phosphate/Protein_Major	
5	0.8739	0168	Contaminants 385_bone_phosphate_gray_D	Partial phosphate_gray Materials:Lipid/Calcium	

Fig. 10 Hit List

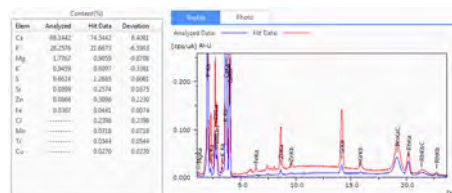

Fig. 11 Element Content and X-Ray Fluorescence Profiles of Analyzed Data and Hit Data

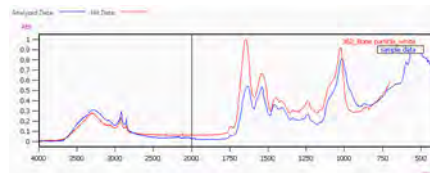

Fig. 12 Infrared Spectra of Analyzed Data and Hit Data

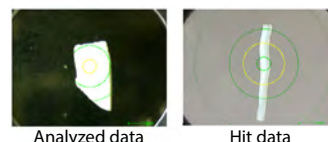

Fig. 13 Sample Images of Analyzed Data and Hit Data

The EDXIR-Analysis software enabled easy and swift obtaining of analysis results that combine the inorganic element information acquired using EDX and the organic compound information acquired using FTIR.

References

- (1) Application News No. A522A "Contaminant Analysis Using EDXIR-Analysis Software for Combined EDX-FTIR Analysis"
- (2) Application News No. A527 "Quantifying "Silent Change" Using EDXIR-Analysis Software: EDX-FTIR Contaminant Finder/Material Inspector"
- (3) Application News No. A537 "Introducing the EDXIR-Holder: Sample Holder/Stocker for Contaminant Measurement"



For Research Use Only. Not for use in diagnostic procedure.

This publication may contain references to products that are not available in your country. Please contact us to check the availability of these products in your country.

The content of this publication shall not be reproduced, altered or sold for any commercial purpose without the written approval of Shimadzu. Shimadzu disclaims any proprietary interest in trademarks and trade names used in this publication other than its own. See <http://www.shimadzu.com/about/trademarks/index.html> for details.

The information contained herein is provided to you "as is" without warranty of any kind including without limitation warranties as to its accuracy or completeness. Shimadzu does not assume any responsibility or liability for any damage, whether direct or indirect, relating to the use of this publication. This publication is based upon the information available to Shimadzu on or before the date of publication, and subject to change without notice.

Application News

No. X261

X-ray Analysis

Contaminant Analysis in Food Manufacturing Process by EDX and FTIR

EDX and FTIR are widely used for analysis of foreign contaminant matter, but recently, these instruments are increasingly being utilized in tandem to conduct contaminant analysis¹⁾. While identification using any of these instruments and analytical methods independently is limited to some degree, using them in conjunction with one another permits a more detailed elucidation of the contaminant characteristics, thereby enhancing the validity of the respective results. The analytical method and sample pretreatment method to be used depend on the degree to which a contaminant is to be characterized, whether or not the substance is altered or destroyed due to pretreatment, and the speed that is required to complete the analysis. Introduced here is an example of actual analysis of various types of foreign matter entered during the food manufacturing process.

■ Samples

Foreign matter that entered during the food manufacturing process Five types of samples: Sample 1, 2, 3, 4, 5

■ Pretreatment and Analysis Procedures

First, EDX measurement was conducted without conducting any sample pretreatment, and then FTIR measurement was conducted similarly without pretreatment. Next, the foreign matter was removed by rinsing, and then analyzed. This preparation procedure is outlined in the flowchart of Fig. 1.

Depending on the sample, there may be cases in which detailed analysis by ATR measurement using the FTIR main unit will be difficult due to such factors as small sample size relative to the prism, which could result in the sample

being crushed, such as in the current situation, or samples consisting of a mixture, etc. It was therefore decided to conduct microscopic ATR measurement with close contact of the prism at the measurement site.

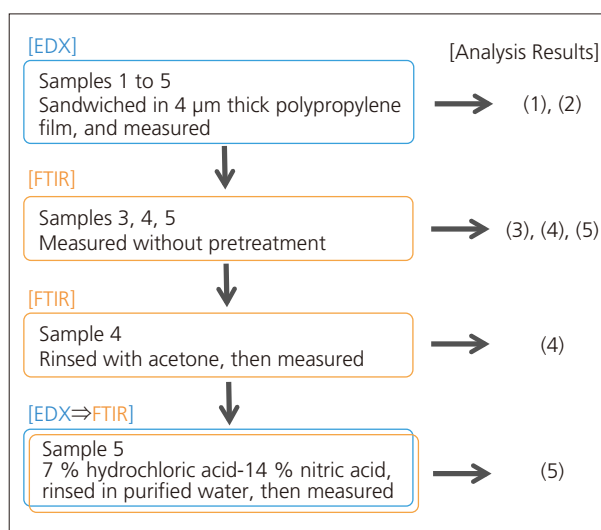

Fig. 1 Pretreatment and Analysis Procedures

■ Analysis Result

Fig. 2 to Fig. 9 and Table 1 to Table 5 show the analysis results for each sample using EDX and FTIR, in addition to the inferred and specific attributions according to those results.

(1) Sample 1 Characteristics: Metallic luster, hard, silvery white

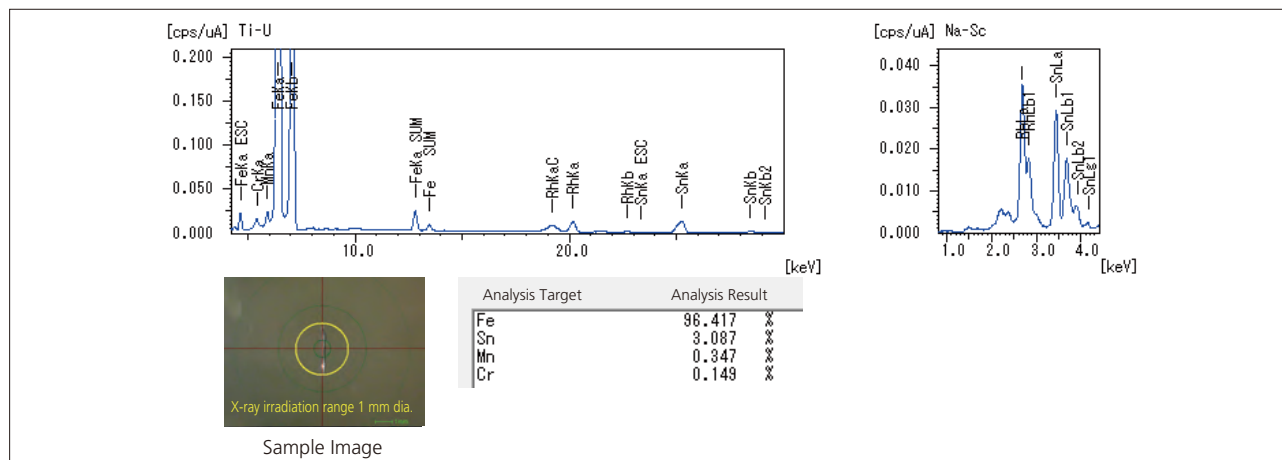

Fig. 2 Sample 1 Qualitative-Quantitative Results by EDX

Table 1 Analysis Results for Sample 1

	Measurement Result	Possible Source	Total Findings Found by EDX and FTIR
EDX	Principal component is ²⁶ Fe, next prevalent is ⁵⁰ Sn.	Tin-plated steel sheet, fragment of tin can	Tin-plated steel sheet, fragment of tin can (Clearly metallic according to EDX measurement only)
FTIR	Omitted (Significant peak not detected)	Possibly a metal or inorganic compound	

(2) Sample 2 Characteristics: Metallic luster, hard, silver color

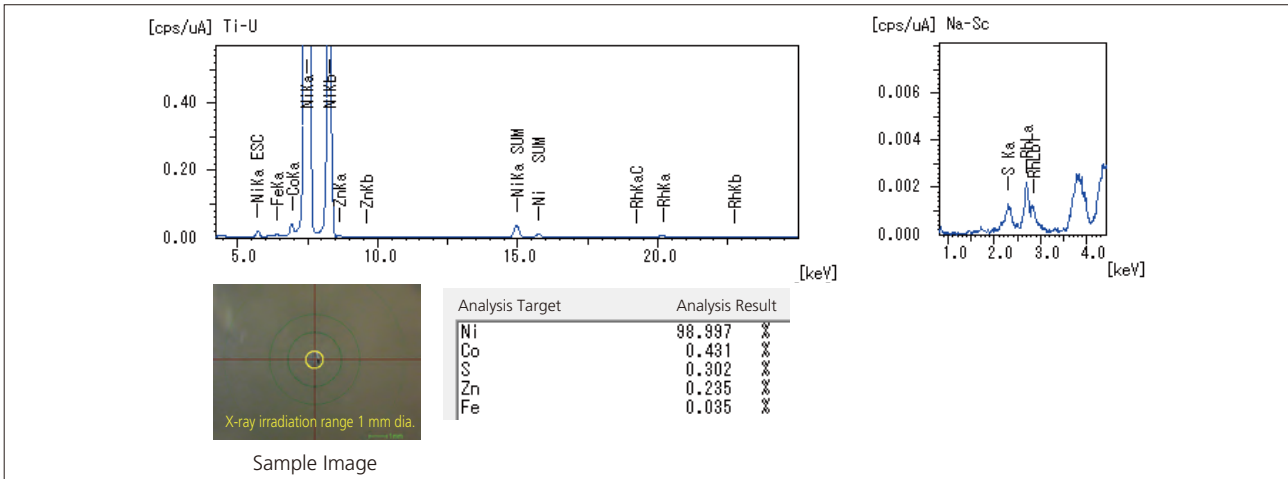

Fig. 3 Sample 2 Qualitative-Quantitative Results by EDX

Table 2 Analysis Results for Sample 2

	Measurement Result	Possible Source	Total Findings Found by EDX and FTIR
EDX	Principal component is ²⁸ Ni, other components are in small quantity.	Nickel, peeling of the nickel plating	Nickel, peeling of the nickel plating (Clearly metallic according to EDX measurement only)
FTIR	Omitted (Significant peak not detected)	Possibly a metal or inorganic compound	

(3) Sample 3 Characteristics: No metallic luster, brittle, brownish red

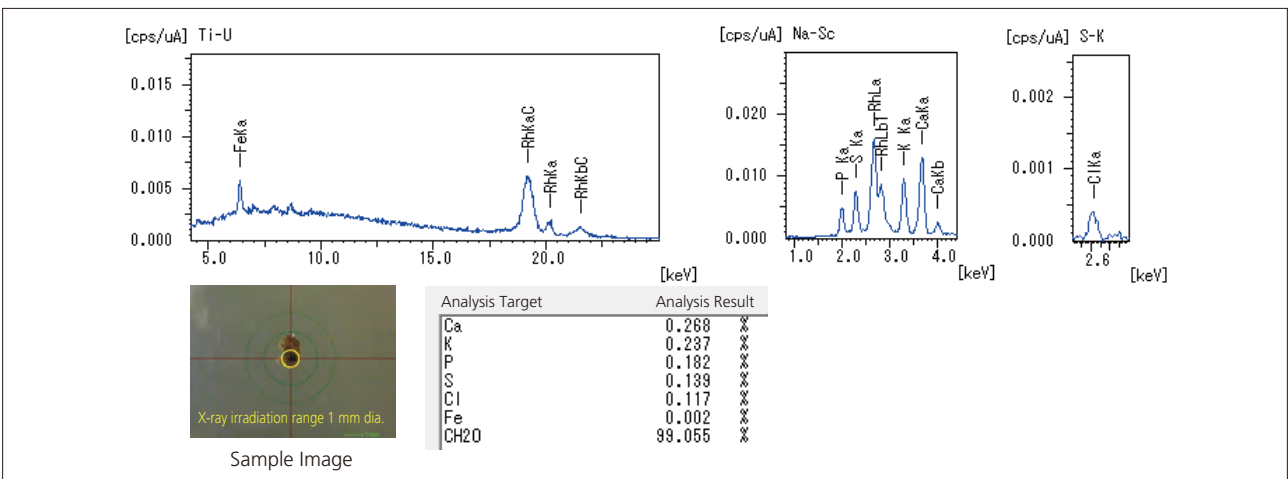

Fig. 4 Sample 3 Qualitative-Quantitative Results by EDX

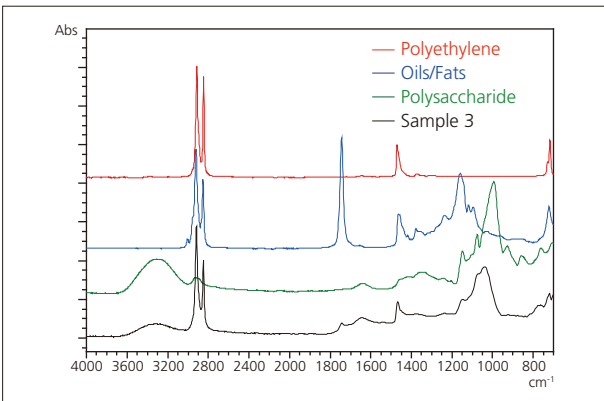

Fig. 5 Infrared Spectrum and Search Results for Sample 3 by FTIR

Table 3 Analysis Results for Sample 3

	Measurement Result	Possible Source	Total Findings Found by EDX and FTIR
EDX	Detected ¹⁹ K, ²⁰ Ca, and other food components. Principal component is ⁹ F and below. (RhKaC is big. ²⁾)	Food clump	Polyethylene with attached food components
FTIR	Polyethylene, oils and fats, polysaccharides	Polyethylene with attached oils/fats and polysaccharides	

(4) Sample 4 Characteristics: Non-metallic luster, hard, black

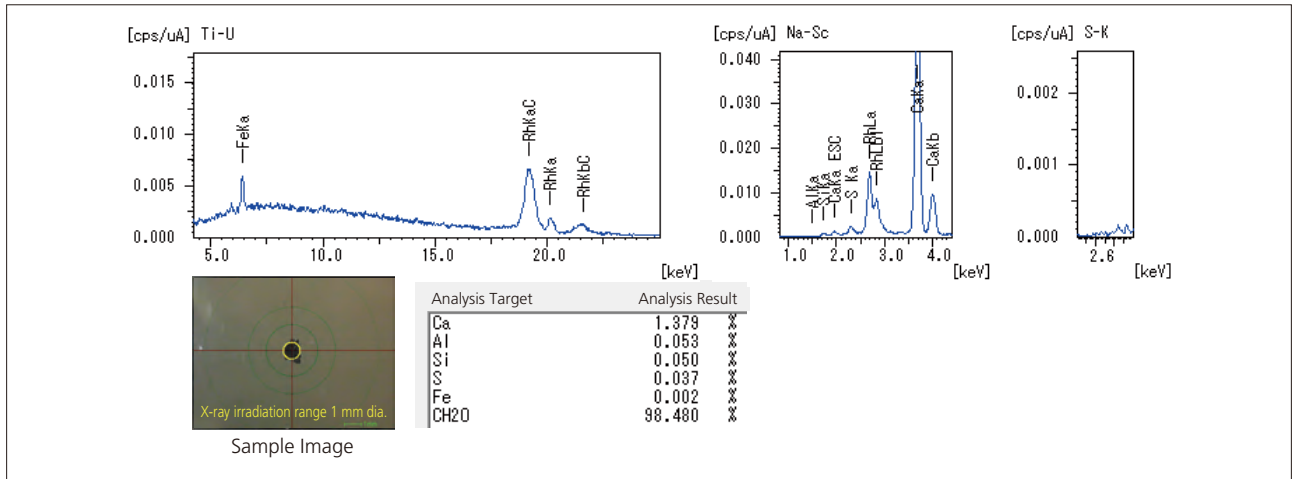

Fig. 6 Sample 4 Qualitative-Quantitative Results by EDX

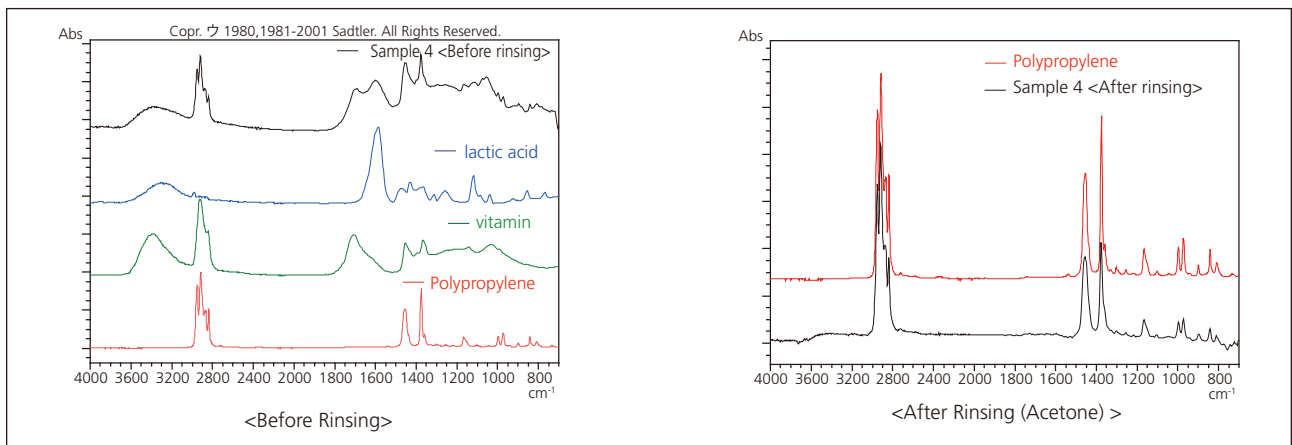

Fig. 7 Sample 4 Infrared Spectra and Search Results by FTIR

Table 4 Analysis Results for Sample 4

	Measurement Result	Possible Source	Total Findings Found by EDX and FTIR			
EDX	Detected ²⁰ Ca and other food components. Principal component is ¹⁹ F and below.	Food clump, resins, etc.	Polyethylene with attached food components			
FTIR	<table border="1"> <tr> <td>Before rinsing</td> <td>Polypropylene, lactic acid, vitamins</td> </tr> <tr> <td>After rinsing</td> <td>Polypropylene</td> </tr> </table>	Before rinsing		Polypropylene, lactic acid, vitamins	After rinsing	Polypropylene
Before rinsing	Polypropylene, lactic acid, vitamins					
After rinsing	Polypropylene					

(5) Sample 5 Characteristics: Some metallic luster, hard, black silver color

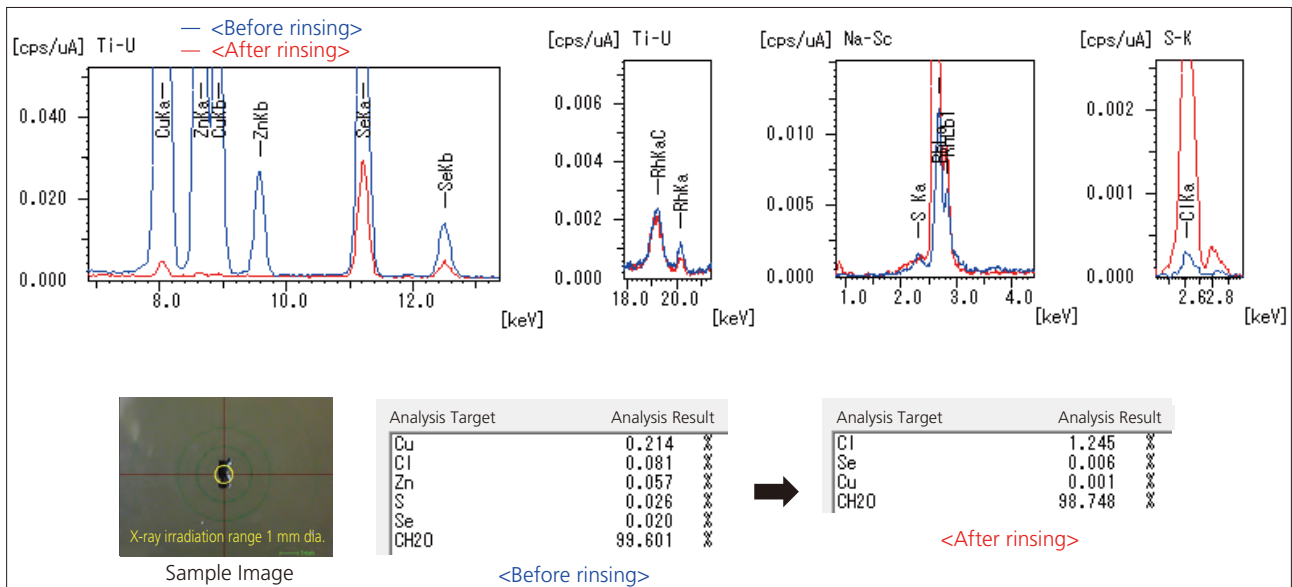

Fig. 8 Sample 5 Qualitative-Quantitative Result by EDX

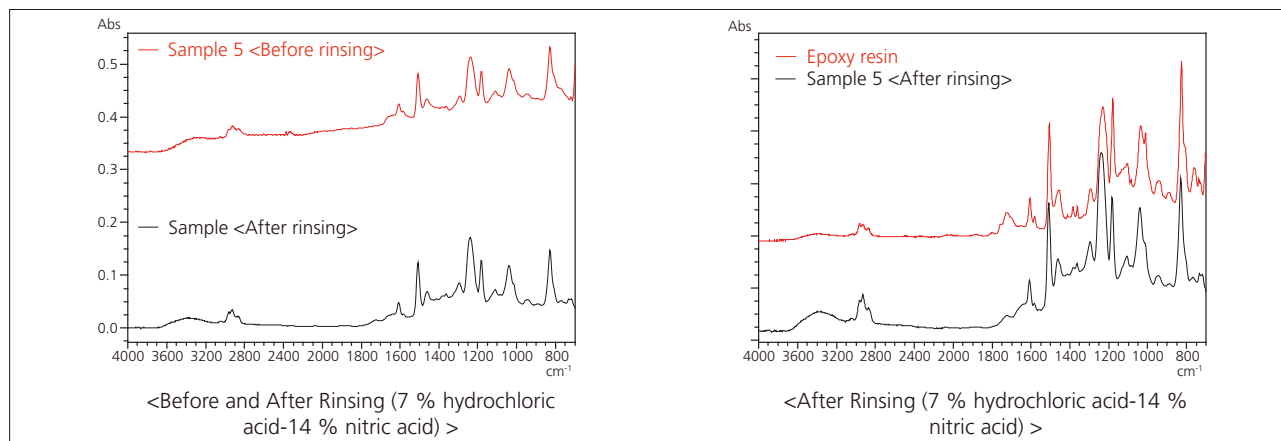

Fig. 9 Sample 5 Infrared Spectra and Search Result by FTIR

Table 5 Analysis Results for Sample 5

		Measurement Result	Possible Source	Total Findings Found by EDX and FTIR
EDX	Before rinsing	Principal components are ${}^9\text{F}$ and below, large amounts of ${}^{29}\text{Cu}$, ${}^{30}\text{Zn}$, ${}^{34}\text{Se}$.	Copper alloy, resin composite material, zinc, selenium additives	Zinc and selenium food additives adhering to epoxy resin coated on copper thin film
	After rinsing	Principal components are ${}^9\text{F}$ and below, with ${}^{29}\text{Cu}$, ${}^{30}\text{Zn}$ nearly absent due to rinsing, and a small amount of residual ${}^{34}\text{Se}$.	Film	
FTIR	Before rinsing	Epoxy resin (with the presence of metals, etc. suggested due to rising of the infrared baseline)	Composite material consisting of epoxy resin and metal	
	After rinsing	Epoxy resin (no rise in the baseline in infrared spectrum)	Epoxy resin	

- Regarding the EDX quantitative analysis results
 - Organic material is represented by CH_2O , and was balanced.
 - Abundant, small quantity, etc. are relative reference values. (In order to collectively set plating, film and deposits, etc.)

Conclusion

The analysis results by both EDX and FTIR permitted approximate identification of metals, resins, and their compounds or complex materials associated with contaminants introduced during the food product manufacturing process without the need for

pretreatment. Further, by conducting relatively simple pretreatment of samples, detailed identification is also possible depending on the sample. In terms of speed and ease, these analytical techniques are quite effective.

[References]

- 1) Shimadzu Application News No. A452
- 2) Izumi Nakai (Editor), A Practical Guide for X-ray Fluorescence Analysis, Asakura Publishing, 90 (2006)

Analytical Conditions [EDX]

Instrument	: EDX-7000
Elements	: Na-U
Analytical Group	: Qualitative-quantitative
Detector	: SDD
X-Ray Tube	: Rh target
Tube Voltage [kV]	: 15, 50
Current [μA]	: Auto
Collimator [mm ϕ]	: 1 or 3
Primary Filter	: Non, #2
Atmosphere	: Vacuum
Integration Time [sec]	: 50 /ch
Dead Time [%]	: Max. 30

Analytical Conditions [FTIR]

Instruments	: IRTracer-100, AIM-8800
Resolution	: 8 cm^{-1}
Accumulation	: 40
Apodization	: Sqr-Triangle
Detector	: MCT

Technical Report

Serotype-Level Bacterial Discrimination Using Matrix-Assisted Laser Desorption Ionization Time-of-Flight Mass Spectrometry

Practical Application of the Highly-Accurate Bacterial Discrimination Software "Strain Solution Ver. 2" with the iD^{plus}

Teruyo Ojima-Kato¹, Hiroto Tamura^{1,2}, Naomi Yamamoto², Keisuke Shima³

Abstract:

We successfully achieved serotype-level discrimination of enterohemorrhagic *Escherichia coli* using a proteotyping method (the *S10*-GERMS method) with markers consisting of ribosomal proteins detected during bacterial measurements using matrix-assisted laser desorption ionization time-of-flight mass spectrometry (MALDI-TOF MS). In the future, this technique could be utilized as a routine method for the discrimination of bacteria at levels finer than the species level, which has thus far not been possible with conventional MALDI-TOF MS fingerprinting-based microbial identification methods.

Keywords: food-poisoning pathogens, MALDI-TOF MS, proteotyping, *S10*-GERMS

1. Introduction

Fast and accurate microbial identification is needed on a routine basis during the manufacturing of food products and pharmaceuticals, as well as in clinical microbiological testing. In particular, the rapid identification of pathogenic microorganisms and microbial contaminants (opportunistic bacteria) has become increasingly important. Conventional microbial identification methods generally include physiological and biochemical tests as well as DNA nucleotide sequence analyses targeting 16S rRNA gene sequences. However, these techniques are associated with the following challenges: 1) they lack rapidity; 2) they are labor-intensive and require expertise; 3) for some bacterial species, detailed identification is impossible beyond the genus or species level; and, importantly, 4) the discrimination of pathogenic microorganisms requires the use of costly reagents (e.g., antisera/antibodies). Thus, methods based on matrix-assisted laser desorption ionization time-of-flight mass spectrometry (MALDI-TOF MS) have received wide attention as new techniques for the rapid identification of microorganisms. MALDI-TOF MS is attractive owing to its simplicity and convenience, and the fact that it allows for the rapid processing of multiple samples. Basically, analyses can be carried out by simply mixing microbial samples from a single colony with an extremely small amount of matrix solution (ionization adjuvant). In addition, the required analysis time of this method is less than 1 minute per sample, which allows for processing multiple samples in a short amount of time. Microbial identification methods using MALDI-TOF MS have been spreading rapidly since the late 2000s, mainly in the field of clinical microbiological testing, and were approved by the United States Food and Drug Administration in 2013. The procedure of microbial identification using MALDI-TOF MS consists of acquiring the mass spectrum of a microbial sample and matching it with the mass spectra of various bacterial species that are previously recorded in a database (fingerprinting method). Although the fingerprinting method allows for identification up to the genus and species levels, it does not allow for detailed discrimination of the serotypes of important food poisoning-related pathogens such as *Escherichia coli* and *Salmonella*. Therefore, we developed a method for discrimination of the serotypes of food poisoning-causing bacteria using the proteotyping method*¹ *S10*-*spc-alpha* operon Gene Encoded Ribosomal protein Mass Spectrum (*S10*-GERMS method)^[1], which enables discrimination of microorganisms with high accuracy, surpassing that of the fingerprinting method. In addition, a highly-accurate bacterial discrimination software named Strain Solution Ver. 2 was developed, which is compatible with the iD^{plus} (Fig. 1). In this communication, the use of MALDI-TOF MS and Strain Solution Ver. 2 for the discrimination of microorganisms to the level of serotypes is introduced, and an example of the application of the method for enterohemorrhagic *Escherichia coli**² is described^[2].

*1 proteotyping method:

In this method, protein components detected by MALDI-TOF MS are used as biomarkers for the discrimination of microorganisms. The biomarkers used for proteotyping are specified in advance on the basis of the nucleotide sequence data of the target gene. Compared to typing methods based on genetic techniques such as the conventional DNA sequencing method, proteotyping using MALDI-TOF MS offers the advantages of being faster, simpler, and easier to use. If the genome sequence of the targeted bacterial species has not yet been decoded, proteotyping can still be carried out by decoding the base sequence of the *S10*-*spc-alpha* operon, which encodes approximately half of all ribosomal proteins. The *S10*-GERMS method was developed by the Department of Environmental Bioscience, Faculty of Agriculture, Meijo University, and by the Environmental Measurement Technology Group, National Institute of Advanced Industrial Science and Technology.

*2 Enterohemorrhagic *Escherichia coli*:

Nearly 200 different serotypes of *Escherichia coli* (type O antigen) have been reported thus far, but the Shiga toxin-producing serotypes O157, O26, and O111 are the major pathogens responsible for food poisoning, and are therefore the most problematic. However, bacterial identification methods using conventional fingerprinting techniques are limited to the species level, which does not allow for determination of serotypes.

2. The *S10*-GERMS Method and Strain Solution Ver. 2

The *S10*-GERMS method identifies the genes encoding the proteins (biomarkers) detected as mass peaks by MALDI-TOF MS that are specific to serotypes or strains of microorganisms. As a result, a database of the theoretical masses of mass peaks that could potentially be used as biomarkers for the distinction between serotypes or strains can be constructed on the basis of the DNA sequence information of the gene as well as on the basis of the actual measured values. Strain Solution Ver. 2 matches the list of the mass peaks obtained from the sample with the database of theoretical values.

Unlike fingerprinting methods, the components of the biomarkers used in this method are well-defined, and therefore discrimination can be achieved even if the difference consists of only a single amino acid mutation resulting from a single-base mutation. For this reason, this method is also useful for the molecular phylogenetic analysis that follows microbial identification, as well as for the analysis of mixed samples (which will be described later).

1 Research Institute, Meijo University

2 Department of Environmental Bioscience, Faculty of Agriculture, Meijo University

3 Analytical & Measuring Instruments Division, Shimadzu Corporation

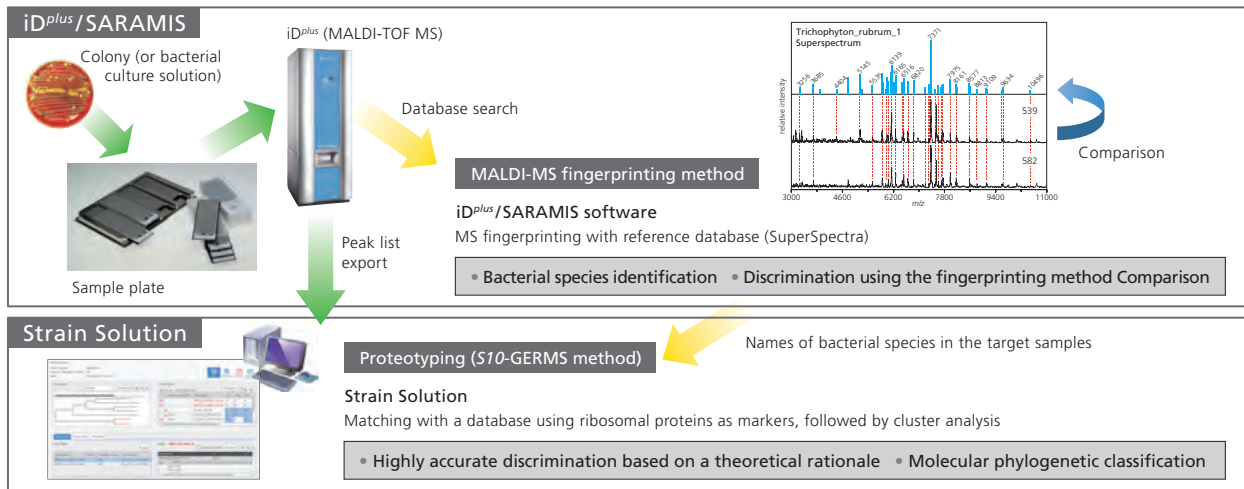

Fig. 1 *iDplus* and Strain Solution

3. Application of the Method

Here, we introduce the development of a database aimed at distinguishing among the major serotypes of enterohemorrhagic *Escherichia coli*, namely O157, O26, and O111, and provide an example of the analysis using Strain Solution Ver. 2.

3-1. Development of a Database Designed for Use with Strain Solution Ver. 2

First, 50 strains of *Escherichia coli* with various types of O antigens were obtained from culture collections; measurements were carried out with MALDI-TOF MS (*iDplus*), and biomarker proteins that could potentially be used as indicators for serotype discrimination were selected. Genomic information or experimentally analyzed DNA sequence data were matched with data from actual measurements using MALDI-TOF MS, and a table of the theoretical masses of the selected biomarkers was created (Fig. 2). As a result, we found a number of biomarker candidates that showed mass numbers characteristic to each *Escherichia coli* serotype, and we were able to distinguish 12 groups (groups A–L) among the 50 strains of *Escherichia coli*.

Among these groups, we found that the presence or absence of the acid-stress protein HdeB (*m/z* 9066.2), the ribosomal protein subunits S15 (*m/z* 10166.6 or 10138.6) and L25 (*m/z* 10676.4 or 10694.4), as well as the DNA-binding protein H-NS (*m/z* 15409.4 or 15425.4) were characteristic of serotypes O157, O26, and O111, the major serotypes of enterohemorrhagic *Escherichia coli*. These biomarkers were also useful for distinguishing between the aforementioned serotypes and other *Escherichia coli* strains and serotypes.

3-2. Verification Using Wild-Type Strains

We carried out a verification of the practicality of the developed database using 45 wild-type strains of *Escherichia coli* of various serotypes, which were isolated from food poisoning patients as well as from food samples (Table 1)^[3]. The strains were cultured in tryptone soy agar medium and common *Escherichia coli* selective media (desoxycholate agar medium, CT-SMAC medium, Chromagar X-gal medium, and VRBL medium). Specifically, the following steps were carried out for the verification (Fig. 1).

- (1) On the basis of the theoretical mass list shown in Fig. 2, the marker peaks of HdeB, S15, L25, and H-NS of *Escherichia coli* strains O157, O26, O111, and K12 were recorded in the Strain Solution Ver. 2 database.
- (2) Single colonies (approximately 10^7 cells) of the wild-type strains used in the verification experiments were cultured on agar medium and smeared on metal plates for analysis, and then mixed

with 1 μ L of matrix solution (20 mg/mL sinapic acid, 50% acetonitrile, 1% trifluoroacetic acid).

- (3) Analyses were carried out using the *iDplus*, and mass spectra were obtained.
- (4) Using Strain Solution Ver. 2, the list of mass peaks in the resulting mass spectrum was matched with the marker peaks registered in the database.

Table 1 *Escherichia coli* Strains Used in the Verification Experiments^[3]

ID	Serotype	Gene			Source
		<i>stx1</i>	<i>stx2</i>	<i>eae</i>	
KB0137	O157	+	+	N. D.	Patient (Japan)
KB0139	O157	+	+	N. D.	Patient (Japan)
KB0150	O157	—	—	N. D.	Patient (USA)
KB0152	O157	+	+	N. D.	Patient (Japan)
KB0155	O157	—	+	N. D.	Patient (Kenya)
KB0156	O157	+	+	N. D.	Patient (Japan)
KB0340	O157	—	+	N. D.	Beef liver
KB0341-1	O157	—	+	+	Beef omasum
KB0341-2	O157	—	—	—	Beef omasum
KB0514	O157	—	+	+	Patient (Japan)
KB0521	O111	+	—	+	Patient (Japan)
KB0522	O157	+	+	+	Patient (Japan)
KB0548	O159	+	+	N. D.	Patient (Kenya)
KB0549	LIT	—	+	N. D.	Patient (Kenya)
KB0617	O26	+	+	N. D.	Patient (unknown)
KB0618	O26	+	+	N. D.	Patient (unknown)
KB0619	O26	+	+	N. D.	Patient (unknown)
KB0620	O26	+	+	N. D.	Patient (unknown)
KB0621	O26	+	+	N. D.	Patient (unknown)
KB0622	O26	+	+	N. D.	Patient (unknown)
KB0623	O26	+	+	N. D.	Patient (unknown)
KB0624	O26	+	+	N. D.	Patient (unknown)
KB0625	O26	+	+	N. D.	Patient (unknown)
KB0626	O26	+	+	N. D.	Patient (unknown)
KB0627	O111	+	—	N. D.	Patient (Japan)
KB0628	O111	+	+	N. D.	Patient (Japan)
KB0732	O121	—	+	+	Patient (Japan)
KB0733	UT	+	+	—	Minced meat
KB0734	O145	+	—	+	Patient (Japan)
KB0735	O91	+	—	—	Patient (Japan)
KB0738	UT	—	+	+	Patient (Japan)
KB0739	O121	—	+	+	Patient (Japan)
KB0740	O91	+	+	—	Patient (Japan)
KB0741	O145	+	—	+	Patient (Japan)
KB0742	O128	+	+	—	Patient (Japan)
KB0743	O91	+	+	—	Patient (Japan)
KB0744	UT	—	+	—	Patient (Japan)
KB0745	O157	+	+	+	Patient (Japan)
KB0746	O115	+	—	—	Patient (Japan)
KB0747	O121	—	+	+	Patient (Japan)
KB0748	O145	—	+	+	Patient (Japan)
KB0749	O103	+	—	+	Patient (Japan)
KB0750	O103	+	—	+	Patient (Japan)
KB0751	O145	+	—	+	Patient (Japan)
KB0752	O145	—	+	+	Patient (Japan)

Serotypes were determined by performing antisera agglutination tests and PCR. UT, untyped. N. D., not determined.

Theoretical mass database

		Group of mass pattern																												
		A		B		C		D				E		F		G		H		I		J		K		L				
Number of strains	Coded operon	14	2	2	9	3	1	1	4	1	1	1	2	5	1	1	1	1	1	1	1	1	1	1	1	1	1			
Protein	Coded operon	O157	O157	O111	O26	O121	O128	O152	-	O115	O119	O63	-	K12	-	-	-	-	-	-	-	-	-	-	-	-	O150			
L23	S10	11200.1	11200.1	11200.1	11200.1	11200.1	11200.1	11200.1	11200.1	11200.1	11200.1	11200.1	11200.1	11200.1	11200.1	11200.1	11200.1	11200.1	11200.1	11200.1	11200.1	11200.1	11200.1	11200.1	11200.1	11200.1	11200.1	11200.1		
L24	spc	11186.0	11186.0	11186.0	11186.0	11186.0	11186.0	11186.0	11186.0	11186.0	11186.0	11186.0	11186.0	11186.0	11186.0	11186.0	11186.0	11186.0	11186.0	11186.0	11186.0	11186.0	11186.0	11186.0	11186.0	11186.0	11186.0	11186.0	11186.0	
S14	spc	11450.3	11450.3	11450.3	11450.3	11450.3	11450.3	11450.3	11450.3	11450.3	11450.3	11450.3	11450.3	11450.3	11450.3	11450.3	11450.3	11450.3	11450.3	11450.3	11450.3	11450.3	11450.3	11450.3	11450.3	11450.3	11450.3	11450.3	11450.3	
L15	spc	14967.4	14967.4	14967.4	14967.4	14967.4	14967.4	14967.4	14967.4	14967.4	14967.4	14967.4	14967.4	14967.4	14967.4	14967.4	14967.4	14967.4	14967.4	14967.4	14967.4	14967.4	14967.4	14967.4	14967.4	14967.4	14967.4	14967.4	14967.4	
S11+Me	alpha	13728.8	13728.8	13728.8	13728.8	13728.8	13728.8	13728.8	13728.8	13728.8	13728.8	13728.8	13728.8	13728.8	13728.8	13728.8	13728.8	13728.8	13728.8	13728.8	13728.8	13728.8	13728.8	13728.8	13728.8	13728.8	13728.8	13728.8	13728.8	
S15		10138.6	10138.6	10138.6	10138.6	10138.6	10138.6	10138.6	10138.6	10138.6	10138.6	10138.6	10138.6	10138.6	10138.6	10138.6	10138.6	10138.6	10138.6	10138.6	10138.6	10138.6	10138.6	10138.6	10138.6	10138.6	10138.6	10138.6	10138.6	10138.6
L25		10694.4	10694.4	10694.4	10694.4	10694.4	10694.4	10694.4	10694.4	10694.4	10694.4	10694.4	10694.4	10694.4	10694.4	10694.4	10694.4	10694.4	10694.4	10694.4	10694.4	10694.4	10694.4	10694.4	10694.4	10694.4	10694.4	10694.4	10694.4	10694.4
HdeB		-	-	9066.2	9066.2	9066.2	9066.2	9066.2	9066.2	9066.2	9066.2	9066.2	9066.2	9066.2	9066.2	9066.2	9066.2	9066.2	9066.2	9066.2	9066.2	9066.2	9066.2	9066.2	9066.2	9066.2	9066.2	9066.2	9066.2	9066.2
H-NS		15409.4	15409.4	15425.4	15425.4	15409.4	15409.4	15409.4	15409.4	15409.4	15409.4	15409.4	15409.4	15409.4	15409.4	15409.4	15409.4	15409.4	15409.4	15409.4	15409.4	15409.4	15409.4	15409.4	15409.4	15409.4	15409.4	15409.4	15409.4	15409.4

Biomarker peaks allowing for discrimination among *Escherichia coli* O157, O26, and O111

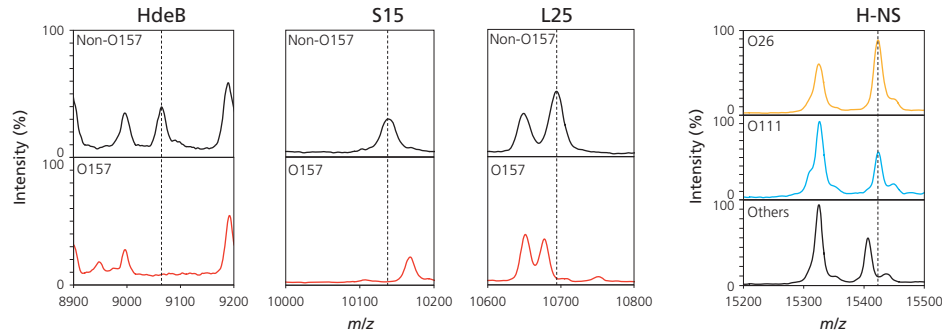

Fig. 2 Construction of the Database Used for Distinguishing Between Serotypes of Enterohemorrhagic *Escherichia coli* on the Basis of the S10-GERMS Method.

The results of discrimination using the cluster analysis function of Strain Solution Ver. 2 are shown in Fig. 3. The strains were broadly classified into the following four clusters: serotype O157 (cluster A), other serotypes (cluster B), serotypes O26 and O111 (cluster C), and serotype O157 (cluster D). The percentage rates of correct discrimination of the serotypes O157 (12 strains) and O26/O111 (13 strains) were 92% (11/12 strains) and 100% (13/13 strains), respectively. These findings showed a high degree of concordance with the results of the determination of serotypes using conventional methods. However, the 11 strains of the Shiga toxin-producing serotype O157 were classified with a 100% discrimination rate in the cluster of O157 (D), revealing that *Escherichia coli* O157 KB0341-2 (a non-shigatoxin producing strain), which was classified as "others" (cluster B), was different from the common O157 strains. In addition, O121 KB0747 had no HdeB peak; therefore, it was classified in the same group (group A) as GTC14550, a rare strain within the O157 serotype.

Fig. 3 shows the results of measurements conducted on colonies that were grown on tryptone soy agar medium, but similar results were also obtained from strains grown in various types of selective media. Of course, it is necessary to carry out verifications on a number of other samples as well; however, these results showed that our database and serotype discrimination by proteotyping seems to be effective for most wild-type strains. Another advantage of this method is that it allows for analyses to be conducted for colonies grown on selective culture media that are used in official methods as well as for those used in independent tests. As a result, this method can be applied to a wide variety of samples without having to change the conventional microbial testing process. The database described in this study is available as an option in the software Strain Solution Ver. 2. Further original databases can also be created depending on the purpose.

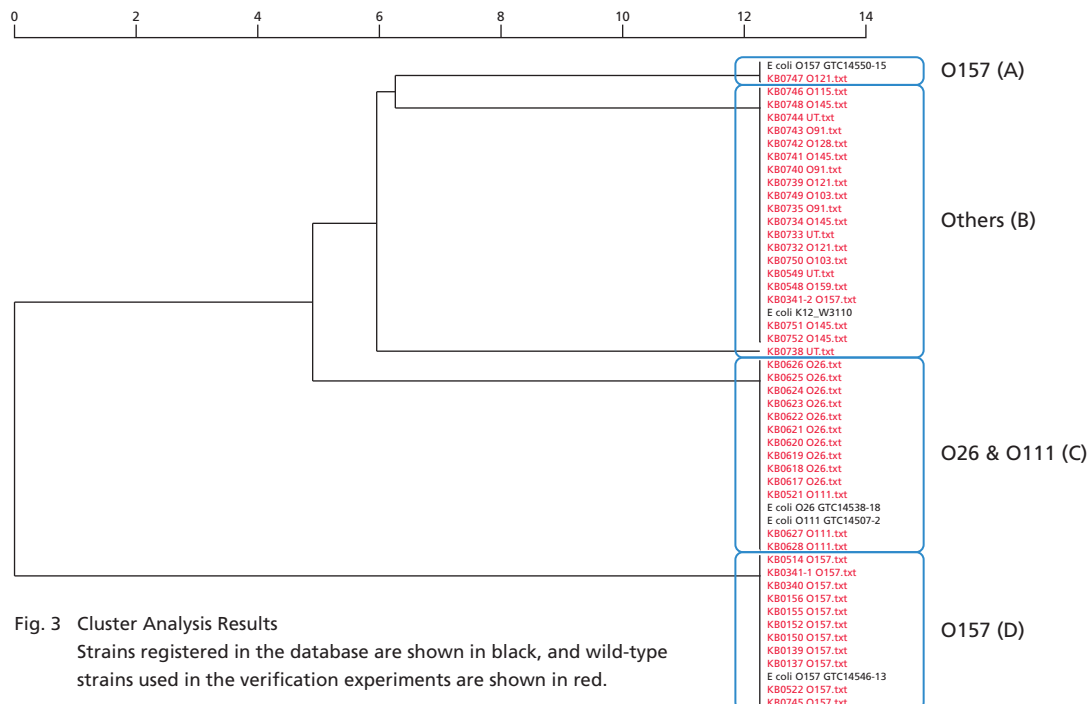
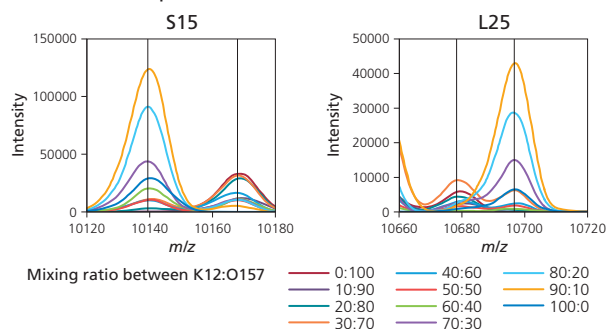

Fig. 3 Cluster Analysis Results
Strains registered in the database are shown in black, and wild-type strains used in the verification experiments are shown in red.

3-3. Mixed Samples

Here, *Escherichia coli* strain K12, which is a common strain used in experiments, was mixed at various ratios with the enterohemorrhagic *Escherichia coli* strain O157, and analyses were carried out using MALDI-TOF MS to verify whether Strain Solution Ver. 2 could identify the mixtures with three biomarkers as indicators. The results showed that when O157 was mixed at ratios of 10% to 80%, the software was able to correctly determine that the samples were mixtures of O157 and other *Escherichia coli* (K12 strains). When the samples were mixed at ratios of 40% to 70%, all three biomarkers were recognized as two mass peaks (Fig. 4) [3].

Biomarker mass peaks



Results from the Strain Solution

Mixing ratio	Hit biomarker			Results of identifications using the Strain Solution
	S15	L25	H-NS	
K12:O157	S15	L25	H-NS	
100:0	C	C	C	Other serotypes
90:10	A, C	C	A, C	O157 and other serotypes
80:20	A, C	C	A, C	O157 and other serotypes
70:30	A, C	C	A, C	O157 and other serotypes
60:40	A, C	A, C	A, C	O157 and other serotypes
50:50	A, C	A, C	A, C	O157 and other serotypes
40:60	A, C	A, C	A, C	O157 and other serotypes
30:70	A, C	A, C	A, C	O157 and other serotypes
20:80	A, C	A	A, C	O157 and other serotypes
10:90	A	A	A	O157
0:100	A	A	A	O157

A: Mass corresponding to the biomarker of the O157 type (*Escherichia coli*).
 C: Mass corresponding to the biomarker of other *Escherichia coli*

Fig. 4 Discrimination of Mixed Bacteria

References

- [1] Yudai Hotta, Kanae Teramoto, Hiroaki Sato, Hiromichi Yoshikawa, Akifumi Hosoda, and Hiroto Tamura: Classification of Genus *Pseudomonas* by MALDI-TOF MS Based on Ribosomal Protein Coding in *S10-spc-alpha* Operon at Strain Level. *J. Proteome Res.*, 2010, 9, 6722–6728.
- [2] Teruyo Ojima-Kato, Naomi Yamamoto, Mayumi Suzuki, Tomohiro Fukunaga, and Hiroto Tamura: Discrimination of *Escherichia coli* O157, O26 and O111 from other serovars by MALDI-TOF MS based on the *S10*-GERMS method. *PLoS ONE*, 2014, 9: e113458.
- [3] Teruyo Ojima-Kato, Naomi Yamamoto, Yoshio Iijima, and Hiroto Tamura: Assessing the performance of novel software Strain Solution on automated discrimination of *Escherichia coli* serotypes and their mixtures using matrix-assisted laser desorption ionization-time of flight mass spectrometry. *J. Microbiol. Methods*, 2015, 119, 233–238.

Strain Solution software was created on the basis of the results obtained from the Food Safety & Security Technology Development Project (group leader: Professor Hiroto Tamura of the Laboratory of Environmental Microbiology, Faculty of Agriculture, Meijo University), a "Knowledge Hub Aichi" core research project of Aichi Prefecture, which is in-turn based on ideas from the Meijo University and the National Institute of Advanced Industrial Science and Technology.

Similar to conventional microbial identification methods, bacteria normally need to be isolated prior to analysis with MALDI-TOF MS; however, if closely related bacterial strains are mixed together, they cannot be distinguished from each other through the standard fingerprinting method. Therefore, such functions of Strain Solution Ver. 2 are useful for monitoring human error when dealing with several closely related bacterial strains. This is beneficial for the management of the quality of starter bacterial strains used in the food industry, as well as culture collections for the management of their microbial collections.

4. Conclusion and Future Prospects

Due to the rapidity and simplicity of MALDI-TOF MS, its use and applications are rapidly expanding in various fields, including for microbial control such as in clinical settings, the pharmaceutical industry, and the food industry. Several studies have reported the use of MALDI-TOF MS for direct measurements of bacteria from blood culture media and food samples in recent years, and simpler analyses with higher accuracy are needed. The proteotyping technique using Strain Solution Ver. 2 based on the *S10*-GERMS method allows for distinguishing the small changes in the mass of selected biomarkers with high sensitivity, which has thus far not been considered important. Therefore, this method can potentially be utilized in a wide range of applications, not only in the discrimination of serotypes or strains of single microorganisms but also in the detailed analysis and diagnosis of the intestinal flora or bacterial mixtures that do not allow for single-strain isolation.

Acknowledgments

This work was financially supported by the Aichi Science and Technology Foundation (Japan) as a part of the "Technological Development Project for Food Safety and Security" under Knowledge Hub Aichi. Verification of wild-type strains was conducted with the cooperation of Kobe City's Environmental Health Research Institute.



Shimadzu Corporation
www.shimadzu.com/an/

For Research Use Only. Not for use in diagnostic procedures.

This publication may contain references to products that are not available in your country. Please contact us to check the availability of these products in your country.

The content of this publication shall not be reproduced, altered or sold for any commercial purpose without the written approval of Shimadzu. Company names, products/service names and logos used in this publication are trademarks and trade names of Shimadzu Corporation, its subsidiaries or its affiliates, whether or not they are used with trademark symbol "TM" or "®".

Third-party trademarks and trade names may be used in this publication to refer to either the entities or their products/services, whether or not they are used with trademark symbol "TM" or "®".

Shimadzu disclaims any proprietary interest in trademarks and trade names other than its own.

The information contained herein is provided to you "as is" without warranty of any kind including without limitation warranties as to its accuracy or completeness. Shimadzu does not assume any responsibility or liability for any damage, whether direct or indirect, relating to the use of this publication. This publication is based upon the information available to Shimadzu on or before the date of publication, and subject to change without notice.

Application
Data Sheet

No. 127A

GC-MS

Gas Chromatograph Mass Spectrometer

Simultaneous Analysis of 418 Pesticides
Utilizing Smart SIM

The selected ion monitoring (SIM) method is capable of high-sensitivity measurements, so it is utilized for the analysis of trace components, such as residual pesticides in foods. With existing SIM conditions settings, however, the number of components is limited to a few hundred, and configuring the settings is difficult. In addition, when many ions are monitored simultaneously, the sensitivity is reduced. Smart SIM was developed to solve these problems. This article provides an example of its application to the simultaneous analysis of 418 pesticides.

Smart SIM

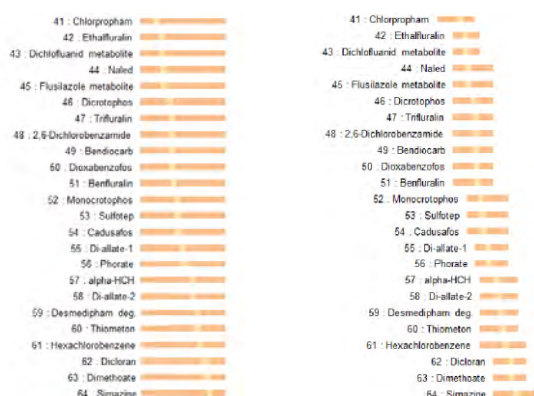

Fig. 1: SIM Measurement Time Program
(Left: Group Measurement Method;
Right: Measurement Method Using Smart SIM)
By using Smart SIM, the optimal time program
synchronized to the retention times for each
compound can be created.

As shown in Fig. 1, with the existing SIM method, a time program must be configured in order to collect data on designated ions only for designated time periods. If the number of target compounds exceeds 100, this time program becomes very complex. With the existing group measurement method (Fig. 1, left), configuring the settings is difficult, and sufficient sensitivity is not obtained because many ions are measured simultaneously.

In this example, a method was created utilizing Smart SIM, which automatically creates the optimal time program synchronized to the retention times for each compound (Fig. 1, right), and the sensitivity and accuracy were then evaluated.

In order to create a method with Smart SIM, the first step is to prepare the Smart Database (Fig. 2), which can be created simply by importing an existing method file if there is one. The retention index information is also registered; therefore, by utilizing the AART function with Smart Database, retention times can be estimated and adjusted without analyzing standard samples. Here, a method was created utilizing retention times adjusted with the AART function. The analytical conditions are indicated in Table 1.

(For details on retention time adjustments utilizing retention indices, check the Shimadzu website. <http://www.an.shimadzu.co.jp/gcms/gcmssol/sol1.htm>)

Serial#	Type	Acq. Mode	Compound Name (E)	Ret. Index 1	Ret. Time	Ion1			Ion2			Ion3		
						Typi	m/z	Rati	Typi	m/z	Rati	Typi	m/z	Rati
41	Target	SIM	Chlorpropham	1866	10.228	T	213.0	100.00	Ref.1	127.0	219.30	154.0	56.14	
42	Target	SIM	Ethalfuralin	1875	10.324	T	276.0	100.00	Ref.1	316.0	78.70	333.0	23.15	
43	Target	SIM	Dichlofluanid metabolite	1676	10.334	T	200.0	100.00	Ref.1	92.0	126.69	108.0	22.13	
44	Target	SIM	Naled	1678	10.355	T	185.0	100.00	Ref.1	109.0	595.24	145.0	152.38	
45	Target	SIM	Flusilazole metabolite	1678	10.355	T	235.0	100.00	Ref.1	250.0	14.80	155.0	9.60	
46	Target	SIM	Diclotophos	1688	10.461	T	127.0	100.00	Ref.1	193.0	9.60	237.0	6.80	
47	Target	SIM	Trifluralin	1691	10.493	T	306.0	100.00	Ref.1	264.0	88.68	335.0	8.18	
48	Target	SIM	2,6-Dichlorobenzamide	1691	10.493	T	173.0	100.00	Ref.1	175.0	63.60	169.0	44.00	
49	Target	SIM	Dioxabenzofos (Salithion)	1692	10.504	T	216.0	100.00	Ref.1	183.0	45.60	201.0	26.60	
50	Target	SIM	Benfluralin	1695	10.535	T	282.0	100.00	Ref.1	264.0	24.40	283.0	12.40	
51	Target	SIM	Monocrotophos	1700	10.588	T	127.0	100.00	Ref.1	97.0	18.00	192.0	10.00	
52	Target	SIM	Sulfotep	1702	10.609	T	322.0	100.00	Ref.1	238.0	39.60	266.0	39.20	
53	Target	SIM	Cadusafos	1703	10.619	T	159.0	100.00	Ref.1	158.0	69.20	270.0	5.20	
54	Target	SIM	Di-allate-1	1711	10.702	T	234.0	100.00	Ref.1	236.0	39.73	86.0	254.79	
55	Target	SIM	Phorate	1713	10.723	T	260.0	100.00	Ref.1	231.0	54.29	75.0	714.29	

Fig. 2: Smart Database Screen

Table 1: Analytical Conditions

GC-MS:	GCMS-QP2020	MS
Column:	SH-Rtx-5MS (30 m long, 0.25 mm I.D., df = 0.25 μm) (Shimadzu GLC, P/N: 221-75855-30)	Interface Temperature: 250 °C
Glass Insert:	Sky Single Taper Inlet Liner w/ Wool (Shimadzu GLC, P/N: 23336.5)	Ion Source Temperature: 200 °C
GC		Ionization Mode: EI
Injection Port Temperature:	250 °C	Measurement mode: SIM
Column Oven Temperature:	50 °C (1.0 min) → (25 °C /min) → 125 °C → (10 °C/min) → 300 °C (15 min)	Loop Time: 0.5 sec
Injection Mode:	Splitless	
High-Voltage Injection:	250 kPa (1.5 min)	
Injection Volume:	2 μL	
Carrier Gas Control:	Linear velocity (47.2 cm/sec)	

Results

To create the sample, polyethylene glycol 300 was added as a pseudo matrix to a pesticides standard mixed solution to reach a concentration of 200 µg/mL. Fig. 3 shows the SIM chromatogram for the 100 ng/ml standard solution, and Fig. 4 shows the SIM chromatograms for each pesticide, as well as the %RSD and S/N ratios. Fig. 5 shows the results for the same sample, measured with a 244 component simultaneous analysis method via the existing group measurement method.

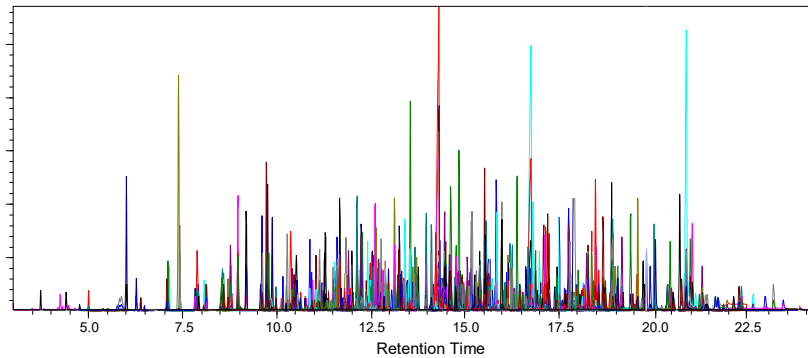

Fig. 3: SIM Chromatogram for a 100 ng/mL Pesticides Standard Mixed Solution

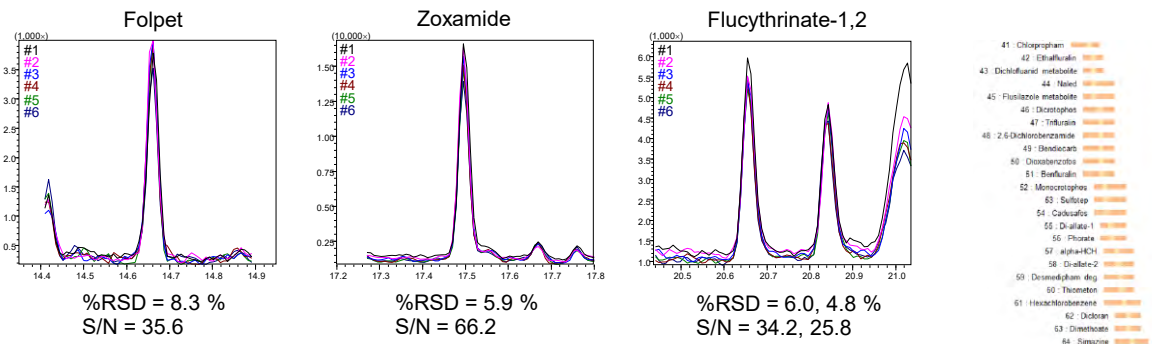

Fig. 4: SIM Chromatograms, %RSD and Average S/N Ratios (n=6) for 2 ng/mL Sample

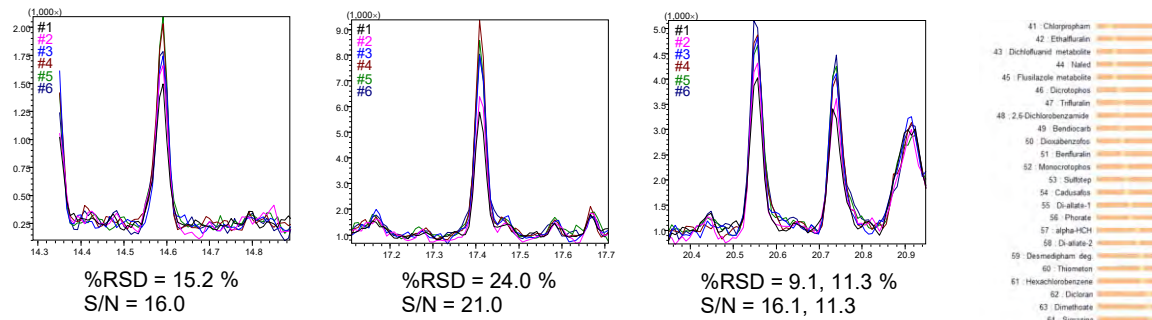

Fig. 5: SIM Chromatograms, %RSD and Average S/N Ratios (n=6) for 2 ng/mL Sample with the Group Measurement Method

Using Smart SIM, a method was easily created that enables the simultaneous analysis of more than 400 components. In addition, it was evident that the analysis could be performed with higher sensitivity and higher accuracy in comparison to a method configured with the existing group measurement method. Further, as shown in Fig. 6, for more than 90 % of the 2 ng/mL components, the %RSD was 10 % max., indicating a highly accurate analysis.

Furthermore, with the existing method, to ensure sensitivity and accuracy, when the number of components exceeds 200, multiple measurement cycles are performed by dividing the method into several sections. In contrast, Smart SIM allows obtaining the results with a single measurement. This can significantly reduce the analysis time. In addition, since the number of analyses per sample is reduced, so too are the frequency of maintenance and the cost, which will significantly improve laboratory productivity.

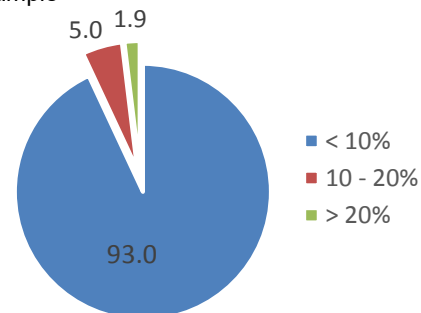

Fig. 6: %RSD Distribution for 2 ng/mL Sample (Excluding oxpoconazole-formyl deg., which were not detected.)



Shimadzu Corporation

www.shimadzu.com/an/

For Research Use Only. Not for use in diagnostic procedures.

This publication may contain references to products that are not available in your country. Please contact us to check the availability of these products in your country.

The content of this publication shall not be reproduced, altered or sold for any commercial purpose without the written approval of Shimadzu. Company names, products/service names and logos used in this publication are trademarks and trade names of Shimadzu Corporation, its subsidiaries or its affiliates, whether or not they are used with trademark symbol "TM" or "®".

Third-party trademarks and trade names may be used in this publication to refer to either the entities or their products/services, whether or not they are used with trademark symbol "TM" or "®". Shimadzu disclaims any proprietary interest in trademarks and trade names other than its own.

The information contained herein is provided to you "as is" without warranty of any kind including without limitation warranties as to its accuracy or completeness. Shimadzu does not assume any responsibility or liability for any damage, whether direct or indirect, relating to the use of this publication. This publication is based upon the information available to Shimadzu on or before the date of publication, and subject to change without notice.

Fully automated derivatization and quantification of Glyphosate and AMPA in beer using a standard UHPLC-MS/MS system

ASMS 2017 MP205

Julia Sander¹, Anja Grüning¹, Robert Ludwig¹,
Philipp Jochems¹
1 Shimadzu Europa, Albert-Hahn-Str. 6-10,
47269 Duisburg, Germany

Fully automated derivatization and quantification of Glyphosate and AMPA in beer using a standard UHPLC-MS/MS system

Introduction

Glyphosate is currently one of the most common pesticides used worldwide. In spite of its approval by regulatory bodies all over the world, the concern about its harm to humans and the environment persists. Therefore, the strict control of Glyphosate and its metabolite

Aminomethylphosphonic acid (AMPA) in food and environment is mandatory.

The chromatography of glyphosate is challenging due to its high polarity. In order to overcome this, there exists a

well-established method including a derivatization step with 9-fluorenylmethyl chloroformate (FMOC) followed by LCMS analysis.

Here we report a fully automated derivatization followed by LC-MS/MS analysis of beer samples. The instrumental set-up does not require any additional hardware for sample pretreatment but uses the built-in pretreatment function of the autosampler.

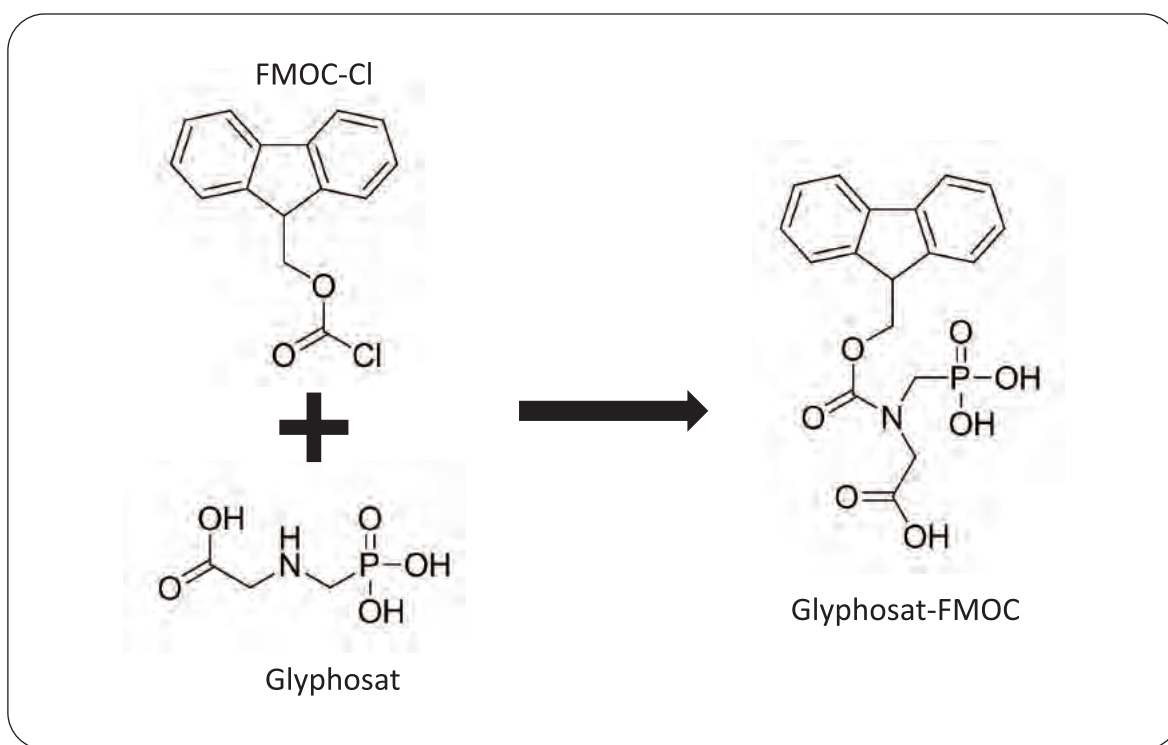

Figure 1 Derivatization of Glyphosat with FMOC

Methods and Materials

Sample Preparation

After precipitation with methanol (50:50) and centrifugation the beer samples were set into the autosampler.

Fully automated derivatization and quantification of Glyphosate and AMPA in beer using a standard UHPLC-MS/MS system

UHPLC method

Instrument	: Nexera UHPLC, Shimadzu
Column	: Gemini 5 µm C18, 150 x 2 mm
Mobile phase A	: 2 mM NH ₄ HCO ₃ , pH 9.5
B	: acetonitrile
Flow rate	: 0.4 mL/min
Time program	: B conc. 5%(0 min) -50%(7 min) - 95%(7.01-12min) – 5% (12.01 min – 15 min)
Injection vol.	: 50 µL
Column temperature	: 35 °C

MS conditions

Instrument	: LCMS-8060, Shimadzu
Ionization	: pos/neg ESI
Nebulizing gas	: 3 L/min
Heating gas	: 15 L/min
Drying gas	: 5 L/min
Interface temperature	: 325 °C
DL temperature	: 150 °C
Heat block temperature	: 400 °C
CID gas	: 270 kPa
Interface voltage	: 4 kV/ -3 kV

Results

Method development for automatization of derivatization

The addition of internal standards as well as the derivatization of Glyphosate and AMPA with FMOC was done fully automated by the autosampler SIL-30AC within 15 minutes. After derivatization the sample was injected directly to the LC-MS/MS and analyzed accordingly.

Fully automated derivatization and quantification of Glyphosate and AMPA in beer using a standard UHPLC-MS/MS system

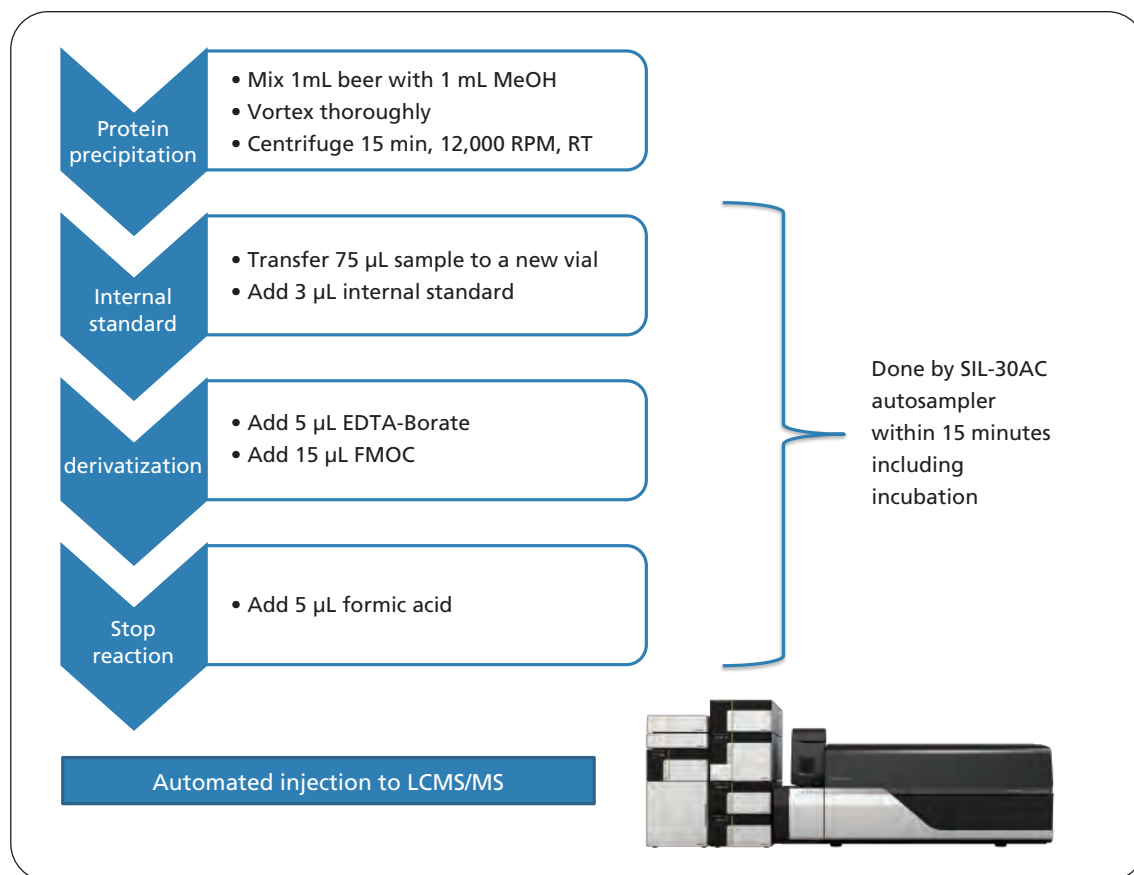

Figure 2: Workflow of sample pretreatment. Addition of internal standard as well as derivatization is done by the autosampler.

Due to overlapping sample pretreatment functionality, the next sample was already pretreated during the on-going analysis in order to maximize sample throughput. Except for the first and the last sample, the total time per sample for automated pretreatment and analysis can be reduced to 15 minutes.

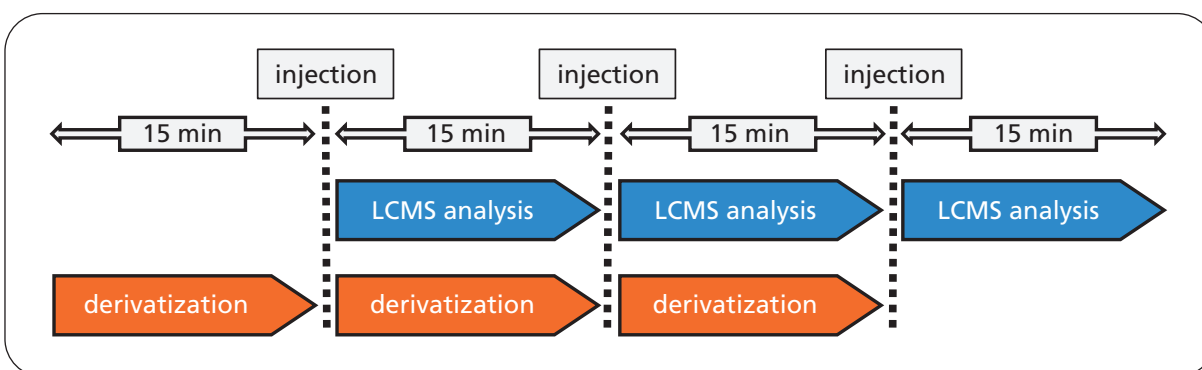

Figure 3: Overlapping sample pretreatment and analysis done by SIL-30AC. Total time per sample is reduced to 15 minutes.

Fully automated derivatization and quantification of Glyphosate and AMPA in beer using a standard UHPLC-MS/MS system

Table 1: QC sample results

Batch	Glyphosate-FMOC						AMPA-FMOC					
	QC 3 ng/mL		QC 15 ng/mL		QC 75 ng/mL		QC 3 ng/mL		QC 15 ng/mL		QC 75 ng/mL	
	Conc.	Acc. %	Conc.	Acc. %	Conc.	Acc. %	Conc.	Acc. %	Conc.	Acc. %	Conc.	Acc. %
A	2,60	86,5	14,89	99,3	74,14	98,9	4,76	158,5	15,66	104,4	80,80	107,7
A	2,87	95,7	14,96	99,7	81,22	108,3	2,71	90,3	16,16	107,7	85,65	114,2
A	3,41	113,5	15,14	100,9	77,94	103,9	3,15	105,0	15,99	106,6	81,38	108,5
B	2,81	93,7	16,00	106,7	79,18	105,6	4,11	137,0	15,33	102,2	78,40	104,5
B	3,20	106,7	16,08	107,2	76,19	101,6	3,49	116,2	15,20	101,3	82,23	109,6
B	3,46	115,3	15,42	102,8	83,74	111,6	3,02	100,8	15,66	104,4	84,15	112,2
C	2,82	93,9	14,94	99,6	67,88	90,5	3,48	115,9	15,48	103,2	83,97	112,0
C	2,73	91,1	15,67	104,5	76,89	102,5	3,25	108,3	16,55	110,3	79,72	106,3
C	3,27	109,0	15,87	105,8	84,87	113,2	3,38	112,6	16,87	112,5	82,65	110,2
D	3,19	106,2	16,42	109,5	82,82	110,4	2,73	90,9	16,85	112,3	75,46	100,6
D	3,33	110,9	16,00	106,7	85,29	113,7	3,31	110,4	14,35	95,7	72,06	96,1
D	3,23	107,6	17,14	114,3	84,74	113,0	3,55	118,3	15,50	103,3	75,97	101,3
Mean	3,08		15,71		79,57		3,41		15,80		80,20	
SD	0,2915		0,6816		5,2735		0,5676		0,7306		4,0615	
RSD (%)	9,5		4,3		6,6		16,6		4,6		5,1	
												extrapolated

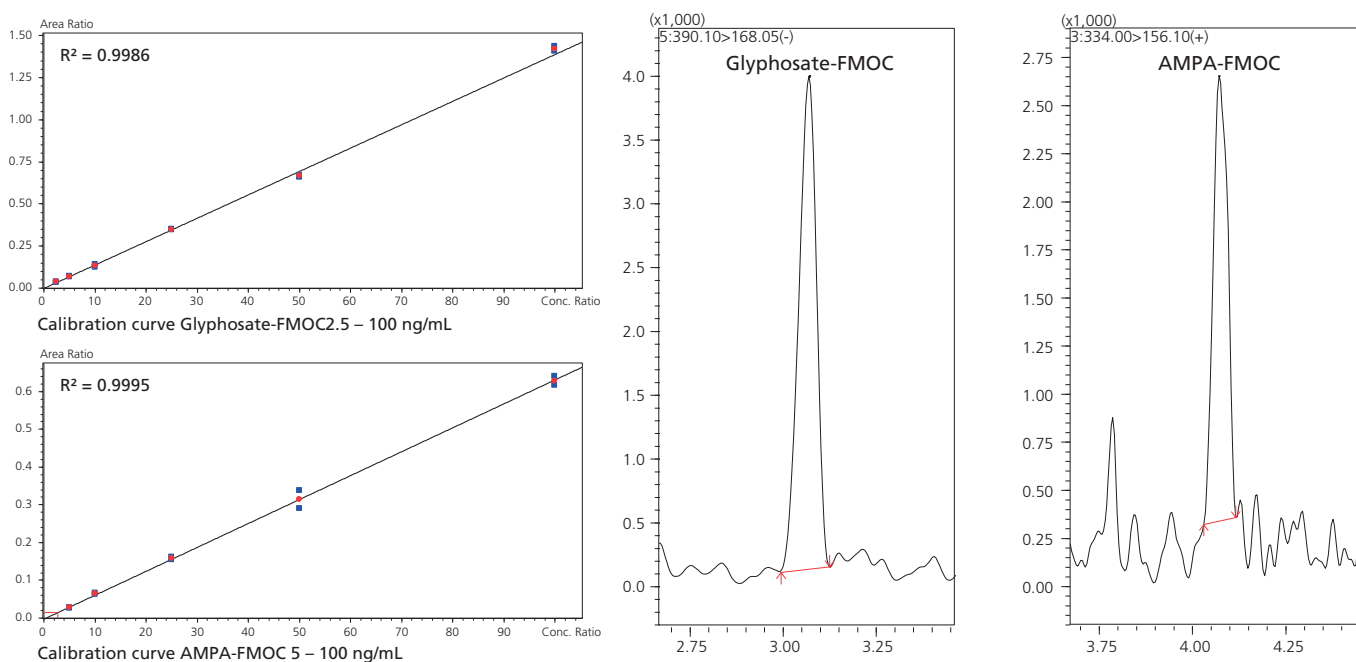

Figure 4: Chromatogram of Glyphosate-FMOC (2.5 ng/mL) and AMPA-FMOC (5 ng/mL) at their respective LOQs and calibration curves.

Fully automated derivatization and quantification of Glyphosate and AMPA in beer using a standard UHPLC-MS/MS system

Quantitative Analysis of 40 beer samples

A total of 40 commercially available beer samples were analysed. Among these samples there were 21 samples of beer brewed according to Pilsener style, 3 samples of organic beer, 10 samples of other types of beer and 6 samples of alcohol-free beers or non alcoholic beer mix drinks. All samples were analysed in duplicate in two consecutive runs. While Glyphosate was detected in 60 % of all samples its metabolite AMPA was below LOQ in all samples.

Table 2: Analysis of beer samples

	Glyphosat-FMOC					AMPA-FMOC	
	Conc. ng/mL	Conc. ng/mL	Mean	SD	% RSD	Conc. ng/mL	Conc. ng/mL
Pils							
Sample 1	<LOQ	<LOQ				<LOQ	<LOQ
Sample 2	8,37	8,95	8,7	0,4087	4,7	<LOQ	<LOQ
Sample 3	20,85	20,28	20,6	0,4038	2,0	<LOQ	<LOQ
Sample 4	<LOQ	<LOQ				<LOQ	<LOQ
Sample 5	6,78	6,57	6,7	0,1549	2,3	<LOQ	<LOQ
Sample 6	11,34	12,08	11,7	0,5240	4,5	<LOQ	<LOQ
Sample 7	<LOQ	<LOQ				<LOQ	<LOQ
Sample 8	8,61	9,41	9,0	0,5706	6,3	<LOQ	<LOQ
Sample 9	4,74	4,63	4,7	0,0834	1,8	<LOQ	<LOQ
Sample 10	<LOQ	<LOQ				<LOQ	<LOQ
Sample 11	10,81	12,03	11,4	0,8627	7,6	<LOQ	<LOQ
Sample 12	13,95	14,65	14,3	0,4943	3,5	<LOQ	<LOQ
Sample 13	33,06	27,61	30,3	3,8509	12,7	<LOQ	<LOQ
Sample 14	20,29	18,68	19,5	1,1377	5,8	<LOQ	<LOQ
Sample 15	25,28	22,09	23,7	2,2578	9,5	<LOQ	<LOQ
Sample 16	3,23	2,93	3,1	0,2171	7,1	<LOQ	<LOQ
Sample 17	3,66	3,48	3,6	0,1308	3,7	<LOQ	<LOQ
Sample 18	5,25	5,65	5,4	0,2807	5,2	<LOQ	<LOQ
Sample 19	2,67	2,93	2,8	0,1881	6,7	<LOQ	<LOQ
Sample 20	3,87	4,39	4,1	0,3698	9,0	<LOQ	<LOQ
Sample 21	<LOQ	<LOQ				<LOQ	<LOQ
Organic Beer							
Sample 22	<LOQ	<LOQ				<LOQ	<LOQ
Sample 23	<LOQ	<LOQ				<LOQ	<LOQ
Sample 24	<LOQ	<LOQ				<LOQ	<LOQ
Others							
Sample 25	2,79	3,26	3,0	0,3323	11,0	<LOQ	<LOQ
Sample 26	4,61	4,15	4,4	0,3260	7,4	<LOQ	<LOQ
Sample 27	<LOQ	<LOQ				<LOQ	<LOQ
Sample 28	<LOQ	<LOQ				<LOQ	<LOQ
Sample 29	2,52	<LOQ				<LOQ	<LOQ
Sample 30	<LOQ	<LOQ				<LOQ	<LOQ
Sample 31	<LOQ	<LOQ				<LOQ	<LOQ
Sample 32	8,06	7,27	7,7	0,5621	7,3	<LOQ	<LOQ
Sample 33	11,19	11,57	11,4	0,2737	2,4	<LOQ	<LOQ
Sample 34	<LOQ	<LOQ				<LOQ	<LOQ
Non alcoholic							
Sample 35	4,75	4,47	4,6	0,1952	4,2	<LOQ	<LOQ
Sample 36	16,05	15,71	15,9	0,2454	1,5	<LOQ	<LOQ
Sample 37	<LOQ	<LOQ				<LOQ	<LOQ
Sample 38	<LOQ	<LOQ				<LOQ	<LOQ
Sample 39	<LOQ	<LOQ				<LOQ	<LOQ
Sample 40	2,50	2,85	2,7	0,2482	9,3	<LOQ	<LOQ

Fully automated derivatization and quantification of Glyphosate and AMPA in beer using a standard UHPLC-MS/MS system

Conclusions

- Fully automated FMOC-derivatization of Glyphosate and AMPA within 15 minutes.
- No additional hardware required
- Sample derivatization and internal standard addition done by autosampler SIL-30AC
- Maximized sample throughput due to overlapping sample pretreatment functionality
- Robust and reliable method for Glyphosate and AMPA even in a complex matrix like beer

The products and applications in this presentation are intended for Research Use Only (RUO). Not for use in diagnostic procedures.

First Edition: June, 2017

For Research Use Only. Not for use in diagnostic procedures.

This publication may contain references to products that are not available in your country. Please contact us to check the availability of these products in your country.

The content of this publication shall not be reproduced, altered or sold for any commercial purpose without the written approval of Shimadzu. Company names, products/service names and logos used in this publication are trademarks and trade names of Shimadzu Corporation, its subsidiaries or its affiliates, whether or not they are used with trademark symbol "TM" or "®".

Third-party trademarks and trade names may be used in this publication to refer to either the entities or their products/services, whether or not they are used with trademark symbol "TM" or "®".

Shimadzu disclaims any proprietary interest in trademarks and trade names other than its own.

The information contained herein is provided to you "as is" without warranty of any kind including without limitation warranties as to its accuracy or completeness. Shimadzu does not assume any responsibility or liability for any damage, whether direct or indirect, relating to the use of this publication. This publication is based upon the information available to Shimadzu on or before the date of publication, and subject to change without notice.

Determination of pyrrolizidine alkaloids in plant material using on-line SPE coupled to UHPLC-MS/MS

ASMS 2018 WP-249

Sven Vedder¹, Anja Grüning¹, Julia Sander¹
1 Shimadzu Europa, Albert-Hahn-Str. 6-10,
47269 Duisburg, Germany

Determination of pyrrolizidine alkaloids in plant material using on-line SPE coupled to UHPLC-MS/MS

Introduction

Pyrrolizidine alkaloids (PAs) are secondary plant metabolites that are supposed to be carcinogenic and genotoxic. They occur mainly in plants of the Boraginaceae, Asteraceae and Fabaceae families. They contain a pyrrolizidine core and make up a large group of heterocyclic alkaloids mainly derived from the 4 Necin bases platynecine, retronecine, heliotridin and ontonecine. PAs are hepatotoxic if they carry a 1,2-double bond as well as an esterified side chain which is a structural prerequisite for their hepatic activation. Plant food and beverage, phytopharmaceuticals or even

animal feed can easily be contaminated with PAs and enter the food chain. Currently there are discussions on possible regulatory measures caused by the presence of PAs in honey, tea, herbal infusions and food supplements. Existing methods include laborious sample preparation, e.g. solid-liquid extraction followed by solid phase extraction for clean-up. Here we report an on-line SPE UHPLC-MS/MS method, which overcomes the difficulties of combining low pressure online SPE with high pressure analytical UHPLC.

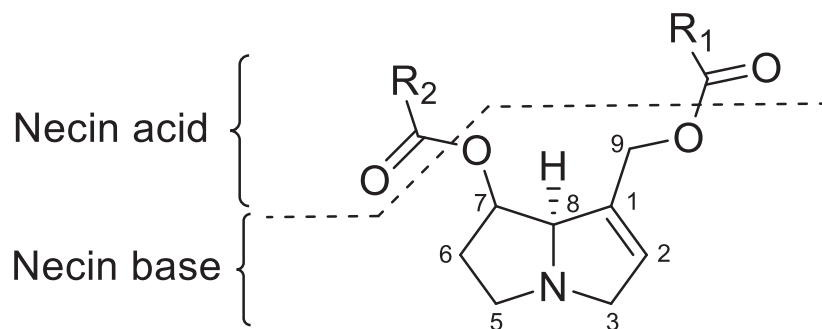

Figure 1 General structure of pyrrolizidine alkaloids

Methods and Materials

Sample Preparation

Tea samples were extracted twice with 0.05M sulfuric acid by sonication. Before centrifugation the pH of the combined extracts was adjusted with ammonium hydroxide.

UHPLC method

Instrument	: Nexera UHPLC, Shimadzu
Column	: Shim-pack XR-ODS III, 150 mm x 2.0 mm, 2.2 μm, Shimadzu
Mobile phase A	: 5 mM ammonium formate + 0.1% formic acid
B	: methanol + 5 mM ammonium formate + 0.1% formic acid
Flow rate	: 0.4 mL/min
Time program	: B conc. 1% (0-1.6 min) -50% (14.6 min) – 71.5% (18.1 min) – 95% (18.2 min – 20.2 min) -1% (20.3 min – 25 min)
Column temperature	: 30 °C

Determination of pyrrolizidine alkaloids in plant material using on-line SPE coupled to UHPLC-MS/MS

Online SPE method

Column	: EVOLUTE® EXPRESS ABN, 30 x 2.1 mm, Biotage
Mobile phase	: 5 mM ammonium formate + 0.1% formic acid for sample loading methanol / H ₂ O + 5 mM ammonium formate + 0.1% formic acid methanol, isopropanol for washing of SPE column
Flow rate	: 0.2 / 2 mL/min
Injection vol.	: 50 µL
Column temperature	: RT

MS conditions

Instrument	: LCMS-8060, Shimadzu
Ionization	: pos ESI
Nebulizing gas	: 3 L/min
Heating gas	: 15 L/min
Drying gas	: 5 L/min
Interface temperature	: 400 °C
DL temperature	: 300 °C
Heat block temperature	: 400 °C
CID gas	: 270 kPa
Interface voltage	: 1 kV

Result

Method development of the online SPE

The neutralized and centrifuged tea extract samples were put into the autosampler and transferred to the on-line SPE column using an aqueous solution. After washing the sample was eluted with only 10 µL solvent and trapped into a loop. By switching the loop the eluted sample was transferred to the analytical column. A binary gradient

separated the PAs for quantification. Due to this hardware set-up UHPLC with high backpressure and on-line SPE which is pressure limited were successfully combined. By careful fine-tuning of the SPE elution and the chromatographic conditions the separation of critical peak pairs could be maintained.

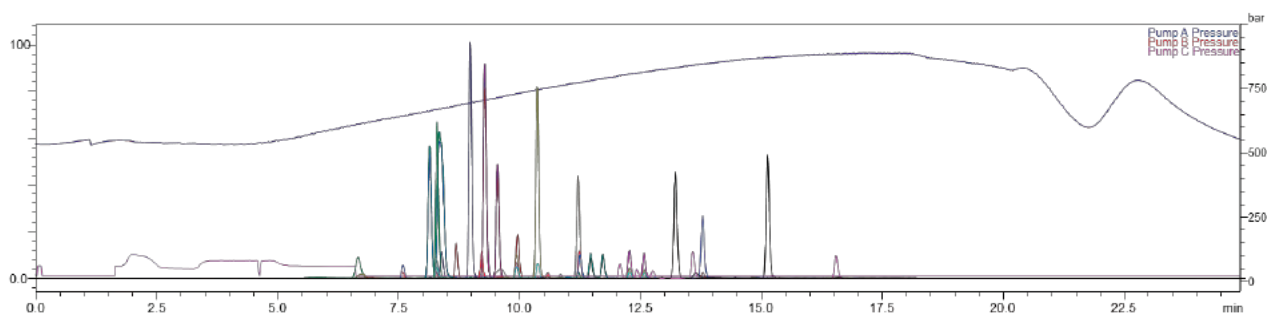

Figure 2 Typical chromatogram of pyrrolizidine alkaloids in tea matrix including the separated pressure curves of the analytical column (Pump A and B pressure) and the online SPE column (Pump C pressure)

Determination of pyrrolizidine alkaloids in plant material using on-line SPE coupled to UHPLC-MS/MS

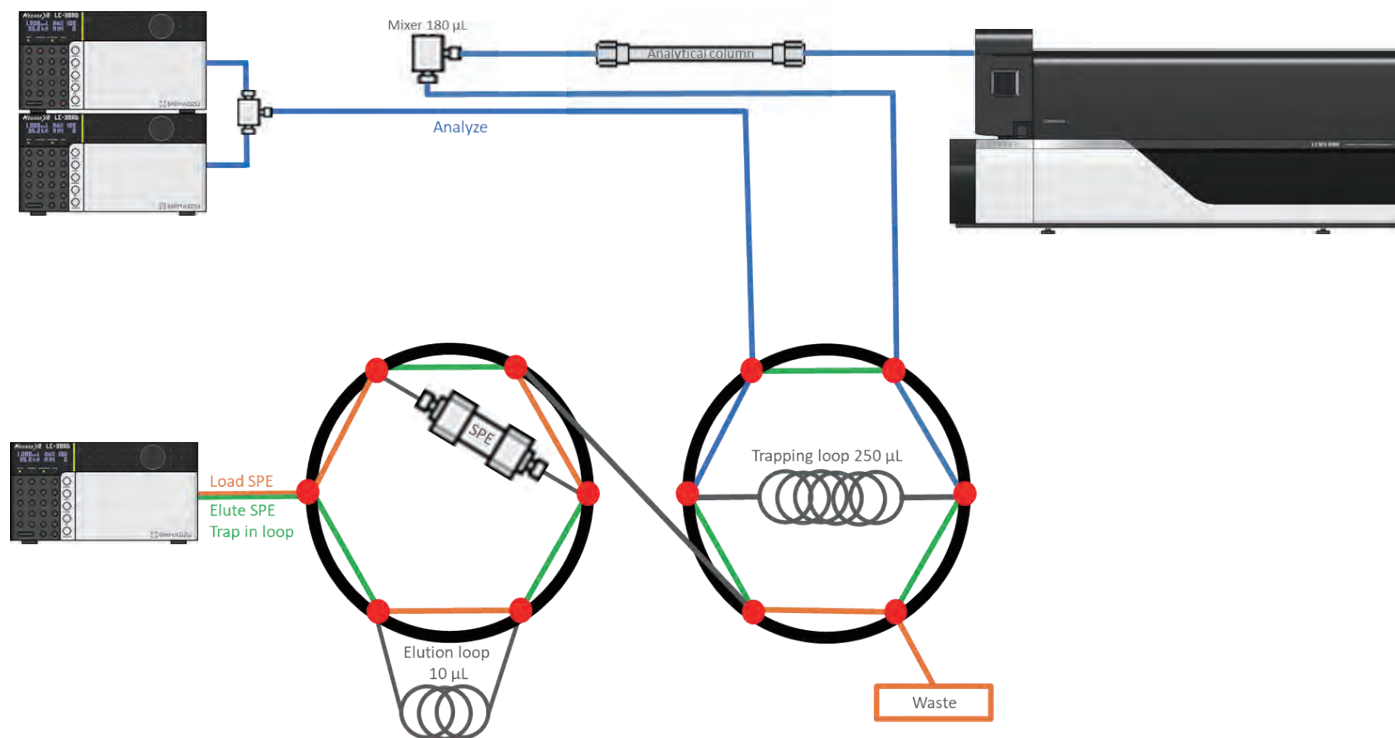

Figure 3 Setup of the on-line SPE analytical system

Quantitative Analysis of tea samples

By using the reported instrument set-up, analysis and thus the quantification of 16 PAs and 14 of their related N-Oxides could be performed. Calibration curves in different tea matrices (black tea, green tea and herbal tea) determined in duplicate showed good precision and accuracy and even in a complex matrix like tea we were able to easily quantify the PAs in at least the range of 10 to 400 µg/kg. This is comparable to the established methods

using manual sample preparation. For all analytes, weighted regression resulting in r^2 0.99 could be achieved, with $S/N > 10$ for LLOQ levels.

Exemplary calibration curves obtained for the 30 compounds are shown in Figure 4, Chromatograms of exemplary LLOQs are shown in Figure 5, the LLOQs which could be achieved in the different tea matrices are shown in Table 1.

Determination of pyrrolizidine alkaloids in plant material using on-line SPE coupled to UHPLC-MS/MS

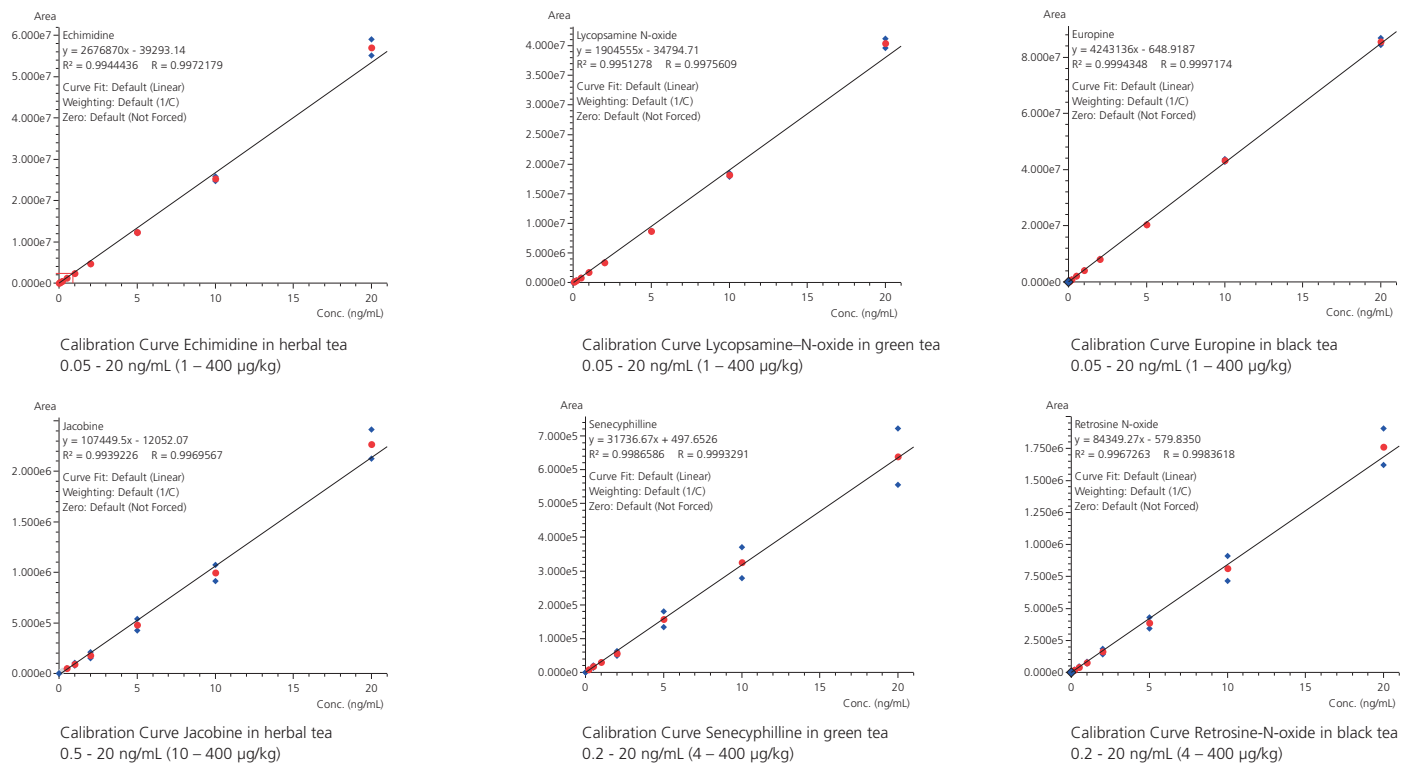

Figure 4 Exemplary calibration curves in different tea matrices

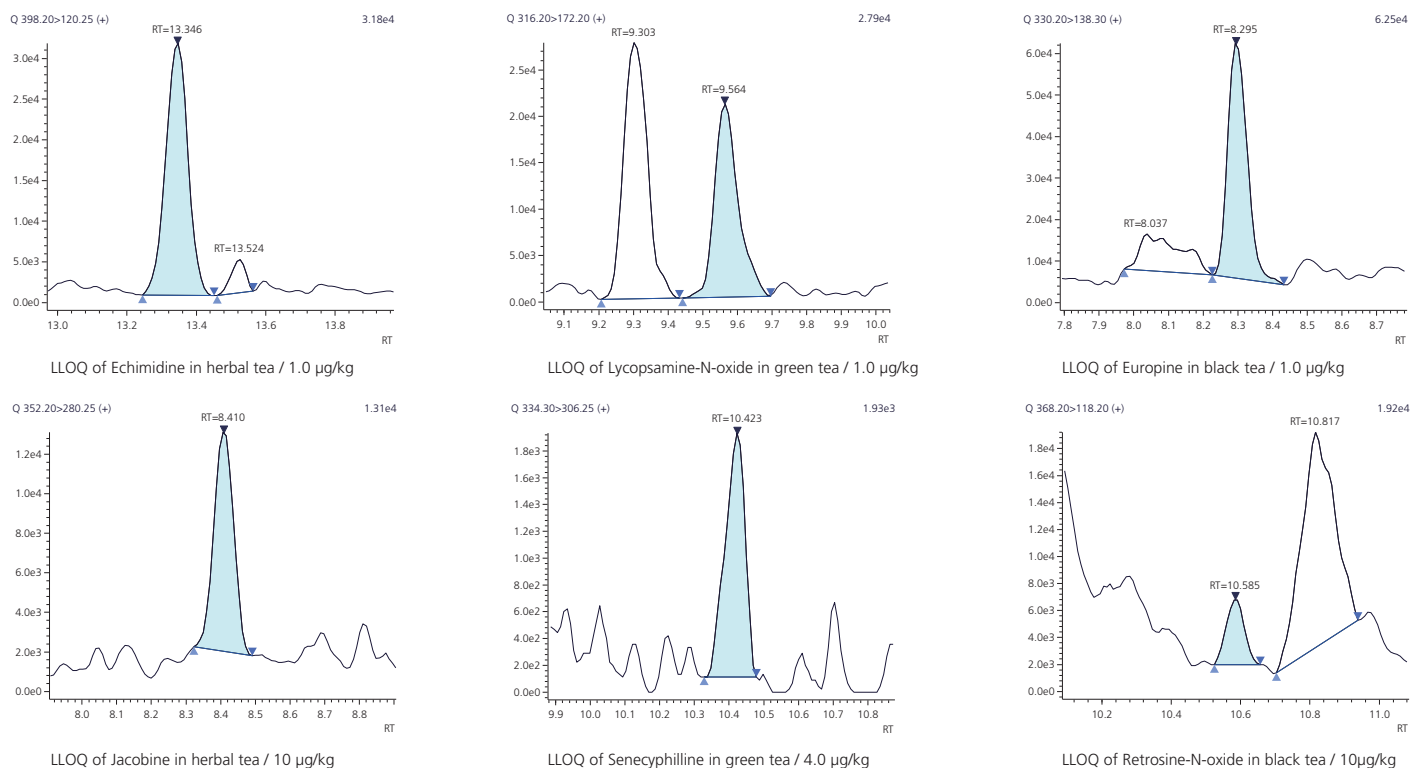

Figure 5 Exemplary chromatograms of LLOQs different tea matrices

Determination of pyrrolizidine alkaloids in plant material using on-line SPE coupled to UHPLC-MS/MS

Table 1 LLOQs of the pyrrolizidine alkaloids in different tea matrices

	Black tea LLOQ		Green tea LLOQ		Herbal tea LLOQ	
	ng/mL	µg/kg	ng/mL	µg/kg	ng/mL	µg/kg
Echimidine	0.05	1.0	0.05	1.0	0.05	1.0
Echimidine-N-oxide	0.05	1.0	0.05	1.0	0.05	1.0
Erucifoline	0.20	4.0	0.20	4.0	0.50	10.0
Erucifoline-N-Oxide	0.10	2.0	0.20	4.0	0.10	2.0
Europine	0.05	1.0	0.05	1.0	0.05	1.0
Europine -N-Oxide	0.05	1.0	0.05	1.0	0.05	1.0
Heliotrine	0.05	1.0	0.05	1.0	0.05	1.0
Heliotrine N-oxide	0.05	1.0	0.05	1.0	0.05	1.0
Intermedine	0.05	1.0	0.05	1.0	0.05	1.0
Intermedine N-oxide / Indicine N-oxide	N.A	N.A	0.05	1.0	0.05	1.0
Jacobine	0.20	4.0	0.50	10.0	0.50	10.0
Jacobine N-oxide	0.05	1.0	0.10	2.0	0.10	2.0
Lasiocarpine	0.05	1.0	0.10	2.0	0.05	1.0
Lasiocarpine N-oxide	0.10	2.0	0.10	2.0	0.05	1.0
Lycopsamine / Indicine	N.A	N.A	0.05	1.0	0.05	1.0
Lycopsamine N-oxid	0.05	1.0	0.05	1.0	0.05	1.0
Monocrotaline	0.50	10.0	0.20	4.0	0.50	10.0
Monocrotaline-N-oxide	0.10	2.0	0.10	2.0	0.10	2.0
Retrosine	0.10	2.0	0.05	1.0	0.10	2.0
Retrosine N-oxide	0.20	4.0	0.50	10.0	0.50	10.0
Senecionine	0.05	1.0	0.50	10.0	0.50	10.0
Senecionine N-oxide	0.05	1.0	0.20	4.0	0.50	10.0
Senecyphilline	0.10	2.0	0.20	4.0	0.50	10.0
Senecyphilline N-oxide	0.05	1.0	0.20	4.0	0.10	2.0
Senecivernine	0.20	4.0	0.50	10.0	0.20	4.0
Senecivernine N-oxide	0.05	1.0	0.20	4.0	0.10	2.0
Senkirkine	0.05	1.0	0.05	1.0	0.05	1.0
Trichodesmine	0.05	1.0	0.10	2.0	0.20	4.0

A total of 29 commercially available tea samples were analyzed. Among these samples there were 6 samples of green tea, 10 samples of black tea and 13 samples of herbal tea. In 59% of all analyzed tea samples one or more

of the pyrrolizidine alkaloids could be detected above their LLOQ. 3 out of 6 green tea samples, 5 out of 10 black tea samples and 9 out of 13 herbal tea samples were contaminated with pyrrolizidine alkaloids.

Determination of pyrrolizidine alkaloids in plant material using on-line SPE coupled to UHPLC-MS/MS

Conclusions

An on-line SPE method for high-sensitivity analysis was successfully developed for PA analysis in plant material. The manual sample preparation could be reduced to a minimum as the set up of on-line SPE followed by UHPLC-MS/MS saves additional clean-up steps without compromising the performance of the assay.

The products and applications in this presentation are intended for Research Use Only (RUO). Not for use in diagnostic procedures

First Edition: June, 2018

For Research Use Only. Not for use in diagnostic procedures.

This publication may contain references to products that are not available in your country. Please contact us to check the availability of these products in your country.

The content of this publication shall not be reproduced, altered or sold for any commercial purpose without the written approval of Shimadzu. Company names, products/service names and logos used in this publication are trademarks and trade names of Shimadzu Corporation, its subsidiaries or its affiliates, whether or not they are used with trademark symbol "TM" or "®".

Third-party trademarks and trade names may be used in this publication to refer to either the entities or their products/services, whether or not they are used with trademark symbol "TM" or "®".

Shimadzu disclaims any proprietary interest in trademarks and trade names other than its own.

The information contained herein is provided to you "as is" without warranty of any kind including without limitation warranties as to its accuracy or completeness. Shimadzu does not assume any responsibility or liability for any damage, whether direct or indirect, relating to the use of this publication. This publication is based upon the information available to Shimadzu on or before the date of publication, and subject to change without notice.

Application News

No. AD-0095

Food Additives / Nexera X2

Fast and High Sensitivity Analysis of Six Preservatives in Beverages by UHPLC with Photodiode Array Detection

□ Introduction

Food preservatives are additives to inhibit, retard or prevent mould, acidification or other deterioration of foodstuffs caused by microbial contamination. The most commonly used preservatives in beverages are benzoic acid, sorbic acid and four para-hydroxybenzoic acid esters (parabens). However, excess amounts of these additives can be harmful to consumer health. In this regard, the minimum permissible concentrations of preservatives are regulated in most countries to ensure safety for consumer [1]. Therefore, quantitative analysis of these preservatives in food is not only required for food quality assurance but also important for consumer interest and protection. High performance liquid chromatography (HPLC) has been used for analysis of the preservatives in beverage [2-4]. In this Application News, a new rapid and high sensitivity UHPLC method for simultaneous determination of the six preservatives in beverages is described. A gradient elution was optimized for separation and quantitation of the six preservatives with a photodiode array detector. A capillary flow cell with extra long optical path of 85 mm was employed to achieve high sensitivity for a very small injection amount of sample (1µL) which was not cleaned up except filtration.

□ Experimental

Preparation of standards and samples

Benzoic acid, sorbic acid and parabens were obtained from chemicals suppliers. A mixed stock solution of 1.0 g/L of benzoic acid, sorbic acid and methyl, ethyl, propyl, butyl parabens were prepared with ethanol/water (70/30) solvent as the diluent. A set of nine working standards was prepared from the stock solution using the same diluent at the concentrations shown in Table 1. Soft drink, mango juice and cocoa drink were purchased at the local supermarket. The soft drink and mango juice were diluted 20 times and 2 times with diluent respectively while cocoa drink was not diluted. All the samples were filtered through a 0.45 µm syringe filter prior to injection to UHPLC.

Table 1: Concentrations of working standards of six preservatives for setting calibration curves

No.	Working Standard	Benzoic acid (mg/L)	Sorbic acid (mg/L)	Parabens (mg/L)
1	S1	0.2	0.008	0.01
2	S2	2.0	0.08	0.1
3	S3	4.0	0.16	0.2
4	S4	20.0	0.8	1.0
5	S5	60.0	2.4	3.0
6	S6	80.0	3.2	4.0
7	S7	100.0	4.0	5.0
8	S8	150.0	6.0	7.5
9	S9	200.0	8.0	10.0

Instrumental and analytical conditions

A Nexera X2 UHPLC system (Shimadzu Corporation, Japan) was used in this work. The system is consisted of a high pressure binary gradient solvent delivery unit (LC-30AD pumps) and an UHPLC autosampler (SIL-30AC) coupled to a photodiode array detector (SPD-M30A) with a high sensitivity capillary flow cell (85mm optical path length) featured as total reflection and low dispersion. A YMC Triart C18 column of 1.9µm particle size (150mmL. x 2.0mm I.D.) was used for the separation of preservatives (benzoic acid, sorbic acid and methyl, ethyl, propyl, butyl parabens) with an optimized linear gradient program developed. The details of the LC conditions are shown in Table 2.

Table 2: Analytical conditions of preservatives in beverages on Nexera X2 UHPLC

Column	YMC Triart C18 1.9 µm 150 x 2.0mm I.D.
Flow Rate	0.45 mL/min
Mobile Phase	A: 1.5% acetic acid+1.5% ammonium acetate in H ₂ O B: 1.5% ammonium acetate in MeOH
Elution Mode	Gradient elution: 40% B (0.01 to 4.0 min) → 80% B (4.01 to 5.5 min) → 40% B (5.51 to 8.5min)
Oven Temp.	45°C
Injection Volume	1 µL
Detection (PDA)	Wavelength 240–600nm; Ref: 720nm Quant, 240nm for benzoic acid, 260nm for other compounds

Results and Discussion

Method Development

The six preservatives were well-separated as sharp peaks between 1.7 min and 5.1 min as shown in Figure 1. The total run time of the UHPLC method is 8.5 mins, which is several times faster than the HPLC method reported [2-4]. It is worth to note that two wavelengths were selected for quantitative data processing, i.e., 240 nm for benzoic acid and 260 nm for the rest five compounds [4].

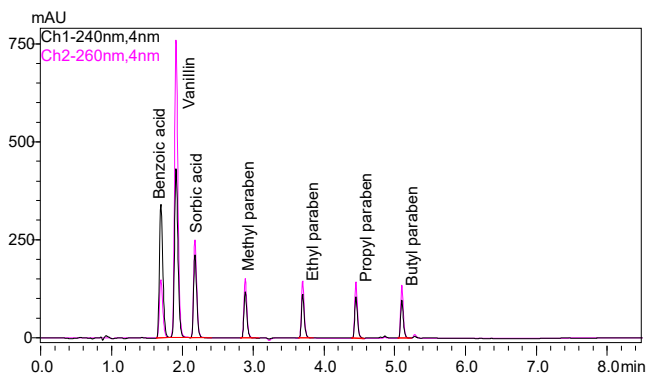

Figure 1: Chromatograms of mixed standard (S3) with 1 μ L injection volume on Nexera X2.

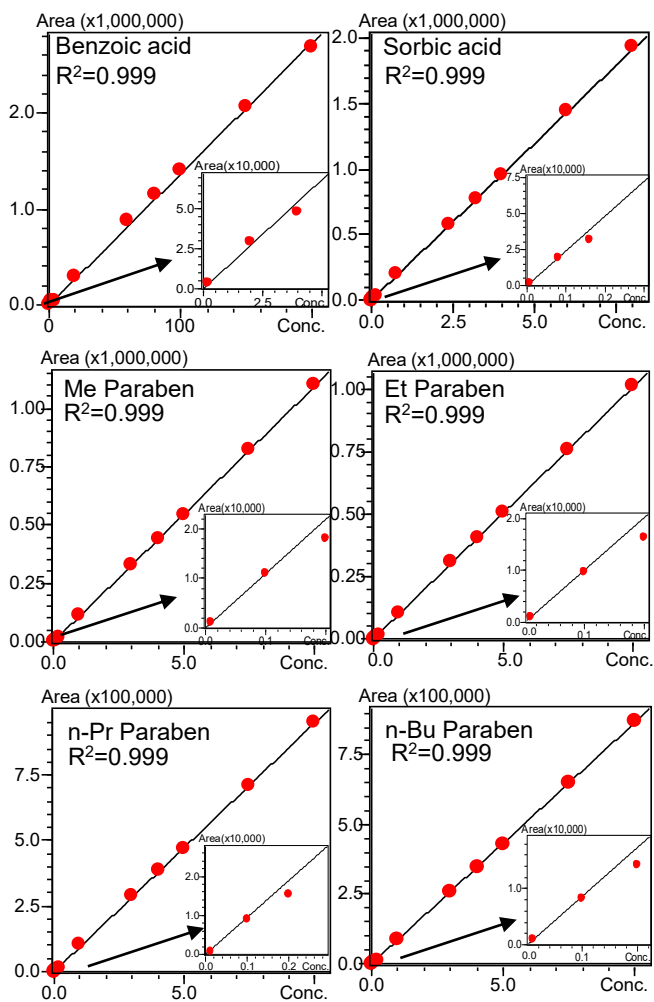

Figure 2: Calibration curves of six preservatives at concentration S1~S9 (see Table 1)

Figure 2 shows the calibration curves of the six compounds established with 1 μ L injection volume. The linearity with correlation coefficient (R^2) greater than 0.999 across the wide calibration range of 0.008~200 mg/L was obtained for the six compounds.

The repeatability of the method was evaluated at the levels S2 and S5. The peak area %RSD for the six compounds were lower than 5.1% and 0.3% respectively (Table 3).

Table 3: Results of repeatability evaluation using working standard S2 and S5 (n=6, 1 μ L injection)

Compound	Conc. (mg/L)	RSD%	Conc. (mg/L)	RSD%
Benzoic acid	2.0	1.1	60.0	0.2
Sorbic acid	0.08	1.5	60.0	0.2
Methyl paraben	0.1	1.2	2.4	0.2
Ethyl paraben	0.1	3.8	3.0	0.2
Propyl paraben	0.1	3.2	3.0	0.2
Butyl paraben	0.1	5.1	3.0	0.3

The LOD and LOQ of the method, and peak identification criteria (RT & λ_{Max}) are summarized in Table 4. The results were obtained from the mixed standard S1 (Figure 3). The high sensitivity achieved, i.e., LOQs ranging at 8~10 μ g/L of the compounds except benzoic acid (280 μ g/L), is attributed partially to the use of a high sensitivity SPD-M30A detector with using a capillary cell of 85mm optical path.

Table 4: LOD (S/N=3), LOQ (S/N=10) and peak identification criteria of UHPLC method obtained from S1 chromatogram

Compound	Conc. (μ g/L)	RT	λ_{Max}	LOD (μ g/L)	LOQ (μ g/L)
Benzoic acid	200	1.702	238	90	280
Sorbic acid	8	2.183	257	2.7	8
Methyl paraben	10	2.866	258	3	10
Ethyl paraben	10	3.687	257	3	10
Propyl paraben	10	4.445	258	3	10
Butyl paraben	10	5.091	256	3	10

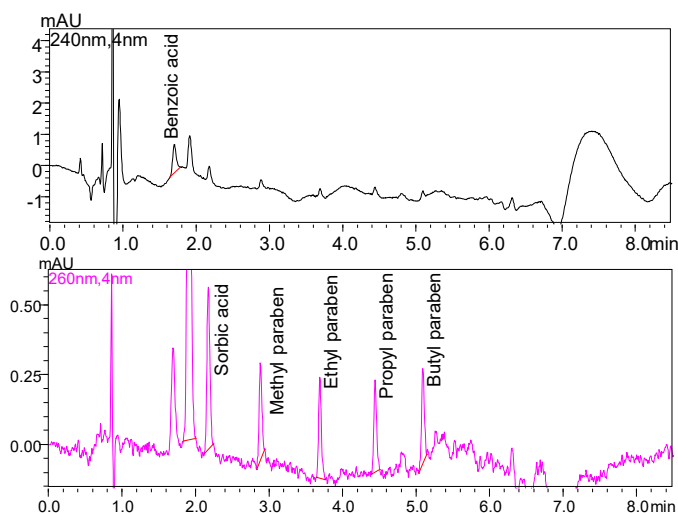

Figure 3: Chromatogram of mixed standard S1 (1 μ L).

Analysis of beverage samples

The UHPLC method established was applied for quantitation of preservatives in three kinds of beverages: soft drink B1, fruit juice B2 and cocoa drink B3. The chromatograms of the samples are shown in Figure 4 and the results are summarized into Table 5. No preservatives was detected in cocoa drink. Benzoic acid and sorbic acid were detected in the soft drink and fruit juice. The identification of both benzoic acid and sorbic acid peaks were confirmed by UV spectra.

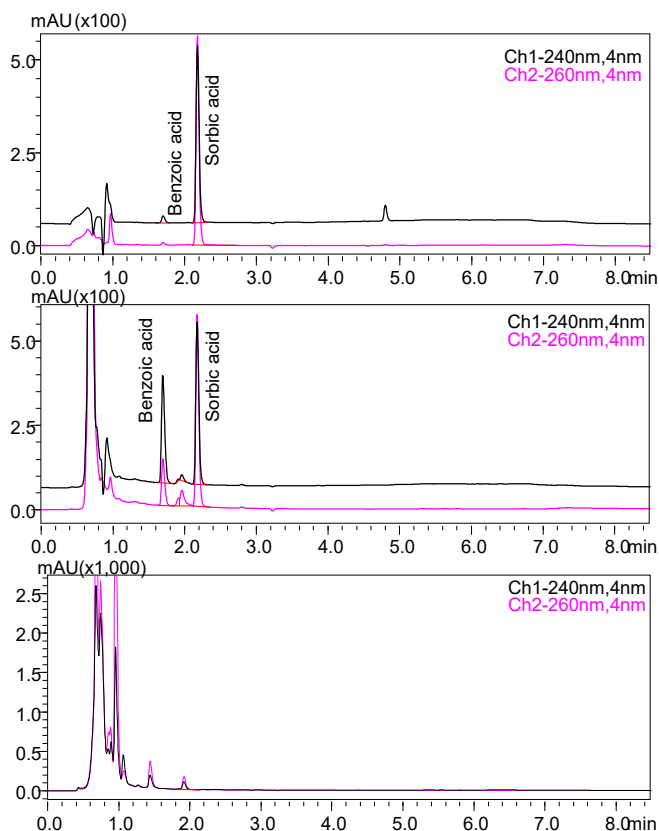

Figure 4: Chromatogram of beverage samples (injection: 1 μ L): Soft drink with 20 times dilution (top); Fruit drink with 2 times dilutions; Cocoa drink without dilution (bottom).

Table 5: Quantitative results of six preservatives in three beverages, each with duplicate injections

Sample Name	Benzoic acid		Sorbic acid		Parabens	
	RT (min)	Conc (mg/L)	RT (min)	Conc (mg/L)	RT (min)	Conc (mg/L)
B1	1.70	82.4	2.18	137.4	ND	
B2	1.70	142.4	2.18	13.8		
B3	ND					

Conclusions

A rapid and high sensitivity UHPLC method for quantitation of six preservatives, benzoic acid, sorbic acid and four para-hydroxybenzoic acid esters (parabens), in beverages was established using a reversed phase UHPLC column (1.9 μ m particle size). A capillary flow cell with extra long optical path of 85 mm was employed in the photodiode array detector. The method achieves LOQs ranging 8-10 μ g/L for the compounds except benzoic acid (280 μ g/L), with 1 μ L injection volume. The very small injection volume minimizes the contamination of beverage samples to the column and system, as such suitable for direct analysis of beverage samples without need for clean up procedure.

References

1. Singapore Agri-Food and Veterinary Services website: Food Regulations – AVA (2014)
2. United States Department of Agriculture Food Safety and Inspection Service, Office of Public Health Science: *Determination of Benzoic acid, Sorbic acid and Methyl, Ethyl, Propyl and Butyl Parabens by HPLC* (2004)
3. Tzu-Yun Chu, Chine-Lin Chen and Hsueh-Fang Wang, *A Rapid Method for the Simultaneous Determination of Preservatives in Soy Sauce*, Journal of Food and Drug Analysis, Vol. 11, No. 3, Pages 246-250 (2003)
4. Shu-Xiang Sun, Shu-Bai Li and Pei Yao, *Simultaneous Determination of Six Preservatives in Beverage by HPLC*, 3rd International Conference on Material, Mechanical and Manufacturing Engineering (2015)

Application News

No. C135

Liquid Chromatography Mass Spectrometry

Shimadzu Pesticide MRM Library Support for LC/MS/MS

 David R. Baker, Alan Barnes, Neil Loftus
 Shimadzu Corporation, UK

■ Abstract

To help expand capabilities in LC/MS/MS pesticide monitoring programs we have created the Shimadzu Pesticide MRM Library. The Library has been created with 766 certified reference standards and has been verified for use with Shimadzu LCMS-8050 and 8060 systems.

The Library contains information that can be used to accelerate method development in LC/MS/MS pesticide analysis including;

An average of 8 MRM transitions for each reference standard (with optimized collision energies) are registered in the database including positive and negative ionization mode. In total, more than 6,000 MRM transitions are part of the Library.

Meta-data for each library entry such as CAS#, formula, activity, mono-isotopic mass and adduct masses, rank of MRM transitions, synonyms, InChI, InChIKey, compound names translation (Japanese and Chinese) and links to websites offering further information (alanwood.net, PAN pesticide database, Chemical Book, ChemSpider). The meta-data is intended not only to set up new methods quickly but to help search for compound properties.

**Key words; Pesticide MRM Library,
766 compound library**

■ Using the Shimadzu Pesticide MRM Library

Expanding pesticide monitoring programmes (or creating focused methods) can be quickly set up using the Library data base (Table 1) and create fully optimized MRM methods for LC/MS/MS analysis.

Users select the target pesticides and corresponding transitions from the Library and simply copy the list into a Shimadzu LabSolutions analytical method. The method will include optimized MRM transitions. Once the acquisition method is created users can start to acquire data for screening or quantitative LC/MS/MS analysis.

Table 1 The Shimadzu Pesticide MRM Library supports a list of over 766 compounds. Designed to build extended LC/MS/MS methods quickly and to review pesticide information easily.

Library entries	
Compound information	Compound Name Synonyms Japanese name Chinese name CAS Chemical Formula Mono-isotopic mass Theoretical m/z ([M+H] ⁺ , [M+Na] ⁺ , [M+K] ⁺ , [M+NH ₄] ⁺ , [M-H] ⁻) Activity InChI InChIKey
MS/MS parameters	Ionization mode Q1 (m/z) Q3 (m/z) Q1 Pre Bias CE Q3 Pre Bias
Web links	Alanwood.net PAN Pesticide Database Chemical Book ChemSpider

Compound	CAS	Formula	M	[M+H] ⁺	[M-H] ⁻	Ionisation Mode	MRM Transitions
1 (E)-Fenpyroximate	134098-61-6	C24H27N3O4	421.2002	422.2075	420.1929	ESI+	6
2 (E)-Ferimzone	89269-64-7	C15H18N4	254.1531	255.1604	253.1458	ESI+	2
3 (Z)-Fenpyroximate	149054-53-5	C24H27N3O4	421.2002	422.2075	420.1929	ESI+	2
4 (Z)-Ferimzone	89269-64-7	C15H18N4	254.1531	255.1604	253.1458	ESI+	6
5 1-(3, 4-Dichlorophenyl)-3-methylurea	3567-62-2	C8H8Cl2N2O	218.0014	219.0087	216.9941	ESI+	19
6 1-(3, 4-Dichlorophenyl)urea	2327-02-8	C7H6Cl2N2O	203.9857	204.9930	202.9784	ESI+	17
7 1-(4-Isopropylphenyl)-3-methylurea	34123-57-4	C11H16N2O	192.1263	193.1336	191.1190	ESI+	6
8 1-(4-Isopropylphenyl)urea	56046-17-4	C10H14N2O	178.1106	179.1179	177.1033	ESI+	6
9 1-naphthaleneacetamide	86-86-2	C12H11NO	185.0841	186.0914	184.0768	ESI+	4
10 1-Naphthaleneacetic Acid	86-87-3	C12H10O2	186.0681	187.0754	185.0608	ESI-	1
11 2, 4, 5-T	93-76-5	C8H5Cl3O3	253.9304	254.9377	252.9231	ESI-	7
12 2, 4, 6-Tribromophenol	118-79-6	C6H3Br3O	327.7734	328.7807	326.7661	ESI+	10
13 2, 4, 6-Trichlorophenol	88-06-2	C6H3Cl3O	195.9249	196.9322	194.9176	ESI-	3
14 2, 4-D (2, 4-PA)	94-75-7	C8H6Cl2O3	219.9694	220.9767	218.9621	ESI-	7
15 2, 4-DB	94-82-6	C10H10Cl2O3	248.0007	249.0080	246.9934	ESI-	5
16 2, 4-dimethylaniline	95-68-1	C8H11N	121.0891	122.0964	120.0818	ESI+	5
17 2, 6-Dichlorobenzamide	2008-58-4	C7H5Cl2NO	188.9748	189.9821	187.9675	ESI+	13
18 2-Naphthoxy acetic acid	120-23-0	C12H10O3	202.0630	203.0703	201.0557	ESI-	2
19 2-Phenylphenol	90-43-7	C12H10O	170.0732	171.0805	169.0659	ESI-	2
20 3-(3-Indolyl)-propionic acid	830-96-6	C11H11NO2	189.0790	190.0863	188.0717	ESI+	6
21 3, 4, 5-Trimethacarb	2686-99-9	C11H15NO2	193.1103	194.1176	192.1030	ESI+	12
22 3-Indolyl-acetic acid	87-51-4	C10H9NO2	175.0633	176.0706	174.0560	ESI+	12
23 3-Methylphosphinopropionic acid	15090-23-0	C4H9O4P	152.0238	153.0311	151.0165	ESI+	12
24 4-(3-Indolyl)-butyric acid	133-32-4	C12H13NO2	203.0946	204.1019	202.0873	ESI+	14
25 4-Chlorophenoxyacetic acid	122-88-3	C8H7ClO3	186.0084	187.0157	185.0011	ESI-	4
26 6-chloro-3-phenylpyridazin-4-ol	40020-01-7	C10H7ClN2O	206.0247	207.0320	205.0174	ESI+	6
27 6-Furfurylaminopurine	525-79-1	C10H9N5O	215.0807	216.0880	214.0734	ESI+	9
28 Acephate	30560-19-1	C4H10NO3PS	183.0119	184.0192	182.0046	ESI+	6
29 Acequinocyl	57960-19-7	C24H32O4	384.2301	385.2374	383.2228	ESI+	6
30 Acetamidiprid	135410-20-7	C10H11ClN4	222.0672	223.0745	221.0599	ESI+	10
31 Acibenzolar-S-methyl	135158-54-2	C8H6N2OS2	209.9922	210.9995	208.9849	ESI+	6
32 Acifluorfen	50594-66-6	C14H7ClF3NO5	360.9965	362.0038	359.9892	ESI-	12
33 Aclonifen	74070-46-5	C12H9ClN2O3	264.0302	265.0375	263.0229	ESI+	2
34 Acrinathrin	101007-06-1	C26H21F6NO5	541.1324	542.1397	540.1251	ESI+	12
35 Alachlor	15972-60-8	C14H20ClNO2	269.1183	270.1256	268.1110	ESI+	12
36 Alanycarb	83130-01-2	C17H25N3O4S2	399.1286	400.1359	398.1213	ESI+	6
37 Aldicarb	116-06-3	C7H14N2O2S	190.0776	191.0849	189.0703	ESI+	5
38 Aldicarb-sulfone (Aldoxycarb)	1646-88-4	C7H14N2O4S	222.0674	223.0747	221.0601	ESI+	5
39 Aldicarb-sulfoxide	1646-87-3	C7H14N2O3S	206.0725	207.0798	205.0652	ESI+	8
40 Allethrin	584-79-2	C19H26O3	302.1882	303.1955	301.1809	ESI+	12
41 Allidochlor	93-71-0	C8H12ClNO	173.0607	174.0680	172.0534	ESI+	12
42 Ametoctradin	865318-97-4	C15H25N5	275.2110	276.2183	274.2037	ESI+	6
43 Ametryn	834-12-8	C9H17N5S	227.1205	228.1278	226.1132	ESI+	6
44 Amidosulfuron	120923-37-7	C9H15N5O7S2	369.0413	370.0486	368.0340	ESI+	8
45 Aminocarb	2032-59-9	C11H16N2O2	208.1212	209.1285	207.1139	ESI+	6
46 Aminopyralid	150114-71-9	C6H4Cl2N2O2	205.9650	206.9723	204.9577	ESI+	7
47 Amisulbrom	348635-87-0	C13H13BrFN5O4S2	464.9576	465.9649	463.9503	ESI+	10
48 Amitraz	33089-61-1	C19H23N3	293.1892	294.1965	292.1819	ESI+	2
49 Amitrole	61-82-5	C2H4N4	84.0436	85.0509	83.0363	ESI+	5
50 AMPA	1066-51-9	CH6NO3P	111.0085	112.0158	110.0012	ESI-	3
51 Ancymidol	12771-68-5	C15H16N2O2	256.1212	257.1285	255.1139	ESI+	6
52 Anilazine	101-05-3	C9H5Cl3N4	273.9580	274.9653	272.9507	ESI+	12
53 Anilofos	64249-01-0	C13H19ClNO3PS2	367.0232	368.0305	366.0159	ESI+	12
54 Aramite	140-57-8	C15H23ClO4S	334.1006	335.1079	333.0933	ESI+	12
55 Asulam	3337-71-1	C8H10N2O4S	230.0361	231.0434	229.0288	ESI+	9
56 Atraton	1610-17-9	C9H17N5O	211.1433	212.1506	210.1360	ESI+	6
57 Atrazine	1912-24-9	C8H14ClN5	215.0938	216.1011	214.0865	ESI+	8
58 Atrazine-2-hydroxy	2163-68-0	C8H15N5O	197.1277	198.1350	196.1204	ESI+	6
59 Atrazine-desethyl	6190-65-4	C6H10ClN5	187.0625	188.0698	186.0552	ESI+	9
60 Atrazine-desethyl-2-hydroxy	19988-24-0	C6H11N5O	169.0964	170.1037	168.0891	ESI+	5
61 Atrazine-desisopropyl	1007-28-9	C5H8ClN5	173.0468	174.0541	172.0395	ESI+	10
62 Avermectin B1a	65195-55-3	C48H72O14	872.4922	873.4995	871.4849	ESI+	4
63 Avermectin B1b	65195-56-4	C47H70O14	858.4766	859.4839	857.4693	ESI+	3
64 Azaconazole	60207-31-0	C12H11Cl2N3O2	299.0228	300.0301	298.0155	ESI+	8
65 Azadirachtin	11141-17-6	C35H44O16	720.2629	721.2702	719.2556	ESI+	8
66 Azamethiphos	35575-96-3	C9H10ClN2O5PS	323.9737	324.9810	322.9664	ESI+	11
67 Azimsulfuron	120162-55-2	C13H16N10O5S	424.1026	425.1099	423.0953	ESI+	5
68 Azinphos-ethyl	2642-71-9	C12H16N3O3PS2	345.0371	346.0444	344.0298	ESI+	5
69 Azinphos-methyl	86-50-0	C10H12N3O3PS2	317.0058	318.0131	315.9985	ESI+	6
70 Aziprotryne	4658-28-0	C7H11N7S	225.0797	226.0870	224.0724	ESI+	4
71 Azobenzene	103-33-3	C12H10N2	182.0844	183.0917	181.0771	ESI+	2
72 Azoxystrobin	131860-33-8	C22H17N3O5	403.1168	404.1241	402.1095	ESI+	5
73 Barban	101-27-9	C11H9Cl2NO2	257.0010	258.0083	255.9937	ESI+	11
74 Beflubutamid	113614-08-7	C18H17F4NO2	355.1195	356.1268	354.1122	ESI+	10
75 Benalaxyl	71626-11-4	C20H23NO3	325.1678	326.1751	324.1605	ESI+	6

	Compound	CAS	Formula	M	[M+H] ⁺	[M-H] ⁻	Ionisation Mode	MRM Transitions
76	Benazolin	3813-05-6	C9H6ClNO3S	242.9757	243.9830	241.9684	ESI+	6
77	Benazolin-ethyl	25059-80-7	C11H10ClNO3S	271.0070	272.0143	269.9997	ESI+	18
78	Bendiocarb	22781-23-3	C11H13NO4	223.0845	224.0918	222.0772	ESI+	6
79	Benfuracarb	82560-54-1	C20H30N2O5S	410.1875	411.1948	409.1802	ESI+	5
80	Benfuresate	68505-69-1	C12H16O4S	256.0769	257.0842	255.0696	ESI+	2
81	Benodanil	15310-01-7	C13H10INO	322.9807	323.9880	321.9734	ESI+	6
82	Benoxacor	98730-04-2	C11H11Cl2NO2	259.0167	260.0240	258.0094	ESI+	17
83	Bensulfuron-methyl	83055-99-6	C16H18N4O7S	410.0896	411.0969	409.0823	ESI+	6
84	Bensulide	741-58-2	C14H24NO4PS3	397.0605	398.0678	396.0532	ESI+	9
85	Bentazone	25057-89-0	C10H12N2O3S	240.0569	241.0642	239.0496	ESI-	5
86	Benthiavalicarb-isopropyl	177406-68-7	C18H24FN3O3S	381.1522	382.1595	380.1449	ESI+	5
87	Benthiazole	21564-17-0	C9H6N2S3	237.9693	238.9766	236.9620	ESI+	6
88	Benzanilide	93-98-1	C13H11NO	197.0841	198.0914	196.0768	ESI+	4
89	Benzofenap	82692-44-2	C22H20Cl2N2O3	430.0851	431.0924	429.0778	ESI+	2
90	Benzoximate	29104-30-1	C18H18ClNO5	363.0874	364.0947	362.0801	ESI+	12
91	Benzoylprop-ethyl	22212-55-1	C18H17Cl2NO3	365.0585	366.0658	364.0512	ESI+	6
92	Benzthiazuron	1929-88-0	C9H9N3OS	207.0466	208.0539	206.0393	ESI+	9
93	Benzyl dimethyl dodecyl ammonium	139-07-1	C21H37N	303.2926	304.2999	302.2853	ESI+	4
94	Benzyl dimethyl hexadecyl ammonium	122-18-9	C25H45N	359.3552	360.3625	358.3479	ESI+	3
95	Benzyl dimethyl tetradecyl ammonium	139-08-2	C23H41N	331.3239	332.3312	330.3166	ESI+	3
96	Bifenazate	149877-41-8	C17H20N2O3	300.1474	301.1547	299.1401	ESI+	6
97	Bifenox	42576-02-3	C14H9Cl2NO5	340.9858	341.9931	339.9785	ESI+	8
98	Bifenthrin	82657-04-3	C23H22ClF3O2	422.1260	423.1333	421.1187	ESI+	5
99	Bioresmethrin	28434-01-7	C22H26O3	338.1882	339.1955	337.1809	ESI+	6
100	Bispyribac-sodium	125401-92-5	C19H17N4NaO8	452.0944	453.1017	451.0871	ESI+	8
101	Bitertanol	55179-31-2	C20H23N3O2	337.1790	338.1863	336.1717	ESI+	6
102	Bixafen	581809-46-3	C18H12Cl2F3N3O	413.0310	414.0383	412.0237	ESI+	12
103	Boscalid	188425-85-6	C18H12Cl2N2O	342.0327	343.0400	341.0254	ESI+	12
104	Brodifacoum	56073-10-0	C31H23BrO3	522.0831	523.0904	521.0758	ESI+	12
105	Bromacil	314-40-9	C9H13BrN2O2	260.0160	261.0233	259.0087	ESI+	9
106	Bromadiolone	28772-56-7	C30H23BrO4	526.0780	527.0853	525.0707	ESI-	12
107	Bromfeninfos	33399-00-7	C12H14BrCl2O4P	401.9190	402.9263	400.9117	ESI+	17
108	Bromobutide	74712-19-9	C15H22BrNO	311.0885	312.0958	310.0812	ESI+	10
109	Bromophos-ethyl	4824-78-6	C10H12BrCl2O3PS	391.8805	392.8878	390.8732	ESI+	3
110	Bromophos-methyl	2104-96-3	C8H8BrCl2O3PS	363.8492	364.8565	362.8419	ESI+	6
111	Bromoxynil	1689-84-5	C7H3Br2NO	274.8581	275.8654	273.8508	ESI-	11
112	Bromuconazole	116255-48-2	C13H12BrCl2N3O	374.9541	375.9614	373.9468	ESI+	11
113	Bupirimate	41483-43-6	C13H24N4O3S	316.1569	317.1642	315.1496	ESI+	6
114	Buprofezin	69327-76-0	C16H23N3O5	305.1562	306.1635	304.1489	ESI+	6
115	Butachlor	23184-66-9	C17H26ClNO2	311.1652	312.1725	310.1579	ESI+	12
116	Butafenacil	134605-64-4	C20H18ClF3N2O6	474.0805	475.0878	473.0732	ESI+	10
117	Butamifos	36335-67-8	C13H21N2O4PS	332.0960	333.1033	331.0887	ESI+	12
118	Butocarboxim	34681-10-2	C7H14N2O2S	190.0776	191.0849	189.0703	ESI+	3
119	Butocarboxim-sulfone	34681-23-7	C7H14N2O4S	222.0674	223.0747	221.0601	ESI+	14
120	Butocarboxim-sulfoxide	34681-24-8	C7H14N2O3S	206.0725	207.0798	205.0652	ESI+	6
121	Butralin	33629-47-9	C14H21N3O4	295.1532	296.1605	294.1459	ESI+	6
122	Buturon	3766-60-7	C12H13ClN2O	236.0716	237.0789	235.0643	ESI+	9
123	Butylate	2008-41-5	C11H23NOS	217.1500	218.1573	216.1427	ESI+	3
124	Cadusafos	95465-99-9	C10H23O2PS2	270.0877	271.0950	269.0804	ESI+	5
125	Cafenstrole	125306-83-4	C16H22N4O3S	350.1413	351.1486	349.1340	ESI+	3
126	Captafol	2425-06-1	C10H9Cl4NO2S	346.9108	347.9181	345.9035	ESI+	1
127	Carbaryl (NAC)	63-25-2	C12H11NO2	201.0790	202.0863	200.0717	ESI+	6
128	Carbendazim	10605-21-7	C9H9N3O2	191.0695	192.0768	190.0622	ESI+	5
129	Carbetamide	16118-49-3	C12H16N2O3	236.1161	237.1234	235.1088	ESI+	6
130	Carbofuran	1563-66-2	C12H15NO3	221.1052	222.1125	220.0979	ESI+	6
131	Carbofuran-3-hydroxy (3-Hydroxycarbofuran)	16655-82-6	C12H15NO4	237.1001	238.1074	236.0928	ESI+	12
132	Carbofuran-3-keto	16709-30-1	C12H13NO4	235.0845	236.0918	234.0772	ESI+	12
133	Carbophenothion	786-19-6	C11H16ClO2PS3	341.9739	342.9812	340.9666	ESI+	9
134	Carbosulfan	55285-14-8	C20H32N2O3S	380.2134	381.2207	379.2061	ESI+	6
135	Carboxin	5234-68-4	C12H13NO2S	235.0667	236.0740	234.0594	ESI+	6
136	Carfentrazone-ethyl	128639-02-1	C15H14Cl2F3N3O3	411.0364	412.0437	410.0291	ESI+	5
137	Carpropamid	104030-54-8	C15H18Cl3NO	333.0454	334.0527	332.0381	ESI+	18
138	Cartap	15263-53-3	C7H15N3O2S2	237.0606	238.0679	236.0533	ESI+	3
139	Chinomethionat	2439-01-2	C10H6N2OS2	233.9922	234.9995	232.9849	ESI+	6
140	Chloramphenicol	56-75-7	C11H12Cl2N2O5	322.0123	323.0196	321.0050	ESI-	17
141	Chlorantraniliprole	500008-45-7	C18H14BrCl2N5O2	480.9708	481.9781	479.9635	ESI+	28
142	Chlorbromuron	13360-45-7	C9H10BrClN2O2	291.9614	292.9687	290.9541	ESI+	12
143	Chlorbufam	1967-16-4	C11H10ClNO2	223.0400	224.0473	222.0327	ESI+	4
144	Chlordimeform	6164-98-3	C10H13ClN2	196.0767	197.0840	195.0694	ESI+	12
145	Chlorfenvinphos	470-90-6	C12H14Cl3O4P	357.9695	358.9768	356.9622	ESI+	12
146	Chlorfluzuron	71422-67-8	C20H9Cl3F5N3O3	538.9630	539.9703	537.9557	ESI+	17
147	Chloridazon	1698-60-8	C10H8ClN3O	221.0356	222.0429	220.0283	ESI+	11
148	Chlorimuron-ethyl	90982-32-4	C15H15ClN4O6S	414.0401	415.0474	413.0328	ESI+	12
149	Chlormequat-chloride	999-81-5	C5H13Cl2N	157.0425	158.0498	156.0352	ESI+	6
150	Chlorophacinone	3691-35-8	C23H15ClO3	374.0710	375.0783	373.0637	ESI-	15

Compound	CAS	Formula	M	[M+H] ⁺	[M-H] ⁻	Ionisation Mode	MRM Transitions
151 Chlorotoluron	15545-48-9	C10H13ClN2O	212.0716	213.0789	211.0643	ESI+	8
152 Chloroxuron	1982-47-4	C15H15ClN2O2	290.0822	291.0895	289.0749	ESI+	12
153 Chloroxynil	1891-95-8	C7H3Cl2NO	186.9592	187.9665	185.9519	ESI-	6
154 Chlorpropham	101-21-3	C10H12ClNO2	213.0557	214.0630	212.0484	ESI+	2
155 Chlorpyrifos	2921-88-2	C9H11Cl3NO3PS	348.9263	349.9336	347.9190	ESI+	16
156 Chlorpyrifos-methyl	5598-13-0	C7H7Cl3NO3PS	320.8950	321.9023	319.8877	ESI+	12
157 Chlorpyrifos-oxon	5598-15-2	C9H11Cl3NO4P	332.9491	333.9564	331.9418	ESI+	24
158 Chlorsulfuron	64902-72-3	C12H12ClN5O4S	357.0299	358.0372	356.0226	ESI+	18
159 Chlorthiamid	1918-13-4	C7H5Cl2NS	204.9520	205.9593	203.9447	ESI+	16
160 Chromafenozide	143807-66-3	C24H30N2O3	394.2256	395.2329	393.2183	ESI+	6
161 Cinidon-ethyl	142891-20-1	C19H17Cl2NO4	393.0535	394.0608	392.0462	ESI+	24
162 Cinosulfuron	94593-91-6	C15H19N5O7S	413.1005	414.1078	412.0932	ESI+	6
163 Clethodim	99129-21-2	C17H26ClNO3S	359.1322	360.1395	358.1249	ESI+	10
164 Climbazole	38083-17-9	C15H17ClN2O2	292.0979	293.1052	291.0906	ESI+	9
165 Clodinafop (free acid)	114420-56-3	C14H11ClFNO4	311.0361	312.0434	310.0288	ESI+	8
166 Clodinafop-propargyl	105512-06-9	C17H13ClFNO4	349.0517	350.0590	348.0444	ESI+	12
167 Clofentezine	74115-24-5	C14H8Cl2N4	302.0126	303.0199	301.0053	ESI+	10
168 Clomazone	81777-89-1	C12H14ClNO2	239.0713	240.0786	238.0640	ESI+	8
169 Clomeprop	84496-56-0	C16H15Cl2NO2	323.0480	324.0553	322.0407	ESI+	21
170 Cloprop	101-10-0	C9H9ClO3	200.0240	201.0313	199.0167	ESI-	2
171 Clopyralid	1702-17-6	C6H3Cl2NO2	190.9541	191.9614	189.9468	ESI-	2
172 Cloquintocet-mexyl	99607-70-2	C18H22ClNO3	335.1288	336.1361	334.1215	ESI+	9
173 Cloransulam-methyl	147150-35-4	C15H13ClFN5O5S	429.0310	430.0383	428.0237	ESI+	12
174 Clothianidin	210880-92-5	C6H8ClN5O2S	249.0087	250.0160	248.0014	ESI+	7
175 Coumachlor	81-82-3	C19H15ClO4	342.0659	343.0732	341.0586	ESI+	18
176 Coumaphos	56-72-4	C14H16ClO5PS	362.0145	363.0218	361.0072	ESI+	12
177 Coumatetralyl	5836-29-3	C19H16O3	292.1099	293.1172	291.1026	ESI+	6
178 Crimidine	535-89-7	C7H10ClN3	171.0563	172.0636	170.0490	ESI+	12
179 Crotoxyphos	7700-17-6	C14H19O6P	314.0919	315.0992	313.0846	ESI+	6
180 Crufomate	299-86-5	C12H19ClNO3P	291.0791	292.0864	290.0718	ESI+	12
181 Cumyluron	99485-76-4	C17H19ClN2O	302.1186	303.1259	301.1113	ESI+	2
182 Cyanazine	21725-46-2	C9H13ClN6	240.0890	241.0963	239.0817	ESI+	6
183 Cyanofenphos	13067-93-1	C15H14NO2PS	303.0483	304.0556	302.0410	ESI+	6
184 Cyazofamid	120116-88-3	C13H13ClN4O2S	324.0448	325.0521	323.0375	ESI+	5
185 Cyclanilide	113136-77-9	C11H9Cl2NO3	272.9959	274.0032	271.9886	ESI-	20
186 Cycloate	1134-23-2	C11H21NOS	215.1344	216.1417	214.1271	ESI+	5
187 Cycloheximide	66-81-9	C15H23NO4	281.1627	282.1700	280.1554	ESI+	12
188 Cycloprothrin	63935-38-6	C26H21Cl2NO4	481.0848	482.0921	480.0775	ESI+	2
189 Cyclosulfamuron	136849-15-5	C17H19N5O6S	421.1056	422.1129	420.0983	ESI+	6
190 Cycloxydim	101205-02-1	C17H27NO3S	325.1712	326.1785	324.1639	ESI+	10
191 Cyfluron	2163-69-1	C11H22N2O	198.1732	199.1805	197.1659	ESI+	5
192 Cyflufenamid	180409-60-3	C20H17F5N2O2	412.1210	413.1283	411.1137	ESI+	6
193 Cyflumetofen	400882-07-7	C24H24F3NO4	447.1657	448.1730	446.1584	ESI+	8
194 Cyhalofop-butyl	122008-85-9	C20H20FNO4	357.1376	358.1449	356.1303	ESI+	3
195 Cymiazole	61676-87-7	C12H14N2S	218.0878	219.0951	217.0805	ESI+	6
196 Cymoxanil	57966-95-7	C7H10N4O3	198.0753	199.0826	197.0680	ESI+	4
197 Cypermethrin	52315-07-8	C22H19Cl2NO3	415.0742	416.0815	414.0669	ESI+	10
198 Cyphenothrin	39515-40-7	C24H25NO3	375.1834	376.1907	374.1761	ESI+	12
199 Cyproconazole	94361-06-5	C15H18ClN3O	291.1138	292.1211	290.1065	ESI+	10
200 Cyprodinil	121552-61-2	C14H15N3	225.1266	226.1339	224.1193	ESI+	6
201 Cyromazine	66215-27-8	C6H10N6	166.0967	167.1040	165.0894	ESI+	6
202 Daimuron (Dymron)	42609-52-9	C17H20N2O	268.1576	269.1649	267.1503	ESI+	6
203 Dalapon	75-99-0	C3H4Cl2O2	141.9588	142.9661	140.9515	ESI-	10
204 Daminozide	1596-84-5	C6H12N2O3	160.0848	161.0921	159.0775	ESI+	6
205 Dazomet	533-74-4	C5H10N2S2	162.0285	163.0358	161.0212	ESI+	6
206 Deet	134-62-3	C12H17NO	191.1310	192.1383	190.1237	ESI+	2
207 Deltamethrin	52918-63-5	C22H19Br2NO3	502.9732	503.9805	501.9659	ESI+	12
208 Demeton-O	298-03-3	C8H19O3PS2	258.0513	259.0586	257.0440	ESI+	2
209 Demeton-S	126-75-0	C8H19O3PS2	258.0513	259.0586	257.0440	ESI+	3
210 Demeton-S-methyl	919-86-8	C6H15O3PS2	230.0200	231.0273	229.0127	ESI+	2
211 Demeton-S-methyl-sulfone	17040-19-6	C6H15O5PS2	262.0099	263.0172	261.0026	ESI+	6
212 Desmedipham	13684-56-5	C16H16N2O4	300.1110	301.1183	299.1037	ESI+	6
213 Desmetryn	1014-69-3	C8H15N5S	213.1048	214.1121	212.0975	ESI+	4
214 Diafenthion	80060-09-9	C23H32N2O5S	384.2235	385.2308	383.2162	ESI+	12
215 Dialifos	10311-84-9	C14H17ClNO4PS2	393.0025	394.0098	391.9952	ESI+	12
216 Diallylate	2303-16-4	C10H17Cl2NOS	269.0408	270.0481	268.0335	ESI+	12
217 Diazinon	333-41-5	C12H21N2O3PS	304.1010	305.1083	303.0937	ESI+	6
218 Dicamba	1918-00-9	C8H6Cl2O3	219.9694	220.9767	218.9621	ESI-	2
219 Dichlofenthion	97-17-6	C10H13Cl2O3PS	313.9700	314.9773	312.9627	ESI+	8
220 Dichlofluanid	1085-98-9	C9H11Cl2FN2O2S2	331.9623	332.9696	330.9550	ESI+	11
221 Dichlormid	37764-25-3	C8H11Cl2NO	207.0218	208.0291	206.0145	ESI+	19
222 Dichlorprop	120-36-5	C9H8Cl2O3	233.9850	234.9923	232.9777	ESI-	8
223 Dichlorvos	62-73-7	C4H7Cl2O4P	219.9459	220.9532	218.9386	ESI+	17
224 Diclobutrazol	75736-33-3	C15H19Cl2N3O	327.0905	328.0978	326.0832	ESI+	4
225 Diclofop	40843-25-2	C15H12Cl2O4	326.0113	327.0186	325.0040	ESI-	4

Compound	CAS	Formula	M	[M+H] ⁺	[M-H] ⁻	Ionisation Mode	MRM Transitions
226 Diclofop-methyl	51338-27-3	C16H14Cl2O4	340.0269	341.0342	339.0196	ESI+	12
227 Dicloran	99-30-9	C6H4Cl2N2O2	205.9650	206.9723	204.9577	ESI+	4
228 Diclosulam	145701-21-9	C13H10Cl2FN5O3S	404.9865	405.9938	403.9792	ESI+	9
229 Dicrotophos	141-66-2	C8H16NO5P	237.0766	238.0839	236.0693	ESI+	6
230 Dicyclanil	112636-83-6	C8H10N6	190.0967	191.1040	189.0894	ESI+	6
231 Didecyldimethylammonium	7173-51-5	C22H47N	325.3709	326.3782	324.3636	ESI+	6
232 Diethanolamine	111-42-2	C4H11NO2	105.0790	106.0863	104.0717	ESI+	6
233 Diethofencarb	87130-20-9	C14H21NO4	267.1471	268.1544	266.1398	ESI+	6
234 Difenacoum	56073-07-5	C31H24O3	444.1725	445.1798	443.1652	ESI+	12
235 Difenconazole	119446-68-3	C19H17Cl2N3O3	405.0647	406.0720	404.0574	ESI+	12
236 Difenoxuron	14214-32-5	C16H18N2O3	286.1317	287.1390	285.1244	ESI+	6
237 Difenzoquat-methyl-sulfate	43222-48-6	C17H16N2	248.1313	249.1386	247.1240	ESI+	6
238 Diflubenzuron	35367-38-5	C14H9ClF2N2O2	310.0321	311.0394	309.0248	ESI+	9
239 Diflufenican	83164-33-4	C19H11F5N2O2	394.0741	395.0814	393.0668	ESI+	12
240 Dimefuron	34205-21-5	C15H19ClN4O3	338.1146	339.1219	337.1073	ESI+	5
241 Dimepiperate	61432-55-1	C15H21NOS	263.1344	264.1417	262.1271	ESI+	6
242 Dimethachlon	24096-53-5	C10H7Cl2NO2	242.9854	243.9927	241.9781	ESI-	2
243 Dimethachlor	50563-36-5	C13H18ClNO2	255.1026	256.1099	254.0953	ESI+	12
244 Dimethametryn	22936-75-0	C11H21N5S	255.1518	256.1591	254.1445	ESI+	6
245 Dimethenamid	87674-68-8	C19H18ClNO2S	275.0747	276.0820	274.0674	ESI+	12
246 Dimethirimol	5221-53-4	C11H19N3O	209.1528	210.1601	208.1455	ESI+	3
247 Dimethoate	60-51-5	C5H12NO3PS2	228.9996	230.0069	227.9923	ESI+	6
248 Dimethomorph	110488-70-5	C21H22ClNO4	387.1237	388.1310	386.1164	ESI+	12
249 Dimetilan	644-64-4	C10H16N4O3	240.1222	241.1295	239.1149	ESI+	6
250 Dimoxystrobin	149961-52-4	C19H22N2O3	326.1630	327.1703	325.1557	ESI+	6
251 Diniconazole	83657-24-3	C15H17Cl2N3O	325.0749	326.0822	324.0676	ESI+	7
252 Dinocap	39300-45-3	C18H24N2O6	364.1634	365.1707	363.1561	ESI+	6
253 Dinoseb	88-85-7	C10H12N2O5	240.0746	241.0819	239.0673	ESI-	4
254 Dinotefuran	165252-70-0	C7H14N4O3	202.1066	203.1139	201.0993	ESI+	6
255 Dinoterb	1420-07-1	C10H12N2O5	240.0746	241.0819	239.0673	ESI-	4
256 Dioxacarb	6988-21-2	C11H13NO4	223.0845	224.0918	222.0772	ESI+	6
257 Dioxathion	78-34-2	C12H26O6P2S4	456.0087	457.0160	455.0014	ESI+	6
258 Diphenamid	957-51-7	C16H17NO	239.1310	240.1383	238.1237	ESI+	6
259 Diphenylamine	122-39-4	C12H11N	169.0891	170.0964	168.0818	ESI+	4
260 Dipropetryn	4147-51-7	C11H21N5S	255.1518	256.1591	254.1445	ESI+	6
261 Diquat	6385-62-2	C12H12N2	184.1000	185.1073	183.0927	ESI+	3
262 Disulfoton	298-04-4	C8H19O2PS3	274.0285	275.0358	273.0212	ESI+	3
263 Disulfoton-sulfone	2497-06-5	C8H19O4PS3	306.0183	307.0256	305.0110	ESI+	6
264 Disulfoton-sulfoxide	2497-07-6	C8H19O3PS3	290.0234	291.0307	289.0161	ESI+	6
265 Ditalimfos	5131-24-8	C12H14NO4PS	299.0381	300.0454	298.0308	ESI+	6
266 Dithianon	3347-22-6	C14H4N2O2S2	295.9714	296.9787	294.9641	ESI-	4
267 Dithiopyr	97886-45-8	C15H16F5NO2S2	401.0543	402.0616	400.0470	ESI+	6
268 Diuron (DCMU)	330-54-1	C9H10Cl2N2O	232.0170	233.0243	231.0097	ESI+	7
269 DMST	66840-71-9	C9H14N2O2S	214.0776	215.0849	213.0703	ESI+	4
270 DNOC	534-52-1	C7H6N2O5	198.0277	199.0350	197.0204	ESI-	6
271 Dodemorph	1593-77-7	C18H35NO	281.2719	282.2792	280.2646	ESI+	6
272 Dodine	2439-10-3	C15H33N3O2	287.2573	288.2646	286.2500	ESI+	6
273 Doramectin	117704-25-3	C50H74O14	898.5079	899.5152	897.5006	ESI+	10
274 Edifenphos	17109-49-8	C14H15O2PS2	310.0251	311.0324	309.0178	ESI+	6
275 Emamectin B1a	119791-41-2	C49H75NO13	885.5238	886.5311	884.5165	ESI+	5
276 Emamectin B1b	137335-79-6	C55H79NO15	871.5082	872.5155	870.5009	ESI+	3
277 Endosulfan-sulfate	1031-07-8	C9H6Cl6O4S	419.8118	420.8191	418.8045	ESI-	3
278 EPN	2104-64-5	C14H14NO4PS	323.0381	324.0454	322.0308	ESI+	6
279 Epoxiconazole	133855-98-8	C17H13ClFN3O	329.0731	330.0804	328.0658	ESI+	9
280 EPTC	759-94-4	C9H19NOS	189.1187	190.1260	188.1114	ESI+	5
281 Esfenvalerate	66230-04-4	C25H22ClNO3	419.1288	420.1361	418.1215	ESI+	2
282 Esprocarb	85785-20-2	C15H23NOS	265.1500	266.1573	264.1427	ESI+	5
283 Etaconazole	60207-93-4	C14H15Cl2N3O2	327.0541	328.0614	326.0468	ESI+	12
284 Ethametsulfuron-methyl	97780-06-8	C15H18N6O6S	410.1009	411.1082	409.0936	ESI+	6
285 Ethephon	16672-87-0	C2H6ClO3P	143.9743	144.9816	142.9670	ESI-	6
286 Ethidimuron	30043-49-3	C7H12N4O3S2	264.0351	265.0424	263.0278	ESI+	11
287 Ethiofencarb	29973-13-5	C11H15NO2S	225.0823	226.0896	224.0750	ESI+	10
288 Ethiofencarb-sulfone	53380-23-7	C11H15NO4S	257.0722	258.0795	256.0649	ESI+	8
289 Ethiofencarb-sulfoxide	53380-22-6	C11H15NO3S	241.0773	242.0846	240.0700	ESI+	4
290 Ethion	563-12-2	C9H22O4P2S4	383.9876	384.9949	382.9803	ESI+	6
291 Ethiprole	181587-01-9	C13H9Cl2F3N4OS	395.9826	396.9899	394.9753	ESI+	30
292 Ethirimol	23947-60-6	C11H19N3O	209.1528	210.1601	208.1455	ESI+	6
293 Ethofumesate	26225-79-6	C13H18O5S	286.0875	287.0948	285.0802	ESI+	11
294 Ethoprophos	13194-48-4	C8H19O2PS2	242.0564	243.0637	241.0491	ESI+	6
295 Ethoxyquin	91-53-2	C14H19NO	217.1467	218.1540	216.1394	ESI+	4
296 Ethoxysulfuron	126801-58-9	C15H18N4O7S	398.0896	399.0969	397.0823	ESI+	6
297 Ethylenethiourea	96-45-7	C3H6N2S	102.0252	103.0325	101.0179	ESI+	6
298 Etofenprox	80844-07-1	C25H28O3	376.2038	377.2111	375.1965	ESI+	6
299 Etoxazole	153233-91-1	C21H23F2NO2	359.1697	360.1770	358.1624	ESI+	6
300 Etrinfos	38260-54-7	C10H17N2O4PS	292.0647	293.0720	291.0574	ESI+	6

Compound	CAS	Formula	M	[M+H] ⁺	[M-H] ⁻	Ionisation Mode	MRM Transitions
301 Famoxadone	131807-57-3	C22H18N2O4	374.1267	375.1340	373.1194	ESI+	6
302 Famphur	52-85-7	C10H16NO5PS2	325.0208	326.0281	324.0135	ESI+	12
303 Fenamidone	161326-34-7	C17H17N3O5	311.1092	312.1165	310.1019	ESI+	6
304 Fenaminosulf	140-56-7	C8H10N3NaO3S	251.0341	252.0414	250.0268	ESI+	2
305 Fenamiphos	22224-92-6	C13H22NO3PS	303.1058	304.1131	302.0985	ESI+	6
306 Fenamiphos-sulfone	31972-44-8	C13H22NO5PS	335.0956	336.1029	334.0883	ESI+	6
307 Fenamiphos-sulfoxide	31972-43-7	C13H22NO4PS	319.1007	320.1080	318.0934	ESI+	6
308 Fenarimol	60168-88-9	C17H12Cl2N2O	330.0327	331.0400	329.0254	ESI+	12
309 Fenazaquin	120928-09-8	C20H22N2O	306.1732	307.1805	305.1659	ESI+	6
310 Fenazox	495-48-7	C12H10N2O	198.0793	199.0866	197.0720	ESI+	6
311 Fenbuconazole	114369-43-6	C19H17ClN4	336.1142	337.1215	335.1069	ESI+	8
312 Fenbutatin-oxide	13356-08-6	C60H78Osn2	1054.4121	1055.4194	1053.4048	ESI+	11
313 Fenchlorazol-ethyl	103112-35-2	C12H8Cl5N3O2	400.9059	401.9132	399.8986	ESI+	118
314 Fenfuram	24691-80-3	C12H11NO2	201.0790	202.0863	200.0717	ESI+	6
315 Fenhexamid	126833-17-8	C14H17Cl2NO2	301.0636	302.0709	300.0563	ESI+	23
316 Fenitrothion	122-14-5	C9H12NO5PS	277.0174	278.0247	276.0101	ESI+	2
317 Fenobucarb	3766-81-2	C12H17NO2	207.1259	208.1332	206.1186	ESI+	6
318 Fenoprop	93-72-1	C9H7Cl3O3	267.9461	268.9534	266.9388	ESI-	8
319 Fenothiocarb	62850-32-2	C13H19NO2S	253.1136	254.1209	252.1063	ESI+	4
320 Fenoxanil	115852-48-7	C15H18Cl2N2O2	328.0745	329.0818	327.0672	ESI+	29
321 Fenoxaprop	95617-09-7	C16H12ClNO5	333.0404	334.0477	332.0331	ESI+	23
322 Fenoxaprop-ethyl	66441-23-4	C18H16ClNO5	361.0717	362.0790	360.0644	ESI+	12
323 Fenoxaprop-P-ethyl	71283-80-2	C18H16ClNO5	361.0717	362.0790	360.0644	ESI+	12
324 Fenoxycarb	79127-80-3	C17H19NO4	301.1314	302.1387	300.1241	ESI+	6
325 Fenpropathrin	64257-84-7	C22H23NO3	349.1678	350.1751	348.1605	ESI+	11
326 Fenpropidin	67306-00-7	C19H31N	273.2457	274.2530	272.2384	ESI+	6
327 Fenpropimorph	67564-91-4	C20H33NO	303.2562	304.2635	302.2489	ESI+	6
328 Fensulfothion	115-90-2	C11H17O4PS2	308.0306	309.0379	307.0233	ESI+	6
329 Fensulfothion-oxon	6552-21-2	C11H17O5PS	292.0534	293.0607	291.0461	ESI+	6
330 Fensulfothion-oxon-sulfone	6132-17-8	C11H17O6PS	308.0483	309.0556	307.0410	ESI+	4
331 Fensulfothion-sulfone	14255-72-2	C11H17O5PS2	324.0255	325.0328	323.0182	ESI+	6
332 Fenthion	55-38-9	C10H15O3PS2	278.0200	279.0273	277.0127	ESI+	6
333 Fenthion-oxon	6552-12-1	C10H15O4PS	262.0429	263.0502	261.0356	ESI+	6
334 Fenthion-oxon-sulfone	14086-35-2	C10H15O6PS	294.0327	295.0400	293.0254	ESI+	12
335 Fenthion-oxon-sulfoxide	6552-13-2	C10H15O5PS	278.0378	279.0451	277.0305	ESI+	3
336 Fenthion-sulfone	3761-42-0	C10H15O5PS2	310.0099	311.0172	309.0026	ESI+	4
337 Fenthion-sulfoxide	3761-41-9	C10H15O4PS2	294.0149	295.0222	293.0076	ESI+	6
338 Fenuron	101-42-8	C9H12N2O	164.0950	165.1023	163.0877	ESI+	6
339 Fenvalerate	51630-58-1	C25H22ClNO3	419.1288	420.1361	418.1215	ESI+	6
340 Fipronil	120068-37-3	C12H4Cl2F6N4O5	435.9387	436.9460	434.9314	ESI-	12
341 Fipronil-desulfinyl	205650-65-3	C12H4Cl2F6N4	387.9717	388.9790	386.9644	ESI-	12
342 Fipronil-sulfide	120067-83-6	C12H4Cl2F6N4S	419.9438	420.9511	418.9365	ESI-	12
343 Fipronil-sulfone	120068-36-2	C12H4Cl2F6N4O2S	451.9336	452.9409	450.9263	ESI-	12
344 Flamprop-isopropyl	52756-22-6	C19H19ClFNO3	363.1037	364.1110	362.0964	ESI+	10
345 Flamprop-methyl	52756-25-9	C17H15ClFNO3	335.0724	336.0797	334.0651	ESI+	4
346 Flamprop-M-isopropyl	63782-90-1	C19H19ClFNO3	363.1037	364.1110	362.0964	ESI+	10
347 Flazasulfuron	104040-78-0	C13H12F3N5O5S	407.0511	408.0584	406.0438	ESI+	6
348 Floccoumafen	90035-08-8	C33H25F3O4	542.1705	543.1778	541.1632	ESI+	12
349 Flonicamid	158062-67-0	C9H6F3N3O	229.0463	230.0536	228.0390	ESI+	8
350 Florasulam	145701-23-1	C12H8F3N5O3S	359.0300	360.0373	358.0227	ESI+	2
351 Fluacrypyrim	229977-93-9	C20H21F3N2O5	426.1403	427.1476	425.1330	ESI+	6
352 Fluazifop	69335-91-7	C15H12F3NO4	327.0718	328.0791	326.0645	ESI+	12
353 Fluazifop-butyl	69806-50-4	C19H20F3NO4	383.1344	384.1417	382.1271	ESI+	6
354 Fluazifop-P (free acid)	83066-88-0	C15H12F3NO4	327.0718	328.0791	326.0645	ESI+	12
355 Fluazifop-P-butyl	79241-46-6	C19H20F3NO4	383.1344	384.1417	382.1271	ESI+	6
356 Fluazinam	79622-59-6	C13H4Cl2F6N4O4	463.9514	464.9587	462.9441	ESI-	12
357 Fluazuron	86811-58-7	C20H10Cl2F5N3O3	505.0019	506.0092	503.9946	ESI+	17
358 Flubendiamide	272451-65-7	C23H22F7IN2O4S	682.0233	683.0306	681.0160	ESI+	5
359 Flucycloxuron	94050-52-9	C25H20ClF2N3O3	483.1161	484.1234	482.1088	ESI+	10
360 Flucythrinate	70124-77-5	C26H23F2NO4	451.1595	452.1668	450.1522	ESI+	4
361 Fludioxonil	131341-86-1	C12H6F2N2O2	248.0397	249.0470	247.0324	ESI-	6
362 Flufenacet	142459-58-3	C14H13F4N3O2S	363.0665	364.0738	362.0592	ESI+	6
363 Flufenoxuron	101463-69-8	C21H11ClF6N2O3	488.0362	489.0435	487.0289	ESI+	8
364 Flumetralin	62924-70-3	C16H12ClF4N3O4	421.0452	422.0525	420.0379	ESI+	3
365 Flumetsulam	98967-40-9	C12H9F2N5O2S	325.0445	326.0518	324.0372	ESI+	2
366 Flumioxazin	103361-09-7	C19H15FN2O4	354.1016	355.1089	353.0943	ESI+	2
367 Fluometuron	2164-17-2	C10H11F3N2O	232.0823	233.0896	231.0750	ESI+	4
368 Fluopicolide	239110-15-7	C14H8Cl3F3N2O	381.9654	382.9727	380.9581	ESI+	11
369 Fluopyram	658066-35-4	C16H11ClF6N2O	396.0464	397.0537	395.0391	ESI+	12
370 Fluoroglycofen-ethyl	77501-90-7	C18H13ClF3NO7	447.0333	448.0406	446.0260	ESI+	12
371 Fluoxastrobin	361377-29-9	C21H16ClFN4O5	458.0793	459.0866	457.0720	ESI+	12
372 Flupyrsulfuron-methyl	144740-54-5	C15H14F3N5O7S	465.0566	466.0639	464.0493	ESI+	12
373 Fluquinconazole	136426-54-5	C16H8Cl2FN5O	375.0090	376.0163	374.0017	ESI+	10
374 Fluridone	59756-60-4	C19H14F3NO	329.1027	330.1100	328.0954	ESI+	4
375 Flurochloridone	61213-25-0	C12H10Cl2F3NO	311.0092	312.0165	310.0019	ESI+	18

	Compound	CAS	Formula	M	[M+H] ⁺	[M-H] ⁻	Ionisation Mode	MRM Transitions
376	Fluroxypyr	69377-81-7	C7H5Cl2FN2O3	253.9661	254.9734	252.9588	ESI+	15
377	Fluroxypyr-1-methylheptylester	81406-37-3	C15H21Cl2FN2O3	366.0913	367.0986	365.0840	ESI+	12
378	Flurprimidol	56425-91-3	C15H15F3N2O2	312.1086	313.1159	311.1013	ESI+	6
379	Flurtamone	96525-23-4	C18H14F3NO2	333.0977	334.1050	332.0904	ESI+	6
380	Flusilazole	85509-19-9	C16H15F2N3Si	315.1003	316.1076	314.0930	ESI+	6
381	Fluthiacet-methyl	117337-19-6	C15H15ClF3N3O3S2	403.0227	404.0300	402.0154	ESI+	9
382	Flutolanil	66332-96-5	C17H16F3NO2	323.1133	324.1206	322.1060	ESI+	12
383	Flutriafol	76674-21-0	C16H13F2N3O	301.1027	302.1100	300.0954	ESI+	5
384	Fluxapyroxad	907204-31-3	C18H12F5N3O	381.0901	382.0974	380.0828	ESI+	11
385	Fomesafen	72178-02-0	C15H10ClF3N2O6S	437.9900	438.9973	436.9827	ESI+	21
386	Fonofos	944-22-9	C10H15OPS2	246.0302	247.0375	245.0229	ESI+	5
387	Foramsulfuron	173159-57-4	C17H20N6O7S	452.1114	453.1187	451.1041	ESI+	6
388	Forchlorfenuron	68157-60-8	C12H10ClN3O	247.0512	248.0585	246.0439	ESI+	12
389	Fosetyl-aluminium	39148-24-8	C2H7O3P	110.0133	111.0206	109.0060	ESI-	3
390	Fosthiazate	98886-44-3	C9H18NO3PS2	283.0466	284.0539	282.0393	ESI+	6
391	Fuberidazole	3878-19-1	C11H8N2O	184.0637	185.0710	183.0564	ESI+	6
392	Furalaxyl	57646-30-7	C17H19NO4	301.1314	302.1387	300.1241	ESI+	3
393	Furametpyr	123572-88-3	C17H20ClN3O2	333.1244	334.1317	332.1171	ESI+	12
394	Furathiocarb	65907-30-4	C18H26N2O5S	382.1562	383.1635	381.1489	ESI+	6
395	Furmecyclox	60568-05-0	C14H21NO3	251.1521	252.1594	250.1448	ESI+	6
396	Gibberellic acid (Gibberellin)	77-06-5	C19H22O6	346.1416	347.1489	345.1343	ESI-	11
397	Glufosinate	77182-82-2	C5H12NO4P	181.0504	182.0577	180.0431	ESI+	10
398	Glyphosate	1071-83-6	C3H8NO5P	169.0140	170.0213	168.0067	ESI+	8
399	Halofenozide	112226-61-6	C18H19ClN2O2	330.1135	331.1208	329.1062	ESI+	12
400	Halosulfuron-methyl	100784-20-1	C13H15ClN6O7S	434.0411	435.0484	433.0338	ESI+	11
401	Haloxyfop	69806-34-4	C15H11ClF3NO4	361.0329	362.0402	360.0256	ESI+	9
402	Haloxyfop-2-ethoxyethyl	87237-48-7	C19H19ClF3NO5	433.0904	434.0977	432.0831	ESI+	12
403	Haloxyfop-methyl	69806-40-2	C16H13ClF3NO4	375.0485	376.0558	374.0412	ESI+	12
404	Haloxyfop-R-methyl	72619-32-0	C16H13ClF3NO4	375.0485	376.0558	374.0412	ESI+	12
405	Heptenophos	23560-59-0	C9H12ClO4P	250.0162	251.0235	249.0089	ESI+	9
406	Hexaconazole	79983-71-4	C14H17Cl2N3O	313.0749	314.0822	312.0676	ESI+	10
407	Hexaflumuron	86479-06-3	C16H8Cl2F6N2O3	459.9816	460.9889	458.9743	ESI-	12
408	Hexazinone	51235-04-2	C12H20N4O2	252.1586	253.1659	251.1513	ESI+	3
409	Hexythiazox	78587-05-0	C17H21ClN2O2S	352.1012	353.1085	351.0939	ESI+	11
410	Hydramethylnon	67485-29-4	C25H24F6N4	494.1905	495.1978	493.1832	ESI+	12
411	Hymexazol	10004-44-1	C4H5NO2	99.0320	100.0393	98.0247	ESI+	3
412	Imazalil	35554-44-0	C14H14Cl2N2O	296.0483	297.0556	295.0410	ESI+	12
413	Imazamethabenz-methyl	81405-85-8	C16H20N2O3	288.1474	289.1547	287.1401	ESI+	12
414	Imazamox	114311-32-9	C15H19N3O4	305.1376	306.1449	304.1303	ESI+	10
415	Imazapic	104098-48-8	C14H17N3O3	275.1270	276.1343	274.1197	ESI+	11
416	Imazapyr	81334-34-1	C13H15N3O3	261.1113	262.1186	260.1040	ESI+	11
417	Imazaquin	81335-37-7	C17H17N3O3	311.1270	312.1343	310.1197	ESI+	6
418	Imazethapyr	81335-77-5	C15H19N3O3	289.1426	290.1499	288.1353	ESI+	12
419	Imazosulfuron	122548-33-8	C14H13ClN6O5S	412.0357	413.0430	411.0284	ESI+	13
420	Imibenconazole	86598-92-7	C17H13Cl3N4S	409.9927	411.0000	408.9854	ESI+	22
421	Imidacloprid	138261-41-3	C9H10ClN5O2	255.0523	256.0596	254.0450	ESI+	8
422	Indanofan	133220-30-1	C20H17ClO3	340.0866	341.0939	339.0793	ESI+	6
423	Indoxacarb	173584-44-6	C22H17ClF3N3O7	527.0707	528.0780	526.0634	ESI+	12
424	Iodosulfuron-methyl	144550-36-7	C14H14IN5O6S	506.9710	507.9783	505.9637	ESI+	8
425	Ioxynil	1689-83-4	C7H3J2NO	370.8304	371.8377	369.8231	ESI-	4
426	Iproconazole	125225-28-7	C18H24ClN3O	333.1608	334.1681	332.1535	ESI+	5
427	Iprobenfos	26087-47-8	C13H21O3PS	288.0949	289.1022	287.0876	ESI+	3
428	Iprodione	36734-19-7	C13H13Cl2N3O3	329.0334	330.0407	328.0261	ESI+	4
429	Iprovalicarb	140923-17-7	C18H28N2O3	320.2100	321.2173	319.2027	ESI+	6
430	Irgarol 1051	28159-98-0	C11H19N5S	253.1361	254.1434	252.1288	ESI+	6
431	Isazofos	42509-80-8	C9H17ClN3O3PS	313.0417	314.0490	312.0344	ESI+	12
432	Isocarbamid	30979-48-7	C8H15N3O2	185.1164	186.1237	184.1091	ESI+	6
433	Isocarbofos	24353-61-5	C11H16NO4PS	289.0538	290.0611	288.0465	ESI+	6
434	Isofenphos	25311-71-1	C15H24NO4PS	345.1164	346.1237	344.1091	ESI+	6
435	Isofenphos-methyl	99675-03-3	C14H22NO4PS	331.1007	332.1080	330.0934	ESI+	6
436	Isofenphos-oxon	31120-85-1	C15H24NO5P	329.1392	330.1465	328.1319	ESI+	3
437	Isomethiozin	57052-04-7	C12H20N4O5S	268.1358	269.1431	267.1285	ESI+	6
438	Isonoruron	28805-78-9	C13H22N2O	222.1732	223.1805	221.1659	ESI+	6
439	Isoprocab	2631-40-5	C11H15NO2	193.1103	194.1176	192.1030	ESI+	3
440	Isopropalin	33820-53-0	C15H23N3O4	309.1689	310.1762	308.1616	ESI+	6
441	Isoprothiolane	50512-35-1	C12H18O4S2	290.0647	291.0720	289.0574	ESI+	6
442	Isoproturon	34123-59-6	C12H18N2O	206.1419	207.1492	205.1346	ESI+	6
443	Isopyrazam	881685-58-1	C20H23F2N3O	359.1809	360.1882	358.1736	ESI+	9
444	Isoxaben	82558-50-7	C18H24N2O4	332.1736	333.1809	331.1663	ESI+	6
445	Isoxadifen-ethyl	163520-33-0	C18H17NO3	295.1208	296.1281	294.1135	ESI+	12
446	Isoxaflutole	141112-29-0	C15H12F3NO4S	359.0439	360.0512	358.0366	ESI+	5
447	Isoxathion	18854-01-8	C13H16NO4PS	313.0538	314.0611	312.0465	ESI+	6
448	Ivermectine	70288-86-7	C48H74O14	874.5079	875.5152	873.5006	ESI+	6
449	Karbutilate	4849-32-5	C14H21N3O3	279.1583	280.1656	278.1510	ESI+	16
450	Kasugamycin	6980-18-3	C14H25N3O9	379.1591	380.1664	378.1518	ESI+	3

Compound	CAS	Formula	M	[M+H] ⁺	[M-H] ⁻	Ionisation Mode	MRM Transitions
451 Kresoxim-methyl	143390-89-0	C18H19NO4	313.1314	314.1387	312.1241	ESI+	6
452 Lactofen	77501-63-4	C19H15ClF3NO7	461.0489	462.0562	460.0416	ESI+	12
453 Lambda-Cyhalothrin	91465-08-6	C23H19ClF3NO3	448.1006	450.1079	448.0933	ESI+	4
454 Lenacil	2164-08-1	C13H18N2O2	234.1368	235.1441	233.1295	ESI+	6
455 Linuron	330-55-2	C9H10Cl2N2O2	248.0119	249.0192	247.0046	ESI+	12
456 Lufenuron	103055-07-8	C17H8Cl2F8N2O3	509.9784	510.9857	508.9711	ESI-	10
457 Malaoxon	1634-78-2	C10H19O7PS	314.0589	315.0662	313.0516	ESI+	6
458 Malathion	121-75-5	C10H19O6PS2	330.0361	331.0434	329.0288	ESI+	12
459 Maleic-hydrazide	123-33-1	C4H4N2O2	112.0273	113.0346	111.0200	ESI+	3
460 Mandipropamid	374726-62-2	C23H22ClNO4	411.1237	412.1310	410.1164	ESI+	12
461 MCPA (MCP)	94-74-6	C9H9ClO3	200.0240	201.0313	199.0167	ESI-	3
462 MCPA-butoxyethyl ester	19480-43-4	C15H21ClO4	300.1128	301.1201	299.1055	ESI+	12
463 MCPB	94-81-5	C11H13ClO3	228.0553	229.0626	227.0480	ESI-	3
464 Mecarbam	2595-54-2	C10H20NO5PS2	329.0521	330.0594	328.0448	ESI+	6
465 Mecoprop (MCP)	93-65-2	C10H11ClO3	214.0397	215.0470	213.0324	ESI-	2
466 Mecoprop-P	16484-77-8	C10H11ClO3	214.0397	215.0470	213.0324	ESI-	4
467 Mefenacet	73250-68-7	C16H14N2O2S	298.0776	299.0849	297.0703	ESI+	6
468 Mefenpyr-diethyl	135590-91-9	C16H18Cl2N2O4	372.0644	373.0717	371.0571	ESI+	24
469 Mefluidide	53780-34-0	C11H13F3N2O3S	310.0599	311.0672	309.0526	ESI+	10
470 Mepanipyrim	110235-47-7	C14H13N3	223.1109	224.1182	222.1036	ESI+	6
471 Mephosfolan	950-10-7	C8H16NO3PS2	269.0309	270.0382	268.0236	ESI+	6
472 Mepiquat	24307-26-4	C7H16N	114.1283	115.1356	113.1210	ESI+	6
473 Mepronil	55814-41-0	C17H19NO2	269.1416	270.1489	268.1343	ESI+	5
474 Meptyldinocap	6119-92-2	C18H24N2O6	364.1634	365.1707	363.1561	ESI-	6
475 Mesosulfuron-methyl	208465-21-8	C17H21N5O9S2	503.0781	504.0854	502.0708	ESI+	6
476 Mesotrione	104206-82-8	C14H13NO7S	339.0413	340.0486	338.0340	ESI+	6
477 Metaflumizone	139968-49-3	C24H16F6N4O2	506.1177	507.1250	505.1104	ESI+	6
478 Metalaxyl	57837-19-1	C15H21NO4	279.1471	280.1544	278.1398	ESI+	6
479 Metalaxyl-M	70630-17-0	C15H21NO4	279.1471	280.1544	278.1398	ESI+	6
480 Metamitron	41394-05-2	C10H10N4O	202.0855	203.0928	201.0782	ESI+	3
481 Metazachlor	67129-08-2	C14H16ClN3O	277.0982	278.1055	276.0909	ESI+	6
482 Metconazole	125116-23-6	C17H22ClN3O	319.1451	320.1524	318.1378	ESI+	4
483 Methabenzthiazuron	18691-97-9	C10H11N3OS	221.0623	222.0696	220.0550	ESI+	6
484 Methacrifos	62610-77-9	C7H13O5PS	240.0221	241.0294	239.0148	ESI+	12
485 Methamidophos	10265-92-6	C2H8NO2PS	141.0013	142.0086	139.9940	ESI+	6
486 Methfuroxam	28730-17-8	C14H15NO2	229.1103	230.1176	228.1030	ESI+	4
487 Methidathion	950-37-8	C6H11N2O4PS3	301.9619	302.9692	300.9546	ESI+	7
488 Methiocarb	2032-65-7	C11H15NO2S	225.0823	226.0896	224.0750	ESI+	6
489 Methiocarb-sulfone	2179-25-1	C11H15NO4S	257.0722	258.0795	256.0649	ESI+	9
490 Methiocarb-sulfoxide	2635-10-1	C11H15NO3S	241.0773	242.0846	240.0700	ESI+	6
491 Methomyl	16752-77-5	C5H10N2O2S	162.0463	163.0536	161.0390	ESI+	6
492 Methoprene	40596-69-8	C19H34O3	310.2508	311.2581	309.2435	ESI+	12
493 Methoprotryne	841-06-5	C11H21N5OS	271.1467	272.1540	270.1394	ESI+	6
494 Methoxyfenozide	161050-58-4	C22H28N2O3	368.2100	369.2173	367.2027	ESI+	6
495 Metobromuron	3060-89-7	C9H11BrN2O2	258.0004	259.0077	256.9931	ESI+	12
496 Metolachlor	51218-45-2	C15H22ClNO2	283.1339	284.1412	282.1266	ESI+	12
497 Metolcarb	1129-41-5	C9H11NO2	165.0790	166.0863	164.0717	ESI+	6
498 Metominostrobin	133408-50-1	C16H16N2O3	284.1161	285.1234	283.1088	ESI+	6
499 Metosulam	139528-85-1	C14H13Cl2N5O4S	417.0065	418.0138	415.9992	ESI+	24
500 Metoxuron	19937-59-8	C10H13ClN2O2	228.0666	229.0739	227.0593	ESI+	5
501 Metrafenone	220899-03-6	C19H21BrO5	408.0572	409.0645	407.0499	ESI+	12
502 Metribuzin	21087-64-9	C8H14N4OS	214.0888	215.0961	213.0815	ESI+	5
503 Metsulfuron-methyl	74223-64-6	C14H15N5O6S	381.0743	382.0816	380.0670	ESI+	6
504 Mevinphos	7786-34-7	C7H13O6P	224.0450	225.0523	223.0377	ESI+	5
505 Mexacarbate	315-18-4	C12H18N2O2	222.1368	223.1441	221.1295	ESI+	6
506 Molinate	2212-67-1	C9H17NOS	187.1031	188.1104	186.0958	ESI+	6
507 Monalide	7287-36-7	C13H18ClNO	239.1077	240.1150	238.1004	ESI+	20
508 Monocrotophos	6923-22-4	C7H14NO5P	223.0610	224.0683	222.0537	ESI+	12
509 Monolinuron	1746-81-2	C9H11ClN2O2	214.0509	215.0582	213.0436	ESI+	10
510 Monuron	150-68-5	C9H11ClN2O	198.0560	199.0633	197.0487	ESI+	10
511 Morpholine	110-91-8	C4H9NO	87.0684	88.0757	86.0611	ESI+	6
512 Moxidectin	113507-06-5	C37H53NO8	639.3771	640.3844	638.3698	ESI+	12
513 Myclobutanil	88671-89-0	C15H17ClN4	288.1142	289.1215	287.1069	ESI+	8
514 <i>N</i> -(2, 4-Dimethylphenyl) formamide	60397-77-5	C9H11NO	149.0841	150.0914	148.0768	ESI+	6
515 <i>N</i> -(2, 4-Dimethylphenyl) - <i>N'</i> -methylformamidine	33089-74-6	C10H14N2	162.1157	163.1230	161.1084	ESI+	6
516 <i>N, N'</i> -Diphenylurea	102-07-8	C13H12N2O	212.0950	213.1023	211.0877	ESI+	4
517 Naled	300-76-5	C4H7Br2Cl2O4P	377.7826	378.7899	376.7753	ESI+	6
518 Naproanilide	52570-16-8	C19H17NO2	291.1259	292.1332	290.1186	ESI+	2
519 Napropamide	15299-99-7	C17H21NO2	271.1572	272.1645	270.1499	ESI+	6
520 Naptalam	132-66-1	C18H13NO3	291.0895	292.0968	290.0822	ESI+	6
521 Neburon	555-37-3	C12H16Cl2N2O	274.0640	275.0713	273.0567	ESI+	9
522 Nicarbazin	330-95-0	C19H18N6O6	426.1288	427.1361	425.1215	ESI-	3
523 Nicosulfuron	111991-09-4	C15H18N6O6S	410.1009	411.1082	409.0936	ESI+	6
524 Nicotine	54-11-5	C10H14N2	162.1157	163.1230	161.1084	ESI+	6
525 Nitenpyram	150824-47-8	C11H15ClN4O2	270.0884	271.0957	269.0811	ESI+	6

Compound	CAS	Formula	M	[M+H] ⁺	[M-H] ⁻	Ionisation Mode	MRM Transitions
526 Nitralin	4726-14-1	C13H19N3O6S	345.0995	346.1068	344.0922	ESI+	12
527 Nitrothal-isopropyl	10552-74-6	C14H17NO6	295.1056	296.1129	294.0983	ESI+	6
528 Norflurazon	27314-13-2	C12H9ClF3N3O	303.0386	304.0459	302.0313	ESI+	16
529 Norflurazon-desmethyl	23576-24-1	C11H7ClF3N3O	289.0230	290.0303	288.0157	ESI+	12
530 Novaluron	116714-46-6	C17H9ClF8N2O4	492.0123	493.0196	491.0050	ESI+	18
531 Noviflumuron	121451-02-3	C17H7Cl2F9N2O3	527.9690	528.9763	526.9617	ESI-	6
532 Nuarimol	63284-71-9	C17H12ClF2N2O	314.0622	315.0695	313.0549	ESI+	11
533 Ofurace	58810-48-3	C14H16ClNO3	281.0819	282.0892	280.0746	ESI+	17
534 Omethoate	1113-02-6	C5H12NO4PS	213.0225	214.0298	212.0152	ESI+	4
535 Orbencarb	34622-58-7	C12H16ClNOS	257.0641	258.0714	256.0568	ESI+	12
536 Orthosulfamuron	213464-77-8	C16H20N6O6S	424.1165	425.1238	423.1092	ESI+	6
537 Oryzalin	19044-88-3	C12H18N4O6S	346.0947	347.1020	345.0874	ESI+	5
538 Oxabetrinil	94593-79-0	C12H12N2O3	232.0848	233.0921	231.0775	ESI+	2
539 Oxadiargyl	39807-15-3	C15H14Cl2N2O3	340.0381	341.0454	339.0308	ESI+	14
540 Oxadiazon	19666-30-9	C15H18Cl2N2O3	344.0694	345.0767	343.0621	ESI+	6
541 Oxadixyl	77732-09-3	C14H18N2O4	278.1267	279.1340	277.1194	ESI+	12
542 Oxamyl	23135-22-0	C7H13N3O3S	219.0678	220.0751	218.0605	ESI+	3
543 Oxasulfuron	144651-06-9	C17H18N4O6S	406.0947	407.1020	405.0874	ESI+	6
544 Oxaziclomefone	153197-14-9	C20H19Cl2NO2	375.0793	376.0866	374.0720	ESI+	2
545 Oxycarboxin	5259-88-1	C12H13NO4S	267.0565	268.0638	266.0492	ESI+	3
546 Oxydemeton-methyl	301-12-2	C6H15O4PS2	246.0149	247.0222	245.0076	ESI+	6
547 Paclobutrazol	76738-62-0	C15H20ClN3O	293.1295	294.1368	292.1222	ESI+	8
548 Paraoxon-ethyl	311-45-5	C10H14NO6P	275.0559	276.0632	274.0486	ESI+	6
549 Paraoxon-methyl	950-35-6	C8H10NO6P	247.0246	248.0319	246.0173	ESI+	3
550 Paraquat	1910-42-5	C12H14Cl2N2	256.0534	257.0607	255.0461	ESI+	5
551 Parathion	56-38-2	C10H14NO5PS	291.0330	292.0403	290.0257	ESI+	3
552 Pebulate	1114-71-2	C10H21NOS	203.1344	204.1417	202.1271	ESI+	6
553 Penconazole	66246-88-6	C13H15Cl2N3	283.0643	284.0716	282.0570	ESI+	12
554 Pencycuron	66063-05-6	C19H21ClN2O	328.1342	329.1415	327.1269	ESI+	10
555 Pendimethalin	40487-42-1	C13H19N3O4	281.1376	282.1449	280.1303	ESI+	6
556 Penoxsulam	219714-96-2	C16H14F5N5O5S	483.0636	484.0709	482.0563	ESI+	6
557 Pentachlorophenol	87-86-5	C6HCl5O	263.8470	264.8543	262.8397	ESI-	3
558 Pentoxazone	110956-75-7	C17H17ClFNO4	353.0830	354.0903	352.0757	ESI+	2
559 Permethrin	52645-53-1	C21H20Cl2O3	390.0790	391.0863	389.0717	ESI+	12
560 Pethoxamid	106700-29-2	C16H22ClNO2	295.1339	296.1412	294.1266	ESI+	7
561 Phenmedipham	13684-63-4	C16H16N2O4	300.1110	301.1183	299.1037	ESI+	6
562 Phenothrin	26002-80-2	C23H26O3	350.1882	351.1955	349.1809	ESI+	9
563 Phenthoate	2597-03-7	C12H17O4PS2	320.0306	321.0379	319.0233	ESI+	12
564 Phorate	298-02-2	C7H17O2PS3	260.0128	261.0201	259.0055	ESI+	6
565 Phorate-oxon	2600-69-3	C7H17O3PS2	244.0357	245.0430	243.0284	ESI+	6
566 Phorate-sulfone	2588-04-7	C7H17O4PS3	292.0027	293.0100	290.9954	ESI+	6
567 Phorate-sulfoxide	2588-03-6	C7H17O3PS3	276.0077	277.0150	275.0004	ESI+	6
568 Phosalone	2310-17-0	C12H15ClNO4PS2	366.9869	367.9942	365.9796	ESI+	12
569 Phosfolan	947-02-4	C7H14NO3PS2	255.0153	256.0226	254.0080	ESI+	6
570 Phosmet	732-11-6	C11H12NO4PS2	316.9945	318.0018	315.9872	ESI+	12
571 Phosphamidon	13171-21-6	C10H19ClNO5P	299.0689	300.0762	298.0616	ESI+	12
572 Phoxim	14816-18-3	C12H15N2O3PS	298.0541	299.0614	297.0468	ESI+	6
573 Picloram	1918-02-1	C6H3Cl3N2O2	239.9260	240.9333	238.9187	ESI+	9
574 Picolinafen	137641-05-5	C19H12F4N2O2	376.0835	377.0908	375.0762	ESI+	6
575 Picoxystrobin	117428-22-5	C18H16F3NO4	367.1031	368.1104	366.0958	ESI+	6
576 Pinoxaden	243973-20-8	C23H32N2O4	400.2362	401.2435	399.2289	ESI+	6
577 Piperonyl-butoxide	51-03-6	C19H30O5	338.2093	339.2166	337.2020	ESI+	12
578 Piperophos	24151-93-7	C14H28NO3PS2	353.1248	354.1321	352.1175	ESI+	6
579 Pirimicarb	23103-98-2	C11H18N4O2	238.1430	239.1503	237.1357	ESI+	3
580 Pirimicarb-desmethyl	30614-22-3	C10H16N4O2	224.1273	225.1346	223.1200	ESI+	6
581 Pirimicarb-desmethyl-formamido	27218-04-8	C11H16N4O3	252.1222	253.1295	251.1149	ESI+	2
582 Pirimiphos-ethyl	23505-41-1	C13H24N3O3PS	333.1276	334.1349	332.1203	ESI+	6
583 Pirimiphos-methyl	29232-93-7	C11H20N3O3PS	305.0963	306.1036	304.0890	ESI+	6
584 Prallethrin	23031-36-9	C19H24O3	300.1725	301.1798	299.1652	ESI+	6
585 Pretilachlor	51218-49-6	C17H26ClNO2	311.1652	312.1725	310.1579	ESI+	6
586 Primisulfuron-methyl	86209-51-0	C15H12F4N4O7S	468.0363	469.0436	467.0290	ESI+	9
587 Probenazole	27605-76-1	C10H9NO3S	223.0303	224.0376	222.0230	ESI+	4
588 Prochloraz	67747-09-5	C15H16Cl3N3O2	375.0308	376.0381	374.0235	ESI+	15
589 Profenofos	41198-08-7	C11H15BrClO3PS	371.9351	372.9424	370.9278	ESI+	12
590 Profoxydim	139001-49-3	C24H32ClNO4S	465.1741	466.1814	464.1668	ESI+	24
591 Promecarb	2631-37-0	C12H17NO2	207.1259	208.1332	206.1186	ESI+	6
592 Prometon	1610-18-0	C10H19N5O	225.1590	226.1663	224.1517	ESI+	6
593 Prometryn	7287-19-6	C10H19N5S	241.1361	242.1434	240.1288	ESI+	6
594 Propachlor	1918-16-7	C11H14ClNO	211.0764	212.0837	210.0691	ESI+	6
595 Propamocarb	24579-73-5	C9H20N2O2	188.1525	189.1598	187.1452	ESI+	6
596 Propanil	709-98-8	C9H9Cl2NO	217.0061	218.0134	215.9988	ESI+	9
597 Propaphos	7292-16-2	C13H21O4PS	304.0898	305.0971	303.0825	ESI+	10
598 Propaquizafop	111479-05-1	C22H22ClN3O5	443.1248	444.1321	442.1175	ESI+	12
599 Propargite	2312-35-8	C19H26O4S	350.1552	351.1625	349.1479	ESI+	6
600 Propazine	139-40-2	C9H16ClN5	229.1094	230.1167	228.1021	ESI+	6

Compound	CAS	Formula	M	[M+H] ⁺	[M-H] ⁻	Ionisation Mode	MRM Transitions
601 Propetamphos	31218-83-4	C10H20NO4PS	281.0851	282.0924	280.0778	ESI+	18
602 Propham	122-42-9	C10H13NO2	179.0946	180.1019	178.0873	ESI+	6
603 Propiconazole	60207-90-1	C15H17Cl2N3O2	341.0698	342.0771	340.0625	ESI+	12
604 Propisochlor	86763-47-5	C15H22ClNO2	283.1339	284.1412	282.1266	ESI+	12
605 Propoxur	114-26-1	C11H15NO3	209.1052	210.1125	208.0979	ESI+	6
606 Propoxycarbazono	181274-15-7	C15H18N4O7S	398.0896	399.0969	397.0823	ESI+	20
607 Propylene-thiourea	2122-19-2	C4H8N2S	116.0408	117.0481	115.0335	ESI+	6
608 Propyzamide	23950-58-5	C12H11Cl2NO	255.0218	256.0291	254.0145	ESI+	10
609 Proquinazid	189278-12-4	C14H17IN2O2	372.0335	373.0408	371.0262	ESI+	6
610 Prosulfocarb	52888-80-9	C14H21NOS	251.1344	252.1417	250.1271	ESI+	4
611 Prosulfuron	94125-34-5	C15H16F3N5O4S	419.0875	420.0948	418.0802	ESI+	7
612 Prothioconazole	178928-70-6	C14H15Cl2N3OS	343.0313	344.0386	342.0240	ESI+	10
613 Prothioconazole-desthio	120983-64-4	C14H15Cl2N3O	311.0592	312.0665	310.0519	ESI+	10
614 Prothiophos	34643-46-4	C11H15Cl2O2PS2	343.9628	344.9701	342.9555	ESI+	12
615 Prothoate	2275-18-5	C9H20NO3PS2	285.0622	286.0695	284.0549	ESI+	6
616 Pymetrozine	123312-89-0	C10H11N5O	217.0964	218.1037	216.0891	ESI+	4
617 Pyracarbolid	24691-76-7	C13H15NO2	217.1103	218.1176	216.1030	ESI+	3
618 Pyraclufos	89784-60-1	C14H18ClN2O3PS	360.0464	361.0537	359.0391	ESI+	12
619 Pyraclostrobin	175013-18-0	C19H18ClN3O4	387.0986	388.1059	386.0913	ESI+	11
620 Pyraflufen-ethyl	129630-19-9	C15H13Cl2F3N2O4	412.0204	413.0277	411.0131	ESI+	12
621 Pyrasulfotole	365400-11-9	C14H13F3N2O4S	362.0548	363.0621	361.0475	ESI+	9
622 Pyrazolynate	58011-68-0	C19H16Cl2N2O4S	438.0208	439.0281	437.0135	ESI+	2
623 Pyrazophos	13457-18-6	C14H20N3O5PS	373.0861	374.0934	372.0788	ESI+	12
624 Pyrazosulfuron-ethyl	93697-74-6	C14H18N6O7S	414.0958	415.1031	413.0885	ESI+	6
625 Pyrazoxyfen	71561-11-0	C20H16Cl2N2O3	402.0538	403.0611	401.0465	ESI+	12
626 Pyributicarb	88678-67-5	C18H22N2O2S	330.1402	331.1475	329.1329	ESI+	6
627 Pyridaben	96489-71-3	C19H25ClN2OS	364.1376	365.1449	363.1303	ESI+	12
628 Pyridalyl	179101-81-6	C18H14Cl4F3NO3	488.9680	489.9753	487.9607	ESI+	18
629 Pyridaphenthion	119-12-0	C14H17N2O4PS	340.0647	341.0720	339.0574	ESI+	6
630 Pyridate	55512-33-9	C19H23ClN2O2S	378.1169	379.1242	377.1096	ESI+	12
631 Pyrifenox	88283-41-4	C14H12Cl2N2O	294.0327	295.0400	293.0254	ESI+	8
632 Pyrifthalid	135186-78-6	C15H14N2O4S	318.0674	319.0747	317.0601	ESI+	2
633 Pyrimethanil	53112-28-0	C12H13N3	199.1109	200.1182	198.1036	ESI+	6
634 Pyrimidifen	105779-78-0	C20H28ClN3O2	377.1870	378.1943	376.1797	ESI+	12
635 Pyriminobac-methyl (E)	136191-64-5	C17H19N3O6	361.1274	362.1347	360.1201	ESI+	6
636 Pyriproxyfen	95737-68-1	C20H19NO3	321.1365	322.1438	320.1292	ESI+	6
637 Pyroquilon	57369-32-1	C11H11NO	173.0841	174.0914	172.0768	ESI+	6
638 Pyroxsulam	422556-08-9	C14H13F3N6O5S	434.0620	435.0693	433.0547	ESI+	6
639 Quinalphos	13593-03-8	C12H15N2O3PS	298.0541	299.0614	297.0468	ESI+	6
640 Quinclorac	84087-01-4	C10H5Cl2NO2	240.9697	241.9770	239.9624	ESI+	11
641 Quinmerac	90717-03-6	C11H8ClNO2	221.0244	222.0317	220.0171	ESI+	12
642 Quinoclamine	2797-51-5	C10H6ClNO2	207.0087	208.0160	206.0014	ESI+	19
643 Quinoxifen	124495-18-7	C15H8Cl2FNO	306.9967	308.0040	305.9894	ESI+	12
644 Quizalofop (free acid)	76578-12-6	C17H13ClN2O4	344.0564	345.0637	343.0491	ESI+	24
645 Quizalofop-ethyl	76578-14-8	C19H17ClN2O4	372.0877	373.0950	371.0804	ESI+	12
646 Quizalofop-methyl	76578-13-7	C18H15ClN2O4	358.0720	359.0793	357.0647	ESI+	12
647 Quizalofop-P	94051-08-8	C17H13ClN2O4	344.0564	345.0637	343.0491	ESI+	9
648 Quizalofop-P-ethyl	100646-51-3	C19H17ClN2O4	372.0877	373.0950	371.0804	ESI+	12
649 Rabenzazole	40341-04-6	C12H12N4	212.1062	213.1135	211.0989	ESI+	12
650 Resmethrin	10453-86-8	C22H26O3	338.1882	339.1955	337.1809	ESI+	6
651 Rimsulfuron	122931-48-0	C14H17N5O7S2	431.0569	432.0642	430.0496	ESI+	9
652 Rotenone	83-79-4	C23H22O6	394.1416	395.1489	393.1343	ESI+	6
653 Saflufenacil	372137-35-4	C17H17ClF4N4O5S	500.0544	501.0617	499.0471	ESI+	8
654 Sebuthylazine	7286-69-3	C9H16ClN5	229.1094	230.1167	228.1021	ESI+	6
655 Sebuthylazine-desethyl	37019-18-4	C7H12ClN5	201.0781	202.0854	200.0708	ESI+	12
656 Secbumeton	26259-45-0	C10H19NO5O	225.1590	226.1663	224.1517	ESI+	4
657 Sethoxydim	74051-80-2	C17H29NO3S	327.1868	328.1941	326.1795	ESI+	12
658 Siduron	1982-49-6	C14H20N2O	232.1576	233.1649	231.1503	ESI+	5
659 Silafluofen	105024-66-6	C25H29FO2Si	408.1921	409.1994	407.1848	ESI+	2
660 Silthiofam	175217-20-6	C13H21NOSSi	267.1113	268.1186	266.1040	ESI+	5
661 Simazine	122-34-9	C7H12ClN5	201.0781	202.0854	200.0708	ESI+	12
662 Simazine-2-hydroxy	2599-11-3	C7H13N5O	183.1120	184.1193	182.1047	ESI+	5
663 Simeconazole	149508-90-7	C14H20FN3OSi	293.1360	294.1433	292.1287	ESI+	6
664 Simetryn	1014-70-6	C8H15N5S	213.1048	214.1121	212.0975	ESI+	4
665 Spinetoram A	187166-40-1	C42H69NO10	747.4921	748.4994	746.4848	ESI+	2
666 Spinetoram B	187166-15-0	C43H69NO10	759.4921	760.4994	758.4848	ESI+	3
667 Spinosyn A	131929-60-7	C41H65NO10	731.4608	732.4681	730.4535	ESI+	4
668 Spinosyn D	131929-63-0	C42H67NO10	745.4765	746.4838	744.4692	ESI+	4
669 Spirodiclofen	148477-71-8	C21H24Cl2O4	410.1052	411.1125	409.0979	ESI+	11
670 Spiromesifen	283594-90-1	C23H30O4	370.2144	371.2217	369.2071	ESI+	4
671 Spirotetramat	203313-25-1	C21H27NO5	373.1889	374.1962	372.1816	ESI+	6
672 Spiroxamine	118134-30-8	C18H35NO2	297.2668	298.2741	296.2595	ESI+	6
673 Sulcotrione	99105-77-8	C14H13ClO5S	328.0172	329.0245	327.0099	ESI+	2
674 Sulfallate	95-06-7	C8H14ClNS2	223.0256	224.0329	222.0183	ESI+	9
675 Sulfaquinoxaline	59-40-5	C14H12N4O2S	300.0681	301.0754	299.0608	ESI+	6

Compound	CAS	Formula	M	[M+H] ⁺	[M-H] ⁻	Ionisation Mode	MRM Transitions
676 Sulfometuron-methyl	74222-97-2	C15H16N4O5S	364.0841	365.0914	363.0768	ESI+	6
677 Sulfosulfuron	141776-32-1	C16H18N6O7S2	470.0678	471.0751	469.0605	ESI+	6
678 Sulfotep	3689-24-5	C8H20O5P2S2	322.0227	323.0300	321.0154	ESI+	6
679 Sulprofos	35400-43-2	C12H19O2PS3	322.0285	323.0358	321.0212	ESI+	6
680 Tau-Fluvalinate	102851-06-9	C26H22ClF3N2O3	502.1271	503.1344	501.1198	ESI+	15
681 Tebuconazole	107534-96-3	C16H22ClN3O	307.1451	308.1524	306.1378	ESI+	10
682 Tebufenozide	112410-23-8	C22H28N2O2	352.2151	353.2224	351.2078	ESI+	6
683 Tebufenpyrad	119168-77-3	C18H24ClN3O	333.1608	334.1681	332.1535	ESI+	12
684 Tebupirimfos	96182-53-5	C13H23N2O3PS	318.1167	319.1240	317.1094	ESI+	6
685 Tebutam	35256-85-0	C15H23NO	233.1780	234.1853	232.1707	ESI+	6
686 Tebuthiuron	34014-18-1	C9H16N4OS	228.1045	229.1118	227.0972	ESI+	6
687 Teflubenzuron	83121-18-0	C14H6Cl2F4N2O2	379.9742	380.9815	378.9669	ESI-	12
688 Tembotrione	335104-84-2	C17H16ClF3O6S	440.0308	441.0381	439.0235	ESI+	12
689 Temphos	3383-96-8	C16H20O6P2S3	465.9897	466.9970	464.9824	ESI+	6
690 Tepraloxymdim	149979-41-9	C17H24ClNO4	341.1394	342.1467	340.1321	ESI+	8
691 Terbacil	5902-51-2	C9H13ClN2O2	216.0666	217.0739	215.0593	ESI-	10
692 Terbucarb	1918-11-2	C17H27NO2	277.2042	278.2115	276.1969	ESI+	12
693 Terbufos	13071-79-9	C9H21O2PS3	288.0441	289.0514	287.0368	ESI+	5
694 Terbufos-sulfone	56070-16-7	C9H21O4PS3	320.0340	321.0413	319.0267	ESI+	6
695 Terbufos-sulfoxide	10548-10-4	C9H21O3PS3	304.0390	305.0463	303.0317	ESI+	6
696 Terbumeton	33693-04-8	C10H19N5O	225.1590	226.1663	224.1517	ESI+	6
697 Terbumeton-desethyl	30125-64-5	C8H15N5O	197.1277	198.1350	196.1204	ESI+	3
698 Terbutylazine	5915-41-3	C9H16ClN5	229.1094	230.1167	228.1021	ESI+	10
699 Terbutylazine-2-hydroxy	66753-07-9	C9H17N5O	211.1433	212.1506	210.1360	ESI+	6
700 Terbutylazine-desethyl	30125-63-4	C7H12ClN5	201.0781	202.0854	200.0708	ESI+	12
701 Terbutryn	886-50-0	C10H19N5S	241.1361	242.1434	240.1288	ESI+	6
702 Tetrachlorvinphos (CVMP)	22248-79-9	C10H9Cl4O4P	363.8993	364.9066	362.8920	ESI+	16
703 Tetraconazole	112281-77-3	C13H11Cl2F4N3O	371.0215	372.0288	370.0142	ESI+	7
704 Tetraethylpyrophosphate	107-49-3	C8H20O7P2	290.0684	291.0757	289.0611	ESI+	6
705 Tetramethrin	7696-12-0	C19H25NO4	331.1784	332.1857	330.1711	ESI+	12
706 Thenylchlor	96491-05-3	C16H18ClNO2S	323.0747	324.0820	322.0674	ESI+	12
707 Thiabendazole	148-79-8	C10H7N3S	201.0361	202.0434	200.0288	ESI+	6
708 Thiacloprid	111988-49-9	C10H9ClN4S	252.0236	253.0309	251.0163	ESI+	6
709 Thiamethoxam	153719-23-4	C8H10ClN5O3S	291.0193	292.0266	290.0120	ESI+	12
710 Thiazafurion	25366-23-8	C6H7F3N4OS	240.0293	241.0366	239.0220	ESI+	6
711 Thiazopyr	117718-60-2	C16H17F5N2O2S	395.0931	397.1004	395.0858	ESI+	6
712 Thidiazuron	51707-55-2	C9H8N4OS	220.0419	221.0492	219.0346	ESI+	6
713 Thien carbazono-methyl	317815-83-1	C12H14N4O7S2	390.0304	391.0377	389.0231	ESI+	3
714 Thifensulfuron-methyl	79277-27-3	C12H13N5O6S2	387.0307	388.0380	386.0234	ESI+	6
715 Thifluzamide	130000-40-7	C13H6Br2F6N2O2S	525.8421	526.8494	524.8348	ESI+	29
716 Thiobencarb	28249-77-6	C12H16ClNOS	257.0641	258.0714	256.0568	ESI+	11
717 Thiodicarb	59669-26-0	C10H18N4O4S3	354.0490	355.0563	353.0417	ESI+	6
718 Thiofanox	39196-18-4	C9H18N2O2S	218.1089	219.1162	217.1016	ESI+	2
719 Thiofanox-sulfone	39184-59-3	C9H18N2O4S	250.0987	251.1060	249.0914	ESI+	9
720 Thiofanox-sulfoxide	39184-27-5	C9H18N2O3S	234.1038	235.1111	233.0965	ESI+	12
721 Thiometon	640-15-3	C6H15O2PS3	245.9972	247.0045	244.9899	ESI+	2
722 Thionazin	297-97-2	C8H13N2O3PS	248.0384	249.0457	247.0311	ESI+	6
723 Thiophanate-ethyl	23564-06-9	C14H18N4O4S2	370.0769	371.0842	369.0696	ESI+	6
724 Thiophanate-methyl	23564-05-8	C12H14N4O4S2	342.0456	343.0529	341.0383	ESI+	6
725 Thiram	137-26-8	C6H12N2S4	239.9883	240.9956	238.9810	ESI+	6
726 Tolclofos-methyl	57018-04-9	C9H11Cl2O3PS	299.9544	300.9617	298.9471	ESI+	12
727 Tolyfluanid	731-27-1	C10H13Cl2FN2O2S2	345.9780	346.9853	344.9707	ESI+	22
728 Topramezone	210631-68-8	C16H17N3O5S	363.0889	364.0962	362.0816	ESI+	12
729 Tralkoxydim	87820-88-0	C20H27NO3	329.1991	330.2064	328.1918	ESI+	6
730 Tralomethrin	66841-25-6	C22H19Br4NO3	660.8098	661.8171	659.8025	ESI+	7
731 Triadimefon	43121-43-3	C14H16ClN3O2	293.0931	294.1004	292.0858	ESI+	12
732 Triadimenol	55219-65-3	C14H18ClN3O2	295.1088	296.1161	294.1015	ESI+	7
733 Tri-allate	2303-17-5	C10H16Cl3NOS	303.0018	304.0091	301.9945	ESI+	16
734 Triapenthenol	76608-88-3	C15H25N3O	263.1998	264.2071	262.1925	ESI+	12
735 Triasulfuron	82097-50-5	C14H16ClN5O5S	401.0561	402.0634	400.0488	ESI+	12
736 Triazamate	112143-82-5	C13H22N4O3S	314.1413	315.1486	313.1340	ESI+	4
737 Triazophos	24017-47-8	C12H16N3O3PS	313.0650	314.0723	312.0577	ESI+	6
738 Triazoxide	72459-58-6	C10H6ClN5O	247.0261	248.0334	246.0188	ESI+	11
739 Tribenuron-methyl	101200-48-0	C15H17N5O6S	395.0900	396.0973	394.0827	ESI+	5
740 Trichlorfon	52-68-6	C4H8Cl3O4P	255.9226	256.9299	254.9153	ESI+	10
741 Triclopyr	55335-06-3	C7H4Cl3NO3	254.9257	255.9330	253.9184	ESI-	2
742 Tricyclazole	41814-78-2	C9H7N3S	189.0361	190.0434	188.0288	ESI+	6
743 Tridemorph	81412-43-3	C19H39NO	297.3032	298.3105	296.2959	ESI+	6
744 Trietazine	1912-26-1	C9H16ClN5	229.1094	230.1167	228.1021	ESI+	6
745 Triethanolamine	102-71-6	C6H15NO3	149.1052	150.1125	148.0979	ESI+	6
746 Trifloxystrobin	141517-21-7	C20H19F3N2O4	408.1297	409.1370	407.1224	ESI+	6
747 Trifloxysulfuron	145099-21-4	C14H14F3N5O6S	437.0617	438.0690	436.0544	ESI+	9
748 Triflumizole	68694-11-1	C15H15ClF3N3O	345.0856	346.0929	344.0783	ESI+	9
749 Triflumizole Metabolite	131549-75-2	C12H14ClF3N2O	294.0747	295.0820	293.0674	ESI+	2
750 Triflumuron	64628-44-0	C15H10ClF3N2O3	358.0332	359.0405	357.0259	ESI+	8

Compound	CAS	Formula	M	[M+H] ⁺	[M-H] ⁻	Ionisation Mode	MRM Transitions
751 Triflusulfuron-methyl	126535-15-7	C17H19F3N6O6S	492.1039	493.1112	491.0966	ESI+	8
752 Triforine	26644-46-2	C10H14Cl6N4O2	431.9248	432.9321	430.9175	ESI+	7
753 Trinexapac-ethyl	95266-40-3	C13H16O5	252.0998	253.1071	251.0925	ESI+	6
754 Triphenyl phosphate	115-86-6	C18H15O4P	326.0708	327.0781	325.0635	ESI+	6
755 Tris (2-chloro-1-(chloromethyl)ethyl) phosphate	13674-87-8	C9H15Cl6O4P	427.8839	428.8912	426.8766	ESI+	26
756 Triticonazole	131983-72-7	C17H20ClN3O	317.1295	318.1368	316.1222	ESI+	9
757 Tritosulfuron	142469-14-5	C13H9F6N5O4S	445.0279	446.0352	444.0206	ESI+	4
758 Valifenalate	283159-90-0	C19H27ClN2O5	398.1608	399.1681	397.1535	ESI+	16
759 Vamidothion	2275-23-2	C8H18NO4PS2	287.0415	288.0488	286.0342	ESI+	6
760 Vamidothion-sulfone	70898-34-9	C8H18NO6PS2	319.0313	320.0386	318.0240	ESI+	6
761 Vamidothion-sulfoxide	20300-00-9	C8H18NO5PS2	303.0364	304.0437	302.0291	ESI+	6
762 Vernolate	1929-77-7	C10H21NOS	203.1344	204.1417	202.1271	ESI+	5
763 Warfarin	81-81-2	C19H16O4	308.1049	309.1122	307.0976	ESI+	6
764 XMC (3, 5-xyllyl methylcarbamate)	2655-14-3	C10H13NO2	179.0946	180.1019	178.0873	ESI+	12
765 Ziram	137-30-4	C6H12N2S4Zn	303.9175	304.9248	302.9102	ESI+	2
766 Zoxamide	156052-68-5	C14H16Cl3NO2	335.0247	336.0320	334.0174	ESI+	18

Further Information

Application News No.C136 describes the analysis of 646 pesticides in a single multi-residue method built using the Shimadzu Pesticide Library.

Scope and Legal Disclaimers

Whilst every effort has been made to ensure the accuracy of the Library, the method will need to be verified in a laboratory as conditions may differ marginally. The influence of sample matrices, extraction protocols, LC behaviour and technical experience may affect the performance of the LC/MS/MS analysis.

Shimadzu assumes no responsibility or contingent liability, including indirect or consequential damages, for any use to which the purchaser may put the referenced suppliers' products, or for any adverse circumstances arising therefrom.



For Research Use Only. Not for use in diagnostic procedure.

This publication may contain references to products that are not available in your country. Please contact us to check the availability of these products in your country.

The content of this publication shall not be reproduced, altered or sold for any commercial purpose without the written approval of Shimadzu. Company names, product/service names and logos used in this publication are trademarks and trade names of Shimadzu Corporation or its affiliates, whether or not they are used with trademark symbol "TM" or "@". Third-party trademarks and trade names may be used in this publication to refer to either the entities or their products/services. Shimadzu disclaims any proprietary interest in trademarks and trade names other than its own.

The information contained herein is provided to you "as is" without warranty of any kind including without limitation warranties as to its accuracy or completeness. Shimadzu does not assume any responsibility or liability for any damage, whether direct or indirect, relating to the use of this publication. This publication is based upon the information available to Shimadzu on or before the date of publication, and subject to change without notice.

Determining Gamma-Hydroxybutyric Acid and its Precursors Gamma-Butyrolactone and 1,4-Butanediol in Suspected Drug-spiked Beverages using LCMS-8045

Jianli Chen
Shimadzu (China), Shanghai Analysis Center

Application News
SSL-CA14-679

Abstract

This paper established a method to determine the quantity of gamma-hydroxybutyric acid and its precursors gamma-butyrolactone and 1,4-butanediol in suspected drug-spiked beverages using Shimadzu's Ultra-High Performance Liquid Chromatograph LC-30A and Triple Quadrupole Mass Spectrometer LCMS-8045. Analysis was completed within 2 min with good linearity. The standard samples at various concentrations were tested in 6 replicates, and the relative standard deviations of retention time and peak area were 0.26 – 0.48% and 0.70 – 2.31% respectively, showing good precision. The spike recovery of the sample was 92.6 – 104.3%. Given the fast analysis and accurate results acquired, this method can be used for the determination of gamma-hydroxybutyric acid and its precursors gamma-butyrolactone and 1,4-butanediol in beverages.

Media recently reported that energy drinks are being used as alcohol-substitute beverages in karaoke establishments (KTVs) and other entertainment venues. These beverages have been detected to contain high concentrations of gamma-hydroxybutyric acid (GHB) and gamma-butyrolactone (GBL). GHB is listed as a psychotropic drug strictly controlled in China. Substance abuse or drug misuse can cause temporary memory loss, nausea, vomiting, headache, loss of reflex, immediate loss of consciousness, coma and even death. In addition, the consumption of GHB with alcoholic beverage further increase these risks. Both GBL and 1,4-butanediol (1,4-BD) are precursors of GHB and they are rapidly metabolized to GHB inside the human body.

For all these reasons, it is necessary to accurately detect GHB and its precursors in beverages. Traditional detection methods mainly involve the use of GCMS, which requires derivatization of target

substances before sample analysis. In this paper, a rapid and accurate method using Shimadzu's LCMS-8045 is established to determine the quantity of GHB and its precursors in beverages. The method preparation is simple, which doesn't call for derivatization. Sample preparation consists of dilution and filtration of samples. The analysis is fast and ensures good precision, which is ideal for quantitative analysis of such drug substances in beverages.

EXPERIMENTAL

Instrumentation

The experiment used Shimadzu's UHPLC LC-30A and Triple Quadrupole Mass Spectrometer LCMS-8045. The specific configurations are LC-30ADx2 pumps, DGU-20A5 online degassing unit, SIL-20AC autosampler, CTO-20AC column oven, CBM-20A system controller, LCMS-8045 triple quadrupole mass spectrometer and LabSolutions Ver. 5.89 chromatographic workstation.

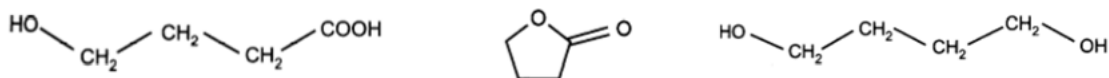

Figure 1 Structures of the target drug substances (left: GHB, middle: GBL, right: 1,4-BD)

Analytical Conditions

LC Chromatography (LC) Conditions

Column	: Shim-pack XR-ODS III (150 mm. Lx2.0 mm I.D., 2.2 µm)
Mobile phase	: Phase A - 0.1% acetic acid in water Phase B - acetonitrile
Flow rate	: 0.30 mL/min
Column Temp.	: 25 °C
Injection volume	: 10 µL
Elution method	: Isocratic elution, where the concentration of Phase B is 5%

Mass Spectrometry (MS) Conditions

Analytical Instrument	: LCMS-8045
Ion Source	: ESI, simultaneous scanning of positive and negative ions
Heating gas	: Air 10.0 L/min
Nebulizer gas	: Nitrogen 3.0 L/min
Drying gas	: Nitrogen 10.0 L/min
Scan mode	: Multiple reaction monitoring (MRM)
Dwell time	: 50 ms
DL temp.	: 200 °C
Heating block temp.	: 400 °C
Scan mode	: Multiple reaction monitoring (MRM)
Dwell time	: 50 ms
Collisions gas	: Argon
Interface temp.	: 300 °C
DL temp.	: 200 °C
Heat block temp.	: 400 °C
Delay time	: 3 ms
MRM Parameters	: Refer to Table 1

Standard solution preparation

Preparation of Standard Working Solutions: The drug standards were weighed and dissolved in methanol or ultra-pure water to give a standard stock solution at concentration of 1000 µg/mL. The stock solution were further diluted with ultra-pure water to obtain standard working solutions of the following concentrations: 1.0, 2.0, 5.0, 10.0, 20.0, 50.0, 100.0, 200.0, 500.0 ng/mL.

Sample Preparation Method

1mL of the beverage sample were collected and diluted with ultra-pure water. The solution was filtered with a 0.22 µm filter membrane prior to analysis.

RESULTS AND DISCUSSION

MRM Chromatogram of Standard Drug Samples

The MRM chromatogram is shown in Figure 2.

Calibration Curve and Linear Range

A series of standard solutions with concentrations of 1.0, 2.0, 5.0, 10.0, 20.0, 50.0, 100.0, 200.0 and 500.0 ng/ml were prepared and injected for analysis according to the conditions in the experimental section and quantified with external standard calibration method. A calibration curve, shown in Figure 3, was plotted showing peak area against concentration. The linear equation, linear range, and correlation coefficients are shown in Table 2.

Table 1 MRM optimized parameters

Compound	Ionization Mode	Precursor Ion	Product Ion	Q1 Pre Bias (V)	CE (V)	Q3 Pre Bias (V)
Gamma-Hydroxybutyric Acid (GHB)	ESI (-)	103.1	85.1*	10.0	15.0	11.0
			57.1	10.0	12.0	16.0
Gamma-Butyrolactone (GBL)	ESI (+)	87.2	45.1*	-13.0	-25.0	-18.0
			43.1	-15.0	-25.0	-20.0
1,4-Butanediol (1,4-DB)	ESI (+)	91.2	55.1*	-15.0	-12.0	-22.0
			73.1	-15.0	-10.0	-13.0

Note: * indicates quantification ion

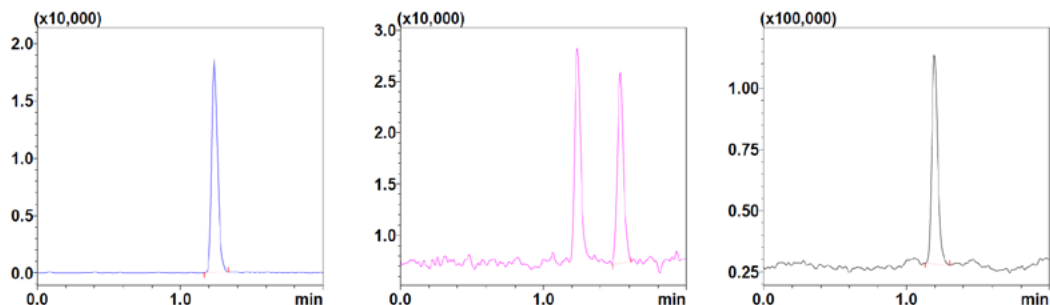

Figure 2 Chromatogram of 20 ng/ml standard samples (left: GHB, middle: GBL, right: 1,4-BD)

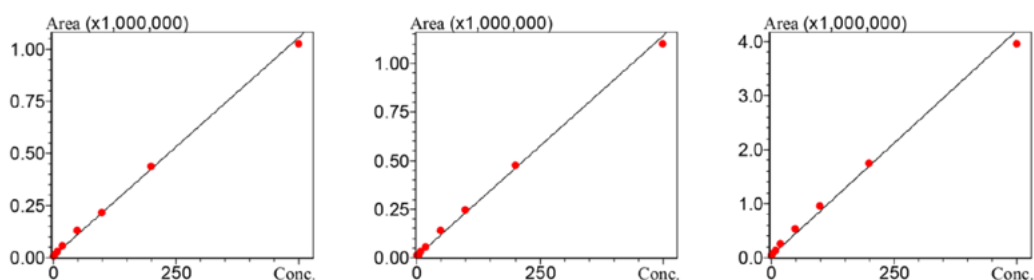

Figure 3 Calibration curve (left: GHB, middle: GBL, right: 1,4-BD)

Table 2 Parameters of the calibration curve

Compound Name	Calibration curve	Linear range (ng/mL)	Correlation coefficient (R)	Accuracy (%)
GHB	$Y = (2413.4) X + (945.6)$	1-500	0.9979	85.4-111.1
GBL	$Y = (2379.9) X + (3704.9)$	2-500	0.9982	88.3-114.6
1,4-BD	$Y = (10000.5) X + (9547.5)$	2-500	0.9986	86.7-113.6

Precision Test

The standard samples with concentrations of 10.0 and 200 ng/ml were consecutively injected for 6 times to investigate the repeatability; and the result of retention time and peak area were shown as Table 3. It shows good repeatability.

Table 3 Repeatability results of retention time and peak area (n=6)

Compound Name	RSD% (10 ng/ml)		RSD% (200 ng/ml)	
	R.T.	Area	R.T.	Area
GHB	0.47	2.31	0.41	0.81
GBL	0.30	2.08	0.26	0.70
1,4-BD	0.44	1.87	0.48	0.97

Actual Sample Test and Spike Recovery Test

The samples were prepared and injected for analysis. The results are shown as Table 5. The spike recovery at a spiking concentration of 0.5 mg/mL was calculated.

CONCLUSION

A method was established in this paper to determine the quantity of gamma-hydroxybutyric acid and its precursors gamma-butyrolactone and 1,4-butanediol in suspected drug-spiked beverages using Shimadzu's UHPLC LC-30A and Triple Quadrupole Mass Spectrometer LCMS-8045. Analysis was completed within 2 min with good linearity. The standard samples at various concentrations were tested in

Table 5 Sample detection and spike recovery test

Compound Name	Detected concentration (µg/ml)	Dilution Factor	Actual Sample concentration (mg/ml)	Spiking concentration (mg/ml)	Detected concentration of spiked samples (mg/ml)	Recovery (%)
GHB	0.11		0.44	0.50	0.91	93.1
GBL	0.18	4000	0.70	0.50	1.23	104.3
1,4-BD	N.D.		N.D.	0.50	0.46	92.6

Note: The samples were provided by the Drug Control Branch of the Wuhan Municipal Public Security Bureau
N.D. = Not detected

6 replicates, and the relative standard deviations of retention time and peak area were 0.26 – 0.48% and 0.70 – 2.31% respectively, showing good precision. The spike recovery of the sample was in the range of 92.6 – 104.3%. Given the fast analysis and accurate results acquired, this method can be used for the determination of gamma-hydroxybutyric acid and its precursors gamma-butyrolactone and 1,4-butanediol in beverages.

Application News

Sum parameter – Total Organic Carbon

Carbon dioxide determination in beer

No. SCA-130-403

Carbon dioxide is an important ingredient in many soft drinks. This is also the case for beer. It creates a sparkling and refreshing (tangy) taste and is important for the formation of foam.

The CO₂ content of a beer affects the threshold values for various fragrance and aroma components. In addition, bottling under CO₂ increases the shelf life of beer..



In the manual of the 'central- European brewery technological analysis commission' (MEBAK) various methods for the determination of CO₂ are listed. These are generally based on manometric or titrimetric method, or they are methods that use specialized detectors.

Disadvantages of these methods are often the lack of selectivity for CO₂ (other gases or substances are also determined), high expenditure in terms of personnel and time, and the lack of possibilities for automation.

In order to develop a method that does not have these disadvantages, a TOC analyzer was used.

■ Innovative methods

In this method, the sample (beer) is directly placed in a 40 mL autosampler vial. 5 mL of a 32% NaOH solution was added to the autosampler vial to preserve the CO₂.

The sample is subsequently added directly to the autosampler and the IC (inorganic carbon) content is measured.



Preservation step:

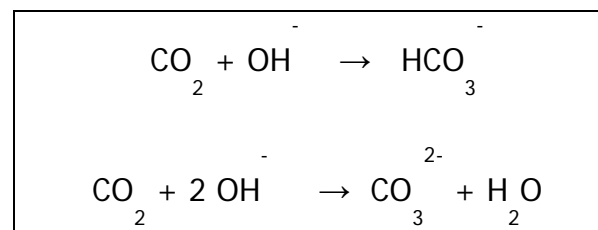

In the TOC analyzer, the sample is injected in a concentrated phosphoric acid solution (25%). The CO₂ is subsequently released again and is transferred via the carrier gas to a CO₂-selective NIDR detector where it is detected.

Displacement reaction: (the strong acid displaces the weak acid from its salt)

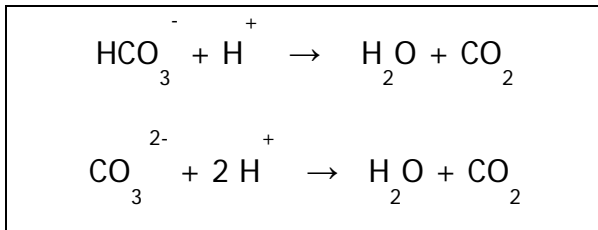

To calculate the results, the IC function of the TOC system is calibrated using a sodium hydrogen carbonate standard in the range of 100 – 1000 mg/L. The dilution of the individual calibration points is performed automatically via the dilution function of the instrument.

■ Advantages of this method

- can be automated to a high degree
- fast
- good reproducibility and high accuracy (precision)
- multiple determinations from one sample is possible
- effortless calibration
- simple operation
- highly specific

Using the modern TOC-L software, evaluation can be carried out automatically or can be recalculated manually. Another function enables further processing of the measurement results. This way the carbon dioxide content can be directly presented in the desired dimension. Due to the possibility for multiple injections, the evaluation contains all the important statistical quantities

Another sample preparation variant is to be carried out during the determination of carbon

dioxide in bottled or canned beer. In this step, 5 mL of a 32% solution of NaOH was directly added to the freshly opened bottle or can for preservation.

■ Comparison of the methods

The following graph shows the good agreement between the TOC method (blue bars) and the Corning method (green bars).

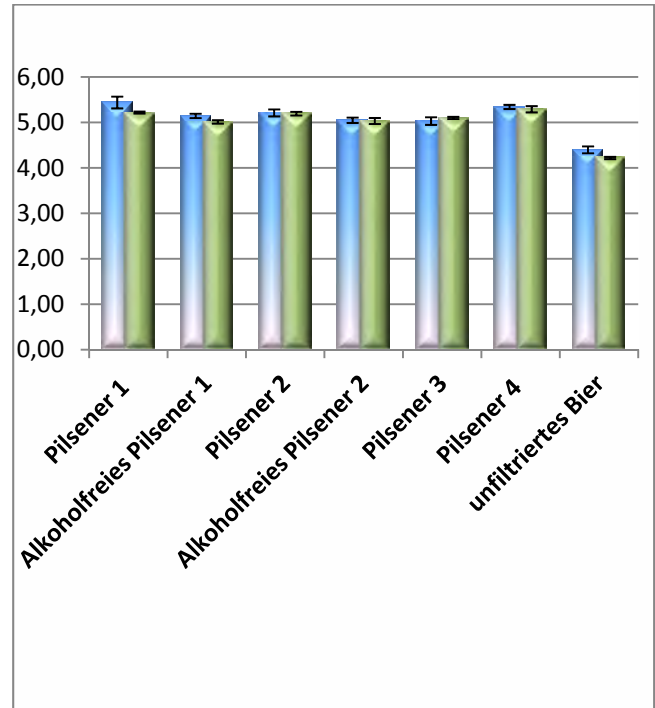

■ Recommended Analyzer / Configuration

TOC-L_{CPH}
ASI-L (40ml)

← Return to main page

Fundamental Techniques for Food Analysis



Mass Spectrometry in Food Analysis

Single quadrupole mass spectrometry have long been acknowledged as the gold standard for food analysis and quantification. With more stringent demands in food safety standards and regulations, the use of triple quadrupole mass spectrometry (QqQ) in the food and agricultural industries have been increasingly popular. Shimadzu concentrates on these key MS features to achieve high speed, sensitivity, specificity and selectivity for your food analyses.

Challenging Limits with Shimadzu



Shimadzu Corporation, one of the leading world-class mass spectrometry manufacturer produced the **world's first mass spectrometry** GCMS- LKB9000 in **1970**.

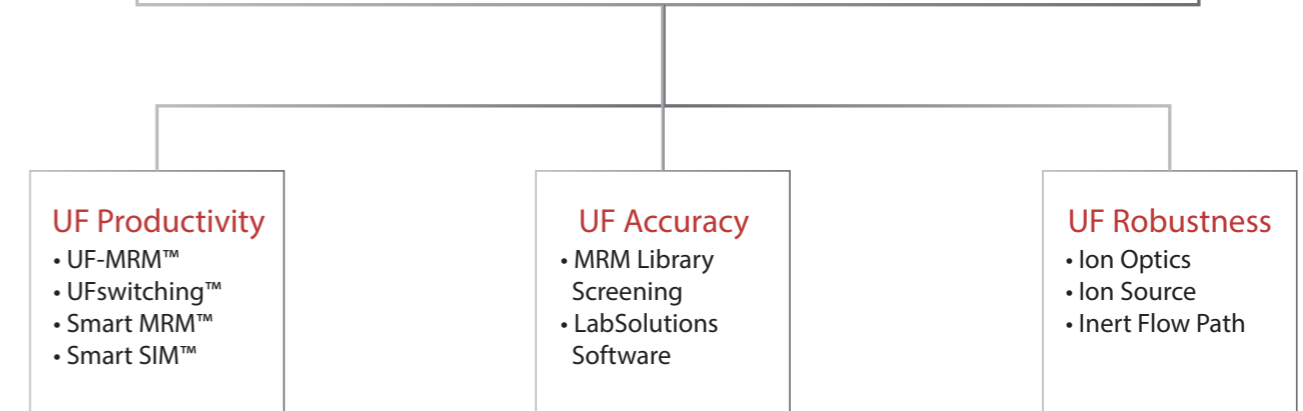

Since 2010, Shimadzu has moved quadrupole MS into a new analytical space by delivering class-leading sensitivity and a higher capability in data quality through Ultra-Fast Mass Spectrometry (UFMS). To date, Shimadzu's UFMS portfolio covers multiple instruments, including GC-MS, LC-MS, ICP-MS, MALDI TOF-MS and MS imaging, driving advancements across a broad range of applications.

These advancements have brought the food safety industry multiple unique benefits and increased confidence in food analysis. Shimadzu's total solution, from method development, workflows, LabSolutions software to data reporting, together addresses several challenges that you may face in your food analysis

← Return to main page

UF-MRM™ and UFswitching™

What is Multiple Reaction Monitoring (MRM)?

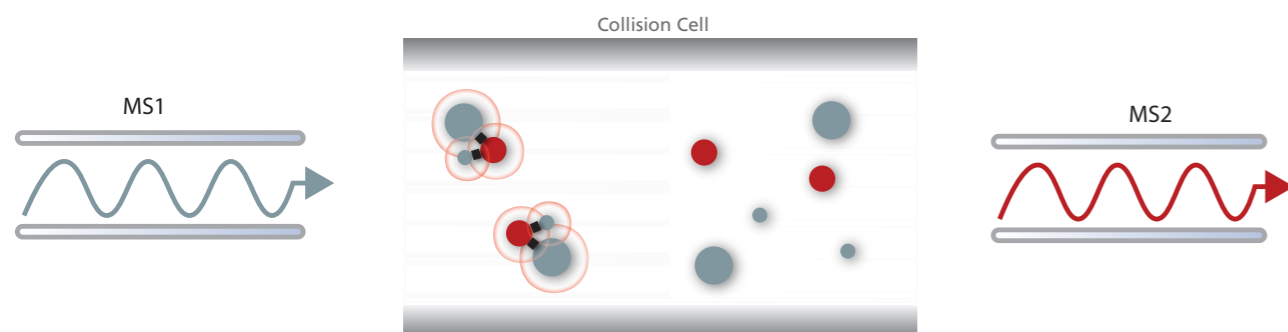

MRM is widely used on triple quadrupole platforms for targeted quantitation as a result of high selectivity, sensitivity and robustness. In a regulated environment such as food safety, along with the increasing complexity in food matrices, there is a growing need to enhance the capability in routine monitoring programs.

Advantages of applying UF-MRM™

Conventional MRM

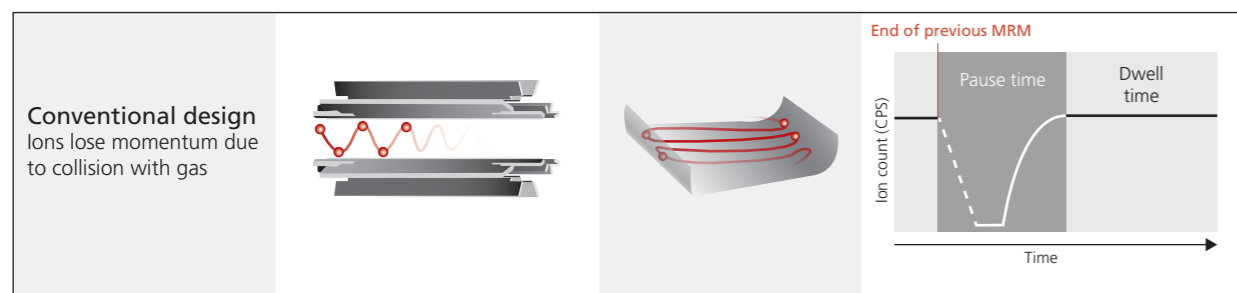

In UF-MRM™

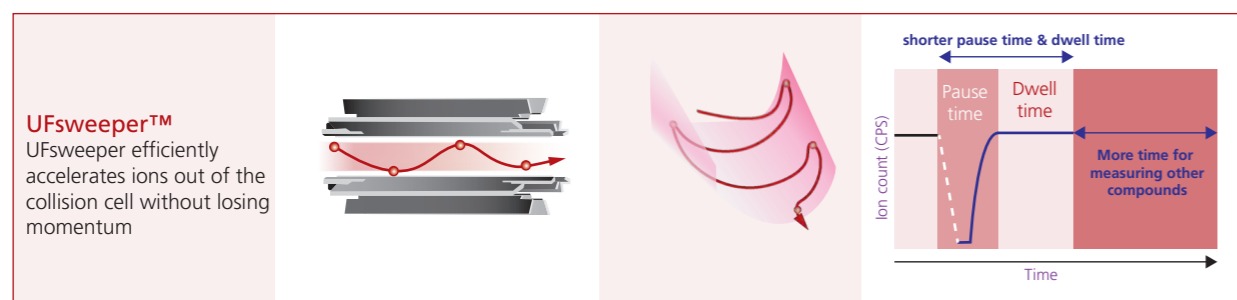

A high-sensitivity and high-throughput MRM approach requires universally ultra-fast collision cell technology. With the new pseudo potential surface, ions entering the collision cell are accelerated and maintain their momentum upon collision. Under these circumstances, the efficiency of the fragmentation or CID is improved. This technology allows quicker and more efficient ion transmission in the collision cell, maintaining signal intensity and dramatically suppressing crosstalk, even when shorter dwell and pause¹ times are used.

¹Measurement conditions must be switched to perform simultaneous measurements of multiple compounds, (multi-component analysis). The time needed for this switching is termed as "pause-time". As data cannot be acquired during the pause time, it should be as short as possible.

High-speed polarity switching pushes the boundaries further

High-speed polarity switching² has a high impact on LC-MS/MS method capability by optimizing the signal response for each target compound resulting in a single injection analysis cycle.

UFswitching™ enables high-speed positive/negative ionization switching in 5 msec, allowing you to measure simultaneous positive/negative compounds in a single analysis, whereas sensitivity and repeatability were not compromised as well.

²Separate positive ionization and negative ionization modes may be used in LCMS. However, switching between the positive and negative ionizations during analysis is required to and the time taken to switch between these modes is known as the "polarity switching time".



Expanding Capabilities in Multi-Residue Pesticide Analysis Using LC-MS/MS

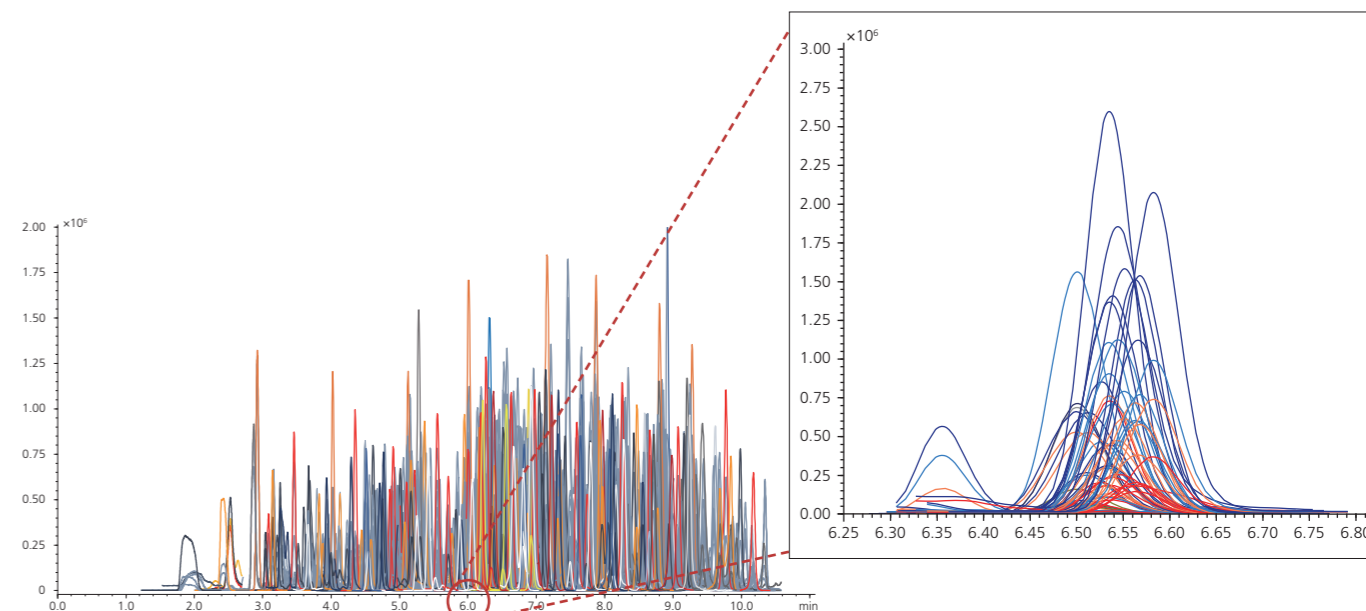

MRM chromatograms of 646 pesticides spiked into a mint extract at 0.01 mg/kg (Up to 3 MRMs per compound and 5 msec polarity switching time).

Based on the example of the mint extract analysis (Phytocontrol, France), QuEChERS protocols were used and 25 pesticide compounds were eluted at the 6.45 - 6.60 time range. Even with high data density acquisitions, the average variation in peak area response was less than 3 %RSD (varying between 1.1 - 5.9 %RSD).



Click to read the application news in details: Expanding Capabilities in Multi-Residue Pesticide Analysis Using The LCMS-8060

← Return to main page

Smart MRM™

✓ Automatic method development with increased throughput



Serial#	Type	Acq. Mode	Compound Name (E)	Ret. Index 1	Ret. Time	Ion1			Ion2			Ion3		
						Typ1	m/z	Rati1	Typ2	m/z	Rati2	Typ3	m/z	Rati3
41	Target	SIM	Chlorpropham	1666	10.228	T	213.0	100.00	Ref.1	127.0	219.30		154.0	56.14
42	Target	SIM	Ethalfuralin	1675	10.324	T	276.0	100.00	Ref.1	316.0	78.70		333.0	23.15
43	Target	SIM	Dichlofluanid metabolite	1676	10.334	T	200.0	100.00	Ref.1	92.0	128.69		108.0	22.13
44	Target	SIM	Naled	1678	10.355	T	185.0	100.00	Ref.1	109.0	595.24		145.0	152.38
45	Target	SIM	Flusilazole metabolite	1678	10.355	T	235.0	100.00	Ref.1	250.0	14.80		155.0	9.60
46	Target	SIM	Diclotophos	1688	10.461	T	127.0	100.00	Ref.1	193.0	9.60		237.0	6.80
47	Target	SIM	Trifluralin	1691	10.493	T	306.0	100.00	Ref.1	264.0	88.68		335.0	8.18
48	Target	SIM	2,6-Dichlorobenzamide	1691	10.493	T	173.0	100.00	Ref.1	175.0	63.60		189.0	44.00
49	Target	SIM	Dioxabenzofos (Salthion)	1692	10.504	T	218.0	100.00	Ref.1	183.0	45.60		201.0	26.80
50	Target	SIM	Benfluralin	1695	10.535	T	292.0	100.00	Ref.1	264.0	24.40		293.0	12.40
51	Target	SIM	Monocrotophos	1700	10.588	T	127.0	100.00	Ref.1	97.0	18.00		192.0	10.00
52	Target	SIM	Sulfotep	1702	10.609	T	322.0	100.00	Ref.1	238.0	39.60		266.0	39.20
53	Target	SIM	Cadusafos	1703	10.619	T	159.0	100.00	Ref.1	158.0	69.20		270.0	5.20
54	Target	SIM	Di-allate-1	1711	10.702	T	234.0	100.00	Ref.1	236.0	39.73		86.0	254.79
55	Target	SIM	Phorate	1713	10.723	T	260.0	100.00	Ref.1	231.0	54.29		75.0	714.29

Smart MRM database incorporated with Smart MRM technology supports automatic creation of analysis methods.

Dwell Time Optimization using Smart MRM

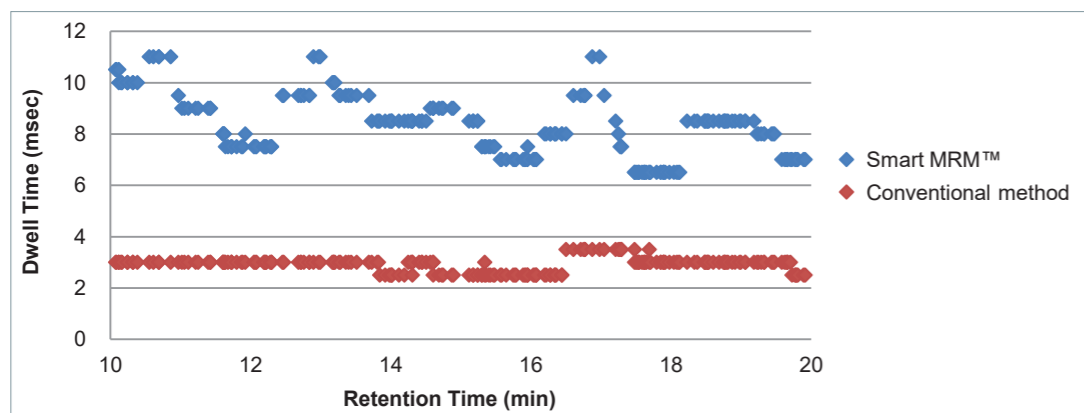

The relationship between the dwell time and retention time in the measurement program created using Smart MRM is shown. (for retention times from 10 to 20 minutes)

Smart MRM technology can automatically adjust the analytical dwell time for each transition, and acquires data during peak elution, to fully optimize sensitivity.

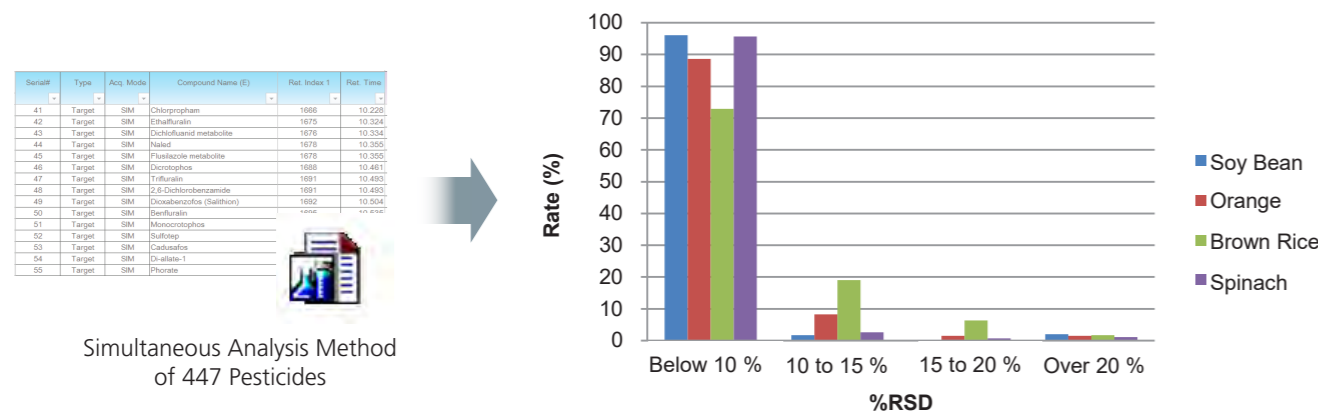

%RSD distribution for each matrix spiked with 477 pesticides at 5 ppb.



Click to read the application data sheet in detail: Simultaneous Analysis of 477 Residual Pesticides in Agricultural Crops Using GC-MS/MS

Smart SIM™

✓ Effortless SIM method building

Smart SIM technology improved dramatically the efficiency of multi-component simultaneous analysis, which function is the same as Smart MRM. Moreover, highly reliable data can be obtained as the result of the optimized analytical conditions.

Group Measurement Method

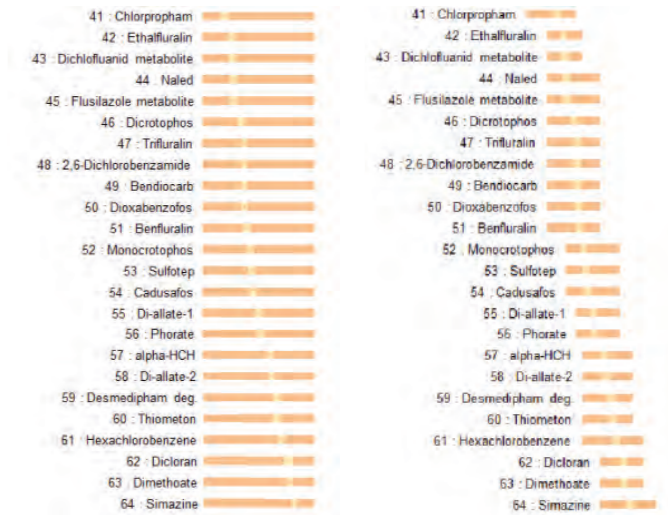

SIM measurement time program
Left: Group measurement method
Right: Measurement method using Smart SIM

Automatic Method Creation

Serial#	Type	Acq. Mode	Compound Name (E)	Ret. Index 1	Ret. Time
41	Target	SIM	Chlorpropham	1666	10.228
42	Target	SIM	Ethalfuralin	1675	10.324
43	Target	SIM	Dichlofluanid metabolite	1676	10.334
44	Target	SIM	Naled	1678	10.355
45	Target	SIM	Flusilazole metabolite	1678	10.355
46	Target	SIM	Diclotophos	1688	10.461
47	Target	SIM	Trifluralin	1691	10.493
48	Target	SIM	2,6-Dichlorobenzamide	1691	10.493
49	Target	SIM	Dioxabenzofos (Salthion)	1692	10.504
50	Target	SIM	Benfluralin	1695	10.535
51	Target	SIM	Monocrotophos	1700	10.588
52	Target	SIM	Sulfotep	1702	10.609
53	Target	SIM	Cadusafos	1703	10.619
54	Target	SIM	Di-allate-1	1711	10.702
55	Target	SIM	Phorate	1713	10.723

Simultaneous Analysis Method of 418 Pesticides

SIM Chromatogram for 418 Pesticides Standard Mixed Solution at 100 ng/mL

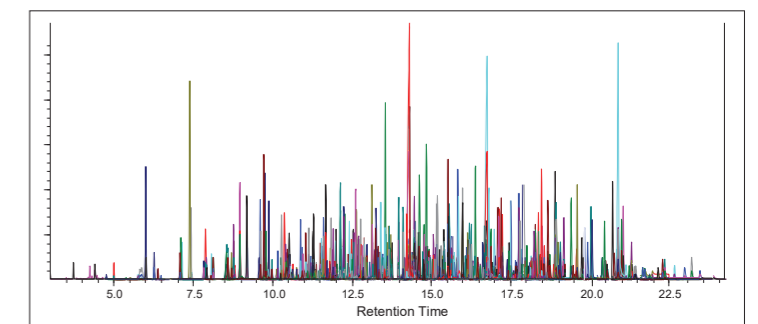

Click to read the application data sheet in detail: Simultaneous Analysis of 418 Pesticides Utilizing Smart SIM

← Return to main page

Library Screening MRM Spectrum Mode

✓ Enhanced specificity and reporting confidence

The integrated UF technologies (UF-MRM™, UFSwitching™) can increase the specificity of detection and reduce false negative and false positive reporting, by acquiring multi-fragment ions in MRM data acquisition.

Comparison of conventional 2-MRM method and MRM Spectrum mode

With reference to the analysis of linuron, data quality of MRM Spectrum mode was not compromised despite monitoring a larger number of fragment ions.

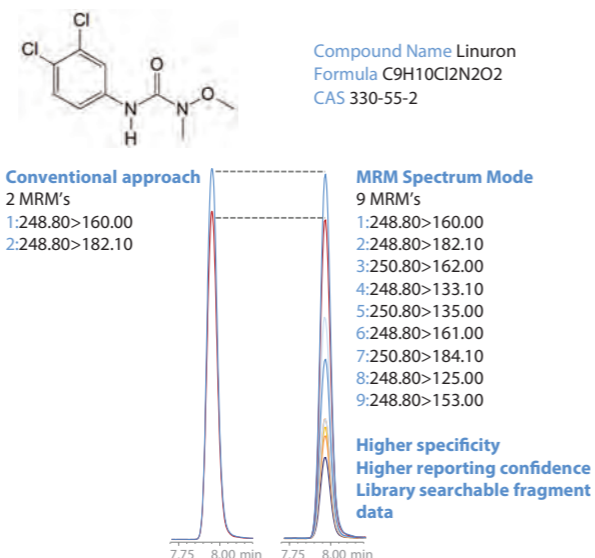

✓ Improved data review efficiency

Shimadzu provides effective ease-of-use tool — Library Screening MRM Spectrum Mode, to deliver reliable data review. This serves as an additional identification criterion to enhance reporting confidence.

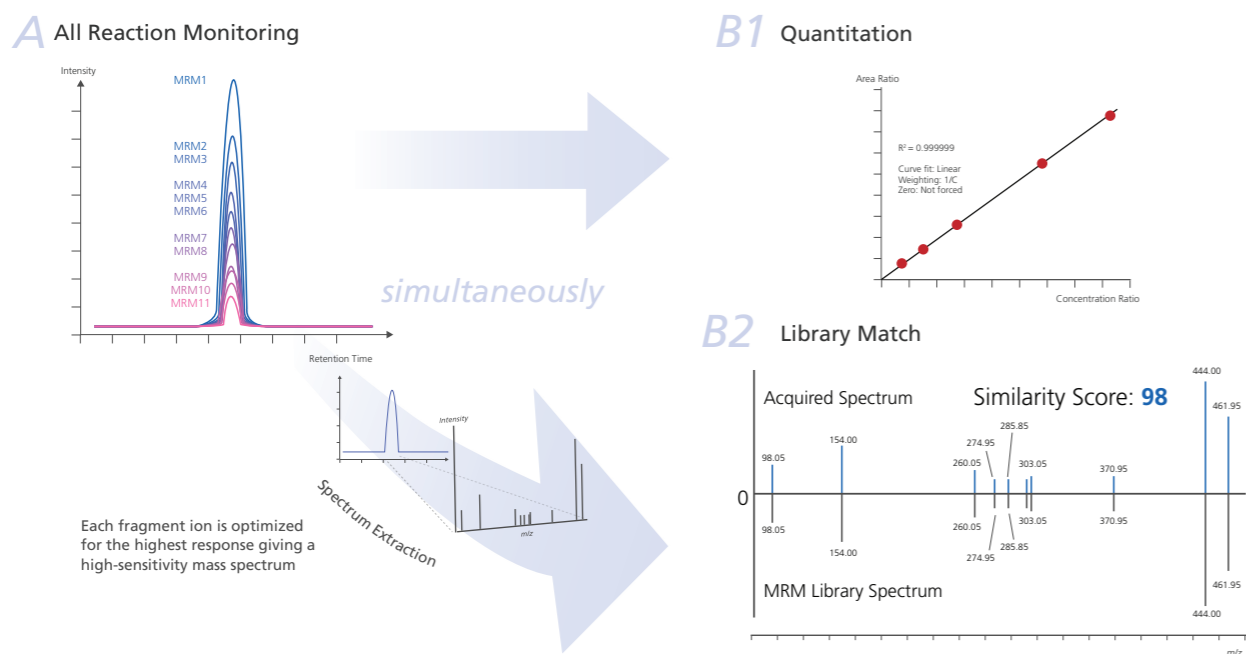

Click to read in detail: LabSolutions Insight Library Screening - MRM Spectrum Mode

✓ Enhanced Reporting Confidence in Routine Pesticide Residue Analysis

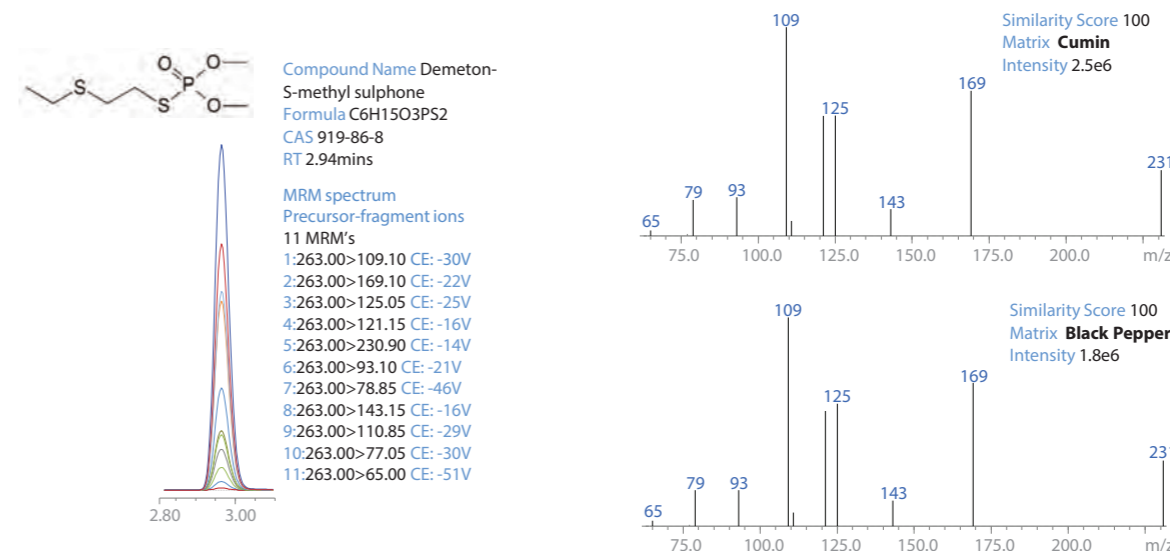

Demeton-S-methyl sulphone was to highlight library matching in cumin and black pepper. Even in the presence of complex spice matrices the library matching approach identified demeton-S-methyl sulphone with a high similarity score and a high degree of confidence for data reporting.



Click to read the application news in detail: Application News Applying 'MRM Spectrum Mode' and Library Searching for Enhanced Reporting Confidence in Routine Pesticide Residue Analysis

✓ Identification of Residual Veterinary Drug

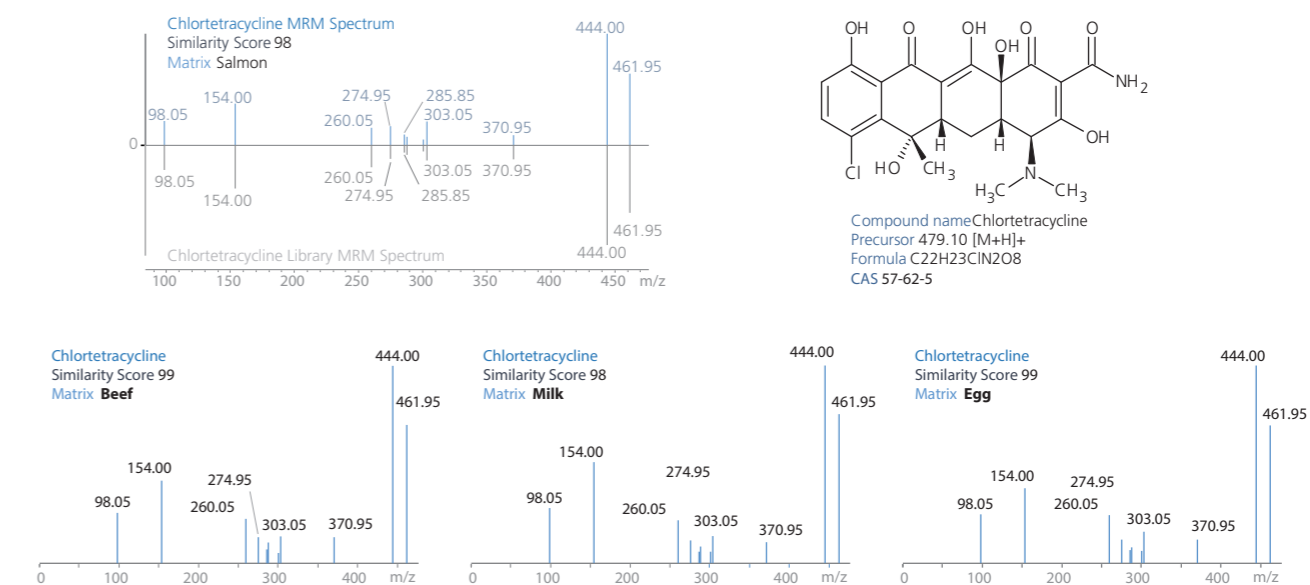

Identification and verification of chlortetracycline using reference library match scores. The library match score was above 98 for salmon, beef, milk, egg extract spiked with chlortetracycline at a concentration of 10 pg/μL.



Click to read the application news in detail: Multi-Residue Veterinary Drug Analysis of >200 Compounds using MRM Spectrum Mode by LC-MS/MS

← Return to main page

LabSolutions Software Platform

LabSolutions Insight™

✓ Accelerates data processing productivity and quantitative data review. Library Screening MRM Spectrum Mode is a featured in LabSolutions Insight.

Conventional data acquisition and processing



Data acquisition and processing using LabSolutions Insight

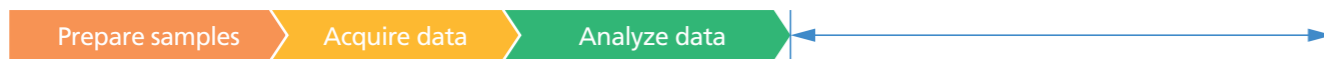

✓ Intuitive Operation

An easy-to-use and configurable interface allows new users to be productive quickly

✓ Automated QA/QC Flagging and Peak Comparison

Contains multiple QA/QC flagging criteria for retention times, reference ion ratios, concentration limits, etc.

✓ Data Integrity

Compatible with LabSolutions DB, enabling traceability, audit trail, and user management capabilities.

✓ Efficient Workflow

Flag-based labeling, filtering, peak comparison functions, and centralized results files to work more efficiently.

LabSolutions Report Plus™ Software

✓ Create user-defined reports with information freely arranged in any layout

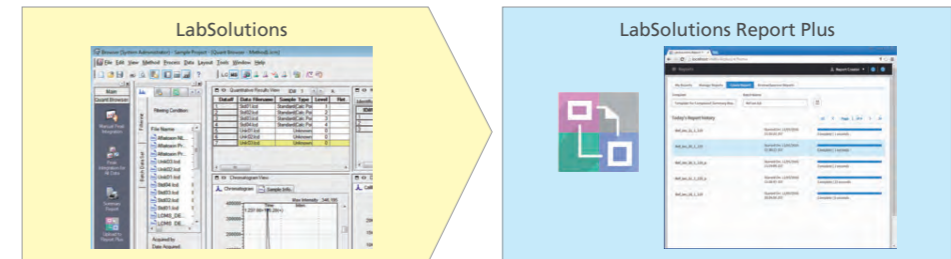

An analytical condition summary report lists the analytical conditions for each compound

A calibration curve summary report lists the calibration curve for each compound

A compound summary report summarizes quantitation results for each compound of unknown samples



Click to read the technical report in detail: Data Integrity Compliance Using the LabSolutions Report Set

Various Database Series and Application-Specific Method Packages

✓ Simplify your workflows and quickly set up a method for targeted and suspect screening using GC-MS and LC-MS.

<p>Food Safety Analysis</p>	<p>GC/MS</p> <ul style="list-style-type: none"> · Quick-DB Database for Residual Pesticide Analysis · Smart Pesticides Database <p>LC/MS</p> <ul style="list-style-type: none"> · Method Package for Residual Pesticides · Method Package for Veterinary Drugs 	<p>Metabolite Component Analysis</p>	<p>GC/MS</p> <ul style="list-style-type: none"> · Smart Metabolites Database <p>LC/MS</p> <ul style="list-style-type: none"> · MRM Library for Metabolic Enzymes (Yeasts) Library · Method Package for Lipid Mediators · Method Package for Primary Metabolites
<p>Environmental Pollutant Analysis</p>	<p>GC/MS</p> <ul style="list-style-type: none"> · Compound Composer · Smart Environmental Database <p>LC/MS</p> <ul style="list-style-type: none"> · Method Package for Water Analysis 	<p>Forensic Toxicological Analysis</p>	<p>GC/MS</p> <ul style="list-style-type: none"> · Smart Forensic Database · Quick-DB GC/MS/MS Forensic Toxicological Database <p>LC/MS</p> <ul style="list-style-type: none"> · Rapid Toxicological Drug Screening System · Method Package for Forensic Toxins

← Return to main page

Cutting-edge Ion Optics

✓ Long-term stability with minimum downtime

Shimadzu LC-MS/MS series have engineered a unique and innovative ion optics that routinely delivers robust detection at very high sensitivities even with complex matrices at trace levels.

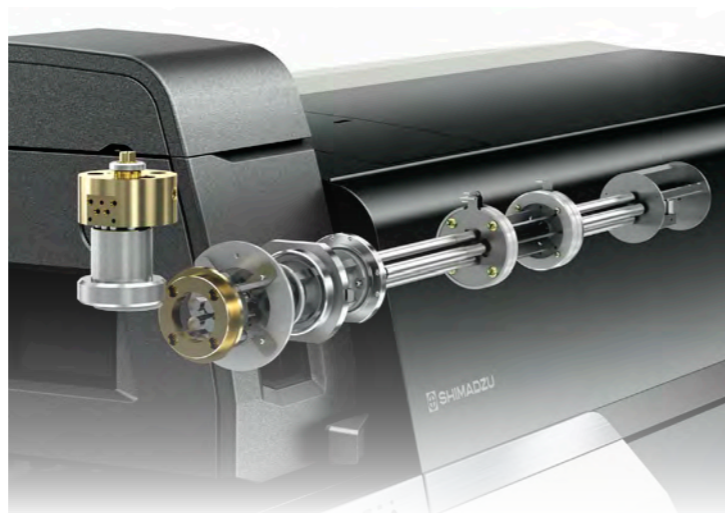

LC-MS/MS robustness was demonstrated by long-term stability of the instrument using a solution of pork crude extract (spiked with 10µg/L standard solution). Even after continuous measurement of an extremely complex matrix over a period of 3 days, Shimadzu instruments can deliver consistent, and higher quality results.

✓ Highly repeatable quantification of veterinary drug

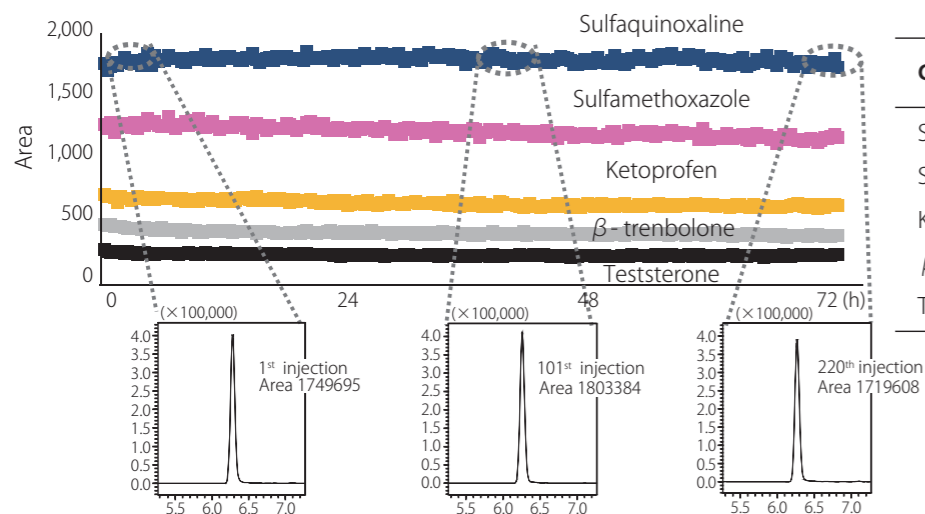

Sample preparation of typical samples based on QuEChERS Extraction Salts Kit. Area Plot and %RSD of Typical Compounds with Continuous Analysis



Click to read the application news in detail: Quantitative Analysis of Veterinary Drugs Using the Shimadzu LCMS-8050 Triple Quadrupole Mass Spectrometer

✓ Confident pesticide residue analysis for various matrices

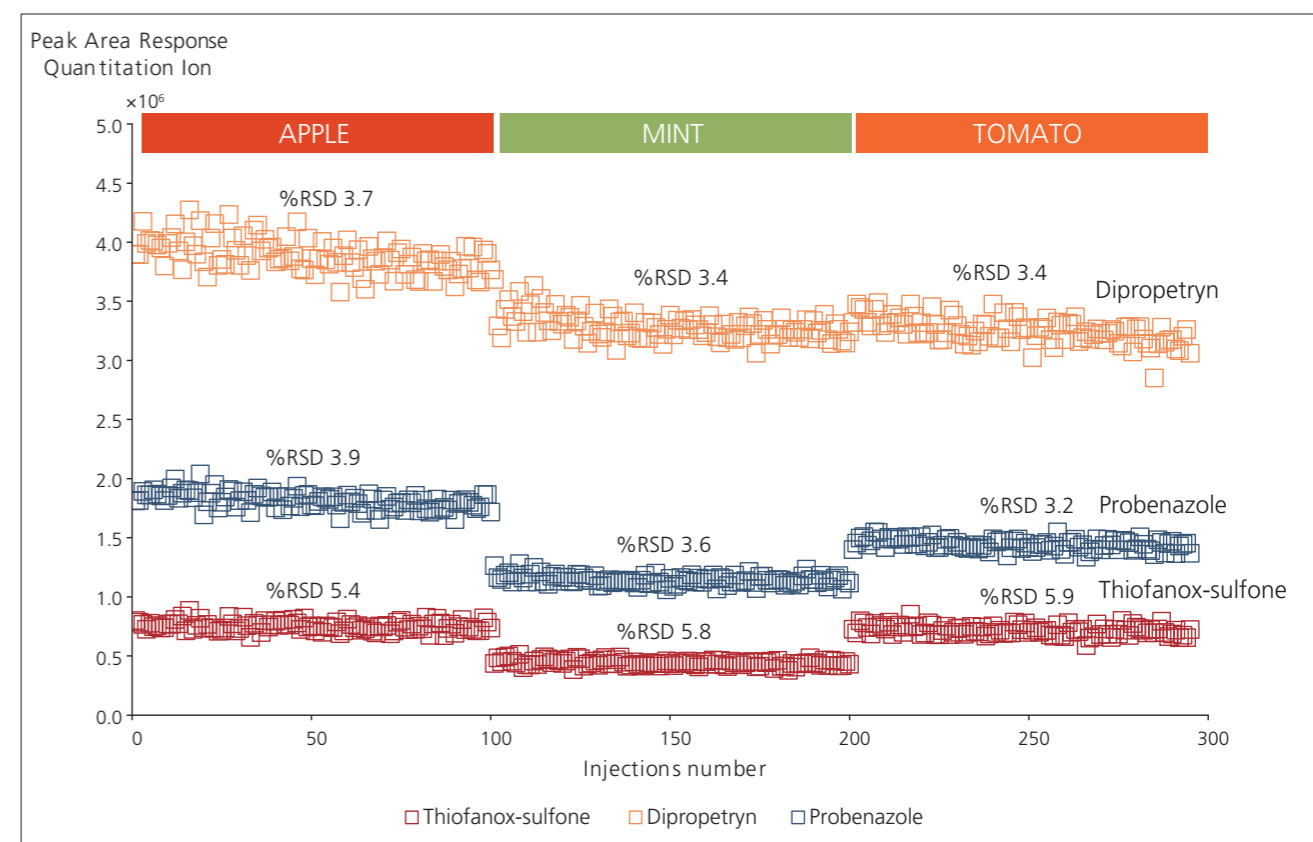

Peak area response for three pesticides spiked into apple, mint and tomato matrix extracts at 0.05 mg/kg over 72 hours.

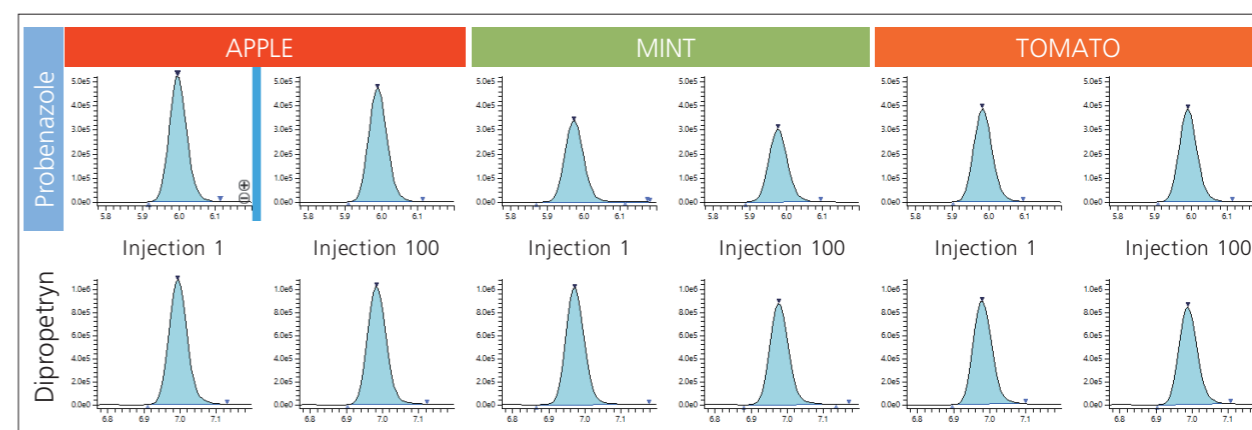

MRM chromatogram for probenazole and dipropetryn for injection 1 and injection 100.



Click to read the application news in detail: Expanding Capabilities in Multi-Residue Pesticide Analysis Using The LCMS-8060

← Return to main page

Patented Ion Source

✓ Reduces maintenance frequency and long-term operational costs

The effect of the filament's electric potential on the ion source is reduced by increasing the distance between the filament and ion source box. In addition, a shield blocks out radiant heat generated from the filament to ensure the ion source box temperature remains uniform. Since this prevents any active spots within the ion source, it provides higher sensitivity for analysis (Patent: US7939810).

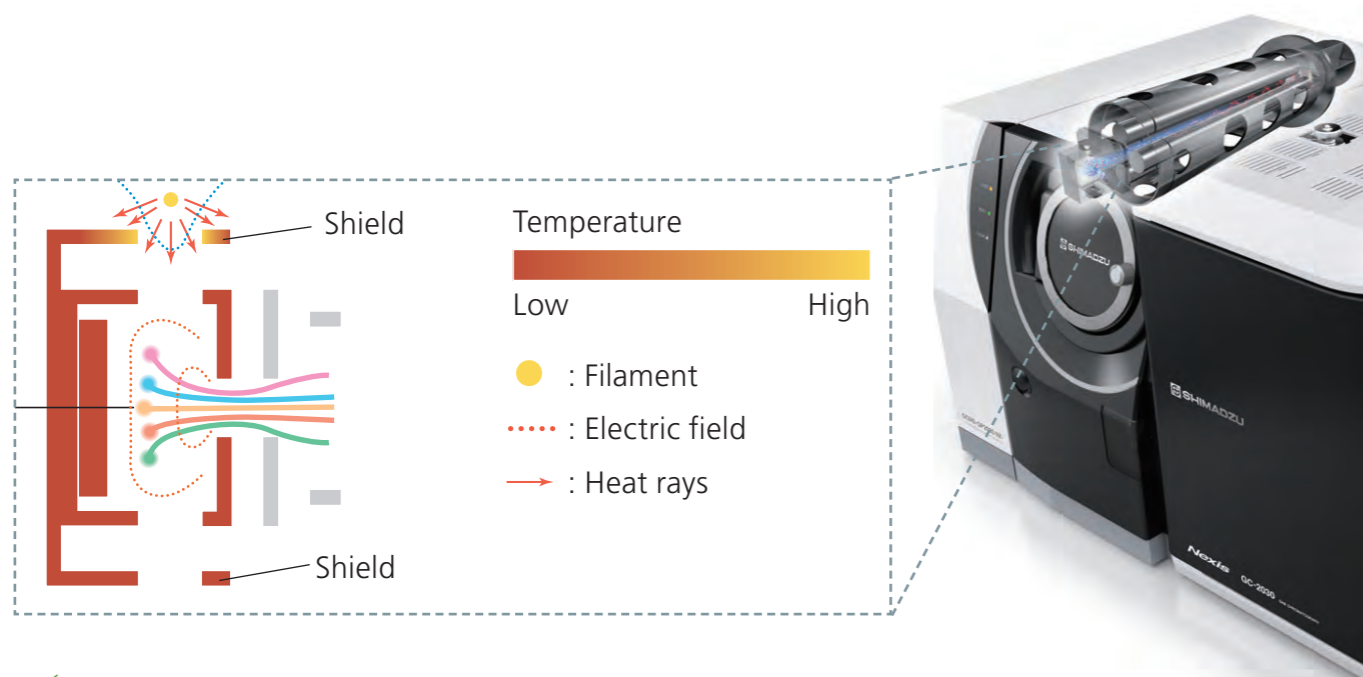

✓ Improved robustness through ultra-sensitive design

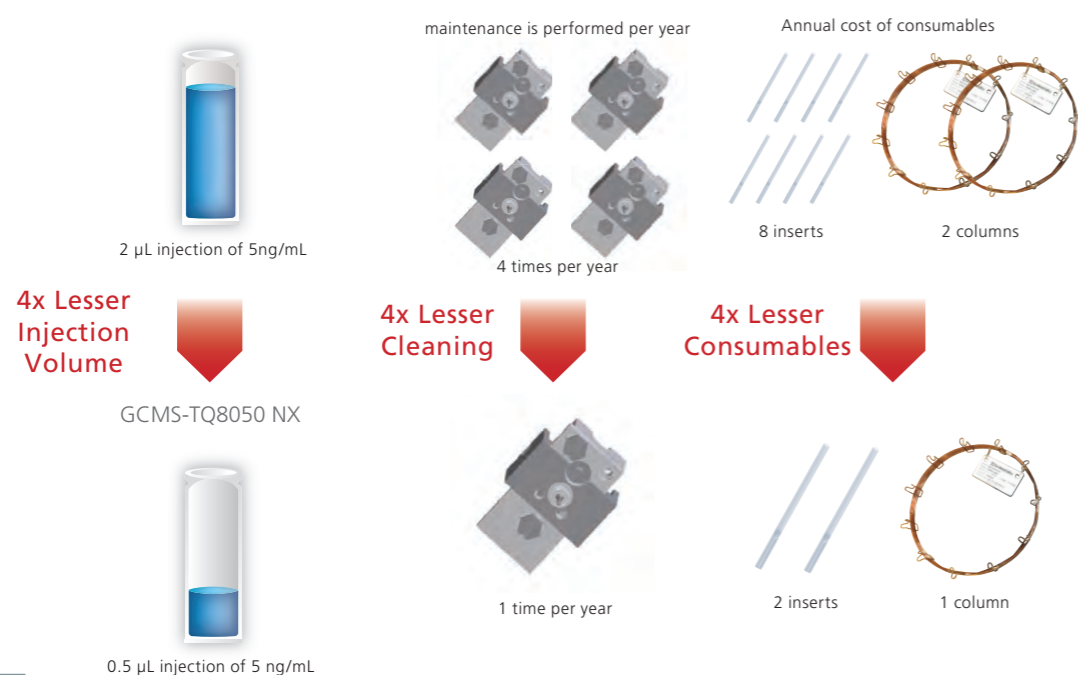

Click to read the application data sheet in detail: [Efficient Analysis of Residual Pesticides in Foods Using High-Sensitivity GC-MS/MS](#)



Inert Flow Path

✓ Detect trace components with high sensitivity and repeatability

Glass liner
The glass liner recommended for GC/MS analysis uses a proprietary inactivation technology to dramatically suppress active sites. After packing into the insert, the wool is subjected to a complete inactivation treatment. This product is controlled throughout from production to final inspection to provide 100 % satisfaction.

TIC	Endrin	p,p'-DDT
Resolution (%) Endrin: 1.34 DDT: 1.44		

Micro-syringe
Autosampler syringes feature improved durability, clarity, and accuracy, achieving reliable injection accuracy.

GC septum
Our lineup now includes low bleed septa, which maintain optimal seal performance even when the injection cycles are increased, and can be used even at high temperatures. This reduces sensitivity variations due to leaks.

Ferrules and gold gasket
The high-quality Vespel ferrule is easily attached and designed to resist leaking. The gold gasket is inactive, and adsorption does not occur.

Ion source
Designed with a shield that blocks radiant heat generated by the filament, and an ion source treated with an oxide coating, active spots inside the ion source are not prone to occur, which enables high-sensitivity analysis with long-term stability.

Capillary columns
For the SH-Rxi™ series, a high-quality fused silica like no other is used as the raw material. Our proprietary surface inactivation technology and optimal process to mask silanol groups result in a low-bleed column with very impressive inactivation performance, even with respect to polar compounds comparable to acidic and basic substances.

SHIMADZU
GCMS-TQ8050 NX
SHIMADZU
Nexis GC-2030

← Return to main page

Advanced Techniques for Food Analysis



Complex food analysis can be made simpler and more efficient by several advanced separation and screening techniques. In addition to Shimadzu UFMS technologies that addressed truly scalable performance for routine analysis, complex food analysis can be made simpler and more efficient with the incorporation of advanced separation and screening techniques.

Shimadzu has developed several instrumentation, software and configurations to simplify and expedite your analytical workflow, and improve your screening capabilities. This section describes in detail the key features and benefits of these advanced techniques.

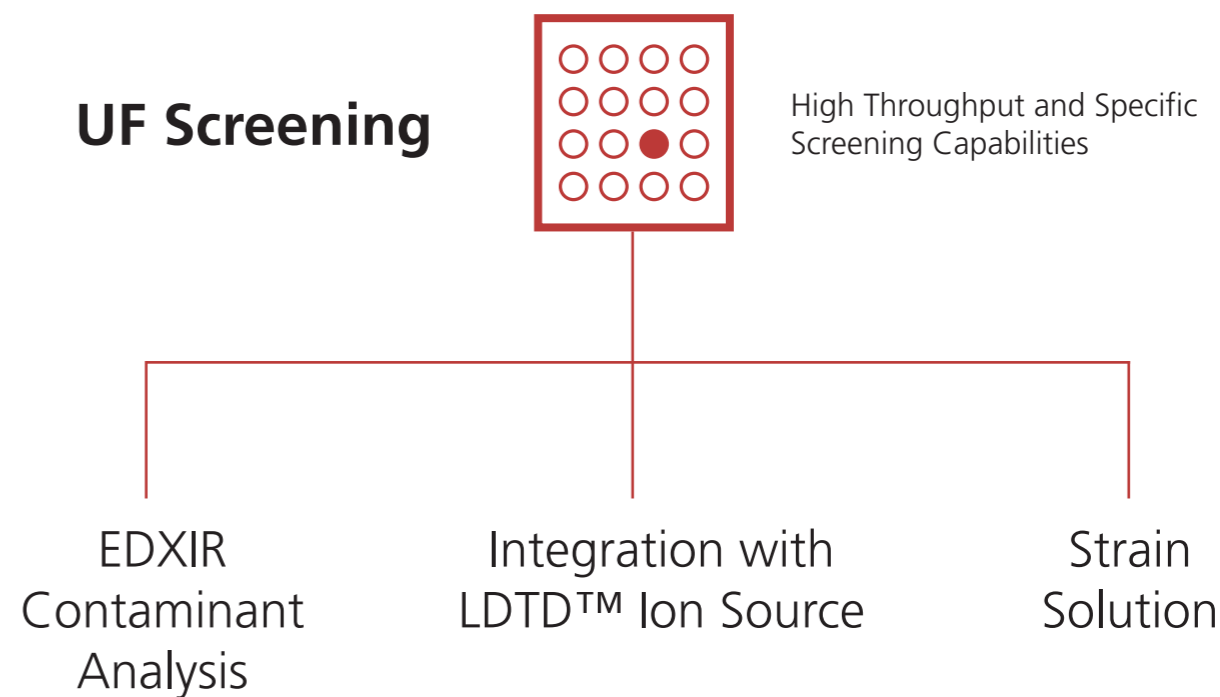
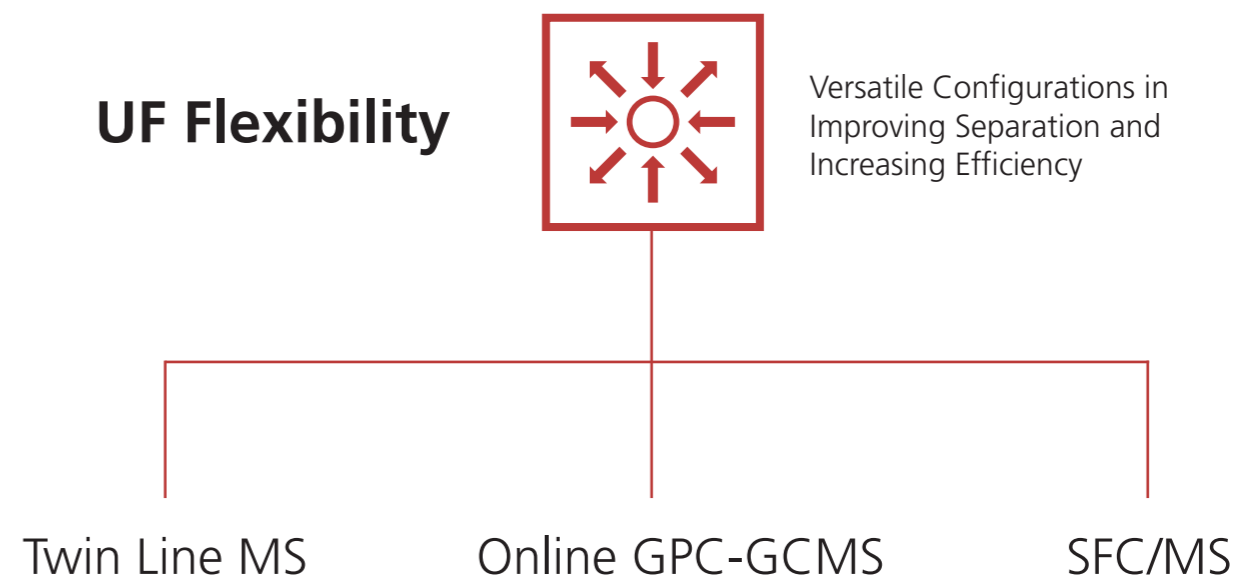

← Return to main page

Twin Line MS System

✓ **Makes second-column confirmation on the same instrument simpler**

The highly complex nature of food samples has always been a challenging issue in sample preparation and analysis. With the use of simple sample preparation for food such as QuEChERS, the detection and identification of target compounds may not be directly achieved. In some cases, even the use of SIM or MRM mode may not obtain the required resolution, sensitivity and selectivity.



✓ **Discover the key benefit enabling quantitation with confidence**

Using a second-column allows for peak separation and identification of the target compound. Both single quadrupole MS and triple quadrupole MS are compatible with the Twin Line MS system, and can be used to reliably and accurately analyze target compounds in complex food matrices without the need to vent the MS.

Simultaneous Analysis of 477 Residual Pesticides in Agricultural Crops Using GC-MS/MS

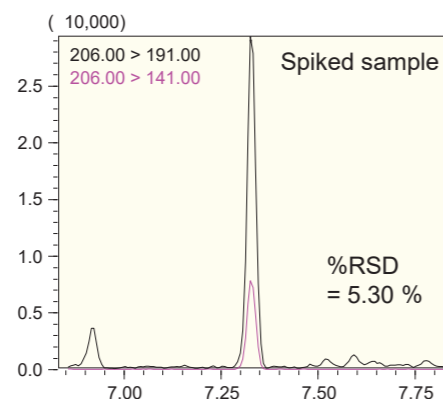
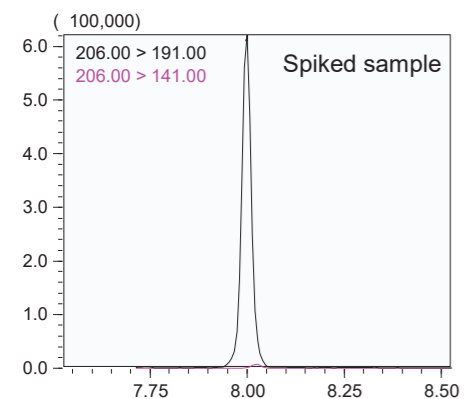
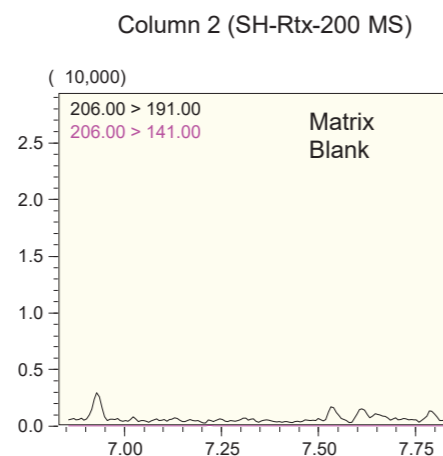
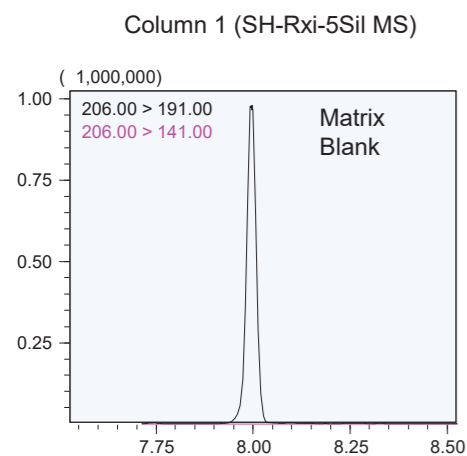

Separated from Impurities



Click to read in detail the application note on the use of Twin Line MS for second-column confirmation of pesticides on the same GC-MS without venting the MS.

Online GPC-GCMS

✓ **Online cleanup technique specifically for residual pesticides analysis in food**

In this online system, Gel Permeation Chromatography (GPC) works as a cleanup technique, by removing unwanted compounds from complex food matrices, prior to a GC-MS analysis. This coupling of GPC to GC-MS provides a rapid streamlined workflow specifically for analysis of pesticides in foods. Also, some food contaminants are analyzed by GPC-GCMS.



Accessible online analysis

1. Unwanted compounds (e.g. oil, fat and dye analytes) are separated from target pesticides compounds using a GPC column.
2. Unwanted compounds are removed using a flow line switching valve.
3. Target pesticides are trapped and concentrated in the sample loop for large-volume injection into the GC-MS for simultaneous multi-component analysis.

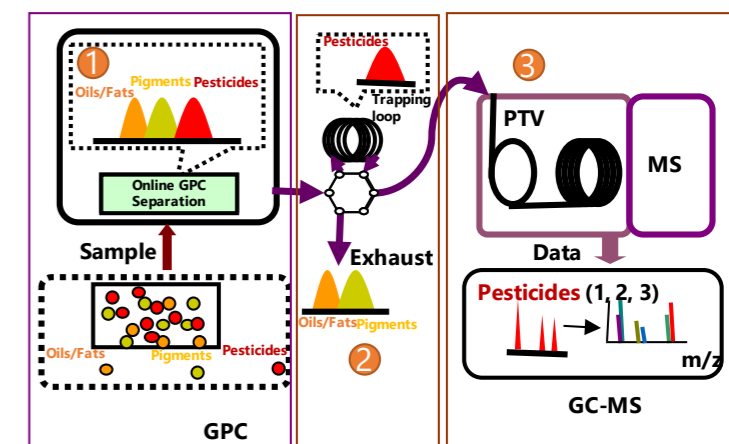

✓ **Reduced Manual Sample Preparation**

✓ **Automated System**

✓ **GC-MS analysis + Simultaneous removal of unwanted compounds**

✓ **Lower Solvent Consumption**

Conventional Method

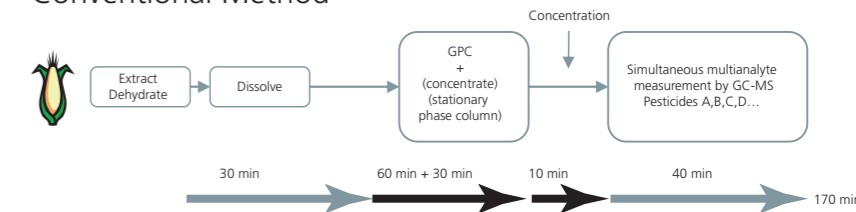

Online GPC-GCMS

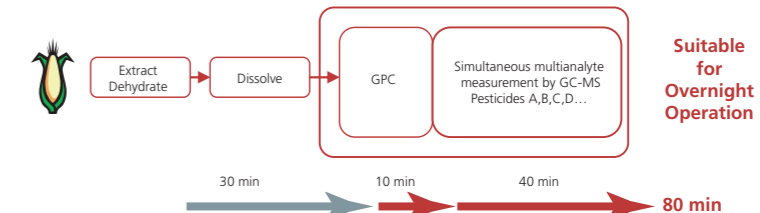

Click to read more on the analysis of PCBs in vegetables using GPC-GCMS

← Return to
main page

SFC/MS System

✓ Increased coverage of polar pesticides

Supercritical fluid chromatography (SFC) has the advantage of being able to separate a wide array of chemical compounds at once due to the characteristics of the mobile phase that is used. In addition, since the separation behavior with SFC differs from that with LC even when using the same column chemistry, SFC can be an effective alternative for the analyses of compounds for which retention and separation are difficult in LC.

Quantitative Analysis of Highly Polar Pesticides in Food Using SFC/MS

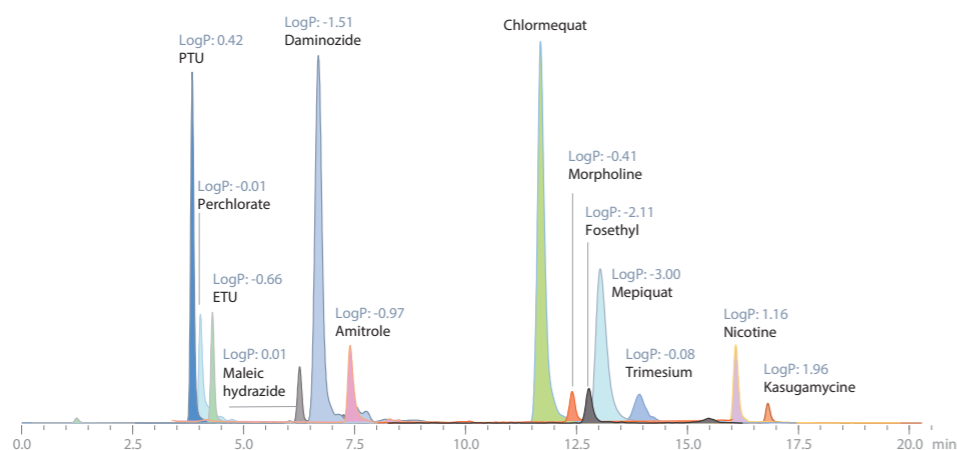

SFC/MS analysis covers the broadest range of compounds than any other existing methods

✓ Higher productivity

Facilitates fast chromatography through low solvent viscosity and superior diffusion characteristics.

✓ Higher sensitivity

Achieves excellent detection capabilities by splitless coupling of SFC eluent to MS

✓ Eco-friendly

Reduces cost of solvent purchase and usage

SFC/MS can be upgraded to on-line SFE-SFC-MS system*, which unites sample separation, analysis with various separation modes, and high-sensitivity detection.



* SFE (Supercritical Fluid Extraction) : An extraction method using supercritical fluid. It is available as a pretreatment method for solid sample analyses.
* SFC (Supercritical Fluid Chromatography) : The chromatographic technique using supercritical fluids as mobile phases. With its unique properties, it enables high-speed, high-resolution analyses.



Click to read more on: Quantitative Analysis of Highly Polar Pesticides in Food using SFC/MS

EDXIR-Analysis

✓ EDX-FTIR Contaminant Finder/Material Inspector

EDXIR system is a comprehensive search system that provide an effective way to identify contaminants by an energy dispersive X-ray (EDX) fluorescence spectrometer and a Fourier transform infrared spectrophotometer (FTIR). Additionally, EDXIR-Analysis software is specially designed to perform qualitative analysis with library used for matching foreign substances in search results.

Procedure for Qualitative Analysis of Contaminants

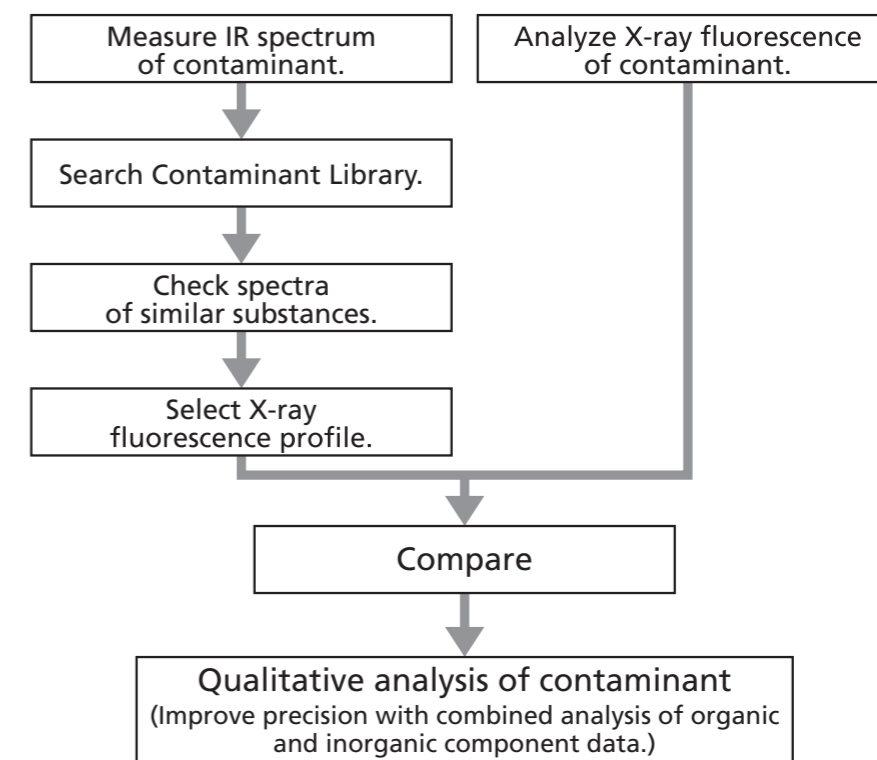

Features

- ✓ Shimadzu's proprietary contaminant library was prepared with cooperation from organizations in the public water supply industry and food manufactures.
- ✓ Includes information from actual contaminant samples both an infrared spectral library, and X-ray fluorescence profiles (in PDF file format).

EDXIR-Analysis Library

The library used for data analysis (containing 485 data as standard) originates from Shimadzu, and was created through cooperation with water supply agencies and food manufacturers. Additional data can be registered to the library as well.



Click to read more on: Combined Analysis of a Contaminant Using a Compact FTIR and EDX

← Return to main page

Laser Diode Thermal Desorption (LDTD)TM

✓ Scalable performance revolutionize laboratory productivity

The LDTDTM ion source (Phytronix Technologies Inc.) delivers solutions that complement screening and identification testing in various fields such as food safety. It is a direct ion source for mass spectrometers that provides ultra-high speed analysis in less than 4 seconds per sample.

Features

- ✓ LDTD Ion Source
 - Direct sample introduction with no carryover
 - Supports 10 LazWell plates (960 samples, 2 to 10 µL)
- ✓ Compatible with LCMS-8050/8060
 - High speed performance of mass spectrometer enables high-throughput analysis.
 - No need to replace LC-MS and LDTD-MS in screening and confirmation test
- ✓ Software Supports Serial Analysis Workflows
 - Easy installation procedure
 - Batch analysis with LabSolutions software

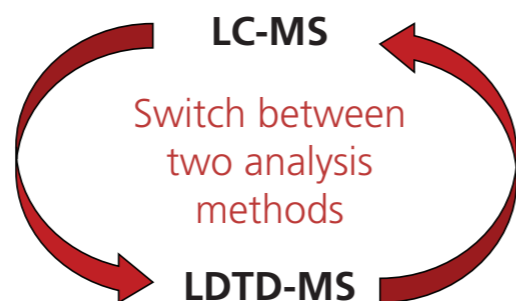

Analysis of melamine added into milk powder using LDTD-MS

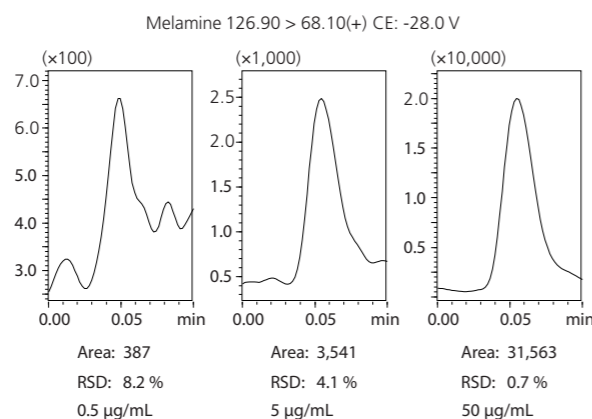

Click to read more on: Ultra-high-speed Analysis of Melamine Powdered Milk using LDTD-MS/MS

Strain Solution with AXIMA series

✓ Strain level identification using S10-GERMS method

Microbial identification using Shimadzu's AXIMA Series MALDI-TOF-MS allows rapid analysis with minimal sample preparation and reagents. Together with the AXIMA-ID^{plus} software, consistent species-level identification can be conducted using SARAMIS microorganism identification. For detailed identification at the species and strain level, Shimadzu's Strain Solution Software facilitates proteotyping based on the S10-GERMS method, discriminating single amino acid mutations.

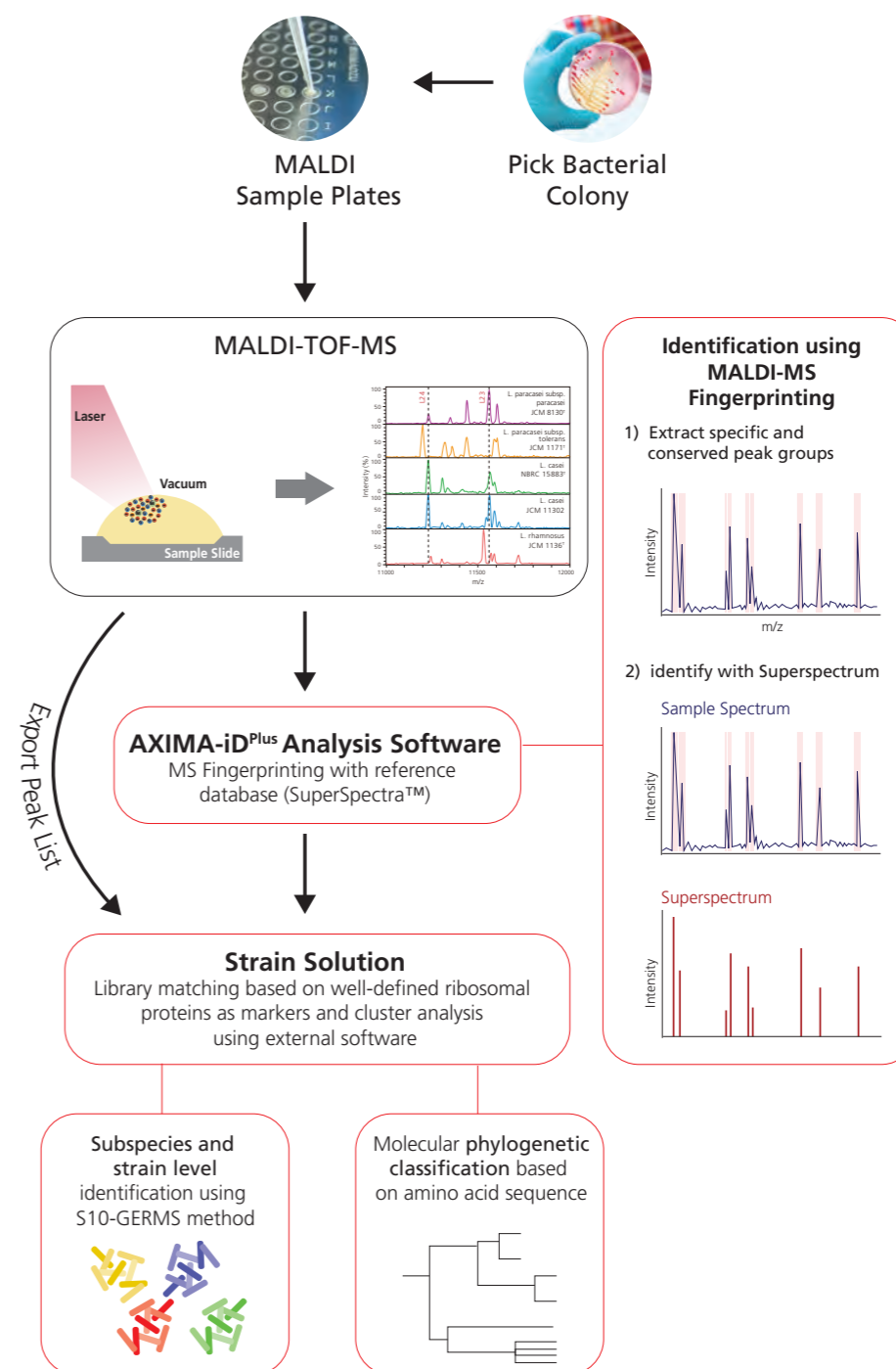

← Return to
main page

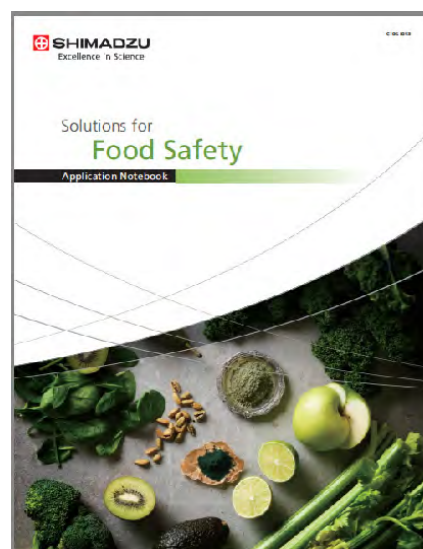

Solutions for Food Safety

A compilation of application notes targeted for the analysis of pesticides, veterinary drugs, preservatives and more in food.

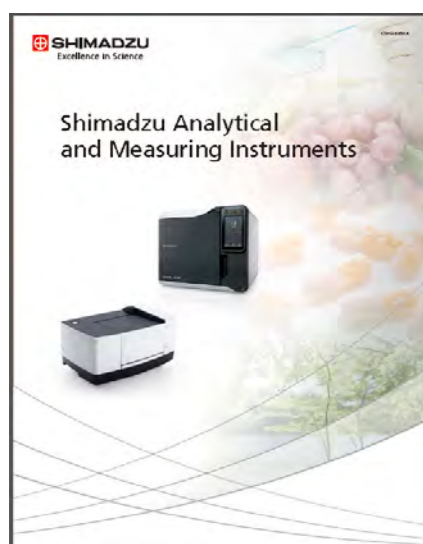

Shimadzu Analytical and Measuring Instruments

A comprehensive booklet on service and support for chromatography, spectroscopy, X-ray and surface analysis apparatus and more.

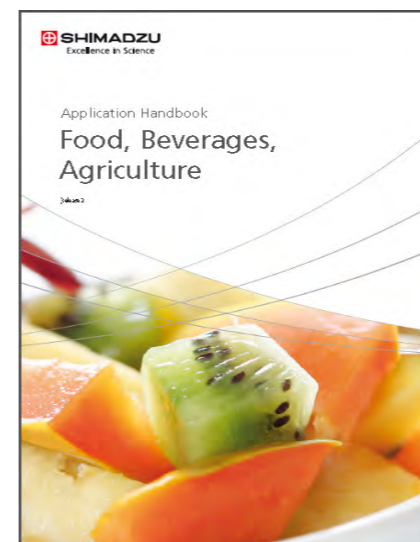

Application Handbook Food, Beverage, Agriculture

A compilation of applications focusing on food safety and quality.

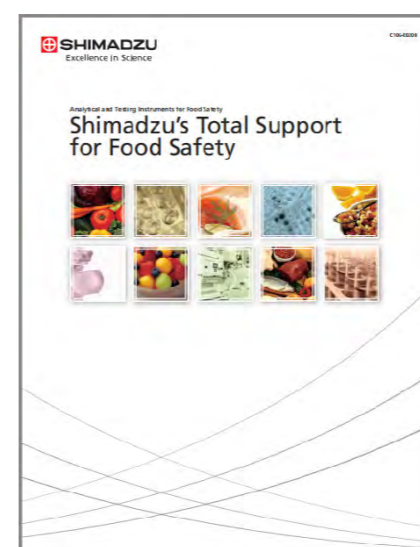

Shimadzu's Total Support for Food Safety

A full range of analytical instruments specially catered to accelerate productivity, enhance sensitivity and accuracy for food safety compliance.

← Return to main page

Shimadzu Innovation Centers and MS Centers

Strengthening our ability to listen closely to customers - this is what Shimadzu has been focusing on. Shimadzu is continuously expanding its innovation centers and MS centers worldwide to strengthen our insight into customers' needs and contribute to collaborative researches.



Healthcare



Environmental Energy



Chemical



Food



Composite Material



Environmental



Imaging



VISIT OUR [WEBPAGE](#) FOR MORE INFO

Find us on 



Linked 



 **ResearchGate**



Contact us

<https://www.shimadzu.com/an/contact/index.html>



Shimadzu Corporation
www.shimadzu.com/an/

For Research Use Only. Not for use in diagnostic procedures.

This publication may contain references to products that are not available in your country. Please contact us to check the availability of these products in your country.
Company names, products/service names and logos used in this publication are trademarks and trade names of Shimadzu Corporation, its subsidiaries or its affiliates, whether or not they are used with trademark symbol "TM" or "®".
Third-party trademarks and trade names may be used in this publication to refer to either the entities or their products/services, whether or not they are used with trademark symbol "TM" or "®".
Shimadzu disclaims any proprietary interest in trademarks and trade names other than its own.

The contents of this publication are provided to you "as is" without warranty of any kind, and are subject to change without notice. Shimadzu does not assume any responsibility or liability for any damage, whether direct or indirect, relating to the use of this publication.