

Chiral Cyclodextrin Capillary GC Columns



895-0008

A Selection Guide to DEX™ Columns

Stable derivatized cyclodextrin stationary phases for high resolution analyses of optical and positional isomers.



Low bleed, wide temperature range (30°C - 240/250°C)



Individually tested with phase-specific test mixes to guarantee optimum performance



Wide range of applications: foods, flavors, essential oils, natural products, pharmaceuticals, chemical syntheses

Chiral molecules can elicit very different responses in a biological system, depending on their stereochemistry (1,2). Rapid commercial introduction of optically active drugs requires reliable stereochemical analysis of the products, and of the chiral intermediates used in their synthesis. Capillary gas chromatography is a simple, fast, accurate, sensitive, and reproducible technique for separating stereo and positional isomers of compounds that can be vaporized without decomposition. Chiral separations have been performed by gas chromatography for nearly three decades (3). First generation chiral GC columns were based on nonbonded and bonded amino acid moieties (4); the latest capillary GC columns are based on functionalized cyclodextrins (5,6).

Key Words:

● chiral compounds ● cyclodextrins

Cyclodextrins

Cyclodextrins (CDs) are cyclic, chiral, torus-shaped macromolecules composed of 6 or more D(+)-glucose residues bonded through α -(1-4) glycosidic linkage. CDs are classified by the number of glucose residues they contain; α -CDs contain 6 residues (cyclohexaamylose), β -CDs contain 7 (cycloheptaamylose), and γ -CDs contain 8 (cyclooctaamylose) (Figure A). The mouth of the torus-shaped CD molecule has a larger circumference than the base and is linked to secondary hydroxyl groups of the C₂ and C₃ atoms of each glucose unit (Figure B). The primary hydroxyl groups are located at the base of the torus, on the C₆ atoms. Free to rotate, they partially block the base. The size of the cavity increases with increasing number of glucose units, from 4.7-5.2Å for α -CD to 6.0-6.5Å for β -CD to 7.5-8.5Å for γ -CD. The hydroxyl groups in the glucose units can be selectively functionalized to provide various physical properties and inclu-

Figure A. Cyclodextrins (approx. to scale)

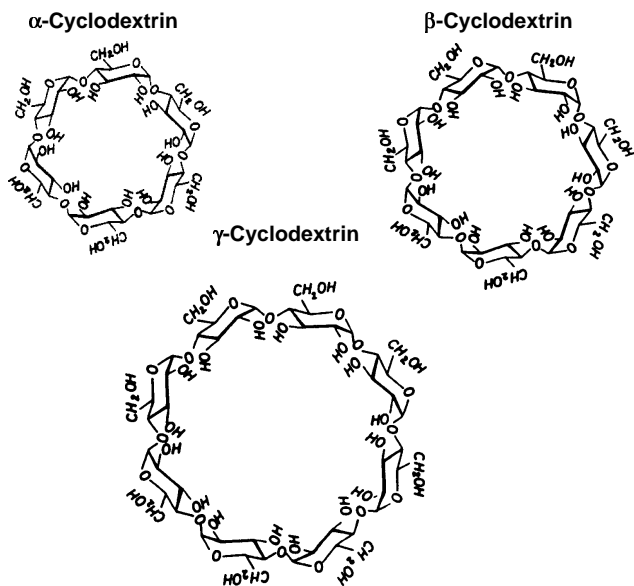

712-0575, 0576, 0577

Figure B. Cyclodextrin: Molecular Model

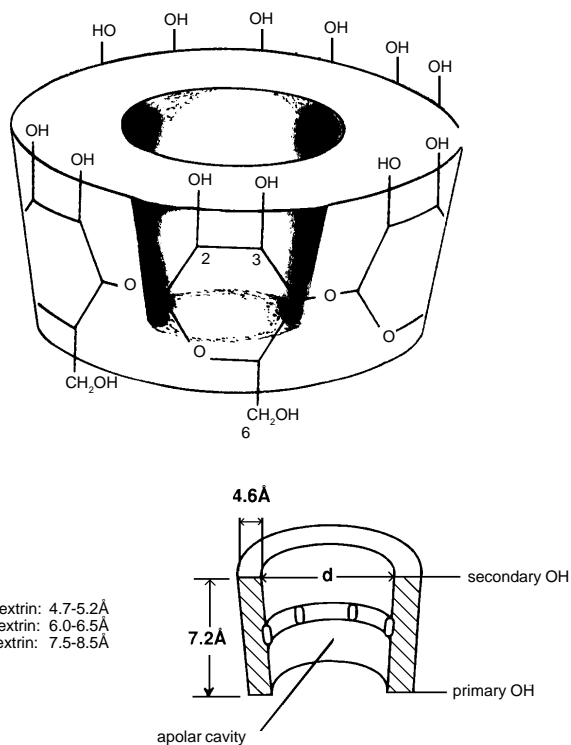

Cross section through the cone of α -, β -, or γ -cyclodextrin (6, 7, or 8 glucose units) with the hydroxyl groups outside the cavity and the ring of glycosidic oxygens -O- inside.

712-0090,93-9512

sion selectivities.

In the last few years enantiomers have been chromatographically separated by using peralkylated α -, β -, and γ -CD dissolved in polysiloxanes and coated within glass or fused silica capillary tubing (5,6). Without the cyclodextrin derivative, no enantiomeric selectivity is exhibited. Enantiomers of polar compounds (e.g., alcohols, diols, carboxylic acids) can be separated without previous derivatization on inert fused silica tubing coated with cyclodextrin/polysiloxane phases. Moreover, racemic alkanes and cycloalkanes are separated by such phases. Consequently, cyclodextrin stationary phases have broadened the capabilities of chiral separations into the fields of agriculture, foods, flavors, beverages, environmental samples, petrochemicals, chemicals and natural products.

DEX Columns

α -DEX, β -DEX, and γ -DEX columns are Supelco's new generation of selective, fused silica capillary columns, capable of efficiently separating both optical and positional isomers. We prepare these columns by adding permethylated α -CD (α -DEX), β -CD (β -DEX), or γ -CD (γ -DEX) to a phenyl-containing polysiloxane stationary phase. From extensive research, SPB™-35 was selected as the phase, because of its wide operating temperature range, its propensity for dissolving permethylated CDs, and its stability against oxidation. The DEX column name denotes both the type of CD and the amount of CD in the polysiloxane (weight percent). For example, α -DEX 110 denotes 10% α -CD and β -DEX 120 denotes 20% β -CD.

DEX columns make it possible to separate chiral compounds without derivatization – enantiomers and positional isomers are separated by slight differences associated with forming reversible inclusion complexes in the cavities of the functionalized CDs. DEX columns are useful for determining the enantiomeric excess of an enantiomer in a reaction mixture or product, or for identifying impurities in a sample. Not all racemates will separate on a single DEX column. In fact, it is difficult to predict exactly which phase will best separate a particular compound, but some general guidelines are available (Table 1).

Therefore, we offer a variety of α -DEX, β -DEX, and γ -DEX columns, which differ in enantioselectivity, efficiency, and sample capacity, due to differences in:

- the size of the CD inclusion cavity
- the percentage of CD (10% or 20% from stock, 1-30% available)
- column length (30m or 60m from stock, 5-100m available)
- column diameter (0.25mm or 0.53mm ID from stock, 0.10-0.53mm ID available)

Table 1. Enantiomeric Separations Achieved with DEX Columns

DEX Column	Probability of Achieving Separation	Compounds Separated
α -DEX 120	40-50%	alcohols, diols, epoxides, ethers, halohydrocarbons, ketones, positional isomers
β -DEX 110 β -DEX 120	80-90%	acids, amines, alcohols, diols, esters, ethers, halohydrocarbons, hydrocarbons, ketones, positional isomers, silanes, terpenes, terpeneols
γ -DEX 120	40-50%	acids, amines, esters, halohydrocarbons, ketones, positional isomers

α -DEX 120 Columns

A small internal cavity in the permethylated α -cyclodextrin generates the molecule's rigid nature and unique chiral selectivities. These columns have a high shape selectivity for positional isomers (e.g., xylenes, menthols, cresols, substituted-phenols, substituted benzenes) and epoxide enantiomers.

β -DEX 110 and β -DEX 120 Columns

The permethylated β -CD in β -DEX columns is unique because it contains an odd number (7) of glucose units. This asymmetrical geometry allows β -DEX columns to distinguish between the enantiomers of a large number of analytes. A β -DEX column is the first column of choice for separating any enantiomeric pair.

γ -DEX 120 Columns

Of the three cyclodextrins, the permethylated γ -CD in γ -DEX 120 columns has the largest cavity. This makes the γ -CD molecule more flexible and less selective in differentiating most enantiomers. Still, some large analytes (e.g., α -BHC, carvone, carboxylic acids, methamphetamine) show the greatest enantiomeric differentiation on a γ -DEX 120 column.

Because the permethylated CDs are not bonded to the polysiloxane cophase, DEX columns should not be rinsed with organic solvents. Solvents in the sample (less than 5 μ L) will not affect the columns.

For additional protection connect a 1-5m deactivated guard column to the inlet of the DEX column, via a GlasSeal™ connector (Cat. No. 2-0479).

The derivatized cyclodextrin in the phase makes it possible to have chromatographic separations below the melting point of the polysiloxane. To ensure reproducible retention times and enantioselectivity, however, we recommend raising the column temperature to the preliminary conditioning temperature (Table 2) for 5-10 minutes before each analysis. This is especially important with α -DEX columns, because the phase begins to solidify if the column is held below 50°C for 15 minutes. All DEX columns can be programmed to 250°C for short periods. The minimum and maximum operating temperatures are used in the examples in Figures C and D.

Table 2. Temperature Limits for DEX Columns

Column	Minimum	Temperature Preliminary Conditioning	Maximum*
α -DEX 120	30°C	220°C	240°C/250°C
β -DEX 110	30°C	170°C	240°C/250°C
β -DEX 120	30°C	170°C	240°C/250°C
γ -DEX 120	30°C	120°C	240°C/250°C

*Isothermal/programmed.

Figure C. (\pm)2-Butanol at 30°C (minimum temperature for DEX columns)

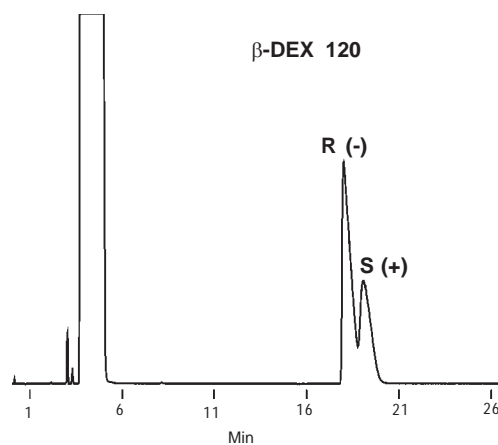

794-0218

Figure D. (\pm)2,2,2-Trifluoro-1-(9-anthryl)ethanol at 240°C (maximum temperature for DEX columns)

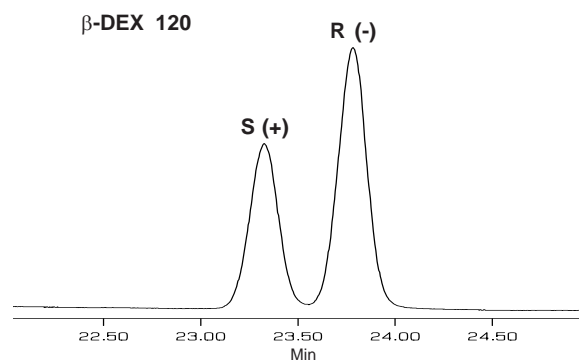

794-0219

Chiral Test Mixes

Each DEX column is individually tested with an appropriate isothermal test mix, to guarantee consistent column performance and provide reference values for future monitoring by the analyst. The components of each mix were chosen to monitor specific column performance parameters (Table 3). By using the test mix periodically, an analyst can monitor inertness, film thickness, chiral resolution, and efficiency.

Table 3. Test Mix Components

Component	Column Performance Monitored
normal alkanes	column efficiency (as theoretical plates/m) film thickness (as retention factor, k') retention index standards
optical isomers	enantioselectivity (as α value) retention index markers
positional isomers	shape selectivity (as α value)

The β -DEX Column Isothermal Test Mix (Cat. No. 4-8028) is formulated for monitoring the performance of β -DEX columns. The elution order of the components of this mix are shown in Figure E. The α -DEX Column Isothermal Test Mix (Cat. No. 4-8013) is similar to the β -DEX test mix. Separation factors (α values) are calculated for the racemic compound, (+/-)-1,2-propanediol, to monitor column enantioselectivity and for m- and p-xylene, to monitor column shape selectivity. Analysis of the α -DEX test mix on an α -DEX 120 column is shown in Figure F. The γ -DEX Column Isothermal Test Mix (Cat. No. 4-7898) was designed for evaluating the same performance parameters as the α -DEX test mix (Figure G). Shape selectivity of a γ -DEX column can be monitored by measuring the separation factor (α value) for 1,4- and 1,3-dichlorobenzene. Enantioselectivity (α value) can be monitored by observing the chiral separation of (+/-)-2-ethylhexanoic acid. A programmed test mix will provide a more stringent test of column performance (Figure H).

Figure E. β -DEX Column: Isothermal Test Mix

Column: β -DEX 120 (separation shown) or β -DEX 110,
30m or 60m x 0.25mm ID, 0.25 μ m film
Oven: 75°C (β -DEX 110) or 80°C (β -DEX 120)
Carrier: helium, 30cm/sec (30m columns)
or 20cm/sec (60m columns)
Det.: FID, 300°C
Inj.: 1 μ L test mix (Cat. No. 4-8028, 0.5mg/mL each analyte in
methylene chloride), split (100:1), 220°C

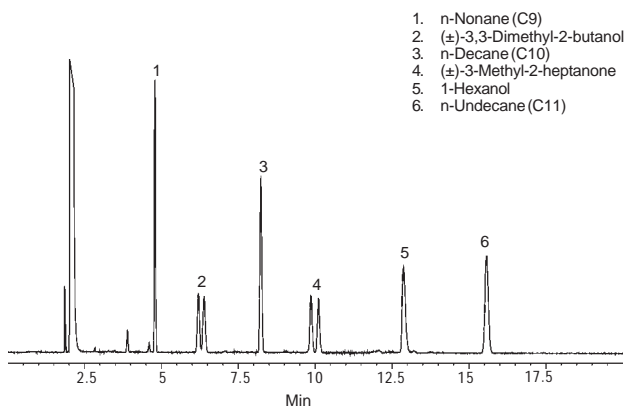

795-0637

Figure F. α -DEX Column: Isothermal Test Mix

Column: α -DEX 120, 30m x 0.25mm ID, 0.25 μ m film
Oven: 80°C
Carrier: helium, 30cm/sec
Det.: FID, 300°C
Inj.: 1 μ L test mix (Cat. No. 4-8013, 0.5mg/mL each analyte in
methylene chloride), split (100:1), 220°C

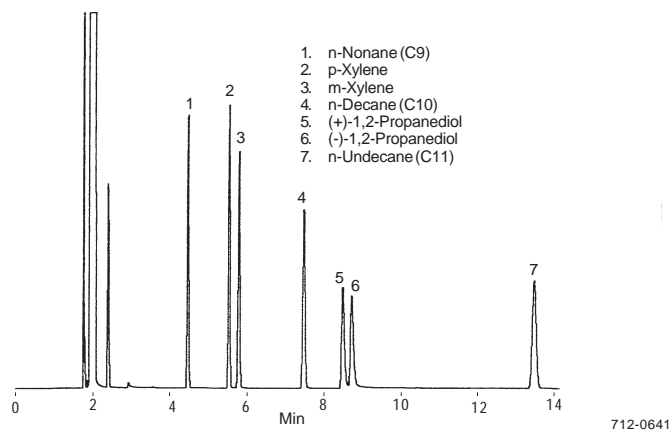

712-0641

Figure G. γ -DEX Column: Isothermal Test Mix

Column: γ -DEX 120, 30m x 0.25mm ID, 0.25 μ m film
Oven: 125°C
Carrier: helium, 30cm/sec
Det.: FID, 300°C
Inj.: 1 μ L test mix (Cat. No. 4-7898, 0.5mg/mL each analyte in
methylene chloride), split (100:1), 220°C

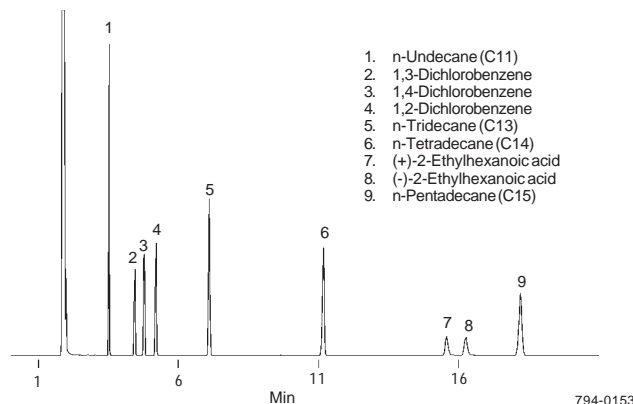

794-0153

Figure H. γ -DEX Column: Temperature Programmed Test Mix

Column: γ -DEX 120, 30m x 0.25mm ID, 0.25 μ m film
Oven: 90°C to 135°C at 1°C/min, then to 240°C at 5°C/min
Carrier: helium, 20cm/sec
Det.: FID, 300°C
Inj.: 1 μ L methylene chloride containing 0.5mg/mL each analyte,
split (100:1), 300°C

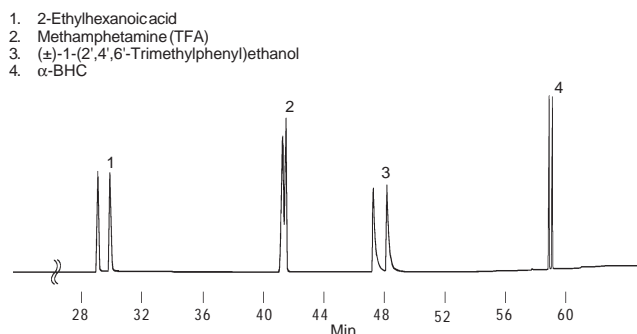

794-0520

Enantioselectivity (α) and Temperature

The GC oven temperature plays an important role in tuning the enantioselectivity (separation factor) of analytes on DEX columns. As depicted in Figure I, decreasing the isothermal temperature increases the separation of enantiomers (higher α values). When conditions yield poor separation of enantiomers, or no separation, reducing the analysis temperature might provide a satisfactory separation.

CD Content

The amount of cyclodextrin in the stationary phase affects the enantioselectivity and polarity of DEX columns. Enantioselectivity increases with higher percentages of CD (Figure J). Increasing the CD content also increases the polarity of the stationary phase. When the CD content is increased from 10% to 20%, 1-hexanol is retained longer, relative to the C10 and C11 hydrocarbons (Figure E).

We offer β -DEX columns with two levels of permethylated CD (10% and 20%) to provide columns that give similar enantiomeric separations, but different polarities. In some cases, the elution order of chiral and achiral components can be changed by connecting a conventional column of lower or higher polarity to the inlet of a DEX column (e.g., connect a SUPELCOWAX™ 10 column to a β -DEX 120 column).

Column Diameter (ID) and Resolution

Decreasing the internal diameter (ID) of DEX columns increases enantiomer resolution, while leaving separation factors (α values) unaffected (Table 4). To balance sample loading capacity and enantiomer resolution, you will find DEX columns of 0.25mm ID ideal for most separations. Custom-prepared 0.10mm ID DEX columns provide the highest resolution, but the lowest sample capacity. Because the opposite is true for 0.53mm ID DEX columns, the latter are best suited for semi-preparative separations (Figure K).

Applications

DEX columns are useful for separating a wide variety of optical isomers: pharmaceuticals, natural products, foods, flavors, agricultural, environmental and biological samples, synthesized asymmetric molecules, etc. (Tables 5, 6, and 7). DEX columns also effectively separate positional isomers.

Chiral Synthesis

In asymmetric synthesis using catalysts, it is important to determine the enantiomeric excess (ee) of products in the reaction mixture before doing any purification which might distort the ee value. Using DEX columns, ee or chiral purity can be determined directly, without sample modification or pretreatment.

Pharmaceuticals

Because enantiomers can have radically different potency and toxicity, single enantiomeric forms of drugs are being targeted by pharmaceutical manufacturers. DEX columns simplify the task of determining enantiomeric purity of pharmaceutical precursors, intermediates, and final products.

Foods, Flavors, and Fragrances

Individual enantiomers usually have significantly different odor and taste. Using DEX columns, analysts can detect adulteration of natural products, flavors in juices, and food additives. Extracts of caraway seed, mushrooms, citrus oils, pine oils and plant oils (obtained by solid phase microextraction) show the versatility of DEX columns for enantiomeric identification (7).

Figure I. Decreasing the (Isothermal) Temperature Increases Enantiomer Separation

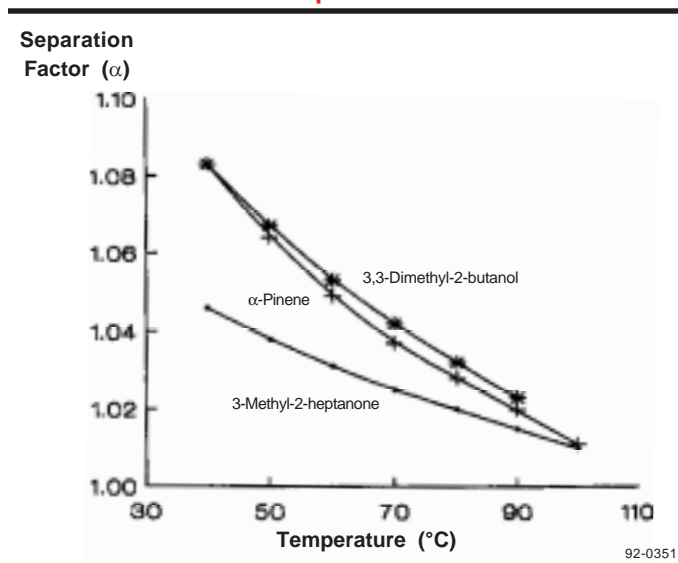

Figure J. Increasing the Cyclodextrin Percentage Increases Enantiomer Separation

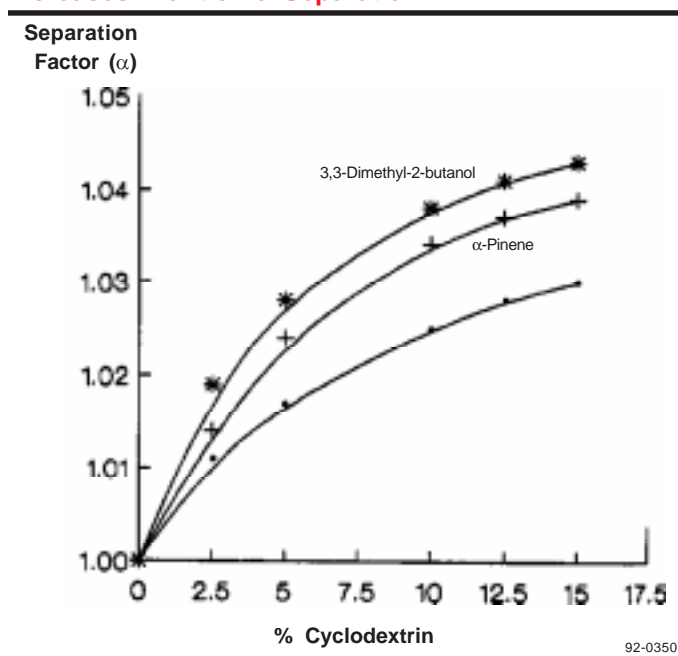

Table 4. Enantioselectivity (α) and Chiral Resolution (R_s) as Functions of Column ID*

Column ID	Test Compound					
	(+/-)-3,3-Dimethyl-2-butanol		(+/-)- α -Pinene		(+/-)-3-Methyl-2-heptanone	
	α	R_s	α	R_s	α	R_s
0.10mm	1.037	1.89	1.031	2.28	1.021	1.84
0.20mm	1.037	1.35	1.031	1.70	1.021	1.47
0.32mm	1.036	0.98	1.030	1.10	1.021	1.01
0.53mm	1.037	0.70	1.033	0.84	1.023	0.80

* β -DEX 110 columns (phase ratio = 250); 75 $^{\circ}\text{C}$; helium carrier.

Figure K. Decreasing Column ID Increases Enantiomer Resolution without Affecting Separation Factors*

Columns: β -DEX 110, 30m
 Oven: 75°C
 Carrier: helium, 30cm/sec
 Det.: FID, 300°C
 Inj.: 1 μ L, 0.5mg/mL each analyte in methylene chloride), split (100:1), 220°C

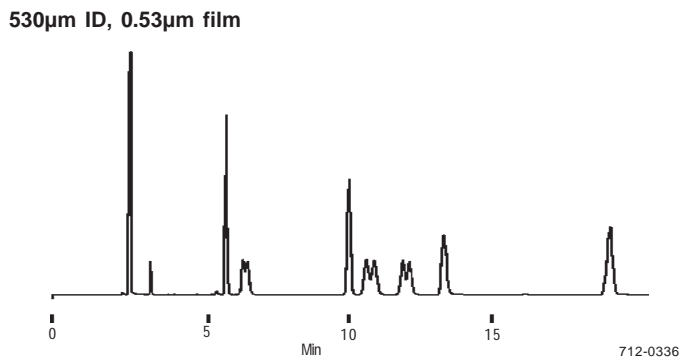
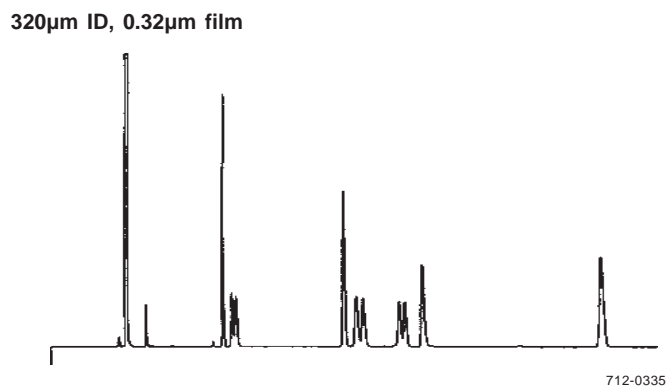
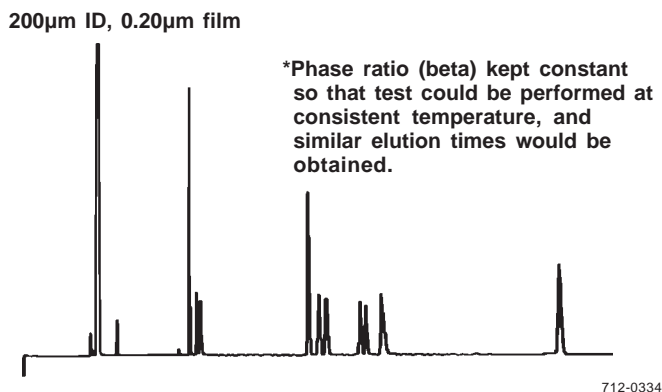
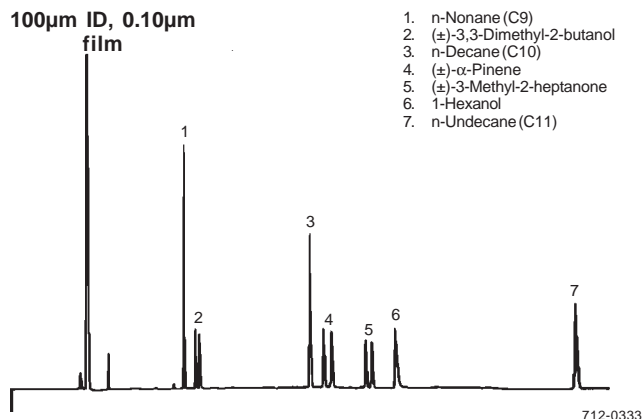

Environmental Applications

Currently, few organic compounds that are classified as environmental pollutants exhibit chirality (8). However, many exist as positional isomers that are often almost as difficult to separate (see α -BHC in Figure H). Separations of benzene, toluene, ethylbenzene, and the 3 xylenes, to detect leaking underground storage tanks (UST), and of positional isomers of dichlorobenzene, cresol, and dichlorophenol are examples of analyses involving difficult-to-resolve positional isomers.

Silicon Compounds

The importance of silicon chemistry in organic synthesis is increasing. DEX columns have been used successfully to separate several asymmetric silane racemates (Table 6) (9).

Industrial Chemicals

Characterization of large-scale industrial achiral chemicals requires the separation of low level impurities with boiling points close to that of the target product. Positional isomers are typically the most difficult to separate. α -DEX 120 columns have proven useful for separating positional isomers of xylenes, divinylbenzenes, chlorinated phenols, cresols, and chlorinated benzenes. Xylene isomers can be separated on these columns regardless of their relative concentrations.

Natural Products

Using a new sample preparation technique, solid phase microextraction (SPME), chiral and nonchiral volatile flavor and fragrance components can be extracted from natural products and essential oils (10).

Reversal of Enantioselectivity with DEX Columns

When determining optical purity with one enantiomer in large excess relative to the other, it is generally better to have the less concentrated enantiomer elute first. The enantiomer in excess frequently produces a large tailing peak that could overlap a smaller, later-eluting peak. Reversing the elution order of two enantiomers (enantio-reversal) also is useful in confirming separations and in mechanistic studies.

In some cases, enantio-reversal can be achieved by changing columns, such as from α -DEX to β -DEX or γ -DEX (7, 8, 10). For example, carvone enantiomers are separated in reversed order on α -DEX and γ -DEX columns, and coelute on β -DEX columns. Additional examples of enantio-reversal (α -BHC, alcohols, methyl mandelate) are listed in Table 7.

Separation Mechanism

The mechanism by which permethylated cyclodextrin columns separate enantiomers is not fully understood. Separations are, in part, due to the formation of geometrically dissimilar cyclodextrin inclusion complexes. Hydrogen bonding interactions are also involved in the enantioselectivity (Tables 5 and 7). It has been postulated that the number of glucose units (and whether an even or odd number) and the cyclodextrin cavity size play critical roles in differentially interacting with enantiomers. This can be visualized, for example, when one enantiomer predominantly forms an asymmetrical inclusion complex within the β -CD cavity. The other enantiomer, forced by geometrical constraints to form a completely different complex, begins to separate from the first enantiomer as a result of the differences in time spent by each in interacting with the β -CD macromolecule.

Table 5. Enantioselectivity of Substituted Phenyl Alcohols

		Separation Factor (α) at 110°C		
Compound		α -DEX 120	β -DEX 120	γ -DEX 120
1-phenylethanol		NS*	1.065	1.015
1-(2-methylphenyl)ethanol		1.022	1.194	1.032
1-(4-methylphenyl)ethanol		NS	1.088	1.036
1-(2,4-dimethylphenyl)ethanol		1.014	1.273	1.102
1-(2,5-dimethylphenyl)ethanol		1.038	1.230	1.058
1-(2,6-dimethylphenyl)ethanol		1.111	1.191	1.035
1-(3,4-dimethylphenyl)ethanol		NS	1.043	1.026
1-(3,5-bis(trifluoromethyl)phenyl)ethanol		1.017	1.117	1.008

		Separation Factor (α) at 140°C		
α -alkyl(2,4-dimethylbenzyl) alcohol		α -DEX 120	β -DEX 120	γ -DEX 120
alkyl (R) =				
-methyl**		1.012	1.125	1.043
-butyl		1.011	1.020	1.007
-isobutyl		1.015	1.059	1.032
-t-butyl		1.013	1.105	1.038
-pentyl		NS	NS	1.006
-hexyl		1.008	NS	1.008
-heptyl		1.003	1.013	1.083

		Separation Factor (α) at 140°C		
α -alkyl(2,6-dimethylbenzyl) alcohol		α -DEX 120	β -DEX 120	γ -DEX 120
alkyl (R) =				
-methyl***		1.072	1.110	1.020
-butyl		NS	1.036	NS
-isobutyl		NS	1.032	1.034
-t-butyl		NS	1.113	1.024
-pentyl		NS	1.038	NS
-hexyl		1.008	1.072	NS
-heptyl		1.002	1.083	1.010
-neopentyl		1.013	1.092	NS

Carrier: helium, 20cm/sec, 70cc/min splitter vent flow
 Detector: FID (4 x 10⁻¹¹ AFS), 250°C
 Injection: 1 μ L (0.1-0.5mg/mL each analyte), split (100:1), 250°C

*NS – no observable separation

**1-(2,4-dimethylphenyl)ethanol

***1-(2,6-dimethylphenyl)ethanol

References

- Cope, M.J., *Anal. Proc.* **30**: 498 (1993).
- Stinson, S.C., *Chem. Eng. News* **73** (41): 44 (1995).
- Gil-Av, E., B. Feibush, and R. Charles-Sigler, *Tetrahedron Lett.* 1009 (1966).
- Schurig, V. *Angew. Chem.* **96**: 733 (1984); *Angew. Chem. Int. Ed. Engl.* **23**: 747 (1984).
- Schurig, V. and H.-P. Nowotny, *Angew. Chem.* **102**: 969 (1990); *Angew. Chem. Int. Ed. Engl.* **29**: 939 (1990).
- Keim, W. A. Kohnes, W. Meltzow, and H. Romer, *HRC* **14**: 507 (1991).
- Mani, V. and C. Woolley, *LC-GC* **14**: 734 (1995).
- Falconer, R.L., T.F. Bidleman, D.J. Gregor, R. Semkin, and C. Teixeira, *Environ. Sci. Technol.* **29**: 1297 (1995).
- Feibush, B., C.L. Woolley, and V. Mani, *Anal. Chem.* **65**: 1130 (1993).
- Mani, V. and Woolley, C., *Foods and Food Ingredients Journal of Japan* **163**: 94 (1995).

DEX, GlasSeal, SPB, and SUPELCOWAX are trademarks of Sigma-Aldrich Co.
 Fused silica columns manufactured under HP US Pat. No. 4,293,415.

Table 6. Chiral Silanes

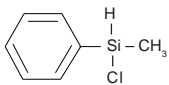
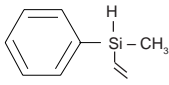
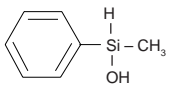
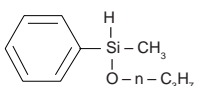
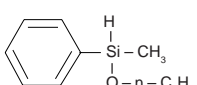
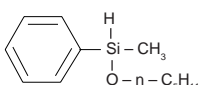
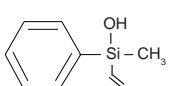
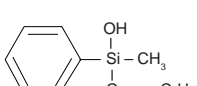
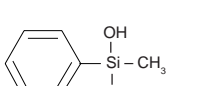
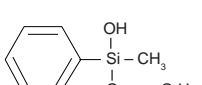
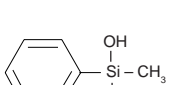
Compound	Structure	Col. Temp.	α value* and (k'_1)		
			α -DEX 110	β -DEX 110	γ -DEX 110
Phenylmethylchlorosilane (Chloromethylphenylsilane)		70°C	NS* (10.3)	NS (11.4)	1.006 (10.9)
Phenylmethylvinylsilane (Methylphenylvinylsilane)		70°C	NS (9.1)	1.012 (9.5)	NS (9.5)
Phenylmethylhydroxysilane (Methylphenylsilanol)		100°C	1.015 (9.0)	1.084 (13.5)	1.015 (10.4)
Phenylmethylpropoxysilane (Methylphenylpropoxysilane)		100°C	NS (6.1)	NS (6.2)	NS (5.6)
Phenylmethylbutoxysilane (Butoxymethylphenylsilane)		100°C	NS (11.1)	NS (11.5)	NS (10.2)
Phenylmethylpentoxysilane (Methylpentoxyphenylsilane)		100°C	NS (20.4)	1.008 (21.3)	NS (18.5)
Methylphenylvinylsilanol		120°C	1.008 (6.6)	1.019 (8.8)	1.015 (8.3)
Methylphenylpropoxysilanol		140°C	1.013 (5.6)	1.017 (6.2)	1.014 (6.5)
Methylphenylbutoxysilanol		140°C	1.018 (8.8)	1.038 (9.7)	1.015 (10.4)
Methylpentoxyphenylsilanol		140°C	1.019 (14.3)	1.065 (15.5)	1.025 (16.6)
Hexylmethylphenylsilanol		140°C	NS (17.9)	1.027 (19.4)	1.023 (20.0)

*NS – no observable separation

*See Key Words and Definitions on page 16.

 $k'_1 = k'$ for first eluting peak.

Table 7. Chiral Compounds

Compound	Structure	Col. Temp.	α value and (k'_1)			
			α -DEX 120	β -DEX 110	β -DEX 120	γ -DEX 120
Acids						
2-Methylbutyric acid		110°C	NS ¹ (1.9)	1.046 (2.1)	1.051 (3.8)	1.010 (2.6)
2-Ethylhexanoic acid		125°C	1.012 (5.0)	1.035 (5.3)	—	1.048 (7.0)
Amines						
α -Methylbenzylamine		90°C	NS (7.8)	1.029 (8.5)	1.030 (11.9)	NS (9.5)
N-Trifluoroacetyl-methamphetamine		90°C 1°/min	NS (26.6)	NS (27.1)	—	1.066 (23.3)
Alcohols						
2-Butanol		30°C	NS (2.4)	1.043 (4.2)	1.070 (5.0)	NS (2.8)
trans-2-Methylcyclopentanol		70°C	1.040 (4.2)	—	1.060 (13.6)	NS (5.0)
3-Methylcyclopentanol		70°C	1.021 (5.4)	NS (7.5)	NS (13.7)	NS (4.8)
2-Octanol		80°C	1.017 (7.9)	1.011 (8.3)	1.017 (13.4)	NS (7.7)
1-Octen-3-ol		80°C	1.030 (6.9)	1.015 (8.5)	1.021 (13.5)	NS (5.3)
α -Terpineol ²		100°C	NS (12.4)	1.031 (15.2)	1.042 (23.7)	1.028 (15.4)
Terpinen-4-ol ³		100°C	NS (6.2)	1.032 (1.8)	1.036 (10.2)	1.010 (12.3)
Borneol		120°C	NS (4.6)	1.046 (6.7)	1.051 (7.9)	NS (6.1)
Isoborneol		120°C	NS (3.8)	1.021 (6.0)	1.025 (9.1)	NS (6.9)

Table 7. Chiral Compounds contd.

Compound	Structure	Col. Temp.	α value and (k')			
			α -DEX 120	β -DEX 110	β -DEX 120	γ -DEX 120
Exonorborneol		120°C	NS (4.2)	—	1.026 (3.0)	NS (2.1)
Menthol		110°C	1.021 (6.7)	1.025 (7.6)	1.031 (11.5)	1.030 (8.5)
Isomenthol ⁴		110°C	1.030 (7.0)	1.031 (8.6)	1.041 (14.6)	1.015 (9.9)
Neomenthol		110°C	1.060 (6.1)	1.037 (6.9)	1.048 (10.2)	1.025 (7.6)
2-Phenyl-1-propanol		110°C	1.012 (10.2)	1.016 (11.2)	1.014 (12.8)	1.006 (13.2)
1-Phenyl-2-propanol		110°C	NS (7.5)	1.018 (7.9)	1.016 (8.9)	NS (8.6)
1-Phenyl-1-butanol		130°C	1.016 (6.5)	NS (6.6)	NS (9.2)	NS (8.3)
Linalool		90°C	NS (8.4)	1.024 (12.3)	1.019 (10.7)	NS (5.6)
2,2,2-Trifluoro-1-(9-anthryl)ethanol		240°C	1.008 (18.0)	1.015 (7.3)	1.018 (8.6)	1.014 (9.7)
Glycidol		40°C	1.043 (11.5)	1.052 (12.3)	1.066 (10.9)	1.016 (10.8)
Isopinocampheol		100°C	1.027 (10.8)	1.014 (16.5)	1.061 (4.5)	1.011 (17.9)

Table 7. Chiral Compounds contd.

Compound	Structure	Col. Temp.	α value and (k')			
			α -DEX 120	β -DEX 110	β -DEX 120	γ -DEX 120
1-Phenylethanol		120°C	NS (3.9)	1.051 (4.1)	1.068 (5.9)	1.021 (4.7)
1-Phenyl-2,2,2-trifluoroethanol		120°C	NS (4.8)	1.071 (5.9)	1.085 (9.7)	1.063 (7.7)
6-Methyl-5-hepten-2-ol		90°C	NS (4.6)	1.041 (5.2)	—	—
Diols						
1,2-Propanediol		80°C	1.034 (4.0)	1.028 (3.4)	1.028 (5.9)	NS (3.3)
1,2-Butanediol		100°C	1.030 (3.2)	1.040 (3.2)	1.044 (5.0)	NS (2.8)
1,3-Butanediol		100°C	1.014 (3.9)	1.017 (3.9)	1.021 (6.2)	NS (3.6)
2,3-Butanediol		100°C	NS (1.6)	1.053 (1.7)	NS (2.7)	NS (1.5)
1,2-Pentanediol		100°C	1.040 (5.9)	1.041 (6.5)	1.046 (10.4)	1.008 (5.6)
1,4-Pentanediol		100°C	NS (8.7)	1.023 (10.6)	1.027 (17.6)	NS (8.3)
2,4-Pentanediol		100°C	1.016 (3.7)	1.013 (4.0)	1.012 (6.8)	1.061 (3.4)
1,5-Hexanediol		100°C	1.015 (16.1)	1.024 (20.0)	1.028 (32.6)	1.011 (17.8)
2,5-Hexanediol		100°C	1.029 (8.2)	1.020 (11.3)	1.035 (17.8)	NS (9.8)

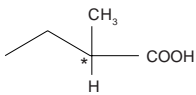
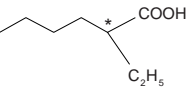
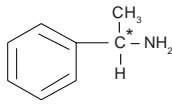
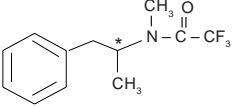
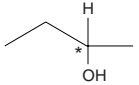
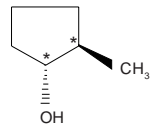
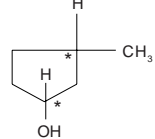
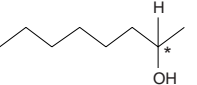
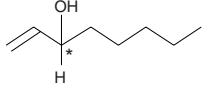
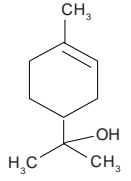
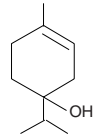
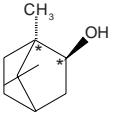
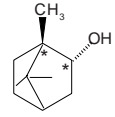
Table 7. Chiral Compounds contd.

Compound	Structure	Col. Temp.	α value and (k')			
			α -DEX 120	β -DEX 110	β -DEX 120	γ -DEX 120
trans-1,2-Cyclohexanediol		110°C	1.018 (8.5)	1.089 (11.5)	1.081 (20.8)	1.030 (11.8)
Esters						
Methyl mandelate ⁵		130°C	1.021 (10.5)	NS (9.8)	NS (10.3)	1.017 (12.9)
Ethyl mandelate		130°C	1.019 (13.1)	NS (11.8)	NS (12.3)	NS (14.7)
Ethyl 2-methylbutyrate		40°C	NS (8.5)	1.027 (8.2)	1.037 (12.5)	NS (6.8)
Methyl DL-2-bromopropionate		70°C	NS (3.6)	1.109 (4.4)	1.156 (6.7)	1.022 (4.0)
Methyl DL-2-chloropropionate		70°C	NS (1.8)	1.062 (2.3)	1.089 (3.4)	1.013 (2.0)
α -Methylbenzyl acetate		90°C	NS (19.0)	1.119 (17.8)	1.115 (20.9)	1.028 (19.1)
2-Butyl acetate		60°C	—	—	1.125 (1.9)	—
Phenyl 2-methylbutyrate		130°C	—	—	1.021 (9.0)	—
1-Phenylethyl butyrate		120°C	NS (13.2)	1.013 (11.7)	1.027 (13.4)	1.016 (13.1)
Ethyl 2-pyrrolidone-5-carboxylate		100°C	—	—	1.070 (11.7)	—
Dimethyl tartrate		120°C	—	—	1.154 (20.5)	—

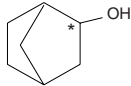
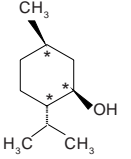
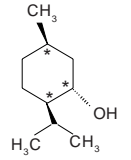
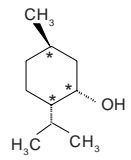
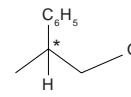
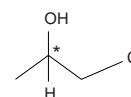
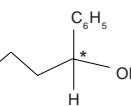
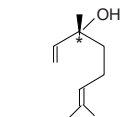
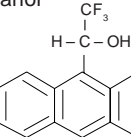
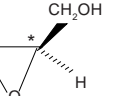
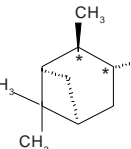
Table 7. Chiral Compounds contd.

Compound	Structure	Col. Temp.	α value and (k')			
			α -DEX 120	β -DEX 110	β -DEX 120	γ -DEX 120
Diisopropyltartarate		150°C	—	—	1.069 (7.5)	—
Ethers						
2,5-Dimethyltetrahydrofuran		60°C	1.022 (1.1)	1.046 (1.1)	1.062 (1.9)	NS (0.8)
2,5-Dimethoxytetrahydrofuran		60°C	1.027 (5.2)	1.150 (6.0)	1.208 (9.1)	1.023 (5.5)
2,5-Diethoxytetrahydrofuran		100°C	1.038 (2.2)	1.064 (1.9)	1.084 (1.8)	1.039 (2.3)
Glycidyl-2-methylphenyl-ether		120°C	1.005 (17.8)	NS (16.2)	NS (19.6)	NS (19.1)
sec-Butylmethylether		35°C	NS (1.7)	1.043 (2.9)	1.041 (2.1)	NS (1.7)
(1-Phenyl)ethylbutylether		120°C	1.027 (17.9)	1.007 (15.2)	1.018 (16.5)	NS (17.6)
Halogenated Compounds						
1-Chloro-2-propanol		40°C	1.033 (7.9)	1.018 (8.9)	NS (8.5)	1.754 (4.6)
Pentachlorocyclohexene ³		160°C	NS (13.7)	1.026 (13.2)	1.036 (16.6)	1.017 (18.3)
α -BHC ^{3,6} (Hexachlorocyclohexane)		160°C	1.011 (17.6)	1.014 (16.4)	1.020 (19.0)	1.042 (22.2)
2-Bromopentane		50°C	1.015 (2.1)	1.032 (3.6)	1.044 (4.0)	NS (2.6)

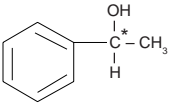
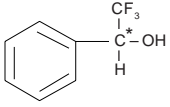
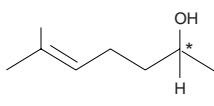
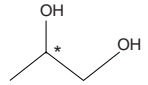
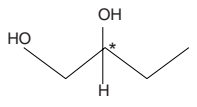
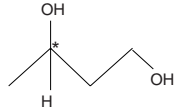
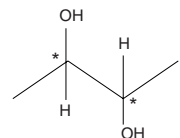
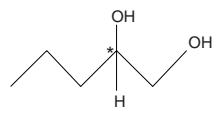
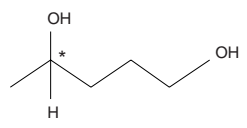
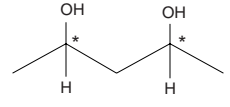
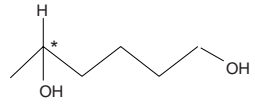
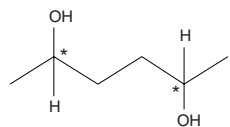
Table 7. Chiral Compounds contd.

Compound	Structure	Col. Temp.	α value and (k')			
			α -DEX 120	β -DEX 110	β -DEX 120	γ -DEX 120
2-Bromo-1-chloropropane		55°C	NS (4.9)	1.019 (3.8)	1.025 (5.8)	NS (2.3)
2-Iodobutane		60°C	NS (10.3)	1.013 (12.0)	1.015 (17.7)	1.017 (8.9)
2-Bromoheptane		60°C	NS (9.3)	1.013 (12.8)	1.012 (12.2)	1.014 (9.2)
Chlorobromoacetonitrile		70°C	NS (10.3)	1.013 (9.3)	1.013 (6.4)	NS (7.5)
Chlorobromoacetic acid methyl ester		70°C	NS (7.5)	1.024 (16.1)	1.030 (12.0)	—
Menthol chloroformate		100°C	NS (20.9)	—	1.021 (33.2)	1.033 (17.4)
Hydrocarbons						
8-Ketotricyclo-[5•2•1•0 ^{2,6}]decane		130°C	NS (7.9)	1.030 (9.2)	1.041 (13.8)	1.018 (8.9)
α -Pinene		80°C	NS (1.9)	1.032 (2.9)	1.048 (4.5)	NS (2.4)
Camphene		80°C	NS (2.4)	1.037 (3.9)	1.051 (6.1)	NS (3.2)
Limonene		80°C	1.024 (4.9)	1.023 (5.7)	1.030 (8.2)	NS (5.3)
Ketones Carvone ⁷		90°C	1.012 (23.7)	NS (24.7)	NS (43.7)	1.020 (30.6)

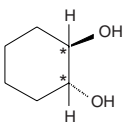
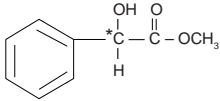
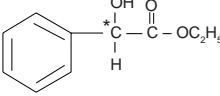
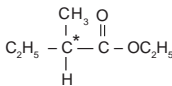
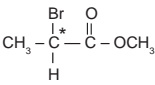
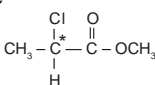
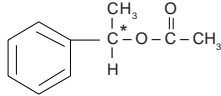
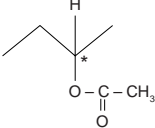
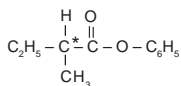
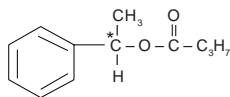
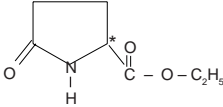
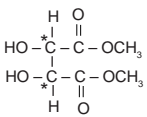
Table 7. Chiral Compounds contd.

Compound	Structure	Col. Temp.	α value and (k')			
			α -DEX 120	β -DEX 110	β -DEX 120	γ -DEX 120
2-Methylcyclohexanone		70°C	1.014 (7.8)	1.014 (9.7)	1.020 (14.7)	NS (7.8)
3-Methylcyclohexanone		70°C	1.017 (8.3)	NS (6.8)	NS (11.5)	NS (5.8)
Hexobarbital		210°C	NS (9.1)	1.025 (7.0)	1.036 (8.6)	1.010 (9.5)
Mephobarbital		210°C	NS (11.6)	1.034 (8.7)	1.050 (10.9)	1.016 (12.2)
Aromatic Positional Isomers						
2,5- and 2,4-Dimethylphenol		160°C	1.097 (1.5)	1.128 (2.7)	1.120 (1.9)	1.073 (2.3)
3,4- and 3,5-Dimethylphenol		160°C	1.039 (2.1)	1.170 (3.6)	1.157 (2.5)	1.175 (3.2)
Chlorobenzene / Ethylbenzene		110°C	1.140 (0.7)	1.081 (0.7)	1.109 (0.9)	1.088 (0.7)
p-Xylene / m-Xylene		70°C	1.090 (2.9)	NS (2.6)	NS (3.3)	1.024 (2.7)
m-Xylene / o-Xylene		70°C	1.214 (3.2)	1.355 (2.6)	1.345 (3.3)	1.276 (2.8)
m-Divinylbenzene / p-Divinylbenzene		140°C	1.088 (1.5)	1.125 (1.3)	1.153 (1.6)	1.111 (1.5)
m-Ethylvinylbenzene / p-Ethylvinylbenzene		140°C	1.066 (1.1)	1.084 (1.0)	1.108 (1.3)	1.069 (1.1)

Table 7. Chiral Compounds contd.

Compound	Structure	Col. Temp.	α value and (k')			
			α -DEX 120	β -DEX 110	β -DEX 120	γ -DEX 120
Toluene / Toluene-d ₈		30°C	1.039 (5.9)	—	1.027 (7.7)	—

¹NS = no observable separation
²Enantio-reversal from β -DEX column to γ -DEX column.
³(+) Enantiomer elutes first from β -DEX column. (-) Enantiomer elutes first from γ -DEX column.
⁴(-) Enantiomer elutes first from α -DEX or β -DEX column. (+) Enantiomer elutes first from γ -DEX column.
⁵(+) Enantiomer elutes first from α -DEX column. (-) Enantiomer elutes first from γ -DEX column.
⁶Elution order not determined for α -DEX column.
⁷(-) Enantiomer elutes first from α -DEX column. (+) Enantiomer elutes first from γ -DEX column.

Gas Chromatographic Enantiomer Separation with Modified Cyclodextrins

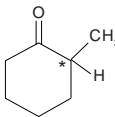
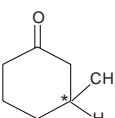
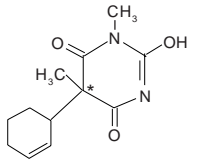
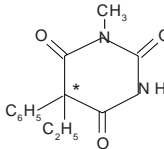
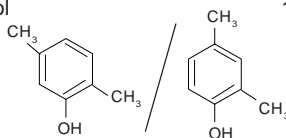
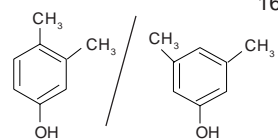
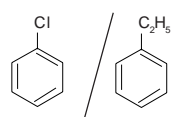
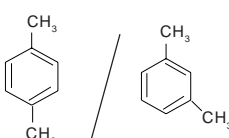
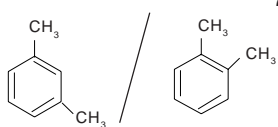
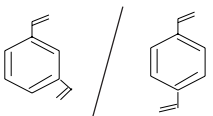
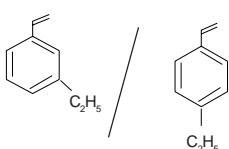
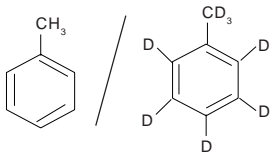
W.A. König, Hüthig, 1992, 168 pp.

Lipophilic cyclodextrin derivatives have proven superior to all other previously used chiral stationary phases for capillary GC, due to their almost unlimited range of applications. Numerous examples are given of stereochemical separations. In addition to covering the data of all the resolved chiral compounds, the preparation and characterization of lipophilic cyclodextrin derivatives and the production and testing of glass and fused silica capillary columns are described in detail.

Description	Cat. No.
Book	2-6554

Chromatographic Enantioseparation: Methods and Applications (2nd Edition)

S.G. Allenmark, Prentice Hall, 1991, 244 pp.

Comprehensive treatment of chiral chromatography, including basic theory and methodology.

Description	Cat. No.
Book	Z23,412-5

Chiral Liquid Chromatography

W.J. Lough, Ed., Blackie/Chapman and Hall, 1989, 288 pp.

This comprehensive reference provides a thorough review of chiral liquid chromatography systems and their practical applications. It includes background material on the nature of chirality, the historical development and use of chiral LC, and an appendix with relevant suppliers and products.

Description	Cat. No.
Book	Z23,560-1

Key Words and Definitions

α -DEX

α -cyclodextrin-containing capillary GC column, proprietary to Supelco

asymmetric molecule

molecule with different substituents to a central carbon, silicon, phosphorus, etc. atom (e.g., C*R₁R₂R₃R₄), existing in two mirror image configurations with no elements of symmetry

β -DEX

β -cyclodextrin-containing capillary GC column, proprietary to Supelco

CD

cyclodextrin

chiral molecule

molecule that can exist in two non-superimposable (mirror image) configurations (e.g., d- and l-glucose)

enantiomeric resolution (Rs)

a measure of chromatographic separation of isomers in which column efficiency is considered:

$$R_s = 1.177 \times \frac{t_{r2} - t_{r1}}{w_1 + w_2}$$

w_1 & w_2 are peak widths for isomers 1 & 2 at half-height

enantiomers (optical isomers)

non-superimposable mirror image molecules which rotate polarized light in equal and opposite directions (e.g., d- and l-amino acids)

enantiomeric excess (ee)

the percent by which one enantiomer of an optically active compound is in excess of the other in a mixture of the two (typically determined from area or area %):

$$ee = \frac{\% \text{ enantiomer}_1 - \% \text{ enantiomer}_2}{\% \text{ enantiomer}_1 + \% \text{ enantiomer}_2} \times 100$$

enantio-reversal

reversal in the elution order of two enantiomers as a result of changing the (CD) stationary phase

enantioselectivity

same as separation factor

γ -DEX

γ -cyclodextrin-containing capillary GC column, proprietary to Supelco

meso compound

a molecule which contains two or more chiral centers, but has a plane of symmetry and thus is optically inactive

optical purity

the percent of one enantiomer in excess of the other, as determined from optical rotation measurements

positional isomers

molecules having identical molecular formula, but with one substituent (Cl, OH, etc.) located at different positions

racemate (racemic mixture)

a 50:50 mixture of two enantiomers, denoted as (dl) or (+/-)

retention factor (k')

a relative measure of chromatographic retention of a compound:

$$k' = \frac{\text{retention time of compound} - \text{dead time}}{\text{dead time}}$$
$$= \frac{t_r - t_0}{t_0}$$

separation factor (α value)

a measure of chromatographic separation of isomers in which column efficiency **is not** considered:

$$\alpha = \frac{\text{retention time}_{\text{isomer 2}} - \text{dead time}}{\text{retention time}_{\text{isomer 1}} - \text{dead time}}$$

$$= \frac{t_{r2} - t_0}{t_{r1} - t_0} = \frac{k'_2}{k'_1}$$

stereochemistry

the study of molecules having the same molecular formula, but different spatial orientations

Menthols

Column: α -DEX 120, 30m x 0.25mm ID, 0.25 μ m film
 Cat. No.: 2-4310
 Column: β -DEX 110, 30m x 0.25mm ID, 0.25 μ m film
 Cat. No.: 2-4301
 Oven: 110°C
 Carrier: helium, 20cm/sec
 Det.: FID, 300°C
 Inj.: 1 μ L methylene chloride (0.5mg/mL each analyte), split (100:1), 300°C (α -DEX 120) or 220°C (β -DEX 110)

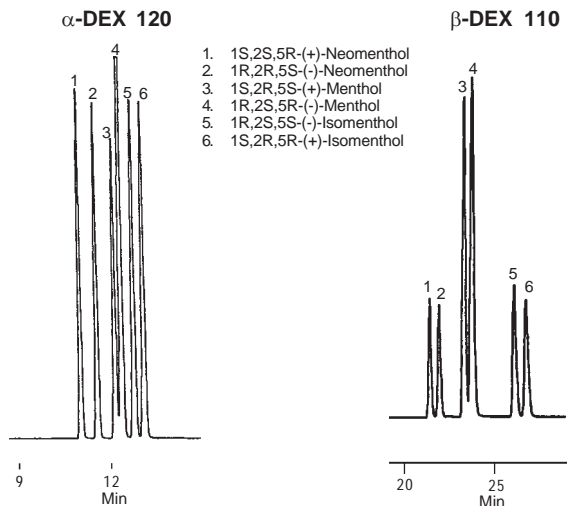

713-0089,712-0265

(±)-1-Octen-3-ol

Column: α -DEX 120, 30m x 0.25mm ID, 0.25 μ m film
 Cat. No.: 2-4310
 Oven: 100°C
 Carrier: helium, 20cm/sec
 Det.: FID, 300°C
 Inj.: 1 μ L methanol (0.5mg/mL each analyte), split (100:1), 250°C

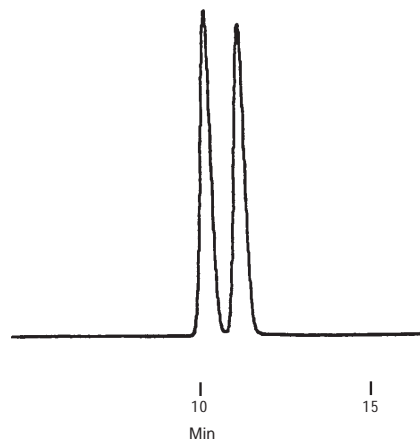

713-0090

1-Phenylethanol; 1-Phenylpropanol

1-Phenylethanol*
 Column: β -DEX 110, 30m x 0.25mm ID, 0.25 μ m film
 Cat. No.: 2-4301
 Oven: 110°C
 Carrier: helium, 20cm/sec
 Det.: FID, 200°C
 Inj.: 1 μ L methylene chloride (0.5mg/mL each analyte), split (100:1), 150°C

1-Phenylpropanol
 Column: β -DEX 120, 30m x 0.25mm ID, 0.25 μ m film
 Cat. No.: 2-4304
 Oven: 130°C
 Carrier: helium, 20cm/sec
 Det.: FID, 300°C
 Inj.: 1 μ L methylene chloride containing 1mg/mL racemate, split 100:1, 220°C

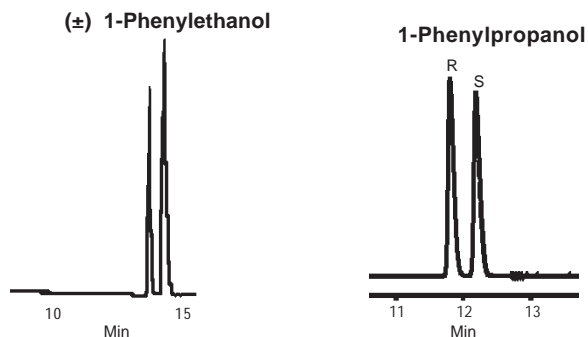
**Citronellal**

Column: β -DEX 225, 30m x 0.25mm ID, 0.25 μ m film
 Cat. No.: 2-4348
 Oven: 95°C
 Carrier: helium, 20cm/sec
 Det.: FID, 300°C
 Inj.: 1 μ L methylene chloride containing 1mg/mL mixed enantiomers, split 100:1, 220°C

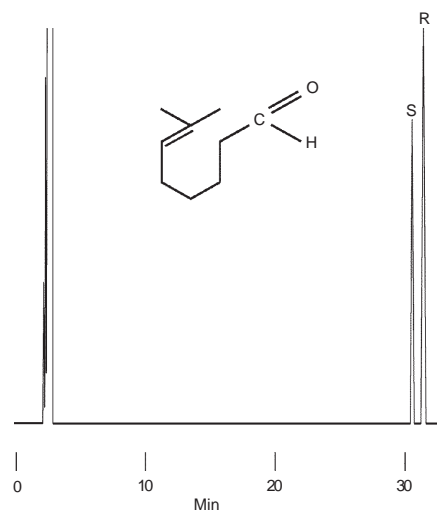

*Application developed by Dr. L. Sundaram, The Pennsylvania State University, University Park, PA USA.

712-0253,797-0151

796-0642

Linalool

Column: β -DEX 110, 30m x 0.25mm ID, 0.25 μ m film
Cat. No.: 2-4301
Oven: 100°C
Carrier: helium, 20cm/sec
Det.: FID, 200°C
Inj.: 1 μ L methylene chloride (0.5mg/mL each analyte), split (100:1), 150°C

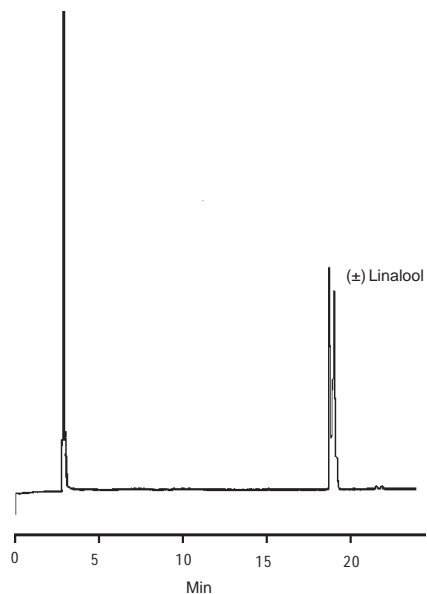

712-0267

2,2,2-Trifluoro-1-(9-anthryl)ethanol

Column: γ -DEX 120, 30m x 0.25mm ID, 0.25 μ m film
Cat. No.: 2-4307
Oven: 240°C
Carrier: helium, 20cm/sec
Det.: FID, 300°C
Inj.: 1 μ L methylene chloride (0.5mg/mL each analyte), split (100:1), 300°C

1. S-(+)-2,2,2-Trifluoro-1-(9-anthryl)ethanol
2. R-(-)-2,2,2-Trifluoro-1-(9-anthryl)ethanol

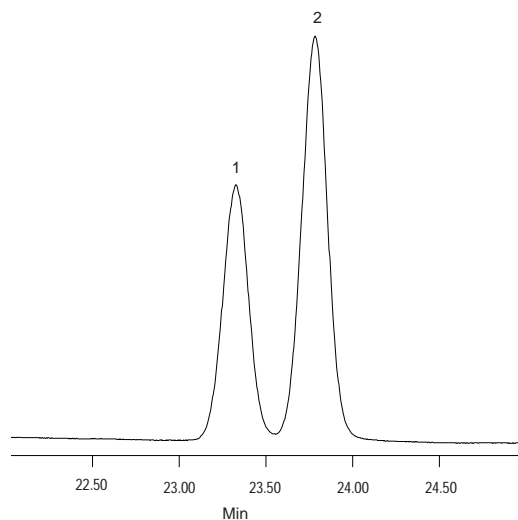

794-0219

Alcohols

Column: β -DEX 120, 30m x 0.25mm ID, 0.25 μ m film
Cat. No.: 2-4304
Oven: 120°C
Carrier: helium, 20cm/sec
Det.: FID, 300°C
Inj.: 1 μ L methylene chloride (0.5mg/mL each analyte), split (100:1), 200°C

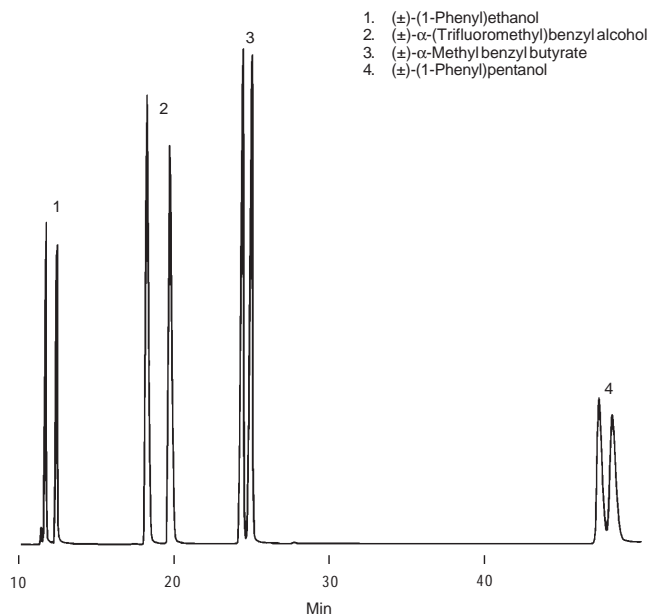

94-0340

5-Hydroxy-4-methyl-3-heptanone

Column: γ -DEX 120, 30m x 0.25mm ID, 0.25 μ m film
Cat. No.: 2-4307
Oven: 110°C
Carrier: helium, 35cm/sec
Det.: FID, 300°C
Inj.: 1 μ L methylene chloride (0.5mg/mL each analyte), split (100:1), 300°C

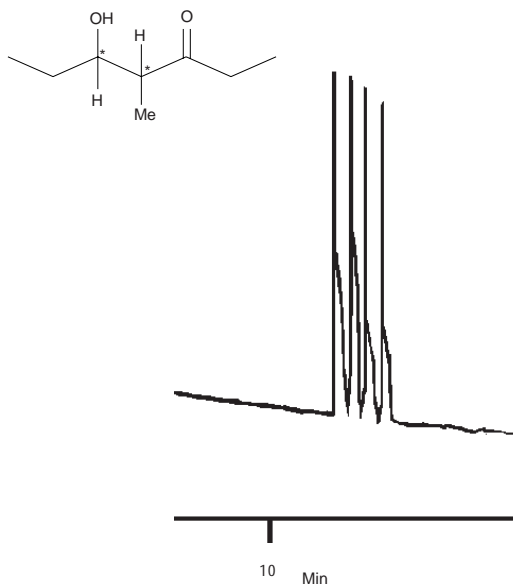

92-0344

Terpinen-4-ol (Enantio-reversal)

Column: β -DEX 120 and γ -DEX 120, 30m x 0.25mm ID, 0.25 μ m film
 Cat. No.: 2-4304 (β -DEX 120), 2-4307 (γ -DEX 120)
 Oven: 100°C
 Carrier: helium, 35cm/sec
 Det.: FID, 300°C
 Inj.: 1 μ L methylene chloride (1mg/mL each analyte), split (100:1), 250°C

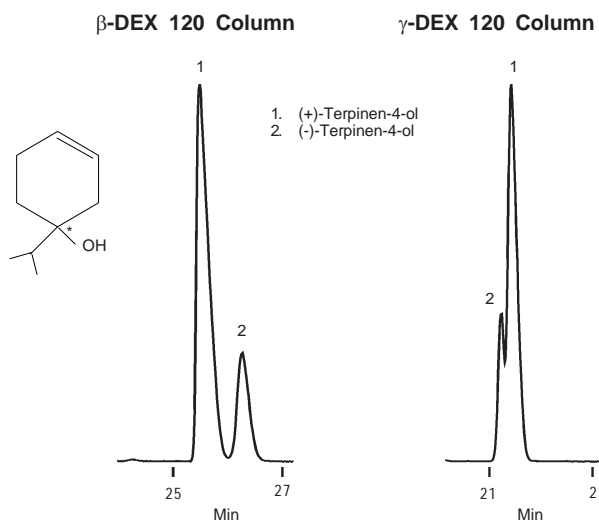

794-0284,0285

Aromatics

Divinylbenzenes

Column: α -DEX 120, 30m x 0.25mm ID, 0.25 μ m film
 Cat. No.: 2-4310
 Oven: 140°C
 Carrier: helium, 35cm/sec
 Det.: FID, 300°C
 Inj.: 4 μ L methylene chloride (0.5mg/mL each analyte), split (100:1), 300°C

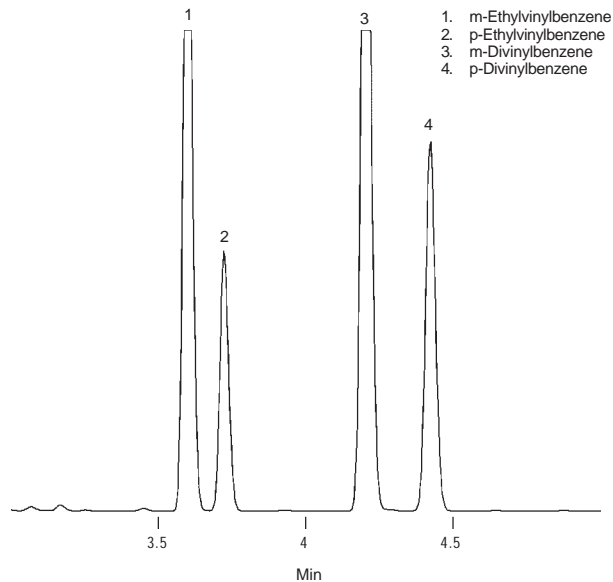

795-0801

Menthols (Enantio-reversal)

Column: α -DEX 120, β -DEX 120, and γ -DEX 120, 30m x 0.25mm ID, 0.25 μ m film
 Cat. No.: 2-4310 (α -DEX 120), 2-4304 (β -DEX 120), 2-4307 (γ -DEX 120)
 Oven: 110°C
 Carrier: helium, 30cm/sec
 Det.: FID, 300°C
 Inj.: 1 μ L methylene chloride (0.5mg/mL each analyte), split (100:1), 250°C

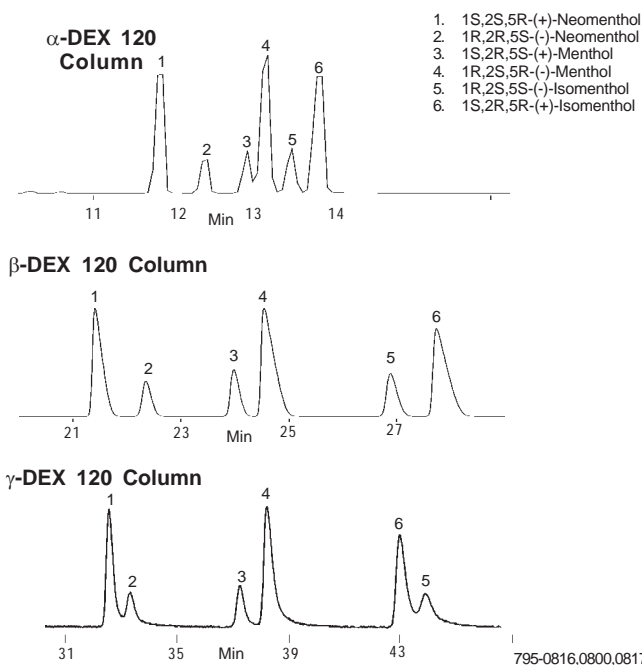

795-0816,0800,0817

Xylene Isomers

Column: α -DEX 120, 30m x 0.25mm ID, 0.25 μ m film
 Cat. No.: 2-4310
 Oven: 50°C
 Carrier: helium, 30cm/sec
 Det.: FID, 300°C
 Inj.: 0.6 μ L each analyte (neat), split (100:1), 80°C

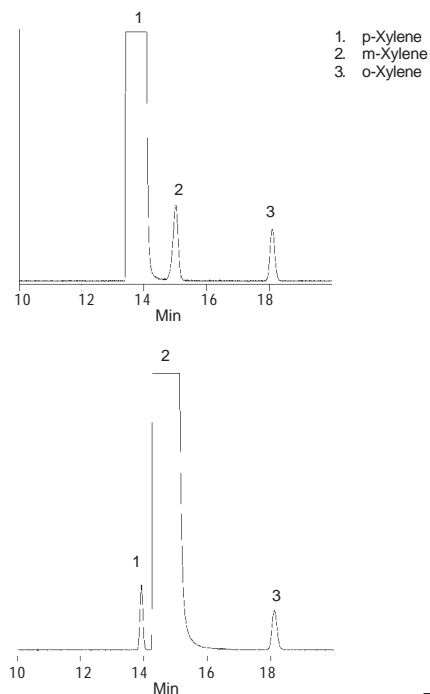

794-0648,0649

Aromatics

Column: β -DEX 110, 30m x 0.25mm ID, 0.25 μ m film
 Cat. No.: 2-4301
 Oven: 50°C
 Carrier: helium, 20cm/sec
 Det.: FID, 260°C
 Inj.: 0.1 μ L methylene chloride (0.5mg/mL each analyte), split (100:1), 100°C

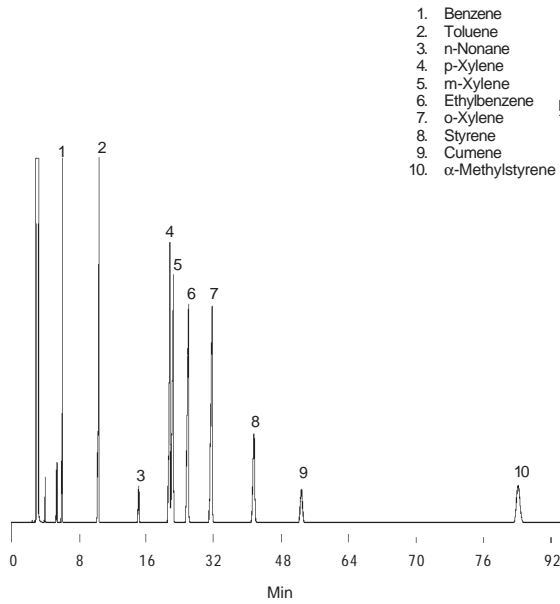

794-0652

BTEX Compounds, Gasoline Range Organics (GRO)

Column: β -DEX 120, 30m x 0.25mm ID, 0.25 μ m film
 Cat. No.: 2-4304
 Oven: 40°C to 180°C at 8°C/min
 Carrier: helium, 30cm/sec
 Det.: FID, 300°C
 Inj.: 1 μ L methanol (0.5mg/mL each analyte), direct injection, 250°C

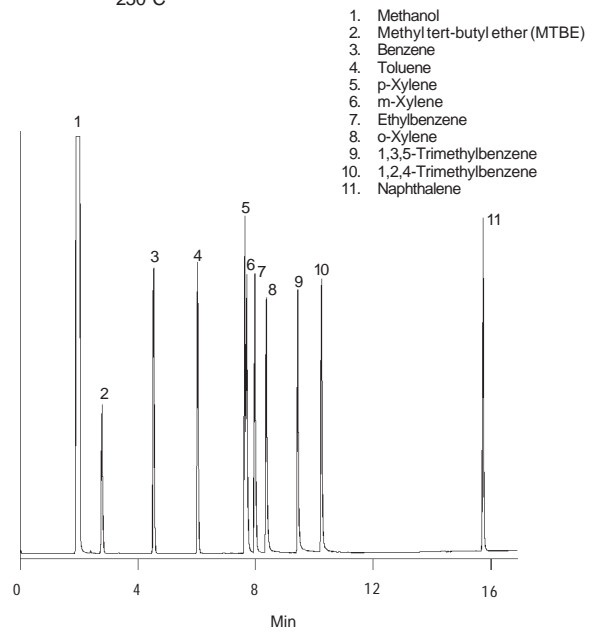

794-0580

BTEX Compounds

Column: β -DEX 120, 30m x 0.25mm ID, 0.25 μ m film
 Cat. No.: 2-4304
 Oven: 55°C (5 min) to 75°C at 2°C/min
 Carrier: helium, 20cm/sec
 Det.: FID, 300°C
 Inj.: 1 μ L methylene chloride (0.5mg/mL each analyte), split (100:1), 250°C

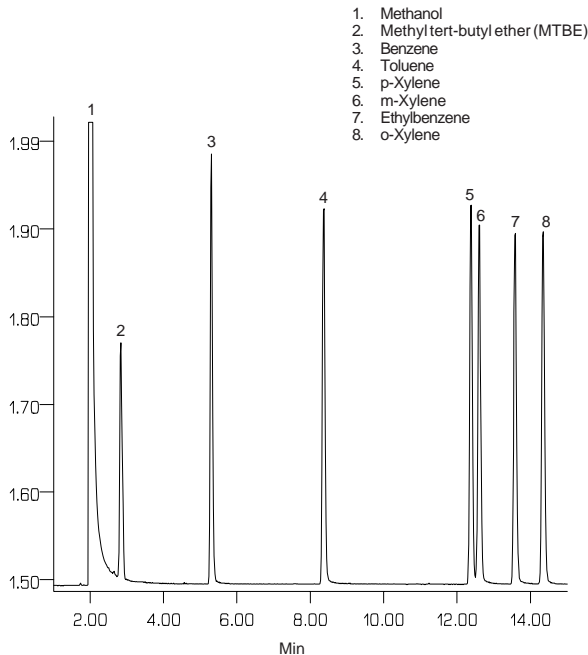

94-0338

Epoxides

Limonene Oxide

Column: α -DEX 120, 30m x 0.25mm ID, 0.25 μ m film
 Cat. No.: 2-4310
 Oven: 90°C
 Carrier: helium, 30cm/sec
 Det.: FID, 250°C
 Inj.: 1 μ L, split (100:1), 250°C

1,4. cis/trans-(+)-Limonene oxide
 2,3. cis/trans-(-)-Limonene oxide

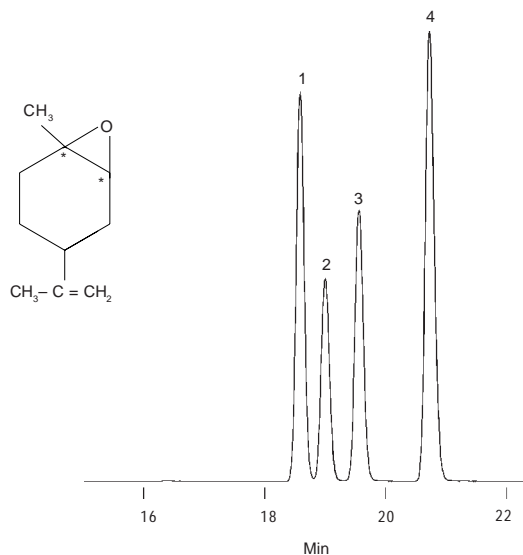

795-0802

Epoxides

Column: α -DEX 120, 30m x 0.25mm ID, 0.25 μ m film
 Cat. No.: 2-4310
 Oven: 110°C
 Carrier: helium, 20cm/sec
 Det.: FID, 300°C
 Inj.: 1 μ L methylene chloride (0.5mg/mL each analyte), split (100:1), 300°C

1. R-(+)-Styrene oxide
2. S-(-)-Styrene oxide
3. (\pm)-2,2-Dimethyl-3-phenyloxirane
4. (\pm)-trans-2-Methyl-3-phenyloxirane

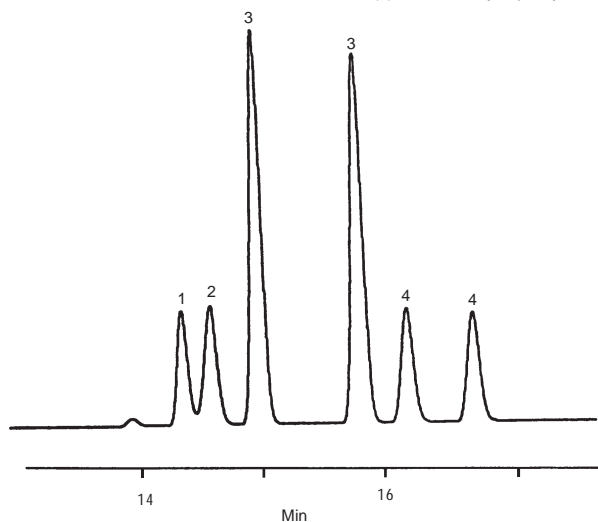

93-0404

Esters

Methyl and Ethyl Mandelate

Column: α -DEX 120, 30m x 0.25mm ID, 0.25 μ m film
 Cat. No.: 2-4310
 Oven: 130°C
 Carrier: helium, 30cm/sec
 Det.: FID, 300°C
 Inj.: 1 μ L methanol (0.5mg/mL each analyte), split (100:1), 300°C

1. S-(+)-Methyl mandelate
2. R-(-)-Methyl mandelate
3. S-(+)-Ethyl mandelate
4. R-(-)-Ethyl mandelate

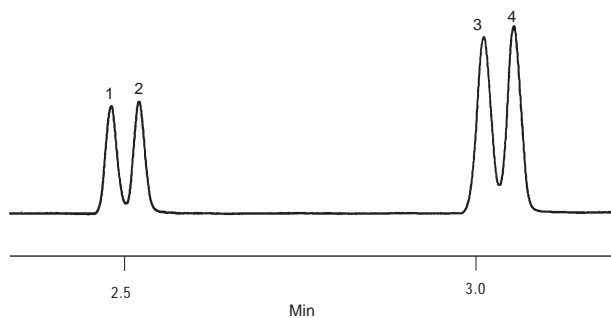

93-0405

Epoxides

Column: β -DEX 110, 30m x 0.25mm ID, 0.25 μ m film
 Cat. No.: 2-4301
 Oven: 110°C
 Carrier: helium, 20cm/sec
 Det.: FID, 300°C
 Inj.: 1 μ L methylene chloride (0.5mg/mL each analyte), split (100:1), 300°C

- I Impurity
1. cis-Methylstyrene oxide
 2. (\pm)-2,2-Dimethyl-3-phenyloxirane
 3. (\pm)-trans-2-Methyl-3-phenyloxirane

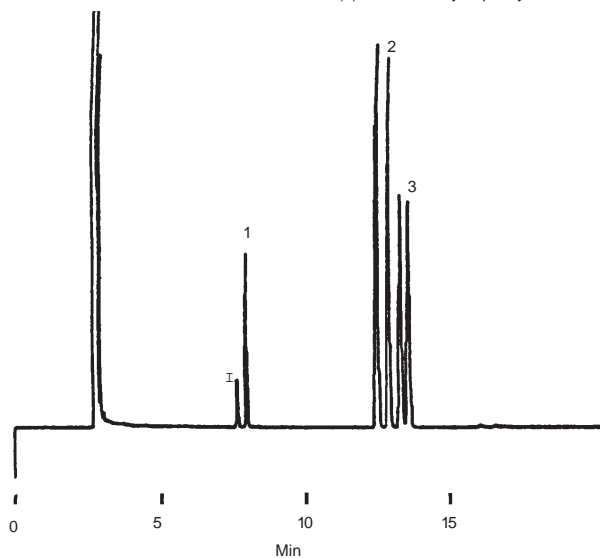

92-0343

Ethyl 2-Methylbutyrate

Column: β -DEX 110, 30m x 0.25mm ID, 0.25 μ m film
 Cat. No.: 2-4301
 Column: β -DEX 120, 30m x 0.25mm ID, 0.25 μ m film
 Cat. No.: 2-4304
 Oven: 40°C
 Carrier: helium, 20cm/sec
 Det.: FID, 200°C (β -DEX 110) or 300°C (β -DEX 120)
 Inj.: 1 μ L methylene chloride (0.5mg/mL each analyte), split (100:1), 100°C (β -DEX 110) or 250°C (β -DEX 120)

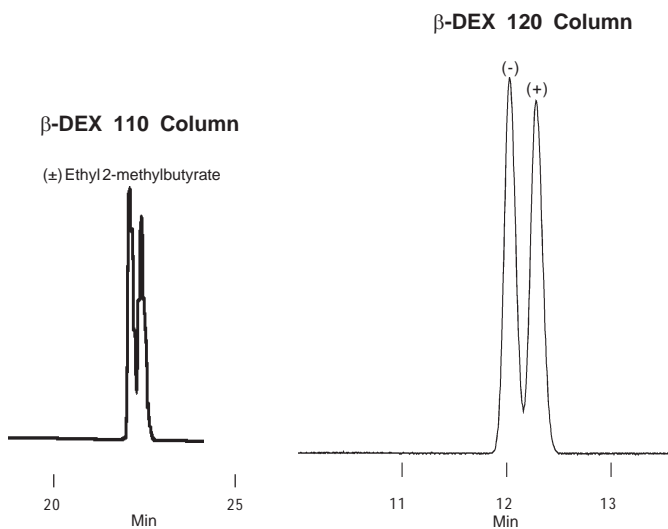

712-0268, 795-0804

Methyl 2-Chloropropionate and Methyl 2-Bromopropionate

Column: β -DEX 120, 30m x 0.25mm ID, 0.25 μ m film
 Cat. No.: 2-4304
 Oven: 70°C
 Carrier: helium, 20cm/sec
 Det.: FID, 300°C
 Inj.: 1 μ L methylene chloride (0.5mg/mL each analyte), split (100:1), 250°C

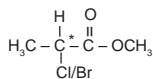

1. (\pm)-Methyl 2-chloropropionate
2. (\pm)-Methyl 2-bromopropionate

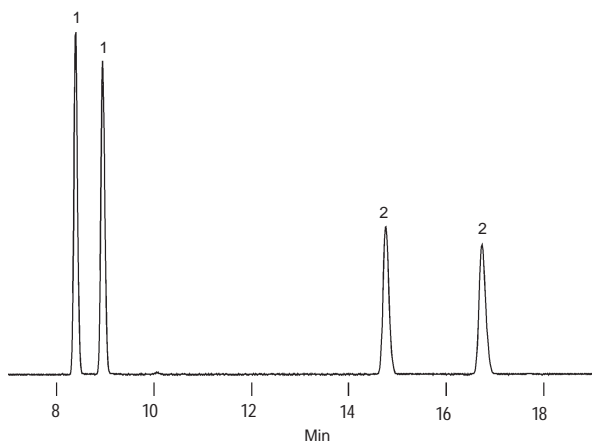

795-0803

Free Acids

4-Methyloctanoic Acid

Column: γ -DEX 120, 30m x 0.25mm ID x 0.25 μ m film
 Cat. No.: 2-4307
 Oven: 115°C
 Carrier: helium, 20cm/sec
 Det.: FID, 300°C
 Inj.: 1 μ L methylene chloride containing ~1mg/mL racemate, split 100:1, 220°C

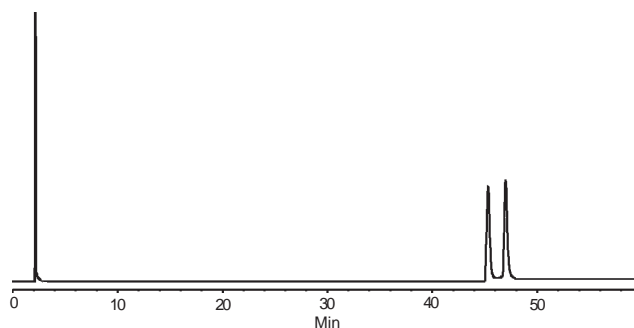

797-0225

Methyl Mandelate (Enantio-reversal)

Column: α -DEX 120 and γ -DEX 120, 30m x 0.25mm ID, 0.25 μ m film
 Cat. No.: 2-4310 (α -DEX 120), 2-4307 (γ -DEX 120)
 Oven: 130°C
 Carrier: helium, 35cm/sec
 Det.: FID, 300°C
 Inj.: 1 μ L methylene chloride (1mg/mL each analyte), split (100:1), 250°C

1. S-(+)-Methyl mandelate
2. R-(-)-Methyl mandelate

α -DEX 120 Column

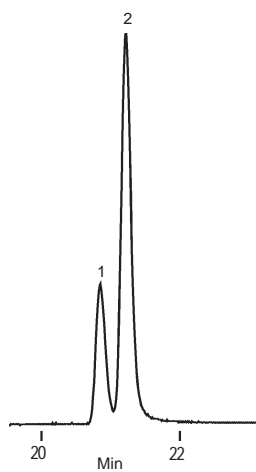

γ -DEX 120 Column

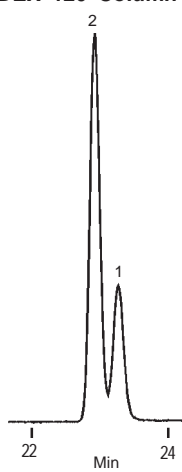

794-0282,0283

Ethers

Bis(2-chloroisopropyl)ether

Column: α -DEX 120, 30m x 0.25mm ID, 0.25 μ m film
 Cat. No.: 2-4310
 Oven: 70°C to 200°C at 2°C/min
 Carrier: helium, 20cm/sec
 Det.: MSD (scan: 18-500 amu)
 Inj.: 1 μ L methylene chloride (0.5mg/mL each analyte), 80°C

1. Bis(2-chloroisopropyl)ether Isomers
2. 1,1'-Oxybis(3-chloropropane) (impurity)

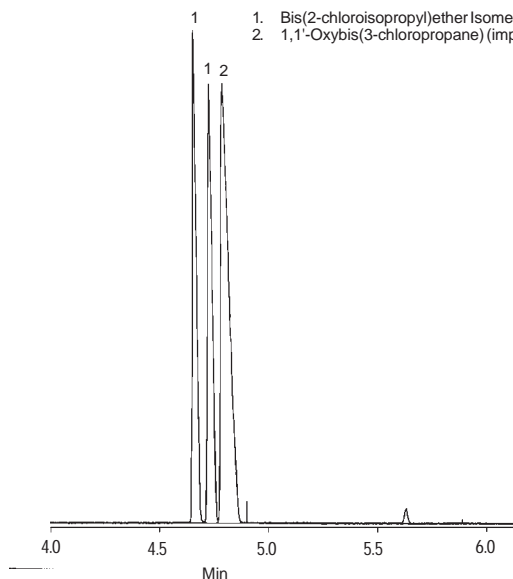

794-0188

Diethoxytetrahydrofuran

Column: α -DEX 120, 30m x 0.25mm ID, 0.25 μ m film
Cat. No.: 2-4310
Oven: 70°C/90°C/110°C
Carrier: helium, 20cm/sec
Det.: FID, 300°C
Inj.: 1 μ L methylene chloride (0.5mg/mL each analyte), split (100:1), 250°C

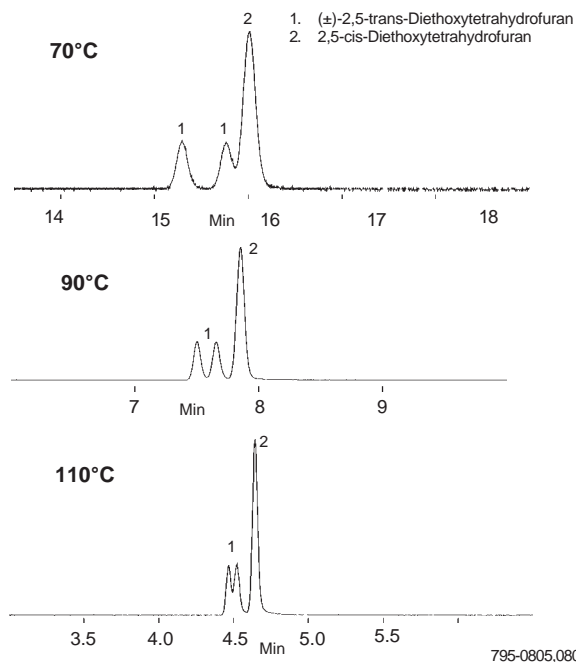

Dimethoxytetrahydrofuran

Column: β -DEX 120, 30m x 0.25mm ID, 0.25 μ m film
Cat. No.: 2-4304
Oven: 60°C
Carrier: helium, 30cm/sec
Det.: FID, 300°C
Inj.: 1 μ L methylene chloride (0.5mg/mL each analyte), split (100:1), 250°C

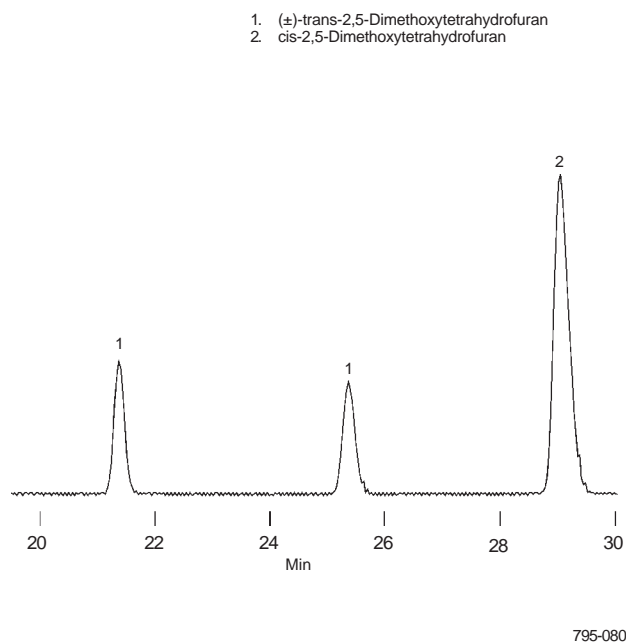

Dimethyltetrahydrofuran

Column: β -DEX 120, 30m x 0.25mm ID, 0.25 μ m film
Cat. No.: 2-4304
Oven: 60°C
Carrier: helium, 30cm/sec
Det.: FID, 300°C
Inj.: 1 μ L methylene chloride (0.5mg/mL each analyte), split (100:1), 250°C

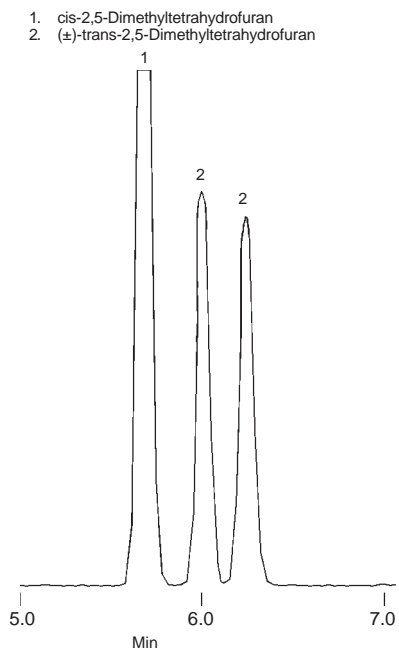

Halogenated Compounds

Isoflurane (Florane)

Column: β -DEX 110, 60m x 0.53mm ID, 0.5 μ m film
Cat. No.: 2-5411
Oven: 35°C
Carrier: helium, 20cm/sec
Det.: FID, 250°C
Inj.: 1 μ L methylene chloride (0.5mg/mL each analyte), split (100:1), 250°C

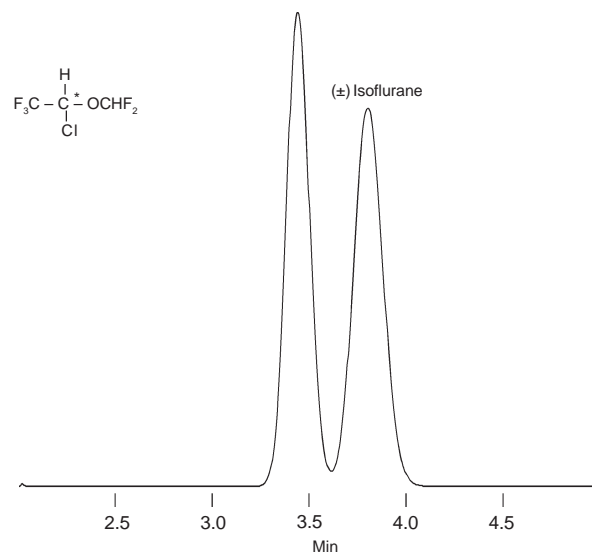

795-0810

Hydrocarbons

α -BHC and PCCH (Enantio-reversal)

Column: β -DEX 120 and γ -DEX 120, 30m x 0.25mm ID, 0.25 μ m film
 Cat. No.: 2-4304 (β -DEX 120), 2-4307 (γ -DEX 120)
 Oven: 160°C
 Carrier: helium, 30cm/sec
 Det.: FID, 300°C
 Inj.: 1 μ L methylene chloride (0.5mg/mL each analyte), split (100:1), 200°C

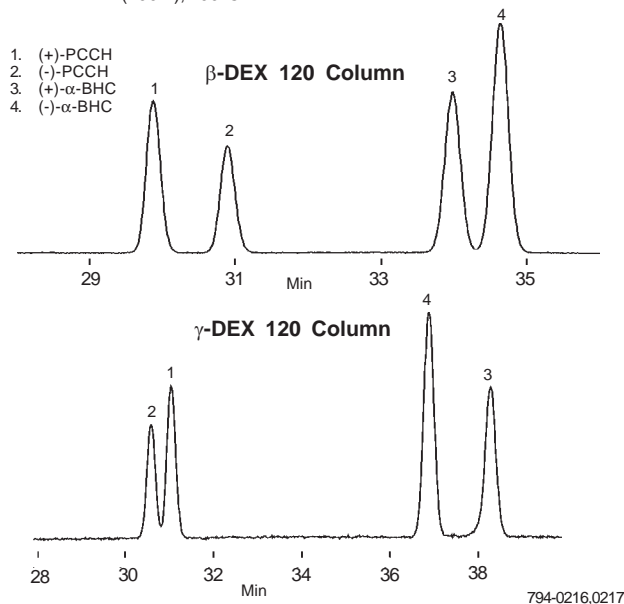

Ketones

Barbitals

Column: β -DEX 110, 30m x 0.25mm ID, 0.25 μ m film
 Cat. No.: 2-4301
 Oven: 210°C
 Carrier: helium, 20cm/sec
 Det.: FID, 300°C
 Inj.: 1 μ L methylene chloride (0.5mg/mL each analyte), split (100:1), 250°C

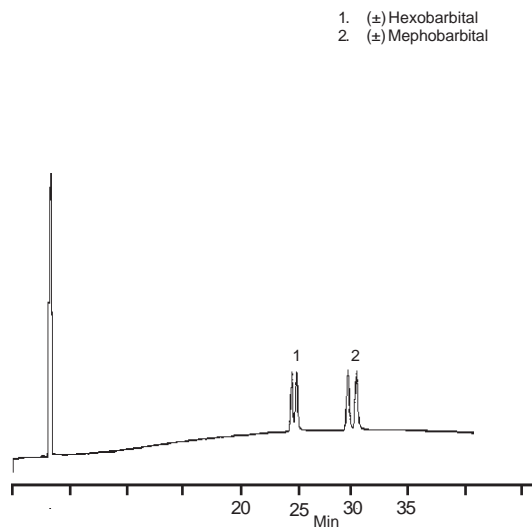

α -Pinene, Camphene, and Limonene

Column: β -DEX 120, 30m x 0.25mm ID, 0.25 μ m film
 Cat. No.: 2-4304
 Oven: 80°C
 Carrier: helium, 20cm/sec
 Det.: FID, 300°C
 Inj.: 1 μ L methylene chloride (0.5mg/mL each analyte), split (100:1), 150°C

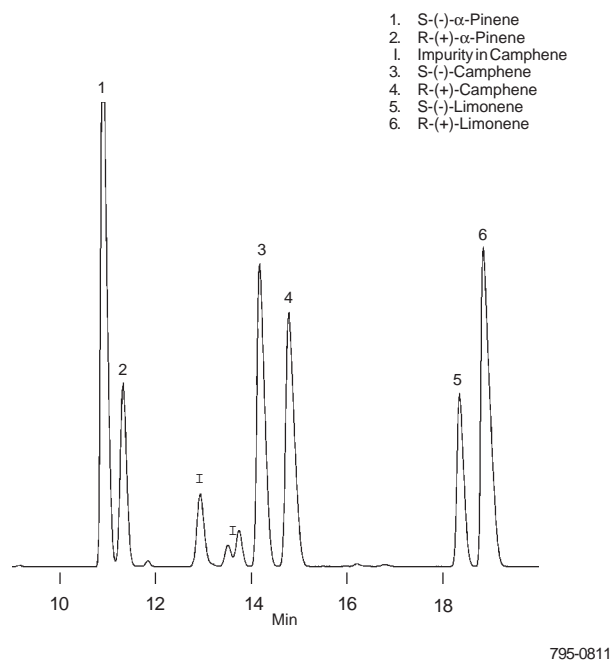

Barbitals

Column: β -DEX 120, 30m x 0.25mm ID, 0.25 μ m film
 Cat. No.: 2-4304
 Oven: 210°C
 Carrier: helium, 20cm/sec
 Det.: FID, 300°C
 Inj.: 1 μ L methylene chloride (5.0mg/mL each analyte), split (100:1), 300°C

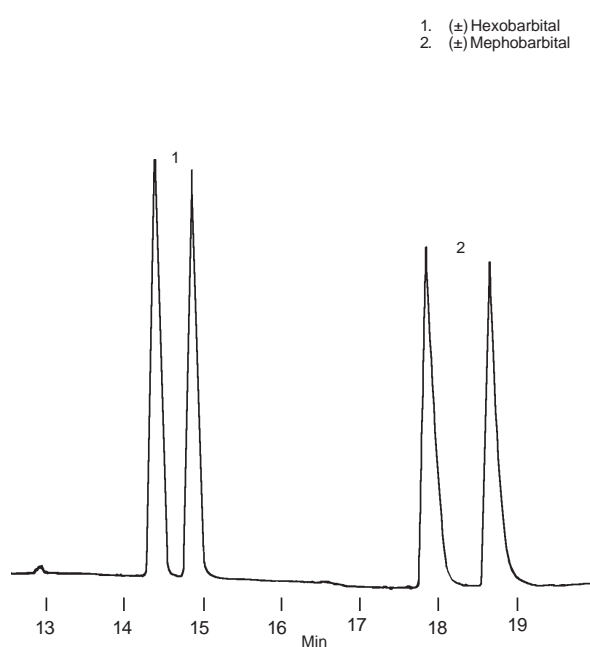

Carvone (Enantioreversal)

Sample: 0.3mg/mL S-(+)/0.2mg/mL R-(-) solution extracted by solid phase microextraction (100µm polydimethylsiloxane-coated SPME fiber, 30°C, 10 min)
 Column: α -DEX 120, β -DEX 120, and γ -DEX 120, 30m x 0.25mm ID, 0.25µm film
 Cat. No.: 2-4310 (α -DEX 120), 2-4304 (β -DEX 120), 2-4307 (γ -DEX 120)
 Oven: 90°C
 Carrier: helium, 35cm/sec
 Det.: FID, 300°C
 Inj.: split (100:1), 250°C

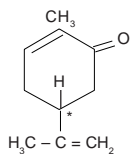

1. S-(+)-Carvone
2. R-(-)-Carvone

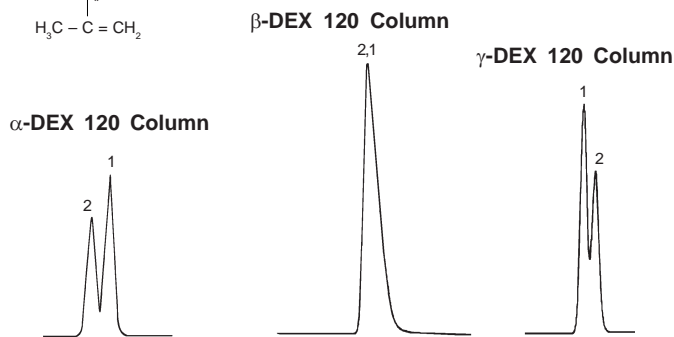

93-0540

Phenols

Dimethylphenol Positional Isomers

Column: β -DEX 110, 30m x 0.25mm ID, 0.25µm film
 Cat. No.: 2-4301
 Oven: 140°C
 Carrier: helium, 20cm/sec
 Det.: FID, 300°C
 Inj.: 1µL methylene chloride (0.5mg/mL each analyte), split (100:1), 220°C

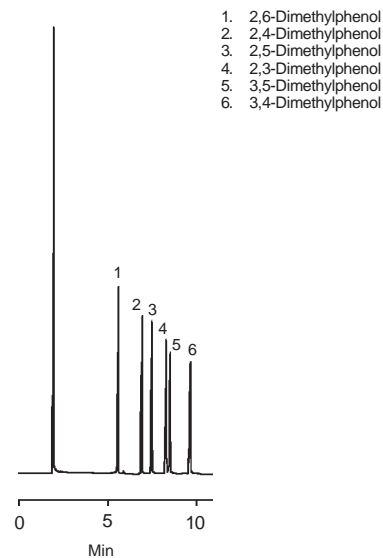

1. 2,6-Dimethylphenol
2. 2,4-Dimethylphenol
3. 2,5-Dimethylphenol
4. 2,3-Dimethylphenol
5. 3,5-Dimethylphenol
6. 3,4-Dimethylphenol

712-0276

Lactones

Alkylated γ -Lactones

Column: β -DEX 110, 30m x 0.25mm ID, 0.25µm film
 Cat. No.: 2-4301
 Oven: 90°C to 200°C at 1°C/min
 Carrier: helium, 20cm/sec
 Det.: FID, 300°C
 Inj.: 1µL methylene chloride (0.5mg/mL each analyte), split (100:1), 300°C

1. (\pm)-Methyl- γ -lactone
2. (\pm)-Ethyl- γ -lactone
3. (\pm)-Propyl- γ -lactone
4. (\pm)-Butyl- γ -lactone

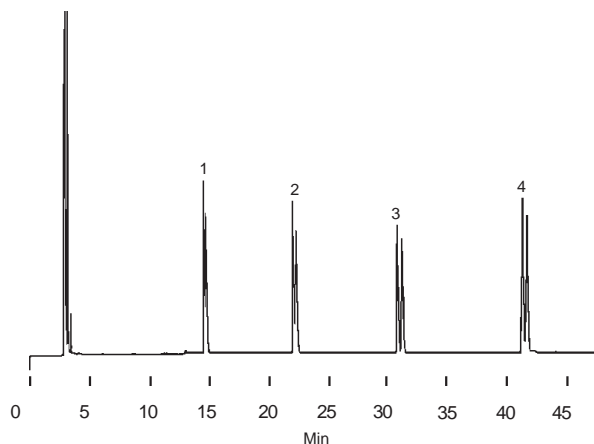

712-0266

Phenols

Column: α -DEX 120, 30m x 0.25mm ID, 0.25µm film
 Cat. No.: 2-4310
 Oven: 130°C (12 min) to 220°C at 10°C/min, hold 5 min
 Carrier: hydrogen, 40cm/sec
 Det.: FID, 300°C
 Inj.: 1µL, split (100:1), 250°C

1. Phenol
2. 2-Methylphenol (o-Cresol)
3. 2,6-Dimethylphenol
4. 4-Methylphenol (p-Cresol)
5. 3-Methylphenol (m-Cresol)
6. 2-Ethylphenol
7. 2,4-Dimethylphenol
8. 2,5-Dimethylphenol
9. 2,4,6-Trimethylphenol
10. 4-Ethylphenol
11. 2,3-Dimethylphenol
12. 2,3,5-Trimethylphenol
13. 3-Ethylphenol
14. 3,4-Dimethylphenol
15. 3,5-Dimethylphenol

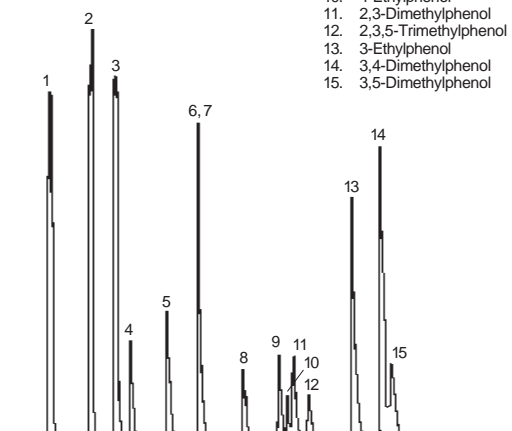

Figure provided by J. Novocik, DEZA Corporation, Czech Republic.

795-0853

Toxicity Characteristics Leaching Procedure (TCLP) Acids

Column: α -DEX 120, 30m x 0.25mm ID, 0.25 μ m film
 Cat. No.: 2-4310
 Oven: 130°C to 220°C at 3°C/min
 Carrier: helium, 20cm/sec
 Det.: FID, 300°C
 Inj.: 1 μ L methylene chloride (0.5mg/mL each analyte), split (100:1), 300°C

1. 2-Methylphenol (o-Cresol)
2. 4-Methylphenol (p-Cresol)
3. 3-Methylphenol (m-Cresol)
4. 2,4,6-Trichlorophenol
5. 2,4,5-Trichlorophenol
6. Pentachlorophenol

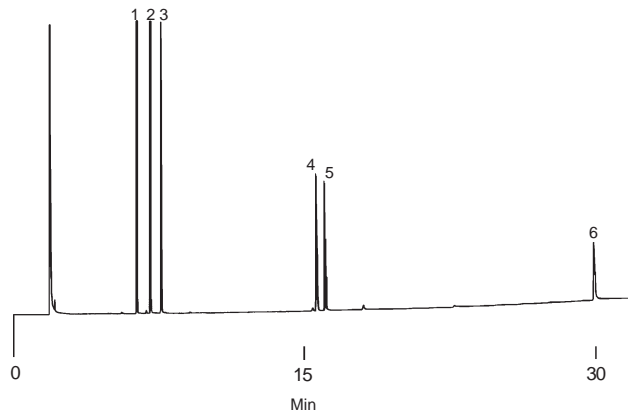

92-0328

Methylphenols (Cresols)

Column: α -DEX 120, 30m x 0.25mm ID, 0.25 μ m film
 Cat. No.: 2-4310
 Oven: 160°C
 Carrier: helium, 20cm/sec
 Det.: FID, 300°C
 Inj.: 1 μ L methylene chloride (0.5mg/mL each analyte), split (100:1), 250°C

1. Phenol
2. 2-Methylphenol (o-Cresol)
3. 4-Methylphenol (p-Cresol)
4. 3-Methylphenol (m-Cresol)

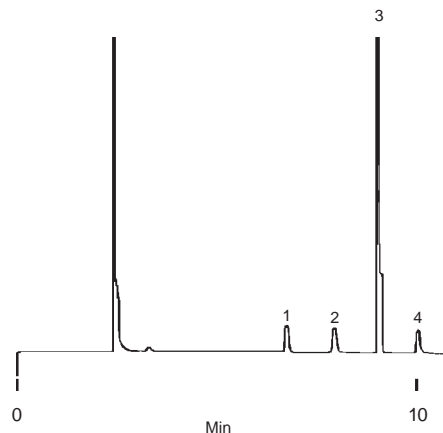

713-0082

Phenols

Column: α -DEX 120, 30m x 0.25mm ID, 0.25 μ m film
 Cat. No.: 2-4310
 Oven: 130°C to 220°C at 3°C/min
 Carrier: helium, 20cm/sec
 Det.: FID, 300°C
 Inj.: 1 μ L methanol (0.5mg/mL each analyte), split (100:1), 300°C

1. 2-Chlorophenol
2. Phenol
3. 2-Methylphenol (o-Cresol)
4. 4-Methylphenol (p-Cresol)
5. 3-Methylphenol (m-Cresol)
6. 2,4-Dimethylphenol
7. 2,4-Dichlorophenol
8. 2,6-Dichlorophenol
9. 4-Chloro-3-methylphenol
10. 2,3,5-Trichlorophenol
11. 2,4,6-Trichlorophenol
12. 2,3,4-Trichlorophenol
13. 2,4,5-Trichlorophenol
14. 4-Nitrophenol
15. 2,3,5,6-Tetrachlorophenol
16. 2,3,4,6-Tetrachlorophenol
17. 2,3,4,5-Tetrachlorophenol
18. 4,6-Dinitro-2-methylphenol
19. 2,4-Dinitrophenol
20. Pentachlorophenol

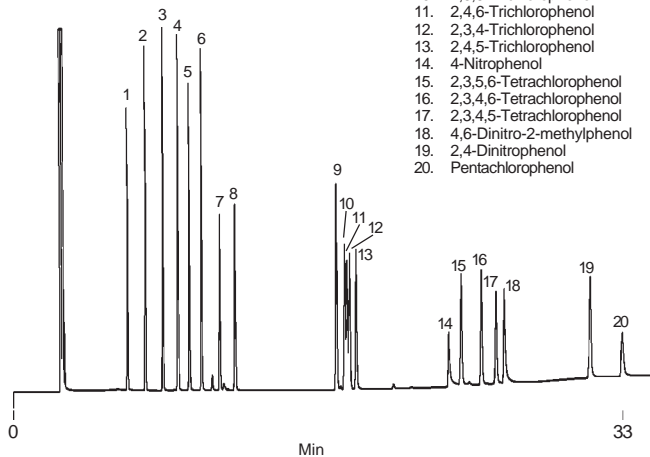

713-0083

Silicon Compounds

Silicon Compounds

Column: β -DEX 110, 30m x 0.25mm ID, 0.25 μ m film
 Cat. No.: 2-4301
 Oven: 100°C to 220°C at 2°C/min
 Carrier: helium, 20cm/sec
 Det.: FID, 300°C
 Inj.: 1 μ L methylene chloride (0.5mg/mL each analyte), split (100:1), 250°C

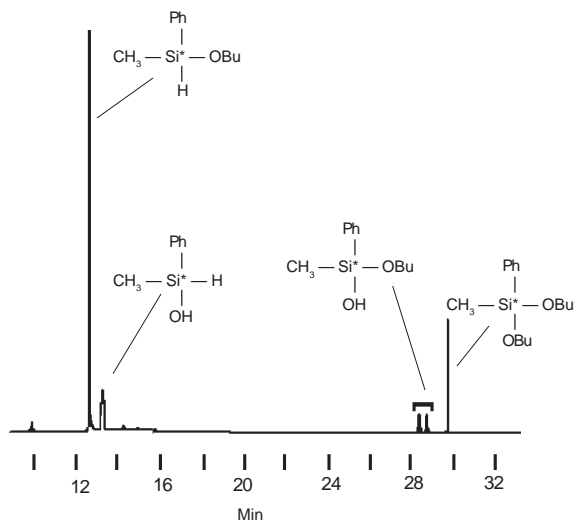

712-0277

Solvents

Solvents

Column: α -DEX 120, 30m x 0.25mm ID, 0.25 μ m film
 Cat. No.: 2-4310
 Oven: 40°C (2 min) to 180°C at 5°C/min, hold 10 min
 Carrier: hydrogen, 30cm/sec
 Det.: FID, 200°C
 Inj.: 1 μ L methylene chloride:methanol, 95:5 (1 μ L/mL each analyte, 0.25 μ L/mL int. std.), 200°C

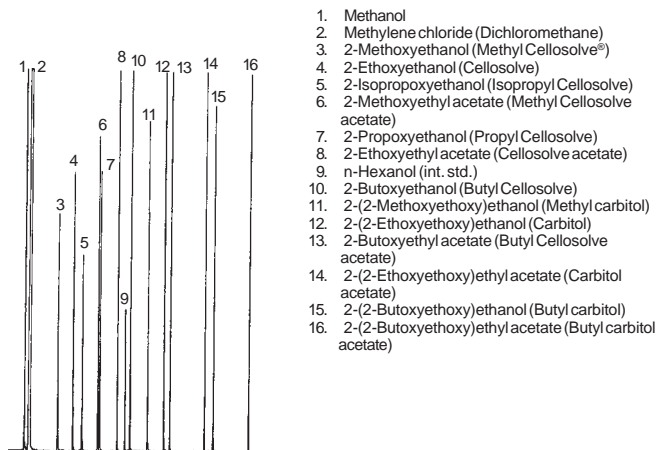

1. Methanol
2. Methylene chloride (Dichloromethane)
3. 2-Methoxyethanol (Methyl Cellosolve[®])
4. 2-Ethoxyethanol (Cellosolve)
5. 2-Isopropoxyethanol (Isopropyl Cellosolve)
6. 2-Methoxyethyl acetate (Methyl Cellosolve acetate)
7. 2-Propoxyethanol (Propyl Cellosolve)
8. 2-Ethoxyethyl acetate (Cellosolve acetate)
9. n-Hexanol (int. std.)
10. 2-Butoxyethanol (Butyl Cellosolve)
11. 2-(2-Methoxyethoxy)ethanol (Methyl carbitol)
12. 2-(2-Ethoxyethoxy)ethanol (Carbitol)
13. 2-Butoxyethyl acetate (Butyl Cellosolve acetate)
14. 2-(2-Ethoxyethoxy)ethyl acetate (Carbitol acetate)
15. 2-(2-Butoxyethoxy)ethanol (Butyl carbitol)
16. 2-(2-Butoxyethoxy)ethyl acetate (Butyl carbitol acetate)

Figure provided by Mr. M.L. Shulsky, Occupational Safety and Health Administration.

713-0224

Solvents

Column: α -DEX 120, 30m x 0.25mm ID, 0.25 μ m film
 Cat. No.: 2-4310
 Oven: 40°C (2 min) to 180°C at 5°C/min, hold 10 min
 Carrier: hydrogen, 30cm/sec
 Det.: FID, 200°C
 Inj.: 1 μ L methylene chloride:methanol, 95:5 (1 μ L/mL each analyte, 0.25 μ L/mL int. std.), 200°C

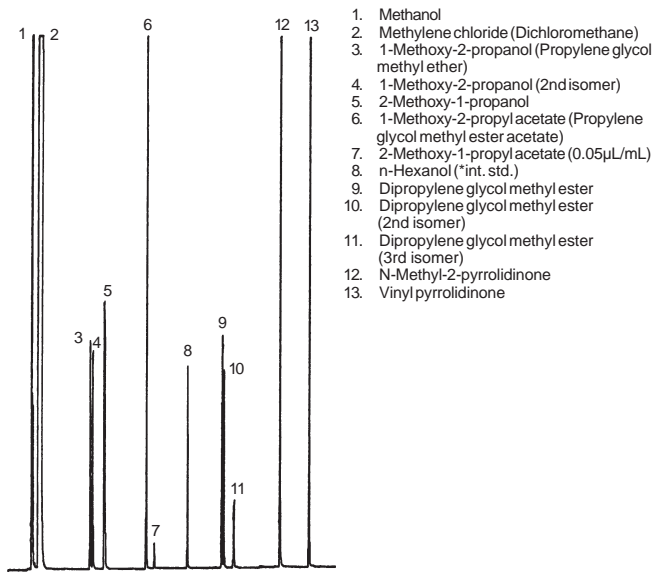

1. Methanol
2. Methylene chloride (Dichloromethane)
3. 1-Methoxy-2-propanol (Propylene glycol methyl ether)
4. 1-Methoxy-2-propanol (2nd isomer)
5. 2-Methoxy-1-propanol
6. 1-Methoxy-2-propyl acetate (Propylene glycol methyl ester acetate)
7. 2-Methoxy-1-propyl acetate (0.05 μ L/mL)
8. n-Hexanol (*int. std.)
9. Dipropylene glycol methyl ester
10. Dipropylene glycol methyl ester (2nd isomer)
11. Dipropylene glycol methyl ester (3rd isomer)
12. N-Methyl-2-pyrrolidinone
13. Vinyl pyrrolidinone

Figure provided by Mr. M.L. Shulsky, Occupational Safety and Health Administration.

713-0225

SPME/Chiral Capillary GC

Juniper Leaves

Sample: 0.5g sliced juniper leaves in 7mL vial
 SPME Fiber: 100 μ m polydimethylsiloxane
 Cat. No.: 57300-U (manual sampling)
 Extraction: headspace, 40°C, 20 min
 Desorption: 1 min, 250°C
 Column: β -DEX 120, 30m x 0.25mm ID, 0.25 μ m film
 Cat. No.: 2-4304
 Oven: 40°C (2 min) to 220°C at 4°C/min
 Carrier: helium, 35cm/sec
 Det.: FID, 300°C
 Inj.: split (100:1), 250°C

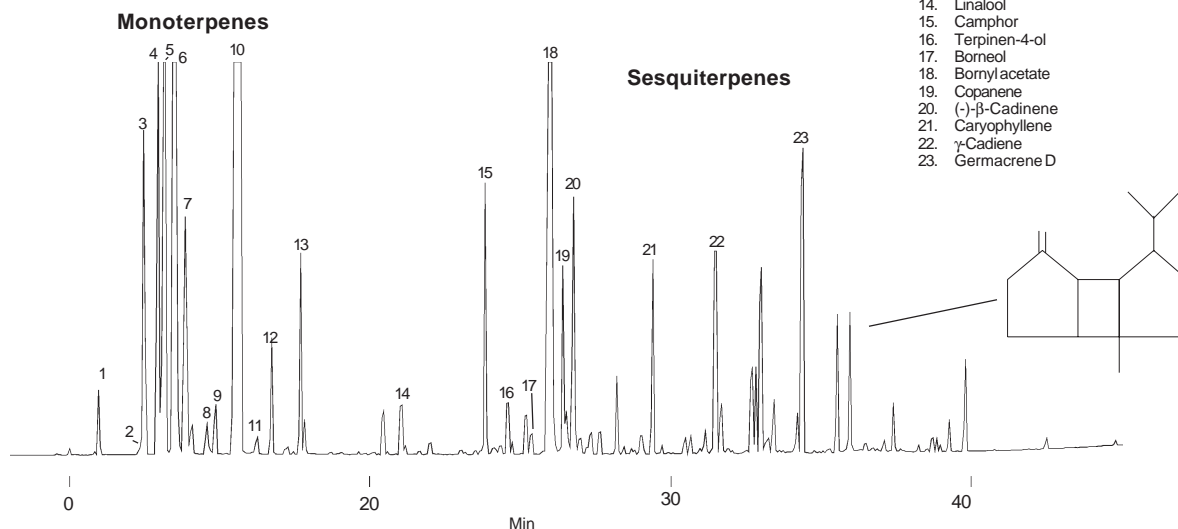

1. α -Thujene
2. (-)- α -Pinene
3. (+)- α -Pinene
4. Tricyclene
5. β -Myrcene
6. Sabinene
7. (+)-Camphene
8. (-)-Camphene
9. α -Terpinene
10. (+)-Limonene
11. β -Phellandrene
12. γ -Terpinene
13. Terpinolene
14. Linalool
15. Camphor
16. Terpinen-4-ol
17. Borneol
18. Bornyl acetate
19. Copanene
20. (-)- β -Cadinene
21. Caryophyllene
22. γ -Cadiene
23. Germacrene D

795-0812

White Pine Leaves

Sample: 0.5g pine leaves in 7mL vial
 SPME Fiber: **100µm polydimethylsiloxane**
 Cat. No.: **57300-U** (manual sampling)
 Extraction: headspace, 40°C, 20 min
 Desorption: 1 min, 250°C
 Column: **β-DEX 120, 30m x 0.25mm ID, 0.25µm film**
 Cat. No.: **2-4304**
 Oven: 40°C (2 min) to 220°C at 4°C/min
 Carrier: helium, 35cm/sec
 Det.: FID, 300°C
 Inj.: split (100:1), 250°C

1. (-)-α-Pinene
2. (+)-α-Pinene
3. β-Myrcene
4. (+)-Sabinene
5. (+)-Camphene
6. (-)-Camphene
7. (+)-β-Pinene
8. 3-Carene
9. (-)-Limonene
10. (+)-Limonene
11. (±)-β-Phellandrene
12. Terpinolene
13. Caryophyllene
14. α-Caryophyllene
15. γ-Cadinene

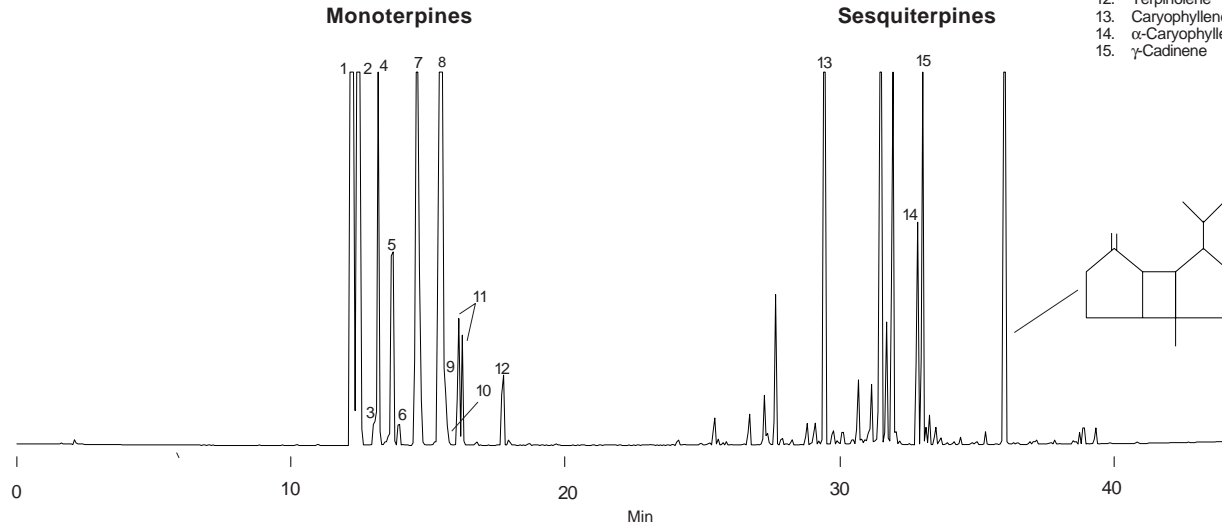

94-0298

Lemon Oil

Sample: 0.5g lemon oil in 7mL vial
 SPME Fiber: **100µm polydimethylsiloxane**
 Cat. No.: **57300-U** (manual sampling)
 Extraction: headspace, 30°C, 30 sec
 Desorption: 1 min, 250°C
 Column: **β-DEX 120, 30m x 0.25mm ID, 0.25µm film**
 Cat. No.: **2-4304**
 Oven: 40°C (2 min) to 220°C at 4°C/min, hold 5 min
 Carrier: helium, 20cm/sec
 Det.: FID, 300°C
 Inj.: split (100:1), 250°C

1. α-Thujene
2. (-)-α-Pinene
3. (+)-α-Pinene
4. β-Myrcene
5. Sabinene
6. (+)-Camphene
7. (-)-Camphene
8. β-Pinene
9. α-Terpinene
10. (-)-Limonene
11. β-Phellandrene
12. γ-Terpinene
13. 3-Octanol
14. Terpinolene
15. Citronellal
16. Linalool
17. Linalyl acetate
18. Menthone
19. (+)-Terpinen-4-ol
20. (-)-Terpinen-4-ol
21. Geranial
22. (±)-α-Terpineol
23. Neral
24. Geranyl acetate
25. Bergamptene
26. Neryl acetate
27. Caryophyllene
28. β-Bisabolene

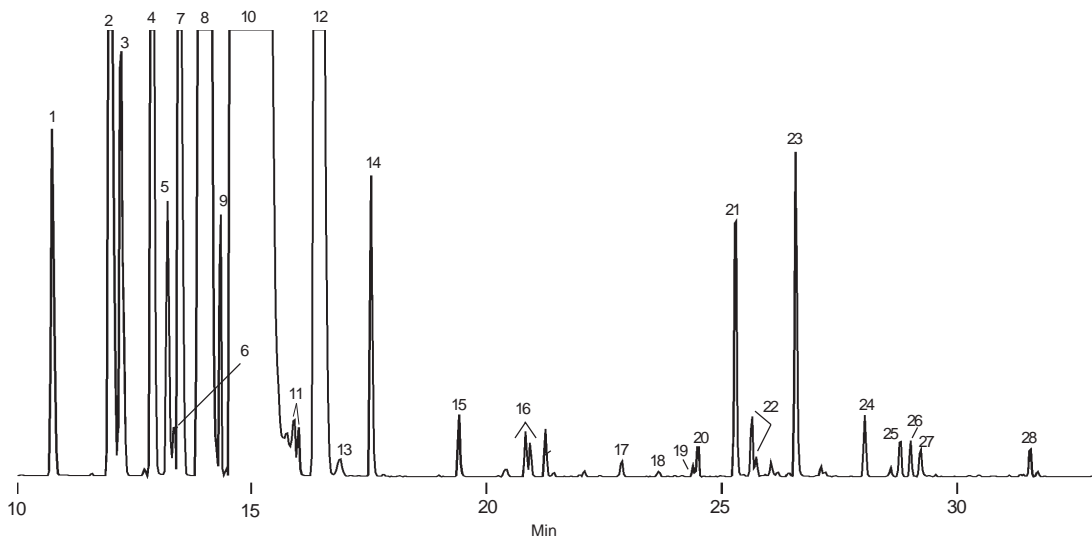

795-0814

Ginger Oil

Sample: 0.5g ginger oil in 7mL vial
 SPME Fiber: **100µm polydimethylsiloxane**
 Cat. No.: **57300-U** (manual sampling)
 Extraction: headspace, 30°C, 30 sec
 Desorption: 1 min, 250°C
 Column: **β-DEX 120, 30m x 0.25mm ID, 0.25µm film**
 Cat. No.: **2-4304**
 Oven: 40°C (2 min) to 220°C at 4°C/min, hold 5 min
 Carrier: helium, 20cm/sec
 Det.: FID, 300°C
 Inj.: split (100:1), 250°C

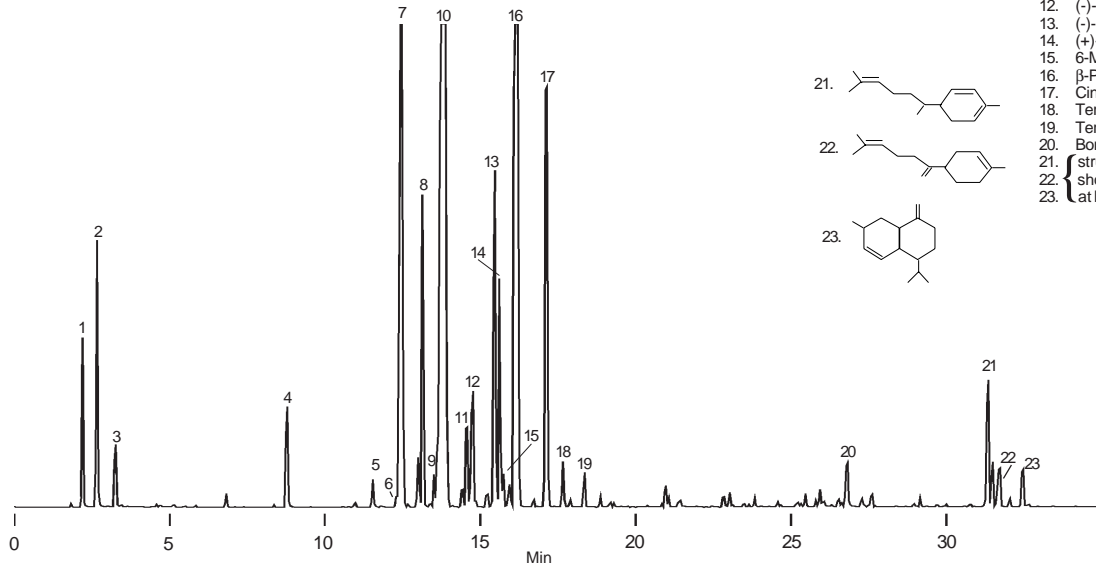

1. Acetone
2. Isopropyl alcohol
3. Ethylacetate
4. Hexanal
5. (-)-α-Pinene
6. (+)-α-Pinene
7. Tricyclene
8. β-Myrcene
9. (+)-Camphene
10. (-)-Camphene
11. (+)-β-Pinene
12. (-)-β-Pinene
13. (-)-Limonene
14. (+)-Limonene
15. 6-Methyl-5-hepten-2-one
16. β-Phellandrene
17. Cineole
18. Terpinene
19. Terpinolene
20. Borneol
21. structures shown at left
22. structures shown at left
23. structures shown at left

795-0815

Perfume

Sample: 1g perfume in 7mL vial
 SPME Fiber: **100µm polydimethylsiloxane**
 Cat. No.: **57300-U** (manual sampling)
 Extraction: headspace, 30°C, 1 min
 Desorption: 1 min, 250°C
 Column: **β-DEX 120, 30m x 0.25mm ID, 0.25µm film**
 Cat. No.: **2-4304**
 Oven: 40°C (2 min) to 220°C at 4°C/min, hold 5 min
 Carrier: helium, 20cm/sec
 Det.: FID, 300°C
 Inj.: split (100:1), 250°C

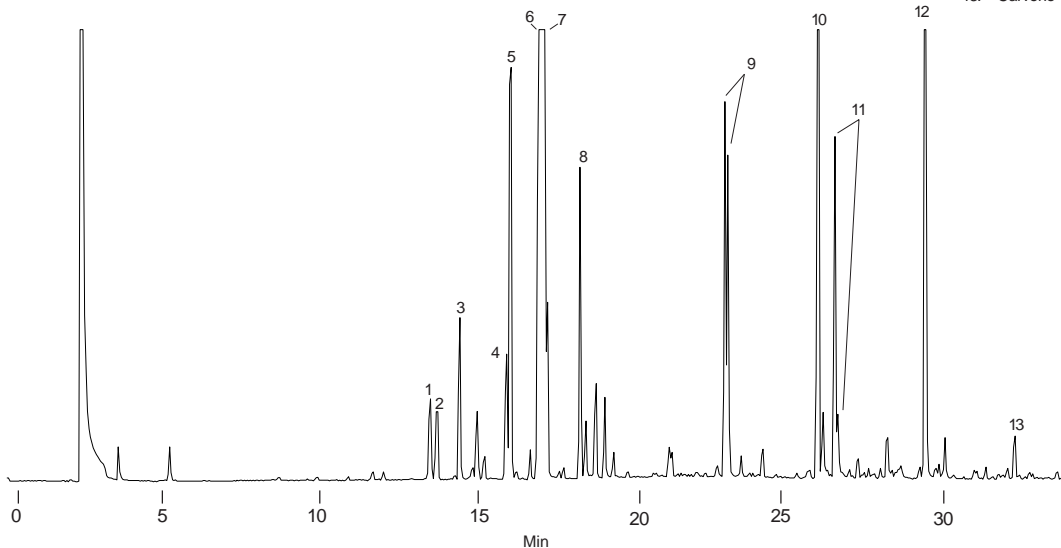

1. (-)-α-Pinene
2. (+)-α-Pinene
3. β-Myrcene
4. (+)-β-Pinene
5. (-)-β-Pinene
6. (-)-Limonene
7. (+)-Limonene
8. γ-Terpinene
9. (±)-Linalool
10. (±)-Linalyl acetate
11. unknown chiral component
12. unknown
13. Carvone

94-0297

Spearmint Oil and Spearmint Gum

Sample: 0.5g spearmint oil or gum in 7mL vial
 SPME Fiber: **100µm polydimethylsiloxane**
 Cat. No.: **57300-U** (manual sampling)
 Extraction: headspace, 30°C, 3 min
 Desorption: 1 min, 250°C
 Column: **β-DEX 120, 30m x 0.25mm ID, 0.25µm film**
 Cat. No.: **2-4304**
 Oven: 40°C (2 min) to 220°C at 4°C/min
 Carrier: helium, 35cm/sec
 Det.: FID, 300°C
 Inj.: split (100:1), 250°C

1. (-)-α-Pinene
2. (+)-α-Pinene
3. β-Myrcene
4. Sabinene
5. (-)-Camphene
6. (+)-β-Pinene
7. (-)-β-Pinene
8. α-Terpinene
9. 3-Carene
10. (-)-Limonene
11. (+)-Limonene
12. γ-Terpinene
13. Cineole
14. Menthone
15. Menthol
16. (±)-Terpinen-4-ol
17. Dihydrocarvone
18. (-)-Carvone

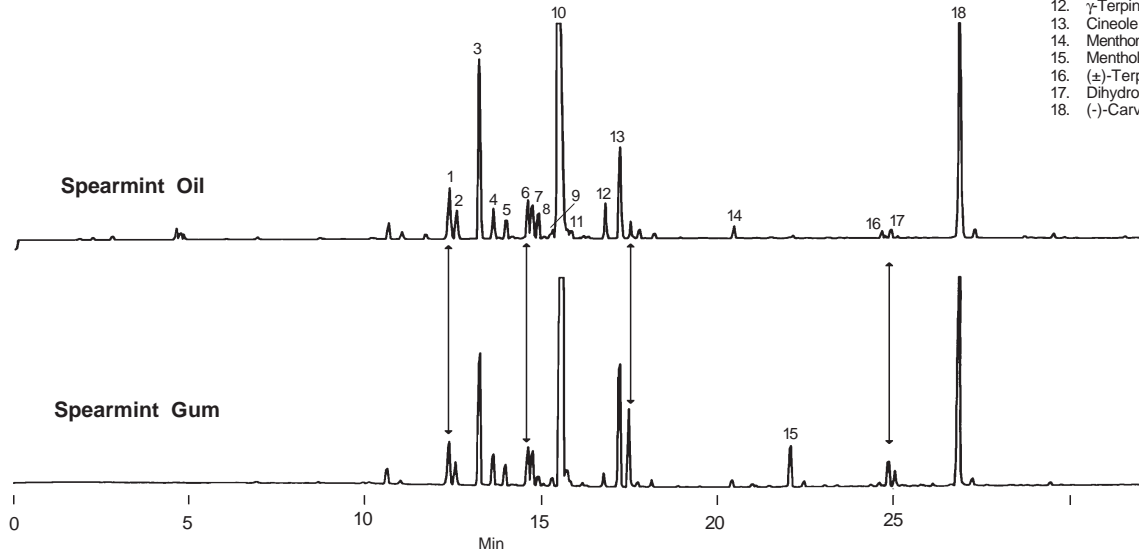

94-0281

Peppermint Oil and Peppermint Candy

Sample: 0.5g peppermint oil or crushed candy in 7mL vial
 SPME Fiber: **100µm polydimethylsiloxane**
 Cat. No.: **57300-U** (manual sampling)
 Extraction: headspace, 30°C, 3 min
 Desorption: 1 min, 250°C
 Column: **β-DEX 120, 30m x 0.25mm ID, 0.25µm film**
 Cat. No.: **2-4304**
 Oven: 40°C (2 min) to 220°C at 4°C/min
 Carrier: helium, 35cm/sec
 Det.: FID, 300°C
 Inj.: split (100:1), 250°C

1. (-)-α-Pinene
2. (+)-α-Pinene
3. β-Myrcene
4. Sabinene
5. (-)-Camphene
6. (+)-β-Pinene
7. (-)-β-Pinene
8. α-Terpinene
9. 3-Carene
10. (-)-Limonene
11. (+)-Limonene
12. (±)-β-Phellandrene
13. γ-Terpinene
14. Cineole
15. Menthone
16. (+)-Menthol
17. (-)-Menthol
18. (±)-Menthyl acetate

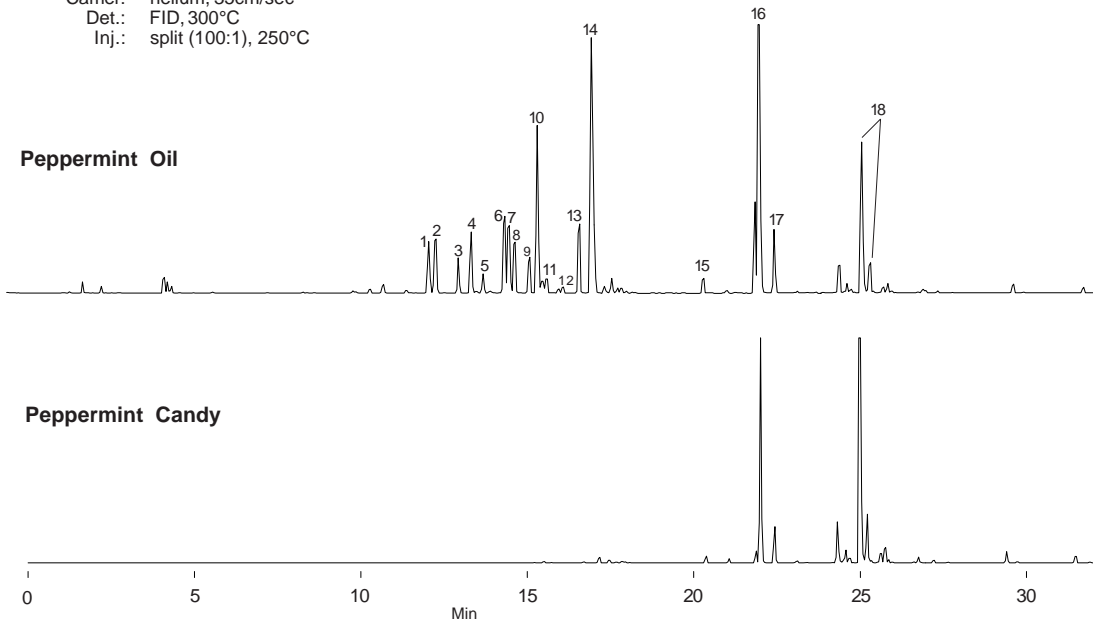

94-0278,0279

Lavender Oil

Sample: 0.5g lavender oil in 7mL vial
 SPME Fiber: **100µm polydimethylsiloxane**
 Cat. No.: **57300-U** (manual sampling)
 Extraction: headspace, 30°C, 30 sec
 Desorption: 1 min, 250°C
 Column: **β-DEX 120, 30m x 0.25mm ID, 0.25µm film**
 Cat. No.: **2-4304**
 Oven: 40°C (2 min) to 220°C at 4°C/min, hold 5 min
 Carrier: helium, 20cm/sec
 Det.: FID, 300°C
 Inj.: split (100:1), 250°C

1. α-Thujene
2. (-)-α-Pinene
3. (+)-α-Pinene
4. β-Myrcene
5. (+)-Camphene
6. (-)-Camphene
7. (+)-β-Pinene
8. (-)-β-Pinene
9. cis-β-Ocimene
10. p-Cumene
11. (±)-Cineole
12. (±)-α-Terpinolene
13. (±)-Linalool
14. (±)-Linalyl acetate
15. Camphor
16. (+)-Terpinen-4-ol
17. (-)-Terpinen-4-ol
18. (±)-Borneol

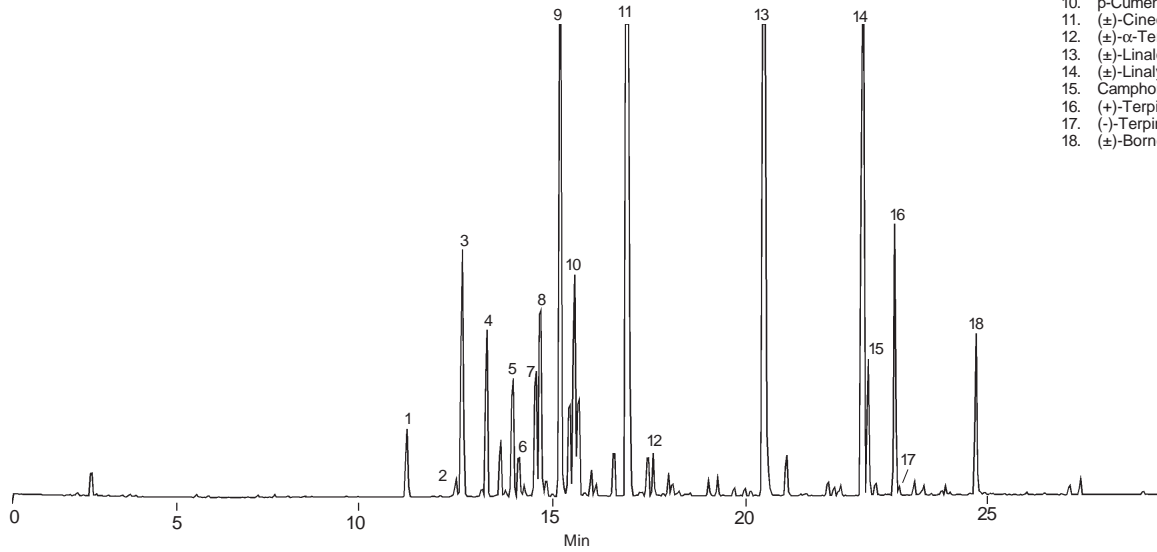

795-0813

Mushroom Extract

Sample: 5g fresh mushroom extract or 5g fresh mushroom extract plus 2µL of 2ppm solution of (±)-1-octen-3-ol in 7mL vial
 SPME Fiber: **100µm polydimethylsiloxane**
 Cat. No.: **57300-U** (manual sampling)
 Extraction: headspace, 40°C, 5 min
 Desorption: 1 min, 250°C
 Column: **α-DEX 120, 30m x 0.25mm ID, 0.25µm film**
 Cat. No.: **2-4310**
 Oven: 80°C
 Carrier: helium, 30cm/sec
 Det.: FID, 300°C
 Inj.: split (100:1), 250°C

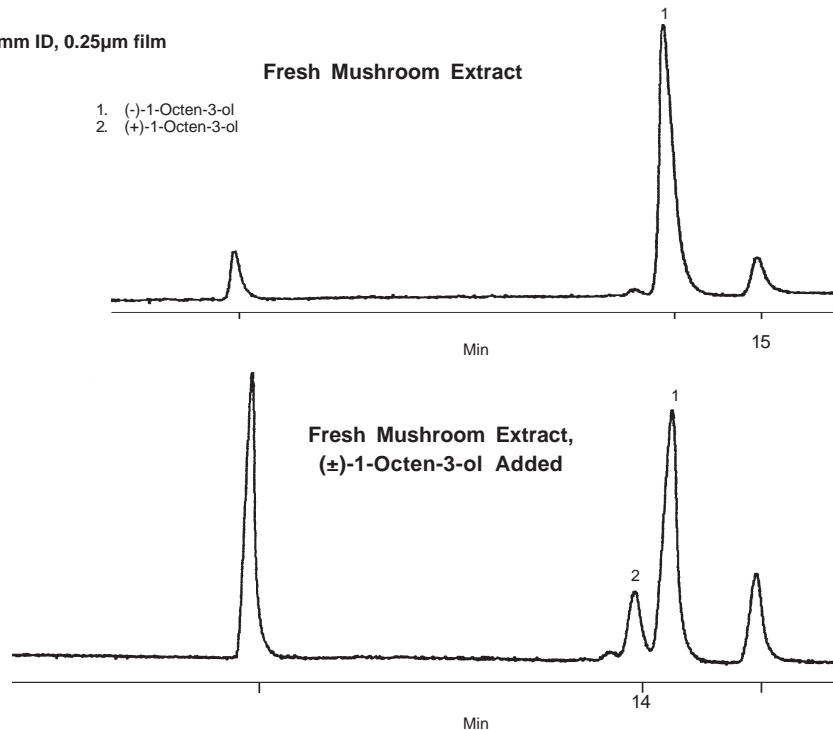

93-0397,0400

Dill Seed

Sample: 1g dill seed or 1g dill seed plus 1µL carvone isomer in 7mL vial
 SPME Fiber: **100µm polydimethylsiloxane**
 Cat. No.: **57300-U** (manual sampling)
 Extraction: headspace, 30°C, 5 min
 Desorption: 1 min, 250°C
 Column: **α-DEX 120, 30m x 0.25mm ID, 0.25µm film**
 Cat. No.: **2-4310**
 Oven: 80°C
 Carrier: helium, 30cm/sec
 Det.: FID, 300°C
 Inj.: split (100:1), 250°C

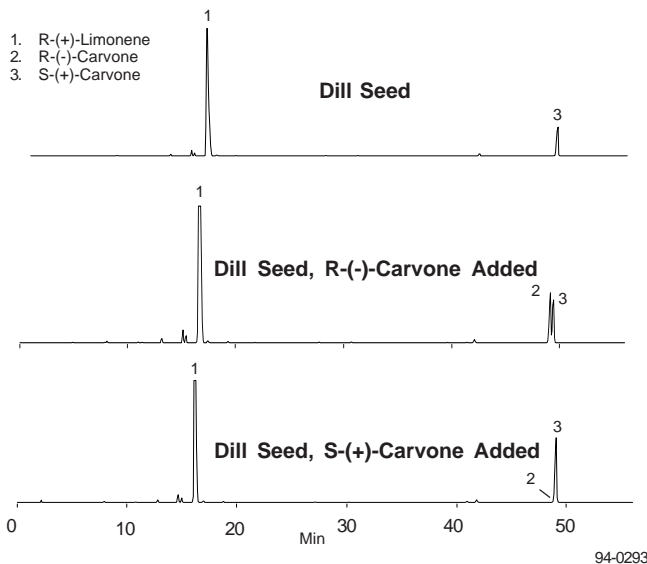

Caraway Seed

Sample: 0.5g caraway seed, 0.5g caraway seed plus 1µL R-(-)-carvone in 7mL vial
 SPME Fiber: **100µm polydimethylsiloxane**
 Cat. No.: **57300-U** (manual sampling)
 Extraction: headspace, 40°C, 5 min
 Desorption: 1 min, 250°C
 Column: **α-DEX 120, 30m x 0.25mm ID, 0.25µm film**
 Cat. No.: **2-4310**
 Oven: 80°C
 Carrier: helium, 35cm/sec
 Det.: FID, 300°C
 Inj.: split (100:1), 250°C

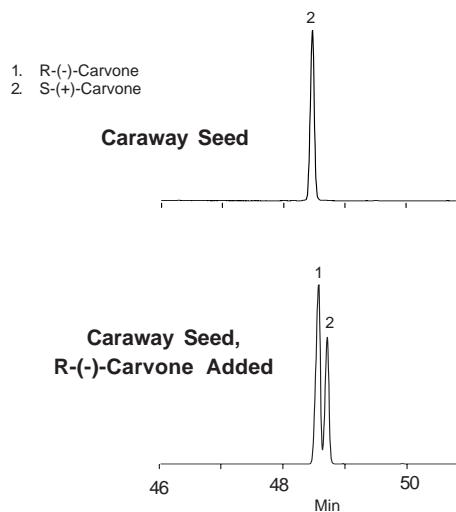

DEX 225 and DEX 325 Columns are the latest additions to the DEX column line. See inside back cover.

Column: **β-DEX 325, 30m x 0.25mm ID, 0.25µm film**
 Cat. No.: **2-4308**
 Oven: 110°C, 1-phenyl-2-propanol; 100°C, isopinocampheol; 90°C, 6-methyl-5-hepten-2-ol
 Carrier: helium, 20cm/sec
 Det.: FID, 300°C
 Inj.: 1µL methylene chloride (1mg/mL each analyte), split (100:1) 220°C

1-Phenyl-2-propanol

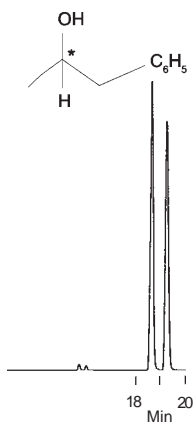

Isopinocampheol

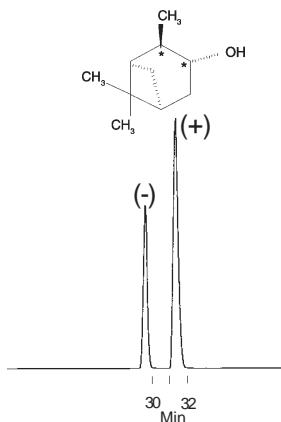

6-Methyl-5-hepten-2-ol

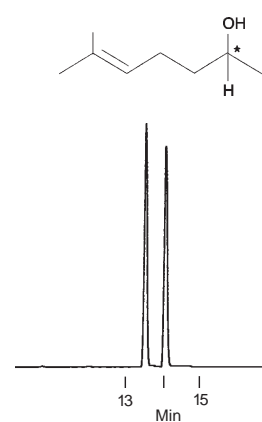

797-0021, 797-0022, 797-0023, 797-0020, 797-0025, 797-0024

Ordering Information:

α -DEX 120

The chiral stationary phase in α -DEX columns contains permethylated α -cyclodextrin embedded in an intermediate polarity stationary phase. The columns provide unique selectivity for the enantiomeric separation of small molecules; also recommended for separating positional isomers (phenols, xylenes, etc.).

Phase: nonbonded; 20% permethylated α -cyclodextrin in SPB-35 poly(35% phenyl/65% dimethylsiloxane)

Temp. Limits: 30°C to 250°C

McReynolds Nos.: x' y' z' u' s' = 102 243 142 221 170

Length (m)	d, (μ m)	Beta	Cat. No.
0.25mm ID Fused Silica			
30	0.25	250	24310

γ -DEX 120

The chiral stationary phase in γ -DEX columns contains 20% permethylated γ -cyclodextrin embedded in an intermediate polarity stationary phase. Because the elution order of the members of a chiral pair frequently reverses (enantioreversal) on a γ -DEX column, compared to the elution order on an α -DEX or β -DEX column, we recommend γ -DEX columns as complements to α -DEX and β -DEX columns.

Phase: nonbonded; 20% permethylated γ -cyclodextrin in SPB-35 poly(35% diphenyl/65% dimethylsiloxane)

Temp. Limits: 30°C to 250°C

Length (m)	d, (μ m)	Beta	Cat. No.
0.25mm ID Fused Silica			
30	0.25	250	24307

Custom Columns

We can prepare fused silica capillary columns with:

- 1-30% permethylated cyclodextrin, 0.1-0.5 μ m film
- 5-100 meter length
- 0.10-0.53mm ID
- alternative cyclodextrin derivatives
- alternative stationary cophases

Prices for these columns are comparable to prices for stock DEX columns. Please contact our Technical Service chemists or your local sales representative for more information.

β -DEX 110, β -DEX 120

The chiral stationary phase in β -DEX columns contains permethylated β -cyclodextrin embedded in an intermediate polarity stationary phase. Recommended for the enantiomeric separation of a wide range of chiral compounds (ketones, esters, alkanes, alkenes, alcohols, acids, ethers, etc.). The 10% (β -DEX 110) and 20% (β -DEX 120) β -cyclodextrin content alters the elution order while maintaining similar enantioselectivity.

Phase: nonbonded; 10% and 20% permethylated β -cyclodextrin in SPB-35 poly(35% diphenyl/65% dimethylsiloxane)

Temp. Limits: 30°C to 250°C

McReynolds Nos.: x' y' z' u' s' = 112 236 153 130 184 (β -DEX 110)

x' y' z' u' s' = 119 264 154 134 187 (β -DEX 120)

Length (m)	d, (μ m)	Beta	Cat. No.
β-DEX 110, 0.25mm ID Fused Silica			
30	0.25	250	24301
60	0.25	250	24302
β-DEX 110, 0.53mm ID Fused Silica			
30	0.5	265	25410-U
60	0.5	265	25411
β-DEX 120, 0.25mm ID Fused Silica			
30	0.25	250	24304
60	0.25	250	24305-U
β-DEX 120, 0.53mm ID Fused Silica			
30	0.5	265	25413-U
60	0.5	265	25414

Cyclodextrin Column Selection Kit I

This kit provides you with the tools you need to perform most chiral separations. Identities of enantiomers can be confirmed by monitoring changes in their elution order (enantioreversal) from an α -DEX column to a β -DEX column, a β -DEX column to a γ -DEX column, or an α -DEX column to a γ -DEX column.

Kit includes one 30m x 0.25mm ID, 0.25 μ m film column of each type: α -DEX 120, β -DEX 120, γ -DEX 120.

Description	Cat. No.
Cyclodextrin Column Selection Kit I	24340

Cyclodextrin Column Selection Kit II

In combination with Kit I, this kit provides you with a library of columns that spans the full range of DEX column enantioselectivity at substantial savings, relative to purchasing individual columns.

Kit includes one 30m x 0.25mm ID, 0.25 μ m film column of each type: β -DEX 120, β -DEX 225, γ -DEX 225, β -DEX 325.

Description	Cat. No.
Cyclodextrin Column Selection Kit II	24328-U

α -DEX 225

The chiral stationary phase in α -DEX 225 columns contains 2,3-di-O-acetyl-6-O-TBDMS- α -cyclodextrin embedded in an intermediate polarity phase.

Phase: nonbonded; 25% 2,3-di-O-acetyl-6-O-TBDMS- α -cyclodextrin embedded in SPB-20 poly(20% phenyl/80% dimethylsiloxane)

Temp. Limits: 30°C to 250°C

Length (m)	d _i (μm)	Beta	Cat. No.
0.25mm ID Fused Silica			
30	0.25	250	24311

β -DEX 225

The chiral stationary phase in β -DEX 225 columns contains 2,3-di-O-acetyl-6-O-TBDMS- β -cyclodextrin embedded in an intermediate polarity phase. These columns provide unique selectivity for enantiomeric separations of small molecules: alcohols, aldehydes (e.g., 2-phenylpropionaldehyde), esters (e.g., methyl malate, methyl lactate), flavor compounds, and ketones.

Phase: nonbonded; 25% 2,3-di-O-acetyl-6-O-TBDMS- β -cyclodextrin embedded in SPB-20 poly(20% phenyl/80% dimethylsiloxane)

Temp. Limits: 30°C to 250°C

Length (m)	d _i (μm)	Beta	Cat. No.
0.25mm ID Fused Silica			
30	0.25	250	24348
0.32mm ID Fused Silica			
30	0.25	320	24349
0.53mm ID Fused Silica			
30	0.25	265	25442

γ -DEX 225

The chiral stationary phase in γ -DEX 225 columns contains 2,3-di-O-acetyl-6-O-TBDMS- γ -cyclodextrin embedded in an intermediate polarity phase.

Phase: nonbonded; 25% 2,3-di-O-acetyl-6-O-TBDMS- γ -cyclodextrin embedded in SPB-20 poly(20% phenyl/80% dimethylsiloxane)

Temp. Limits: 30°C to 250°C

Length (m)	d _i (μm)	Beta	Cat. No.
0.25mm ID Fused Silica			
30	0.25	250	24312

α -DEX 325

The chiral stationary phase in α -DEX 325 columns contains 2,3-di-O-methyl-6-O-TBDMS- α -cyclodextrin embedded in an intermediate polarity phase.

Phase: nonbonded; 25% 2,3-di-O-methyl-6-O-TBDMS- α -cyclodextrin embedded in SPB-20 poly(20% phenyl/80% dimethylsiloxane)

Temp. Limits: 30°C to 250°C

Length (m)	d _i (μm)	Beta	Cat. No.
0.25mm ID Fused Silica			
30	0.25	250	24303

β -DEX 325

The chiral stationary phase in β -DEX 325 columns contains 2,3-di-O-methyl-6-O-TBDMS- β -cyclodextrin embedded in an intermediate polarity phase.

Phase: nonbonded; 25% 2,3-di-O-methyl-6-O-TBDMS- β -cyclodextrin embedded in SPB-20 poly(20% phenyl/80% dimethylsiloxane)

Temp. Limits: 30°C to 250°C

Length (m)	d _i (μm)	Beta	Cat. No.
0.25mm ID Fused Silica			
30	0.25	250	24308
0.32mm ID Fused Silica			
30	0.25	320	24309
0.53mm ID Fused Silica			
30	0.50	265	25443

γ -DEX 325

The chiral stationary phase in γ -DEX 325 columns contains 2,3-di-O-methyl-6-O-TBDMS- γ -cyclodextrin embedded in an intermediate polarity phase.

Phase: nonbonded; 25% 2,3-di-O-methyl-6-O-TBDMS- γ -cyclodextrin embedded in SPB-20 poly(20% phenyl/80% dimethylsiloxane)

Temp. Limits: 30°C to 250°C

Length (m)	d _i (μm)	Beta	Cat. No.
0.25mm ID Fused Silica			
30	0.25	250	24306

For more information, or current prices, contact your nearest Supelco subsidiary listed below. If your country is not listed, see the Supelco catalog for a complete list of all Supelco representatives, or contact Supelco, Bellefonte, PA 16823-0048 USA.

ARGENTINA · Sigma-Aldrich de Argentina, S.A. · Buenos Aires 1119 AUSTRALIA · Sigma-Aldrich Pty. Ltd. · Castle Hill NSW 2154 AUSTRIA · Sigma-Aldrich Handels GmbH · A-1110 Wien
BELGIUM · Sigma-Aldrich N.V./S.A. · B-2880 Bornem BRAZIL · Sigma-Aldrich Quimica Brasil Ltda. · 01239-010 São Paulo, SP CANADA · Sigma-Aldrich Canada, Ltd. · 2149 Winston Park Drive, Ontario L6H 6J8
CZECH REPUBLIC · Sigma-Aldrich s.r.o. · 186 00 Praha 8 FINLAND · Sigma-Aldrich Finland/YA-Kemia Oy · FIN-00700 Helsinki FRANCE · Sigma-Aldrich Chimie · 38297 Saint-Quentin-Fallavier Cedex
GERMANY · Sigma-Aldrich Chemie GmbH · D-82041 Deisenhofen GREECE · Sigma-Aldrich (o.m.) Ltd. · Ilioupoli 16346, Athens HUNGARY · Sigma-Aldrich Kft. · H-1067 Budapest
INDIA · Sigma-Aldrich Co. · Hyderabad 500 033 IRELAND · Sigma-Aldrich Ireland Ltd. · Dublin 24 ISRAEL · Sigma Israel Chemicals Ltd. · Rehovot 76100 ITALY · Sigma-Aldrich s.r.l. · 20151 Milano
JAPAN · Sigma-Aldrich Japan K.K. · Chuo-ku, Tokyo 103 MEXICO · Sigma-Aldrich Quimica S.A. de C.V. · 14210 México D.F. NETHERLANDS · Sigma-Aldrich Chemie BV · 3331 LL Zwijndrecht
NORWAY · Sigma-Aldrich Norway · Torshov · N-0401 Oslo POLAND · Sigma-Aldrich Sp. z o.o. · 61-663 Poznań SINGAPORE · Sigma-Aldrich Pte. Ltd.
SOUTH AFRICA · Sigma-Aldrich (pty) Ltd. · Midrand 1685 SPAIN · Sigma-Aldrich Quimica, S.A. · 28100 Alcobendas, Madrid SWEDEN · Sigma-Aldrich Sweden AB · 135 70 Stockholm
SWITZERLAND · Supelco · CH-9471 Buchs UNITED KINGDOM · Sigma-Aldrich Company Ltd. · Poole, Dorset BH12 4QH
UNITED STATES · Supelco · Supelco Park · Bellefonte, PA 16823-0048 · Phone 800-247-6628 or 814-359-3441 · Fax 800-447-3044 or 814-359-3044 · email:supelco@sial.com

α -DEX – β -DEX – γ -DEX Chiral Cyclodextrin Capillary GC Columns



Derivatized α -, β -, and γ -cyclodextrin on a stable phenylmethylpolysiloxane cophase, for efficiently separating optical and positional isomers without derivatization: foods – flavors – essential oils – pharmaceuticals – polymers – natural products – synthesized chemicals.

Selective, new-generation columns: high resolution, high temperature limits, low bleed, individually tested. Temperature range: 30°C – 240°C/250°C (isothermal/programmed)

Cyclodextrin Column Selection Kit

Determine which DEX column most effectively separates your samples, or use different columns to produce enantioreversals. Kit includes three 30m x 0.25mm ID x 0.25 μ m film columns, one of each 20% cyclodextrin type: α -DEX 120, β -DEX 120, γ -DEX 120.

Catalog No. 2-4340

Custom-Prepared Cyclodextrin Columns

Customize enantioselectivity / efficiency / sample capacity to your exact needs, by choosing:

- ✿ *CD inclusion cavity size*
- ✿ *CD content 1-30% CD / 0.1-0.5 μ m film*
- ✿ *Column internal diameter 0.10-0.53mm*
- ✿ *Column length 5-100m*

Prices for these columns are comparable to prices for stock DEX columns. Please contact our Technical Service chemists for more information (Phone 800-359-3041 or 814-359-3041, FAX 800-359-3044 or 814-359-5468).

For prices, or to order:

Phone: 800-247-6628 or 814-359-3441

FAX: 800-447-3044 or 814-359-3044



Supelco Park • Bellefonte, PA 16823-0048 USA