

Consumable Parts Catalog

2020

- Contact Frontier-lab's channel partners when purchasing the consumable parts listed in this catalog.
<http://www.frontier-lab.com/english/business-partners/>
- Appearance, specifications and kit contents are subject to change without notice.
- Refer to this catalog for details of parts compatibility.

1. Pyrolyzer (EGA/PY-3030D, PY-3030S, PY-2020iD/iS)

1.1 Consumable parts set	3
1.2 Sample cups	6
1.3 Pyrolyzer furnace	9
1.4 GC related parts	14
1.5 Capillary Column	16
1.6 Column and EGA tube connection parts	17
1.7 Standard Sample	24
1.8 Magic Chemisorber	24
1.9 Sampling tools	26

2. Sampler

2.1 On-line Micro Reaction Sampler	31
2.2 Micro Thermal Desorption Sampler	32

3. Selective Sampler (SS-1010E)

4. MicroJet Cryo-Trap (MJT-1030Ex/E, 1035E)

5. Auto-Shot Sampler (AS-1020E)

6. Carrier Gas Selector (CGS-1050Ex)

7. Micro-UV Irradiator (UV-1047Xe)

8. micro-Reactor (Tandem Rx-3050TR, Single Rx-3050SR)

1. Pyrolyzer (EGA/PY-3030D)

1.1 Consumable parts set : a set of consumable parts for one year



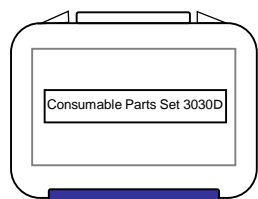







Consumable Parts Set 3030D

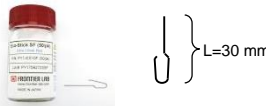

P/N: PY-K303D
for EGA/PY-3030D, 1 set

Contents of PY-K303D		Qty
1)	Eco-Cup SF (Sample cup)	100 ea
2)	Eco-Cup LF (Sample cup)	100 ea
3)	Eco-Stand AL (Sample cup stand)	5 ea
4)	Eco Pick-Up F (for sample cup recovery)	5 ea
5)	Eco-Stick SF	50 ea
6)	Eco-Stick DF	50 ea
7)	Needle Set N	8 ea
8)	Septum (for liquid sampler)	10 ea
9)	Quartz Pyrolysis Tube A3030	4 ea
10)	Graphite Vespel Ferrule (for interface)	8 ea

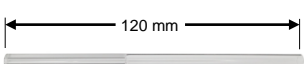
※ Use the following part numbers when ordering the parts individually. The quantities of each parts may differ from the Consumable Parts Set. The quantities of the parts contained in the Consumable Parts Set are shown in the list above.

No.	P/N (part number)	Part name	Specification	Qty	Part
1	PY1-EC50F	Eco-Cup SF	4 mm o.d. x H 5 mm , 50 μ L, made of stainless steel	100 ea	
2	PY1-EC80F	Eco-Cup LF	4 mm o.d. x H 8 mm , 80 μ L , made of stainless steel	100 ea	
3	PY1-EH10AL	Eco-Stand AL	Eco-Cup stand for 1 cup, for all Eco-Cups, made of aluminum	5 ea	
4	PY1-EP55F	Eco Pick-Up F	For stainless steel Eco-Cup recovery, L 135 mm	5 ea	
5	PY1-ES10F	Eco-Stick SF	L 30 mm , for Single-shot	50 ea	
6	PY1-ES20F	Eco-Stick DF	L 80 mm, for Double-shot	50 ea	
7	PY1-1274	Needle Set N	Deactivated needle for PY-3030,PY-2020 and Rx-3050	3 ea	
8	PY1-2025	Septum	For liquid sampler	20 ea	
9	PY1-3018A	Quartz Pyrolysis Tube A3030	For PY-3030, L 120 mm , made of quartz	1 ea	
10	PY1-7911	Graphite Vespel Ferrule	6 mm hole i.d., for interface	5 ea	

1. Pyrolyzer (EGA/PY-3030D, PY-3030S)

1.1 Consumable parts set : a set of consumable parts for one year

Consumable Parts Set 3030AS









Contents of PY-K313D		Qty
1)	Eco-Cup LF (Sample cup)	300 ea
2)	Needle Set N	8 ea
3)	Quartz Pyrolysis Tube A3030	4 ea
4)	ITF Union ASN (use with Auto-Shot Sampler)	1 set
5)	Eco-Cup Stand 10	2 ea
6)	Graphite Vespel Ferrule (for interface)	8 ea

P/N: PY-K313D

for EGA/PY-3030D or PY-3030S with
Auto-Shot Sampler AS-1020E, 1 set

※ Use the following part numbers when ordering the parts individually. The quantities of each parts may differ from the Consumable Parts Set. The quantities of the parts contained in the Consumable Parts Set are shown in the list above.

No.	P/N (part number)	Part name	Specification	Qty	Part
1	PY1-EC80F	Eco-Cup LF	4 mm o.d. x H 8 mm , 80 μ L, made of stainless steel	100 ea	
2	PY1-1274	Needle Set N	Deactivated needle for PY-3030, PY-2020 and Rx-3050	3 ea	
3	PY1-3018A	Quartz Pyrolysis Tube A3030	For PY-3030, L 120 mm , made of quartz	1 ea	
4	PY1-3533	ITF Union ASN	Interface Union Assey for use with Auto-Shot Sampler AS-1020E	1 set	
5	PY1-3711	Eco-Cup Stand 10	For Eco-Cup LF and Eco-Cup G/GQ, for 10 cups	1 ea	
6	PY1-7911	Graphite Vespel Ferrule	6 mm hole i.d., for interface	5 ea	

1. Pyrolyzer (PY-3030S)

1.1 Consumable parts set : a set of consumable parts for one year



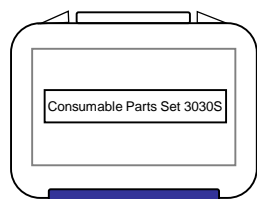

Consumable Parts Set 3030S

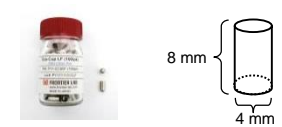

P/N: PY-K303S
for PY-3030S, 1 set

Contents of PY-K303S		Qty
1)	Eco-Cup SF (Sample cup)	100 ea
2)	Eco-Cup LF (Sample cup)	100 ea
3)	Eco-Stand AL (Sample cup stand)	5 ea
4)	Eco Pick-Up F (for sample cup recovery)	5 ea
5)	Eco-Stick SF	100 ea
6)	Needle Set N	8 ea
7)	Septum (for liquid sampler)	10 ea
8)	Quartz Pyrolysis Tube A3030	4 ea
9)	Graphite Vespel Ferrule (for interface)	8 ea



※ Use the following part numbers when ordering the parts individually. The quantities of each parts may differ from the Consumable Parts Set. The quantities of the parts contained in the Consumable Parts Set are shown in the list above.

No.	P/N (part number)	Part name	Specification	Qty	Part
1	PY1-EC50F	Eco-Cup SF	4 mm o.d. x H 5 mm , 50 μ L, made of stainless steel	100 ea	
2	PY1-EC80F	Eco-Cup LF	4 mm o.d. x H 8 mm , 80 μ L, made of stainless steel	100 ea	
3	PY1-EH10AL	Eco-Stand AL	Eco-Cup stand for 1 cup, for all Eco-Cups, made of aluminum	5 ea	
4	PY1-EP55F	Eco Pick-Up F	For stainless steel Eco- Cup recovery, L 135 mm	5 ea	
5	PY1-ES10F	Eco-Stick SF	L 30 mm , for Single-shot	50 ea	
6	PY1-1274	Needle Set N	Deactivated needle for PY-3030, PY-2020 and Rx-3050	3 ea	
7	PY1-2025	Septum	For liquid sampler	20 ea	
8	PY1-3018A	Quartz Pyrolysis Tube A3030	For PY-3030, L 120 mm , made of quartz	1 ea	
9	PY1-7911	Graphite Vespel Ferrule	6 mm hole i.d., for interface	5 ea	







1. Pyrolyzer (EGA/PY-3030D, PY-3030S, PY-2020iD/iS)

1.2 Sample Cups

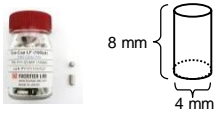
Common parts

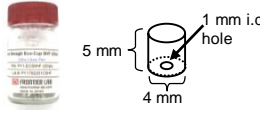
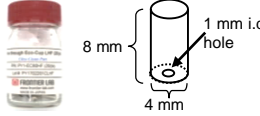
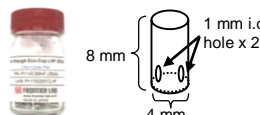





P/N (part number)	Part name	Specification	Qty	Part
PY1-EH10AL	Eco-Stand AL	Eco-Cup stand for 1 cup, for all Eco-Cups, made of aluminum	5 ea	
PY1-3711	Eco-Cup Stand 10	For Eco-Cup LF and Eco-Cup G/GQ, for 10 cups	1 ea	

Eco-Cup (Deactivated Stainless Steel)

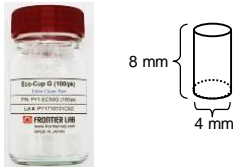
P/N (part number)	Part name	Specification	Qty	Part
PY1-EC50F	Eco-Cup SF	4 mm o.d. x H 5 mm , 50 μ L, made of stainless steel	100 ea	
PY1-EC80F	Eco-Cup LF	4 mm o.d. x H 8 mm , 80 μ L, made of stainless steel	100 ea	
PY1-EC80F-V4	Eco-Cup LF-V4	4 mm o.d. x H 8 mm , 80 μ L, made of stainless steel	400 ea (100 x 4 bottles)	
PY1-EC50HF	Flow Through Eco-Cup SHF	Flow through type, 1 mm i.d. hole at the bottom, 4 mm o.d. x H 5 mm , 50 μ L	20 ea	
PY1-EC80HF	Flow Through Eco-Cup LHF	Flow through type 1 mm i.d. hole at the bottom, 4 mm o.d. x H 8 mm , 80 μ L	20 ea	
PY1-EC80UV	Side Hole Eco-Cup UV	Flow through type, 1 mm i.d. hole at both sides, 4 mm o.d. x H 8 mm , 80 μ L	20 ea	
PY1-EP55F	Eco-Pickup F	For stainless steel Eco-Cup recovery, L 135 mm	5 ea	
PY1-ES10F	Eco-Stick SF	For stainless steel Eco-Cups, L 30 mm , for Single-shot	50 ea	
PY1-ES20F	Eco-Stick DF	For stainless steel Eco-Cups, L 80 mm , for Double-shot	50 ea	

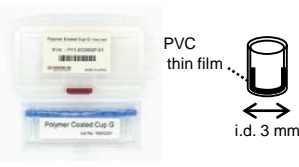

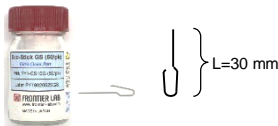
1. Pyrolyzer (EGA/PY-3030D, PY-3030S, PY-2020iD/iS)

Eco-Cup G series (Glass)

P/N (part number)	Part name	Specification	Qty	Part
AS1-7814	AS Teflon Sheet G	Teflon sheet for cup chute of Auto-Shot Sampler(3ea), spare fixing screw (4ea), Attach when glass Eco-Cup is used with Auto-Shot Sampler (stainless steel Eco-Cups can also be used with Teflon sheet)	1 set	
PY1-EC50G	Eco-Cup G	Non quartz coated, maximum use temp. 450°C, 4 mm o.d. x H 8 mm , thickness 5 mm , 50 µL	100 ea	
PY1-EC50GQ	Eco-Cup GQ	Glass coated with bonded quartz layer, maximum use temp. 600°C, 4 mm o.d. x H 8 mm , thickness 5 mm , 50 µL	30 ea	
PY1-EC50GP-01	Polymer Coated Cup G	PVC coated glass cup, maximum use temp. 450°C, 50µL	10ea	
PY1-EC50GP-05	Polymer Coated Cup G 5 sets	PVC coated glass cup, maximum use temp. 450°C, 50µL,	50ea	
PY1-EP55GF	Eco-Pickup GF	For glass Eco-Cup recovery, L 135 mm	5 ea	
PY1-ES10G	Eco-Stick GS	For glass Eco-Cups, L 30 mm, for Single-Shot	50 ea	
PY1-ES20G	Eco-Stick GD	For glass Eco-Cups, L 80 mm, for Double-Shot	50 ea	

1. Pyrolyzer (EGA/PY-3030D, PY-3030S, PY-2020iD/iS)

Eco-Cup (Non-deactivated Stainless Steel)

P/N (part number)	Part name	Specification	Qty	Part
PY1-EC80N	RoHS-Cup LN	Recommended for RoHS phthalates analysis, Non-deactivated stainless steel, max. use temp. 700°C, volume 80 µL	100 ea	
PY1-EC80N-V5	RoHS-Cup LN-V5	Recommended for RoHS phthalates analysis, Non-deactivated stainless steel, max. use temp. 700°C, volume 80 µL, 5 bottles	500 ea (100 x 5 bottles)	
PY1-EC80N-V10	RoHS-Cup LN-V10	Recommended for RoHS phthalates analysis, Non-deactivated stainless steel, max. use temp. 700°C, volume 80 µL, 10 bottles	1000 ea (100 x 10 bottles)	

1. Pyrolyzer (EGA/PY-3030D, PY-3030S, PY-2020iD/iS)

1.3 Pyrolyzer Furnace

Note: some of the parts are **only** compatible with 3030 or 2020 series

Furnace and Interface Parts

Common Parts

P/N (part number)	Part name	Specification	Qty	Part
PY1-7811	O-ring (P-12)	O-ring for sampler base of PY-2020iD/iS and PY-3030D/S, black	10 ea	

PY-3030D/S Parts

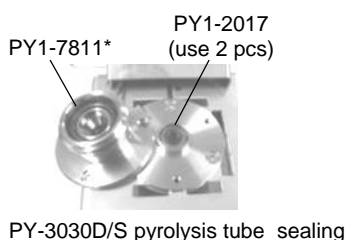

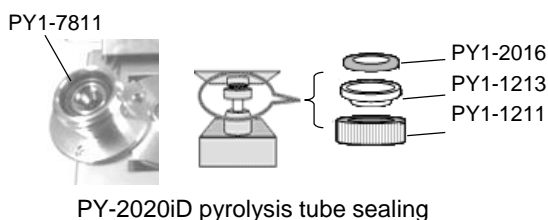

P/N (part number)	Part name	Specification	Qty	Part
PY1-2017	O-ring (P-6W)	Pyrolysis tube sealing Translucent silicon rubber	20 ea	

PY-2020iD/iS Parts



*** PY1-1211, PY1-1213 and PY1-2016 will be discontinued on Dec. 31, 2020.**

P/N (part number)	Part name	Specification	Qty	Part
PY1-1211*	Finger-tighten Nut	Finger-tighten nut, fixing quartz pyrolysis tube	1 ea	
PY1-1213*	Metal Washer 2	Metal washer 2, use with o-ring to fixing quartz pyrolysis tube	3 ea	
PY1-2016*	O-ring (SM-6)	O-ring (SM-6), for quartz pyrolysis tube sealing, standard for PY-2020 series	20 ea	

1. Pyrolyzer (EGA/PY-3030D, PY-3030S, PY-2020iD/iS)

Note: some of the parts are **only** compatible with 3030 or 2020 series

Furnace and Interface Parts

PY-3030D/S Parts

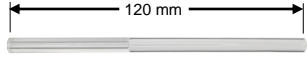
P/N (part number)	Part name	Specification	Qty	Part
PY1-3018A	Quartz Pyrolysis Tube A3030	For PY-3030, L 120 mm , made of quartz	1 ea	

PY-2020iD/iS Parts * PY1-1174 and PY1-2018A will be discontinued on Dec. 31, 2020.

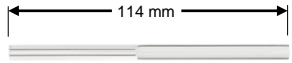
P/N (part number)	Part name	Specification	Qty	Part
PY1-1174*	Needle Set	Deactivated needle for PY-2020 series, use with old model union (PY1-3511/discontinued),	3 ea	
PY1-2018A*	Quartz Pyrolysis Tube A20	For PY-2020, L 114 mm , made of quartz	1 ea	

Common parts for PY-3030 and PY-2020 (Refer to the next page for details)

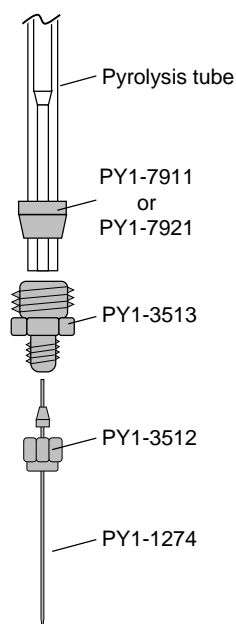

Connection between pyrolysis tube and needle

1. Pyrolyzer (EGA/PY-3030D, PY-3030S, PY-2020iD/iS)

Note: some of the parts are **only** compatible with 3030 or 2020 series

P/N (part number)	Part name	Specification	Qty	Part
PY1-1274	ITF Needle Set N	Deactivated needle for PY-3030,PY-2020 and Rx-3050	3 ea	
PY1-3512	Needle Nut	Stainless steel 1/16"	3 ea	
PY1-3513	Interface Union N	With nut	1 ea	
PY1-3515	ITF Union N Set	Contains 1 interface union N with a nut and 2 interface needles N	1 set	
PY1-3533	ITF Union ASN	Interface Union Assey for use with Auto-Shot Sampler AS-1020E	1 ea	
PY1-7911	Graphite Vespel Ferrule	6 mm hole i.d., for interface	5 ea	
PY1-7921	Graphite Ferrule	6 mm hole i.d.,	5 ea	



1. Pyrolyzer (EGA/PY-3030D, PY-3030S, PY-2020iD/iS)



Heat Sink Adapter Parts (for connection between pyrolyzer and GC inlet)

Depending on the combination of your GC and pyrolyzer, different part is used.

Please make sure to select parts compatible with your GC.

PY-3030D/S







P/N (part number)	Part name	Specification	Qty	Part
PY1-3551	Heat Sink Adapter Kit 3030	Agilent 7890/6890, Shimadzu GC-2010/17A	1 set	
PY1-3552		PerkinElmer Auto system/Clarus GC	1 set	
PY1-3555		Thermo Fisher TRACE/Focus GC	1 set	

P/N (part number)	Part name	Specification	Qty	Part
PY1-3544	Septum Nut Set 3030	Shimadzu GC-2010/17A	1 set	
PY1-3553		Agilent 7890/6890	1 set	
PY1-3556		PerkinElmer Auto system/Clarus GC	1 set	
- *		Thermo Fisher TRACE/Focus GC	-	-



* Ask your GC vendor.

1. Pyrolyzer (EGA/PY-3030D, PY-3030S, PY-2020iD/iS)

Sampler Parts

P/N (part number)	Part name	Specification	Qty	Part
PY1-1020	Double-Shot Sampler	Double-Shot Sampler for PY-2010, 2020, 3030 pyrolyzer	1 ea	
PY1-1040	Single-Shot Sampler	For all Single-Shot pyrolyzer	1 ea	
PY1-2022	Double-Shot Sampler Stand		1 ea	
PY1-2025	Septum	For liquid sampler	20 ea	
PY1-2112	O-ring (P-3)	For the purge valve of Double-Shot sampler	20 ea	
PY1-7412	Needle Guide φ 0.8 A	For liquid sampler 0.8 mm i.d., H 8 mm	1 ea	

GC Inlet Parts

P/N (part number)	Part name	Specification	Qty	Part
PY1-7301	Septum	Surface treated, for Agilent GC and Thermo TRACE1300/1310 GC	5 ea	
PY1-7304	Septum	Surface treated, for Shimadzu GC	5 ea	
PY1-7306	Septum	Surface treated, for Thermo TRACE GC Ultra and Focus GC	5 ea	

ITF Cover Parts

P/N (part number)	Part name	Specification	Qty	Part
PY1-3563	ITF Cover 3030A	Interface cover for EGA/PY-3030D, PY-3030S, Rx-3050TR, Rx-3050SR, includes set screws (3ea)	1 set	

1. Pyrolyzer (EGA/PY-3030D, PY-3030S, PY-2020iD/iS)

1.4 GC related parts

Tubing

P/N (part number)	Part name	Specification	Qty	Part
PY1-K002	Carrier Gas Union Set 1/8	Swagelok 1/8" union (Brass, 1ea), Swagelok 1/8" nut (Brass, 2ea), Swagelok 1/8" back ferrule (Brass, 2ea) and Inlet/outlet septum (5 ea)	1 set	
PY1-K003	Cap Set	Swagelok 1/8" nut (Brass, 1ea), Swagelok 1/8" cap (Brass, 1ea), Swagelok 1/8 back ferrule (Brass, 1ea) and Inlet/outlet septum (1ea)	1 set	
PY1-2028	Inlet/Outlet Septum	For connecting tubes, with hole	20 ea	
PY1-2216	Absorption Trap Tube	For trap tube only. Packed with activated charcoal	3 ea	
PY1-2218	Absorption Trap Set 7890/6890SV	For Agilent 7890/6890 split vent	1 set	
PY1-2227	Absorption Trap Set 17SV	For Shimadzu GC-2010 /17A split vent	1 set	

1. Pyrolyzer (EGA/PY-3030D, PY-3030S, PY-2020iD/iS)

Remote Signal Cable (for connection between pyrolyzer controller and GC)

Depending on the combination of your GC and pyrolyzer, different remote signal cable is used. Please make sure to select a part compatible with your GC.



PY-3030D/S

P/N (part number)	Part name	Specification	Qty	Part
PY1-6111	Remote Signal Cable 3030A78	Agilent 7890/6890	1 ea	
PY1-6121	Remote Signal Cable 3030S20	Shimadzu GC-2010	1 ea	
PY1-6122	Remote Signal Cable 3030S17	Shimadzu GC-17A	1 ea	
PY1-6131	Remote Signal Cable 3030T01	Thermo Fisher TRACE GC	1 ea	
PY1-6151	Remote Signal Cable 3030P01	PerkinElmer Auto system/Clarus GC	1 ea	
PY1-6171	Remote Signal Cable 3030J01	Master GC	1 ea	

1. Pyrolyzer (EGA/PY-3030D, PY-3030S, PY-2020iD/iS)

1.5 Capillary column

Common parts

P/N (part number)	Part name	Specification	Qty	Part
UAP-7001	File for Ultra ALLOY Capillary Tube	File for cutting capillary tubes	1 ea	
UAP-7002	Ceramic Cutter	W 40 x H 25 mm, thickness 1 mm	5 ea	

Capillary column



P/N (part number)	Part name	Specification	Qty	Part
UA5-30M-0.25F	Ultra ALLOY® Capillary column, UA5-30M-0.25F	30 m, 0.25 mm i.d., 0.25 µm	1 ea	

1. Pyrolyzer (EGA/PY-3030D, PY-3030S, PY-2020iD/iS)

1.6 Column and EGA tube connection parts

Vent-free GC/MS Adapter

Common parts

P/N (part number)	Part name	Specification	Qty	Part
UAP-7001	File for Ultra ALLOY Capillary Tube	File for cutting capillary tubes	1 ea	
UAP-7002	Ceramic Cutter	W 40 x H 25 mm, thickness 1 mm	5 ea	





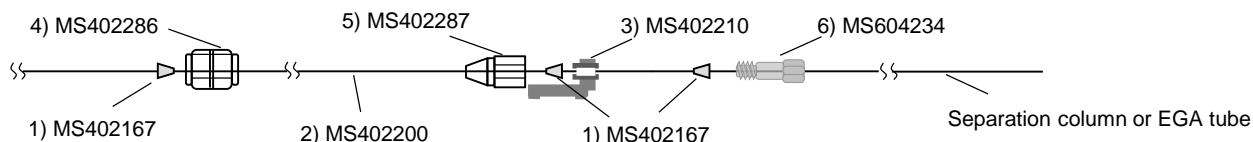

1. Pyrolyzer (EGA/PY-3030D, PY-3030S, PY-2020iD/iS)

1.6 Column and EGA tube connection parts

Connecting VF tube and Separation column (or EGA tube)

For Agilent, Shimadzu JEOL and Thermo TRACE 1300/1310



No.	P/N (part number)	Part name	Specification	Qty	Part
1	MS402167	VF Metal Ferrule D	VF Metal Ferrule D for column connection	20 ea	
2	MS402200	VF Tube N-50	Includes Vent-free tube N (0.15 mm id / 50 cm, 1 ea), VF spacer, VF metal ferrule D (2 ea), VF nut B and VF nut C	1 set	
3	MS402210	VF Holder N	Use with VF Tube N, consists of holder and fixing bracket	1 set	
4	MS402286	VF Nut B	For the interface between MS and VF tube	3 ea	
5	MS402287	VF Nut C	For the interface between VF Holder N and VF tube	3 ea	
6	MS604234	Column Nut	0.5 mm hole i.d.	1 ea	

※Refer to the next page for Vent-free GC/MS Adapter Kit.

1. Pyrolyzer (EGA/PY-3030D, PY-3030S, PY-2020iD/iS)

Vent-free GC/MS Adapter N-50

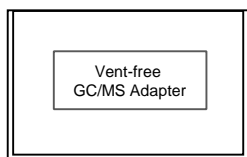







P/N: MS402280

For Agilent, Shimadzu, JEOL and Thermo TRACE 1300/1310

1 set

Contents of MS402280		Qty
1)	Plug Nut B	1 set
2)	VF Metal Ferrule D	10 ea
3)	VF Tube N-50	2 ea
4)	VF Holder N	1 ea
5)	VF Nut B	1 ea
6)	VF Nut C	1 ea
7)	Column Nut	2 ea
8)	Operation Manual	1 ea

※ Use the following part numbers when ordering the parts individually. The quantities of each parts may differ from the Vent-free GC/MS Adapter N-50. The quantities of the parts contained in the Vent-free GC/MS Adapter N-50 are shown in the list above.

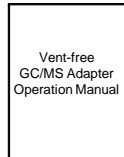
No.	P/N (part number)	Part name	Specification	Qty	Part
1	MS402168	Plug Nut B	Use to plug the VF tube	1 set	
2	MS402167	VF Metal Ferrule D	VF Metal Ferrule D for column connection	20 ea	
3	MS402200	VF Tube N-50	Includes Vent-free tube N (0.15 mm id / 50 cm, 1 ea), VF spacer, VF metal ferrule D (2 ea), VF nut B and VF nut C	1 set	
4	MS402210	VF Holder N	Use with VF Tube N, consists of holder and fixing bracket	1 set	
5	MS402286	VF Nut B	For the interface between MS and VF tube	3 ea	
6	MS402287	VF Nut C	For the interface between VF Holder N and VF tube	3 ea	
7	MS604234	Column Nut		1 ea	
8	-	Operation Manual	※Not for sale. This can be downloaded from Frontier Lab's website for free.	-	

1. Pyrolyzer (EGA/PY-3030D, PY-3030S, PY-2020iD/iS)

Connecting VF tube and Separation column (or EGA tube)

For Thermo TRACE Ultra and FOCUS

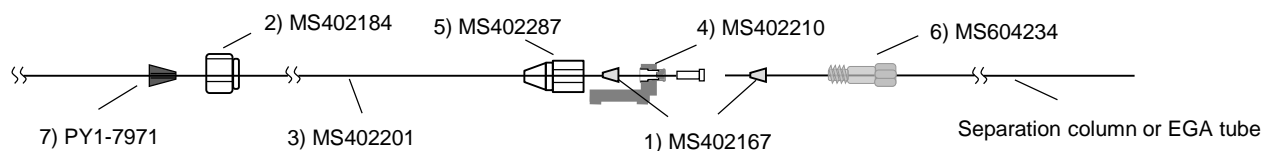

No.	P/N (part number)	Part name	Specification	Qty	Part
1	MS402167	VF Metal Ferrule D	VF Metal Ferrule D for column connection	20 ea	
2	MS402184	VF Nut 1/16	For connecting VF tube to Bruker/Thermo MS interface. 1/16 Swagelok, stainless	5 ea	
3	MS402201	VF Tube N-70	Includes Vent-free tube N (0.15 mm id / 70 cm, 1 ea), VF spacer, graphite vespel ferrule, VF metal ferrule, 1/16 nut (SS) and VF nut C For Thermo Fisher MS	1 ea	
4	MS402210	VF Holder N	Use with VF Tube N, consists of holder and fixing bracket	1 set	
5	MS402287	VF Nut C	For the interface between VF Holder N and VF tube	3 ea	
6	MS604234	Column Nut		1 ea	
7	PY1-7971	Graphite Vespel Ferrule 05	0.5 mm hole i.d.	10 ea	

※Refer to the next page for Vent-free GC/MS Adapter Kit.

1. Pyrolyzer (EGA/PY-3030D, PY-3030S, PY-2020iD/iS)

Vent-free GC/MS Adapter N-70

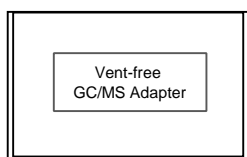





P/N: MS402290

For Thermo TRACE Ultra and Focus GC

1 set

Contents of MS402290		Qty
1)	Plug Nut B	1 set
2)	VF Metal Ferrule D	10 ea
3)	VF Nut 1/16	1 ea
4)	VF Tube N-70	2 ea
5)	VF Holder N	1 ea
6)	VF Nut C	1 ea
7)	Column Nut	2 ea
8)	Graphite Vespel Ferrule 05	1 ea
9)	Operation Manual	1 ea

※ Use the following part numbers when ordering the parts individually. The quantities of each parts may differ from the Vent-free GC/MS Adapter N-70. The quantities of the parts contained in the Vent-free GC/MS Adapter N-70 are shown in the list above.

No.	P/N (part number)	Part name	Specification	Qty	Part
1	MS402168	Plug Nut B	Use to plug the VF tube	1 set	
2	MS402167	VF Metal Ferrule D	VF Metal Ferrule D for column connection	20 ea	
3	MS402184	VF Nut 1/16	For connecting VF tube to Bruker/Thermo MS interface. 1/16 Swagelok, stainless	5 ea	
4	MS402201	VF Tube N-70	Includes Vent-free tube N (0.15 mm id / 70 cm, 1 ea), VF spacer, graphite vespel ferrule, VF metal ferrule, 1/16 nut (SS) and VF nut C For Thermo Fisher MS	1 ea	
5	MS402210	VF Holder N	Use with VF Tube N, consists of holder and fixing bracket	1 set	
6	MS402287	VF Nut C	For the interface between VF Holder N and VF tube	3 ea	
7	MS604234	Column Nut		1 ea	
8	PY1-7971	Graphite Vespel Ferrule 05	0.5 mm hole i.d.	10 ea	
9	-	Operation Manual	※Not for sale. This can be downloaded from Frontier Lab's website for free.	1 ea	

1. Pyrolyzer (EGA/PY-3030D, PY-3030S, PY-2020iD/iS)

Connecting VF tube and Separation column (or EGA tube)

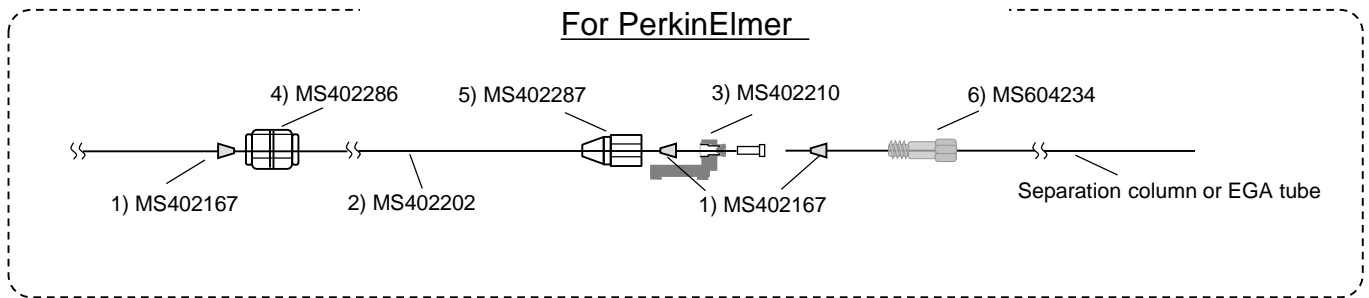

No.	P/N (part number)	Part name	Specification	Qty	Part
1	MS402167	VF Metal Ferrule D	VF Metal Ferrule D for column connection	20 ea	
2	MS402202	VF Tube N-70PE	Includes Vent-free tube N (0.15 mm id / 70 cm, 1 ea), VF spacer, VF metal ferrule D (2ea), VF nut B and VF nut C For PerkinElmer Clarus series	1 ea	
3	MS402210	VF Holder N	Use with VF Tube N, consists of holder and fixing bracket	1 set	
4	MS402286	VF Nut B	For the interface between MS and VF tube	3 ea	
5	MS402287	VF Nut C	For the interface between VF Holder N and VF tube	3 ea	
6	MS604234	Column Nut		1 ea	

※Refer to the next page for Vent-free GC/MS Adapter Kit.

1. Pyrolyzer (EGA/PY-3030D, PY-3030S, PY-2020iD/iS)



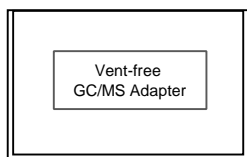

Vent-free GC/MS Adapter N-70PE



P/N: MS402295
For PerkinElmer,
1 set

Contents of MS402295		Qty
1)	Plug Nut B	1 set
2)	VF Metal Ferrule D	10 ea
3)	VF Tube N-70PE	2 ea
4)	VF Holder N	1 ea
5)	VF Nut B	1 ea
6)	VF Nut C	1 ea
7)	Column Nut	2 ea
8)	Operation Manual	1 ea

※ Use the following part numbers when ordering the parts individually. The quantities of each parts may differ from the Vent-free GC/MS Adapter N-70PE. The quantities of the parts contained in the Vent-free GC/MS Adapter N-70PE are shown in the list above.

No.	P/N (part number)	Part name	Specification	Qty	Part
1	MS402168	Plug Nut B	Use to plug the VF tube	1 set	
2	MS402167	VF Metal Ferrule D	VF Metal Ferrule D for column connection	20 ea	
3	MS402202	VF Tube N-70PE	Includes Vent-free tube N (0.15 mm id / 70 cm, 1 ea), VF spacer, VF metal ferrule D (2ea), VF nut B and VF nut C For PerkinElmer Clarus series	1 ea	
4	MS402210	VF Holder N	Use with VF Tube N, consists of holder and fixing bracket	1 set	
5	MS402286	VF Nut B	For the interface between MS and VF tube	3 ea	
6	MS402287	VF Nut C	For the interface between VF Holder N and VF tube	3 ea	
7	MS604234	Column Nut		1 ea	
8	-	Operation Manual	※Not for sale. This can be downloaded from Frontier Lab's website for free.	1 ea	



1. Pyrolyzer (EGA/PY-3030D, PY-3030S, PY-2020iD/iS)

1.7 Standard sample

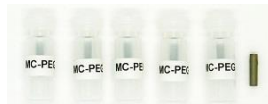

P/N (part number)	Part name	specification	Qty	Part
PY1-4908	Polystyrene sample	For Pyrolyzer Performance Evaluation, Polystyrene 2.5 mg film, Me-stearate 5 w% in 2mL glass bottle	1 ea	

1.8 Magic Chemisorber

Magic Chemisorber PEG

P/N (part number)	Part name	Specification	Qty	Part
NEW PY1-MC04P	Magic Chemisorber PEG	Includes Magic Chemisorber PEG	5 ea	
NEW PY1-MC04P-K	Magic Chemisorber PEG Kit	Includes Magic Chemisorber PEG (5 ea) and Eco-Stick GD (5 ea)	1 set	

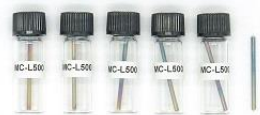
Magic Chemisorber PDMS

P/N (part number)	Part name	Specification	Qty	Part
PY1-MC01L	Magic Chemisorber L500	100% dimethylpolysiloxane, film thickness 500 μm, L 34.5 mm, use with PY1-MCP01	5 ea	
PY1-MC01L-K	Magic Chemisorber L500 Kit	Includes Magic Chemisorber L500 (3 ea), Eco-Stick DF (5 ea) and MC holder L (2 ea)	1 set	
PY1-MC01S	Magic Chemisorber S500	100% dimethylpolysiloxane, film thickness 500 μm, L 6 mm, use with PY1-EC80HF or PY1-EC80F	10 ea	

1. Pyrolyzer (EGA/PY-3030D, PY-3030S, PY-2020iD/iS)

1.8 Magic Chemisorber

P/N (part number)	Part name	Specification	Qty	Part
PY1-MC01S-K	Magic Chemisorber S500 Kit	Includes Magic Chemisorber S500(3 ea), Eco-Stick DF (5 ea) and MC holder S (Flow through Eco-Cup LHF, 5 ea)	1 set	
NEW PY1-MC01SL-K	Magic Chemisorber SL Kit	Includes Magic Chemisorber L500 (2 ea), Magic Chemisorber L100 (2 ea) and Magic Chemisorber S500 (2 ea)	1 set	
PY1-MCP01	MC holder L	Protective tube for Magic Chemisorber L	3 ea	
PY1-MC02L	Magic Chemisorber L100	100% dimethylpolysiloxane, film thickness 100 μm, L 30mm	5 ea	
PY1-MC02L-K	Magic Chemisorber L100 Kit	Includes Magic Chemisorber L100 (3ea), Eco-stick DF (5ea) and MC holder L (2ea)	1 set	

1. Pyrolyzer (EGA/PY-3030D, PY-3030S, PY-2020iD/iS)

1.9 Sampling Tools

Micro-puncher

A set of three Micro-punchers (same inner diameter) and one Cutting Mat L.



P/N (part number)	Part name	Specification	Qty	Part
FMP-0.50S	Micro-puncher 050S	0.50 mm i.d., 3 punchers, 1 Cutting Mat L ,White	1 set	 <p>A variety of Micro-punchers and Cutting Mat L</p>
FMP-0.75S	Micro-puncher 075S	0.75 mm i.d., 3 punchers, 1 Cutting Mat L ,Green	1 set	
FMP-1.25S	Micro-puncher 125S	1.25 mm i.d., 3 punchers, 1 Cutting Mat L ,White	1 set	
FMP-2.00S	Micro-puncher 200S	2.00 mm i.d., 3 punchers, 1 Cutting Mat L ,Gray	1 set	
FMP-3.00S	Micro-puncher 300S	3.00 mm i.d., 3 punchers, 1 Cutting Mat L, White	1 set	
HMP-4.00S	Micro-puncher 400S	4.00 mm i.d., 3 punchers, 1 Cutting Mat L, Brown	1 set	
HMP-5.00S	Micro-puncher 500S	5.00mm i.d., 3 punchers, 1 Cutting Mat L, Orange	1 set	

A set of ten Micro-punchers (same inner diameter). The Cutting Mat L is not included.

P/N (part number)	Part name	Specification	Qty	Part
FMP-0.50D	Micro-puncher 050D	0.50 mm i.d., White	10 ea	 <p>A variety of Micro-punchers and Cutting Mat L</p> <p>※Cutting Mat L is not included in this products.</p>
FMP-0.75D	Micro-puncher 075D	0.75 mm i.d., Green	10 ea	
FMP-1.25D	Micro-puncher 125D	1.25 mm i.d., White	10 ea	
FMP-2.00D	Micro-puncher 200D	2.00 mm i.d., Gray	10 ea	
FMP-3.00D	Micro-puncher 300D	3.00 mm i.d., White	10 ea	
HMP-4.00D	Micro-puncher 400D	4.00 mm i.d., Brown	10 ea	
HMP-5.00D	Micro-puncher 500D	5.00mm i.d., Orange	10 ea	

1. Pyrolyzer (EGA/PY-3030D, PY-3030S, PY-2020iD/iS)

Micro-puncher

P/N (part number)	Part name	specification	Qty	Part
FMP-03KIT	Micro-puncher 03 Kit	3 pcs each of 0.75/ 1.25/ 2.0 (mm i.d.) punchers and 2 sheets of Cutting Mat L	1 set	
HMP-04KIT	Micro-puncher 04 Kit	3 pcs each of 3.0 /4.0 /5.0 (mm i.d.) punchers and 2 sheets of Cutting Mat L	1 set	
P/N (part number)	Part name	Specification	Qty	Part
FCM-6577	Cutting Mat L	L 150 mm x W 220 mm Light green	5 ea	

1. Pyrolyzer (EGA/PY-3030D, PY-3030S, PY-2020iD/iS)

Sampling Tool Kit 01 **NEW**



P/N: PY1-K101

1 set

Contents of PY1-K101	Qty
1) Cutting Mat L	2 ea
2) Micro-puncher 125D	5 ea
3) Tweezers	3 ea
4) Cutter Knife	2 ea
5) Scissors	1 ea
6) Precision Scissors	1 ea

※ Use the following part numbers when ordering the parts individually. The quantities of each parts may differ from the Sampling Tool Kit 01. The quantities of the parts contained in the Sampling Tool Kit 01 are shown in the list above.

No.	P/N (part number)	Part name	Specification	Qty	Part
1	FCM-6577 *1	Cutting Mat L	L 150 mm x W 220 mm Light green	5 ea	
2	FMP-1.25D *1	Micro-puncher 125D	Micro-puncher 1.25mm i.d., White	10 ea	
3	PY1-7141	Tweezers	L 125 mm	1 ea	
4	PY1-7151	Cutter Knife	Incl. spare blades (25 pcs)	1 ea	
5	PY1-7161	Scissors	L 176 mm , Blades 65 mm	1 ea	
6	PY1-7162	Precision Scissors	L 90 mm , Blades 16 mm	1 ea	

*1 : A set of Micro-puncher 125 (3 ea) and Cutting Mat L (1 ea) is available.
(Product name: Micro-puncher 125S, P/N: FMP-1.25S)

Micro-punchers have 7 kinds of inner diameter (0.5/ 0.75/ 1.25/ 2.0/ 3.0/ 4.0/ 5.0 mm).
Refer to the catalog of Micro-puncher from Frontier-lab's website for details.

1. Pyrolyzer (EGA/PY-3030D, PY-3030S, PY-2020iD/iS)



Sampling Tool Kit 02 **NEW**



P/N: PY1-K102
1set

Contents of PY1-K102	Qty
1) Cutting Mat L	1 ea
2) Micro-puncher 050D	3 ea
3) Micro-puncher 075D	3 ea
4) Micro-puncher 125D	3 ea
5) Micro Sample Collector	1 ea
6) Eco-Cup Stand 10	1 ea
7) Tweezers	2 ea
8) Blunt Tip Tweezers	1 ea
9) Sampling Needle	3 ea
10) Double Head Spatula	1 ea
11) Cutter Knife	1 ea
12) Scissors	1 ea
13) Precision Scissors	1 ea
14) Eco-Stand AL	2 ea
15) File for Ultra ALLOY Capillary Tube	1 ea









※ Use the following part numbers when ordering the parts individually. The quantities of each parts may differ from the Sampling Tool Kit 02. The quantities of the parts contained in the Sampling Tool Kit 02 are shown in the list above.

No.	P/N (part number)	Part name	Specification	Qty	Part
1	FCM-6577 *1	Cutting Mat L	L 150 mm x W 220 mm Light green	5 ea	
2	FMP-0.50D *1	Micro-puncher 050D	Micro-puncher 0.5mm i.d., White	10 ea	
3	FMP-0.75D *1	Micro-puncher 075D	Micro-puncher 0.75mm i.d., White	10 ea	
4	FMP-1.25D *1	Micro-puncher 125D	Micro-puncher 1.25mm i.d., White	10 ea	
5	PY1-1070 *2	Micro Sample Collector Kit	Incl. Micro Coil S (20 ea)	5 ea	
6	PY1-3711	Eco-Cup Stand 10	For Eco-Cup LF and Eco-Cup G/GQ, for 10cups	1 ea	

1. Pyrolyzer (EGA/PY-3030D, PY-3030S, PY-2020iD/iS)

Sampling Tool Kit 02 (Cont.) **NEW**

※ Use the following part numbers when ordering the parts individually. The quantities of each parts may differ from the Sampling Tool Kit 02. The quantities of the parts contained in the Sampling Tool Kit 02 are shown in the list above.

No.	P/N (part number)	Part name	Specification	Qty	Part
7	PY1-7141	Tweezers	L 125 mm	1 ea	
8	PY1-7142	Blunt Tip Tweezers	L 125 mm	1 ea	
9	PY1-7145	Sampling Needle	For viscous liquids	5 ea	
10	PY1-7147	Double Head Spatula	Gathers powder samples	1 ea	
11	PY1-7151	Cutter Knife	Incl. spare blades (25 pcs)	1 ea	
12	PY1-7161	Scissors	L 176 mm , Blades 65 mm	1 ea	
13	PY1-7162	Precision Scissors	L 90 mm , Blades 16 mm	3 ea	
14	PY1-EH10AL	Eco-Stand AL	Eco-Cup stand for 1 cup, for all Eco-Cups, made of aluminum	5 ea	
15	UAP-7001	File for Ultra ALLOY Capillary Tube	File for cutting capillary tubes	1 ea	

*1 A set of Micro-puncher (3 ea) and Cutting Mat L (1 ea) is available.

Product name : Micro-puncher 050S, P/N : FMP-0.50S

Product name : Micro-puncher 075S, P/N : FMP-0.75S

Product name : Micro-puncher 125S, P/N : FMP-1.25S

Micro-punchers have 7 kinds of inner diameter (0.5/ 0.75/ 1.25/ 2.0/ 3.0/ 4.0/ 5.0 mm).

Refer to the catalog of Micro-punchers from Frontier-lab's website for details.

*2 Micro Sample Collector Kit (P/N: PY1-1070) comes with Micro Coil S (20 ea).









Micro Sample Collector and Micro Coil S are available individually.

Product name : Micro Sample Collector (5 ea), P/N : PY1-1071

Product name : Micro Coil S (20 ea x 5), P/N : PY1-1075





2. Sampler

2.1 On-line Micro Reaction Sampler (PY1-1050)

P/N (part number)	Part name	Specification	Qty	Part
PY1-3321	SUS Pyrolysis Tube 3030	Deactivated stainless steel	1 ea	
PY1-5113	Glass Capsule B	L 40 mm	20 ea	
PY1-5114	Glass Capsule B 120	L 120 mm	20 ea	
PY1-5311	Reaction Chamber		1 ea	
PY1-5315	Glass Capsule Sealing Assembly	Glass Capsule Holder A1 (1 ea) Glass Capsule Holder B1 (1 ea) O-ring S3 (red, 3 ea)	1 set	
PY1-5316	Glass Capsule Holder A1		1 ea	
PY1-5317	Glass Capsule Holder B1		1 ea	
PY1-5319	O-ring S3	Red	20 ea	
UV1-3802	UV Sampler Stand	Stand for sampler	1 ea	
UV1-7701	O-ring S4	Fluorine rubber, black	10 ea	

2. Sampler

2.2 Micro Thermal Desorption Sampler (PY1-1060)

P/N (part number)	Part name	Specification	Qty	Part
PY1-5210	TD tube packed with Tenax	For micro therm desorption (PY1-1060). TD tube packed with Tenax	3 ea	
PY1-5220	TD tube	For micro thermal desorption sampler (PY1-1060), cleaned blank glass tube	5 ea	
UV1-3802	UV Sampler Stand	Stand for sampler	1 ea	
UV1-7701	O-ring S4	Fluorine rubber, black	10 ea	

3. Selective Sampler (SS-1010E)

Connection parts for GC inlet

Depending on the combination of your GC and pyrolyzer, different part is used.

Please make sure to select parts compatible with your GC.

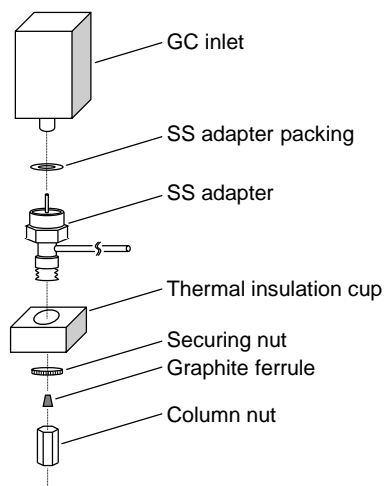

Connection parts underneath GC inlet

GC	SS Adapter Packing	SS Adapter	Thermal Insulation Cup	Securing nut	Graphite ferrule	Column nut
Agilent 7890/6890	SS1-1011	SS1-1001	SS1-1012	SS1-1013	PY1-7971	MS604234 ¹⁾
Shimadzu GC-2010/17A	SS1-2011	SS1-2001	SS1-2012	Not necessary ²⁾	SS1-7215	SS1-7201 ³⁾
Thermo TRACE 1300/1310 GC	SS1-1011	SS1-3101	Not necessary ⁴⁾	Not necessary	PY1-7971	MS604234
Thermo TRACE GC	*	SS1-3001	SS1-3012	SS1-1013	PY1-7971	SS1-7301
Thermo Focus GC	*	SS1-3001	SS1-3022	SS1-1013	PY1-7971	SS1-7301

¹⁾ Agilent column nut (Agilent P/N: 5181-8830) can be used

²⁾ Standard screws for GC are used



³⁾ Shimadzu column nut (Shimadzu P/N: 221-32705) can be used

⁴⁾ Use the thermal insulator (P/N: MJ1-1518)





* Order Thermo Fisher's genuine part (Thermo Fisher P/N: 29033629)

3. Selective Sampler (SS-1010E)





SS Adapter Packing

P/N (part number)	Part name	Specification	Qty	Part
SS1-1011	SS Adapter Packing for Agilent, Thermo 1300/1310GC	For SS adapter (SS1-1001 and SS1-3101)	10 ea	
SS1-2011	SS Adapter Packing for Shimadzu	For SS Adapter (SS1-2001)	10 ea	

SS Adapter

P/N (part number)	Part name	Specification	Qty	Part
SS1-1001	SS Adapter for Agilent	For Agilent7890/6890	1 set	
SS1-2001	SS Adapter for Shimadzu	For Shimadzu GC-17A/2010, includes purge line capillary tube (1.75 m , 0.25 mm i.d.)	1 set	
SS1-3001	SS Adapter for TRACE GC Ultra/FOCUS GC	For TRACE GC Ultra/FOCUS GC, includes purge line capillary tube (1.75 m , 0.25 mm i.d.)	1 set	
SS1-3101	SS Adapter for TRACE 1300/1310 GC	SS adapter for Thermo TRACE 1300/1310 GC, includes purge line capillary tube (1.75 m , 0.25 mm i.d.)	1 set	

Thermal Insulation Cup



P/N (part number)	Part name	Specification	Qty	Part
SS1-1012	Thermal Insulation Cup for Agilent	For SS adapter (SS1-1001)	1 ea	
SS1-2012	Thermal Insulation Cup for Shimadzu	For SS adapter (SS1-2001), includes 2 securing screws	1 ea	
SS1-3012	Thermal Insulation Cup for TRACE GC Ultra	For Thermo TRACE GC Ultra	1 ea	
SS1-3022	Thermal Insulation Cup for FOCUS GC	For Thermo FOCUS GC	1 ea	

3. Selective Sampler (SS-1010E)



Thermal Insulation Cup

P/N (part number)	Part name	Specification	Qty	Part
SS1-1013	Thermal Insulation Cup Securing Nut (for Agilent&Thermo GCs)	Fixing nut of thermal insulation cup for SS adapter (SS1-1001 and SS1-3001)	1 ea	

Graphite ferrule

P/N (part number)	Part name	Specification	Qty	Part
PY1-7971	Graphite Vespel Ferrule 05	0.5 mm hole i.d., for Ultra ALLOY Capillary column and EGA tube	10 ea	
SS1-7215	Graphite Ferrule 0.5	Graphite ferrule for Shimadzu GC	10 ea	

Column nut

P/N (part number)	Part name	Specification	Qty	Part
MS604234	Column Nut		1 ea	
SS1-7201	Column Nut	For Shimadzu GC	1 ea	
SS1-7301	Column Nut T for TRACE GC Ultra/FOCUS GC	For TRACE GC Ultra/FOCUS GC, for SS adapter (SS1-3001)	1 ea	

3. Selective Sampler (SS-1010E)

Other parts

P/N (part number)	Part name	Specification	Qty	Part
PY1-3337	Glass Insert	Deactivated glass insert	1 ea	
SS1-4210	Purge Line Kit		1 set	
SS1-4211	Purge Line Capillary Tube	0.25 mm i.d., 1.75 m	1 ea	
SS1-4300	Plumbing Kit	includes 1 ea of copper Tube 3 m, 1/8 tee union and 1/8 cap nut	1 set	
SS1-7101	Double Head Wrench	Wrench 12-14 mm	1 ea	
SS1-7355	Inlet/Outlet Septum for capillary tube	Inlet/outlet septum (rubber seal with hole) for SS connecting tubes	10 ea	

4. MicroJet Cryo-Trap (MJT-1030Ex/E, MJT-1035E)

MJT parts in GC oven







P/N (part number)	Part name	Specification	Qty	Part
MJ1-1111	Micro Jet Tube	MicroJet Tube, quartz	1 ea	
MJ1-1121	LN2 Saver	Two in 1 set	1 set	
MJ1-1304	Thermal Exchange Coil 10L	Thermal exchange coil for 10 liters container	1 ea	
MJ1-1305	Thermal Exchange Coil 2L	Thermal exchange coil for 2 liters container	1 ea	
MJ1-1306	Thermal Exchange Coil 30L	For use with a 30L liquid nitrogen container	1 ea	
MJ1-1500	Liquid Nitrogen Container Kit	Bench top Liquid Nitrogen Container Kit, includes, each 1 pcs of Container cap 2L, Thermal exchange coil 2L, Liquid N2 container 2L, Stand base, Stand pole, Clamp and Indicator	1 set	
MJ1-1511	Liquid N2 Container 2L		1 ea	
MJ1-1512	Container Cap 2L	For liquid N2 container 2L (MJ1-1511)	1 ea	
MJ1-1513	Stand Base		1 ea	
MJ1-1514	Stand Pole		1 ea	

4. MicroJet Cryo-Trap (MJT-1030Ex/E, MJT-1035E)

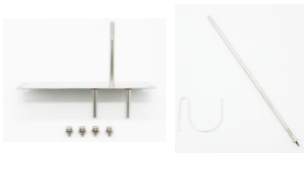
P/N (part number)	Part name	Specification	Qty	Part
MJ1-1515	Clamp	Clamp for holding liquid nitrogen feed tube	1 ea	
MJ1-1517	Indicator	Liquid nitrogen fluid level indicator for 2 liters container	1 ea	
MJ1-1521	Container Cap 2L	Container cap for Liquid N2 container 2L	1 ea	
MJ1-1522	Container Cap 30L	For 30L container	1 ea	
MJ1-1600	Thermal Exchange Coil Set for 30L Container	Includes each 1 of Container Cap 30L and Thermal Exchange Coil 30L	1 set	
MJ1-3101	MicroJet Tube Union Set	Includes each 1 pcs of hexagon cap nut and fixing nut	1 set	
MJ1-7941	Graphite Ferrule	Graphite ferrule for MicroJet tube	5 ea	

4. MicroJet Cryo-Trap (MJT-1030Ex/E, MJT-1035E)







Installation Kit

P/N (part number)	Part name	Specification	Qty	Part
MJ1-K201	MJT-1030E/Ex Installation Kit for Shimadzu GC-17A/2010	Includes support plate (MJ1-1204) and tube hanger (MJ1-3501)	1 set	
MJ1-K380	MJT-1030E/Ex Installation Kit for Varian CP3800GC	Includes support plate (MJ1-1208) and tube hanger(MJ1-3501)	1 set	
MJ1-K580	MJT-1030E/Ex Installation Kit for HP5890	Includes support plate (MJ1-1202) and tube hanger (MJ1-3501)	1 set	
MJ1-K680	MJT-1030E/Ex Installation Kit for Agilent7890/6890	Includes support plate (MJ1-1201) and tube hanger(MJ1-3502)	1 set	
MJ1-K801	MJT-1030E/Ex Installation Kit for PerkinElmer Clarus GC	Includes support plate (MJ1-1209) and tube hanger (MJ1-3501)	1 set	
MJ1-K901	MJT-1030E/Ex Installation Kit for Thermo TRACE GC Ultra	Includes support plate (MJ1-1207) and tube hanger (MJ1-3501)	1 set	
MJ1-K903	MJT-1030E/Ex Installation Kit for Thermo TRACE 1300/1310GC	Includes support plate (MJ1-1218), Thermal insulator (MJ1-1518)	1 set	



4. MicroJet Cryo-Trap (MJT-1030Ex/E, MJT-1035E)

Liquid Nitrogen Feed Tube Securing Plate for Major GCs

The shape and size of the liquid nitrogen feed tube securing plates vary depending on your GC model. Choose the right one for your GC from the table below.





P/N (part number)	Part name	Specification	Qty	Part
MJ1-1201	Securing Plate	For Agilent 7890 / 6890	1 set	
MJ1-1202		For HP 5890	1 set	
MJ1-1204		For Shimadzu GC-2010 / 17A	1 set	
MJ1-1207		For Thermo Fisher TRACE GC Ultra	1 set	
MJ1-1208		For Varian CP3800 GC	1 set	
MJ1-1209		For PerkinElmer Clarus GC	1 set	
MJ1-1218		For Thermo Fisher TRACE 1300/1310 GC	1 set	

Tube Hanger

P/N (part number)	Part name	Specification	Qty	Part
MJ1-3501	Tube Hanger for HP5890, Shimadzu GC-17A/2010, TRACE GC, CP3800	Liquid nitrogen feed tube hanger (for HP5890, Shimadzu GC-17A/2010, TRACE GC and Varian CP3800)	1 set	
MJ1-3502	Tube Hanger for Agilent6890	Liquid nitrogen feed tube hanger (for Agilent6890)	1 set	

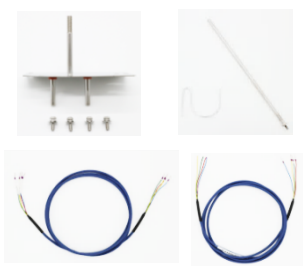
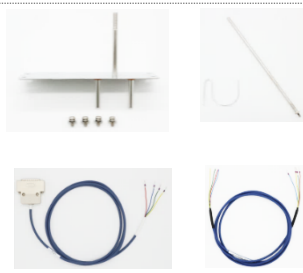
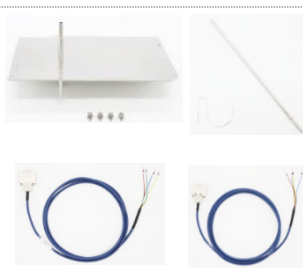

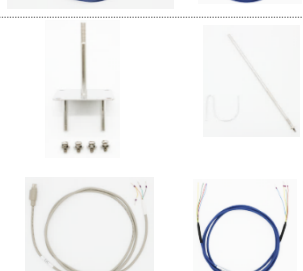
4. MicroJet Cryo-Trap (MJT-1030Ex/E, MJT-1035E)

Installation Kit (MJT-1035E)



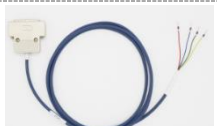

P/N (part number)	Part name	Specification	Qty	Part
MJ1-K211	MJT-1035E Installation Kit for Shimadzu GC-17A/2010	Includes support plate(MJ1-1204), tube hanger(MJ1-3501), GC remote signal cable S (MJ1-4312), and Auto sampler connection cable G (MJ1-4301)	1 set	
MJ1-K381	MJT-1035E Installation Kit (for Varian CP3800/450GC)	Includes support plate(MJ1-1208) , tube hanger(MJ1-3501), GC remote signal cable V (MJ1-4315), and Auto sampler connection cable G (MJ1-4301)	1 set	
MJ1-K780	MJT-1035E Installation Kit (for Agilent7890/6890)	Includes support plate(MJ1-1201), tube hanger(MJ1-3502), GC remote signal cable A (MJ1-4311), and Auto sampler connection cable G (MJ1-4301)	1 set	
MJ1-K811	MJT-1035E Installation Kit (for PerkinElmer Clarus GC)	Includes support plate(MJ1-1209) , tube hanger(MJ1-3501), GC remote signal cable P (MJ1-4313), and Auto sampler connection cable G (MJ1-4301)	1 set	
MJ1-K911	MJT-1035E Installation Kit (for Thermo TRACE GC Ultra)	Includes support plate (MJ1-1207), tube hanger(MJ1-3501), GC remote signal cable T (MJ1-4314), and Auto sampler connection cable G (MJ1-4301)	1 set	
MJ1-K913	MJT-1035E Installation Kit (for Thermo TRACE 1300/1310GC)	Includes support plate (MJ1-1218), Thermal insulator (MJ1-1518), GC remote signal cable T (MJ1-4314), and Auto sampler connection cable G (MJ1-4301)	1 set	

4. MicroJet Cryo-Trap (MJT-1030Ex/E, MJT-1035E)

GC Remote Signal Cable

P/N (part number)	Part name	Specification	Qty	Part
MJ1-4311	GC Remote Signal Cable A	MJT remote cable for Agilent 7890/6890	1 ea	
MJ1-4312	GC Remote Signal Cable S/P	MJT remote cable for Shimadzu 2010GC/PerkinElmer Clarus GC	1 ea	
MJ1-4314	GC Remote Signal Cable T	MJT remote cable for Thermo Fishier TRACE GC	1 ea	
MJ1-4315	GC Remote Signal Cable V	MJT remote cable for Varian CP3800/GC450	1 ea	

Miscellaneous Parts

P/N (part number)	Part name	Specification	Qty	Part
MJ1-1303	Liquid Nitrogen Feed Tube Ex	(※Refurbished assembly is available with part number MJ1-1353. Returning the defective part is required.)	1 set	
MJ1-4201	MJT Control Cable		1 ea	
MJ1-4202	MJT Signal Cable	MJT signal cable for connecting MJT-1030E/Ex, MJT-1035E with PY-3030 series	1 ea	
MJ1-4215	Short Plug B	For terminating temp. sensor input connector	1 ea	
MJ1-5501	MS (Molecular Sieve) Trap	With copper tube 1.2 m and 15µm filter	1 set	

5. Auto-Shot Sampler (AS-1020E)

Component Parts for Upper Section of Unit

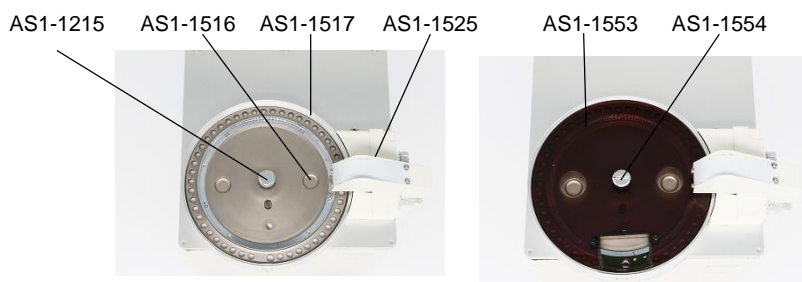









Component parts of top of Auto-Shot Sampler

P/N (part number)	Part name	Specification	Qty	Part
AS1-1551	Sample Cup Tray Set N	Includes each 1 pcs of sample cup carrousel N, sample cup tray N and securing screw	1 set	
AS1-1215	Sample Cup Tray Securing Screw	For sample cup tray N (AS1-1517) and sample cup carrousel N (AS1-1516)	1 ea	
AS1-1516	Sample Cup Carrousel N		1 ea	
AS1-1517	Sample Cup Tray N	Sample cup tray N, shiny metallic surface	1 ea	
AS1-1525	Sample Cup Recovery Chute (AS Teflon sheet)	Sample cup recovery chute equipped with AS Teflon sheet	1 ea	
AS1-1553	Sample Cup Tray Cover		1 ea	
AS1-1554	Sample Cup Tray Cover Securing Screw		1 ea	
AS1-7813	Sample Cup Recovery Container		2 ea	
AS1-7814	AS Teflon Sheet G	Teflon sheet for cup chute(3 ea) and Spare fixing screw (4 ea)	1 set	

5. Auto-Shot Sampler (AS-1020E)

Installation Kit for Major GCs

P/N (part number)	Part name	Specification	Qty	Part
AS1-K201	AS-1020E Installation Kit for Shimadzu GC-17A/2010	Supporting plate with screws (1 set), Main frame fixing screw (1 ea) and Hexagon mounting post for the main frame	1 set	
AS1-K202	AS-1020E Installation Kit for Shimadzu GC-2010 detector position	Includes AS securing plate 1ea, AS fixing washer 1ea, AS fixing screw 1ea, and AS stand (80mm) 2ea, 1 set. Installation plate (PY1-3854) is required.	1 set	
AS1-K380	AS-1020E Installation Kit for SCION GC	For Varian GC3800/Bruker SCION 430/436/450/456-GC, includes each 1 pcs of securing plate, washer and fixing screw. Stand base(PY1-1702) is required.	1 set	
AS1-K680	AS-1020E Installation Kit for Agilent 7890/6890	Supporting rod with a fixing screw (1 set) and AS securing bracket (with screws, 1ea)	1 set	
AS1-K780	AS-1020E Installation Kit 780	For Agilent 7890, used for mounting AS-1020E on the rear injection port. AS Support attachment 1 (1 ea), AS support attachment 2 (1 ea), Support attachment 2 fixing screw (1 ea) and M3x6 screws (2 ea)	1 set	
AS1-K784	AS-1020E Sideways Installation Kit for Agilent 7890	AS-1020E Sideways Installation Kit for Agilent 7890 and PY-K7894	1 set	
AS1-K902	AS-1020E Mounting Kit N for TRACE GC Ultra	Supporting rod with a fixing screw, nut and washers (1set), AS securing bracket (with screws, 1ea) and Long stand (80 mm, 2 ea)	1 set	
AS1-K904	AS-1020E Mounting Kit N for TRACE GC 1300/1310	Supporting Rod for Thermo TRACE GC 1300/1310 with a screw (1 set), AS securing bracket (with screws, 1ea) and Extension stand (40 mm ,1 ea)	1 set	







5. Auto-Shot Sampler (AS-1020E)

Miscellaneous Parts



P/N (part number)	Part name	Specification	Qty	Part
AS1-1531	Sample Cup Inspector		1 ea	
AS1-4111	Valve Control Cable	Gas reservoir valve control cable, DC24V 3 poles, 2 m	1 ea	
AS1-K040	Tubing Kit	Includes each 1 pcs of 1/8" copper tube 1.5m and 3m, 1/8" union (no ferrule), 1/8" TEE union	1 set	
PY1-EC80F	Eco-Cup LF	4 mm o.d. x H 8 mm , 80 µL, made of stainless steel	100 ea	 
PY1-3533	Interface Union ASN	Interface Union Assey for use with Auto-Shot Sampler AS-1020E	1 ea	 "V1" mark
PY1-3711	Eco-Cup Stand 10	For Eco-Cup LF and Eco-Cup G/GQ, for 10cups	1 ea	
PY1-5111	Fine Quartz Wool 2g	2 g	1 ea	
PY1-7787	Auto-Rx Disc 100	In glass vial	100 ea	 
PY1-7788	Auto-Rx Disc 300	In glass vial	300 ea (100 x 3 vials)	 

6. Carrier Gas Selector (CGS-1050Ex)

Tubing Kit



P/N (part number)	Part name	Specification	Qty	Part
CG1-1700	CGS Tubing Kit for Shimadzu GC-17A	CGS-1050Ex tubing kit for Shimadzu GC-17A	1 set	
CG1-2010	CGS Tubing Kit for Shimadzu GC-2010	CGS-1050Ex tubing kit for Shimadzu GC-2010	1 set	
CG1-3800	CGS Tubing Kit for Varian GC3800/450	CGS-1050Ex tubing kit for Varian GC3800/450	1 set	
CG1-5800	CGS Tubing Kit for PerkinElmer Clarus 580/680	CGS-1050Ex tubing Kit for PerkinElmer Clarus 580/680	1 set	
CG1-6800	CGS Tubing Kit for Agilent GC7890/6890	CGS-1050Ex tubing kit for Agilent GC7890/6890	1 set	
CG1-9001	CGS Tubing Kit for TRACE GC Ultra	CGS-1050Ex tubing kit for TRACE GC Ultra	1 set	
CG1-9003	CGS Tubing Kit for TRACE 1300/1310GC	CGS-1050Ex tubing kit for TRACE 1300/1310GC	1 set	

Miscellaneous Parts



P/N (part number)	Part name	Specification	Qty	Part
CG1-4020	CGS Valve Control Cable	CGS-1050Ex valve control cable for PY-3030D/S	1 ea	
PY1-7001	AC Power Cable 100V for UL standard	AC power cable 100-120V for UL standard	1 ea	

7. Micro UV Irradiator (UV-1047Xe)





UV Light Source Lamp

P/N (part number)	Part name	Specification	Qty	Part
UV1-7105	Xenon Arc Lamp (contains Hg)		1 ea	
UV1-7106	Xenon Arc Lamp (contains no Hg)		1 ea	

UV Sampler Parts

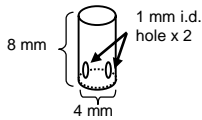
P/N (part number)	Part name	Specification	Qty	Part
UV1-3801	UV Sampler		1 ea	 *UV fiber Xe is not included
UV1-3802	UV Sampler Stand	Stand for UV sampler	1 ea	
UV1-7012	UV Fiber Xe		1 ea	

Miscellaneous Parts





P/N (part number)	Part name	Specification	Qty	Part
PY1-EC80UV	Eco-Cup UV	Flow through type, 1 mm i.d. hole at both sides, 4 mm o.d. x H 8 mm , 80 μ L	20 ea	  1 mm i.d. hole x 2 8 mm 4 mm
PY1-7802	Communication Cable	RS-232C, D-sub 9 pins, female, reverse	1 ea	
UV1-K001	UV Tube Kit	A set of Air Tube Set (UV1-K101) and Extension Tube Set (UV1-K104)	1 set	
UV1-K101	Air Tube Set	Includes each 1 of 1/8" copper tube (3 m), 1/8" union, 1/8"nut, back ferrule and front ferrule	1 set	

7. Micro UV Irradiator (UV-1047Xe)

Miscellaneous Parts

P/N (part number)	Part name	Specification	Qty	Part
UV1-K104	Extension Tube Set	Includes each 2 of 1/16" stainless steel tube(1.5 m) and union sets for carrier gas connection	1 set	
UV1-4001	Polystyrene sample for UV Irradiator Performance Evaluation	3 mm diameter disc	30 ea	
UV1-4201	UV Sampler Adjusting Tool		1 ea	
UV1-7108	Fiber Clamp A		1 ea	
UV1-7201	Dewar 350	Liquid nitrogen container, 350 mL	1 ea	
UV1-7501	Dewar Holder	Holder to prevent the liquid nitrogen container fall	1 ea	
UA1-30M-0.5F	Ultra ALLOY® Capillary column	dimethyl polysiloxane, 0.25mm id, 30m, 0.5um	1 ea	

7. Micro UV Irradiator (UV-1048E)

P/N (part number)	Part name	Specification	Qty	Part
PY1-7001	AC Power Cable 100V for UL standard	AC power cable 100-120V for UL standard	1 ea	
UV1-7015	UV Fiber bundle	For UV-1048E	1 ea	
UV1-7016	UV Fiber bundle connector	For UV-1048E	1 ea	
UV1-7017	Sample Holder 18	For UV-1048E	1 ea	

8. micro-Reactor (Rx-3050TR, Rx-3050SR)

1st and 2nd Reactor furnace parts

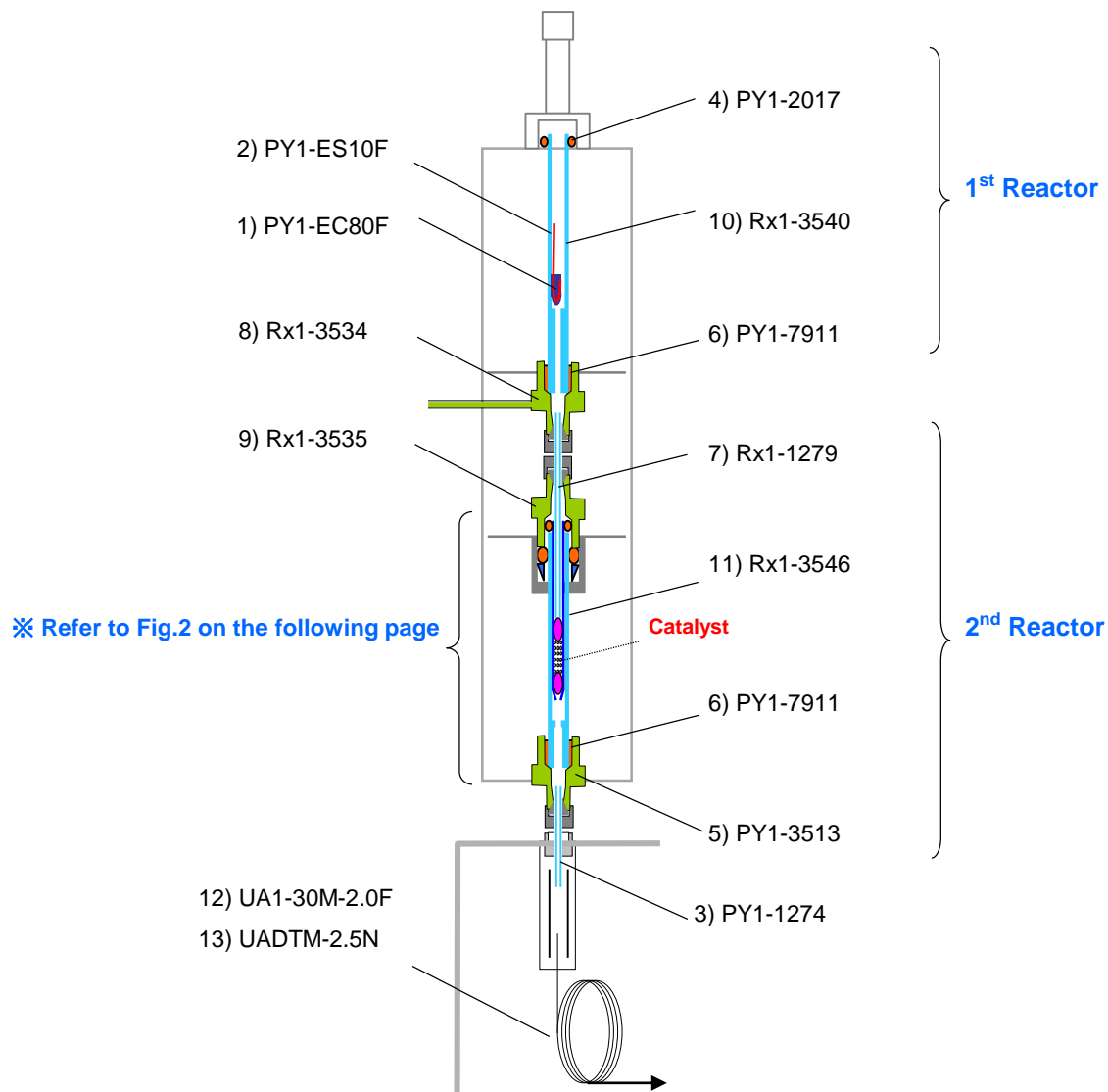

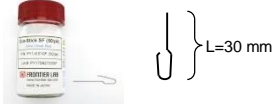













Fig.1 Visual list of consumables

8. micro-Reactor (Rx-3050TR, Rx-3050SR)

No.	P/N (part number)	Part name	Specification	Qty	Part
1	PY1-EC80F	Eco-Cup LF	4 mm o.d. x H 8 mm , 80 μ L, made of stainless steel	100 ea	
2	PY1-ES10F	Eco-Stick SF	For stainless steel Eco-Cups, L 30 mm , for Single-shot	50 ea	
3	PY1-1274	ITF Needle Set N	Deactivated needle for PY-3030, PY-2020 and Rx-3050	3 ea	
4	PY1-2017	O-ring P-6W	Translucent silicon rubber	20 ea	
5	PY1-3513	ITF Union N	With nut	1 ea	
6	PY1-7911	Graphite Vespel Ferrule	6 mm hole i.d., for interface	5 ea	
7	Rx1-1279	Rx ITF Needle B Set	1/16" o.d., with nut and ferrule	3 ea	
8	Rx1-3534	Rx ITF Union A	With reaction gas feed tube	1 ea	
9	Rx1-3535	Rx ITF Union B	1/16" – 1/4"	1 ea	
10	Rx1-3540	Rx Deactivated SS Tube A	For Tandem/Single micro reactor, 6 mm o.d., 120 mm length, deactivated stainless steel	1 ea	
11	Rx1-3546	Rx Deactivated SS Tube B	For 2nd reactor of Tandem micro reactor, 6 mm o.d., 120 mm length, deactivated stainless steel	1 ea	
12	UA1-30M-2.0F	Ultra ALLOY® Capillary Column	dimethylpolysiloxane, 30 m, 0.25 mm i.d., 2.0 μ m	1 ea	
13	UADTM-2.5N	EGA Capillary Tube	For Evolved gas analysis, 2.5 m , 0.15 mm i.d.	1 ea	

8. micro-Reactor (Rx-3050TR, Rx-3050SR)

1st and 2nd Reactor furnace parts

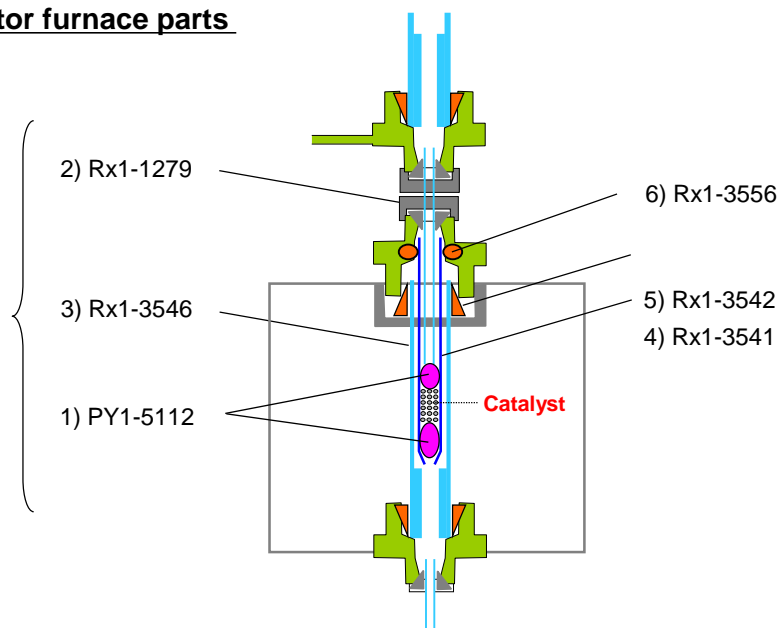







Fig. 2 Visual list of consumables



No.	P/N (part number)	Part name	Specification	Qty	Part
1	PY1-5112	Fine Quartz Wool 0.5g	0.5 g	1 ea	
2	Rx1-1279	Rx ITF Needle B Set	1/16" o.d., with nut and ferrule	3 ea	
3	Rx1-3546	Rx Deactivated SS Tube B	For 2nd reactor of Tandem micro reactor, 6 mm o.d., 120 mm length, deactivated stainless steel	1 ea	
4	Rx1-3541	Rx Blank Quartz Insert A	3 mm i.d., 4 mm o.d., x L78 mm	5 ea	
5	Rx1-3542	Rx ZMS-5 Quartz Insert A	3 mm i.d., 4 mm o.d., x L 78 mm	1 ea	
6	Rx1-3556	High temperature- resistant O-ring (S4)	Fluorine rubber, Black	10 ea	

8. micro-Reactor (Rx-3050TR, Rx-3050SR)

1st Reactor furnace parts (others)

P/N (part number)	Part name	Specification	Qty	Part
PY1-1036	Liquid Injection Sampler A	Liquid sampler for all pyrolyzers and micro reactors	1 ea	
PY1-3631	Storage Stand 30A	One piece type	1 ea	
Rx1-1040	High Pressure Solid Sampler	For Rx-3050HP /MP, for high /medium pressure	1 ea	
Rx1-2023	High Pressure Solid Sampler Stand		1 ea	
Rx1-2501	Rx Tandem Reactor Cover A		1 ea	
Rx1-3579	Rx Heat Sink Adapter Set B	For Tandem micro reactor, Heat Sink Adapter Set	1 set	

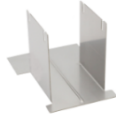
2nd Reactor furnace parts (others)

P/N (part number)	Part name	Specification	Qty	Part
PY1-3563	ITF Cover 3030A	Interface cover for EGA/PY-3030D, PY-3030S, Rx-3050TR, Rx-3050SR, includes set screw(3ea)	1 set	
PY1-3631	Storage Stand 30A	One piece type	1 ea	
Rx1-2504	Rx Interface Cover B	For Tandem micro reactor, Cover for interface between 1st and 2nd reactor	1 ea	

8. micro-Reactor (Rx-3050TR, Rx-3050SR)

Controller parts

P/N (part number)	Part name	Specification	Qty	Part
PY1-3751	USB Cable Fixing Bracket		1 ea	
PY1-6034	Noise Filter for AC Power Cable		1 ea	
PY1-7001	AC Power Cable 100V for UL standard	100 – 120V	1 ea	
PY1-7002	AC Power Cable 200V for VDE standard	200 – 240V	1 ea	
PY1-7612	Cooling Gas Tube	For cooling gas, 4 mm o.d., 2 mm i.d., 1.5 m, 1 ea, *refer to PY1-7801(Cooling Gas Connecting Tube) if a quick connector is required.	1 ea	
PY1-7613	Cooling Gas Tube	With restrictor, 1.5 m	1 ea	
PY1-7614	Nylon tube branching adapter	For Tandm micro reactor cooling gas franching, 3-way, 4 mm o.d. Nylon tube	1 ea	
PY1-7801	Cooling Gas Connecting Tube	With one-touch connector and 1/8 Swagelok female, 1.5 m	1 ea	
PY1-7805	USB Cable	2 m, type A male – type B male	1 ea	
Rx1-7806	1 st Reactor Control Cable	1.5 m	1 ea	
Rx1-7808	Tandem micro-Reactor Control Cable	1.5 m	1 ea	

8. micro-Reactor (Rx-3050TR, Rx-3050SR)

P/N (part number)	Part name	Specification	Qty	Part
PY1-EH10AL	Eco-Stand AL	Eco-Cup stand for 1 cup, for all Eco-Cups, made of aluminum	5 ea	
PY1-EP55F	Eco-Pickup F	For stainless steel Eco-Cup recovery, L 135 mm	5 ea	
PY1-2025	Septum	For liquid sampler	20 ea	
PY1-3563	Interface Cover 3030A	Interface cover for EGA/ PY-3030D, PY-3030S, Rx-3050TR, Rx-3050SR, includes set screw (3 ea)	1 set	
PY1-7131	Level Vial		1ea	
PY1-7618	Furnace purge gas restrictor B	Stainless tube (0.47 mm o.d., 0.15 mm i.d, 1.0 m) 1 ea, 1/16-1/8 Swagelok union 2 ea, inlet/outlet septum 1 ea, banding band 2 ea, purge gas holder	1 set	
Rx1-K033	Rx Piping Kit A	1/16" SS tube (0.8 mm i.d., 1.5m), 1/8 swagelok union (brass,1ea), 1/8 swagelok nut (brass, 3ea), 1/8 swagelok back ferrule (brass,3ea) and rubber seal with hole (3ea)	1 set	
UV1-7201	Dewar 350	Liquid nitrogen container, 350 mL	1 ea	
UV1-7501	Dewar Holder	Holder to prevent the liquid nitrogen container fall	1 ea	

8. micro-Reactor (Rx-3050TR)

Rx Consumable Parts Set

Rx Consumable Parts Set TR

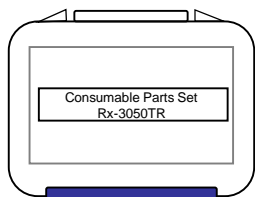

P/N: Rx1-K040TR

For Tandem micro-Reactor Rx-3050TR,

1 set

Contents of Rx Consumable Parts Set TR	Qty
1) ITF Needle Set N	3 ea
2) O-ring P-6W	5 ea
3) Fine Quartz Wool (0.5g)	1 ea
4) Graphite Vespel Ferrule	10 ea
5) Rx ITF Needle B Set	3 ea
6) Rx Deactivated SS Tube A	3 ea
7) Rx Blank Quartz Insert A	10 ea
8) High temperature-resistant O-ring S4	10 ea

※ Use the following part numbers when ordering the parts individually. The quantities of each parts may differ from the Consumable Parts Set. The quantities of the parts contained in the Consumable Parts Set are shown in the list above.

No.	P/N (part number)	Part name	Specification	Qty	Part
1	PY1-1274	ITF Needle Set N	Deactivated needle for PY-3030, PY-2020 and Rx-3050	3 ea	
2	PY1-2017	O-ring P-6W	Quartz pyrolysis tube seal for EGA/PY-3030D, silicon rubber, white, usable temp. range -50 to 200 C	20 ea	
3	PY1-5112	Fine Quartz Wool, 0.5g	0.5 g	1 ea	
4	PY1-7911	Graphite Vespel Ferrule	Graphite vespel ferrule, 6mm hole i.d., for quartz pyrolysis tube	5 ea	
5	Rx1-1279	Rx ITF Needle B Set	For Tandem micro reactor, Rx ITF needle B, o.d.1/16", with nut-ferrule	3 ea	
6	Rx1-3540	Rx Deactivated SS Tube A	For Tandem/Single micro reactor, 6 mm o.d., 120 mm length, deactivated stainless steel	1 ea	
7	Rx1-3541	Rx Blank Quartz Insert A	3 mm i.d., 4 mm o.d., x L 78 mm	5 ea	
8	Rx1-3556	High temperature-resistant O-ring (S4)	Fluorine rubber, black	10 ea	

8. micro-Reactor (Rx-3050SR)

Rx Consumable Parts Set

Rx Consumable Parts Set SR

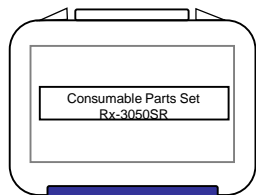

P/N: Rx1-K040SR

For Single micro-Reactor Rx-3050SR,
1 set

Contents of Rx Consumable Parts Set SR		Qty
1)	ITF Needle Set N	3 ea
2)	Fine Quartz Wool 0.5g	1 ea
3)	Graphite Vespel Ferrule	5 ea
4)	Rx Deactivated SS Tube A	3 ea
5)	Rx Blank Quartz Insert A	10 ea
6)	O-ring P6	10 ea
7)	High temperature-resistant O-ring (S4)	10 ea

※ Use the following part numbers when ordering the parts individually. The quantities of each parts may differ from the Consumable Parts Set. The quantities of the parts contained in the Consumable Parts Set are shown in the list above.

No.	P/N (part number)	Part name	Specification	Qty	Part
1	PY1-1274	ITF Needle Set N	Deactivated needle for PY-3030, PY-2020 and Rx-3050	3 ea	
2	PY1-5112	Fine Quartz Wool 0.5g	0.5 g	1 ea	
3	PY1-7911	Graphite Vespel Ferrule	6 mm hole i.d., for interface	5 ea	
4	Rx1-3540	Rx Deactivated SS Tube A	6 mm i.d. x L 120 mm	1 ea	
5	Rx1-3541	Rx Blank Quartz Insert A	3 mm i.d., 4 mm o.d., x L 78 mm	5 ea	
6	Rx1-3551	O-ring P6	Fluorine rubber, black	10 ea	
7	Rx1-3556	High temperature-resistant O-ring (S4, black)	Fluorine rubber, black	10 ea	

7. micro-Reactor (Rx-3050TR, Rx-3050SR)

Vent-free GC/MS Adapter

Vent-free GC/MS Adapter N-50

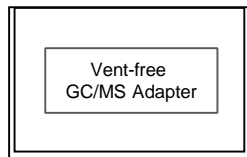







P/N: MS402280

For Agilent, Shimadzu, JEOL and Thermo TRACE1300/1310, 1 set

Contents of MS402280		Qty
1)	Plug Nut B	1 set
2)	VF Metal Ferrule D	10 ea
3)	VF Tube N-50	2 ea
4)	VF Holder N	1 ea
5)	VF Nut B	1 ea
6)	VF Nut C	1 ea
7)	Column Nut	2 ea
8)	Operation Manual	1 ea

※ Use the following part numbers when ordering the parts individually. The quantities of each parts may differ from the Vent-free GC/MS Adapter N-50. The quantities of the parts contained in the Vent-free GC/MS Adapter N-50 are shown in the list above.

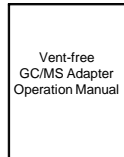
No.	P/N (part number)	Part name	Specification	Qty	Part
1	MS402168	Plug Nut B	Use to plug the VF tube	1 set	
2	MS402167	VF Metal Ferrule D	VF Metal Ferrule D for column connection	20 ea	
3	MS402200	VF Tube N-50	Includes Vent-free tube N (0.15 mm id / 50 cm, 1 ea), VF spacer, VF metal ferrule D (2 ea), VF nut B and VF nut C	1 set	
4	MS402210	VF Holder N	Use with VF Tube N, consists of holder and fixing bracket	1 set	
5	MS402286	VF Nut B	For the interface between MS and VF tube	3 ea	
6	MS402287	VF Nut C	For the interface between VF Holder N and VF tube	3 ea	
7	MS604234	Column Nut		1 ea	
8	-	Operation Manual	※Not for sale. This can be downloaded from Frontier Lab's website for free.	-	

8. micro-Reactor (Rx-3050TR, Rx-3050SR)

Vent-free GC/MS Adapter

Vent-free GC/MS Adapter N-70

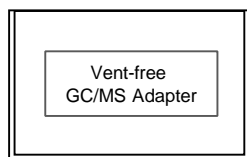









P/N: MS402290

For Thermo TRACE Ultra and Focus GC, 1 set

Contents of MS402290		Qty
1)	Plug Nut B	1 set
2)	VF Metal Ferrule D	10 ea
3)	VF Nut 1/16	1 ea
4)	VF Tube N-70	2 ea
5)	VF Holder N	1 ea
6)	VF Nut C	1 ea
7)	Column Nut	2 ea
8)	Graphite Vespel Ferrule 05	1 ea
9)	Operation Manual	1 ea

※ Use the following part numbers when ordering the parts individually. The quantities of each parts may differ from the Vent-free GC/MS Adapter N-70. The quantities of the parts contained in the Vent-free GC/MS Adapter N-70 are shown in the list above.

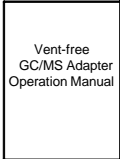
No.	P/N (part number)	Part name	Specification	Qty	Part
1	MS402168	Plug Nut B	Use to plug the VF tube	1 set	
2	MS402167	VF Metal Ferrule D	VF Metal Ferrule D for column connection	20 ea	
3	MS402184	VF Nut 1/16	For connecting VF tube to Bruker/Thermo MS interface. 1/16 Swagelok, stainless	5 ea	
4	MS402201	VF Tube N-70	Includes Vent-free tube N (0.15 mm id / 70 cm, 1 ea), VF spacer, graphite vespel ferrule, VF metal ferrule, 1/16 nut (SS) and VF nut C For Thermo Fisher MS	1 ea	
5	MS402210	VF Holder N	Use with VF Tube N, consists of holder and fixing bracket	1 set	
6	MS402287	VF Nut C	For the interface between VF Holder N and VF tube	3 ea	
7	MS604234	Column Nut		1 ea	
8	PY1-7971	Graphite Vespel Ferrule 05	0.5 mm hole i.d.	10 ea	
9	-	Operation Manual	※Not for sale. This can be downloaded from Frontier Lab's website for free.	1 ea	

8. micro-Reactor (Rx-3050TR, Rx-3050SR)

Tool Set





Rx Tool Set A P/N: Rx1-K050, 1 set

Contents of Rx Tool Set A	Qty
1) Hex Screw Driver 2	1 ea
2) Hex Screw Driver 2.5	1 ea
3) Tweezers	1 ea
4) Double Head Wrench (12/13 mm)	1 ea
5) Double Head Wrench (6/8 mm)	2 ea

Rx Tool Set B P/N: Rx1-K051, 1 set

Contents of Rx Tool Set B	Qty
1) Hex Screw Driver 2	1 ea
2) Tweezers	1 ea
3) Double Head Wrench (12/13 mm)	1 ea
4) Double Head Wrench (6/8 mm)	2 ea

※ Use the following part numbers when ordering the parts individually. The quantities of each parts may differ from the Rx Tool Set. The quantities of the parts contained in the Rx Tool Set are shown in the list above.

No.	P/N (part number)	Part name	Specification	Qty	Part
1	PY1-7111	Hex Screw Driver (2 mm)	2.0 mm	1 ea	
2	PY1-7113	Hex Screw Driver (2.5 mm)	2.5 mm	1 ea	
3	PY1-7141	Tweezers	L 125 mm	1 ea	
4	Rx1-3531	Double Head Wrench (12/13 mm)	12/13 mm	1 ea	
5	Rx1-3532	Double Head Wrench (6/8 mm)	6/8 mm	1 ea	