

Solutions for
Food Development

Application Notebook



Facile quantitation of fundamental components

Simultaneous Analysis of Water-Soluble Vitamins by Newly Developed "Shim-pack MAqC-ODS I" Column

Newly developed "Shim-pack MAqC-ODS I" column is used to conduct simultaneous analysis of water-soluble vitamins without the addition of ion-pair reagents to the mobile phase.

Analysis of Sugars in Orange Juice and Grape Juice by Prominence-i and Differential Refractive Index Detector

We introduce an example of sugar analysis in juices using the Prominence-i with the RID-10A.

Analysis of Sugars and Sugar Alcohols in Energy Drink by Prominence-i with Differential Refractive Index Detector

We introduce an example of simultaneous analysis of sugars and sugar alcohols in an energy drink using the Prominence-i and RID-20A.

Analysis of Oligosaccharides in Japanese Sake Using an Evaporative Light Scattering Detector

We introduce an example of analysis of oligosaccharides in Japanese sake using the Nexera-i with ELSD-LTII evaporative light scattering detector.

Analysis of Low Molecular Weight Soluble Dietary Fiber by Prominence-i

This article describes an analysis of the amount of low molecular weight soluble dietary fiber by an enzymatic-HPLC method, based on the Food Labeling Standards.

Simultaneous Analysis of Nine Sweeteners Using Triple Quadrupole LC-MS/MS (LCMS-8040)

This article presents a simultaneous analysis of nine sweeteners including both specified additives and unspecified additives, using the LCMS-8040.

Simultaneous Analysis of 16 Sweeteners Using Triple Quadrupole LC-MS/MS

In this article, we introduce an example of simultaneous analysis of 16 sweeteners using an LCMS-8050.

Analysis of Histamine and Tyramine Using Prominence Amino Acid Analysis System

We introduce an example of analysis of tyramine and histamine using the Prominence Amino Acid Analysis System, in which detection is conducted using post-column fluorescence derivatization.

Aroma Component Analysis of Japanese Sake by GC-FID Using a Diacetyl Derivatizing Reagent

We introduce an example analysis of aroma components in Japanese sake with a simple GC system configuration using a simplified pretreatment method.

A Comparison Study of Different Capillary Columns for Analysis of Alcohol Congeners in Alcoholic Beverages

In this study, four capillary columns are selected and their performance are compared with packed column in terms of separation of all key components found in alcoholic beverages.

Nexis GC-2030 Next Industry Standard [Flyer]

In-depth analysis of targeted class of compounds

Comprehensive Two-Dimensional Analysis of Polyphenols in Red Wine Using Nexera-e Coupled with SPD-M30A

The Nexera-e comprehensive two-dimensional liquid chromatograph was applied to the analysis of polyphenols in red wine.

Comprehensive 2D Separation of Triglycerides in Vegetable Oil with ELSD/LCMS-IT-TOF Detection

A combination of an evaporative light scattering detector and an ion trap time-of-flight mass spectrometer was used to analyze triglycerides in vegetable oil.

Comprehensive 2D Separation of Carotenoids in Red Chili Pepper by the Nexera-e System

The carotenoids extracted from red chili pepper were analyzed using Nexera-e with PDA and MS detectors.

Comprehensive Two-Dimensional Liquid Chromatograph - Nexera-e Catch the Peaks Behind the Peaks - [Flyer]

Developing a Chiral Amino Acid Analysis Method That Uses Column Switching

This article introduces a rapid analysis method that employs chiral columns to achieve high separation and high sensitivity and that dispenses with derivatization.

Analysis of Chiral Amino Acids within Fermented Beverages Utilizing a Column Switching System

This article introduces an example analysis of fermented beverages using a column switching system which alternates between two types of chiral columns using high-pressure column switching valves.

LC/MS/MS Method Package for D/L Amino Acids [Flyer]

Comprehensive multi-component analysis

Investigating Food Quality Evaluation: Complete Analysis of Aroma Compounds and Metabolites in Food

This Application News presents the results of an experiment that set out to measure aroma compounds and metabolites present in sake, and investigated which of these compounds could be used to distinguish between different sake types.

Comprehensive Analysis of Primary and Secondary Metabolites in Citrus Fruits Using an Automated Method Changeover UHPLC System and LC-MS/MS System

In this article, we describe a method of performing comprehensive analysis of primary and secondary metabolites in food (major organic acids, amino acids, sugars, carotenoids, and flavonoids) using LC-MS/MS.

Application of Metabolomics to Microbial Breeding

In this article, we discuss an example of LC/MS analysis of how the sulfur-containing metabolites vary during culture of a cysteine-producing *Escherichia coli* (*E. coli*) when either thiosulfuric acid or sulfuric acid is added as the sulfur source during cysteine synthesis.

Multi-Component Analysis of Five Beers

In this article, we describe the simultaneous analysis of five commercially available beers with a triple quadrupole mass spectrometer (LCMS-8060) using a primary metabolite method package, and performing principal component analysis on the data set obtained using Traverse™ MS software.

Liquid Chromatograph Mass Spectrometer - LCMS-8060 [Flyer]

Untargeted profiling

Differentiating Olive Oils Using UV-VIS Spectrophotometer and Spectrofluorophotometer

This article describes an attempt to differentiate between these two olive oil types by spectrum measurement using Shimadzu UV-2700 UV-VIS spectrophotometer and RF-6000 spectrofluorophotometer, then performing multivariate analysis.

Application News

No. L459

High Performance Liquid Chromatography

Simultaneous Analysis of Water-Soluble Vitamins by Newly Developed "Shim-pack MAqC-ODS I" Column

Vitamins play vital roles in the metabolic activities of the body. However, because they cannot be synthesized in sufficient quantities in the body, if at all, they must be ingested either in our meals or by other means, such as tablets.

Vitamins can be classified into two groups, water-soluble and fat-soluble, and their analysis is generally conducted by high-performance liquid chromatography. Of the two types of vitamins, the water-soluble type consists mainly of highly polar basic components which exhibit weak retention in analysis by reversed-phase liquid chromatography. Since they exhibit weak retention, the analysis is typically conducted using ion-pair reagents.

Using ion-pair reagents can be challenging because of the longer analysis time, widening of slow eluting peaks, difficulty in obtaining sufficient sensitivity and long equilibration times. Analysis efficiency is also compromised due to additional work-flow requirements, such as mobile phase preparation and column conditioning.

Here, we introduce an example in which the newly developed "Shim-pack MAqC-ODS I" column is used to conduct simultaneous analysis of water-soluble vitamins without the addition of ion-pair reagents to the mobile phase.

■ Overview of Shim-pack MAqC-ODS I

The Shim-pack MAqC-ODS I column is a reversed-phase column packed with a silica gel containing metal and an added octadecylsilyl (ODS) group. In addition to the hydrophobic interaction effect provided by the ODS, the metal content effectively contributes by providing cation-exchange effects. This enhances the retention of basic compounds, thereby permitting analysis using a conventional buffer instead of an ion-pair reagent such as sodium alkyl sulfonate (e.g. sodium 1-hexanesulfonate), which is required when conducting ion-pair chromatography.

It is difficult to improve throughput in ion-pair chromatography due to the time required for reequilibration following gradient elution. While on the other hand, in isocratic elution, sensitivity is compromised due to peak broadening from slow eluting substances. Thus, its application to simultaneous analysis is not always appropriate.

Use of the Shim-pack MAqC-ODS I permits the retention of highly polar basic compounds without the use of ion-pair reagents, thereby making it possible to apply gradient elution. As a result, simultaneous analysis of highly polar basic compounds and other components can be achieved while shortening the analysis time and improving sensitivity.

These features demonstrate the powerful advantages of this column for simultaneous analysis of water-soluble vitamins, as well as impurities in pharmaceutical products that contain large quantities of basic compounds.

■ Analysis of Standard Solution

A standard solution was prepared following the procedure outlined in Fig. 1. As folic acid, riboflavin, and biotin are only slightly soluble in water, they were first dissolved in dilute alkali solution, and then dissolved in 10 mmol/L phosphate buffer (sodium) solution (pH 2.6). The standard solution was adjusted to obtain concentrations of 20 mg/L each.

An example of analysis using the Shim-pack MAqC-ODS I is shown in Fig. 2, and the analytical conditions used are shown in Table 1. For comparison, analysis was conducted using a typical ODS column with mobile phase that was spiked with an ion-pair reagent. Those analysis results are shown in Fig. 3, and the analytical conditions are shown in Table 2.

The results using the Shim-pack MAqC-ODS I demonstrate that the analysis time can be shortened due to the use of gradient analysis. Furthermore, even the late eluting substances show sharp peaks.

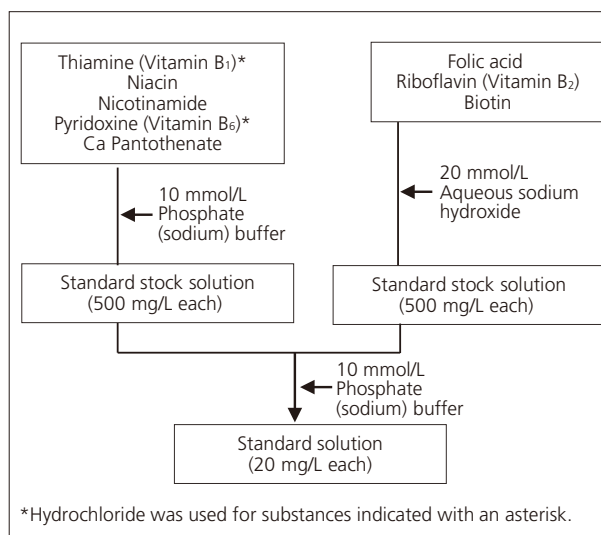

Fig. 1 Standard Solution Preparation

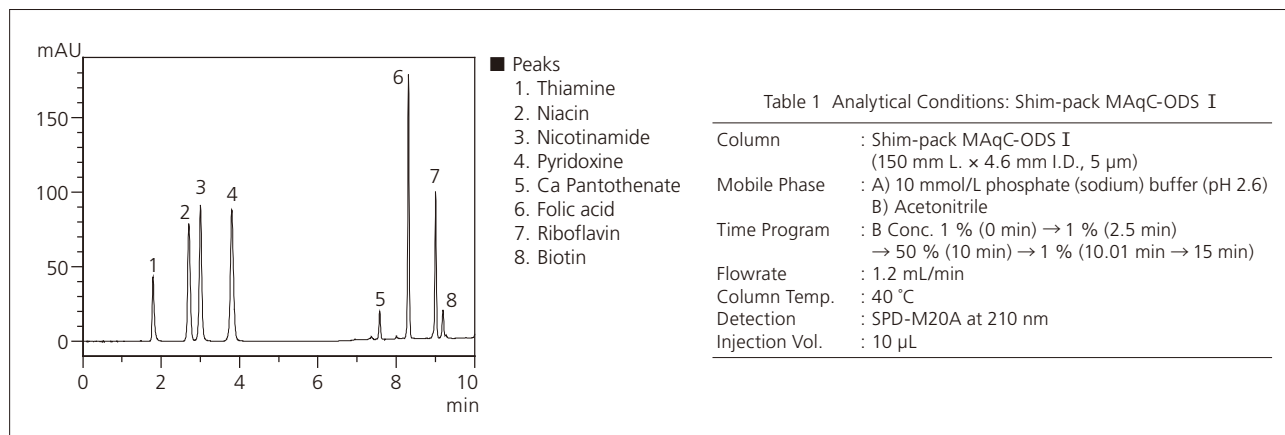

Fig. 2 Chromatogram of Standard Mixture of 8 Water-Soluble Vitamins (Shim-pack MAQc-ODS I)

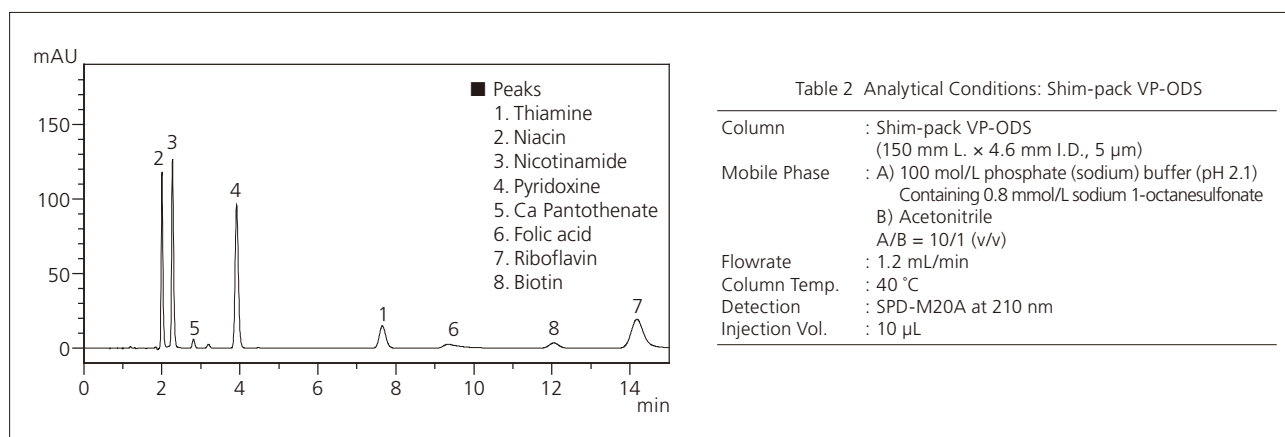

Fig. 3 Chromatogram of Standard Mixture of 8 Water-Soluble Vitamins (Shim-pack VP-ODS)

■ Analysis of Multivitamin Tablet

Fig. 5 shows a chromatogram of a multivitamin tablet that was analyzed using the Shim-pack MAQc-ODS I column. The analytical conditions were the same as those shown in Table 1. Sample preparation was conducted according to the procedure outlined in Fig. 4.

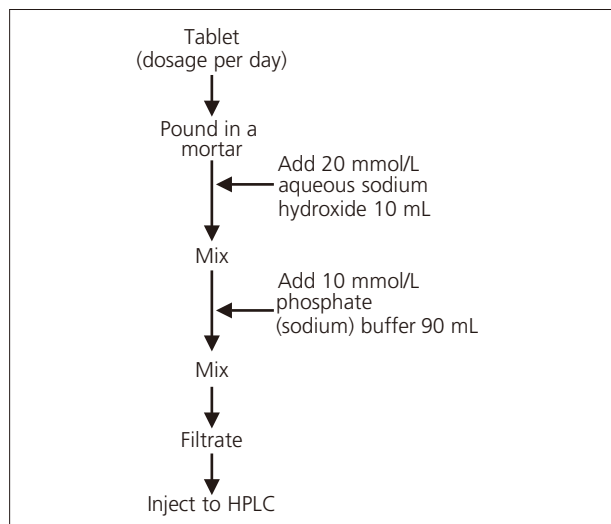

Fig. 4 Sample Preparation Procedure

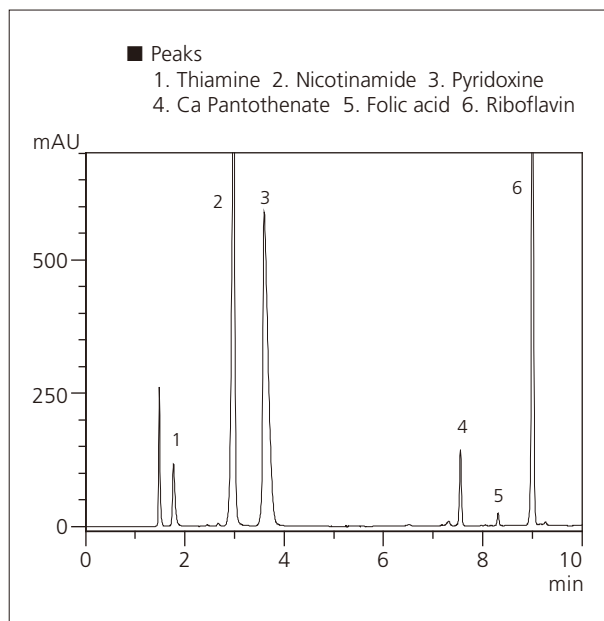

Fig. 5 Chromatogram of Multivitamin Tablet

The Shim-pack MAQc-ODS I was developed jointly with Eisai Co., Ltd.

Application News

No.L467

High Performance Liquid Chromatography

Analysis of Sugars in Orange Juice and Grape Juice by Prominence-i and Differential Refractive Index Detector

As sugars display little ultraviolet absorption, a differential refractive index detector or an evaporative light scattering detector is used for their detection.

The new Prominence-i integrated high-performance liquid chromatograph can be connected to the RID-10A differential refractive index detector. Since the column oven can accommodate a 30-cm column for use in sugar analysis (ligand exchange column), and the temperature can be controlled up to 85 °C, it therefore supports applications that require a long column and high column temperature.

Here, we introduce an example of sugar analysis in juices using the Prominence-i with the RID-10A.

■ Analysis of Sugar Standard Solution

Fig. 1 shows the results of analysis of a standard mixture of four sugars (maltotriose, sucrose, glucose, fructose) using a 10 µL injection (each at 20 g/L). The analytical conditions were as shown in Table 1. For the analytical column, we used the Shim-pack SCR-101N, a specialized sugar-analysis column that supports both the gel filtration and ligand exchange modes.

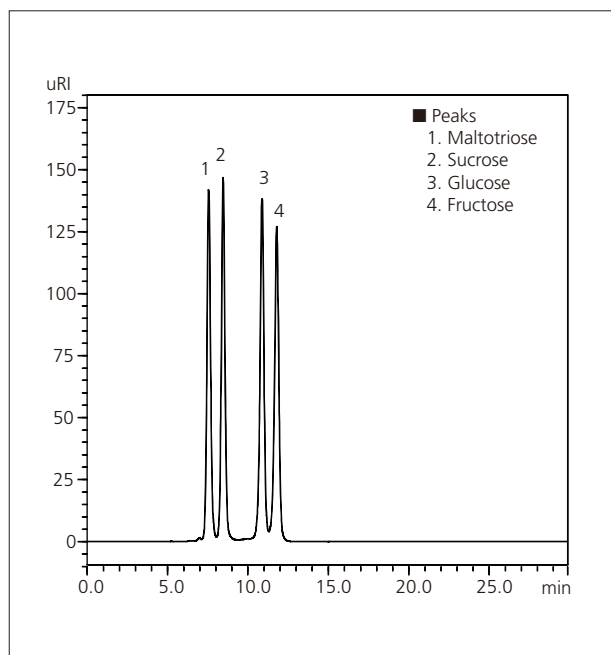

Fig. 1 Chromatogram of a Standard Mixture of Four Sugars (20 g/L each, 10 µL injected)

Table 1 Analytical Conditions

Column	: Shim-pack SCR-101N (300 mm L. × 7.9 mm I.D., 10 µm)
Mobile Phase	: Water
Flowrate	: 0.6 mL/min
Column Temp.	: 80 °C
Injection Volume	: 10 µL
Detection	: RID-10A
	Polarity +, Cell temp. 40 °C, Response 1.5 sec

■ Linearity

Fig. 2 shows the linearity obtained using the conditions listed in Table 1. Calibration curves were generated for the four sugars using concentrations ranging from 0.4 to 20 g/L, and the mean area value obtained from each set of the three repeat measurements. Excellent linearity was obtained, with a coefficient of determination greater than $R^2=0.9999$ for all of the substances.

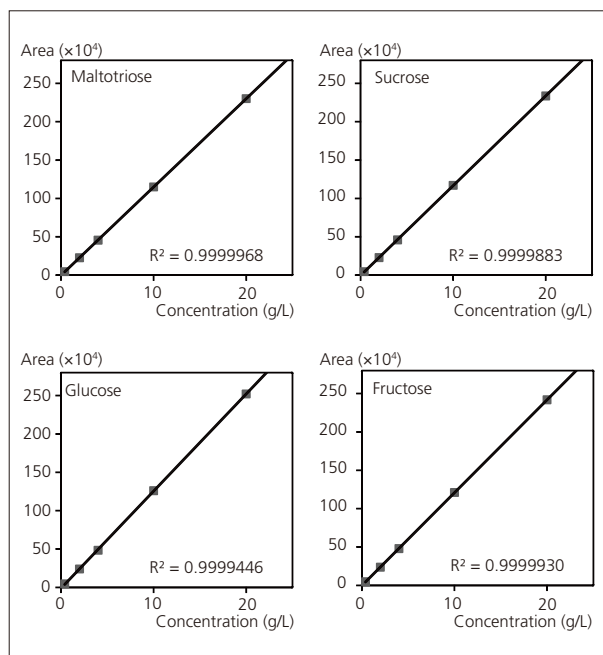

Fig. 2 Calibration Curves of a Standard Mixture of 4 Sugars (0.4 - 20 g/L, 10 µL injected)

■ Analysis of Orange Juice

Fig. 3 and 4 show the chromatograms obtained from analysis of Orange Juice A and Orange Juice B, respectively. Both Orange Juice A and B were diluted with water to obtain 10-fold dilutions, respectively, and after filtering the solutions through a 0.2 μm membrane filter, 10 μL each was injected. The analytical conditions used were the same as those shown in Table 1. Sucrose, glucose and fructose were detected in both types of orange juice. Table 2 shows the content values for the respective sugars detected in the juices.

Table 2 Content of Each Sugar in Orange Juices

	Content (g/L)	
	Orange juice A	Orange juice B
Sucrose	36	36
Glucose	25	28
Fructose	27	34

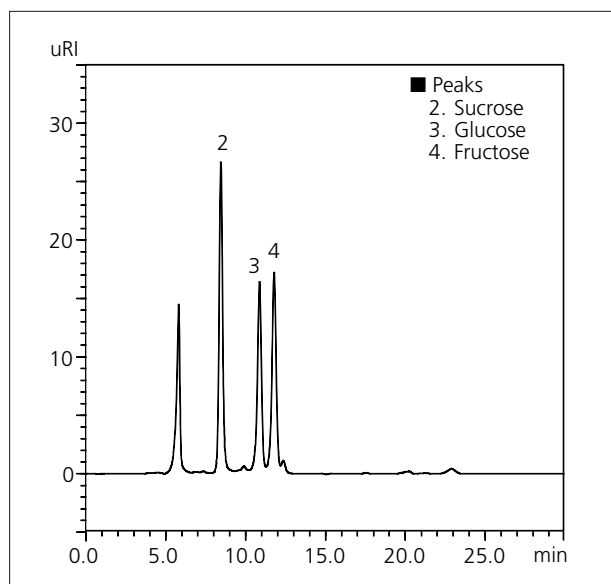

Fig. 3 Chromatogram of Orange Juice A (10 μL injected)

■ Analysis of Grape Juice

Fig. 4 shows a chromatogram obtained from analysis of grape juice. The grape juice was diluted with water to obtain a 10-fold dilution, and after filtering the solution through a 0.2 μm membrane filter, 10 μL of the prepared sample was injected. The analytical conditions used were the same as those shown in Table 1. Glucose and fructose were detected in the grape juice. Table 3 shows the content values of the detected sugars.

Table 3 Content of Each Sugar in Grape Juice

	Content (g/L)
Glucose	50
Fructose	56

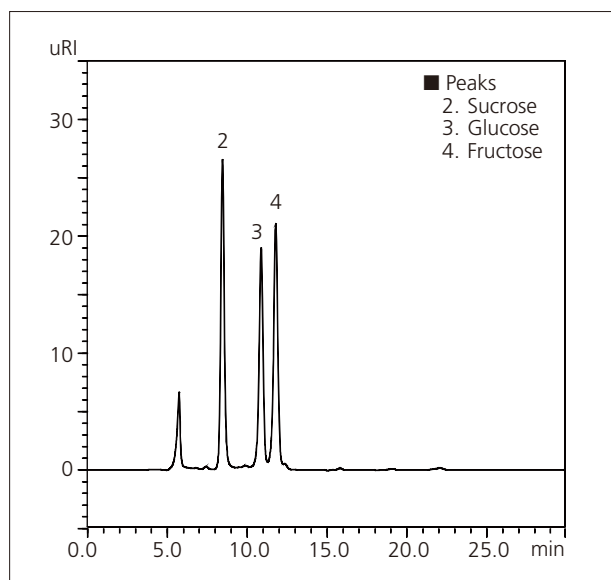

Fig. 4 Chromatogram of Orange Juice B (10 μL injected)

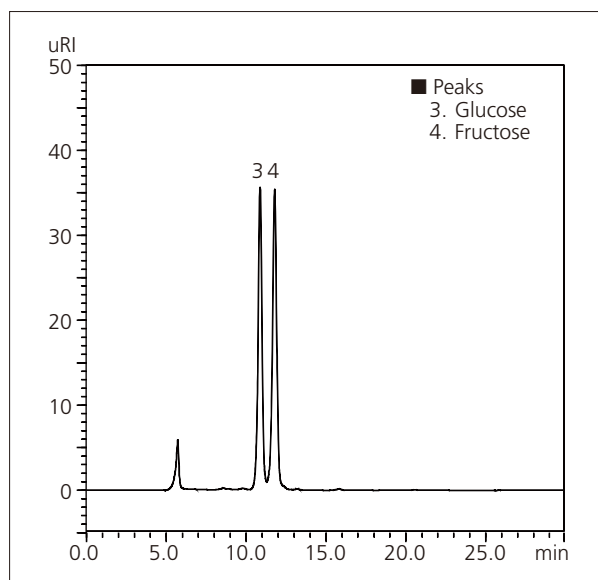

Fig. 5 Chromatogram of Grape Juice (10 μL injected)

Application News

No.L481

High Performance Liquid Chromatography

Analysis of Sugars and Sugar Alcohols in Energy Drink by Prominence-i with Differential Refractive Index Detector

Sugars and sugar alcohols display almost no ultraviolet absorption, and are therefore typically detected using a differential refractive index detector or evaporative light scattering detector. By using a ligand exchange column for sugar analysis, it is possible to distinguish among the different isomers based on the position of the hydroxyl group in the chair conformation of glucose and fructose for example. In other words, the hydroxyl group of the sugar and the metal ion of the stationary phase form a complex, making it possible to achieve separation due to the difference in the strength of the complex formation. Also, maintaining a column temperature of 80 °C suppresses sugar anomer separation and peak dispersion, thereby achieving good separation of adjacent peaks.

The new Prominence-i integrated high-performance liquid chromatograph can be connected to the RID-20A differential refractive index detector. The column oven, which can accommodate a 30 cm column and maintain temperature control up to 85 °C, therefore supports applications that require a long column.

In Application News No. 467, we introduced an example of analysis of sugars in juice, in which the Prominence-i was connected to a differential refractive index detector. Here, we introduce an example of simultaneous analysis of sugars and sugar alcohols in an energy drink using the Prominence-i and RID-20A.

■ Analysis of a Standard Mixture of Six Sugars

Sorbitol, xylitol, mannitol and erythritol are a type of sugar alcohol that because of their relative sweetness, are used as sweeteners. When conducting simultaneous analysis of sugars and sugar alcohols, a hydrophilic compound analytical column, such as the SPR-Ca or SPR-Pb, is suitable along with the use of a combination of the size exclusion and ligand exchange modes of analysis. Fig. 1 shows the results of analysis of a standard solution of six sugar alcohol substances (10 g/L each of maltose, glucose, fructose, erythritol, mannitol and sorbitol) using the SPR-Ca column with a 10 µL injection. The analytical conditions are shown in Table 1.

Fig. 2 shows the results of analysis of a standard solution of six sugar substances including sugar alcohols (10 g/L each of maltose, glucose, fructose, mannitol, xylitol, sorbitol) using a 10 µL injection, and Table 2 shows the analytical conditions that were used. The SPR-Pb was used as the analytical column.

Table 1 Analytical Conditions

Column	: Shim-pack SPR-Ca (250 mm L × 7.8 mm I.D., 8 µm)
Mobile Phase	: Water
Flowrate	: 0.6 mL/min
Column Temp.	: 80 °C
Injection Volume	: 10 µL
Detection	: RID-20A Polarity +, Cell temp. 40 °C, Response 1.5 sec

Table 2 Analytical Conditions

Column	: Shim-pack SPR-Pb (250 mm L × 7.8 mm I.D., 8 µm)
Mobile Phase	: Water
Flowrate	: 0.6 mL/min
Column Temp.	: 80 °C
Injection Volume	: 10 µL
Detection	: RID-20A Polarity +, Cell temp. 40 °C, Response 1.5 sec

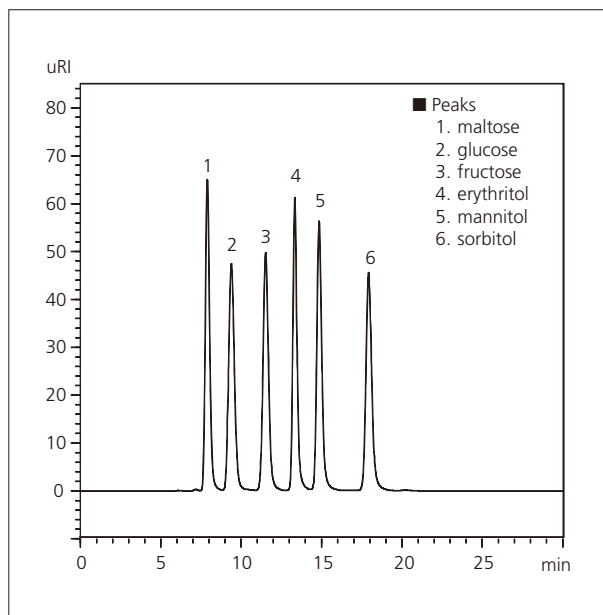

Fig. 1 Chromatogram of a Standard Mixture of Six Sugars (10 g/L each, 10 µL Injected)

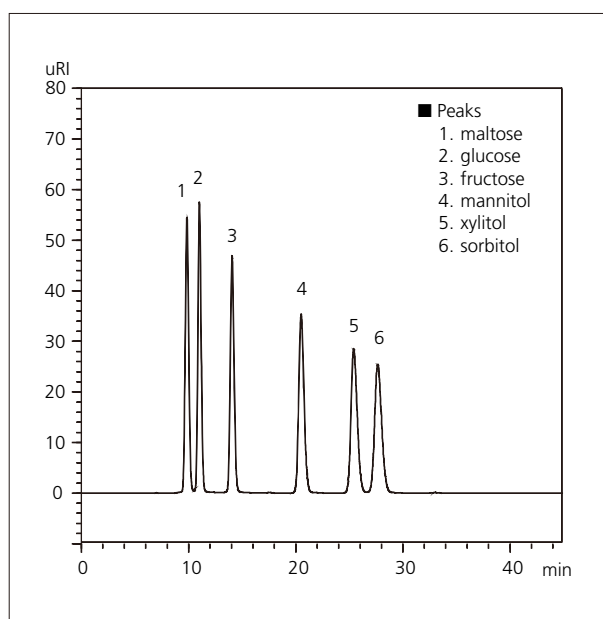

Fig. 2 Chromatogram of a Standard Mixture of Six Sugars (10 g/L each, 10 µL Injected)

■ Linearity

Fig. 3 shows the calibration curves generated using the analytical conditions of Table 2. When generating the curves for the six components over a concentration range of 0.2 to 10 g/L (using the average of three area values, respectively), excellent linearity with a coefficient of determination greater than $R^2=0.9999$ was obtained for each component.

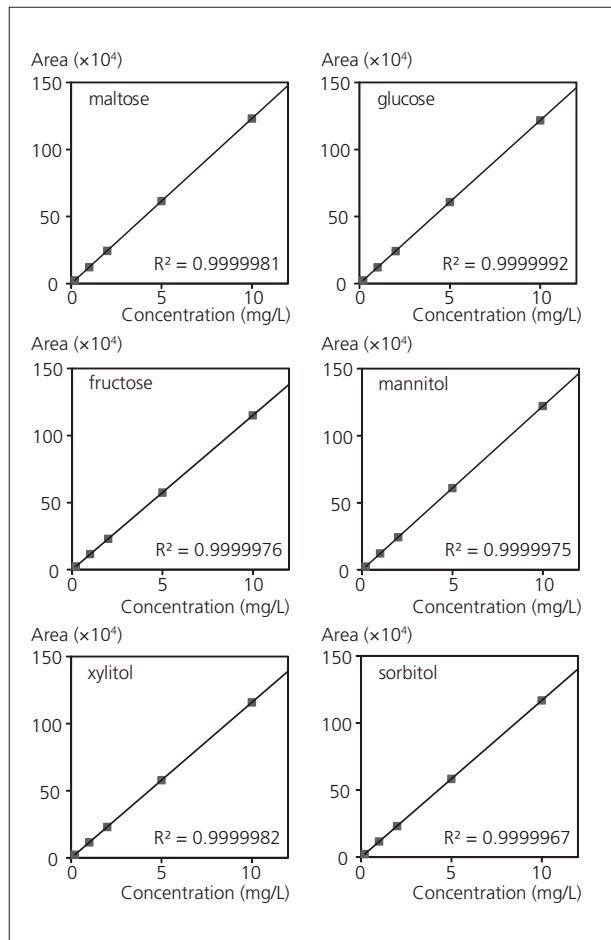

Fig. 3 Calibration Curves of a Standard Mixture of Six Sugars (0.2 – 10 g/L, 10 μ L Injected)

■ Analysis of Energy Drink

Figs. 4 and 5 show the chromatograms obtained from measurement of energy drinks A and B, respectively. Energy drink A was diluted 10:1 with water, and energy drink B, 20:1 with water, and after each was filtered through a 0.2 μ m membrane filter, 10 μ L of each sample was injected. The analytical conditions were the same as those of Table 2.

Xylitol and sorbitol were detected in energy drink A, and glucose and fructose were detected in energy drink B. Table 3 shows the quantities of each of these sugars in the respective energy drinks.

Table 3 Content of Respective Sugars in Energy Drinks

	Content (g/L)	
	Energy Drink A	Energy Drink B
Glucose	ND	59
Fructose	ND	101
Xylitol	25	ND
Sorbitol	14	ND

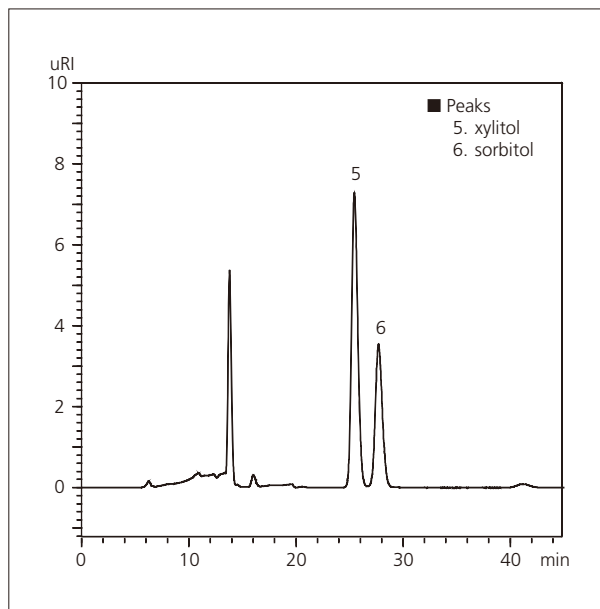

Fig. 4 Chromatogram of Energy Drink A (10 μ L Injected)

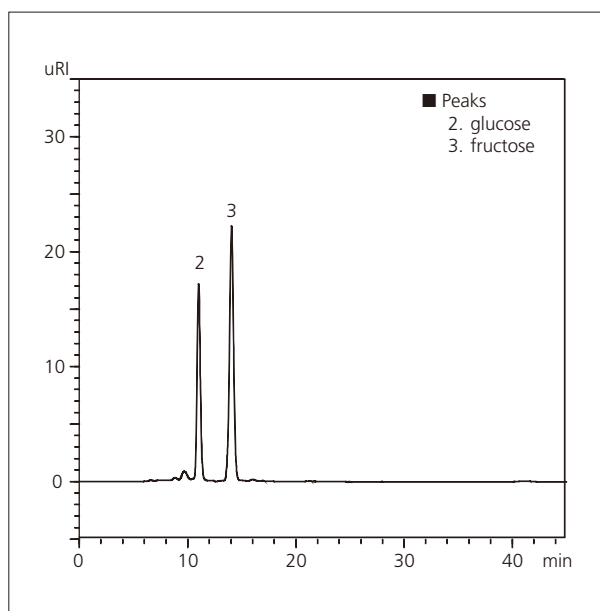

Fig. 5 Chromatogram of Energy Drink B (10 μ L Injected)

Application News

No. L474

High Performance Liquid Chromatography

Analysis of Oligosaccharides in Japanese Sake Using an Evaporative Light Scattering Detector

An evaporative light scattering detector (ELSD) is an HPLC detector often called a "universal" detector because it can detect almost all non-volatile sample components, including those that do not absorb light. Although a differential refractive index detector (RID) can also be used for analysis of compounds with no chromophore, the ELSD removes any potential interference from the solvent peak that is eluted at the column void volume because detection occurs after volatilization and evaporation of the mobile phase. In

■ Analysis of a Standard Mixture of Isomaltooligosaccharides

A differential refractive index detector is typically used in the analysis of sugars, but it is limited because gradient elution cannot be used, therefore resulting in longer run times. Fig. 1 shows the chromatogram obtained from the analysis of a standard mixture of isomaltooligosaccharides using isocratic conditions, and Table 1 shows the analytical conditions that were used.

Table 1 Analytical Conditions: Isocratic Elution

Column	: Asahipak NH ₂ P-50 4E (250 mm L. × 4.6 mm I.D.)
Mobile Phase	: A: 10 mM Ammonium Acetate Buffer B: Acetonitrile Isocratic B 70 %
Flowrate	: 1.0 mL/min
Column Temp.	: 40 °C
Detection	: ELSD-LT II Temperature : 40 °C Gain : 7 Nebulizer Gas : N ₂ Gas Pressure : 350 kPa

Under isocratic conditions, components that have long retention times tend to have broader peak shapes and diminished sensitivity because of the less intense response. Fig. 2 shows an example where a gradient was used for the same sample. The analytical conditions are described in Table 2. Using gradient elution with the ELSD permits separation of many components with high sensitivity because the narrower peaks produce a much higher signal.

Table 2 Analytical Conditions: Gradient Elution

Column	: Asahipak NH ₂ P-50 4E (250 mm L. × 4.6 mm I.D.)
Mobile Phase	: A: 10 mM Ammonium Acetate Buffer B: Acetonitrile Linear Gradient B 70 % → 40 %, 25 min
Flowrate	: 1.0 mL/min
Column Temp.	: 40 °C
Detection	: ELSD-LT II Temperature : 40 °C Gain : 7 Nebulizer Gas : N ₂ Gas Pressure : 350 kPa

addition, an ELSD detector has an advantage over an RID with its capability for analysis using gradient elution conditions.

Here we introduce an example of analysis of oligosaccharides in Japanese sake using the Nexera-i integrated high-performance liquid chromatograph, which includes a built-in UV detector. The ELSD-LT II evaporative light scattering detector was connected directly to the Nexera-i through an A/D acquisition board.

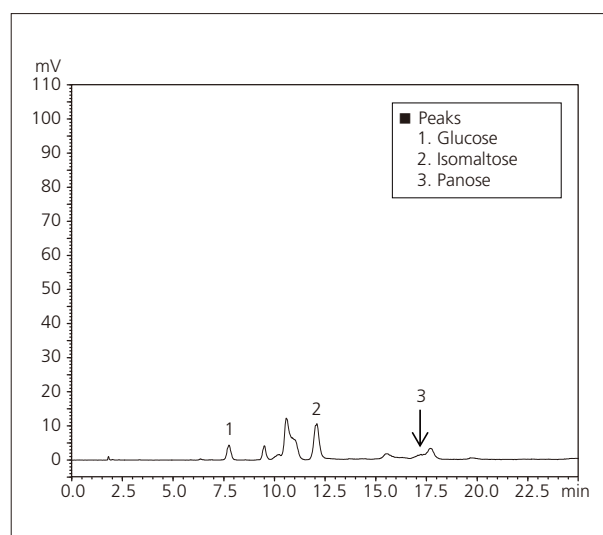

Fig. 1 Standard Solution of Isomaltooligosaccharides: Isocratic Elution

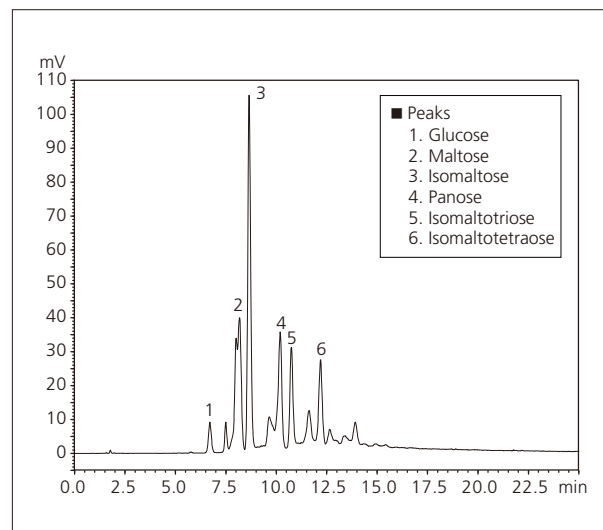

Fig. 2 Standard Solution of Isomaltooligosaccharides: Gradient Elution

Quantitative Analysis of Oligosaccharides Included in Sake

We used the ELSD to conduct quantitative analysis of glucose, isomaltose and panose that are present in sake. Pretreatment of the sake sample was performed according to the steps shown in Fig. 3. The calibration curves that were generated based on standard samples analyzed using the analytical conditions shown in Table 2 are shown in Fig. 4. Because the ELSD is not a spectroscopic detector, it does not obey Beer's law with a linear correlation between absorbance and concentration. Instead, a log-log plot of peak area and analyte quantity produces a linear response. Within the concentration range including 100, 200, 400, 1000, and 2000 mg/L (for glucose, 200, 400, 800, 2000, 4000 mg/L), excellent linearity was obtained with R^2 greater than 0.999. Fig. 5 shows the chromatogram of sake obtained using the conditions shown in Table 2. The quantitation results calculated using the calibration curves generated using the standard samples are shown in Table 3.

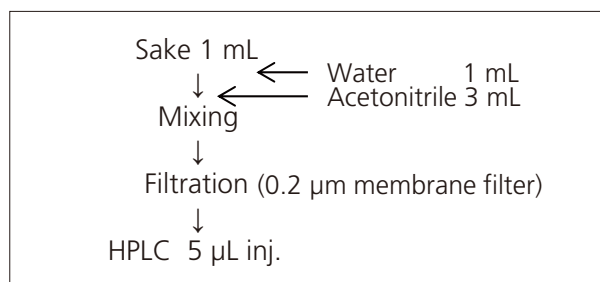

Fig. 3 Pretreatment of Sake

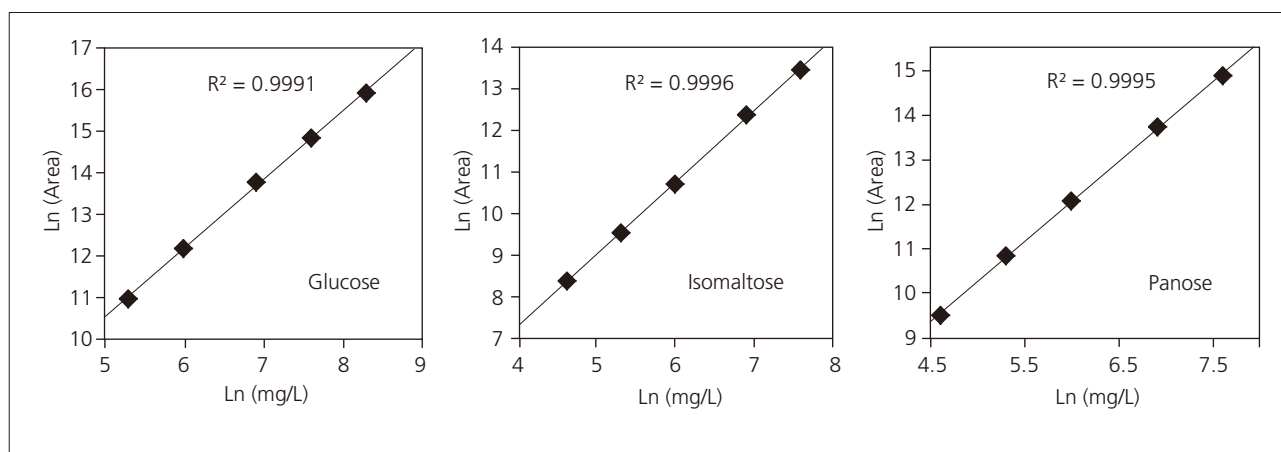

Fig. 4 Calibration Curves (Each injection 5 μ L)

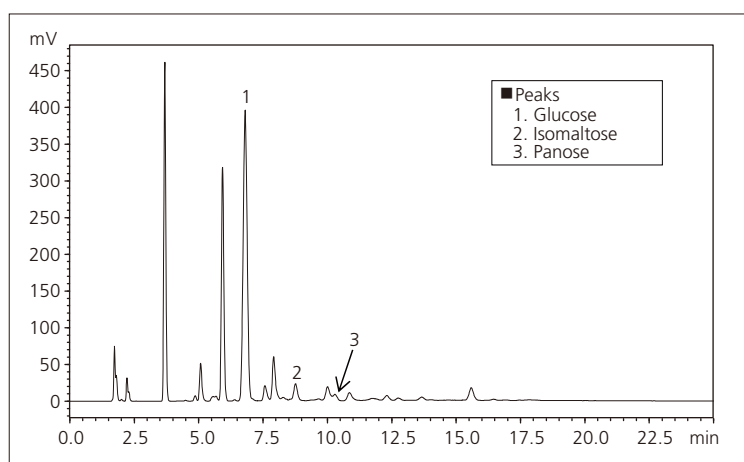

Fig. 5 Chromatogram of Sake

Table 3 Quantitation Results and Repeatability (n = 3) of Oligosaccharides in Japanese Sake

	Area	%RSD	Conc.
Glucose	432×10^4	0.6	13110 mg/L
Isomaltose	228×10^3	2.1	5130 mg/L
Panose	909×10^2	5.9	1410 mg/L

Note: The listed concentrations are the values obtained after converting the results obtained from the 5 μ L measurement samples to the undiluted source solution.

Application News

No. L507

High Performance Liquid Chromatography

Analysis of Low Molecular Weight Soluble Dietary Fiber by Prominence-i

Research into the physiological effects of dietary fiber has been ongoing since the results of epidemiological research showing dietary fiber reduces incidence of diseases that include digestive system disorders, circulatory system disorders, and diabetes. This research has revealed a variety of effects of dietary fiber, including the reduced absorption of lipids like cholesterol from the intestines, and assistance with adsorption and excretion of harmful substances. This functionality has garnered interest in recent years, with chemically synthesized dietary fiber being added to an increasing number of processed foods. Some of nutritional labeling of foods show dietary fiber content, and such labeling is a regulatory obligation in some countries.

Many substances can be classified as dietary fiber, with definitions varying by country and policy. Dietary fiber mainly refers to: cellulose, hemicellulose, and lignin that make up cell walls; animal polysaccharides like chitin and chitosan (insoluble dietary fiber), polysaccharides like pectin (high molecular weight soluble dietary fiber), and chemically synthesized polysaccharides like polydextrose and indigestible dextrin (low molecular weight soluble dietary fiber).

Dietary fiber is normally measured using an enzymatic-gravimetric method (prosky method). This involves subjecting a sample to an enzymatic reaction, filtering the sample, and measuring the weight of residue as the amount of dietary fiber. A problem with this method is its low rate of recovery for low molecular weight soluble dietary fiber, such as polydextrose and indigestible dextrin. Total dietary fiber is obtained by adding the quantitative result obtained by the enzymatic-gravimetric method to the quantitative result obtained by HPLC analysis of filtrate obtained from the enzymatic-gravimetric method. Japan's food labeling standards (Cabinet Office Ordinance No. 10, dated March 20, 2015) specify dietary fiber to be measured by a prosky method or HPLC method.

This application news describes an analysis of the amount of low molecular weight soluble dietary fiber by an enzymatic-HPLC method, based on the Food Labeling Standards — Appendix: Methods of analysis of nutritional composition¹⁾.

The instrument used was a Prominence-i integrated HPLC system installed with an RID-20A differential refractive index detector.

■ Pretreatment of Low Molecular Weight Soluble Dietary Fiber in a Beverage

Two types of cold beverages containing indigestible dextrin were prepared according to the analytical method¹⁾. The pretreatment procedure is shown in Fig. 1. After treatment with three different enzymes (after the

step "*" in Fig. 1), samples would normally require ethanol precipitation and filtration steps. However, these steps can be omitted when analyzing samples that clearly contain only low molecular weight soluble dietary fiber. The steps were omitted for both the beverages analyzed, since they were presumed to contain only low molecular weight soluble dietary fiber. Samples were then passed through an ion-exchange column before being used as the HPLC sample solution. Please refer to the analytical method¹⁾ for further information.

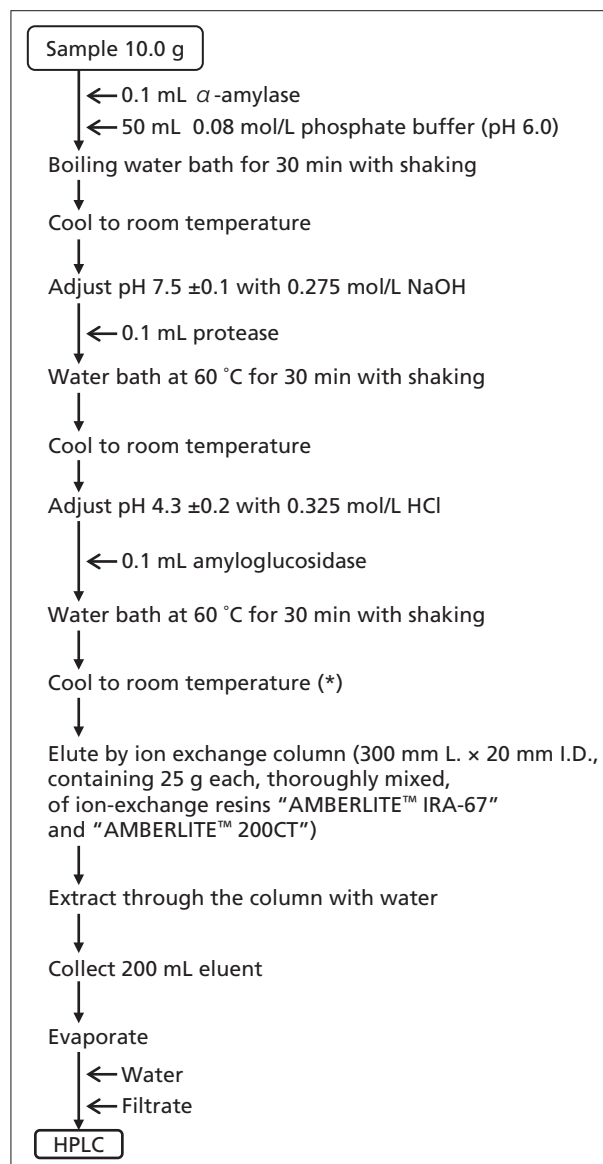

Fig. 1 Pretreatment Procedure

AMBERLITE™ is a trademark of the Dow Chemical Company (Dow) or an affiliated company of Dow.

HPLC Analysis of Low Molecular Weight Soluble Dietary Fiber

The two beverages were prepared according to the procedure shown in Fig. 1, and analyzed by HPLC. The results of HPLC analysis are shown in Fig. 2 and 3 alongside the results of HPLC analysis of maltotriose. Analytical conditions are shown in Table 1. The saccharides detected were divided into monosaccharides, disaccharides, and trisaccharides or larger on the chromatograms, with trisaccharides or larger being regarded as the dietary fiber fraction. The published analytical method¹⁾ states to analyze the trisaccharide maltotriose under the same conditions as the sample, then to include all peaks that elute equal to or earlier than maltotriose in the dietary fiber fraction. The published analytical method¹⁾ states to use either a ligand exchange column or gel filtration column for HPLC. Analysis was performed using a Shim-pack SPR-Na ligand exchange column. Ligand exchange columns are mainly used in carbohydrate analysis, and are excellent at separating carbohydrates. Ligand exchange columns can easily separate glucose from other carbohydrates, and are therefore suited to analyses using glucose as an internal reference standard as shown below.

The actual quantification analysis was performed using glucose produced by hydrolysis of starch as an internal reference standard. The amount of glucose in each sample was calculated by a separate pyranose oxidase method, and the amount of low molecular weight soluble dietary fiber was obtained by multiplying the peak area ratio of the dietary fiber fraction to the glucose peak by the amount of glucose. Depending on the sample and HPLC column type, glucose may not separate from accompanying components. If glucose does not separate from other components, quantification can be performed by adding a known concentration of glycerin or another internal reference standard after the enzyme pretreatment steps, then calculating amounts based on the peak area ratio of the dietary fiber fraction to the internal reference standard. Analytical sensitivity will differ when a compound other than glucose is used as the internal reference standard, and results will need to be corrected accordingly by calculating a coefficient relative to analytical sensitivity for glucose.

The amount of dietary fiber is shown by adding the amount of low molecular weight soluble dietary fiber calculated by HPLC analysis to the result obtained by a separate prosky method. This method of calculation includes oligosaccharides in the dietary fiber fraction, so to show the amount of dietary fiber in the sample minus indigestible oligosaccharides, the amount of indigestible oligosaccharides must be deleted from the results. Please refer to the analytical method¹⁾ for further information.

Table 1 HPLC Analytical Conditions

System	: Prominence-i, RID-20A
Column	: Shim-pack SPR-Na (250 mm L. × 7.8 mm I.D., 8 μm) × 2
Guard Column	: Shim-pack SPR-Na (50 mm L. × 7.8 mm I.D., 8 μm)
Mobile Phase	: Water
Flowrate	: 0.50 mL/min
Column Temp.	: 80 °C
Injection Volume	: 20 μL
Detection	: RID-20A

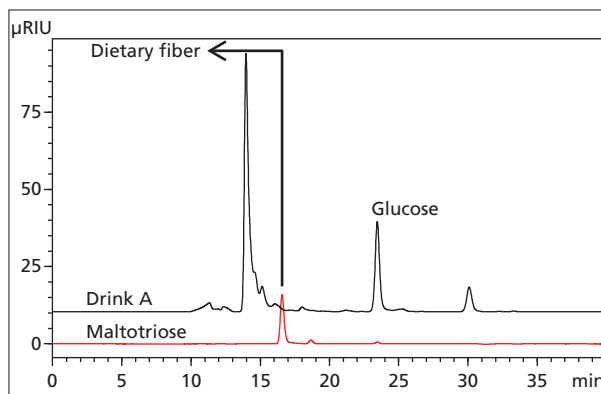

Fig. 2 Analysis of Low Molecular Weight Soluble Dietary Fiber in Beverage A

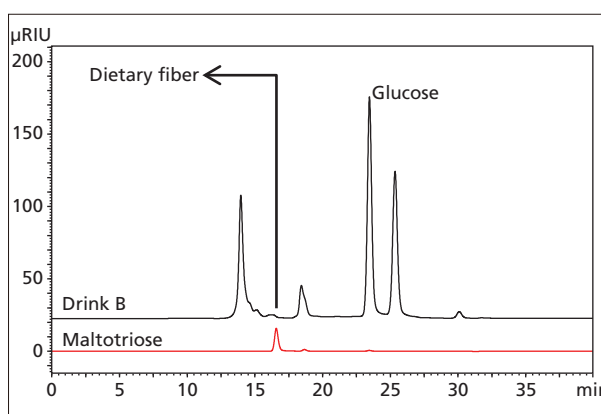

Fig. 3 Analysis of Low Molecular Weight Soluble Dietary Fiber in Beverage B

1) Food Labeling Standards
— Appendix: Methods of analysis of nutritional composition (Notification No. 139 from the Deputy Secretary General of the Consumer Affairs Agency, dated March 30, 2015) [In Japanese]

Application News

No. C121

Liquid Chromatography Mass Spectrometry

Simultaneous Analysis of Nine Sweeteners Using Triple Quadrupole LC/MS/MS (LCMS-8040)

Artificial sweeteners such as saccharin sodium, aspartame, sucralose and acesulfame potassium fall under the category of specified additives in Japan's Food Sanitation Act, for which each specified criteria exist for their use in terms of eligible foods and amounts used.

Cyclamate, an artificial sweetener used in some regions of the world outside Japan, is an unspecified additive within Japan, for which inspection is required on specific imported foods.

In light of these situations, there is a demand for analyses of various different sweeteners, not only the quantitative testing of permitted sweeteners but also the testing of unspecified sweetener additives.

This article presents a simultaneous analysis of nine sweeteners including both specified additives and unspecified additives, using the LCMS-8040 high-performance liquid chromatograph-triple quadrupole mass spectrometer.

■ Analysis of a Standard Mixture

Fig. 1 shows chromatograms measured from a 5 μ L injected sample of a 10 ng/mL standard mixture of nine sweeteners, analyzed with the analytical conditions shown in Table 1. Chromatograms at around the lower limit of quantitation (LLOQ) are shown in Fig. 2. The retention time, calibration curve range, and correlation coefficient for each compound are shown in Table 2. A calibration point accuracy of within 100 ± 20 % and a percentage of area repeatability (%RSD) of within 20 % were employed. Good linearity was obtained for all compounds with a correlation coefficient of 0.997 or higher.

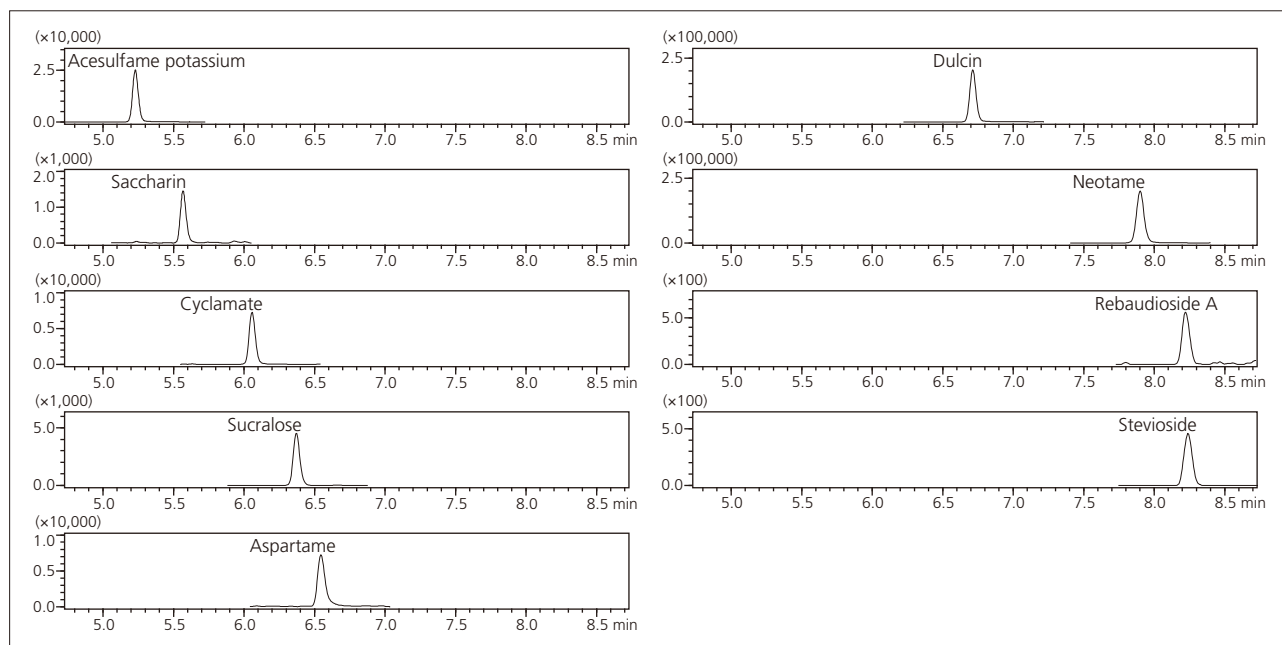

Fig. 1 Chromatograms from a 10 ng/mL Standard Mixture of Nine Sweeteners

Table 1 Analytical Conditions

Column	: Unison UK-C18 (150 mm L. \times 3.0 mm I.D., 3.0 μ m)
Mobile Phases	: A 5 mmol/L Ammonium Formate - Water : B Methanol
Gradient	: B Conc. 0 % (0.0 - 2.0 min) \rightarrow 70 % (4.5 min) \rightarrow 90 % (8.0 - 12.0 min) \rightarrow 0 % (12.01-15.0 min)
Flowrate	: 0.2 mL/min
Column Temperature	: 40 $^{\circ}$ C
Injection Volume	: 5 μ L
Probe Voltage	: + 4.5 kV (ESI-positive mode) / -3.5 kV (ESI-negative mode)
DL Temperature	: 300 $^{\circ}$ C
Block Heater Temperature	: 500 $^{\circ}$ C
Nebulizing Gas Flow	: 3 L/min
Drying Gas Flow	: 15 L/min

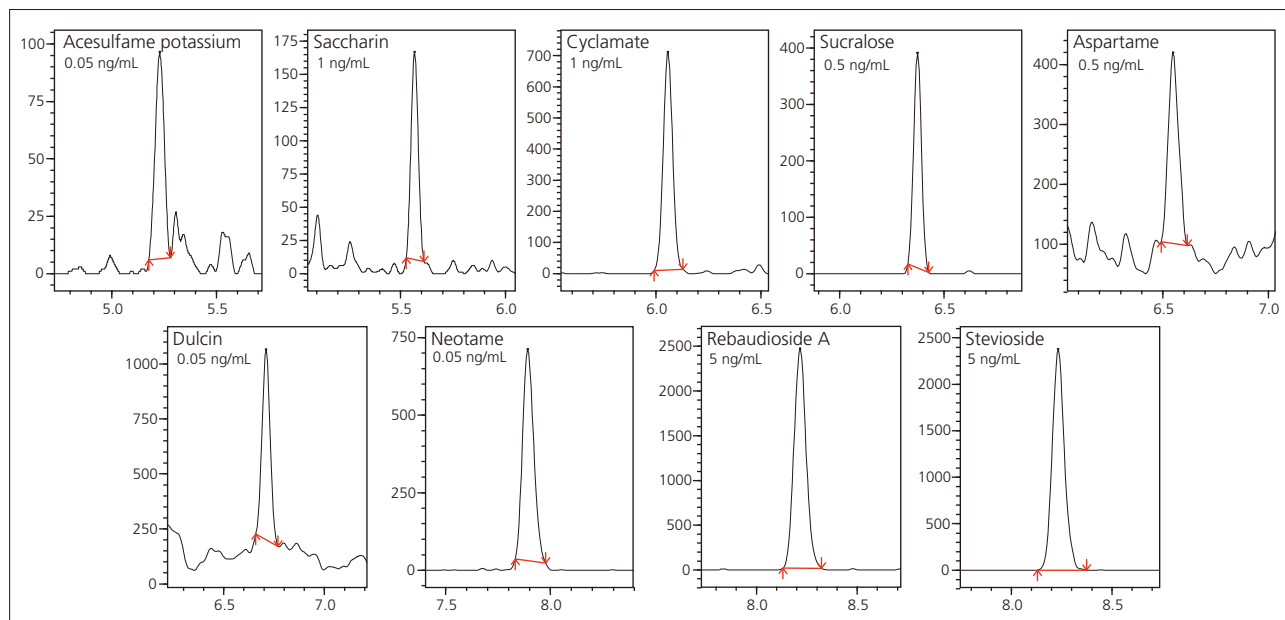

Fig. 2 Chromatograms of Nine Sweeteners at Around LLOQ

Table 2 Linearity of Nine Sweeteners

Compound Name	Polarity	Transition	Retention Time (min)	Calibration Curve Range (ng/mL)	Correlation Coefficient
Acesulfame potassium	-	162.00 > 82.10	5.228	0.05 – 100	0.997
Saccharin	-	182.00 > 42.00	5.561	1 – 100	0.999
Cyclamate	-	178.00 > 80.00	6.057	1 – 100	0.998
Sucralose	+	413.90 > 199.00	6.370	0.5 – 500	0.999
Aspartame	-	293.10 > 261.10	6.543	0.5 – 1000	0.999
Dulcin	+	181.20 > 108.10	6.712	0.05 – 10	0.999
Neotame	+	379.10 > 172.20	7.898	0.05 – 1000	0.999
Rebaudioside A	-	965.30 > 803.40	8.220	5 – 1000	0.999
Stevioside	+	822.30 > 319.20	8.238	5 – 1000	0.999

Recovery from Actual Samples

Seven sweeteners were added to foods (curry paste, rice cake flavored with mugwort, and sponge cake) pretreated by dialysis (Fig. 3), and the matrix effect was evaluated. The recovery of each added sweetener is shown in Table 3. Dulcin was the only sweetener for

which the recovery was calculated based on a 1000-fold dilution of the solution after dialysis treatment, while the recovery of all other sweetener samples was calculated based on 100-fold dilution. The recovery was good with all samples, ranging from 85 to 125 %.

Table 3 Recovery of Seven Added Sweeteners

Compound Name	Added Concentration	Recovery (%)		
		Curry Paste	Rice Cake Flavored with Mugwort	Chocolate Sponge Cake
Acesulfame potassium	5 µg/mL	100.8	94.2	93.7
Saccharin		97.0	87.7	88.3
Cyclamate		99.6	89.3	92.0
Sucralose		96.2	89.6	82.6
Aspartame		94.0	89.4	87.2
Dulcin		110.2	99.5	99.5
Neotame		122.5	106.9	110.0

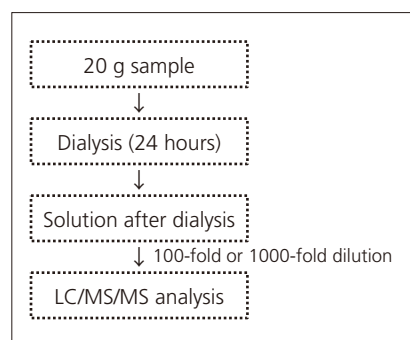

Fig. 3 Workflow of Pretreatment

This Application News was prepared with the cooperation of Tokyo Food Sanitation Association, who provided samples and guidance.

Application News

No. C133

Liquid Chromatography Mass Spectrometry

Simultaneous Analysis of 16 Sweeteners Using Triple Quadrupole LC/MS/MS [LCMS-8050]

Artificial sweeteners such as aspartame, sucralose, and acesulfame potassium fall under the category of designated additives according to Japan's Food Sanitation Act, and prescribed standards are in place for their use in some foods and quantities.

Cyclamate and other artificial sweeteners used in some regions outside Japan are included among undesignated additives in Japan, and inspection is required in specific imported foods.

Consequently, quantitation for large numbers of sweeteners, including not only permitted in Japan but also undesignated, are needed.

Application News C121 described the simultaneous analysis of nine artificial sweeteners including both designated and undesignated additives using an LCMS-8040 triple quadrupole LC/MS/MS system. In this article, we introduce an example of simultaneous analysis of 16 sweeteners using an LCMS-8050.

Standard Mixture Analysis

MRM analysis was performed on 16 sweeteners using the analytical conditions shown in Table 1. Chromatograms of each compound near their lower limit of quantitation are shown in Fig. 1, with calibration curve ranges and correlation coefficients shown in Table 2. Results that met an accuracy of 100 % ±20 % and area repeatability (%RSD) of within 20 % were used for calibration point. Good linearity was obtained for all compounds, with correlation coefficients of 0.997 or higher.

Table 1 Analytical Conditions

Column	: Unison UK-C18 (150 mm L. × 3.0 mm I.D., 3.0 μm)	Injection Volume	: 1 μL
Mobile Phases	: A 5 mmol/L Ammonium formate - Water : B 5 mmol/L Ammonium formate - Methanol	Probe Voltage	: + 4.0 kV (ESI-positive mode) / -3.0 kV (ESI-negative mode)
Gradient	: B.Conc. 0 % (0.0-2.0 min) → 70 % (4.5 min) → 90 % (8.0-12.0 min) → 0 % (12.01-15.0 min)	Nebulizing Gas Flow	: 3 L/min
Flowrate	: 0.4 mL/min	Heating Gas Flow	: 10 L/min
Column Temperature	: 40 °C	Interface Temperature	: 300 °C
		DL Temperature	: 150 °C
		Block Heater Temperature	: 250 °C
		Drying Gas Flow	: 10 L/min

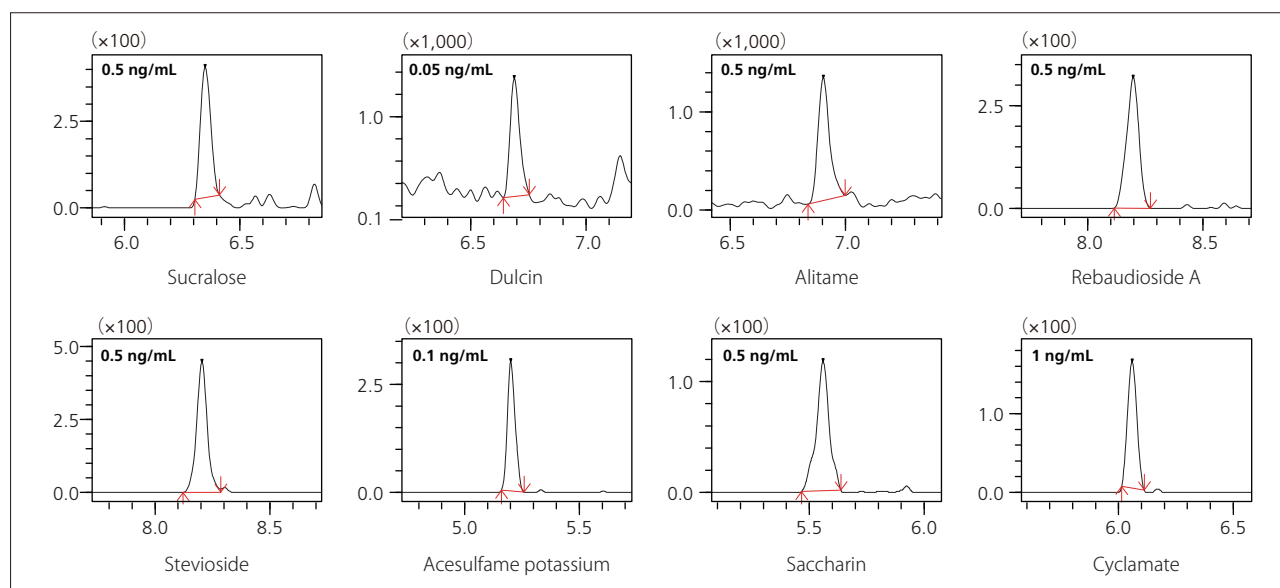

Fig. 1-1 Chromatograms of 16 Sweeteners

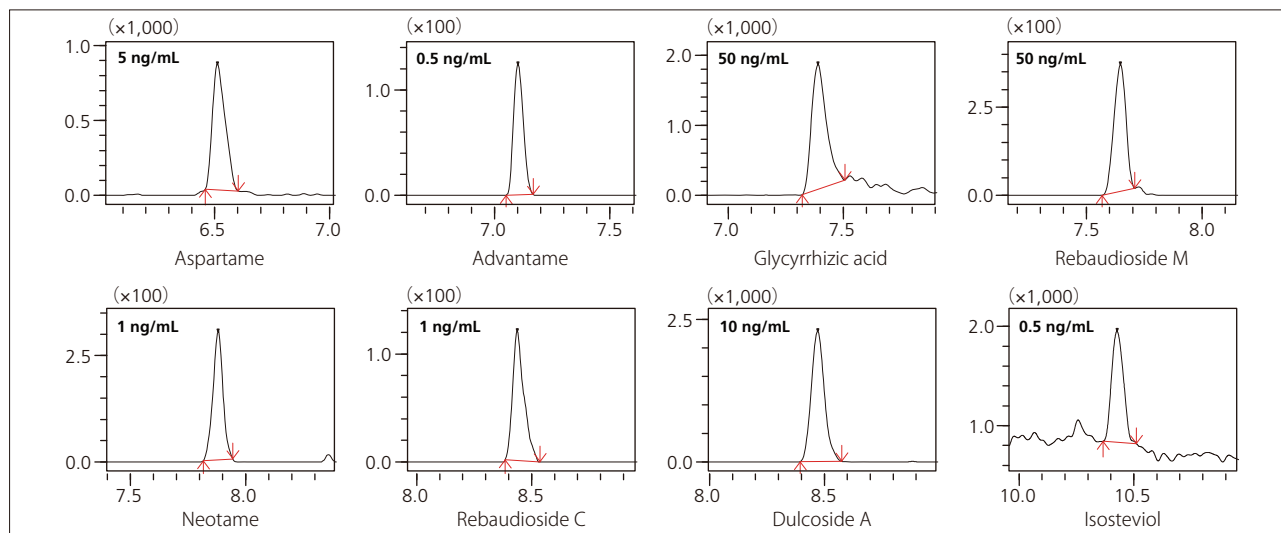

Fig. 1-2 Chromatograms of 16 Sweeteners (continued)

Table 2 Linearity of 16 Sweeteners

Compound Name	Polarity	Transition	Holding Time (min)	Calibration Curve Range (ng/mL)	Correlation Coefficient
Sucralose	+	414.00>199.10	6.36	0.5 - 100	0.999
Dulcin	+	181.20>108.10	6.70	0.05 - 10	0.999
Alitame	+	332.20>129.00	6.92	0.5 - 100	0.999
Rebaudioside A	+	984.50>325.10	8.21	0.5 - 100	0.999
Stevioside	+	822.00>319.30	8.23	0.5 - 100	0.999
Acesulfame potassium	-	161.90>82.00	5.23	0.1 - 10	0.999
Saccharin	-	181.90>42.00	5.58	0.5 - 50	0.997
Cyclamate	-	178.00>80.00	6.08	1 - 100	0.999
Aspartame	-	293.40>261.10	6.53	5 - 100	0.999
Advantame	-	457.30>200.30	7.12	0.5 - 100	0.999
Glycyrrhizic acid	-	821.20>351.10	7.41	50 - 1000	0.999
Rebaudioside M	-	1289.60>802.90	7.66	50 - 1000	0.999
Neotame	-	377.30>200.00	7.90	1 - 100	0.999
Rebaudioside C	-	949.50>787.20	8.46	1 - 100	0.999
Dulcoside A	-	787.50>625.20	8.50	10 - 1000	0.999
Isosteviol	-	317.30>317.30	10.46	0.5 - 1000	0.999

Recovery from Real World Samples

Sweeteners were added to sample solutions prepared according to the procedure shown in Fig. 2, and recovery of these additives was verified by measuring the samples after 100-fold or 1000-fold dilution. The results are shown in Table 3.

Dialysis and solid phase extraction are common methods used in sample pretreatment for sweetener analysis, but these operations have the drawback of being complex, time-consuming, and laborious. Pretreatment by solvent extraction requires no special equipment, and can be performed quickly and simply.

Table 3 Recovery

Compound Name	Additive Concentration	Real World Sample	Dilution Ratio	Recovery (%)
Glycyrrhizic acid	100 µg/mL	Soy sauce	100	85.20
Acesulfame potassium	10 µg/mL	Powdered soft drink	1000	81.21
Aspartame	10 µg/mL	(café au lait)		104.2
Neotame	10 µg/mL	Ketchup	100	108.5

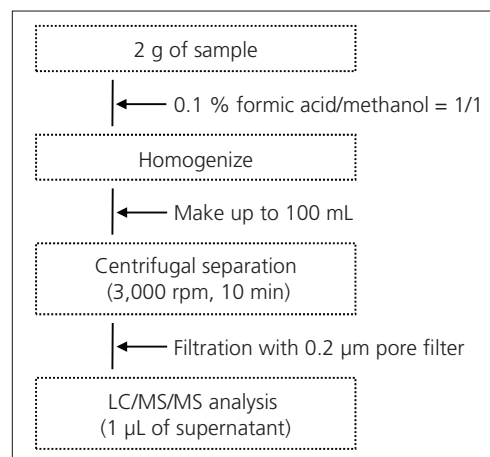

Fig. 2 Pretreatment Workflow

This Application News was prepared with the cooperation of Japan Food Research Laboratories, who provided samples and guidance.

First Edition: Aug. 2016



For Research Use Only. Not for use in diagnostic procedure.

This publication may contain references to products that are not available in your country. Please contact us to check the availability of these products in your country.

The content of this publication shall not be reproduced, altered or sold for any commercial purpose without the written approval of Shimadzu. Company names, product/service names and logos used in this publication are trademarks and trade names of Shimadzu Corporation or its affiliates, whether or not they are used with trademark symbol "TM" or "®". Third-party trademarks and trade names may be used in this publication to refer to either the entities or their products/services. Shimadzu disclaims any proprietary interest in trademarks and trade names other than its own.

The information contained herein is provided to you "as is" without warranty of any kind including without limitation warranties as to its accuracy or completeness. Shimadzu does not assume any responsibility or liability for any damage, whether direct or indirect, relating to the use of this publication. This publication is based upon the information available to Shimadzu on or before the date of publication, and subject to change without notice.

Application News

No.L463

High Performance Liquid Chromatography

Analysis of Histamine and Tyramine Using Prominence Amino Acid Analysis System

Putrefactive non-volatile amines, histamine and tyramine, are formed through decomposition of histidine and tyrosine, respectively, due to the action of microorganisms. When ingested food such as processed products and red-fleshed fish such as tuna, bonito, mackerel, etc., contain a large amount of histamine, food poisoning symptoms such as fever, hives, and palpitations may appear. There are also reported cases of food poisoning associated with fermented foods such as wine and cheese. Further, tyramine can also strengthen the toxicity of histamine, and has been reported as a causative agent in food-associated migraine.

Although there are no specific histamine-related regulations in Japan, in other countries, including the United States and the EU, Codex (International Food Standards) regulatory limits for histamine have been established for fish and fishery products.

As tyramine and histamine, like amino acids, contain an amino group, fluorescence detection is possible using derivatization with ortho-phthalaldehyde (OPA). Here, we introduce an example of analysis of tyramine and histamine using the Prominence Amino Acid Analysis System, in which detection is conducted using post-column fluorescence derivatization. Mobile phase and reagent kits, which are available for this application, contain the required mobile phases and reaction reagent solution, thus eliminating the tedious preparation of mobile phase. Moreover, as sample pretreatment consists only of filtering and dilution for this application, analysis can be conducted without complicated processing.

■ Analysis of Standard Solution

The analytical conditions that were used are shown in Table 1, and the chromatogram obtained from analysis of a standard solution of histamine and tyramine (each at 10 mg/L) is shown in Fig. 1. The standard solution was prepared by dissolving these in pH 2.2 sodium citrate buffer solution. For the mobile phases, the mobile phase B and C of the Amino Acid Mobile Phase kits (Na type) were used, and analysis was conducted using gradient elution. Also, because the elution positions vary depending on the mobile phase pH, use of a carbon dioxide gas trap is suggested when conducting analysis.

Table 1 Analytical Conditions

Column	: Shim-pack Amino-Na (100 mm L. x 6.0 mm I.D.)	
Ammonia Trap	: Shim-pack ISC-30 / S0504Na (50 mm L. x 4.0 mm I.D.)	
Mobile Phase	: Amino Acid Mobile Phase Kits (Na type, Mobile Phase B and C)	
Time Program	Time (min)	B. Conc. (%)
	0	80
	15.00	65
	15.01	0
	20.00	0
	20.01	80
	25.00	Stop
Flowrate	: 0.6 mL/min	
Column Temp.	: 60 °C	
Reagent	: Amino Acid Reagent Kits	
Flowrate of Reagent	: 0.2 mL/min	
Reaction Temp.	: 60 °C	
Detection	: RF-20Axs, Ex at 350 nm, Em at 450 nm	
Injection Vol.	: 10 µL	

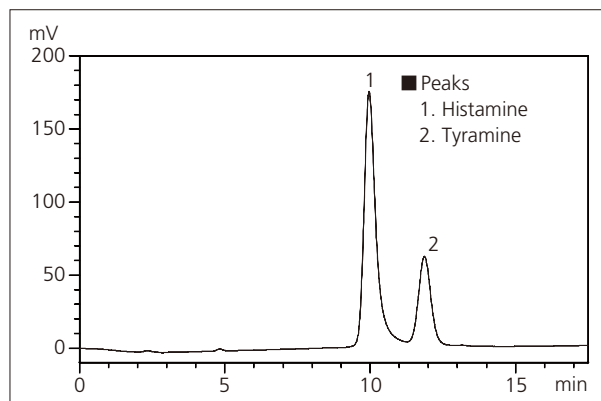

Fig. 1 Chromatogram of Histamine and Tyramine Standard Solution (Each 10 mg/L)

■ Linearity

Fig. 2 shows the linearity of histamine and tyramine using a concentration range from 0.1 mg/L to 100 mg/L. Excellent linearity was obtained with a coefficient of determination greater than $R^2=0.9998$ for both substances.

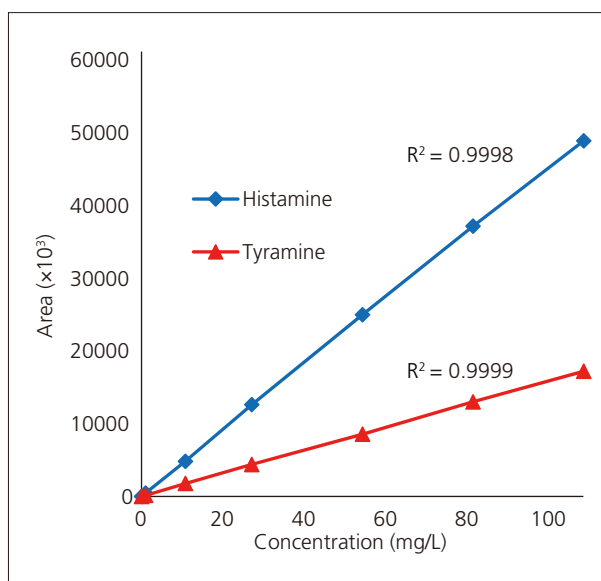

Fig. 2 Linearity of Histamine and Tyramine (0.1 – 100 mg/L)

■ Repeatability

Table 2 and 3 show the relative standard deviations (n=6) of retention time and peak area obtained in repeat analysis of a mixed histamine and tyramine standard solution (each 1 mg/L). Limits for histamine differ depending on the country, but in Codex, for example, the limit associated with decomposition in fish and fishery products is 100 mg/kg. Good repeatability has been obtained at a concentration of about 1/100 of the criterion.

Table 2 Repeatability of Peak Area and Retention Time of Histamine

	R.t (min)	Peak Area
1st	9.962	433,724
2nd	9.983	431,874
3rd	9.967	441,528
4th	9.962	429,887
5th	9.972	439,560
6th	9.993	434,818
Ave	9.973	435,232
%RSD	0.12	1.03

Table 3 Repeatability of Peak Area and Retention Time of Tyramine

	R.t (min)	Peak Area
1st	11.844	153,458
2nd	11.871	155,582
3rd	11.858	155,848
4th	11.855	154,509
5th	11.882	151,206
6th	11.911	153,960
Ave	11.87	154,094
%RSD	0.20	1.09

■ Analysis of Food

Figures 3 to 8 show examples of analysis of commercial fish sauce, wine, and soy sauce. Pretreatment consisted of preparing a 10-fold dilution using pH 2.2 sodium citrate buffer solution, and filtering through a 0.2 µm pore diameter membrane filter. As for the red wine and white wine, both were spiked with histamine and tyramine at 50 µg/L each.

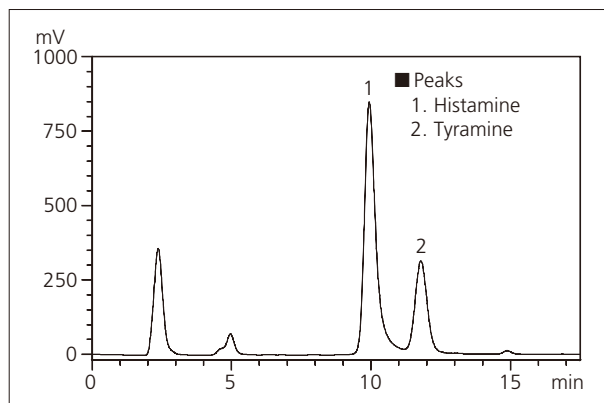

Fig. 5 Chromatogram of Red Wine

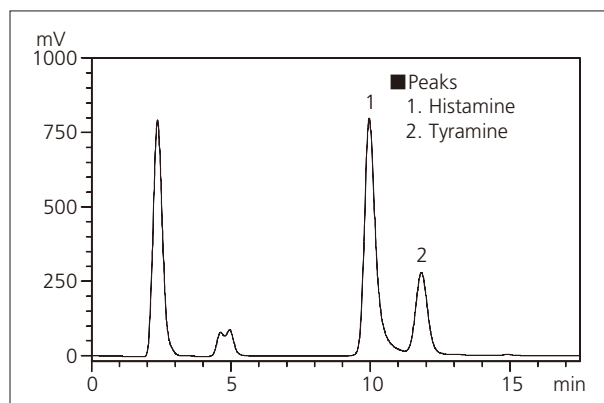

Fig. 6 Chromatogram of White Wine

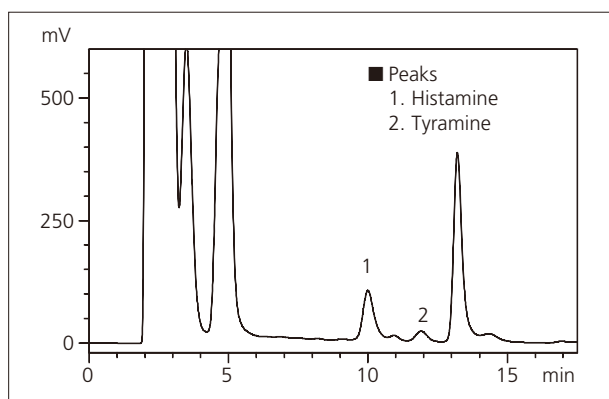

Fig. 3 Chromatogram of Fish Sauce A

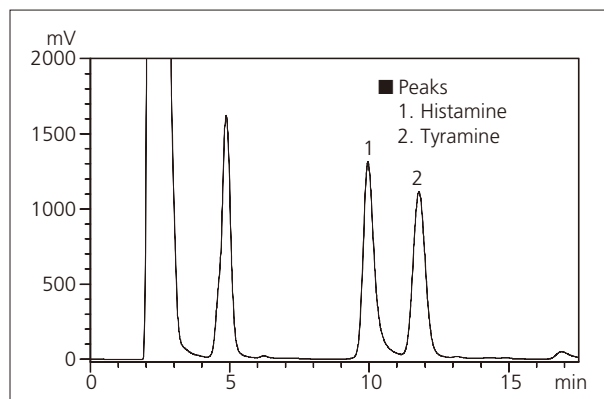

Fig. 7 Chromatogram of Soy Sauce A

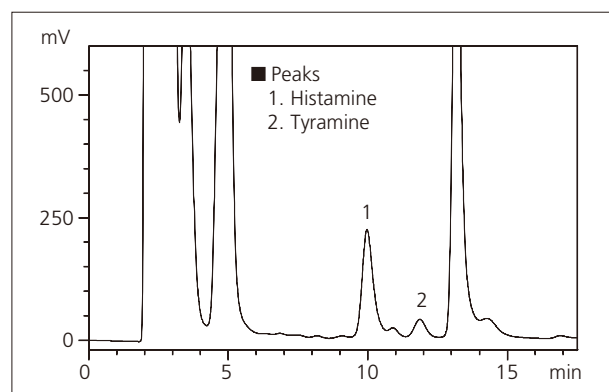

Fig. 4 Chromatogram of Fish Sauce B

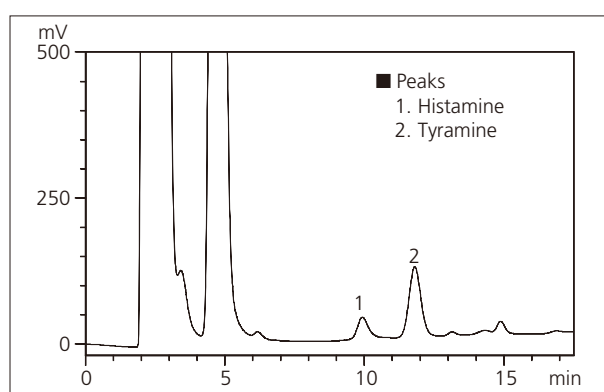

Fig. 8 Chromatogram of Soy Sauce B

Application News

No. G296

Gas Chromatography

Aroma Component Analysis of Japanese Sake by GC-FID Using a Diacetyl Derivatizing Reagent

The food industry widely employs evaluation using analytical instruments for new product developments and quality assurance. In the brewing industry, aroma component analysis is highly important due to the strong effects on product quality. Regarding aroma components in brewed Japanese sake, the conventional analysis method uses a gas chromatograph combined with a headspace sampler. By combining this method with a high-sensitivity detector, detection of aroma components in low concentrations is possible. However, such a system is expensive and sample preparation calls for an experienced analyst.

In this article, we introduce an example analysis of aroma components in Japanese sake with a simple GC system configuration using a simplified pretreatment method which employs a derivatizing reagent manufactured by Shinwa Chemical Industries.

E. Kobayashi, T. Murata

Shinwa DS-DA (Diacetyl) Diacetyl Derivatization Kit Shinwa Chemical Industries

Shinwa DS-DA is a reagent kit for derivatizing diacetyl in non-alcoholic beverages and alcoholic beverages for measurement by gas chromatography.



Fig. 1 Shinwa DS-DA (Diacetyl)

Diacetyl in Japanese Sake

Diacetyl is a compound which has a characteristic aroma and greatly affects the quality of fermented beverage and food products. Although the aroma of diacetyl is indispensable for dairy products which are made by lactic acid fermentation such as cultured butter and some cheeses, it is considered undesirable for food and drinks which are made by alcoholic fermentation such as alcoholic beverages. In particular, sake breweries consider the aroma to be one of the most undesirable odors and therefore conduct quantitative evaluation at production.

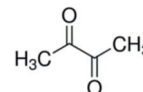

Derivatization Reaction of Diacetyl Using Shinwa DS-DA

Diacetyl reacts with o-phenylenediamine and turns into 2,3-dimethyl quinoxaline (DMQX). Although FID sensitivity for diacetyl is low because diacetyl has two carbonyl groups, DMQX obtained by derivatization has a quinoxaline structure and therefore the FID sensitivity rises.

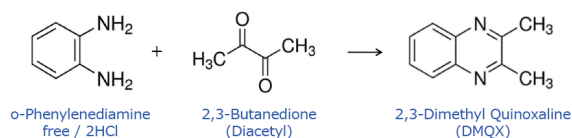

Fig. 2 Derivatization Reaction of Diacetyl Using Shinwa DS-DA

Procedure of Diacetyl Derivatization Using Shinwa DS-DA

Derivatization was performed using the Shinwa DS-DA (Diacetyl) reagent kit on a sample (Japanese sake). The diacetyl contained in the sample reacts and turns into DMQX. Methyl n-propyl quinoxaline (MPQX) was added as an internal standard substance.

Derivatizing Diacetyl Using Shinwa DS-DA

Sample	10 mL	Leave to stand for approx. 1 min until tablet dissolves	Reagent C	8 mL	Mix by inverting for 2 min	GC analysis of supernatant
Reagent A	100 μL		Reagent D	1 mL		
Reagent B	1 tablet					

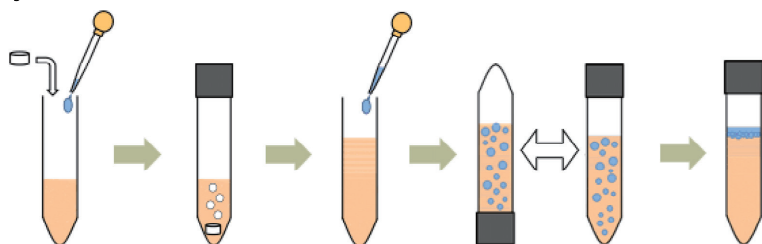

- The tablet may take time to dissolve depending on the sample.
- The tablet may not completely dissolve.

Fig. 3 Procedure of Diacetyl Derivatization Using Shinwa DS-DA

Instrument Configuration and Analysis Conditions

Table 1 lists the configuration of the instrument used for analysis and the analysis conditions.

Table 1 Instrument Configuration and Analysis Conditions

Gas chromatograph	: GC-2010 Plus
Autosampler	: AOC-20i
Sample injection port	: SPL
Column	: ULBON HR-52 (25 m × 0.25 mm I.D. df = 0.25 mm)
Detector	: Flame ionization detector (FID)
Injection volume	: 2 µL
Carrier gas	: He, 30 cm/sec
Split ratio	: 5:1
Injection port temperature	: 200 °C
Detector temperature	: 280 °C
Column temperature	: 100 °C (2 min) - 10 °C/min - 270 °C (5 min)

Analysis of Diacetyl Derivatives Obtained Using Shinwa DS-DA

After derivatizing diacetyl, the peak from DMQX was detected in the vicinity of a retention time of 9.6 min (Fig. 4).

The dotted line in Fig. 5 indicates the calibration curve of a 15 % ethanol solution which was prepared in accordance with the composition of Japanese sake and then added diacetyl. The solid line is the calibration curve of a commercially available sake which was added diacetyl. From this we were able to determine that the diacetyl content in this commercially available sake is 125 ppb (µg/L).

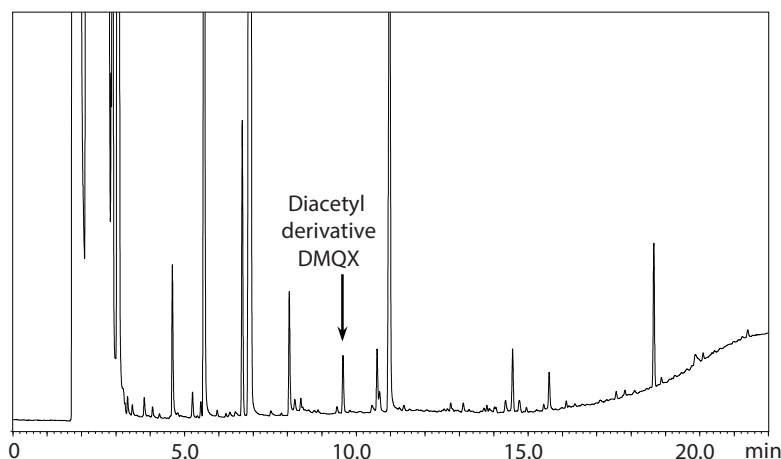

Fig. 4 Chromatogram of Japanese Sake Sample After Diacetyl Derivatization

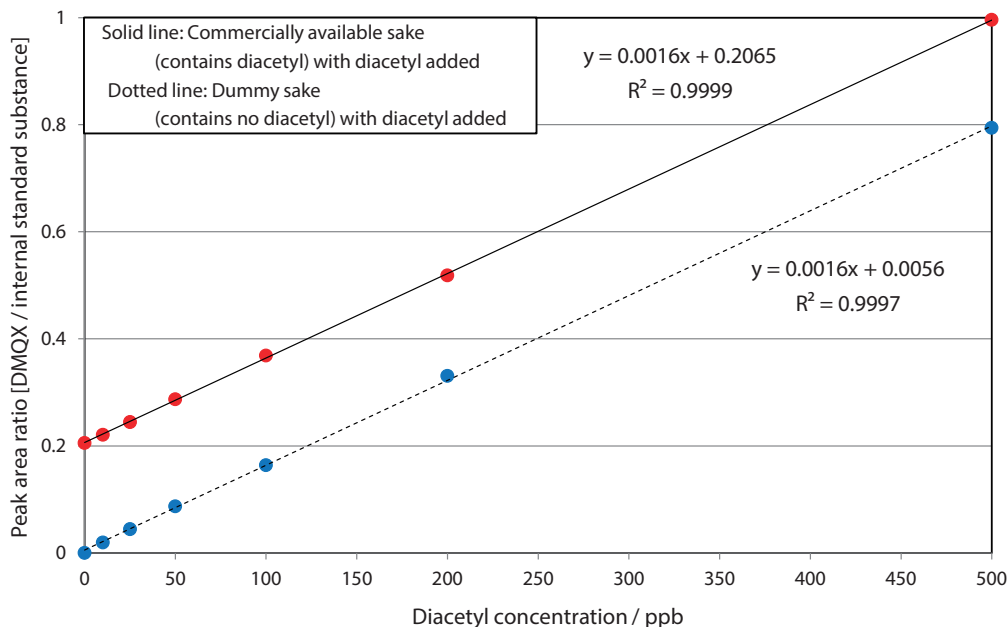

Fig. 5 Calibration Curve of Diacetyl Derivative Sample

First Edition: Oct. 2017



For Research Use Only. Not for use in diagnostic procedure.

This publication may contain references to products that are not available in your country. Please contact us to check the availability of these products in your country.

The content of this publication shall not be reproduced, altered or sold for any commercial purpose without the written approval of Shimadzu. Company names, product/service names and logos used in this publication are trademarks and trade names of Shimadzu Corporation or its affiliates, whether or not they are used with trademark symbol "TM" or "®". Third-party trademarks and trade names may be used in this publication to refer to either the entities or their products/services. Shimadzu disclaims any proprietary interest in trademarks and trade names other than its own.

The information contained herein is provided to you "as is" without warranty of any kind including without limitation warranties as to its accuracy or completeness. Shimadzu does not assume any responsibility or liability for any damage, whether direct or indirect, relating to the use of this publication. This publication is based upon the information available to Shimadzu on or before the date of publication, and subject to change without notice.

Shimadzu Corporation

www.shimadzu.com/an/

Application News

No. AD-0124Ph

Food and Beverages / GC-2010

A Comparison Study of Different Capillary Columns for Analysis of Alcohol Congeners in Alcoholic Beverages

□ Introduction

Alcoholic beverages contain a wide range of volatile components, primary of which are alcohols and short-chain aldehydes. To ensure consistency in the quality and flavour of the finished products, distilleries and alcoholic beverage manufacturers monitor the presence and relative levels of these compounds. Gas chromatography (GC) is usually the preferred technique in analysing these compounds. Fifteen components as listed in Table 1 are monitored by ethanol distilleries and alcoholic beverage manufacturers in the Philippines. The Association of Official Analytical Chemists (AOAC) and the Commission of the European communities have published methods for the analysis of fusel oils, methanol, ethanol, aldehydes and higher alcohols by GC in spirit drinks and distilled liquors [1~3]. The conventional GC methods for alcoholic beverage analysis are based on packed column, because glass tubing material for the packed column is inert, rarely causes tailing or decomposition of samples and minimizes interaction between the target component and the walls of the tube. However, packed glass columns are prone to breakage and may cause adsorption of the more reactive components present in alcoholic beverages. Most modern GC instruments are configured for capillary column use for the inherent advantages over packed columns such as more efficient separation, narrower peaks and consequently, lower limits of detection. This motivates an investigation into the potential of using capillary column in separating alcohols, aldehydes and other congeners typically found in alcoholic beverages. In this study, four capillary columns are selected and their performance are compared with packed column in terms of separation of all key components found in alcoholic beverages.

□ Experimental

Methods and Standard Preparation

Standard solutions containing varying amounts of alcohol congeners were prepared in accordance with in-house procedures. All solutions were diluted to volume with 40% (v/v) ethanol in water. The linear velocity of He carrier gas of GC for each column was optimized to achieve the best separation. The injection and FID detection conditions were set according to the column supplier's recommendation or in-house procedures. Four columns from different suppliers were employed and compared in this work. The columns were chosen based on availability and suitability of each column for alcohol congeners separation as published in literature [4,5].

Instrument, Columns and Analytical Conditions

GC : GC-2010 with FID
 Auto injector : AOC-5000
 Columns : Capillary columns are used as below:

- (1) CP-Wax 57 CB, 50 m L. x 0.25 mm I.D. x 0.20 μ m δ f (see Table 3)
- (2) Supelcowax 10, 60 m L. x 0.53 mm I.D. x 1.0 μ m δ f (see Table 4)
- (3) SPB-20, 40 m L. x 0.25 mm I.D. x 1.0 μ m δ f (Table 5)
- (4) Supel-Q PLOT, 30 m L. x 0.32 mm I.D. (Table 6)

Table 1: Alcohols, aldehydes and other compounds monitored in local alcoholic beverages

Peak ID	Component
1	Acetaldehyde
2	Acetone
3	Ethyl acetate
4	Acetal
5	Methanol
6	Isopropanol
7	N-propyl acetate
8	N-propanol
9	N-butyl acetate
10	Isobutanol
11	Isoamyl acetate
12	N-butanol
13	Isoamyl alcohol
13a	Active amyl alcohol
14	1-pentanol
15	Furfural

□ Results and Discussion

The most popular packed column employed for alcohol congeners analysis is the Carbowax B packed with 5% or 6.6% Carbowax 20M [6]. This column provides excellent peak shape for methanol, resolves methanol from ethanol completely and separates two predominant fusel oils namely active amyl alcohol and isoamyl alcohol (see Figure 1 and Table 2).

Table 2: GC analytical conditions using Carbowax 20M
Packed column (6.6% Carbowax 20M 80/120 Carbopack
B, 2.60 mm I.D. x 2 m L)

Injection Temp.	175°C
Column Temp.	80°C (0.5 min), 4°C/min ~150°C, 10°C/min ~190°C (3 min)
Injection Mode	Direct
Carrier Gas	N ₂
Column Flow	14 mL/min
Injection Volume	1.0 µL
Detector	200°C, FID

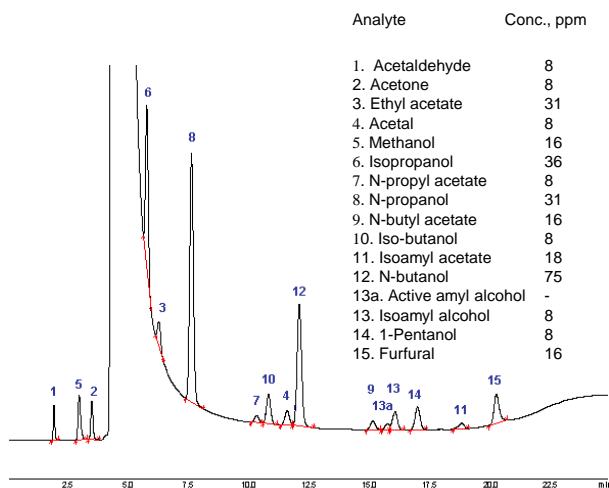

Figure 1: GC-FID result of 15 alcohol congeners on 6.6%
Carbowax 20M 80/120 Carbopack B, 2.60 mm I.D. x 2 m L.

Comparison of four capillary columns

Supelcowax 10 and *CP-Wax 57 CB* columns are both made of 100% chemically bonded polyethylene glycol making these columns highly polar. The compounds tested showed similar elution patterns for both columns (Figures 2 and 3) under the optimized conditions (Tables 3 and 4). In particular, the peak of methanol exhibited a characteristic broad shape. The smaller internal diameter of CP-Wax 57 CB resulted in full baseline separation of acetal from ethyl acetate and active amyl alcohol from isoamyl alcohol (Figure 2). While, the higher loading capacity of the wide bore Supelcowax 10 column enabled better separation of propyl acetate from ethanol (Figure 3).

Table 3: GC Analytical Conditions using CP-Wax 57CB
capillary column

Injection Temp.	200°C
Column Temp.	50°C (10 min), 5°C/min ~140°C, 10°C/min ~190°C (3 min)
Injection Mode	Split, 1:10
Carrier Gas	He
Linear Velocity	25 cm/sec
Injection Volume	1 µL
Detector	210°C, FID

Analyte	Conc., ppm	Analyte	Conc., ppm
1. Acetaldehyde	21	9. N-butyl acetate	12
2. Acetone	13	10. Iso-butanol	11
3. Ethyl acetate	15	11. Isoamyl acetate	17
4. Acetal	11	12. N-butanol	11
5. Methanol	12	13a. Active amyl alcohol	-
6. Isopropanol	11	13. Isoamyl alcohol	11
7. N-propyl acetate	11	14. 1-Pentanol	16
8. N-propanol	10	15. Furfural	14

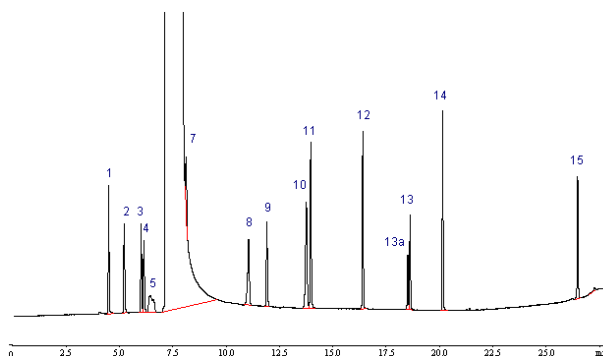

Figure 2: Alcohol congeners on CP-Wax 57 CB column

Table 4: GC analytical conditions using Supelcowax 10
capillary column

Injection Temp.	200°C
Column Temp.	45°C (5 min), 5°C/min ~65°C, 10°C/min ~200°C (0.5 min)
Injection Mode	Split, 1:5
Carrier Gas	He
Linear Velocity	31 cm/sec
Injection Volume	1 µL
Detector	260°C, FID

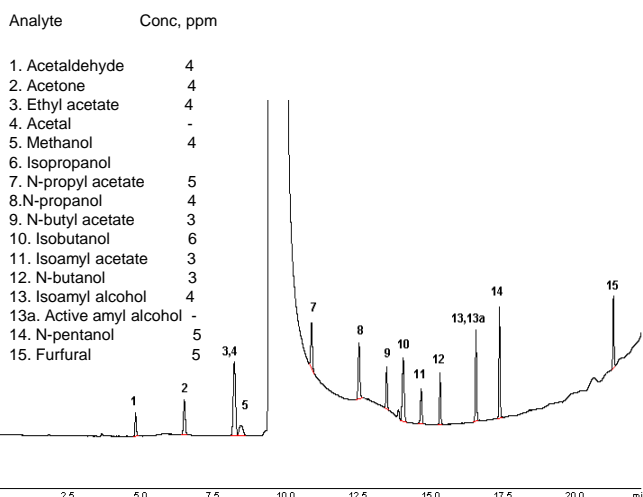
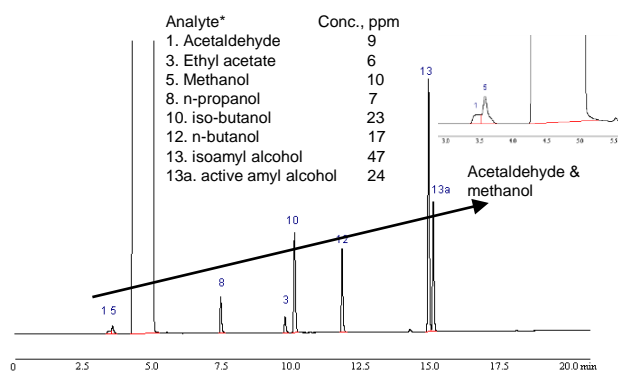

Figure 3: Alcohol congeners on Supelcowax 10 column

The SPB-20 capillary column, on the other hand, can be classified as an intermediate polarity column. Figure 4 shows the separation profile of this column. Its stationary phase is made of bonded poly(20% diphenyl / 80% dimethylsiloxane). The high phenyl content of the column produced a different elution order when compared to polyethylene glycol-based columns, which makes it suitable for confirmation analysis. One drawback of this column is the partially overlapping of two important congeners, acetaldehyde and methanol.

Table 5: GC Analytical Conditions for SPB-20 capillary column

Injection Temp.	150°C
Column Temp.	35°C (5 min), 5°C/min ~100°C (1.0 min)
Injection Mode	Split, 1:10
Carrier Gas	He
Linear Velocity	30 cm/sec
Injection Volume	1 µL
Detector	250°C, FID



* Tested only for eight standards

Figure 4: GC analysis of 15 alcohol congeners on SPB-20 capillary column

The Supel-Q plot capillary column contains a porous sorbent made from copolymer of ethylbenzene and divinylbenzene. The ethanol matrix interfered with the peak of isopropanol for all capillary columns, except this one. This was the only column tested that was able to resolve isopropanol from the ethanol matrix (see Figure 5). However, while this column separates the most number of peaks, significantly smaller and broader peaks with slight tailing was observed. This can be attributed to the column inherently high adsorption characteristic.

Table 6: GC Analytical Conditions for Supel-Q Plot Capillary column

Injection Temp.	200°C
Column Temp.	50°C, 10°C/min ~150°C, 5°C/min ~210°C, 40°C/min ~250°C (5 min)
Injection Mode	Split, 1:10
Carrier Gas	He
Linear Velocity	30 cm/sec
Injection Volume	1 µL
Detector	270°C, FID

Analyte	Conc., ppm	Analyte	Conc., ppm
1. Acetaldehyde	43	9. n-Butyl acetate	35
2. Acetone	43	10. Isobutanol	32
3. Ethyl acetate	27	11. Isoamyl acetate	29
4. Acetal	26	12. N-butanol	39
5. Methanol	32	13. Isoamyl alcohol	28
6. Isopropanol	29	13a. Active amyl alcohol	-
7. N-propyl acetate	40	14. 1-Pentanol	-
8. N-propanol	29	15. Furfural	42

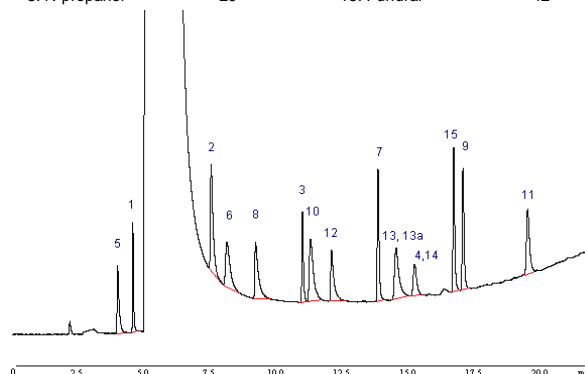

Figure 5: GC analysis of 15 alcohol congeners on Supel-Q plot capillary column

Conclusions

This study shows that the separation of the 15 alcohol congeners which are the major components found in alcoholic beverages can be achieved using capillary columns. A capillary column is thus a possible alternative to replace the conventional packed column for alcoholic beverage analysis. However, the study also reveals that none of a single packed (Carbowax 20M) or a capillary column can fully separate all the 15 alcohol congeners. As an option, the use of two different capillary columns may provide a better solution, which can be accomplished on the Shimadzu GC-2010, a GC system designed for dual-column analyses of a same sample with two FID detectors simultaneously.

References

- [1] AOAC Official Methods 972.10. Alcohols (Higher) and Ethyl Acetate in Distilled Liquors, 2000, 17th ed.
- [2] AOAC Official Methods 972.11. Methanol in Distilled Liquors, 2000, 17th ed, AOAC International.
- [3] Official Journal of the European Communities L333/36. Determination of Volatile Substances and Methanol of Spirit Drinks.
- [4] Restek Technical Guide. Analyzing Alcoholic Beverages by Gas Chromatography. www.restekcorp.com
- [5] Supelco Application Note 164. The Analysis of Alcoholic Beverages on a 30m x 0.25mm ID x 1.0um SPB-20 Capillary Column. www.sigmaaldrich.com
- [6] Supelco Bulletin 790C. Improved Resolution of Alcoholic Beverage Components by Packed Column GC. www.sigmaaldrich.com

Disclaimer: The Shimadzu GC-2010 system and the data in this Application News are intended for Research Use Only (RUO). Not for use in diagnostic procedures.

Gas Chromatograph

Nexis GC-2030



The Next Industry Standard

Nexis GC-2030, Shimadzu's premier gas chromatograph, offers a modern approach to a classic chromatographic technique. Designed with the user in mind, new innovative features, exceptional performance and high-throughput capabilities will elevate your lab to the next level.

Designed with the Analyst in Mind

An advanced interface enables intuitive operation with clear graphics. Shimadzu's latest tool-free maintenance technology makes daily maintenance easy.

World's Highest*¹ Sensitivity and Reproducibility

Achieves the world's highest*¹ sensitivity on the all of the detectors, such as FID and BID. The advanced flow controller (AFC) enhances reliability with excellent repeatability.

Exceptional Expandability and Productivity

Nexis GC-2030 can be customized to meet a customers' specific requirements and needs. Options and functions to use hydrogen carrier gas safely in high-speed analysis maximize analysis productivity.



Information at Your Finger-tips

Analysts will benefit from the touch panel interface, which features clear graphics that display information instantly whenever needed. The user-friendly interface leaves the operator free to focus on obtaining optimal analytical results.

Main settings controllable via the touch panel on the GC unit:

- Analytical conditions
- Self-diagnostics
- Automatic carrier gas leak check
- Chromatogram display, etc.

Tool-free Column Installation

ClickTek connectors*2 make tool free column installation a snap. The click sensation felt when finished attaching the column provides a more reliable connection and ensures a better seal under all operating conditions.

*2 Optional

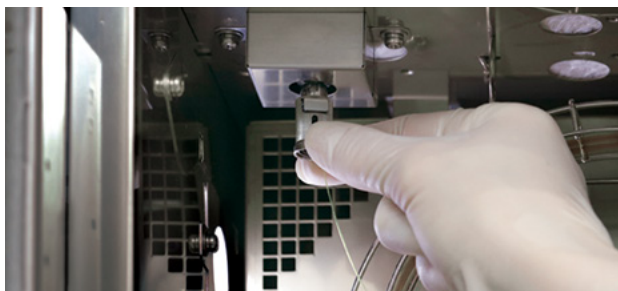

ClickTek Connector

One Touch Inlet Maintenance

The injection port can be opened or closed without tools by simply sliding the ClickTek lever. Replace the insert, slide the lever and feel the click for a leak-free install every time.



ClickTek Nut

High-Sensitivity Detectors Support a Wide Variety of Analyses

The jet and collector structure on the flame ionization detector (FID-2030) has been optimized to provide improved performance. Noise levels were also decreased by improving the stability of the signal processor and flow controller. This results in the world's most*1 sensitive FID. This makes the Nexis GC-2030 the best choice to measure residual solvents in pharmaceuticals.

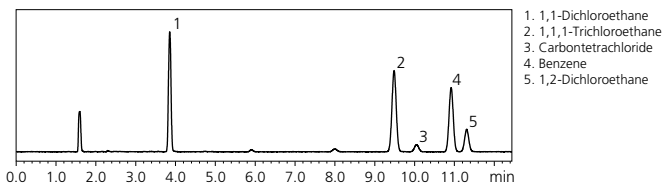

Analysis of Trace Residual Solvents in Pharmaceuticals Using Headspace GC, Class 1 Standard Solution

GC Systems Customized for Specific Needs

The Nexis GC-2030 provides powerful support for configuring custom GC systems tailored to user needs. These systems are adjusted and tested at the factory for the given application before shipment, so they are ready to use for measurements as soon as they are delivered. That means no time is required for developing methods after the system arrives. Two TCD detectors and one FID detector can be installed at the same time. An optional valve box can be added to control up to eight valves from the original four.

Examples of System GC Configurations

Gasoline analysis system

This system is able to measure specific substances in gasoline, such as oxygenates.

Natural gas analysis system

This system is able to analyze components in natural gas, such as shale gas.

Inorganic gas analysis system

This system is able to measure hydrogen and various other inorganic gases.

Hydrocarbon analysis system

This system is able to measure hydrocarbons that are generated, such as from catalyst reactions.

Refinery gas analysis system

This system is able to analyze components in gas from petroleum refineries.

Public utility natural gas analysis system

This system is able to calculate calorific values from measurements of natural gas.



*1 As of May 2017, according to a Shimadzu survey



Shimadzu Corporation

www.shimadzu.com/an/

For Research Use Only. Not for use in diagnostic procedures.

This publication may contain references to products that are not available in your country. Please contact us to check the availability of these products in your country.

Company names, product/service names and logos used in this publication are trademarks and trade names of Shimadzu Corporation or its affiliates, whether or not they are used with trademark symbol "TM" or "®". Third-party trademarks and trade names may be used in this publication to refer to either the entities or their products/services. Shimadzu disclaims any proprietary interest in trademarks and trade names other than its own.

The contents of this publication are provided to you "as is" without warranty of any kind, and are subject to change without notice. Shimadzu does not assume any responsibility or liability for any damage, whether direct or indirect, relating to the use of this publication.

© Shimadzu Corporation, 2017
First Edition: May 2017, Printed in Japan 3655-05713-30ANS

Application News

No. L471

High Performance Liquid Chromatography

Comprehensive Two-Dimensional Analysis of Polyphenols in Red Wine Using Nexera-e Coupled with SPD-M30A

Phenolic compounds are created as secondary metabolites in plants. In many cases, their structures contain multiple aromatic rings and a hydroxyl group. These polyphenols are known to display antioxidant effects, and are said to be effective in preventing arteriosclerosis and cerebral infarction. Red wine is known to contain large amounts of polyphenols, including flavonoids and phenolic acids, and in recent years has attracted considerable attention due to the health benefits associated with these substances. Regarding the analysis of polyphenols in red wine, separation and quantitation of these polyphenols by simultaneous analysis using HPLC is difficult due to the presence of many coexisting substances. The Nexera-e comprehensive two-dimensional liquid chromatograph can be very effective for such an analysis.

Comprehensive Two-Dimensional Separation with SPD-M30A at Appropriate Wavelengths for Respective Analytes

By using the Nexera-e with a photodiode array detector (PDA), a target component can be separated from a complicated mixture of coexisting substances, and then quantitated, all in a single analysis. In the analysis, assuming ethyl gallate, tyrosol and rutin as the target compounds, the ChromSquare dedicated software was applied to generate a contour plot using the respective optimal wavelengths, thereby permitting both separation and quantitation. Fig. 1 shows the contour plots at the respective optimal wavelengths, along with the 1D and 2D gradient profiles generated using the auto-gradient feature.

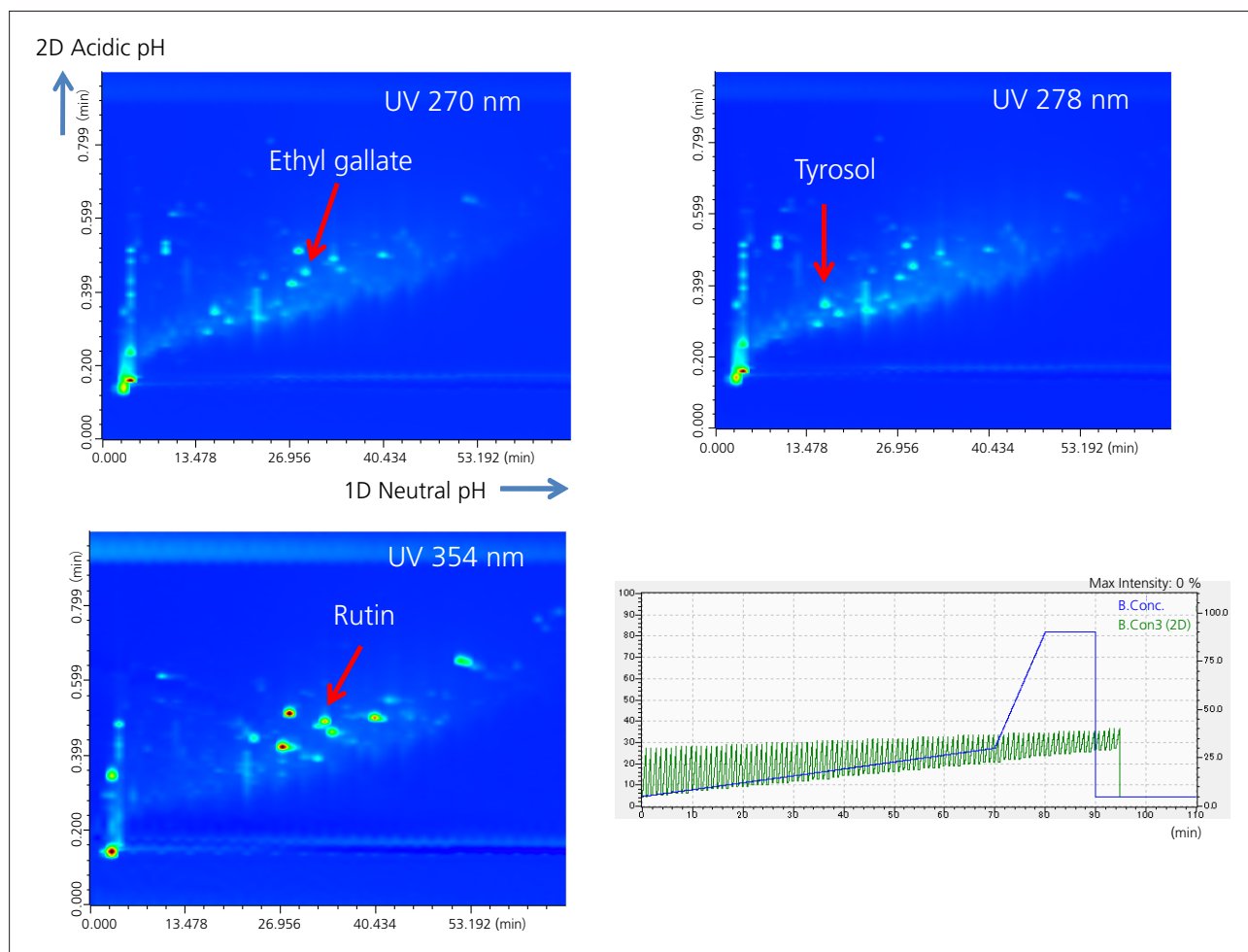

Fig. 1 Comparison of Comprehensive-2D Separation of Commercial Red Wine with Appropriate Wavelength Obtained Using "Auto-Gradient" Profile Feature

Quantitation of Ethyl Gallate, Rutin, and Tyrosol in Red Wine

The analytical conditions are shown in Table 1. We attempted to conduct separation by reversed-phase × reversed phase using a neutral phosphate buffer solution in the 1st dimension, and an acidic phosphate buffer solution in the 2nd dimension.

The calibration curve for each substance was generated using 6 concentrations in the range of 5 - 250 mg/L. The red wine sample was filtered through a 0.22 μm

membrane filter, and then injected. Fig. 2 shows the calibration curve for ethyl gallate. Also, Table 2 shows the repeatability of the total and 2D retention times, respectively, for the three analytes, the blob area repeatability values corresponding to the peak areas, the calibration curve coefficient of determination (R^2) values, and the respective quantitation values.

Table 1 Analytical Conditions

1D Column	: Shim-pack XR-ODS II (100 mm L. × 1.5 mm I.D., 2.2 μm)
Mobile Phase	: A : 10 mM (sodium) phosphate buffer pH = 6.8 B : acetonitrile
Flowrate	: 0.05 mL/min
Time Program	: B Conc. 5 % (0 min) → 30 % (70 min) → 90 % (80 min) → 90 % (90 min) → 5 % (90.1 min) → STOP (110 min)
Column Temp.	: 40 °C
Injection Vol.	: 3 μL
Loop Vol.	: 50 μL (Modulation time: 60 sec)
2D Column	: Kinetex XB-C18 (50 mm L. × 3 mm I.D., 2.6 μm)
Mobile Phase	: A : 10 mM (sodium) phosphate buffer pH = 2.6 B : acetonitrile
Flowrate	: 2 mL/min
Time Program	: Auto-gradient: Initial. B Conc. 5 % (0 min) → 30 % (0.75 min) → 5 % (0.76 min) → STOP (1 min) Final. B Conc. 30 % (0 min) → 40 % (0.75 min) → 30 % (0.76 min) → STOP (1 min) The initial and final B Conc. were changed in a stepwise manner.
Detector	: SPD-M30A photodiode array detector (high sensitivity cell 1 μL, wavelength = 270 nm, 278 nm, 354 nm)

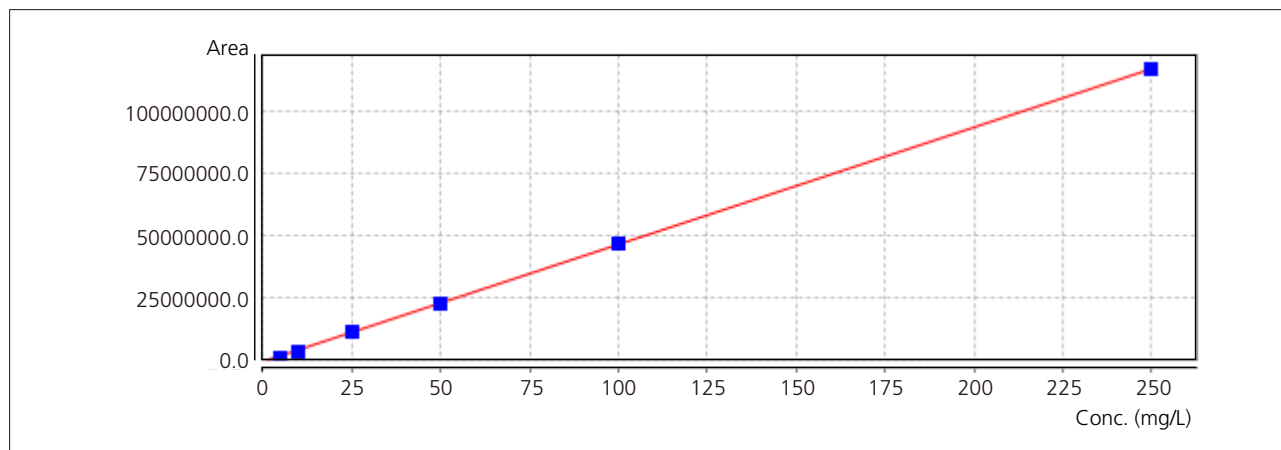

Fig. 2 Calibration Curve for Ethyl Gallate

Table 2 Repeatability of Retention Time and Blob Area (%RSD, n = 5), R^2 Value and Concentration (mg/L)

Compound	Total retention time	Retention time (2D)	Area	R squared	Concentration
Tyrosol	0.007	0.159	2.7	0.999804	101.5
Ethyl gallate	0.007	0.49	3.8	0.999864	15.1
Rutin	0.007	0.52	4.1	0.998805	14.2

Application News

No.L492A

High Performance Liquid Chromatography

Comprehensive 2D Separation of Triglycerides in Vegetable Oil with ELSD/LCMS-IT-TOF Detection

Triglycerides, molecules consisting of a glycerol backbone to which three fatty acids are attached via ester bonds, are considered important functional components in both animal oil and vegetable oil. Triglycerides display low solubility in aqueous solvents, and their separation has typically been conducted by either silver ion-mediated normal phase analysis or reversed phase analysis using an organic solvent. However, as there are numerous molecular species consisting of combinations of fatty acids, mutual separation of the triglycerides in natural fats can be difficult using any single set of separation conditions. The Nexera-e comprehensive two-dimensional liquid chromatograph effectively achieves mutual separation of such complex components.

When conducting comprehensive two-dimensional liquid chromatography, different separation modes are generally selected for the first and second-dimension separations, and depending on the differences in separation selectivity between these dimensions, improved separation is typically seen for components that are difficult to separate in a single, one-dimensional analysis. Here, using borage oil as a sample that contains many triglycerides, micro-scale separation was conducted in the first separation using a silver column (normal phase conditions), and reversed phase separation was conducted in the second dimension by using a two-liquid gradient with non-aqueous organic solvents. Detection was conducted using a combination of an evaporative light scattering detector (ELSD) and an ion trap time-of-flight mass spectrometer (LCMS-IT-TOF). The analytical conditions are shown in Table 1.

Comprehensive Separation of Triglycerides in Borage Oil with ELSD Detection

Borage oil is a vegetable oil that is obtained from the seeds of *Borago officinalis*, an annual herb. Rich in triglycerides containing such fatty acid chains as linoleic acid, γ -linolenic

acid, oleic acid, and palmitic acid, it offers a variety of health effects associated with these substances, such as moisturizing effect, wrinkle prevention, etc. Compared with other vegetable oils, Borage oil is rich in γ -linolenic acid, which is said to be effective in maintaining female hormonal balance. Triglycerides in natural fats and oils are generally characterized by the lengths of their alkyl chains and the number and positions of the double bonds in the alkyl chains. Triglycerides having double bonds in particular are said to possess antioxidant action, and there is considerable demand for the separation of these triglycerides depending on the presence or absence of double bonds. It is known that strong interaction is displayed by the formation of a complex comprising the double bond of an alkyl chain with a silver ion. Utilizing this property, an HPLC method in which a stationary phase impregnated with silver is relatively often used to achieve selective retention of compounds containing double bonds. Here, using the Nexera-e to achieve comprehensive separation of multiple components, a silver ion column (normal phase conditions) with strong retention for double bonds was used for the first-dimension separation, an ultra-high-speed reversed phase analytical column was used for the second-dimension separation, and an ELSD was used for detection.

The ELSD converts the target compound to fine particles by evaporating the eluent exiting the column, and by measuring the scattered light, triglycerides, which display almost no UV absorption, are effectively detected. Fig. 1 shows a comprehensive two-dimensional representation of the separation pattern (horizontal axis: separation in the first dimension with a silver ion column \times vertical axis: reversed phase separation in the second dimension) generated using the specialized two-dimensional analysis software, ChromSquare. The use of comprehensive two-dimensional separation permitted difficult-to-achieve high separation using a single set of separation conditions, by which thirty-seven of the elution peaks were confirmed.

Table 1 Analytical Conditions

[Column1]	: Ag custom column (150 \times 1.0 mm; 5.0 μ m)
Mobile Phase	: A; 1.5 % v/v of Butyronitrile in n-Hexane B; 2.4 % v/v of Butyronitrile in n-Hexane
Time Program	: B Conc. 0 % (0 min) \rightarrow 100 % (40 min) \rightarrow 100 % (150 min)
Flowrate	: 0.007 mL/min (split)
Column Temp.	: 30 $^{\circ}$ C
Injection Volume	: 2 μ L
Modulation Time	: 1.5 min
[Column2]	: Ascentis Express C18 column (Supelco, 50 \times 4.6 mm; 2.7 μ m)
Mobile Phase	: A; Acetonitrile B; Isopropanol
Time Program	: B Conc. 30 % (0 min) \rightarrow 30 % (0.08 min) \rightarrow 40 % (0.1 min) \rightarrow 70 % (1.2 min) \rightarrow 30 % (1.21 min) \rightarrow 30 % (1.5 min)
Detector	: Shimadzu ELSD LT-II
Flowrate	: 4 mL/min
Evaporative Temperature	: 58 $^{\circ}$ C
Nebulizing Gas Pressure	: 260 kPa
Detector	: LCMS-IT-TOF
Flowrate	: 2 mL/min from the 2D pump was split to 0.8 mL/min prior entering the APCI probe.
[MS Conditions]	
Ionization Mode	: APCI positive
Nebulizer Gas Flow	: 2.0 L/min
Interface Temperature	: 400 $^{\circ}$ C
Block Heater Temperature	: 230 $^{\circ}$ C
CDL Temperature	: 230 $^{\circ}$ C
Scan	: <i>m/z</i> 300-1200

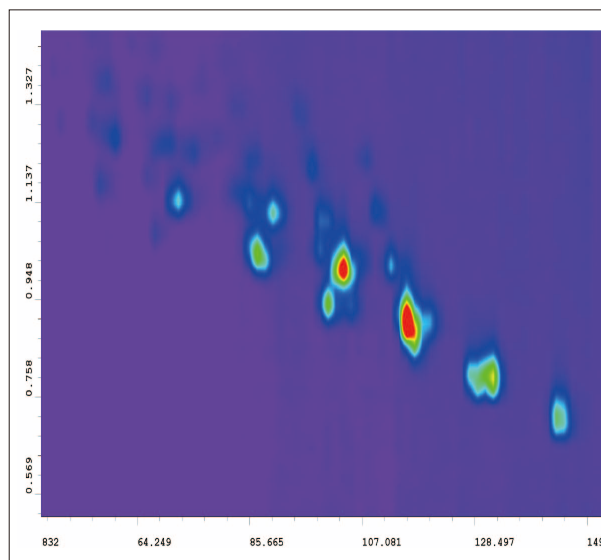

Fig. 1 Comprehensive 2D Plot of Triglycerides in Borage Oil with ELSD Detection

Comprehensive Separation of Triglycerides in Borage Oil with LCMS-IT-TOF Detection

As mentioned above, separation in the first dimension in this analysis is conducted based on the presence or absence or the difference in the number of double bonds in the fatty acid side chain. When a silver ion column is used, the greater the number of double bonds in the triglyceride, the stronger the retention will be. However, it is also possible that retention will be affected depending on the positions of the double bonds or the side chain length. In the second-dimension reversed phase separation, two-solution gradient elution is adopted in which, due to the high hydrophobicity of triglycerides, neither water nor buffer solution, etc., is used, but a non-aqueous organic solvent is used for the mobile phase. With this separation mode, elution tends to proceed in the order obtained by subtracting twice the number of double bonds from the total number of triglyceride carbon atoms, which is referred to as the partition number. The top portion of Fig. 2 shows a two-dimensional plot drawn based on the output of the LCMS-IT-TOF mass spectrometer. To facilitate identification of triglycerides using the order of elution described above, a grid is drawn superimposed on the plot. From this plot, it can be seen how separation is conducted according to the difference in the number of double bonds in the first dimension, and the difference in

partition number in the second dimension.

Use of the LCMS-IT-TOF as the detector for precise mass measurement in the second dimension permits detailed qualitative analysis of the many components eluted following separation by the Nexera-e. The mass spectra corresponding to the white-circled peaks A, B and C of Fig. 2 are shown in the lower part of Fig. 2. The structural information was obtained from the peak of diglyceride with one side chain detached, and the triglyceride structure were determined as follows:

- A : POP
- B : OOP
- C : γ LnP

Where,

- P : Palmitic acid
- O : Oleic acid
- γ Ln : γ -Linolenic acid

Since these compounds each have one to three double bonds, they are eluted from the first-dimension column in this order. As lipid-related compounds often display no UV absorption, and gradient elution cannot be applied with differential refractive index detection, a combination of the Nexera-e and ELSD, or a triple quadrupole or LCMS-IT-TOF mass spectrometer can be considered essential for exhaustive analysis in this field.

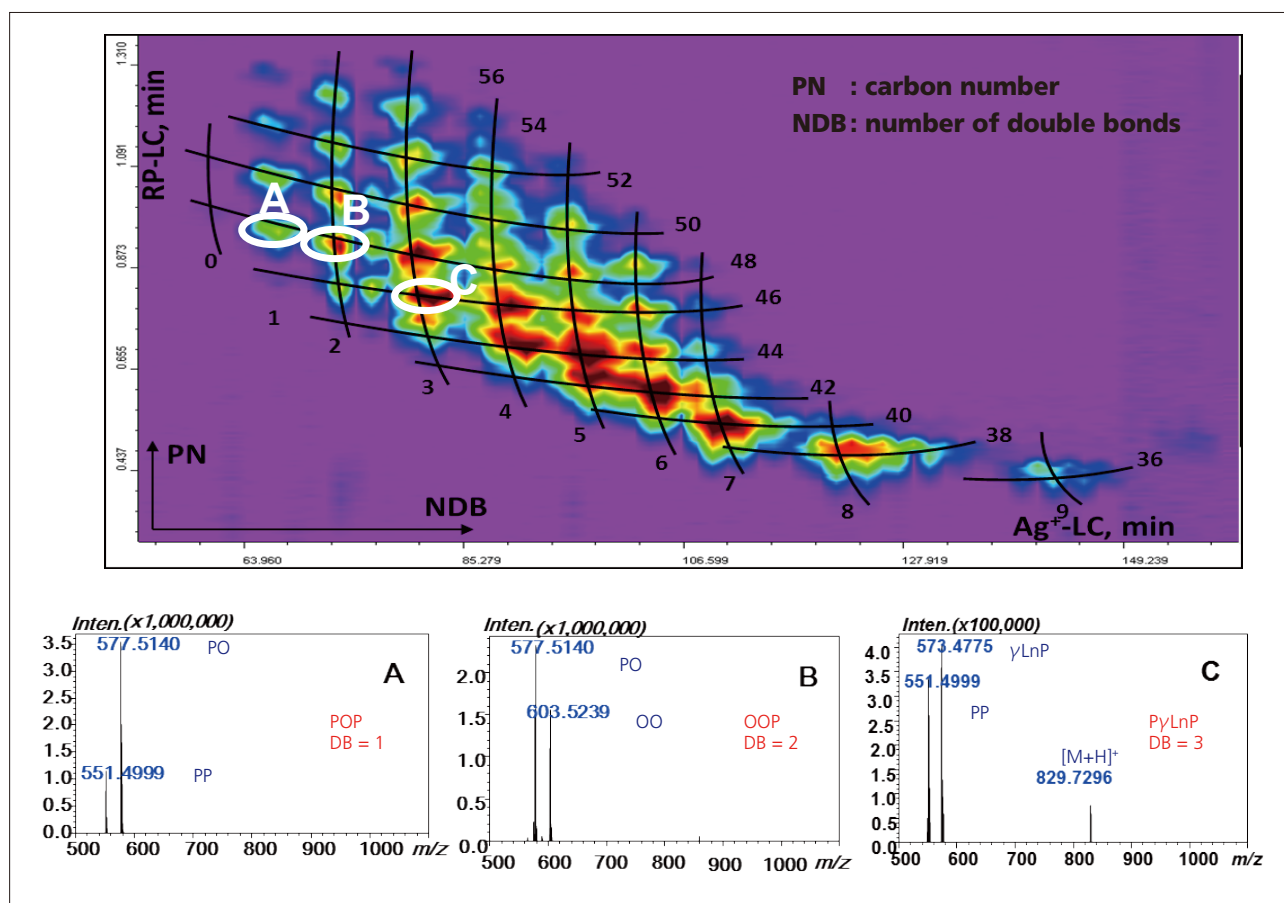

Fig. 2 Comprehensive 2D Plot of Triglycerides in Borage Oil with LCMS-IT-TOF in Addition to the Mass Spectra of Assigned Blobs

Data provided by University of Messina Prof. Luigi Mondello and Chromaleont S.r.l.

Application News

No.L491

High Performance Liquid Chromatography

Comprehensive 2D Separation of Carotenoids in Red Chili Pepper by the Nexera-e System

Carotenoids are naturally occurring organic pigments that are divided into two classes, carotenes, consisting only of carbon and hydrogen, and xanthophylls, which contain oxygen. Carotenoids are rich in double bonds, and therefore have received much attention in recent years as antioxidants, which are known for their disease preventive properties, including lifestyle-related diseases.

The extensive range of carotenoids found in foods makes it difficult to conduct simultaneous separation and quantitation by conventional HPLC. However, the Nexera-e comprehensive two-dimensional LC is particularly suited for such analyses. Here, carotenoids extracted from red chili pepper were subjected to two-dimensional analysis, in which micro-scale separation was conducted in the first stage using normal phase conditions, and separation using reversed phase conditions was tried in the second dimension. For detection, a combination of a photodiode array (PDA) connected to the LCMS-8030 triple quadrupole mass spectrometer was used. Because the separation modes, normal and reversed phases, differ in the first and second dimensions, this might be considered a two-dimensional LC method by which the greatest orthogonality possible is obtained.

Comprehensive Separation of Carotenoids Detected by the Photodiode Array Detector

Use of the Nexera-e with a photodiode array detector (PDA) permits the separation of complex coexisting substances and detection at the optimal wavelength in a single analysis. Fig. 1 shows a comprehensive two-dimensional representation of the separation pattern (absorption wavelength = 450 nm) generated using the specialized two-dimensional analysis software, ChromSquare.

By combining the first-dimension cyano column and the second-dimension ODS column, 10 groups of substances, including hydrocarbons, monoal esters, diol diesters, diol monoketo diesters, diol diketo diesters, diol mono epoxide monoesters, free monoals, diol monoketo monoesters, diol diketo mono esters, and polyoxygenated free xanthophylls were separated according to class based on molecular polarity, and the component separation was verified based on the hydrophobicity of their respective fatty acid residues.

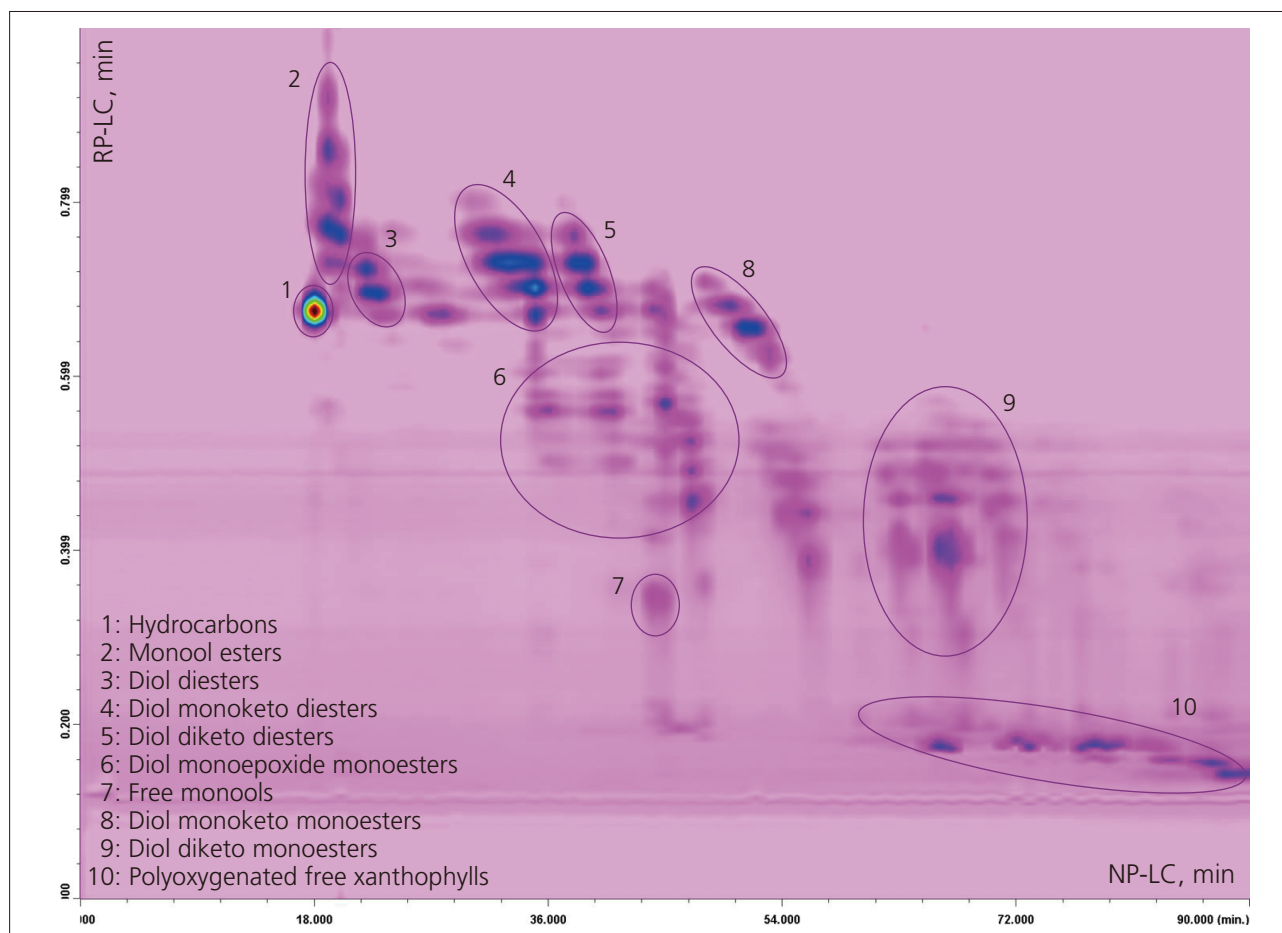

Fig. 1 2D Plot of Carotenoids Using ChromSquare Software

■ Quantitation of β -Carotene in Red Chili Pepper by LC/MS/MS

The analytical conditions are shown in Table 1, and the sample pretreatment conditions are shown in Fig. 2. β -carotene, which is a precursor of vitamin A, was detected in the two-dimensional separation of the carotenoids. Quantitation was then conducted using the LCMS-8030 triple quadrupole mass spectrometer. Both high sensitivity and high selectivity can be obtained using MRM analysis, and further, reduced ion suppression can be expected with the two-dimensional

separation obtained with the Nexera-e. Fig. 3 shows the two-dimensional separation data of β -carotene obtained from DUIS-positive mode MRM analysis of the calibration curve, and Fig. 4 shows the linearity of the three values (blobs) in the range of 0.01 to 10 mg/L, which correspond to the peak volumes used for quantitation. The correlation coefficient (r) = 0.998976 indicates results with good linearity. The quantitative result for β -carotene present in red chili pepper was calculated as 1.22 mg/L based on the concentration in the final sample following extraction.

Table 1 Analytical Conditions

1D Column	: Ascentis Cyano (250 mm L. x 1.0 mm I.D., 5 μ m)
Mobile Phase	: A; Hexane B; Hexane/Butylacetate/Acetone = 80/15/5 (v/v/v)
Flowrate	: 0.02 mL/min
Time Program	: B Conc. 0 % (0.01 min) \rightarrow 0 % (5 min) \rightarrow 100 % (65 min) \rightarrow 100 % (75 min) \rightarrow 0 % (76 min)
Column Temp.	: 30 $^{\circ}$ C
Injection vol.	: 2 μ L
Loop vol.	: 20 μ L
2D Column	: Ascentis Express C18 (30 mm L. x 4.6 mm I.D., 2.7 μ m)
Mobile Phase	: A; acetonitrile B; 2-propanol
Flowrate	: 4 mL/min (0.8 mL/min split for MS)
Time Program	: B Conc. 0 % (0.01 min) \rightarrow 50 % (0.17 - 0.54 min) \rightarrow 80 % (0.54 - 0.93 min) \rightarrow 30 % (0.94 min) \rightarrow STOP (1 min)
Detector	: SPD-M30A Photo diode array detector (standard cell, wave length = 450 nm) Shimadzu LCMS-8030 (DUIS positive mode, targeted β -carotene MRM transition: m/z 536.40 > 444.30)

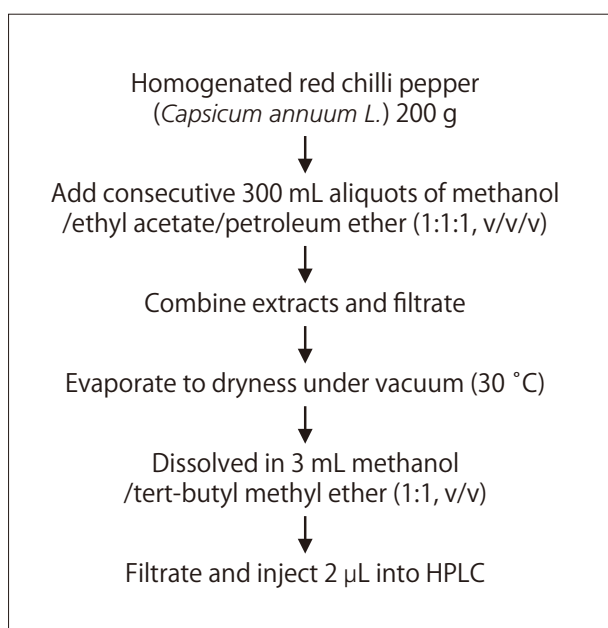

Fig. 2 Sample Preparation

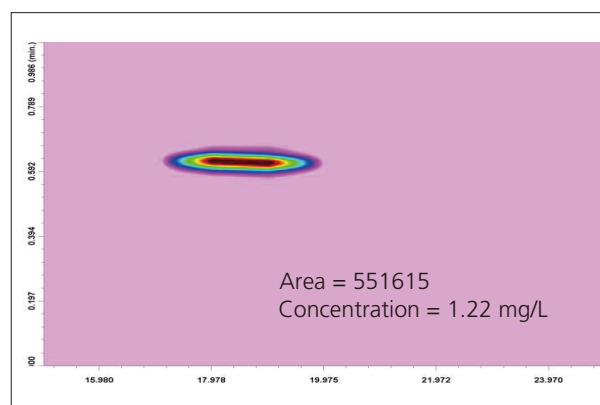

Fig. 3 2D Plot of β -Carotene

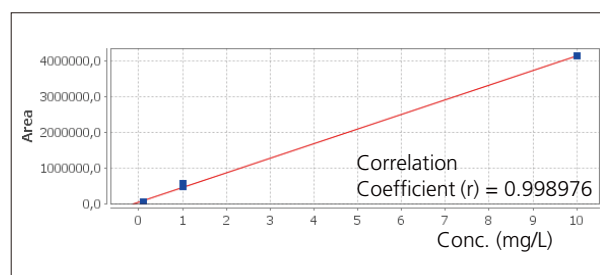

Fig. 4 Linearity of Calibration Curve for β -Carotene

Data provided by University of Messina Prof. Luigi Mondello and Chromaleont S.r.l.

First Edition: May, 2015

Comprehensive Two-Dimensional Liquid Chromatograph

Nexera-e

Catch the peaks behind the peaks

The Nexera-e comprehensive two-dimensional liquid chromatograph (LCxLC) effectively separates samples with complex constituents, including pharmaceutical impurities, proteolytic enzyme digests, natural materials such as food extracts, and synthetic polymers.

The dedicated LCxLC-Assist and ChromSquare software provide excellent usability and visibility, and allow the analyst to quickly analyze a large number of sample components.

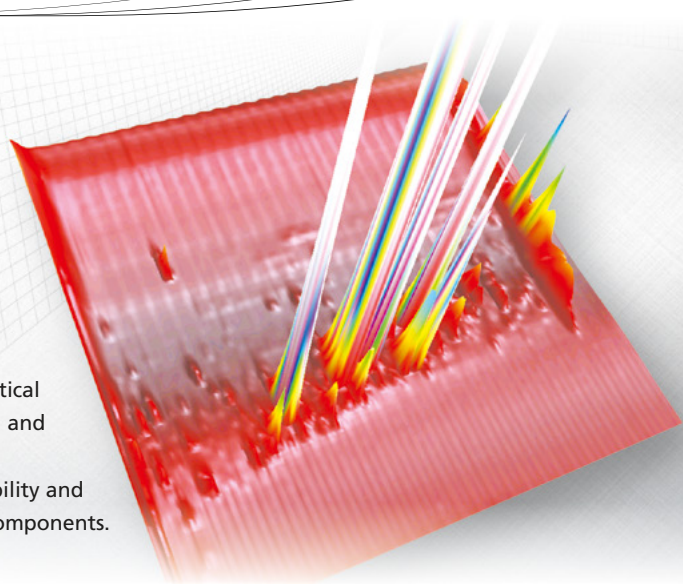

Achieving High-Resolution Analysis with LCxLC

Comprehensive two-dimensional liquid chromatography (2D-LC) is a completely new analytical technique combining two different separation modes orthogonally to provide a substantial improvement in separation performance. Combining multiple separation modes enables the separation of components that conventional one-dimensional liquid chromatography has difficulty separating, and allows the analysis of complex samples.

Comprehensive 2D-LC also differs from conventional 2D-LC by acquiring data that show the results of both first- and second-dimension separations, which allows the analyst to maximize the effectiveness of both separating systems.

Time programming for the second-dimension separation is configured in detail based on target component elution times and eluate solvent concentrations from the first-dimension separation, which allows the discovery of components otherwise hidden among target components.

LCxLC-Assist and ChromSquare are dedicated software for the Nexera-e. They offer excellent operability and visibility, and provide powerful support for LCxLC analysis.

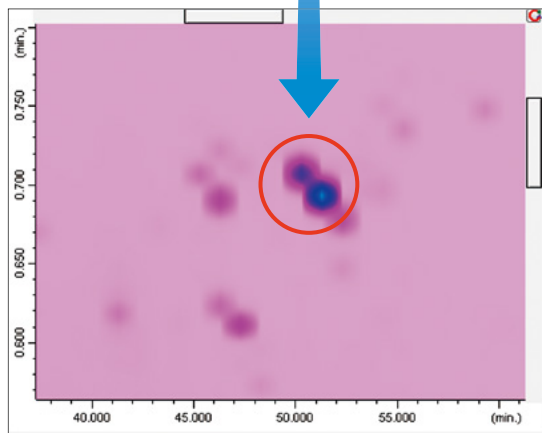
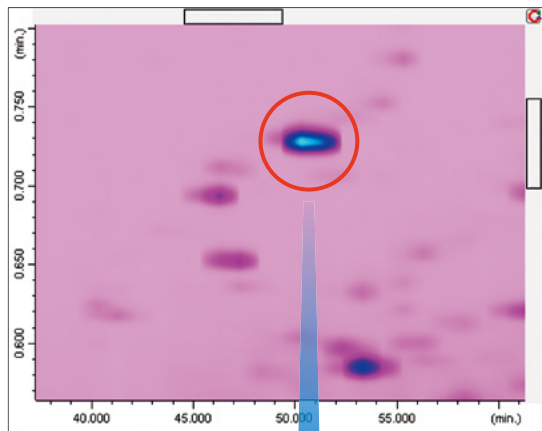

Example Analysis of Glycyrrhizic Acid in Kakkonto

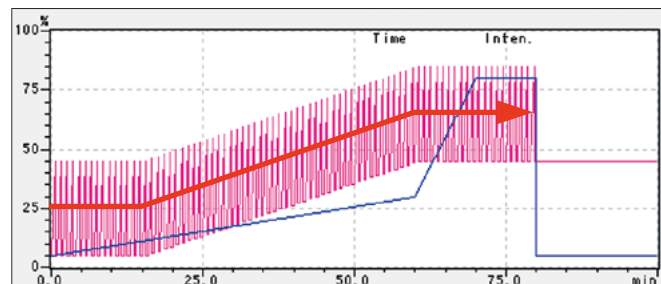
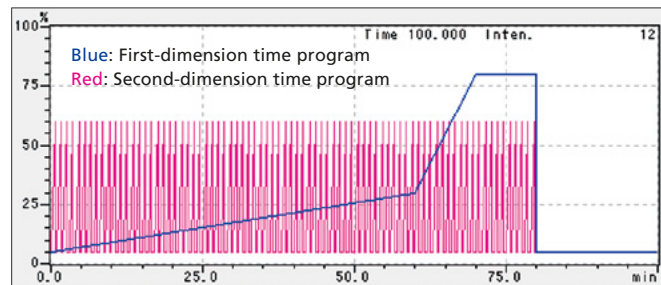

LCxLC-Assist Method Creation Support Software

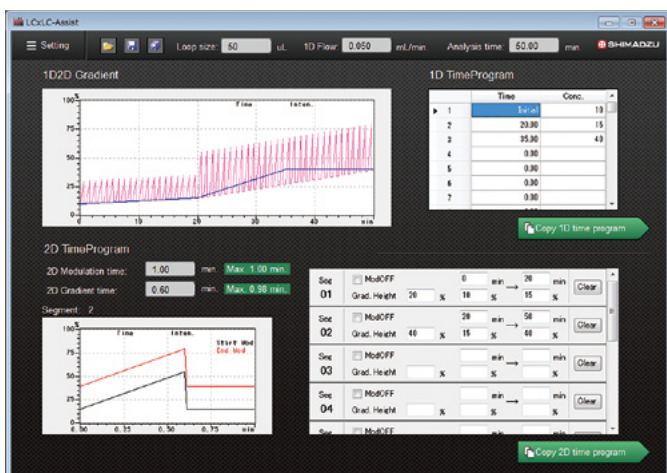

LCxLC analysis involves dozens of gradient analyses in the second-dimension separation mode, which requires complex time programming including valve controls.

LCxLC-Assist method creation support software allows easy creation of complex time programming, including the SIF function, by just entering the minimum necessary number of parameters while watching the resulting gradient curve.

ChromSquare Data Analysis Software

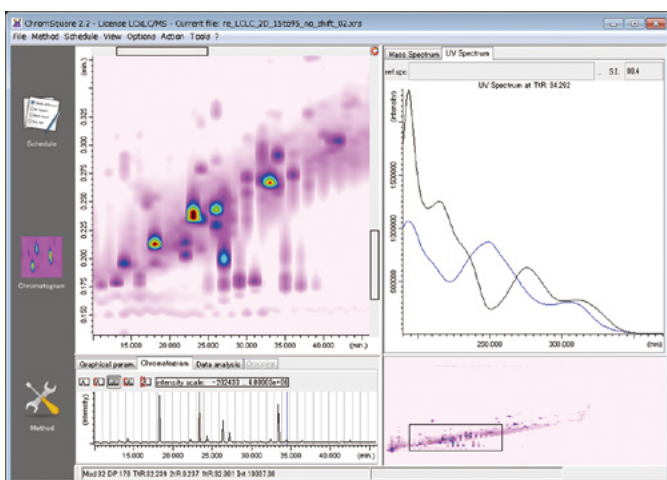

ChromSquare converts the data obtained from LCxLC analysis into two-dimensional data, and performs qualitative and quantitative analysis of this two-dimensional data.

A contour plot (2D map), second-dimension chromatogram, and MS or UV spectrum are displayed in a single window.

The data shown in the second-dimension chromatogram and the MS or UV spectrum change according to the position of the analyst's cursor on the 2D map, which allows the analyst to quickly analyze complex samples.

Note: ChromSquare is a product of Chromaleont S.r.l. in Italy.



Shimadzu Corporation
www.shimadzu.com/an/

For Research Use Only. Not for use in diagnostic procedures.

This publication may contain references to products that are not available in your country. Please contact us to check the availability of these products in your country.

Company names, products/service names and logos used in this publication are trademarks and trade names of Shimadzu Corporation, its subsidiaries or its affiliates, whether or not they are used with trademark symbol "TM" or "®".

Third-party trademarks and trade names may be used in this publication to refer to either the entities or their products/services, whether or not they are used with trademark symbol "TM" or "®".

Shimadzu disclaims any proprietary interest in trademarks and trade names other than its own.

The contents of this publication are provided to you "as is" without warranty of any kind, and are subject to change without notice. Shimadzu does not assume any responsibility or liability for any damage, whether direct or indirect, relating to the use of this publication.

Application News

No. C149

Liquid Chromatograph Mass Spectrometry

Developing a Chiral Amino Acid Analysis Method That Uses Column Switching

With the exception of glycine, the 20 types of amino acids that make up proteins occur as D and L optical isomers. L-amino acids occur in large quantities in the body as protein components and sources of nutrients. As for D-amino acids, despite the fact that they are much less abundant than L-amino acids, they are attracting attention in various fields as components associated with the component analysis of fermented foods, physiological functions in the central nervous system, biomarkers, and even health and beauty.

Analysis of D-amino acids is susceptible to interference by a wide variety of peptides and amino compounds, and therefore requires high sensitivity and highly selective

analysis methods for accurate measurement. Furthermore, conventional optical separation analysis of amino acids necessitated derivatization and long separation times of the amino acids.

This article introduces a rapid analysis method that employs chiral columns to achieve high separation and high sensitivity and that dispenses with derivatization [1]. This system uses two types of chiral columns alternately with high-pressure column switching valves (FCV) and allows fully automatic analysis of a wide range of D- and L-amino acids.

Y. Uno, T. Hattori

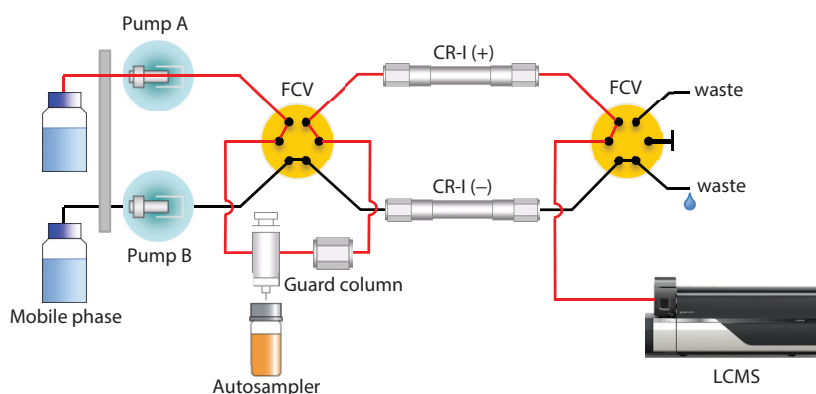

Fig. 1 Chiral Amino Acid Analysis System That Uses Column Switching

A system capable of analysis by automatically switching between two column types, CR-I (+) and CR-I (-), using two high-pressure column switching valves (FCV) was configured (Fig. 1). Pump A is connected to CR-I (+) and pump B is connected to CR-I (-). This means that even if one column is undergoing analysis, the other column can undergo stabilization without stopping mobile phase delivery.

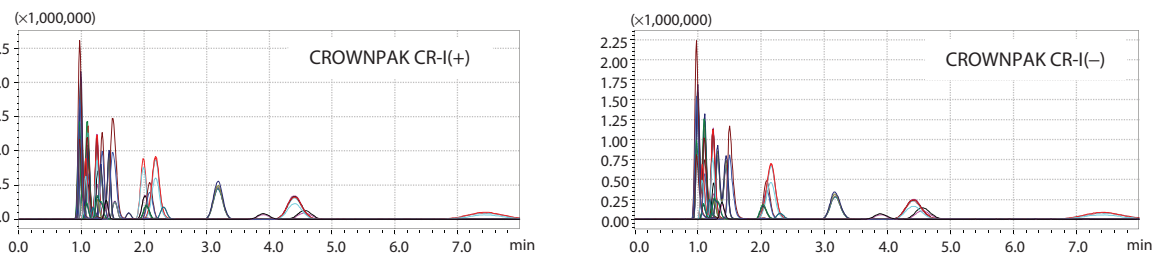

Fig. 2 MRM Chromatograms of D- and L-Amino Acids in Standard Mixed Solution (Sample Concentration: 1 ng/1 μ L)

Table 1 Analysis Conditions

Column	: CROWNPAK CR-I (+) / CR-I (-) (3 mm \times 150 mm, 5 μ m, DAICEL Corp.)
Mobile phase	: Acetonitrile/ethanol/water/TFA = 80/15/5/0.5
Flow rate	: 0.6 mL/min
Injection volume	: 1 μ L
Oven temperature	: 20 $^{\circ}$ C
Ionization mode	: ESI (Positive)
Probe voltage	: +4.0 kV
Neburizing gas flow	: 3.0 L/min
Drying gas flow	: 15.0 L/min
Heating gas flow	: 5.0 L/min
Interface temperature	: 250 $^{\circ}$ C
DL temperature	: 250 $^{\circ}$ C
Block heater temperature	: 300 $^{\circ}$ C

■ Analysis of Standard Solution

This system was employed to analyze a standard mixed solution using ¹³C₆-L-Phe as the internal standard (Fig. 2). Approximately equal area ratios were obtained with CR-I (+) and CR-I (-) for the amino acids other than Gln, Lys, Ile, *allo*-Ile, Thr, and *allo*-Thr, and this confirmed that the system is capable of separation measurement (Table 2).

With CR-I (+), L-Gln and D-Lys, D-Ile and D-*allo*-Ile, and D-Thr and D-*allo*-Thr, which each have the same MRM transition, are detected with the same peak and therefore cannot be separated.

With CR-I (-), D-Gln and L-Lys, L-Ile and L-*allo*-Ile, and L-Thr and L-*allo*-Thr, which each have the same MRM transition, are detected with the same peak and therefore cannot be separated.

However, separation measurement can be performed for these amino acids by utilizing two types of columns. For example, while D-Thr and D-*allo*-Thr cannot be separated with CR-I (+) and L-Thr and L-*allo*-Thr cannot be separated with CR-I (-), interchanging the column types allows for separation measurement (Fig. 3).

Table 2 Analysis Results of Standard Solution

	CR-I (+)		CR-I (-)		Ratio of Area (+)/(-)
	RT	Ratio of Area	RT	Ratio of Area	
D-Ala	1.394	0.728	3.894	0.751	0.97
L-Ala	3.908	0.565	1.389	0.632	0.89
D-Arg	0.973	3.999	1.506	3.239	1.23
L-Arg	1.499	5.633	0.981	6.718	0.84
D-Asn	1.255	1.018	2.036	1.030	0.99
L-Asn	2.036	0.805	1.263	0.911	0.88
D-Asp	1.253	0.742	2.039	0.863	0.86
L-Asp	2.036	0.72	1.259	0.775	0.93
D-Cys	1.183	0.405	2.307	0.458	0.89
L-Cys	2.308	0.789	1.186	0.797	0.99
D-Gln	1.247	2.111	2.161	3.478	with L-Lys 0.61
L-Gln	2.183	4.947	1.239	3.686	with D-Lys 1.34
D-Glu	1.246	2.972	4.426	3.262	0.91
L-Glu	4.388	3.506	1.24	3.731	0.94
Gly	2.827	0.037	2.796	0.039	0.93
D-His	0.967	2.797	1.099	3.917	0.71
L-His	1.09	3.699	0.977	2.969	1.25
D-Ile	0.988	4.745	1.446	2.983	with D- <i>allo</i> -Ile 1.59
L-Ile	1.44	2.325	0.998	4.408	with L- <i>allo</i> -Ile 0.53
D- <i>allo</i> -Ile	0.988	4.745	1.313	2.926	with D-Ile 1.62
L- <i>allo</i> -Ile	1.308	1.844	0.998	4.101	with L-Ile 0.45
D-Leu	1.107	2.019	3.178	2.400	0.84
L-Leu	3.179	2.929	1.105	3.364	0.87
D-Lys	2.181	4.621	7.395	1.641	with L-Gln 2.82
L-Lys	7.348	1.795	2.161	5.118	with D-Gln 0.35
D-Met	1.259	1.704	4.554	1.859	0.92
L-Met	4.556	0.938	1.25	1.060	0.89
D-Phe	1.101	1.568	2.087	1.974	0.79
L-Phe	2.089	2.175	1.106	2.280	0.95
DL-Pro	0.957	2.756	0.971	3.105	0.89
D-Ser	1.222	0.224	1.756	0.253	0.89
L-Ser	1.758	0.307	1.226	0.301	1.02
D-Thr	1.023	1.339	1.53	0.968	with D- <i>allo</i> -Thr 1.38
L-Thr	1.533	0.851	1.033	1.324	with L- <i>allo</i> -Thr 0.64
D- <i>allo</i> -Thr	1.023	1.339	1.205	0.573	with D-Thr 2.34
L- <i>allo</i> -Thr	1.197	0.480	1.033	1.397	with L-Thr 0.34
D-Trp	1.105	2.839	1.99	3.344	0.85
L-Trp	1.988	3.458	1.111	3.510	0.99
D-Tyr	1.103	1.203	2.016	1.560	0.77
L-Tyr	2.016	1.448	1.109	1.455	1.00
D-Val	0.999	1.826	1.337	2.052	0.89
L-Val	1.331	3.170	1.008	3.251	0.97

indicates amino acids that can be separated by one column but not the other.

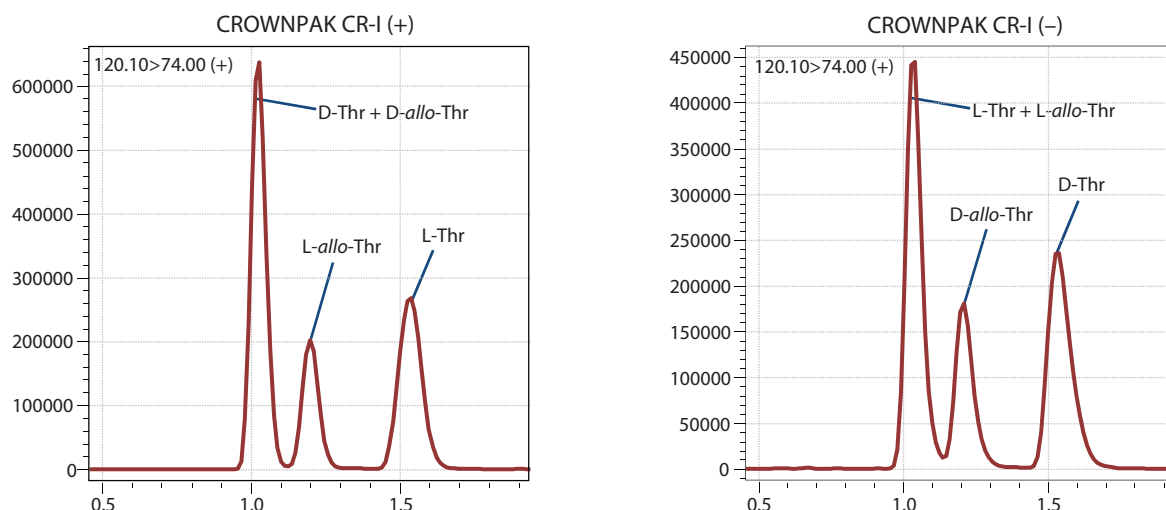

Fig. 3 Analysis Result of D/L-Threonine and D/L-*allo*-Threonine

References [1] Nakano, Y., Konya, Y., Taniguchi, M., Fukusaki, E., *Journal of Bioscience and Bioengineering*, 123, 134-138 (2016)

The analysis method presented in this edition of Application News was developed by the Fukusaki Lab in the School/Graduate School of Engineering at Osaka University.

First Edition: Apr. 2017



For Research Use Only. Not for use in diagnostic procedure.

This publication may contain references to products that are not available in your country. Please contact us to check the availability of these products in your country.

The content of this publication shall not be reproduced, altered or sold for any commercial purpose without the written approval of Shimadzu. Company names, product/service names and logos used in this publication are trademarks and trade names of Shimadzu Corporation or its affiliates, whether or not they are used with trademark symbol "TM" or "®". Third-party trademarks and trade names may be used in this publication to refer to either the entities or their products/services. Shimadzu disclaims any proprietary interest in trademarks and trade names other than its own.

The information contained herein is provided to you "as is" without warranty of any kind including without limitation warranties as to its accuracy or completeness. Shimadzu does not assume any responsibility or liability for any damage, whether direct or indirect, relating to the use of this publication. This publication is based upon the information available to Shimadzu on or before the date of publication, and subject to change without notice.

Shimadzu Corporation

www.shimadzu.com/an/

Application News

No. C156

Liquid Chromatograph Mass Spectrometry

Analysis of Chiral Amino Acids within Fermented Beverages Utilizing a Column Switching System

With the exception of glycine, the 20 types of amino acids that make up proteins occur as D and L optical isomers. In recent years, it has been found that D-amino acids are contained in various foods such as fruits and vegetables, although much less abundant than L-amino acids. Particularly, it is known that fermented foods contain a number of D-amino acids.

The D-amino acids contained in foods have various effects. D-alanine, D-leucine, and D-phenylalanine are known to taste sweeter than their L-amino acid counterparts. For this reason, the amount of D-amino acids contained in a fermented food is considered to affect the taste of the food, and high sensitivity and highly selective analysis methods for D-amino acids in fermented foods are gaining attention.

This article introduces an example analysis of fermented beverages using a column switching system (introduced in Application News No. C149) which alternates between two types of chiral columns using high-pressure column switching valves (FCV).

Y. Uno, T. Hattori

Sample Pretreatment

Three types of black vinegar beverages and two types of yogurt beverages were used as samples. Each sample was pretreated by liquid-liquid extraction using water, methanol, and chloroform^{*1}. Fig. 1 indicates the protocol.

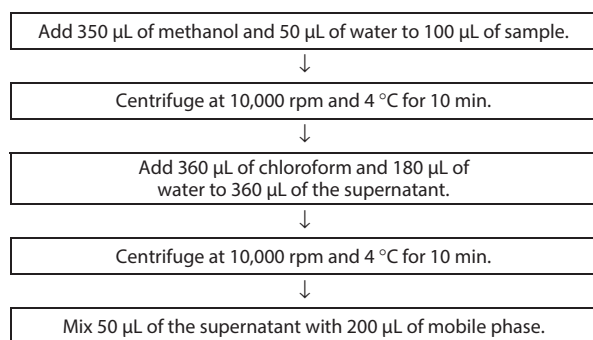

Fig. 1 Pretreatment Protocol

Table 1 Measurement Conditions

Column	: CROWNPAK CR-I(+)/CR-I(-) (3 mm × 150 mm, 5 µm)
Mobile phase	: acetonitrile/ethanol/water/TFA = 80/15/5/0.5
Flow rate	: 0.6 mL/min.
Injection volume	: 1 µL
Oven temperature	: 20 °C
Ionization mode	: ESI (Positive)
Probe voltage	: +4.0 kV
Nebulizing gas flow	: 3.0 L/min.
Drying gas flow	: 15.0 L/min.
Heating gas flow	: 5.0 L/min.
Interface temperature	: 250 °C
DL temperature	: 250 °C
Block heater temperature	: 300 °C

Analysis Results of Black Vinegar Beverages

We verified that D-amino acids are contained in all three types of black vinegar beverages (Table 2). The obtained D/L ratios indicate that black vinegar beverages B and C contain D-Ala in relatively large amounts.

Table 2 D/L Ratio of Amino Acids in Black Vinegar Beverages

	Black Vinegar Beverage A		Black Vinegar Beverage B		Black Vinegar Beverage C	
	Area	Ratio of D/L	Area	Ratio of D/L	Area	Ratio of D/L
D-Ala	7127	3.8 %	54094	20.5 %	26505	15.5 %
L-Ala	187083		263547		171483	
D-Arg	23703	0.6 %	81626	2.4 %	106896	1.7 %
L-Arg	3945110		3353883		6214029	
D-Asn	7047	1.3 %	11213	3.4 %	13135	3.0 %
L-Asn	547867		333152		433012	
D-Asp	6934	1.5 %	7086	2.3 %	8248	2.2 %
L-Asp	476730		302901		370152	
D-Cys	(N.D.)	-	(N.D.)	-	(N.D.)	-
L-Cys	(N.D.)	-	(N.D.)	-	(N.D.)	-
D-Gln	4153	56.1 %	5013	128.1 %	5738	17.3 %
L-Gln	7399		3912		33155	
D-Glu	11658	0.7 %	36502	2.2 %	7575	1.1 %
L-Glu	1635202		1675657		713130	
Gly	2375	-	6382	-	3163	-
D-His	(N.D.)	-	(N.D.)	-	(N.D.)	-
L-His	351973	-	410895	-	232228	-
D-Ile	1262	0.3 %	(N.D.)	-	1861	0.6 %
L-Ile	392041		580580		330869	
D-allo-Ile	1816	50.3 %	(N.D.)	-	2519	136.9 %
L-allo-Ile	3612		4357		1840	
D-Leu	3255	0.5 %	4698	0.5 %	4198	0.9 %
L-Leu	691108		1031536		493487	
D-Lys	13921	1.4 %	4446	0.4 %	28009	5.1 %
L-Lys	965688		1220610		548517	
D-Met	(N.D.)	-	(N.D.)	-	(N.D.)	-
L-Met	22647	-	48753	-	13151	-
D-Phe	2738	0.4 %	3587	0.7 %	3634	0.9 %
L-Phe	746758		549410		419561	
DL-Pro	301069	-	683984	-	549718	-
D-Ser	10568	9.3 %	8036	7.5 %	4653	8.5 %
L-Ser	113543		106729		54472	
D-Thr	2646	1.7 %	4374	2.3 %	2036	1.2 %
L-Thr	159723		193429		170581	
D-allo-Thr	1973	91.6 %	3538	120.7 %	1297	66.6 %
L-allo-Thr	2153		2932		1946	
D-Trp	2098	23.2 %	2195	39.1 %	4159	39.6 %
L-Trp	9045		5609		10506	
D-Tyr	7314	1.7 %	2495	0.8 %	4026	1.4 %
L-Tyr	437963		314522		297401	
D-Val	3046	0.5 %	3186	0.4 %	3613	0.9 %
L-Val	573054		870777		387972	

■ Analysis Results of Yogurt Beverages

We verified that D-amino acids are contained in both types of yogurt beverages (Table 3). The obtained D/L ratios indicate that D-Ala, -Arg, -Asn, -Asp, -Glu, -Lys, and -Ser amino acids are contained in relatively large amounts. Particularly, D-Glu is contained in both yogurt beverages by over 40 times more than L-Glu.

Table 3 D/L Ratio of Amino Acids in Yogurt Beverages

	Yogurt D		Yogurt E	
	Area	Ratio of D/L	Area	Ratio of D/L
D-Ala	140959	164.0 %	37900	40.2 %
L-Ala	85940		94190	
D-Arg	81779	6.9 %	95602	36.5 %
L-Arg	1192614		262060	
D-Asn	60836	43.2 %	3209	16.5 %
L-Asn	140872		19416	
D-Asp	47149	38.1 %	2441	15.3 %
L-Asp	123860		16003	
D-Cys	(N.D.)	-	(N.D.)	-
L-Cys	(N.D.)		(N.D.)	
D-Gln	4743	0.6 %	5157	19.8 %
L-Gln	856603		26021	
D-Glu	412572	4091.1 %	163715	5069.6 %
L-Glu	10085		3229	
Gly	957	-	1106	-
D-His	(N.D.)		(N.D.)	
L-His	839834	-	175326	5.2 %
D-Ile	1428		1366	
L-Ile	176626	0.8 %	130832	1.0 %
D-allo-Ile	2225	59.4 %	1247	39.3 %
L-allo-Ile	3744		3172	
D-Leu	4042	1.0 %	(N.D.)	-
L-Leu	403567		132923	
D-Lys	1151264	73.5 %	24797	3.5 %
L-Lys	1565451		698677	
D-Met	463	0.9 %	(N.D.)	-
L-Met	54490		(N.D.)	
D-Phe	1600	0.5 %	1799	1.5 %
L-Phe	313615		117732	
DL-Pro	2094819	-	888155	-
D-Ser	14619		8332	
L-Ser	101651	14.4 %	28395	29.3 %
D-Thr	1711	1.5 %	3314	4.6 %
L-Thr	112074		71653	
D-allo-Thr	1973	42.5 %	1020	23.7 %
L-allo-Thr	4647		4294	
D-Trp	3039	1.9 %	1879	13.3 %
L-Trp	155899		14086	
D-Tyr	4882	2.1 %	5876	107.4 %
L-Tyr	230926		5470	
D-Val	1241	0.4 %	1277	0.9 %
L-Val	285792		148323	

■ Comparison of D/L Amino Acid Amounts in Fermented Beverages

We next compared the amount of amino acids in the black vinegar and yogurt beverages with regard to the amino acids which were found in relatively large amounts as D isomers (Fig. 2). This comparison shows that the yogurt beverages contain more types of D-amino acids compared to the black vinegar beverages. D-Ala and D-Ser were found in both the black vinegar and the yogurt beverages, but the yogurt beverages contain more D-Ala than the black vinegar beverages. The L-Glu contained in the yogurt beverages is far less in amount than that contained in the black vinegar beverages. Furthermore, the amount of D-Glu contained in the yogurt beverages is relatively large considering the amount of L-Glu contained in the black vinegar beverages.

Yogurt beverage D contains various types of D-amino acids in relatively large amounts. Particularly, D-Ala and D-Lys were contained in large amounts in comparison with the black vinegar beverages.

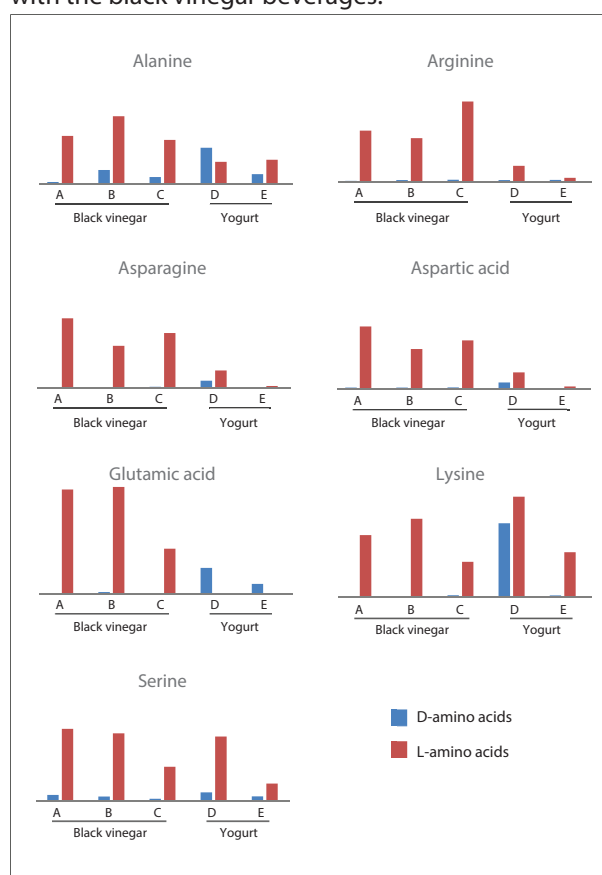

Fig. 2 Comparison of D/L Amino Acids in Black Vinegar Beverages and Yogurt Beverages

These analysis results indicate that actual samples can be effectively analyzed and that this column switching system is useful for the analysis of chiral amino acids.

Reference

*1 Nakano, Y., Konya, Y., Taniguchi, M., Fukusaki, E., Journal of Bioscience and Bioengineering, 123, 134-138 (2016)

First Edition: Jun. 2017



Shimadzu Corporation

www.shimadzu.com/an/

For Research Use Only. Not for use in diagnostic procedure.

This publication may contain references to products that are not available in your country. Please contact us to check the availability of these products in your country.

The content of this publication shall not be reproduced, altered or sold for any commercial purpose without the written approval of Shimadzu. Company names, product/service names and logos used in this publication are trademarks and trade names of Shimadzu Corporation or its affiliates, whether or not they are used with trademark symbol "TM" or "®". Third-party trademarks and trade names may be used in this publication to refer to either the entities or their products/services. Shimadzu disclaims any proprietary interest in trademarks and trade names other than its own.

The information contained herein is provided to you "as is" without warranty of any kind including without limitation warranties as to its accuracy or completeness. Shimadzu does not assume any responsibility or liability for any damage, whether direct or indirect, relating to the use of this publication. This publication is based upon the information available to Shimadzu on or before the date of publication, and subject to change without notice.

For LabSolutions LCMS

LC/MS/MS Method Package for D/L Amino Acids



LCMS-8060

Most important amino acids exist as stereoisomers. D- and L- forms of mirror image isomers, or enantiomers, are named according to their activity on polarized light. By using CROWNPAK CR-I(+) and CR-I(-) columns with chiral stationary phases, the D- and L-forms of amino acids can be analyzed separately. With CR-I(+) elution order is from D- to L-, and with CR-I(-) the elution order is reversed.

In Just Ten Minutes, Chiral Amino Acids Can Be Analyzed Simultaneously

With conventional chiral amino acid analysis, it is necessary to perform derivatization or use very long run times. With this method package, derivatization is not necessary, and high-sensitivity analysis can be performed in a short period of time, bringing efficiency to the chiral separations laboratory.

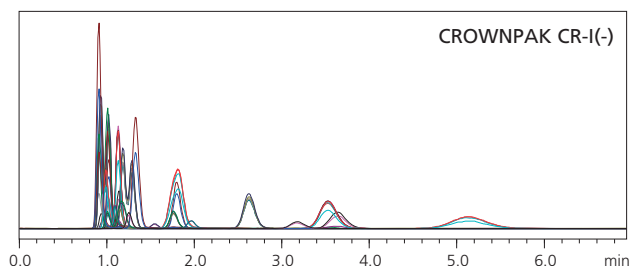
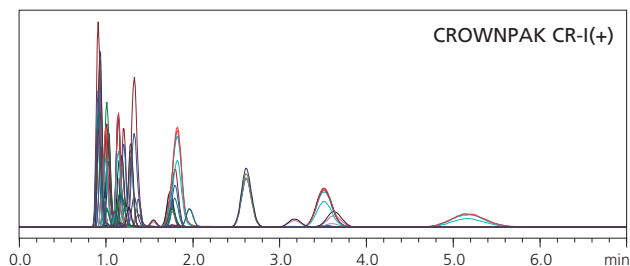

HPLC Conditions

Column	: CROWNPAK CR-I(+)/(-) (3 mmI.D. x 150 mmL., 5 μm)
Mobile Phase	: Acetonitrile/Ethanol/Water/TFA = 80/15/5/0.5
Flowrate	: 0.6 mL/min
Injection Volume	: 1 μL
Column Temp.	: 25 °C

MS Conditions

Nebulizer Gas Flowrate	: 3.0 L/min
Drying Gas Flowrate	: 15.0 L/min
Heating Gas Flowrate	: 5.0 L/min
Interface Temp.	: 250 °C
DL Temp.	: 250 °C
Heat Block Temp	: 300 °C

LC/MS/MS Method Package for D/L Amino Acids

All D/L Amino Acids Can Be Quantified by Column Switching

The physicochemical properties of Glutamine and Lysine, Isoleucine and allo-Isoleucine, Threonine and allo-Threonine are extremely similar. They have virtually the same MS/MS fragmentation patterns, and share many of their MRM transitions. Chromatographic separation is therefore required to analyze them individually by LC-MS/MS. Even if there is coelution on the CR-I(+) column, confirmation can be made by automated switching to a secondary CR-I(-) column.

Analysis of D/L-Isoleucine, D/L-*allo*-Isoleucine, and D/L-Leucine

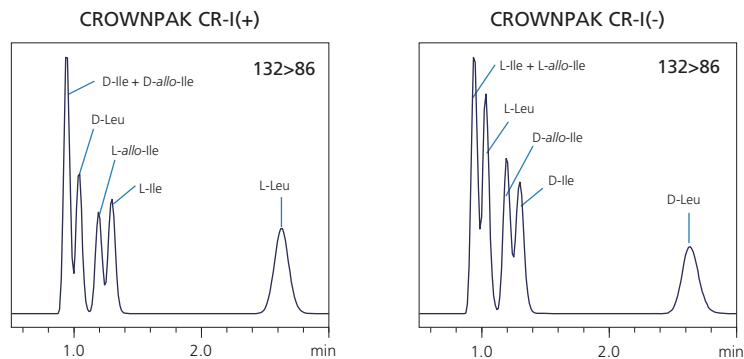

Analysis of D/L-Threonine, and D/L-*allo*-Threonine

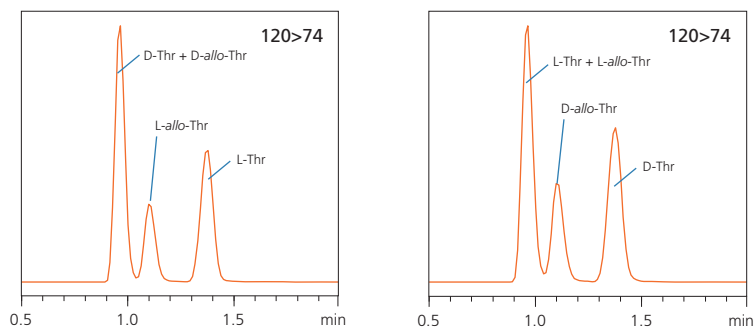

List of Registered Amino Acids

D/L-Alanine
D/L-Arginine
D/L-Asparagine
D/L-Aspartic acid

D/L-Cysteine
D/L-Glutamine
D/L-Glutamic acid
Glycine

D/L-Histidine
D/L-Isoleucine
D/L-*allo*-Isoleucine
D/L-Leucine

D/L-Lysine
D/L-Methionine
D/L-Phenylalanine
DL-Proline

D/L-Serine
D/L-Threonine
D/L-*allo*-Threonine
D/L-Tryptophane

D/L-Tyrosine
D/L-Valine

Precautions

- DL-Proline is a secondary amine, so it cannot be separated with these analysis conditions.
- LabSolutions LCMS Ver. 5.86 or later is required.

CROWNPAK CR-I(+) and CR-I(-) are products of Daicel Corporation.



Shimadzu Corporation
www.shimadzu.com/an/

For Research Use Only. Not for use in diagnostic procedures.

This publication may contain references to products that are not available in your country. Please contact us to check the availability of these products in your country.

Company names, products/service names and logos used in this publication are trademarks and trade names of Shimadzu Corporation, its subsidiaries or its affiliates, whether or not they are used with trademark symbol "TM" or "®".

Third-party trademarks and trade names may be used in this publication to refer to either the entities or their products/services, whether or not they are used with trademark symbol "TM" or "®".

Shimadzu disclaims any proprietary interest in trademarks and trade names other than its own.

The contents of this publication are provided to you "as is" without warranty of any kind, and are subject to change without notice. Shimadzu does not assume any responsibility or liability for any damage, whether direct or indirect, relating to the use of this publication.

Application News

No. M271

Gas Chromatography Mass Spectrometry

Investigating Food Quality Evaluation: Complete Analysis of Aroma Compounds and Metabolites in Food

There are a wide variety of methods of ensuring food quality evaluation, and which method is used depends on the food type and purpose of examination. An evaluation method widely implemented in recent years has been to analyze all various compounds present in food, then to use multivariate analysis to find trends in these compounds that can be linked to food quality.

Much research is being conducted into the measurement of all aroma compounds and metabolites present in food, using these results as an indicator of food qualities such as flavor, functionality, and deterioration.

This Application News presents the results of an experiment that set out to measure aroma compounds and metabolites present in sake, and investigated which of these compounds could be used to distinguish between different sake types. Three commercially available sakes, including a normal quality sake (*futsu-shu*), a sake made with rice and malted rice (*junmai-shu*), and sake made with the rice polished to at least 50 % (*daiginjo-shu*), were analyzed for aroma compounds and metabolites. The main compounds found in these sakes were then identified and analyzed further. We were able to clearly separate a pattern of detected compounds in these three types of sake. Combining this method of quality control with conventional methods such as sensory evaluation will allow for the collection of more precise and revealing quality control data.

1. Analysis of Aroma Compounds

■ Sample

Three sakes of different brands were obtained as samples.

To these sakes were added ultrapure water and 1 mg/mL of an aqueous solution of 3-octanol to prepare samples that contained 10 % ethanol and 0.5 mg/L of 3-octanol. From each sample prepared in this manner was taken 1 mL, which was added to a headspace sampler vial, to which was added 0.5 g of sodium chloride. The samples were confirmed to be saturated with sodium chloride. These vials were then inserted into a headspace sampler and used for analysis.

■ Analytical Conditions

Table 1 Analytical Conditions for Aroma Compound Analysis

Headspace sampler	: HS-20
Triple quadrupole gas chromatograph mass spectrometer	: GCMS-TQ8040
HS	
Mode	: Trap
Trap Tube	: Tenax GR
Number of Multi-Injections	: 5
Oven Temperature	: 70 °C
Sample Line Temperature	: 150 °C
Transfer Line Temperature	: 150 °C
Vial Pressurization Gas Pressure	: 100 kPa
Vial Warming Time	: 10 min
Vial Pressurization Time	: 2 min
Pressurization Equalization Time	: 0.1 min
Loading Time	: 1 min
Loading Equalization Time	: 0.1 min
Injection Time	: 2 min
Needle Flush Time	: 5 min
Sample Charged Volume	: 1 mL
GC	
Column	: HP-INNOWax (60 m × 0.25 mm I.D., 0.25 μm)
Carrier Gas	: He
Control Mode	: Linear velocity (25.5 cm/sec)
Injection Method	: Split
Split Ratio	: 3
Oven Temperature	: From 40 °C (5 min) by (3 °C/min) to 240 °C (15 min)
MS (EI Method)	
Ion Source Temperature	: 200 °C
Interface Temperature	: 200 °C
Tuning Mode	: Standard
Measurement Mode	: Scan (<i>m/z</i> 35 to 350)
Event Time	: 0.3 seconds

Results

Samples of the three sake types were labeled as *futsu-shu*, *junmai-shu*, and *daiginjo-shu*. Taking the results from analysis, peak identification was performed based on the NIST 14 library and quantitative ions, reference ions, and retention indices mentioned in previous articles*. The numbers of compounds identified are shown in Table 2. The 86 compounds detected by this analysis are also listed in Table 3.

Table 2 Numbers of Compounds Detected by Aroma Compound Analysis

	<i>Futsu-shu</i>	<i>Junmai-shu</i>	<i>Daiginjo-shu</i>
Detected compounds	78	76	86

Principal Component Analysis (PCA) was performed for the 76 compounds detected in all samples. A score plot of this analysis is shown in Fig. 1. The three different sake types are clearly separated on the score plot. A loading plot of this analysis is shown in Fig. 2. Compounds characteristic to each sample were identified from these results.

The results suggest that performing a complete analysis of aroma compounds and subsequent multivariate analysis of identified compounds may be useful for food quality evaluation.

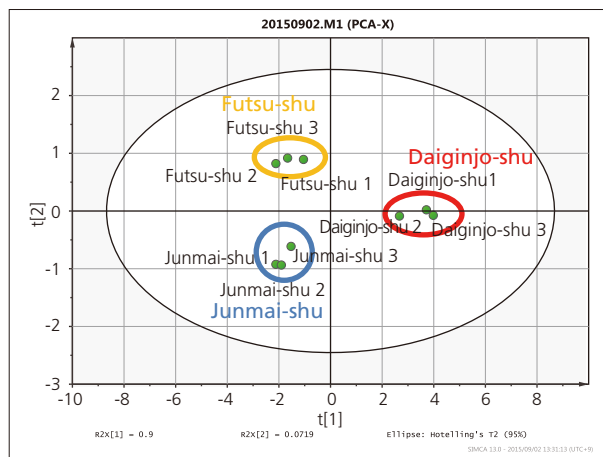

Fig. 1 Score Plot of Aroma Compound Analysis

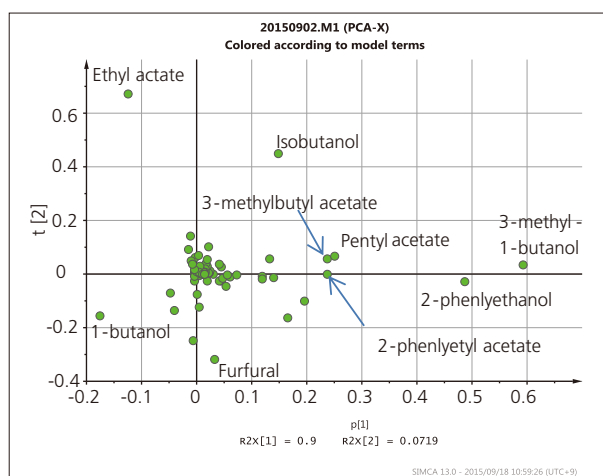

Fig. 2 Loading Plot of Aroma Compound Analysis

Table 3 List of Compounds Detected by Aroma Compound Analysis (86 Compounds)

ethyl acetate	3-methylbutyl propanoate	2-ethyl-1-hexanol	1-decanol
3-methylbutanal	4-pentenyl acetate	decanal	β -citronellol
2, 4, 5-trimethyl-1,3-dioxolane	3-methyl-1-butanol	2-nonanol	diethyl pentanedioate
ethyl propanoate	ethyl hexanoate	ethyl 3-hydroxybutanoate	ethyl phenylacetate
ethyl 2-methylpropanoate	3-octanone	benzaldehyde	2-phenylethyl acetate
propyl acetate	styrene	ethyl 2-hydroxyhexanoate	2-(2-butoxyethoxy) ethyl acetate
2, 3-butanedione	hexyl acetate	propanoic acid	hexanoic acid
isobutyl acetate	2-octanone	1-octanol	benzyl alcohol
ethyl butanoate	octanal	3-methylbutyl methoxyacetate	diethyl hexanedioate
1-propanol	acetoin	ethyl 3-methylthiopropanoate	butylated hydroxytoluene
ethyl 2-methylbutanoate	2-heptanol	ethyl decanoate	2-phenylethanol
ethyl 3-methylbutanoate	3-methyl-1-pentanol	butyrolactone	heptanoic acid
butyl acetate	ethyl heptanoate	1-nonanol	phenol
DMDS	ethyl lactate	acetophenone	dehydromevalonic lactone
1-(1-ethoxyethoxy) pentane	1-hexanol	phenylacetaldehyde	octanoic acid
isobutanol	3-ethoxy-1-propanol	furanmethanol	ethyl hexadecanoate
3-methylbutyl acetate	2-nonanone	ethyl benzoate	decanoic acid
ethyl pentanoate	ethyl octanoate	diethyl succinate	2-phenylethyl octanoate
1-butanol	1-heptanol	(Z)-3-nonen-1-ol	benzoic acid
ethyl 2-butenate	3-methylbutyl hexanoate	3-methylthio-1-propanol	dodecanoic acid
pentyl acetate	acetic acid	pentanoic acid	
2-heptanone	furfural	naphthalene	

2. Analysis of Metabolites Present in Foods

Sample

Next, metabolites present in foods were extracted from each sample, derivatized, and analyzed by GC-MS. We took 20 μL of each sample, added 60 μL of an aqueous solution of ribitol (0.2 mg/mL) as an internal standard solution, and dried this mixture thoroughly in a centrifugal concentration device. To the dried residue was added 100 μL of a methoxyamine hydrochloride/pyridine solution (20 mg/mL), and this mixture was shaken at 30 $^{\circ}\text{C}$ for 90 minutes. Subsequently, 50 μL of *N*-Methyl-*N*-(trimethylsilyl) trifluoroacetamide (MSTFA) was added, and the mixture was shaken at 37 $^{\circ}\text{C}$ for 30 minutes. This sample was then added to a GC-MS vial and used for analysis.

Analytical Conditions

Table 4 Analytical Conditions for Analysis of Metabolites Present in Foods

Triple quadrupole gas chromatograph mass spectrometer	: GCMS-TQ8040
Optional software	: Smart Metabolites Database
GC	
Column	: BPX5 (30 m \times 0.25 mm I.D., 0.25 μm)
Carrier Gas	: He
Control Mode	: Linear velocity (39.0 cm/sec)
Injection Method	: Split
Split Ratio	: 30
Oven Temperature	: From 60 $^{\circ}\text{C}$ (2 min) by (15 $^{\circ}\text{C}/\text{min}$) to 330 $^{\circ}\text{C}$ (3 min)
MS (EI method)	
Ion Source Temperature	: 200 $^{\circ}\text{C}$
Interface Temperature	: 280 $^{\circ}\text{C}$
Tuning Mode	: Standard
Measurement Mode	: MRM
Loop Time	: 0.25 seconds

Table 5 Numbers of Compounds Detected by Analysis of Metabolites Present in Foods

	<i>Futsu-shu</i>	<i>Junmai-shu</i>	<i>Daiginjo-shu</i>
Detected compounds	147	140	149

Results

Taking the results from analysis, peak identification was performed for compounds registered in the Smart Metabolites Database based on their quantitative ions, reference ions, and retention indices. The numbers of compounds identified are shown in Table 5. The 149 compounds detected by this analysis are also listed in Table 6.

Principal Component Analysis (PCA) was performed for the 138 compounds detected in all samples. A score plot of this analysis is shown in Fig. 3. The three different sake types are clearly separated on the score plot. A loading plot of this analysis is shown in Fig. 4. Compounds characteristic to each sample were identified from these results.

The results suggest that performing a complete analysis of metabolites and subsequent multivariate analysis of identified compounds may be useful for food quality evaluation.

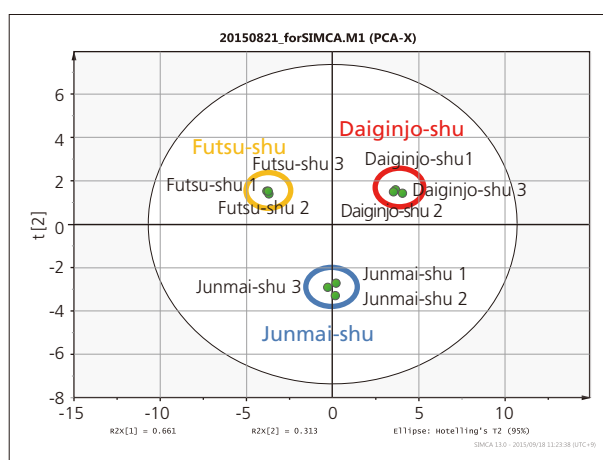

Fig. 3 Score Plot of the Analysis of Metabolites Present in Foods

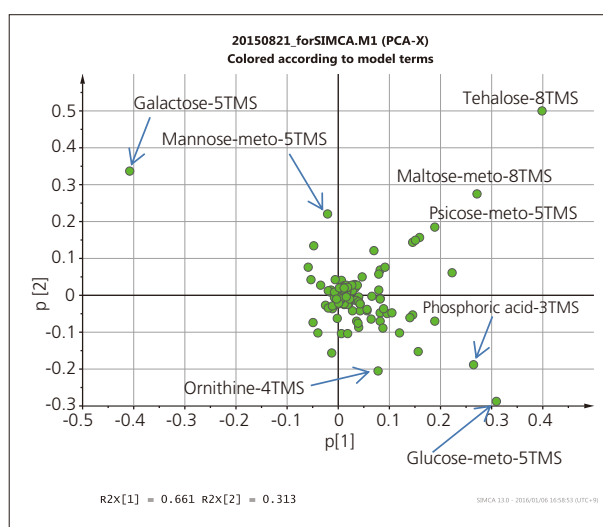

Fig. 4 Loading Plot of the Analysis of Metabolites Present in Foods

Table 6 List of Compounds Detected by Analysis of Metabolites Present in Foods (149 Compounds)

2-Aminobutyric acid	Aspartic acid	Histidine	Ornithine
2-Aminoethanol	Batyl alcohol	Homocysteine	Palmitic acid
2-Aminopimelic acid	Benzoic acid	Homoserine	Pantothenic acid
2-Deoxy-glucose	Cadaverine	Hydroxylamine	Phenylacetic acid
2-Hydroxybutyric acid	Caproic acid	Hypotaurine	Phenylalanine
2-Hydroxyglutaric acid	Citramalic acid	Hypoxanthine	Phenylpyruvic acid
2-Hydroxyisocaproic acid	Citric acid	Indol-3-acetic acid	Phosphoric acid
2-Hydroxyisovaleric acid	Cystamine	Isocitric acid	Proline
2-Isopropylmalic acid	Cystathionine	Isoleucine	Psicose-meto
2-Ketoglutaric acid	Cysteine	Lactic acid	Putrescine
3-Aminoglutaric acid	Cystine	Lactitol	Pyridoxamine-4TMS
3-Aminopropanoic acid	Cytidine	Lactose	Pyruvic acid
3-Hydroxy-3-methylglutaric acid	Cytosine	Lauric acid	Ribitol
3-Hydroxybutyric acid	Decanoic acid	Leucine	Ribose
3-Hydroxyglutaric acid	Dihydroxyacetone phosphate	Lysine	Saccharopine
3-Hydroxyisobutyric acid	Dopamine	Lyxose	Serine
3-Hydroxypropionic acid	Eicosapentaenoic acid	Maleic acid	Stearic acid
3-Methoxy-4-hydroxybenzoic acid	Elaidic acid	Malic acid	Succinic acid
3-Phenyllactic acid	Fructose	Maltitol	Tagatose
4-Aminobutyric acid	Fumaric acid	Maltose	Threitol
4-Hydroxybenzoic acid	Galactose	Mannito	Threonic acid
4-Hydroxyphenylacetic acid	Galacturonic acid	Mannose 6-phosphate	Threonine
4-Hydroxyproline	Glucose	Mannose	Thymine
5-Aminolevulinic acid	Glucuronic acid	Margaric acid	Trehalose
5-Aminovaleric acid	Glutamic acid	meso-Erythritol	Tryptophan
5-Methoxytryptamine	Glutamine	Methionine	Tyramine
5'-Methylthioadenosine	Glutaric acid	Methylsuccinic acid	Tyrosine
5-Oxoproline	Glyceric acid	Mevalonic lactone	Uracil
Acetylglycine	Glycerol 2-phosphate	Myristic acid	Urea
Aconitic acid	Glycerol 3-phosphate	N6-Acetyllysine	Uridine
Adenine	Glycero	N-Acetylmannosamin	Valine
Alanine	Glycine	Nicotinic acid	Xanthine
Allose	Glycolic acid	Nonanoic acid	Xylito
Arabinose	Glycyl-Glycine	Norvaline	Xylose
Arabitol	Glyoxylic acid	Octanoic acid	Xylulose
Arginine	Guanine	Octopamine-4TMS	
Ascorbic acid	Hexanoylglycine	Oleic acid	
Asparagine	Histamine	O-Phosphoethanolamine	

[References]

- * Natsuki Mimura, Atsuko Isogai, Kazuhiro Iwashita, Takeshi Bamba, and Eiichiro Fukusaki.
Gas chromatography/mass spectrometry based component profiling and quality prediction for Japanese sake
Journal of Bioscience and Bioengineering VOL. 118 No. 4, 406e414, 2014

First Edition: May, 2016



For Research Use Only. Not for use in diagnostic procedure.

This publication may contain references to products that are not available in your country. Please contact us to check the availability of these products in your country.

The content of this publication shall not be reproduced, altered or sold for any commercial purpose without the written approval of Shimadzu. Company names, product/service names and logos used in this publication are trademarks and trade names of Shimadzu Corporation or its affiliates, whether or not they are used with trademark symbol "TM" or "®". Third-party trademarks and trade names may be used in this publication to refer to either the entities or their products/services. Shimadzu disclaims any proprietary interest in trademarks and trade names other than its own.

The information contained herein is provided to you "as is" without warranty of any kind including without limitation warranties as to its accuracy or completeness. Shimadzu does not assume any responsibility or liability for any damage, whether direct or indirect, relating to the use of this publication. This publication is based upon the information available to Shimadzu on or before the date of publication, and subject to change without notice.

Shimadzu Corporation
www.shimadzu.com/an/

Application News

No. C132

Liquid Chromatography Mass Spectrometry

Comprehensive Analysis of Primary and Secondary Metabolites in Citrus Fruits Using an Automated Method Changeover UHPLC System and LC/MS/MS System [LCMS-8050]

Due to an increasing trend for healthy lifestyles, the functional properties of agricultural products and foods are being emphasized alongside their taste qualities, and the production and development of foods with high additional value is becoming increasingly important. Metabolome analysis, which is the comprehensive analysis of all metabolites present in a living organism, is now being applied in a variety of areas and not just to analyze the metabolites of living organisms. Metabolome analysis is becoming an important tool in the food sector in areas such as food processing and plant breeding.

In food analysis, it is very important to carry out comprehensive analysis of primary and secondary metabolites that contribute to the color, smell, taste, and functional properties of food. To date, there has been only a few examples of performing these analyses simultaneously.

In this article, we describe a method of performing comprehensive analysis of primary and secondary metabolites in food (major organic acids, amino acids, sugars, carotenoids, and flavonoids) using LC/MS/MS, and also present an example application of this analytical method using citrus fruits as an actual sample.

■ Sample Preparation

We used seven citrus fruits (mikan orange, ponkan, shiranui orange, amakusa orange, hassaku orange, buntan orange, and hyuganatsu) shown in Fig. 1. Each metabolite was fractionated and extracted using two solvents, as shown in Fig. 2.

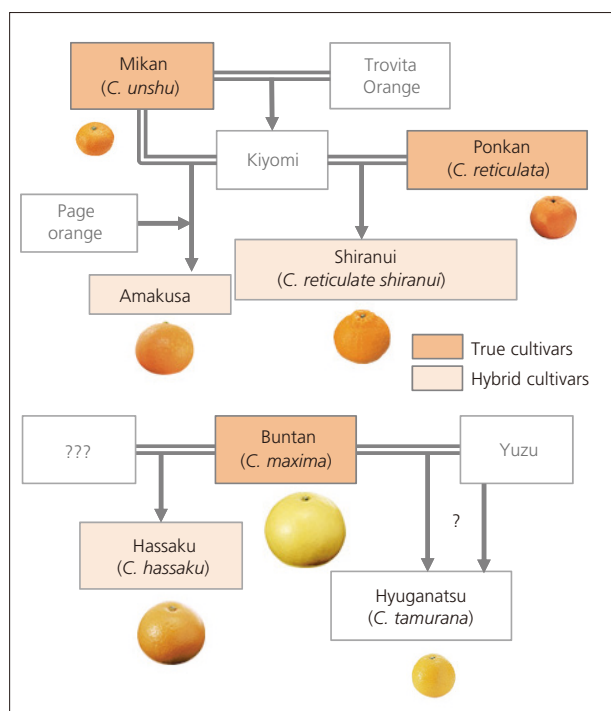

Fig. 1 Taxonomic Tree of Seven Citrus Fruits

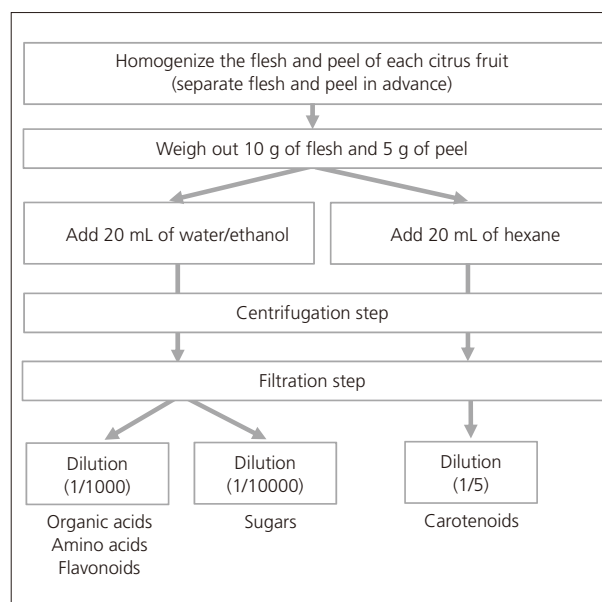

Fig. 2 Sample Pretreatment Protocol

■ LC/MS/MS Analysis

Due to the difficulty of analyzing the chemical properties of primary and secondary metabolites under the same chromatographic conditions, three chromatographic conditions were chosen that differed in mobile phase and column type. We used the Nexera method scouting system (comprehensive method search system) to perform measurements while

automatically changing between the three analytical methods (Fig. 3). Although we used four mobile phases and three columns for this experiment, the system itself can accommodate up to eight mobile phases and six columns. The analytical conditions used are shown in Table 1.

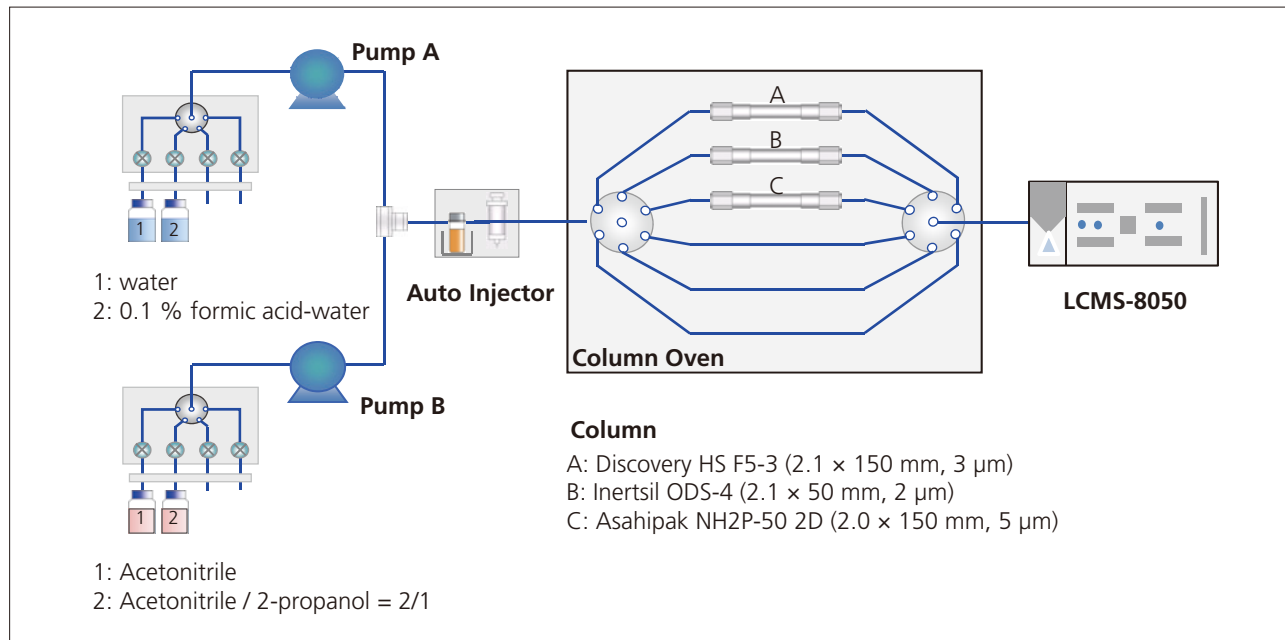

Fig. 3 System Configuration

Table 1 Analytical Conditions

Conditions	Condition 1	Condition 2	Condition 3	
HPLC	Instrument			UHPLC Nexera system (Shimadzu)
	Target Compounds	Organic acids Amino acids Flavonoids	Carotenoids	Sugars
	Column	A: Discovery HS F5-3 (150 mm L. × 2.1 mm I.D., 3 μm) Sigma-aldrich	B: Inertsil ODS-4 (50 mm L. × 2.1 mm I.D., 2 μm) GL-science	C: Asahipak NH2P-50 2D (150 mm L. × 2.0 mm I.D., 5 μm) Shodex
	Column Oven Temp.	40 °C		
	Mobile Phase A	2: 0.1 % Formic acid-Water	1: Water	1: Water
	Mobile Phase B	1: Acetonitrile	2: Acetonitrile / 2-Propanol = 2/1	1: Acetonitrile
	Flowrate	0.25 mL/min	0.4 mL/min	0.4 mL/min
	Time Program	0 %B (0-2 min.) → 95 % (10-13 min.) → 0 % (13.01-16 min.)	60 %B (0 min.) → 100 % (5-8 min.) → 60 % (8.01-10 min.)	65 %B (0-8 min.) → 30 % (8-11 min.) → 65 % (11.01-15 min.)
	Measurement Time	16 min	10 min	15 min
	Total Run Time	41 min		
Injection Volume	2 μL			
MS	Instrument			LCMS-8050
	Ionization			ESI (+ / -)
	Mode			MRM

Multiple Reaction Monitoring (MRM) Analysis of Primary and Secondary Metabolites

The MRM chromatograms obtained for compounds analyzed under each set of analytical conditions are shown in Fig. 4. The calibration curve ranges for all compounds are also shown in Table 2.

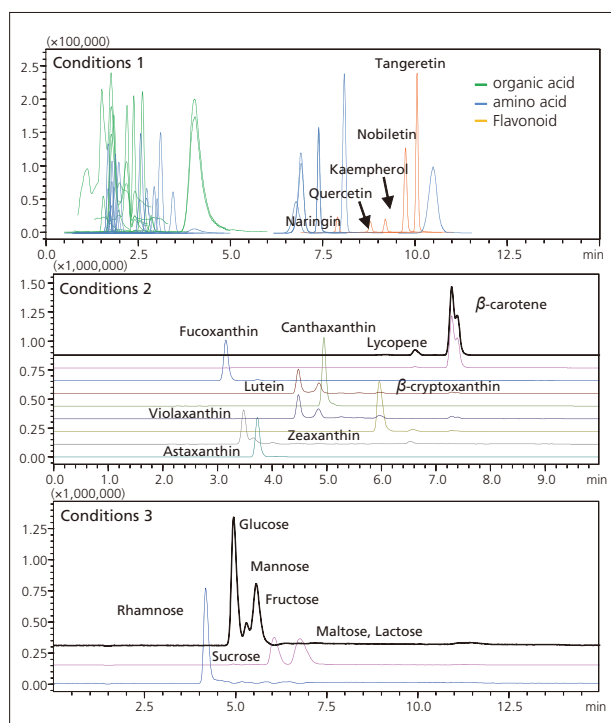

Fig. 4 Example Chromatograms Obtained Under Three Analytical Conditions

Table 2 Calibration Curve Ranges of Target Compounds

Amino acids	Range	Organic acids	Range
Cystine	1-100	Tartaric acid	50-10000
Aspartic acid	5-100	2-Ketoglutaric acid	10-1000
Asparagine	5-100	Isocitric acid	50-10000
Serine	5-100	Malic acid	10-5000
4-Hydroxyproline	1-100	Lactic acid	50-10000
Glycine	5-100	Citric acid	50-10000
Lysine	1-100	Pyroglutamic acid	10-10000
Cysteine	50-100	Succinic acid	10-1000
Threonine	5-100	Fumaric acid	500-1000
Glutamic acid	1-100	Maleic acid	50-10000
Alanine	5-100		
Proline	1-100		
Ornithine	5-1000		
Glutamine	5-100		
Histidine	5-100		
Arginine	5-100		
GABA	5-100		
Valine	1-100		
Methionine	5-100		
Tyrosine	5-100		
Isoleucine	5-100		
Leucine	10-100		
Phenylalanine	1-100		
Tryptophan	5-500		
Sugars	Range		
Rhamnose	50-1000		
Fluctose	50-5000		
Glucose	50-5000		
Sucrose	100-5000		
Maltose, Lactose	200-2000		
Carotenoids	Range	Flavonoids	Range
Fucoxanthin	0.1-100	Naringin	10-1000
Violaxanthin	1-100	Quercetin	5-1000
Astaxanthin	0.5-100	Kaempferol	5-1000
Lutein	0.1-100	Nobiletin	0.1-1000
Zeaxanthin	0.5-100	Tangeretin	0.1-1000
Canthaxanthin	0.05-100		
β-Cryptoxanthin	0.05-100		
Lycopene	50-100		
β-carotene	0.1-100		

Comparison of Flesh and Peel Constituents

Constituents of the flesh and peel of the seven citrus fruits were compared by performing principal component analysis. Flesh and peel constituents tended to separate into two groups on a score plot. The results of the loading plot indicate that the carotenoids, flavonoids, and sugars content of flesh and peel separates these sample types.

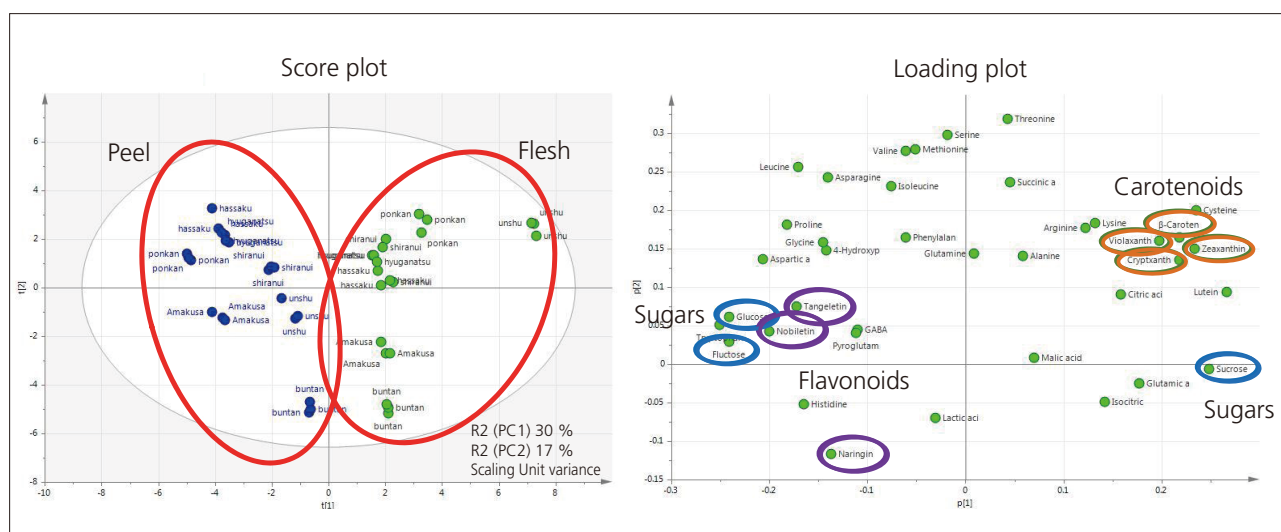

Fig. 5 Principal Component Analysis (PCA) of Flesh and Peel

■ Comparison of Sugars (Flesh and Peel)

The results of a quantitative comparison of sugars in flesh and peel are shown in Fig. 6. Although there is no difference in the total quantity of sugars present in flesh and peel, the sugar composition of flesh and peel differs substantially.

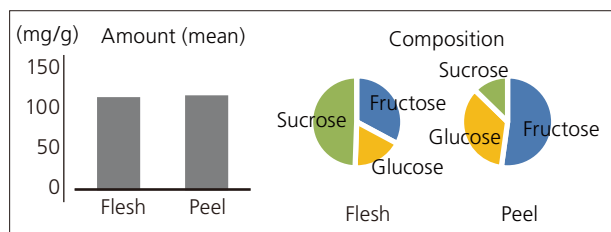

Fig. 6 Comparison of Sugar Quantity and Sugar Composition in Flesh and Peel

■ Comparison of Secondary Metabolites (Flesh and Peel)

The results of a quantitative comparison of secondary metabolites in flesh and peel are shown in Fig. 7. Flesh contained ≥ 30 times the quantity of carotenoids compared to peel. Meanwhile, peel contained around five times the quantity of flavonoids compared to flesh. These results showed a substantial difference in the secondary metabolites of flesh and peel.

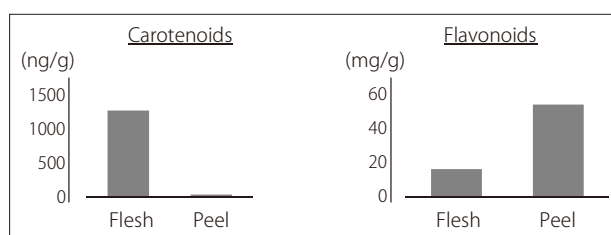

Fig. 7 Comparison of Mean Secondary Metabolites

■ Comparison of Citrus Fruits (Flesh)

Mikan orange and its hybrid varieties tended to appear on the upper right of the score plot. Since we confirmed that carotenoids appear in the upper right of the loading plot (Fig. 8), we also performed a quantitative analysis of carotenoids. This quantitative analysis confirmed mikan orange and its hybrid varieties have a high carotenoid content, and in particular contain a high quantity of β -cryptoxanthin and β -carotene (Fig. 9).

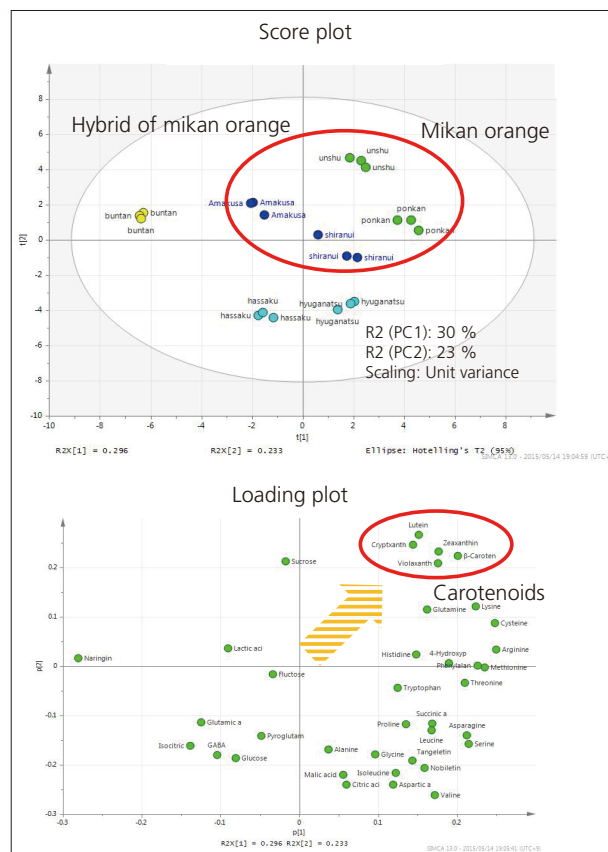

Fig. 8 Principal Component Analysis (PCA) of Flesh

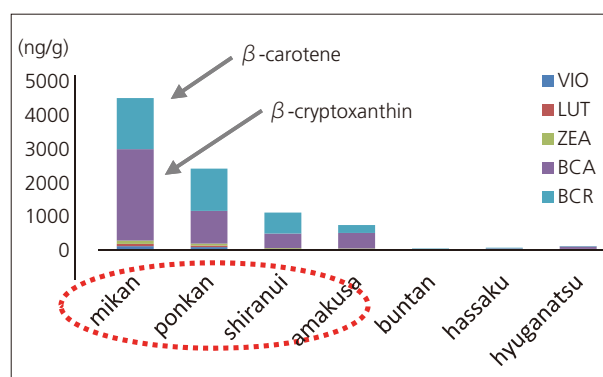

Fig. 9 Comparison of Carotenoid Content of Seven Citrus Fruits

First Edition: Jul. 2016



Shimadzu Corporation
www.shimadzu.com/an/

For Research Use Only. Not for use in diagnostic procedure.

This publication may contain references to products that are not available in your country. Please contact us to check the availability of these products in your country.

The content of this publication shall not be reproduced, altered or sold for any commercial purpose without the written approval of Shimadzu. Company names, product/service names and logos used in this publication are trademarks and trade names of Shimadzu Corporation or its affiliates, whether or not they are used with trademark symbol "TM" or "@". Third-party trademarks and trade names may be used in this publication to refer to either the entities or their products/services. Shimadzu disclaims any proprietary interest in trademarks and trade names other than its own.

The information contained herein is provided to you "as is" without warranty of any kind including without limitation warranties as to its accuracy or completeness. Shimadzu does not assume any responsibility or liability for any damage, whether direct or indirect, relating to the use of this publication. This publication is based upon the information available to Shimadzu on or before the date of publication, and subject to change without notice.

Application News

No. C131

Liquid Chromatography Mass Spectrometry

Application of Metabolomics to Microbial Breeding

Microorganisms have been used for many years to produce useful materials in a wide range of industrial fields, including food, biotechnology, and energy. In the food sector, microorganisms are used to produce foods by the fermentation process, such as alcoholic beverages and fermented foods, and in the biotechnology sector microorganisms are used for the large scale production of amino acids and antibiotics. In the energy sector, it is anticipated that microorganism will be used for biofuel production, though lowering the cost presents an outstanding problem. Although microorganisms are already used in the production of a variety of useful materials, genetic modification and breeding is still performed with the aim of improving production efficiency. Metabolomics presents useful tools for the evaluation of metabolic changes during microorganism breeding, and for understanding metabolic changes related to a target material and its precursors and intermediates. By deepening our understanding of the metabolic pathways involved in material production, metabolomics is expected to result in more efficient materials production. In this article, we discuss an example of LC/MS analysis of how the sulfur-containing metabolites vary during culture of a cysteine-producing *Escherichia coli* (*E. coli*) when either thiosulfuric acid or sulfuric acid is added as the sulphur source during cysteine synthesis.

■ LC/MS Analysis of *Escherichia coli* Extract

We cultured *E. coli* in minimal media to which thiosulfuric acid or sulfuric acid was added as a sulfur source. To evaluate metabolic changes during culture, some *E. coli* were collected from the culture suspension were collected at 3, 4, 5, 6, 7, 8, and 9 hours of culture. The optical density (OD) of the collected *E. coli* was measured before the media components and *E. coli* were quickly separated by filtration. *E. coli* extract was then prepared by breaking down the isolated *E. coli* in methanol. After removing methanol by centrifugal concentration, the extract was adjusted to an appropriate dilution with ultrapure water and used for LC/MS analysis. Metabolites were analyzed simultaneously using the analytical conditions of an ion pairing method (LCMS-8040) and non-ion pairing method (LCMS-8050) obtained from an LCMS method package [primary metabolites]. Table 1 shows the analytical conditions of each method. Fig. 1 also shows an MRM chromatogram (both at 6 hours into culture) for each analytical method obtained by analysis of *E. coli* extract after culture in thiosulfate-containing medium. The main peaks detected when the ion pairing method was used were amino acids, coenzymes, and nucleic acid-related compounds, and the main peaks detected when the non-ion pairing method was used were amino acids, organic acids, and nucleic acid-related compounds.

Table 1 Analytical Conditions for Ion Pairing Method and Non-Ion Pairing Method

Ion Pairing Method (LC Analytical Conditions)		Non-Ion Pairing Method (LC Analytical Conditions)	
Column	: RP column	Column	: RP column
Mobile Phase A	: 15 mmol/L Acetate, 10 mmol/L Tributylamine - Water	Mobile Phase A	: 0.1 % Formic acid - Water
Mobile Phase B	: Methanol	Mobile Phase B	: 0.1 % Formic acid - Acetonitrile
Flowrate	: 0.3 mL/min	Flowrate	: 0.25 mL/min
Mode	: Gradient elution	Mode	: Gradient elution

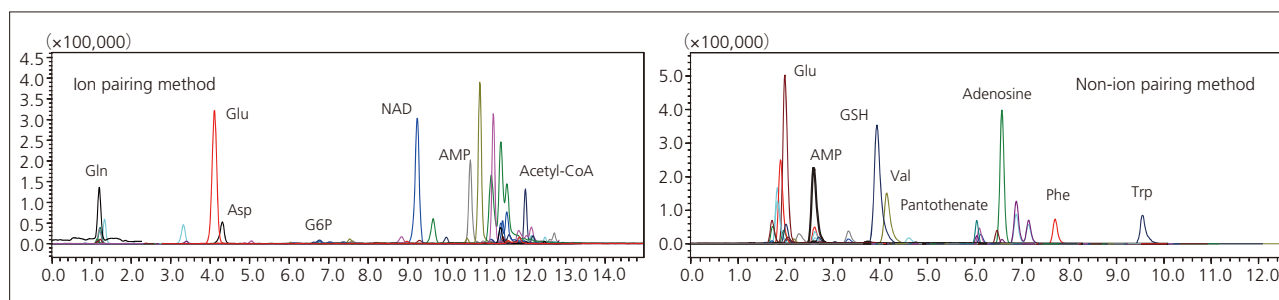

Fig. 1 MRM Chromatograms of *Escherichia coli* Extract After Culture in Thiosulfate-Containing Medium

Change in Sulfur-Containing Metabolites over Time

Based on the results we obtained, the area ratio of metabolites that are related to sulfur-containing metabolites, such as cysteine, over the course of culture in thiosulfate-containing or sulfate-containing medium are compared in Fig. 2 (vertical axis: area ratio, horizontal axis: time). Fig. 2 shows there were changes in metabolites over culture time caused by using different sulfur sources. At around six hours into culture, when glucose became exhausted, in the thiosulfate-containing medium we observed a fall in cysteine (seven hours onwards) and an increase in serine (at six hours), which is upstream in the metabolic pathway. In the thiosulfate-containing medium we also confirmed an increase in

nucleosides (adenosine and inosine). This shows how metabolomics can be used to understand how adding different sulfur sources to media affects the productivity of sulfur-containing metabolites such as cysteine. In this article we looked at how metabolites change during the course of *E. coli* culture, focusing on sulfur-containing metabolites that are linked to cysteine production. The results also show how the primary metabolites method package and a triple quadrupole mass spectrometer can be combined to evaluate changes in various other metabolites that are important to living organisms, such as amino acids, organic acids, and nucleic acid-related compounds.

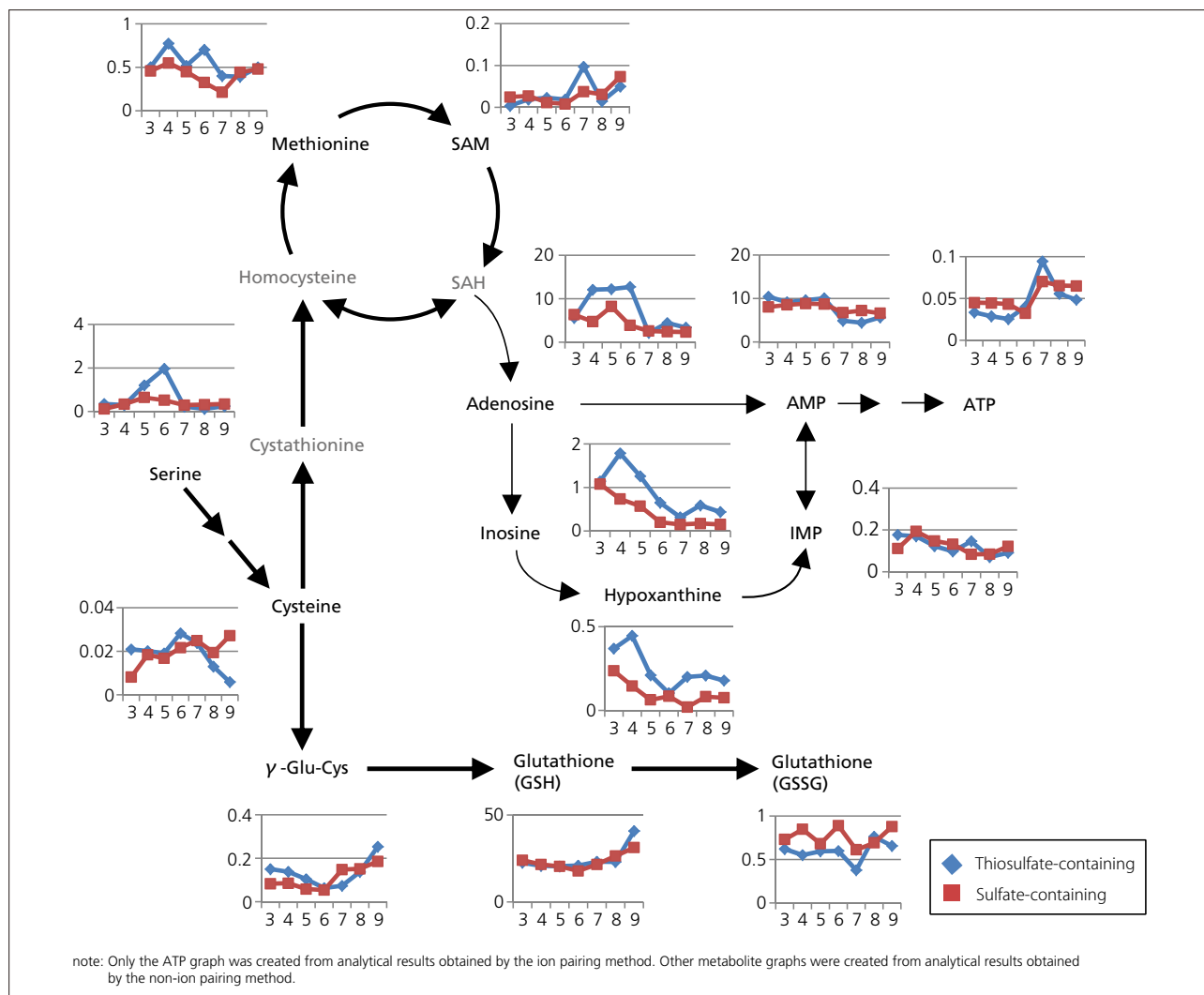

Fig. 2 Changes in Sulfur-Containing Metabolites in *Escherichia coli* Cultured in a Thiosulfate- or Sulfate-Containing Medium

**E. coli* samples were provided by Iwao Ohtsu and Yusuke Kawano of the Integrated System Biology Course, Department of Biological Sciences, Graduate School of Biological Sciences, Nara Institute of Science and Technology.

*This research was conducted utilizing the Ministry of Agriculture, Forestry and Fisheries' "Science and technology research promotion program for agriculture, forestry, fisheries and food industry."

First Edition: Jul. 2016



Shimadzu Corporation
www.shimadzu.com/an/

For Research Use Only. Not for use in diagnostic procedure.

This publication may contain references to products that are not available in your country. Please contact us to check the availability of these products in your country.

The content of this publication shall not be reproduced, altered or sold for any commercial purpose without the written approval of Shimadzu. Company names, product/service names and logos used in this publication are trademarks and trade names of Shimadzu Corporation or its affiliates, whether or not they are used with trademark symbol "TM" or "®". Third-party trademarks and trade names may be used in this publication to refer to either the entities or their products/services. Shimadzu disclaims any proprietary interest in trademarks and trade names other than its own.

The information contained herein is provided to you "as is" without warranty of any kind including without limitation warranties as to its accuracy or completeness. Shimadzu does not assume any responsibility or liability for any damage, whether direct or indirect, relating to the use of this publication. This publication is based upon the information available to Shimadzu on or before the date of publication, and subject to change without notice.

Application News

No. C134

Liquid Chromatography Mass Spectrometry

Multi-Component Analysis of Five Beers

Sensory test methods that present flavor and taste in numerical terms are widely used techniques for the quantitative evaluation of food quality. Recently, attempts have been made to obtain a greater amount of data by combining the results of sensory tests with metabolomics data that provides a comprehensive analysis of food constituents. Combining comprehensive analytical data with use of multivariate analysis has become an effective option for elucidating the differences in a wide range of constituents. This combination of multivariate analysis and metabolomics promises to see application in areas of quality evaluation and quality improvement, as well as in the development of foods with improved functional properties. In this article, we describe the simultaneous analysis of five commercially available beers with a triple quadrupole mass spectrometer (LCMS-8060) using a primary metabolite method package, and performing principal component analysis on the data set obtained using Traverse™ MS software. We classified the five beers based on differences in constituent compounds, and confirmed characteristic components in each beer. We then performed hierarchical clustering analysis to show how these five beers are classified.

Table 1 Analytical Conditions

LC Analytical Conditions

Column	: RP column
Mobile Phase A	: 0.1 % Formic acid - Water
Mobile Phase B	: 0.1 % Formic acid - Acetonitrile
Flowrate	: 0.25 mL/min
Mode	: Gradient elution

MS Analytical Conditions

Ionization Method	: ESI(+)/(-)
Nebulizing Gas Flow	: 2 L/min
Heating Gas Flow	: 10 L/min
Drying Gas Flow	: 10 L/min
Probe Voltage	: 4 kV(+)/-3 kV(-)
Interface Temperature	: 300 °C
DL Temperature	: 250 °C
Block Heater Temperature	: 400 °C

Beer Sample Preparation and Analysis

An internal standard was added to 0.2 mL of degassed beer, and ultrafiltration was performed on this mixture using a molecular weight cut off filter. The filtrate was recovered, diluted 200 times, and then used for simultaneous analysis by LC/MS. LC/MS analysis was performed according to analytical conditions in the primary metabolite method package. The analytical conditions used are shown in Table 1. The MRM chromatograms for three of the five beers (lager beer A, *happoshu* [low-malt beer], and non-alcoholic beer) are shown in Fig. 1. These results show the types of various constituents, such as amino acids, found in the five beers differ greatly between the beers.

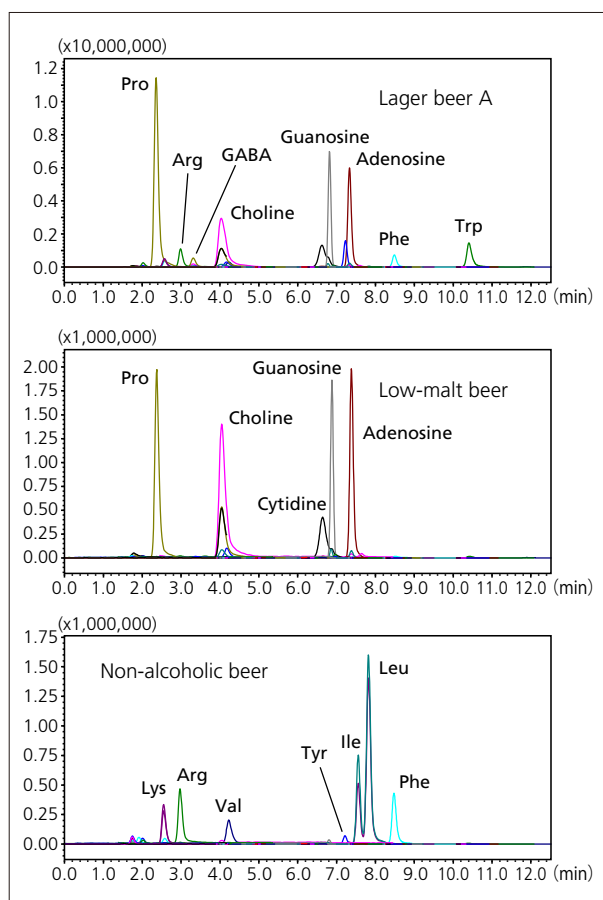

Fig. 1 MRM Chromatograms of Three Beers

■ **Multivariate Analysis with Traverse™ MS Software**

Using the area ratio of each constituent (58 constituents) compared against the internal standard, a principal component analysis (PCA) was performed for the five beers using the Traverse™ MS software. PCA results showing different quantities of constituents in each beer are presented in Fig. 2. Score plot and loading plot results are also shown in Fig. 2. The five beers can be seen to appear fully separated on the score plot. From the loading plot, we also determined constituents that were characteristic to each beer. We confirmed that a number of amino acids and nucleosides differed markedly between the beers.

Next, the area ratio of detected constituents was used to perform hierarchical clustering analysis of the five beers using the Traverse™ MS software. The results of this analysis are shown in Fig. 3. Autoscaling was used to normalize area ratios between samples. As shown in Fig. 3, the lager beers and ale beer are grouped relatively close to each other, and the low-malt beer and non-alcoholic beer are also grouped close to each other. Hierarchical clustering analysis provides a visual representation of the degree of similarity between the beers in terms of their constituents. Performing a comprehensive analysis of food constituents in this way and combining it with multivariate analysis makes it easy to evaluate which constituents affect food quality and function. This combination of comprehensive simultaneous analysis and multivariate analysis is expected to become more commonly used for quality evaluation of food in the future.

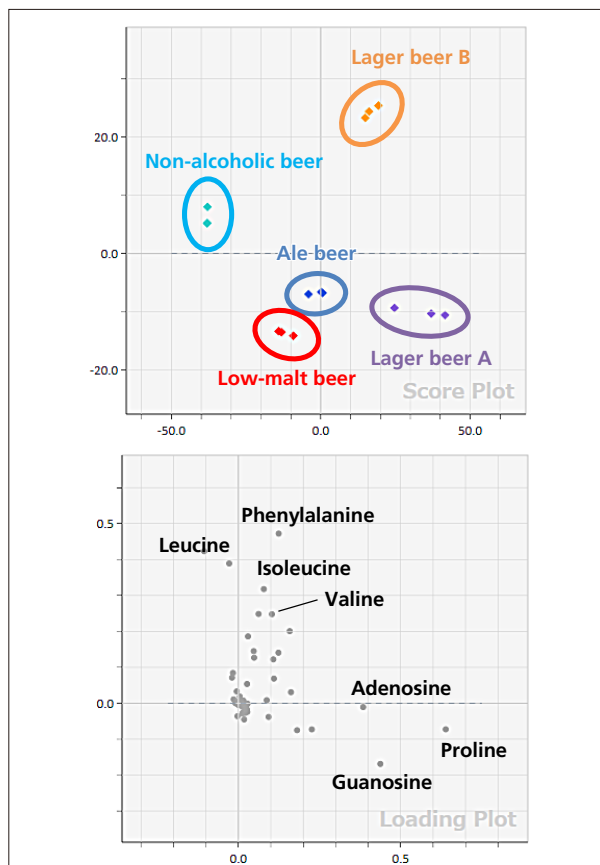

Fig. 2 Principal Component Analysis of Five Beers

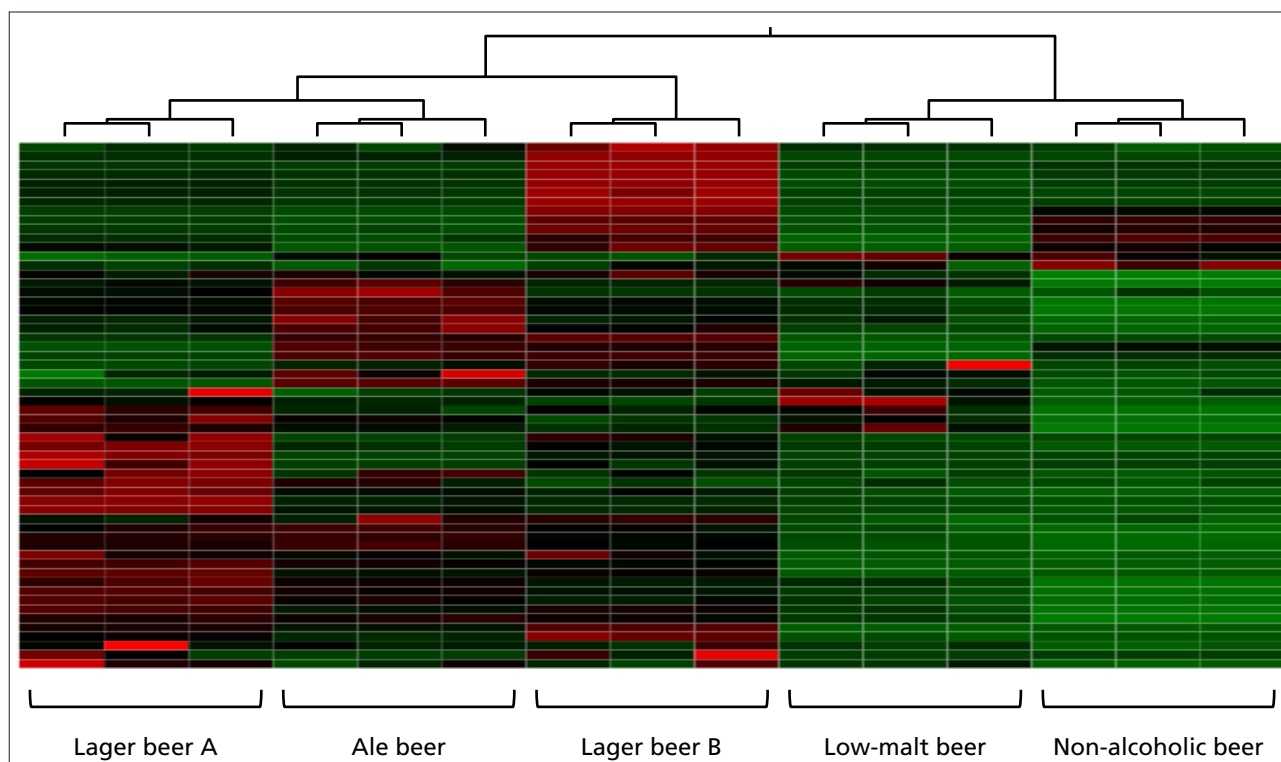

Fig. 3 Hierarchical Clustering Analysis of Five Beers

First Edition: Jul. 2016



Shimadzu Corporation
www.shimadzu.com/an/

For Research Use Only. Not for use in diagnostic procedure.

This publication may contain references to products that are not available in your country. Please contact us to check the availability of these products in your country.

The content of this publication shall not be reproduced, altered or sold for any commercial purpose without the written approval of Shimadzu. Company names, product/service names and logos used in this publication are trademarks and trade names of Shimadzu Corporation or its affiliates, whether or not they are used with trademark symbol "TM" or "®". Third-party trademarks and trade names may be used in this publication to refer to either the entities or their products/services. Shimadzu disclaims any proprietary interest in trademarks and trade names other than its own.

The information contained herein is provided to you "as is" without warranty of any kind including without limitation warranties as to its accuracy or completeness. Shimadzu does not assume any responsibility or liability for any damage, whether direct or indirect, relating to the use of this publication. This publication is based upon the information available to Shimadzu on or before the date of publication, and subject to change without notice.

Liquid Chromatograph Mass Spectrometer

LCMS-8060

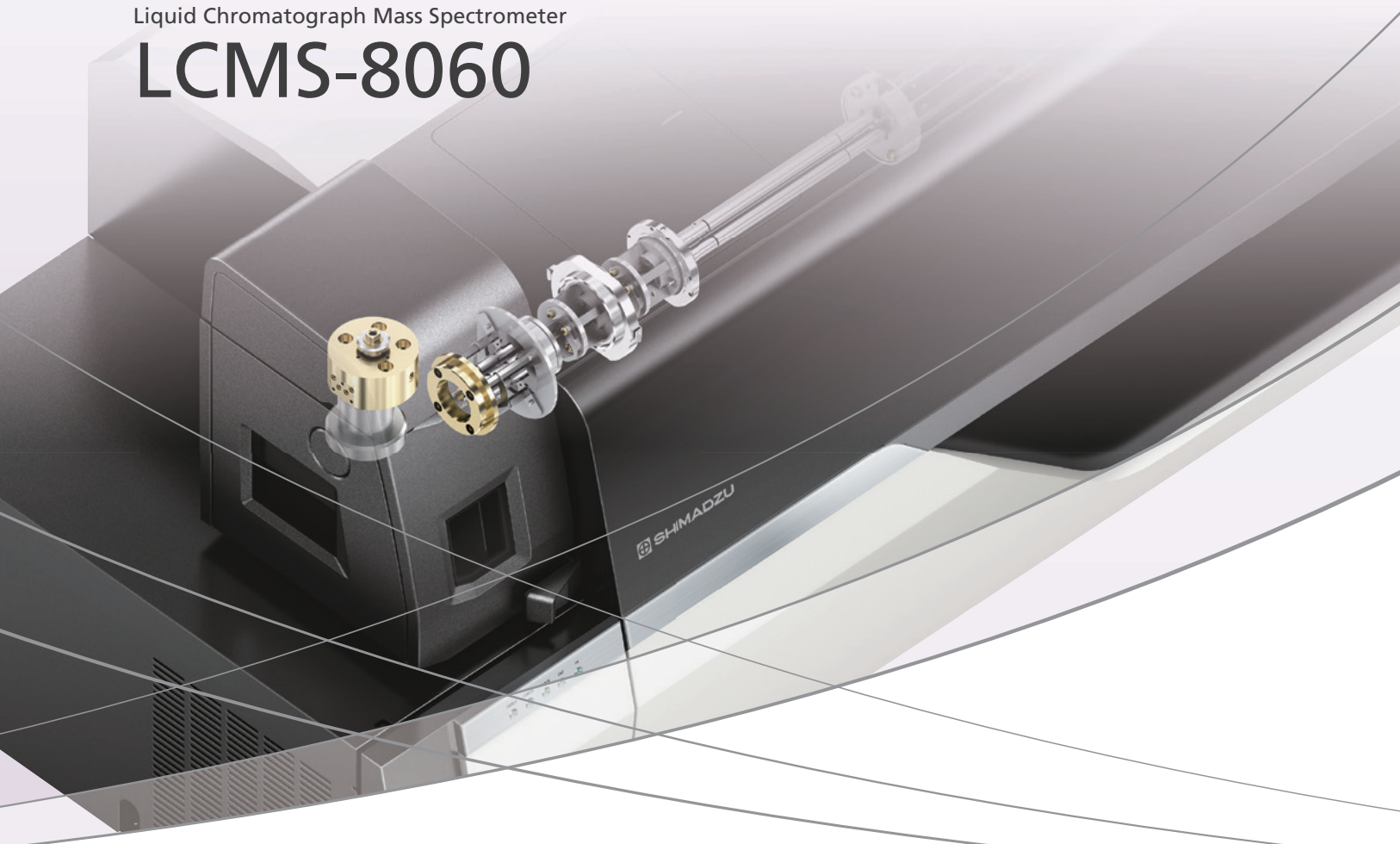

CHANGES **EVERYTHING**

The LCMS-8060 is the latest in Shimadzu's Ultra-Fast Mass Spectrometry product line, designed to deliver you the highest sensitivity and fastest analysis speed of any LCMS on the market today.

Sensitivity

Highest Sensitivity

A newly developed UF-Qarray boosts ion intensity but suppresses noise. By improving the ion sampling device, the ion guide, and vacuum efficiency, Shimadzu has achieved an unprecedented sensitivity in LCMS.

Speed

Fastest Speed

Shimadzu's proprietary technologies allow acquisition of up to 555 MRM channels per second, ultra-fast polarity switching, and ultra-fast scanning, all with high data quality.

UFscanning: Max. 30,000 u/sec

UFswitching: 5 msec

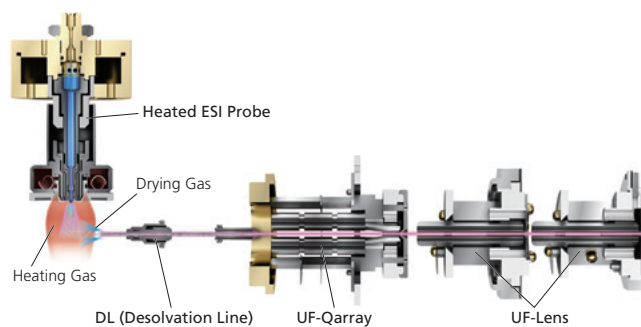

Solutions

Fusion of sensitivity and speed

Don't miss an exciting performance results in **next page!!**



High-Sensitivity Quantitation of Catecholamines in Plasma

Catecholamines in plasma, namely norepinephrine (NE), epinephrine (EP) and dopamine (DA), are routinely measured in the research of such diseases as hypertension or neuroblastoma. Since plasma samples contain endogenous catecholamines, it is difficult to evaluate the LLOQ in plasma matrix. Here we used deuterated catecholamine compounds as standards to estimate the LLOQ in plasma matrix, rather than as internal standards for quantitation.

A neat standard curve was prepared by serial dilution in HPLC solvent, whereas a matrix-matched standard curve was prepared by dilution with pooled plasma sample treated with SPE. The table on the right summarizes the quantitation results, which convincingly demonstrate the capability of LCMS-8060 to detect catecholamines at ultra-high sensitivity without matrix interference.

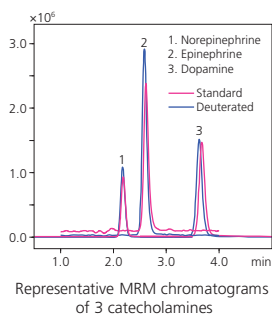

Quantitative range of neat and matrix-matched calibration curves

Compound name	Neat standard curve		Matrix-matched	
	Range (pg/mL)	Linearity (r ²)	Range (pg/mL)	Linearity (r ²)
Norepinephrine-d6 (158.1 > 111.1)	2.5 – 2000	0.9999	2.5 – 2000	0.9997
Epinephrine-d6 (190.1 > 172.1)	10 – 2000	0.9999	10 – 2000	0.9994
Dopamine-d4 (158.1 > 95.1)	5 – 2000	0.9999	10 – 2000	0.9995

In the actual quantitation assay, deuterated catecholamines are spiked as internal standard at 500 pg/mL in plasma and analyzed by LCMS-8060. The figures on the right show the MRM chromatograms of spiked and endogenous catecholamines in plasma.

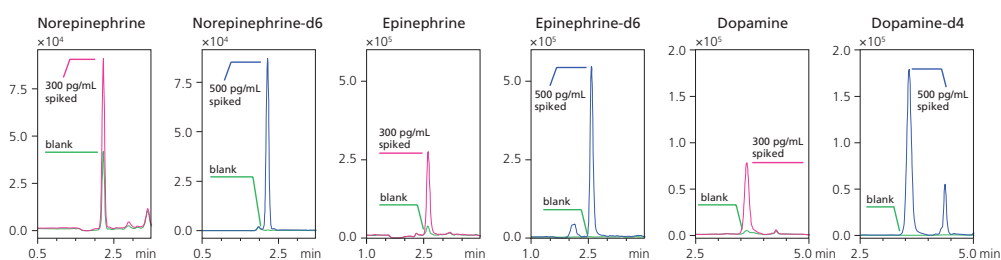

Detection of Norepinephrine, Epinephrine and Dopamine and their deuterated internal standards in plasma.

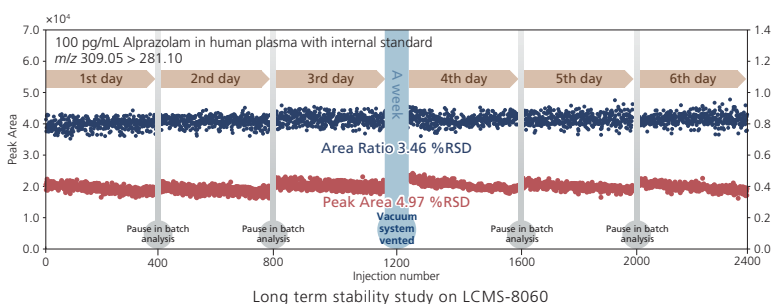

Long term stability study on LCMS-8060

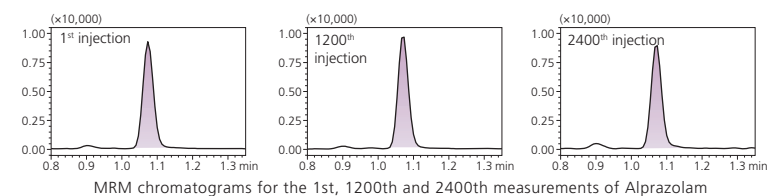

MRM chromatograms for the 1st, 1200th and 2400th measurements of Alprazolam

Intraday and interday variations on LCMS-8060

Compound	Intraday Variation (%RSD)						Interday Variation (%RSD)		
	1st day	2nd day	3rd day	4th day	5th day	6th day	Days 1–3	Days 4–6	6 Day Total
Alprazolam	5.04	4.94	5.06	5.38	4.55	4.83	3.19	1.63	2.74
Alprazolam-d5 (ISTD)	5.04	4.68	5.48	5.31	4.26	4.91	2.62	1.89	2.18
Area ratio	3.48	3.11	3.48	3.44	3.71	3.54	1.79	0.26	1.40

Outstanding Durability

The robustness of the LCMS-8060 and modified ion optics were assessed by injecting 2400 samples of femto-gram levels of alprazolam spiked into protein-precipitated human plasma extracts over a 6 day period (over 400 samples were injected each day). The RSD of peak area response was 5% over this test period; using a deuterated internal standard (alprazolam-d5) the RSD was 3.5%. As part of the robustness test the vacuum system was vented to model a transient power failure with no effect on signal response or baseline noise level.



Shimadzu Corporation
www.shimadzu.com/an/

For Research Use Only. Not for use in diagnostic procedures.

This publication may contain references to products that are not available in your country. Please contact us to check the availability of these products in your country.

Company names, products/service names and logos used in this publication are trademarks and trade names of Shimadzu Corporation, its subsidiaries or its affiliates, whether or not they are used with trademark symbol "TM" or "®".

Third-party trademarks and trade names may be used in this publication to refer to either the entities or their products/services, whether or not they are used with trademark symbol "TM" or "®".

Shimadzu disclaims any proprietary interest in trademarks and trade names other than its own.

The contents of this publication are provided to you "as is" without warranty of any kind, and are subject to change without notice. Shimadzu does not assume any responsibility or liability for any damage, whether direct or indirect, relating to the use of this publication.

Application News

No. A524

Spectrophotometric Analysis

Differentiating Olive Oils Using UV-VIS Spectrophotometer and Spectrofluorophotometer

Introduction

There is growing interest in food safety and organic foods, with an increasing number of shops specializing in a variety of food products and increasing circulation of high price import goods. One of these foods is olive oil, which is supposed to have both health and aesthetic benefits. The most expensive form of olive oil is extra virgin olive oil, which is regulated by the International Olive Council. Only olive oil that is chemically unprocessed, produced by squeezing and filtering olive fruit, and with an acidity of no more than 0.8 % qualifies as extra virgin olive oil. Another olive oil called pure olive oil is created by purification and high-temperature treatment. Differentiating between extra virgin olive oil and pure olive oil based on appearance alone is difficult. This article describes an attempt to differentiate between these two olive oil types by spectrum measurement using Shimadzu UV-2700 UV-VIS spectrophotometer and RF-6000 spectrofluorophotometer, then performing multivariate analysis.

Absorbance Measurement of Olive Oils

Fig. 1 shows Shimadzu UV-2700 that was used to measure absorbance. Fig. 2 shows some of the olive oils tested. They each differ in terms of color, odor, and place of origin. Ten different extra virgin olive oils were prepared from a total of 6 producers. Samples were named in the format "○ × E", where "○" was replaced by letters A through F to refer to each producer, and "×" was replaced by each producer's consecutive numbers in order of increasing olive oil price. Pure olive oil was also prepared from producers A and B. These samples were named in the format "○ × P". Each olive oil was placed in a quartz cell, then its absorption spectrum was measured. Measurement conditions are shown in Table 1, and three spectra representative of the spectra obtained are shown in Fig. 3. Absorption peak wavelengths are almost identical between spectra, though with obvious differences in their degree of absorption. Results confirmed the extra virgin olive oils tended to exhibit higher absorbance than the pure olive oils.



Fig. 1 UV-2700 UV-VIS Spectrophotometer

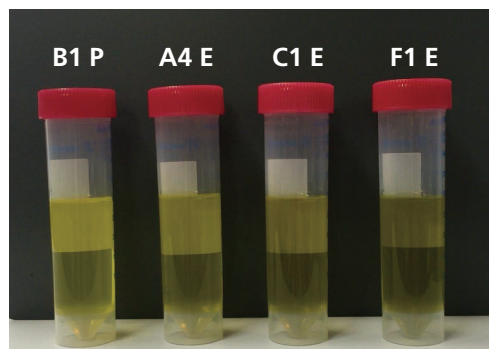

Fig. 2 Various Olive Oils

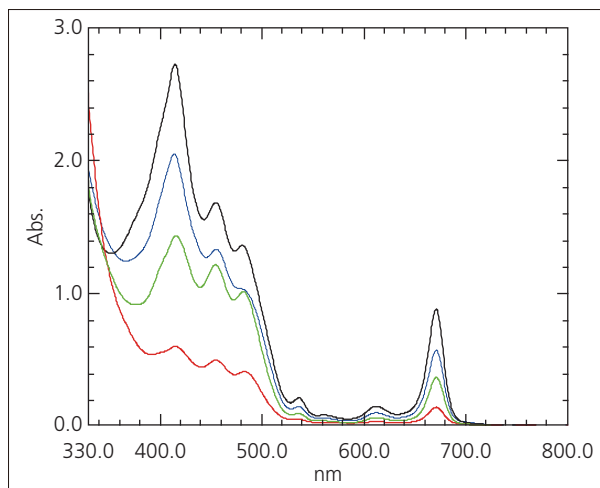

Fig. 3 Olive Oil Absorption Spectra
Red: B1 P, Green: A4 E, Blue: C1 E, Black: F1 E

Table 1 UV-2700 Measurement Conditions

Spectrum Type	: Absorption spectrum
Measurement Wavelength Range	: 330 nm to 800 nm
Scanning Speed	: Intermediate
Sampling Pitch	: 0.5 nm
Light Source Switching Wavelength	: 323 nm

Multivariate Analysis Using Absorption Spectra

We attempted to differentiate between pure olive oil and extra virgin olive oil by performing a multivariate analysis of the results obtained by absorbance measurement. The Unscrambler[®]X¹⁾ multivariate analysis software was used to perform difference analysis on absorbance at 7 peak wavelengths.

Principal component analysis (PCA) and cluster analysis were used to differentiate between olive oil types. With PCA, scores are calculated to allow visual differentiation by the analyst (score plot). A loading plot is also used to determine characteristic factors in each grouping that have a strong influence on the score plot. Cluster analysis differentiates samples based on a tree diagram. The shorter the horizontal line that connects each sample, the more similar those samples.

The score plot obtained by PCA is shown in Fig. 4. Pure olive oils are clustered in the negative direction along the dominant PC-1 axis, while extra virgin olive oils are clustered in the positive direction along the dominant PC-1 axis. This shows successful differentiation between olive oil types. The loading plot in Fig. 5 shows a characteristic of the extra virgin olive oils tested is strong signals at short wavelengths, such as 415 nm and 454.5 nm.

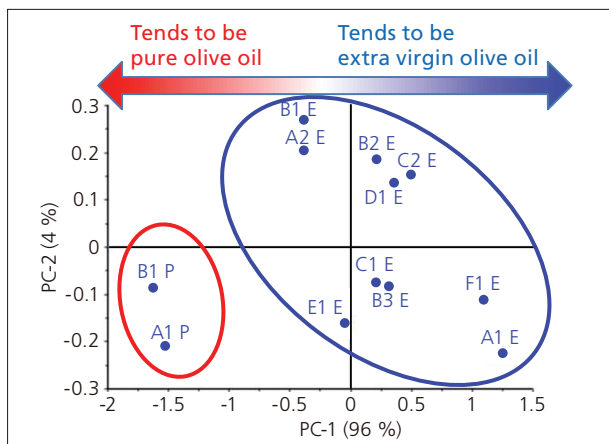

Fig. 4 Score Plot Based on Olive Oil Absorbance

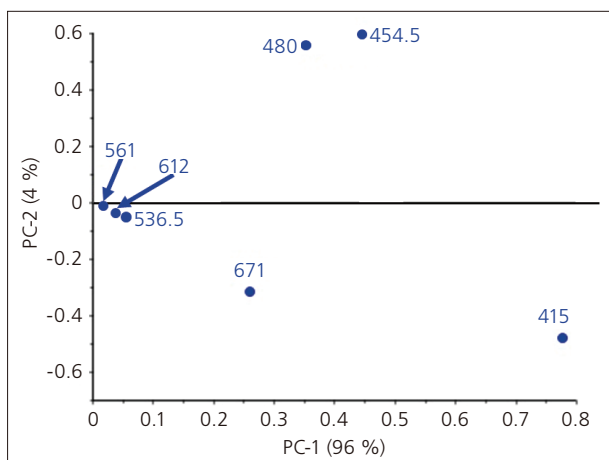

Fig. 5 Loading Plot Based on Olive Oil Absorbance

Cluster analysis results are shown in Fig. 6. At a glance, the tree diagram shows the olive oils separated into 2 groups and the degree of similarity between the samples. This result shows we successfully differentiated between pure olive oils and extra virgin olive oils.

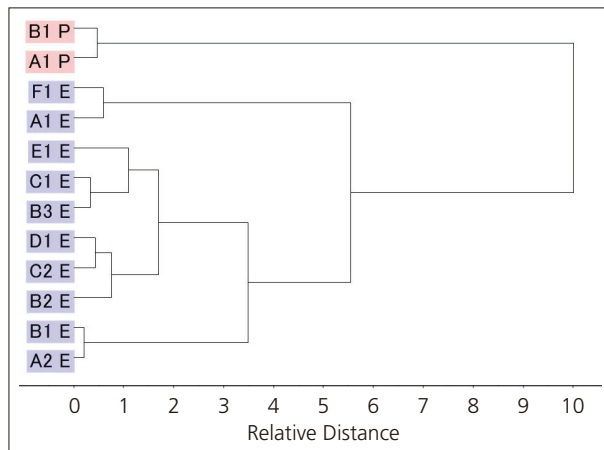

Fig. 6 Cluster Analysis Result Based on Olive Oil Absorbance

Three-Dimensional Spectra Measurements of Olive Oils

The three-dimensional emission spectra of olive oils were measured using Shimadzu RF-6000 spectrofluorophotometer. Fig. 7 shows the instrument used. Due to the high absorbance exhibited by the samples, a solid sample holder (Fig. 8) was used to compensate for self-absorption effects. Self-absorption is the phenomenon of light emitted by the sample being absorbed by the sample itself. When the absorption spectrum of a highly absorbing sample is measured in a normal cell holder, the amount of emission light that enters the detector can be reduced due to emission light being absorbed by the sample itself. A solid sample holder was used to direct excitation light towards the corner of the quartz cell as shown in Fig. 9. This reduces the amount of sample through which emission light travels, and so reduces the effects of self-absorption.



Fig. 7 RF-6000 Spectrofluorophotometer

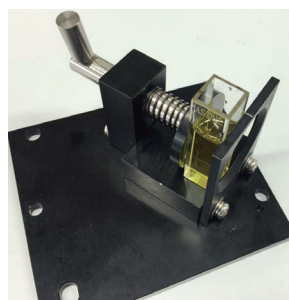

Fig. 8 Solid Sample Holder

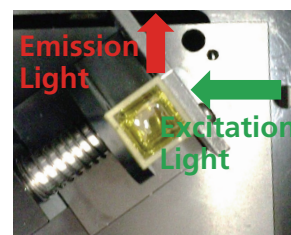

Fig. 9 Measurement Method

Table 2 shows the measurement conditions used. A filter (IHU310) that blocks light below 310 nm was placed in the path of emission light to prevent high-order excitation light reaching the detector. Fig. 10 shows two of the three-dimensional spectral diagrams obtained. Emission light predicted to be derived from chlorophyll was confirmed at Em 680 nm in both samples. Emission light at this wavelength was detected more strongly from extra virgin olive oil samples compared to pure olive oil samples. Also, strong emission light in the vicinity of Em 400 nm was mainly detected from pure olive oil samples. This 400 nm emission light is predicted to be derived from vitamins.

Fig. 11 compares a pure olive oil and an extra virgin olive oil showing emission spectra obtained at an excitation wavelength of 300 nm. The excitation light region shown in Fig. 11 is indicated by the white dotted lines in Fig. 10. The emission spectra show different peak strengths and peak tail shapes between 300 nm and 500 nm.

Table 2 RF-6000 Measurement Conditions

Optional Accessory	: Solid sample holder, IHU310
Spectrum Type	: 3D spectrum
Measurement Wavelength Range	: Ex 200 nm to 800 nm Em 250 nm to 800 nm
Scanning Speed	: 6000 nm/min
Wavelength Interval	: Ex 5.0 nm, Em 1.0 nm
Bandwidth	: Ex 5.0 nm, Em 5.0 nm
Sensitivity	: Low

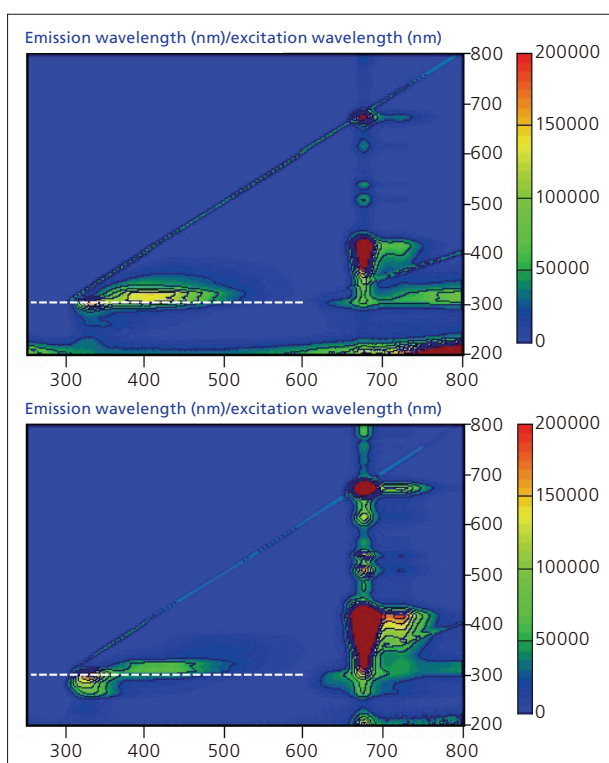

Fig. 10 Three-Dimensional Spectra of Olive Oils
Top: A1 P, Bottom: F1 E

■ **Multivariate Analysis Based on Three-Dimensional Spectra**

Similar to absorbance analysis, a multivariate analysis was performed on the three-dimensional spectra to differentiate between pure olive oils and extra virgin olive oils. Emission light intensity at the 10 points shown in Fig. 12 (A through J) was used for this analysis.

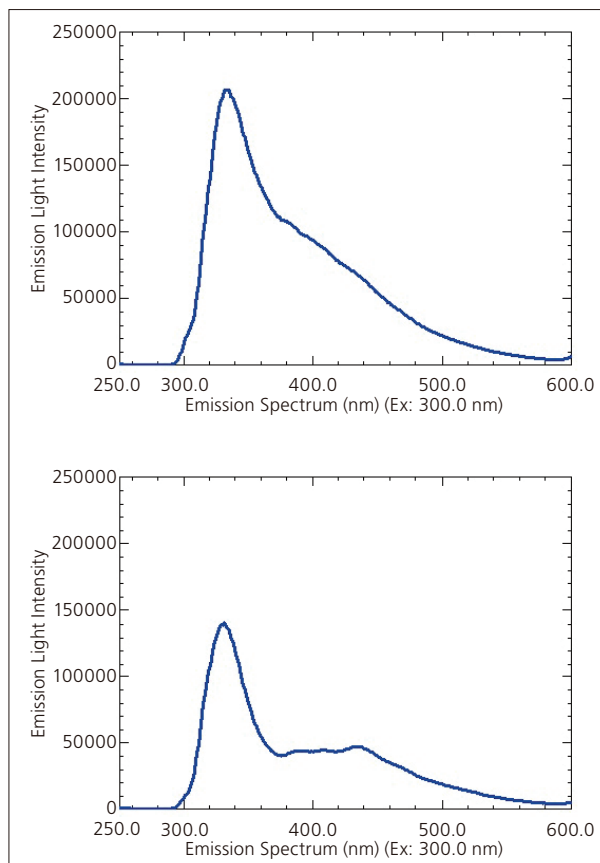

Fig. 11 Emission Spectrum of Olive Oils Excited at 300 nm
Top: A1 P, Bottom: F1 E

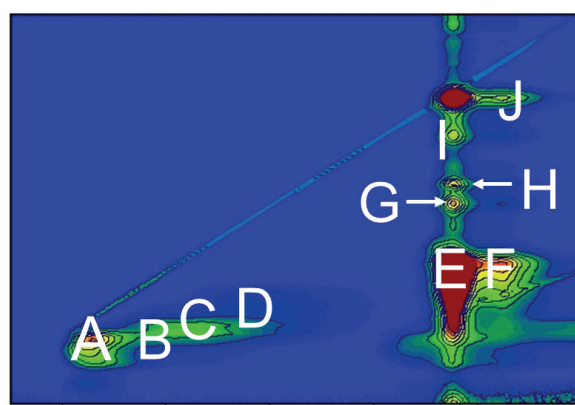

Fig. 12 Analysis Points for Multivariate Analysis

The score plot obtained by PCA is shown in Fig. 13. Pure olive oils are clustered in the positive direction along the dominant PC-1 axis and extra virgin olive oils are clustered in the negative direction along the dominant PC-1 axis. This shows the olive oil types have been separated.

Compared to the score plot created based on absorbance, the A2 E and B1 E samples are positioned closer to the pure olive oil samples. While A2 E and B1 E are both extra virgin olive oils, we can predict they are similar to pure olive oils. The loading plot is shown in Fig. 14. It shows a characteristic of the pure olive oils is for strong signals at emission light analysis points A through D, which are points predicted to be derived from vitamins.

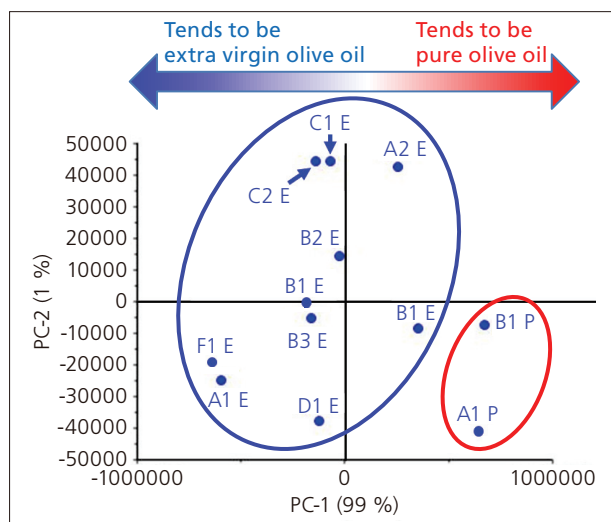

Fig. 13 Score Plot Based on Olive Oil Absorbance

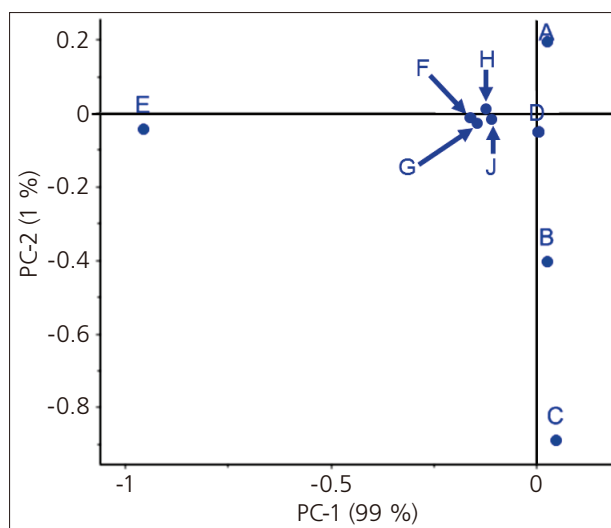

Fig. 14 Loading Plot Based on Olive Oil Absorbance

Results of the cluster analysis are shown in Fig. 15. Compared to the results obtained based on absorbance, the A2 E and B1 E samples are included in the pure olive oil group. This result also shows that while these samples are extra virgin olive oils, they tend to be closer to pure olive oils. Using emission light spectra, we could predict which extra virgin olive oils are likely to contain more vitamins.

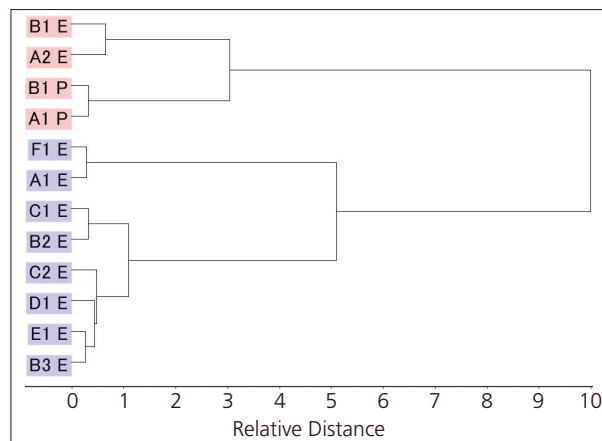

Fig. 15 Cluster Analysis Result Based on Olive Oil Absorbance

Conclusion

Shimadzu UV-2700 UV-VIS spectrophotometer was used to measure absorption spectra. Results showed the extra virgin olive oils have a higher absorbance than the pure olive oils. Next, the three-dimensional emission spectra of olive oils were measured using Shimadzu RF-6000 spectrofluorophotometer. Differences in emission light intensity and peak width were confirmed in the three-dimensional emission spectra results. Multivariate analysis was then performed based on each spectrum. This allowed successful differentiation between the extra virgin olive oils and pure olive oils, while results obtained from the RF-6000 allowed identification of extra virgin olive oils particularly similar to pure olive oils.

<Acknowledgments>

We are grateful to Kazumi Hashimoto of the Polymer Photonics Laboratory, Master's Program of Innovative Materials, Graduate School of Science and Technology, Kyoto Institute of Technology for providing assistance in performing these measurements.

1) The Unscrambler®X is a trademark or registered trademark of CAMO Software.

Find us on 



Linked 



First Edition: March, 2018



For Research Use Only. Not for use in diagnostic procedures.

This publication may contain references to products that are not available in your country. Please contact us to check the availability of these products in your country.

The content of this publication shall not be reproduced, altered or sold for any commercial purpose without the written approval of Shimadzu. Company names, products/service names and logos used in this publication are trademarks and trade names of Shimadzu Corporation, its subsidiaries or its affiliates, whether or not they are used with trademark symbol "TM" or "®".

Third-party trademarks and trade names may be used in this publication to refer to either the entities or their products/services, whether or not they are used with trademark symbol "TM" or "®".

Shimadzu disclaims any proprietary interest in trademarks and trade names other than its own.

The information contained herein is provided to you "as is" without warranty of any kind including without limitation warranties as to its accuracy or completeness. Shimadzu does not assume any responsibility or liability for any damage, whether direct or indirect, relating to the use of this publication. This publication is based upon the information available to Shimadzu on or before the date of publication, and subject to change without notice.

Shimadzu Corporation
www.shimadzu.com/an/