

GENERAL INSTRUCTIONS

Leather is nature's product and subject to its varying conditions. Climate, the food and care given the animal and season of slaughter are a few of many factors which occasionally effect skin flaws. These are natural and in no way mean the skin is inferior. Eliminate flaws, when cutting, by placing the pattern in such a way as to avoid them.

Cutting pattern pieces on crosswise grain (against the grain) tends to stretch leather. Therefore, all lengthwise grain line markings on the pattern are parallel to backbone.

1. Because leather can not be folded, fashion duplicate paper patterns for all parts marked 'cut two'.

2. Lay out pattern pieces. Keep in mind the skin's greatest strength is down the center and parts which will incur the most wear should be cut from this backbone area.

3. Keep the pattern's lengthwise grainline parallel to backbone and try to have equal thicknesses of leather for related parts of your leather project.

4. Tape pattern to skin or attach with pins placed in the seam allowance. (Pattern may also be weighted down.)

5. Prior to cutting, you may want to trace around the pattern with chalk or pen. Then, with shears or razor knife, make the cut — employing long, even strokes.

6. Sewing leather usually entails some minor machine adjustments. First, change needles... we suggest size 11 for lightweight leathers and, for leathers of heavier weights, size 14. Adjust the stitch regulator to allow for seven to ten stitches per inch. (For sheer suedes, as many as twelve stitches per inch may be applied.) An extra-strength, more elastic thread (cotton-wrapped polyester thread) is needed for leatherwork.

7. Hold seams together with paper clips (7A), mending tape (7B) or pin in the seam allowance. Gently position leather under the pressure foot and tie the threads. Avoid backstitching — this weakens the leather.

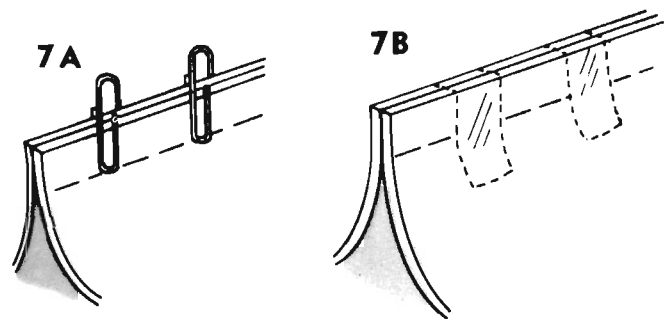

8. Reduce bulk by simply clipping curved seams (8A).

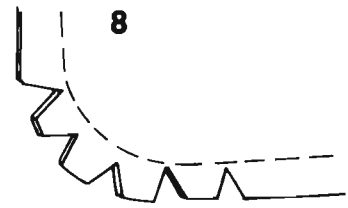

9. Now, apply rubber cement to all seam allowances (including curved seams) (9A).

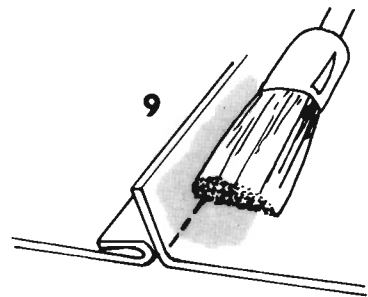

10. Pounding seams with a mallet, then lifting them lightly, flattens seams and lessens tension and pull.

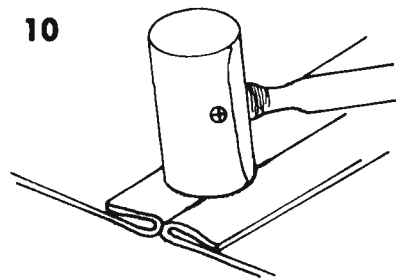

11. Place brown paper or press cloth between leather and iron and press with warm iron — do not steam.

LADIES COAT PATTERN No. 2684



tandy
LEATHER COMPANY
A TANDY CORPORATION COMPANY

You Will Need:

Rubber cement, lining material, cotton wrapped polyester thread, 6 buttons, buckle and interfacing material.

SUGGESTED MATERIALS:

New Zealand Lambskin Suede, Sheer Lambskin Suede, Reversible Garment Sides, or Mello-Tan.

ASSEMBLY INSTRUCTIONS

Gray screen indicates right side of leather.

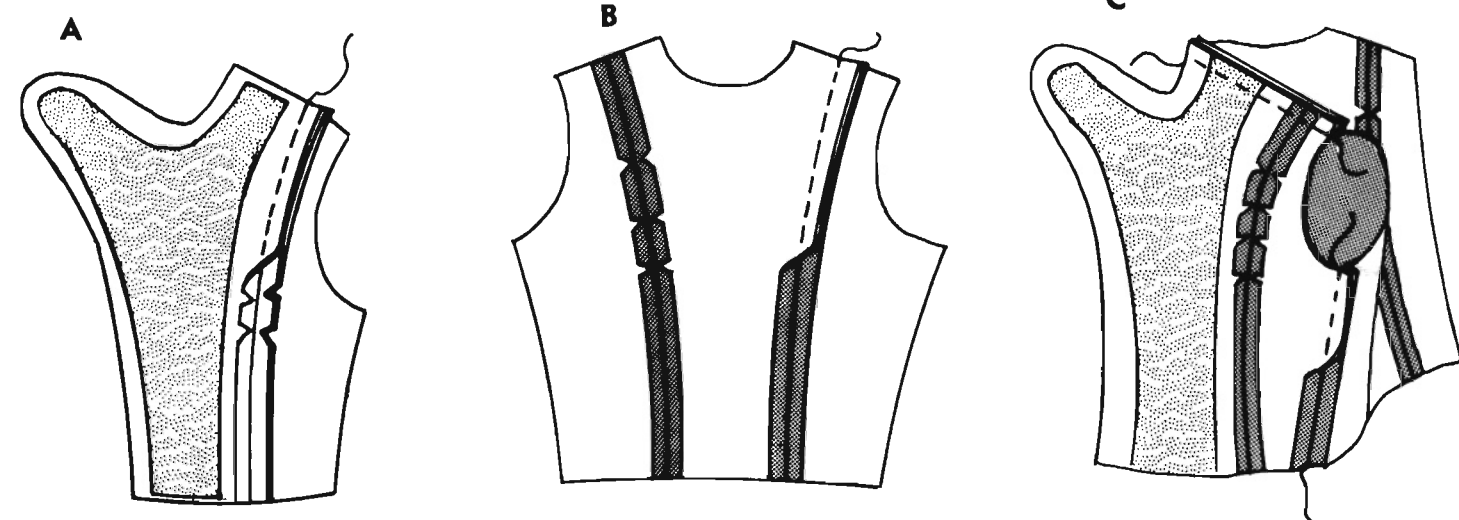

Step 1

TOP OF COAT. With right sides of leather together, stitch top side front to top center front, easing in top side fronts to fit, matching notches. Clip front seam edges as necessary. Cement seams open. Cement top front interfacing to wrong side of top center front (A).

With right sides of leather together stitch top side backs to top center backs, easing in side backs and matching at notches. Clip seam edges as necessary and cement open (B).

With right sides of leather together stitch at shoulder seams and side seams. Cement seam allowance down (C).

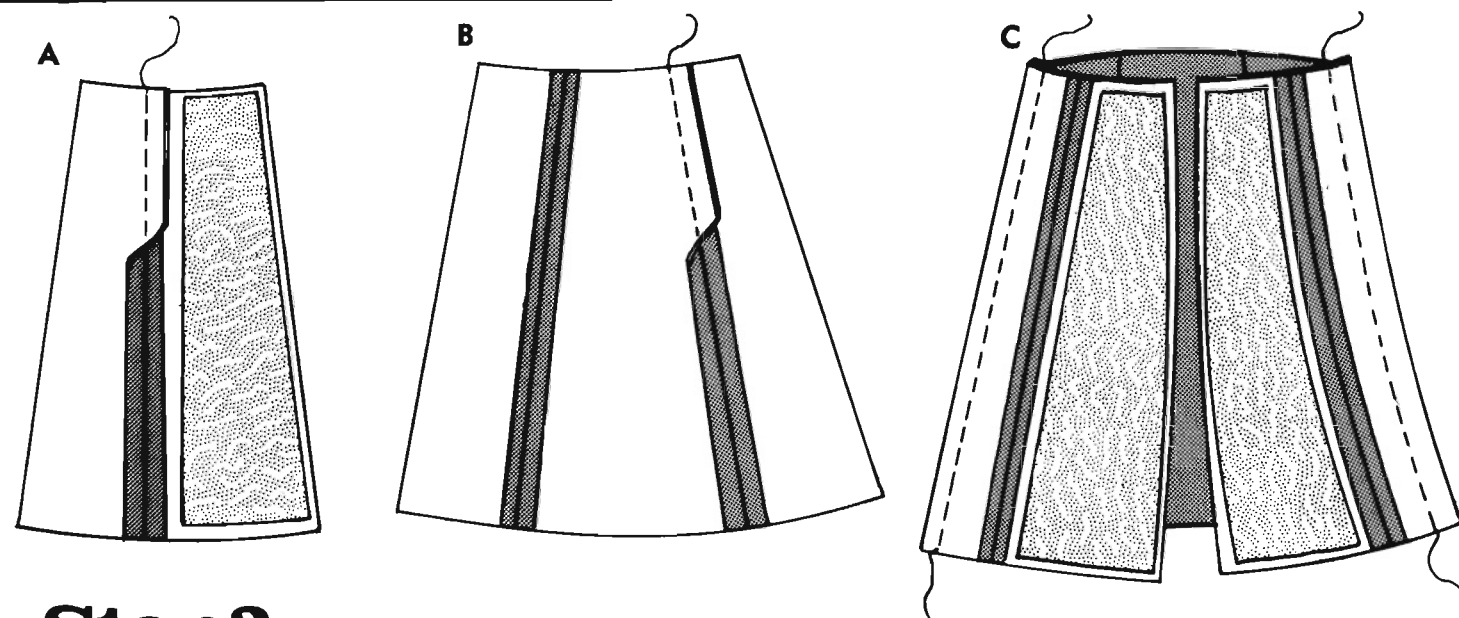

Step 2

COAT BOTTOM. Right sides of leather together stitch bottom side fronts to bottom center fronts at seam edges with single notch. Cement seam allowances down. Cement interfacing to wrong side of center fronts (A).

Right sides of leather together stitch bottom side backs to bottom center back, matching seam edges with two notches. Cement seams down (B).

Right sides of leather together attach bottom fronts to bottom back and cement seam allowance down (C).

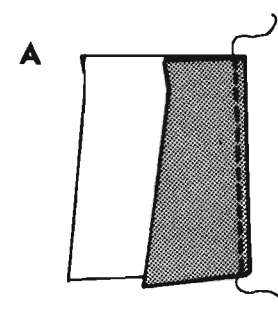

Step 3

POCKET TUCKS. Fold pockets, wrong sides together, on tuck lines and stitch 1/8" from folded edge (A). Repeat for other tuck (B).

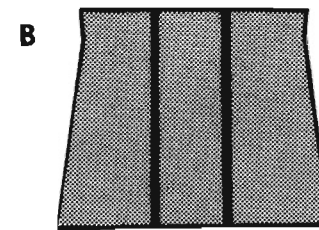

Apply cement to inside area of pocket self-facing. Fold on fold line and tap with mallet (C).

Apply cement to outside edges of wrong side of pocket. Fold on 1/2" seam line to inside and tap with mallet. Clip at corners. (D)

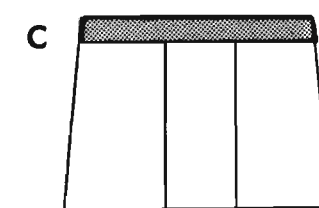

Align pocket on coat at pocket placement lines. Topstitch 1/8" from edge (E).

Pocket may be basted to coat with rubber cement. NOTE: Be sure to stay within pocket placement lines if you use rubber cement.

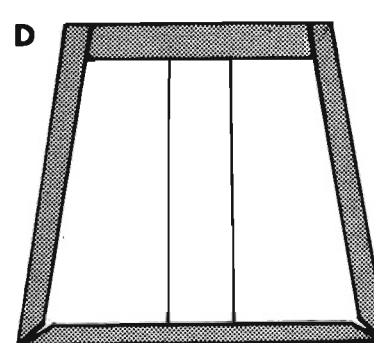

POCKET FLAP. With rubber cement baste flap interfacing to wrong side of pocket flap (F).

With right sides of leather together align pocket under flap with pocket flap and stitch together (G).

Clip corners and turn. Topstitch 1/8" from edges leaving top edge free (H). Turn free edge of top of pocket flap. Align flap with pocket flap placement lines and topstitch 1/8" from edge (I).

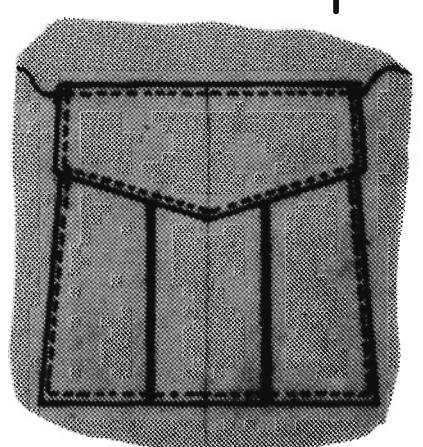
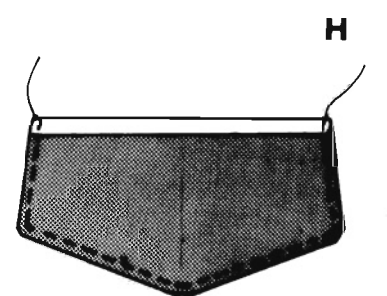
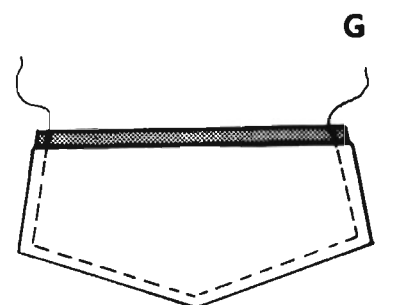
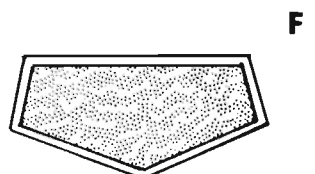
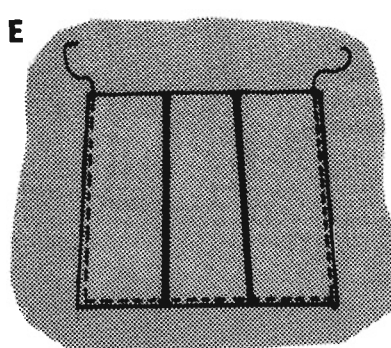

GENERAL INSTRUCTIONS

Leather is nature's product and subject to its varying conditions. Climate, the food and care given the animal and season of slaughter are a few of many factors which occasionally effect skin flaws. These are natural and in no way mean the skin is inferior. Eliminate flaws, when cutting, by placing the pattern in such a way as to avoid them.

Cutting pattern pieces on crosswise grain (against the grain) tends to stretch leather. Therefore, all lengthwise grain line markings on the pattern are parallel to backbone.

1. Because leather can not be folded, fashion duplicate paper patterns for all parts marked 'cut two'.
2. Lay out pattern pieces. Keep in mind the skin's greatest strength is down the center and parts which will incur the most wear should be cut from this backbone area.
3. Keep the pattern's lengthwise grainline parallel to backbone and try to have equal thicknesses of leather for related parts of your leather project.
4. Tape pattern to skin or attach with pins placed in the seam allowance. (Pattern may also be weighted down.)
5. Prior to cutting, you may want to trace around the pattern with chalk or pen. Then, with shears or razor knife, make the cut — employing long, even strokes.
6. Sewing leather usually entails some minor machine adjustments. First, change needles . . . we suggest size 11 for lightweight leathers and, for leathers of heavier weights, size 14. Adjust the stitch regulator to allow for seven to ten stitches per inch. (For sheer suedes, as many as twelve stitches

8. Reduce bulk by simply clipping curved seams (8A).

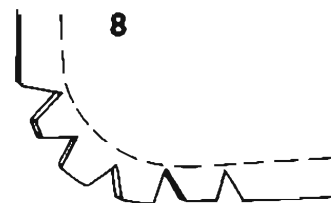

9. Now, apply rubber cement to all seam allowances (including curved seams) (9A).

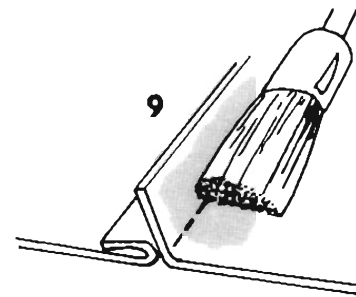

10. Pounding seams with a mallet, then lifting them lightly,

LADIES COAT PATTERN

No. 2684



per inch may be applied.) An extra-strength, more elastic thread (cotton-wrapped polyester thread) is needed for leatherwork.

7. Hold seams together with paper clips (7A), mending tape (7B) or pin in the seam allowance. Gently position leather under the pressure foot and tie the threads. Avoid backstitching – this weakens the leather.

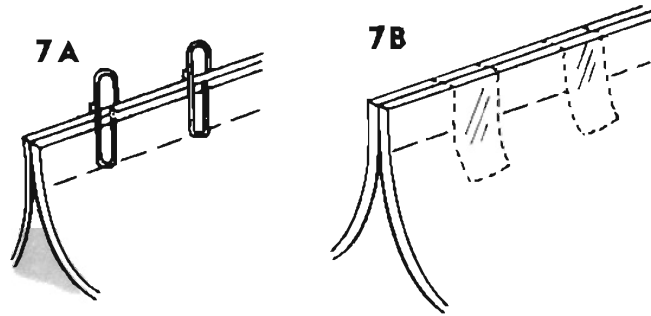

flattens seams and lessens tension and pull.

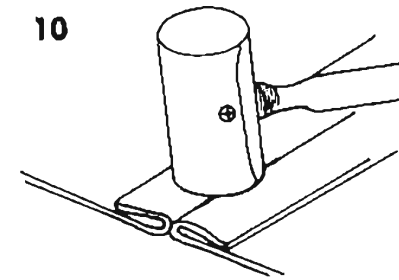

11. Place brown paper or press cloth between leather and iron and press with warm iron – do not steam.

ASSEMBLY INSTRUCTIONS

Gray screen indicates right side of leather.

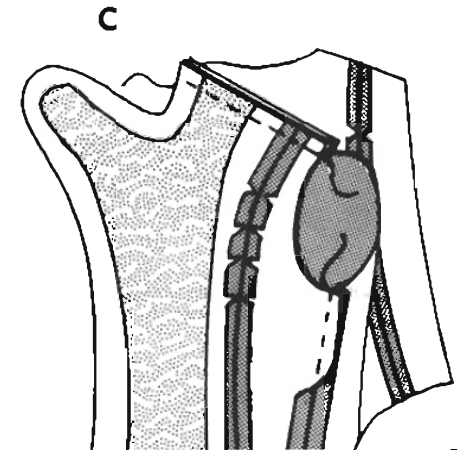
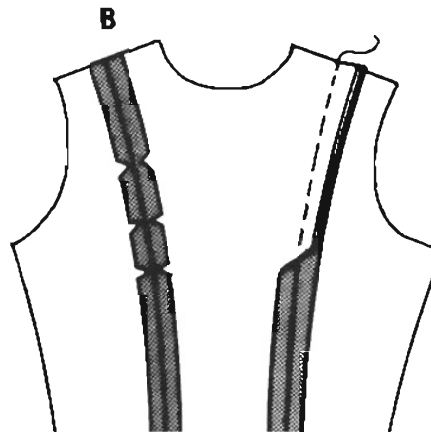
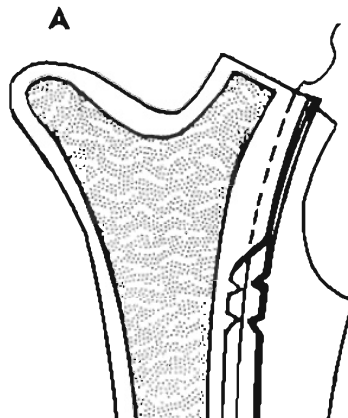



You Will Need:

Rubber cement, lining material, cotton wrapped polyester thread, 6 buttons, buckle and interfacing material.

SUGGESTED MATERIALS:

New Zealand Lambskin Suede, Sheer Lambskin Suede, Reversible Garment Sides, or Mello-Tan.

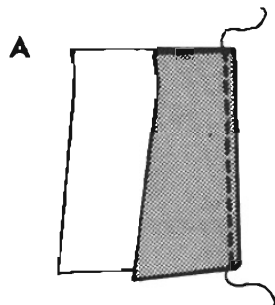

Step 3

POCKET TUCKS. Fold pockets, wrong sides together, on tuck lines and stitch 1/8" from folded edge (A). Repeat for other tuck (B).

Apply cement to inside area of pocket self-facing. Fold on fold line and tap with mallet (C).

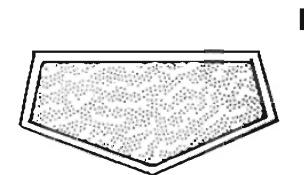



Step 1

TOP OF COAT. With right sides of leather together, stitch top side front to top center front, easing in top side fronts to fit, matching notches. Clip front seam edges as necessary. Cement seams open. Cement top front interfacing to wrong side of top center front (A).

With right sides of leather together stitch top side backs to top center backs, easing in side backs and matching at notches. Clip seam edges as necessary and cement open (B).

With right sides of leather together stitch at shoulder seams and side seams. Cement seam allowance down (C).

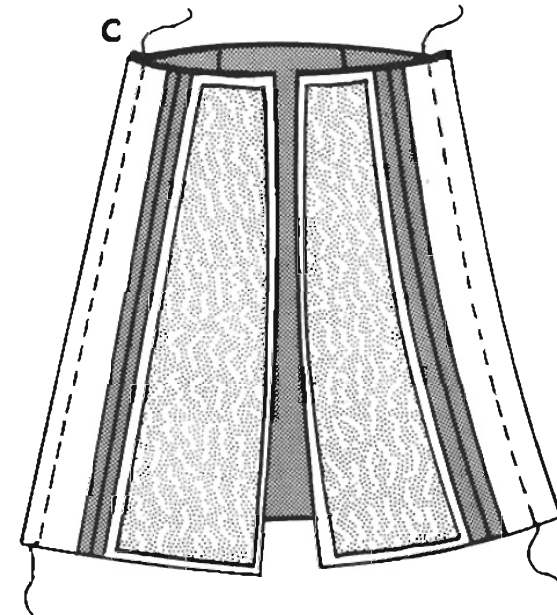
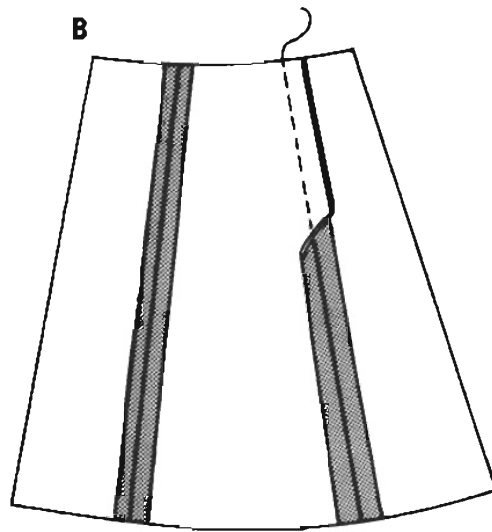
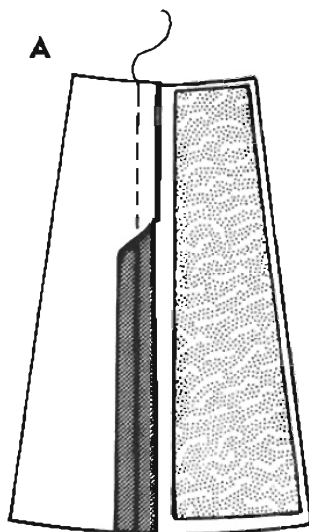

Step 2

COAT BOTTOM. Right sides of leather together stitch bottom side fronts to bottom center fronts at seam edges with single notch. Cement seam allowances down. Cement interfacing to wrong side of center fronts (A).

Right sides of leather together stitch bottom side backs to bottom center back, matching seam edges with two notches. Cement seams down (B).

Right sides of leather together attach bottom fronts to bottom back and cement seam allowance down (C).



Apply cement to outside edges of wrong side of pocket. Fold on 1/2" seam line to inside and tap with mallet. Clip at corners. (D)



C

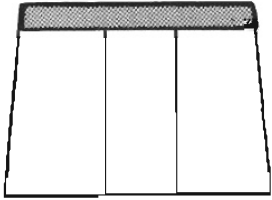

Align pocket on coat at pocket placement lines. Topstitch 1/8" from edge (E).

Pocket may be basted to coat with rubber cement. NOTE: Be sure to stay within pocket placement lines if you use rubber cement.

D

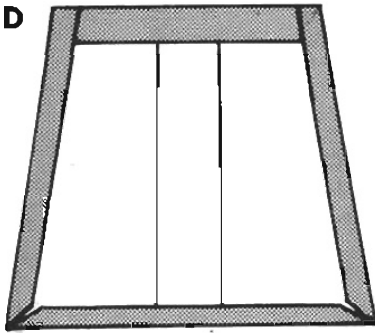

POCKET FLAP. With rubber cement baste flap interfacing to wrong side of pocket flap (F).

With right sides of leather together align pocket under flap with pocket flap and stitch together (G).

Clip corners and turn. Topstitch 1/8" from edges leaving top edge free (H). Turn free edge of top of pocket flap. Align flap with pocket flap placement lines and topstitch 1/8" from edge (I).

E

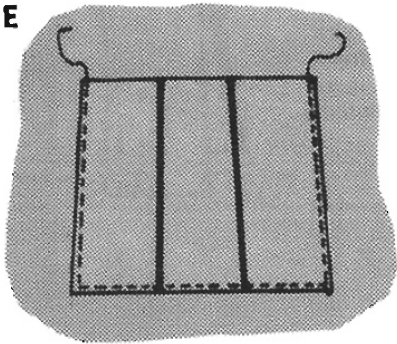

H

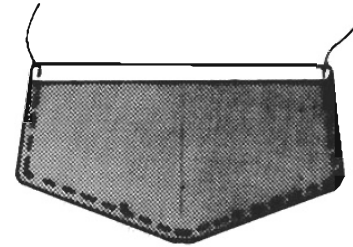

I

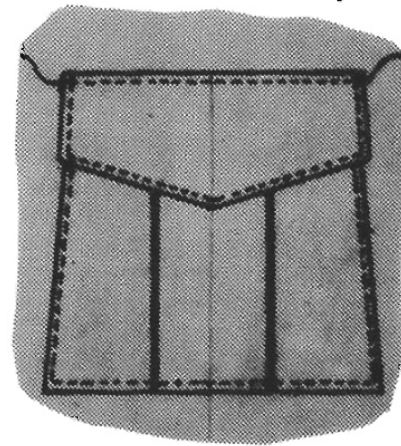

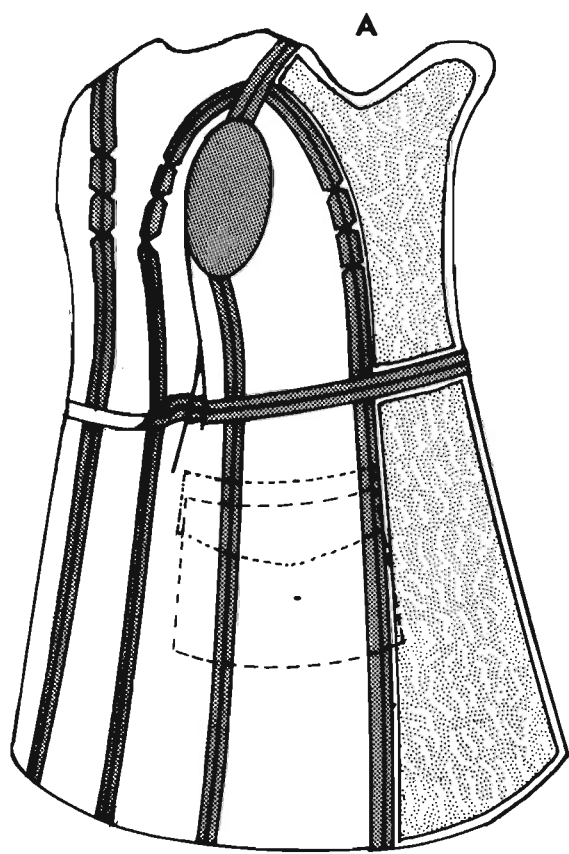

Step 4

ATTACHING COAT TOP TO COAT BOTTOM. Align side seams and front back seams of coat top and bottom, right sides of leather together. Sew together. Cement seam allowances open (A).

HEM. Turn coat hem up to desired length. Use rubber cement to hem coat. Apply cement to inside of hem area and press down. Triangular notches may need to be cut in hem to reduce bulk (B). Tap with mallet so hem will lie flat.

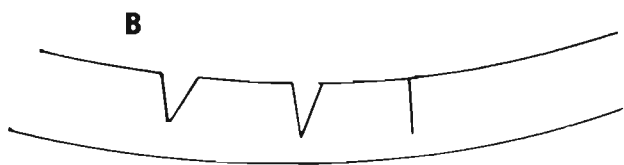

Step 8 (cont.)

INSTALLING LINING. Pin collar between notches on center fronts with undercollar on bottom (C).

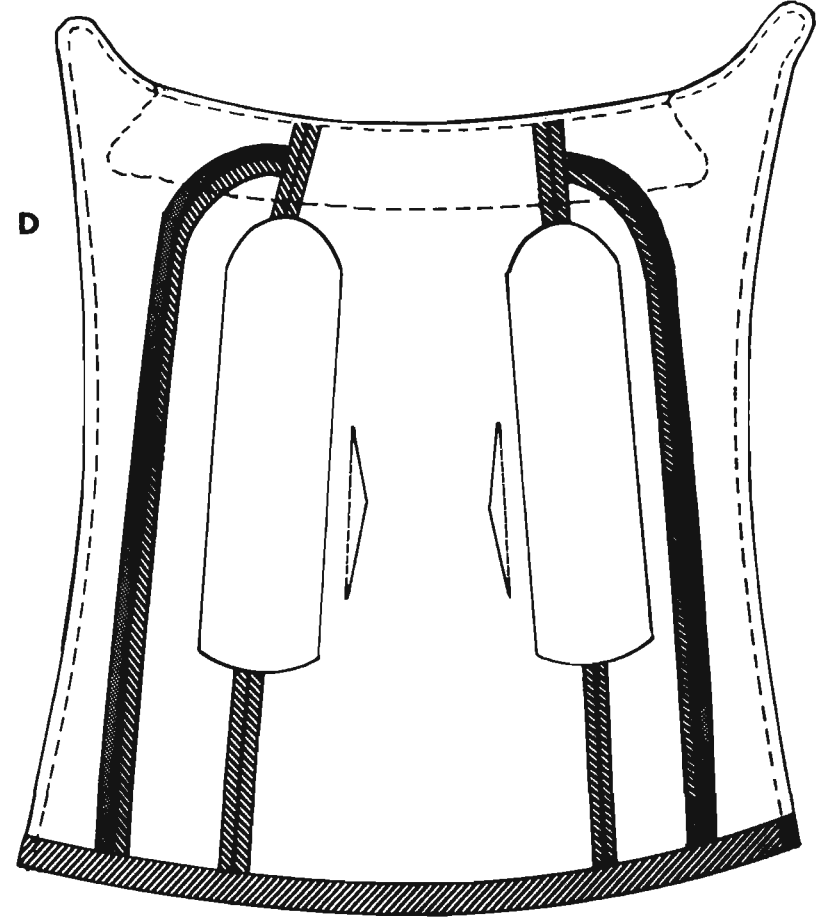
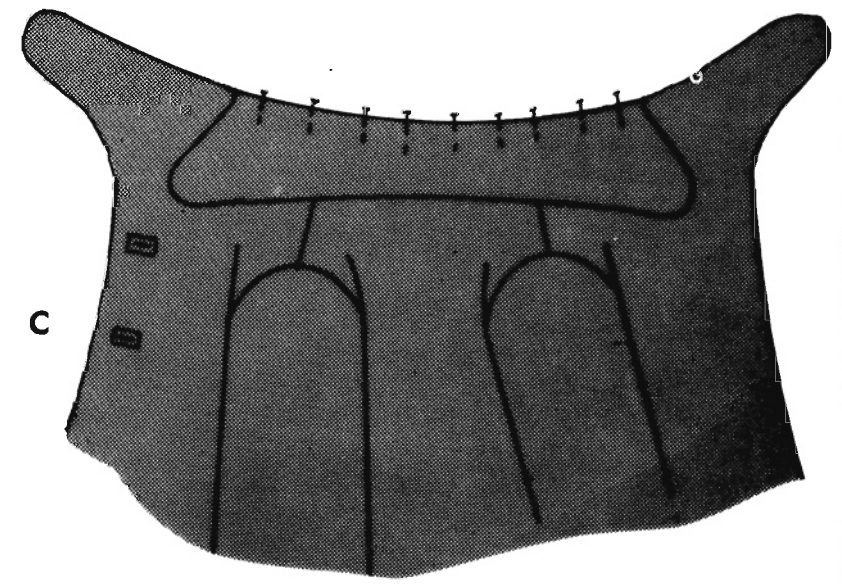

Baste right side of front facing with lining attached to coat. Begin stitching at lower hem of coat and facing and continue stitching up to corner of coat and facing, pivoting at corner, going along neck edge, catching coat neck edge, collar, facing and lining. Continue completely around opposite edge of coat (D). Clip curves, corners and turn. Press.

Step 5

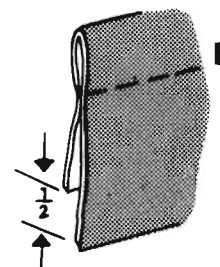
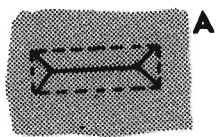

BUTTONHOLES. Make bound buttonholes on left front (see pattern for placement) following instructions below.

Mark placement of buttonhole with ball point pen on wrong side of leather. Length of buttonhole will be diameter plus one thickness of button. Mark off rectangle to indicate area of finished buttonhole. On stretchy leathers, stitch marked rectangle. Cut buttonhole as shown (A). Fold back small flaps and press. Prepare buttonhole strips by cutting two leather strips for each buttonhole about 2" wide. Fold lengthwise, right sides out, as shown, with fold about 1/2" from one edge (B). Place a prepared strip lengthwise in opening with widest part of strip toward wrong side of garment. Hold strip in position with tape and stitch along marked buttonhole line. (You will be stitching through three thickness of leather.) Repeat for other side (C). Pull loose ends of buttonhole through to wrong side of leather. Stitch to secure (D). Make cuts in facing same as original buttonhole. Turn under flaps glue and pound with mallet.

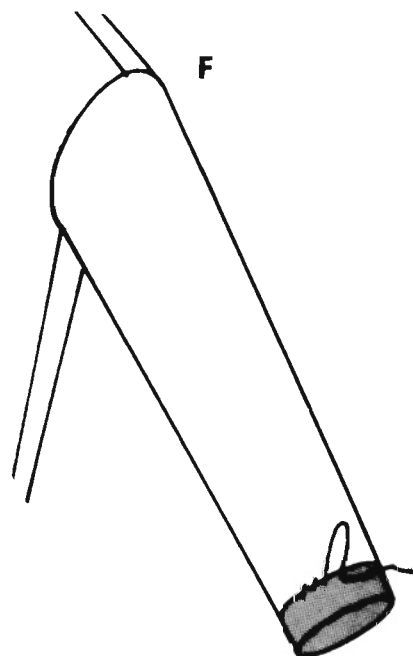
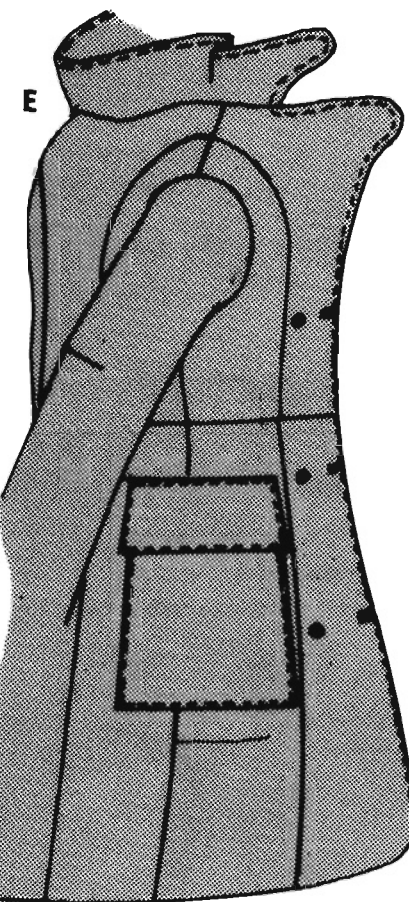
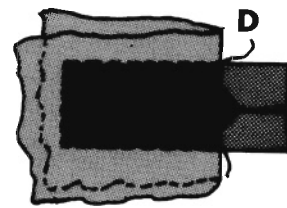
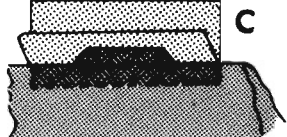

Beginning at lower edge of center front sections, topstitch 1/8" away from front and collar edges as illustrated (E). Complete underside of bound buttonhole.

Pull coat sleeve out inside sleeve lining. To form lower sleeve facing, turn end of coat sleeve and cement down. Cement should be applied to inside area of lower sleeve. Adjust lining length, whipstitch to sleeve facing (F).

Step 6

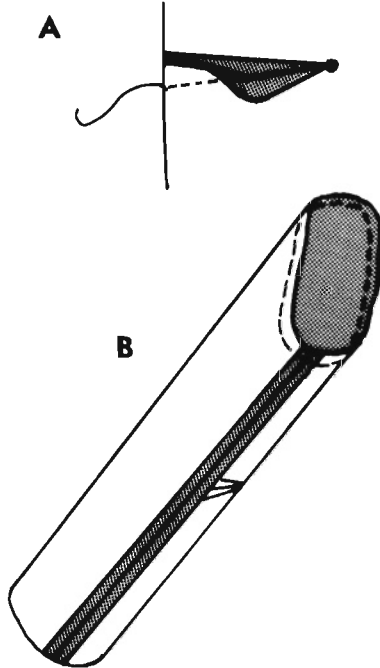

SLEEVE DART. Fold on dotted lines right side of leather together, and stitch to dot. Clip and cement down (A).

SLEEVES. Control ease in sleeve cap with a single row of stitching on seam line. Fold sleeve and stitch sleeve seam with right sides of leather together (B).

Pin sleeve into armhole, matching underarm seams. Ease so sleeve fits. Baste, adjusting ease. Stitch. Trim. (C)

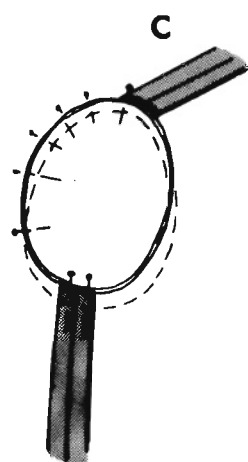

Step 7

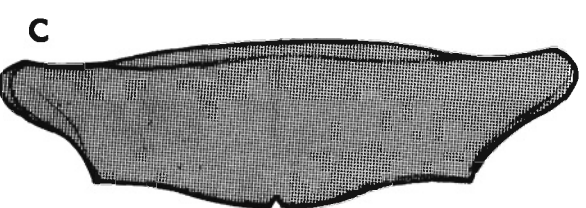
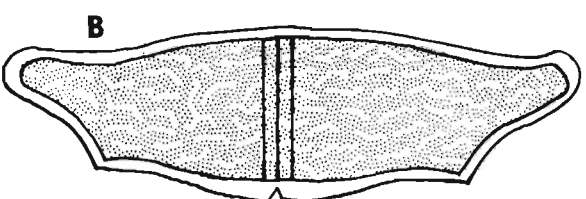
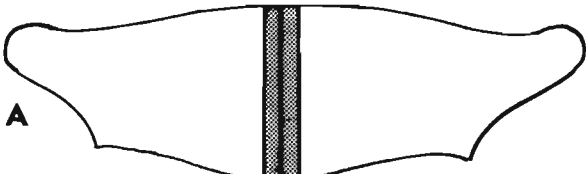

COLLAR. Right sides of leather together, stitch undercollars together at middle seam. Cement seam allowances down (A).

With rubber cement baste interfacing to wrong side of top collar (B). Right sides together, stitch collar together. Clip corners, trim, turn and press (C).

Step 9

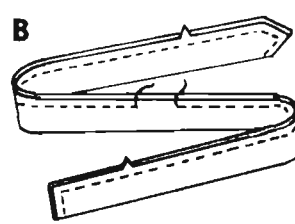
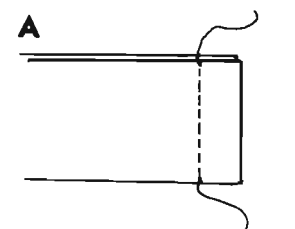

BELT. With right sides of leather together, sew belt pieces together at 1/2" seam allowance edges, cement seam allowance open (A). Fold belt on fold line, right sides of leather together. Stitch seam edges and taking up 1/4" seam, leaving an opening for turning. Trim seam allowances. Turn right side out and cement opening edges together (B). Topstitch 1/8" from outer edges of belt (C). Attach buckle by slipping buckle on buckle end of belt and folding leather around center bar of buckle. Stitch (D).

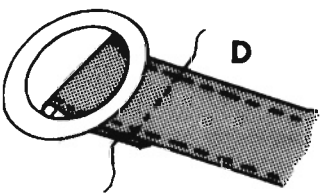
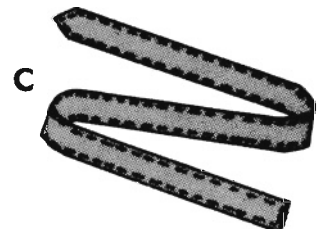

Step 8

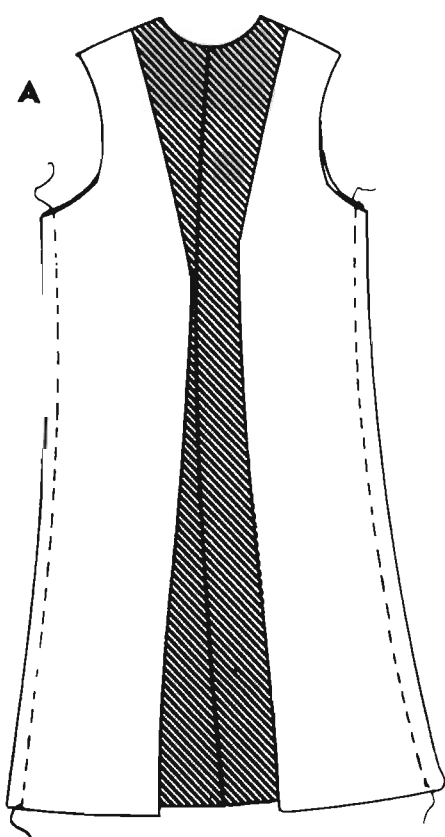

LINING. With right sides together, join front lining to back lining at side seam. Press seams open (A).

Hem lining before attaching front facing. Stitch with right side of leather front facing and right side of front lining together. Clip where necessary. Press seams open. Stitch together at shoulder seams (B). Repeat for other side.

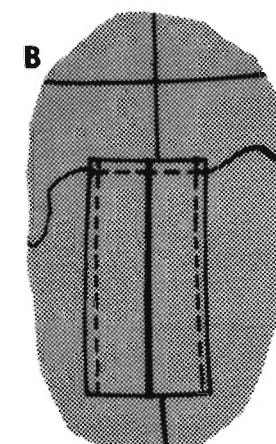
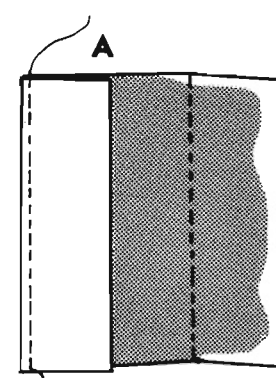
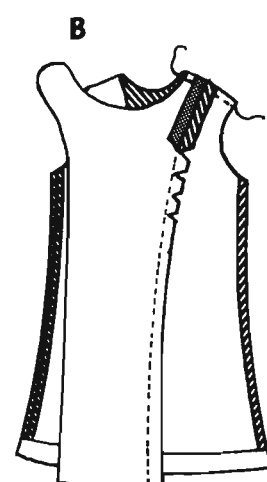

Step 10

BELT LOOPS. Note: Belt loops should be attached to center front seams and center back seams. Apply cement to entire wrong side of belt loop. Fold outside edges inward on fold lines. Tap flat with mallet and topstitch edges (A).

Centering on seam, lay belt loop wrong side up on right side of coat 1" below waist seam line. Stitch down (B).

Fold under top of belt loop, bring up 1" above waist seam and topstitch (C).

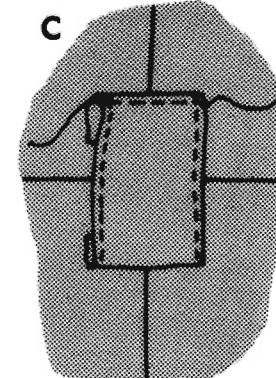

Step 11

BUTTONS. Locate and attach buttons according to placement shown on pattern using the following instructions:

To sew on a button with a stay button: for jacket and coat buttons receiving hard wear sew a small button directly under the top button on the facing side as shown. Both buttons are sewn on in one operation.



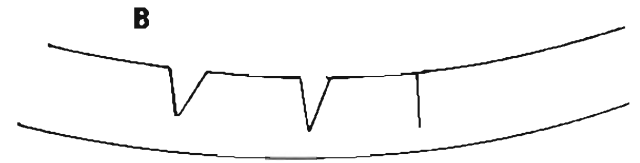
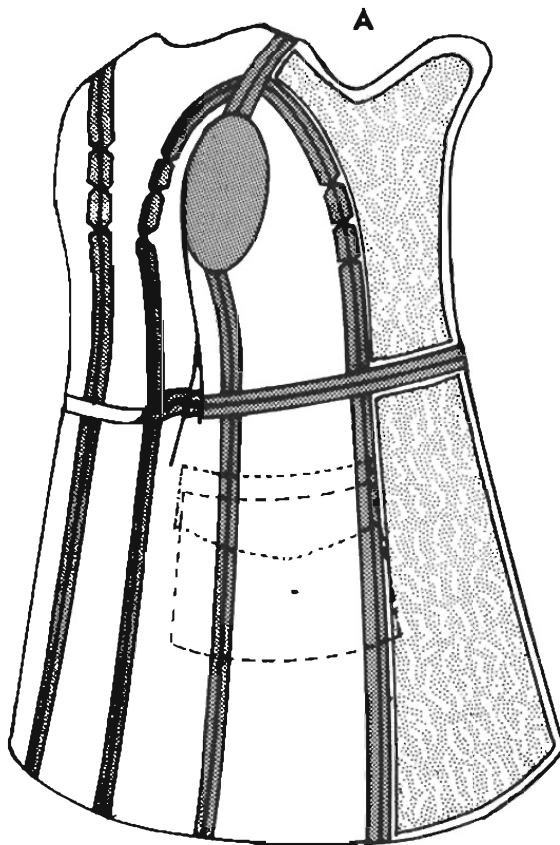

Step 4

ATTACHING COAT TOP TO COAT BOTTOM. Align side seams and front back seams of coat top and bottom, right sides of leather together. Sew together. Cement seam allowances open (A).

HEM. Turn coat hem up to desired length. Use rubber cement to hem coat. Apply cement to inside of hem area and press down. Triangular notches may need to be cut in hem to reduce bulk (B). Tap with mallet so hem will lie flat.

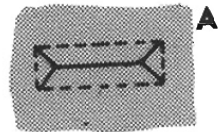

Step 5

BUTTONHOLES. Make bound buttonholes on left front (see pattern for placement) following instructions below.

Mark placement of buttonhole with ball point pen on wrong side of leather. Length of buttonhole will be diameter plus one

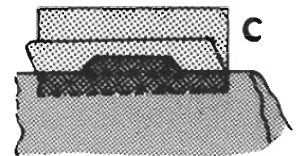

Step 8 (cont.)

INSTALLING LINING. Pin collar between notches on center fronts with undercollar on bottom (C).

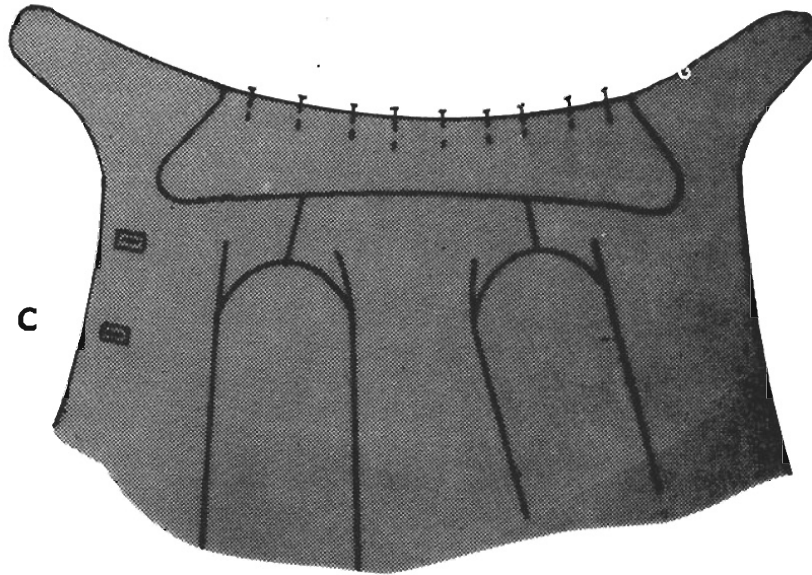

Baste right side of front facing with lining attached to coat. Begin stitching at lower hem of coat and facing and continue stitching up to corner of coat and facing, pivoting at corner, going along neck edge, catching coat neck edge, collar, facing and lining. Continue completely around opposite edge of coat (D). Clip curves, corners and turn. Press.

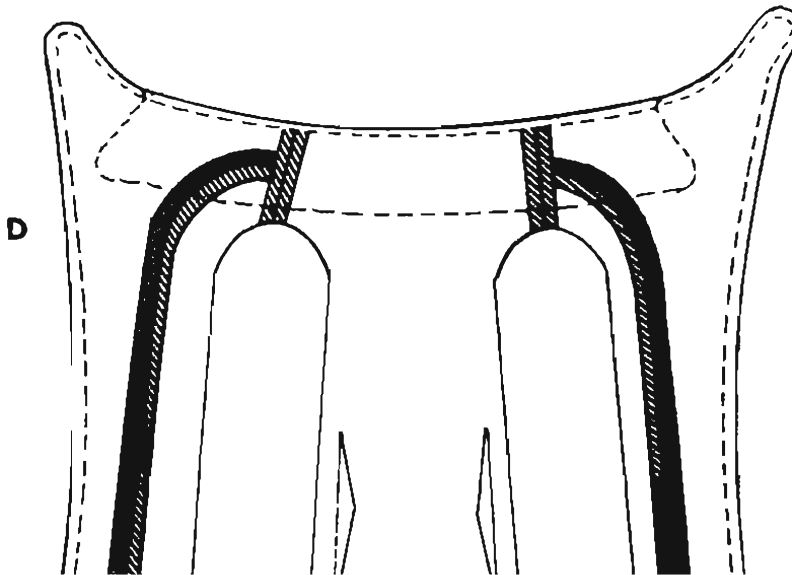

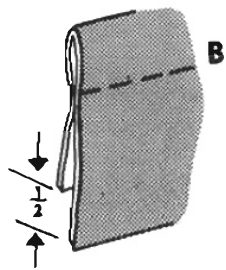

thickness of button. Mark off rectangle to indicate area of finished buttonhole. On stretchy leathers, stitch marked rectangle. Cut buttonhole as shown (A). Fold back small flaps and press. Prepare buttonhole strips by cutting two leather strips for each buttonhole about 2" wide. Fold lengthwise, right sides out, as shown, with fold about 1/2" from one edge (B). Place a prepared strip lengthwise in opening with widest part of strip toward wrong side of garment. Hold strip in position with tape and stitch along marked buttonhole line. (You will be stitching through three thickness of leather.) Repeat for other side (C). Pull loose ends of buttonhole through to wrong side of leather. Stitch to secure (D). Make cuts in facing same as original buttonhole. Turn under flaps glue and pound with mallet.

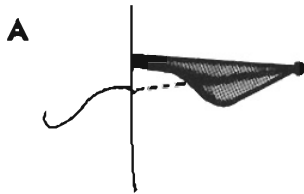
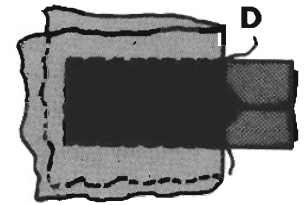

Step 6

SLEEVE DART. Fold on dotted lines right side of leather together, and stitch to dot. Clip and cement down (A).

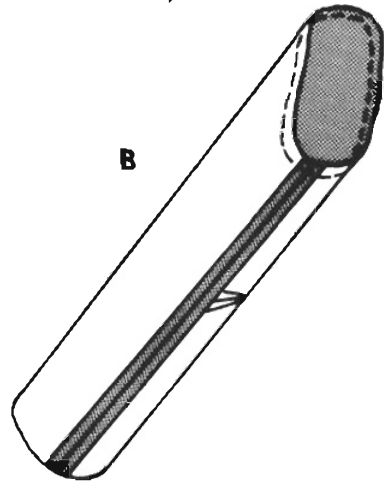

SLEEVES. Control ease in sleeve cap with a single row of stitching on seam line. Fold sleeve and stitch sleeve seam with right sides of leather together (B).

Pin sleeve into armhole, matching underarm seams. Ease so sleeve fits. Baste, adjusting ease. Stitch. Trim. (C)

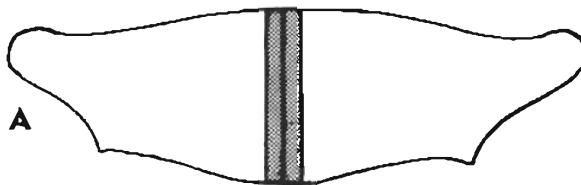
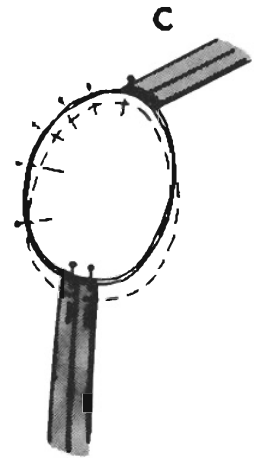

Step 7

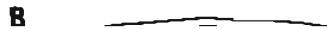

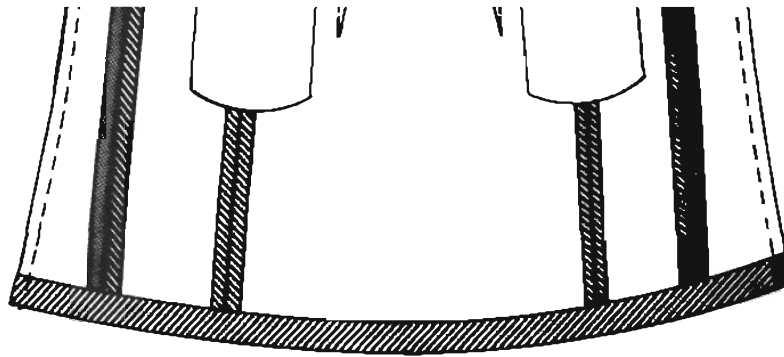

Beginning at lower edge of center front sections, topstitch 1/8" away from front and collar edges as illustrated (E). Complete underside of bound buttonhole.

E

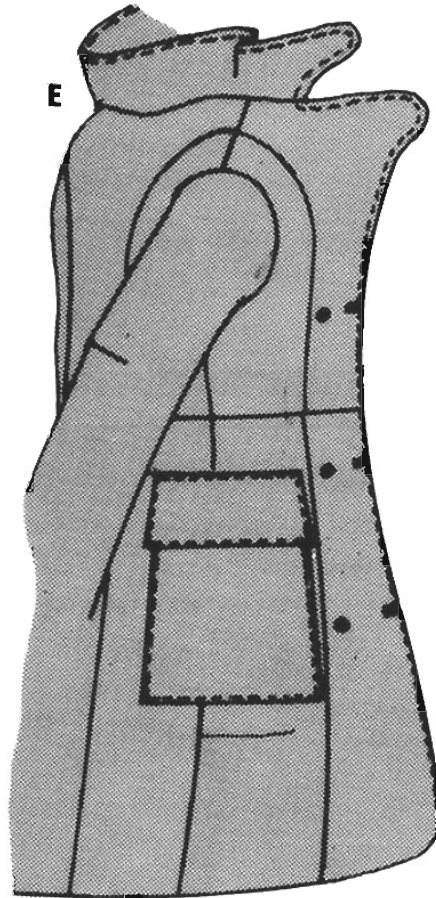

Pull coat sleeve out inside sleeve lining. To form lower sleeve facing, turn end of coat sleeve and cement down. Cement should be applied to inside area of lower sleeve. Adjust lining length, whipstitch to sleeve facing (F).

F

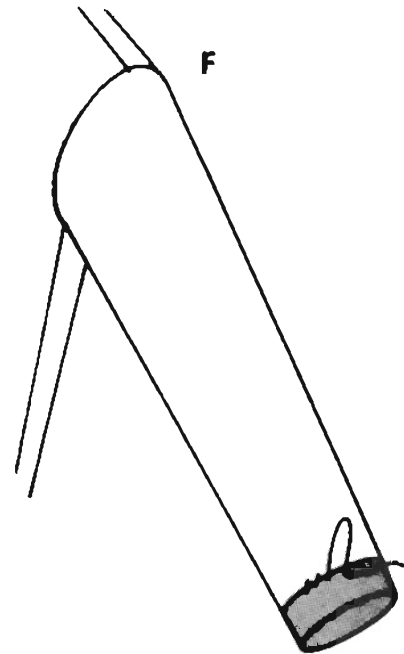

Step 9

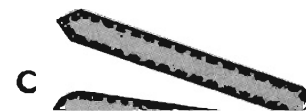

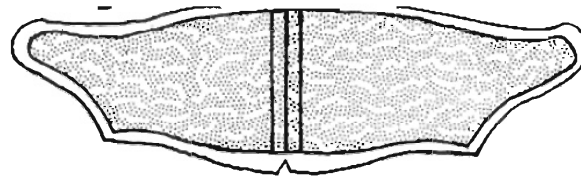

COLLAR. Right sides of leather together, stitch undercollars together at middle seam. Cement seam allowances down (A).

With rubber cement baste interfacing to wrong side of top collar (B). Right sides together, stitch collar together. Clip corners, trim, turn and press (C).

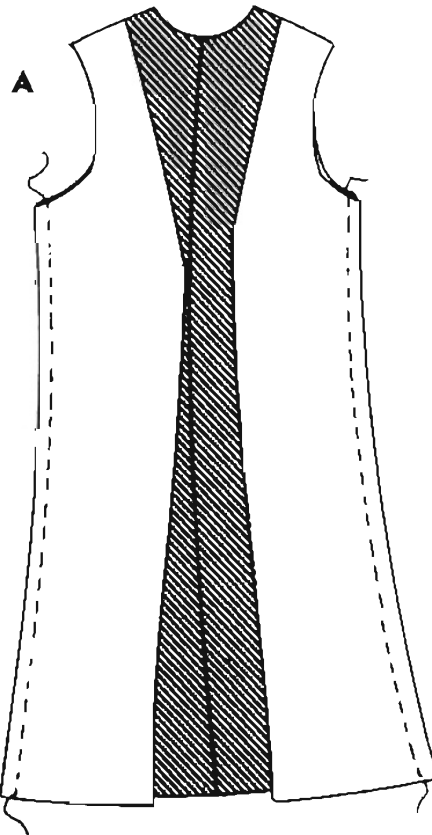
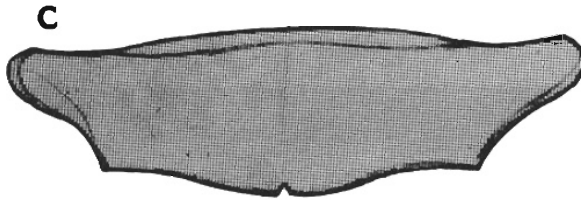

Step 8

LINING. With right sides together, join front lining to back lining at side seam. Press seams open (A).

Hem lining before attaching front facing. Stitch with right side of leather front facing and right side of front lining together. Clip where necessary. Press seams open. Stitch together at shoulder seams (B). Repeat for other side.

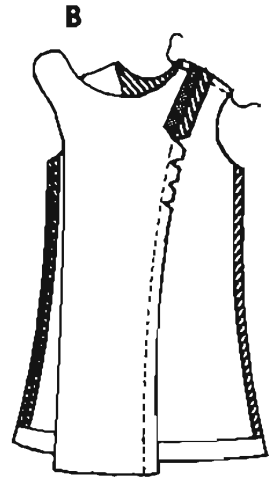

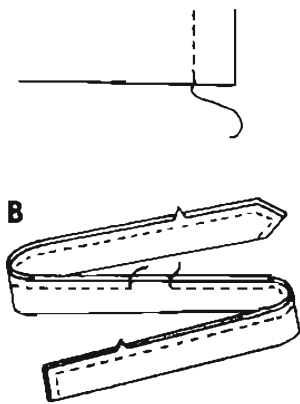

BELT. With right sides of leather together, sew belt pieces together at 1/2" seam allowance edges, cement seam allowance open (A). Fold belt on fold line, right sides of leather together. Stitch seam edges and taking up 1/4" seam, leaving an opening for turning. Trim seam allowances. Turn right side out and cement opening edges together (B). Topstitch 1/8" from outer edges of belt (C). Attach buckle by slipping buckle on buckle end of belt and folding leather around center bar of buckle. Stitch (D).

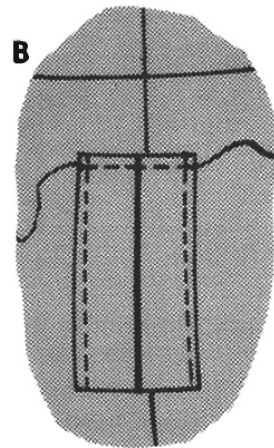
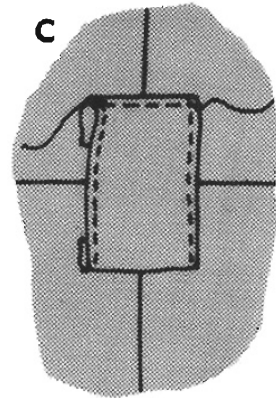
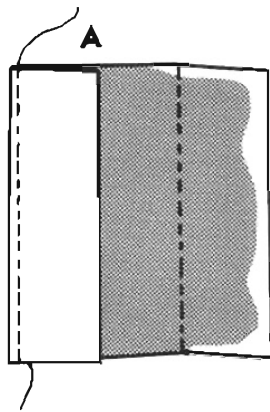
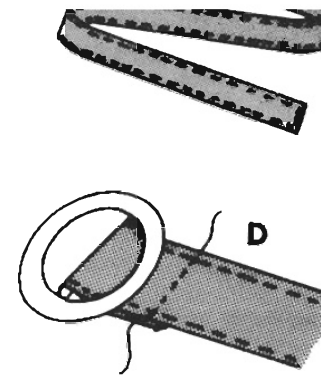

Step 10

BELT LOOPS. Note: Belt loops should be attached to center front seams and center back seams. Apply cement to entire wrong side of belt loop. Fold outside edges inward on fold lines. Tap flat with mallet and topstitch edges (A).

Centering on seam, lay belt loop wrong side up on right side of coat 1" below waist seam line. Stitch down (B).

Fold under top of belt loop, bring up 1" above waist seam and topstitch (C).

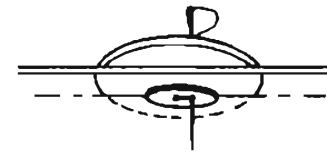

Step 11

BUTTONS. Locate and attach buttons according to placement shown on pattern using the following instructions:

To sew on a button with a stay button: for jacket and coat buttons receiving hard wear sew a small button directly under the top button on the facing side as shown. Both buttons are sewn on in one operation.

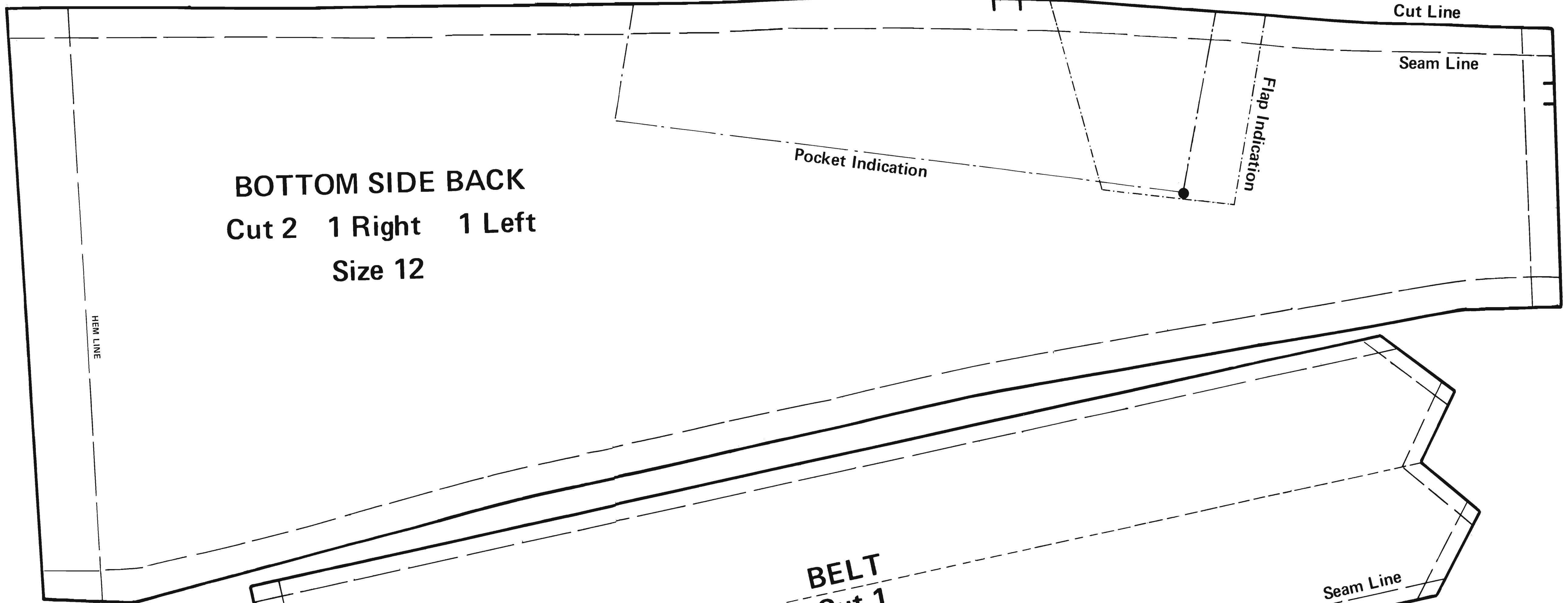
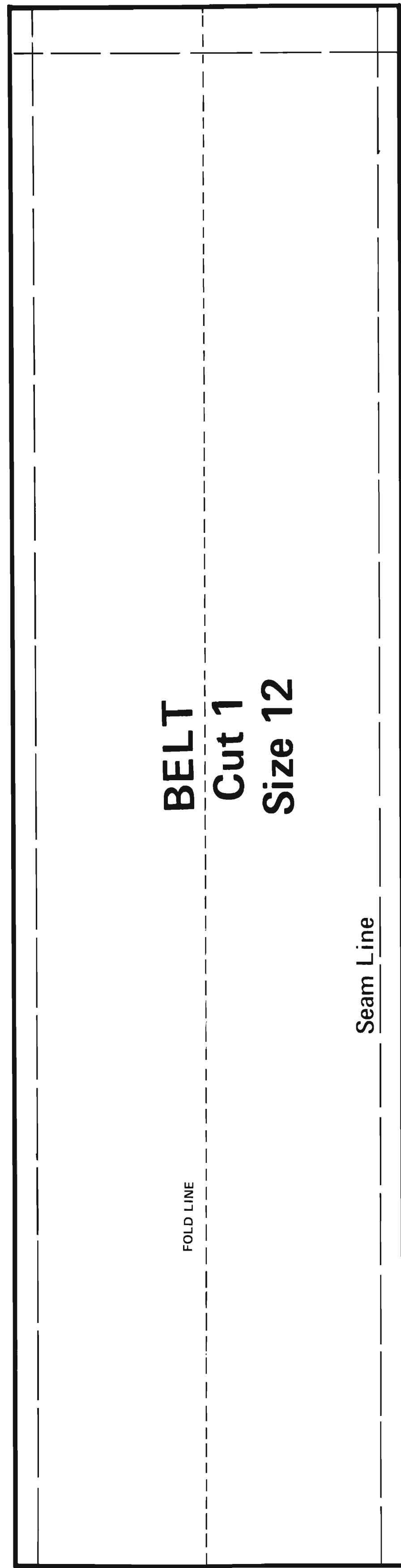

PATTERN PARTS
LADIES COAT
Size 12

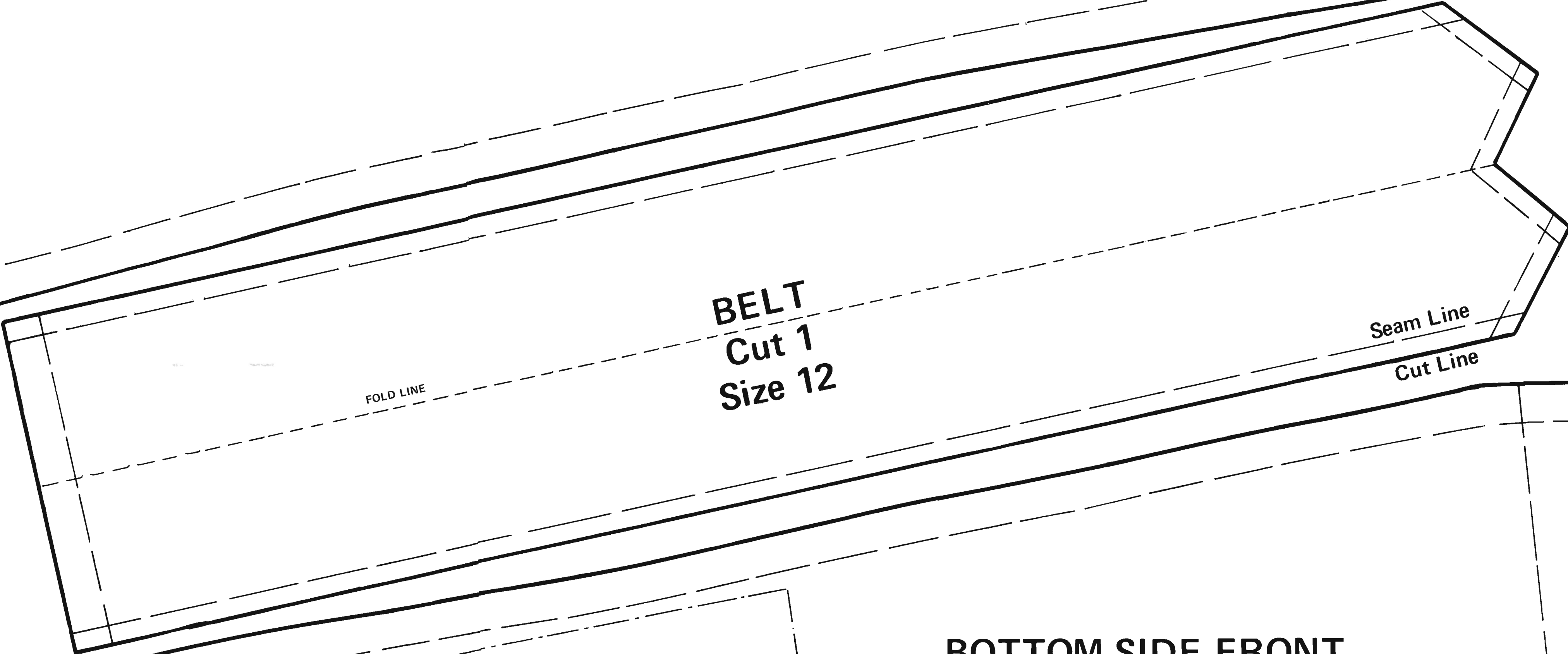

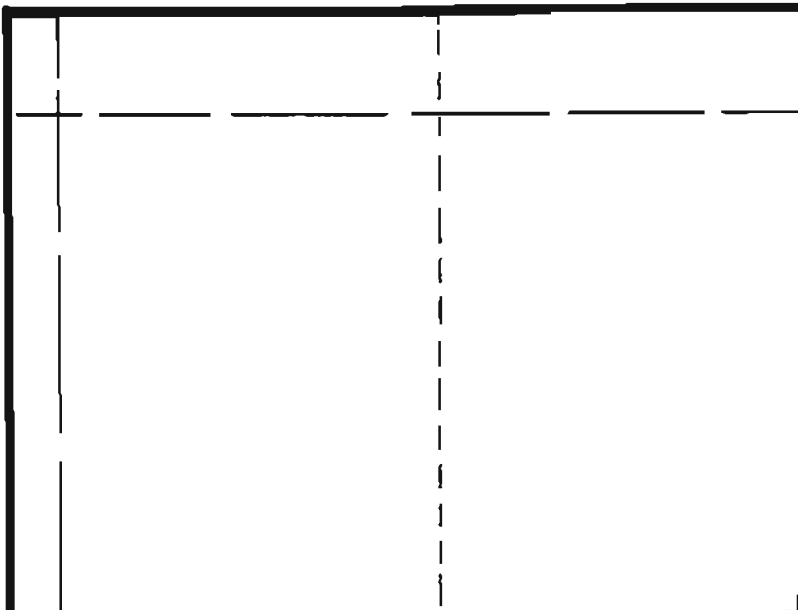

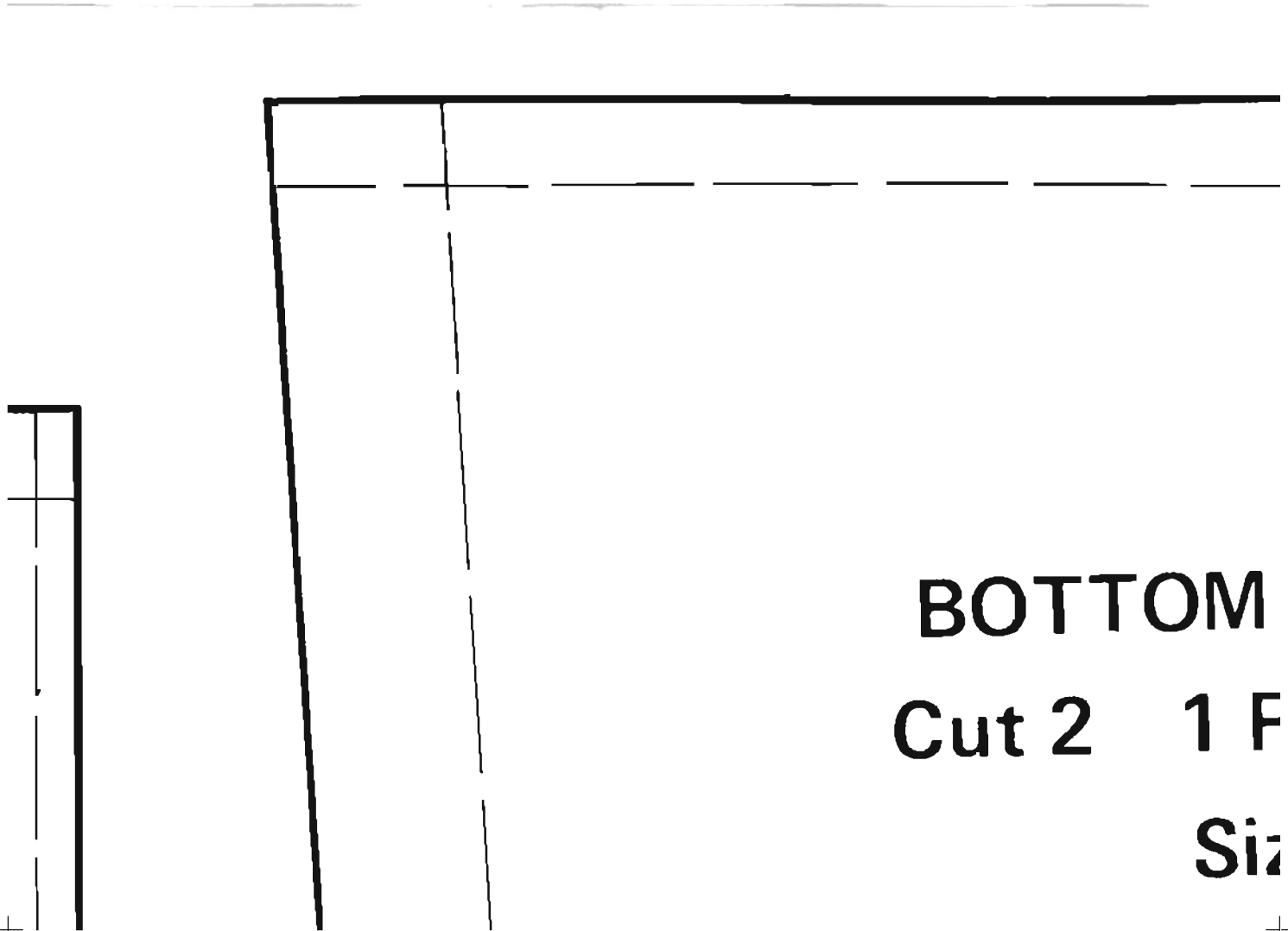

BOTTOM

Cut 2 1 F

Size

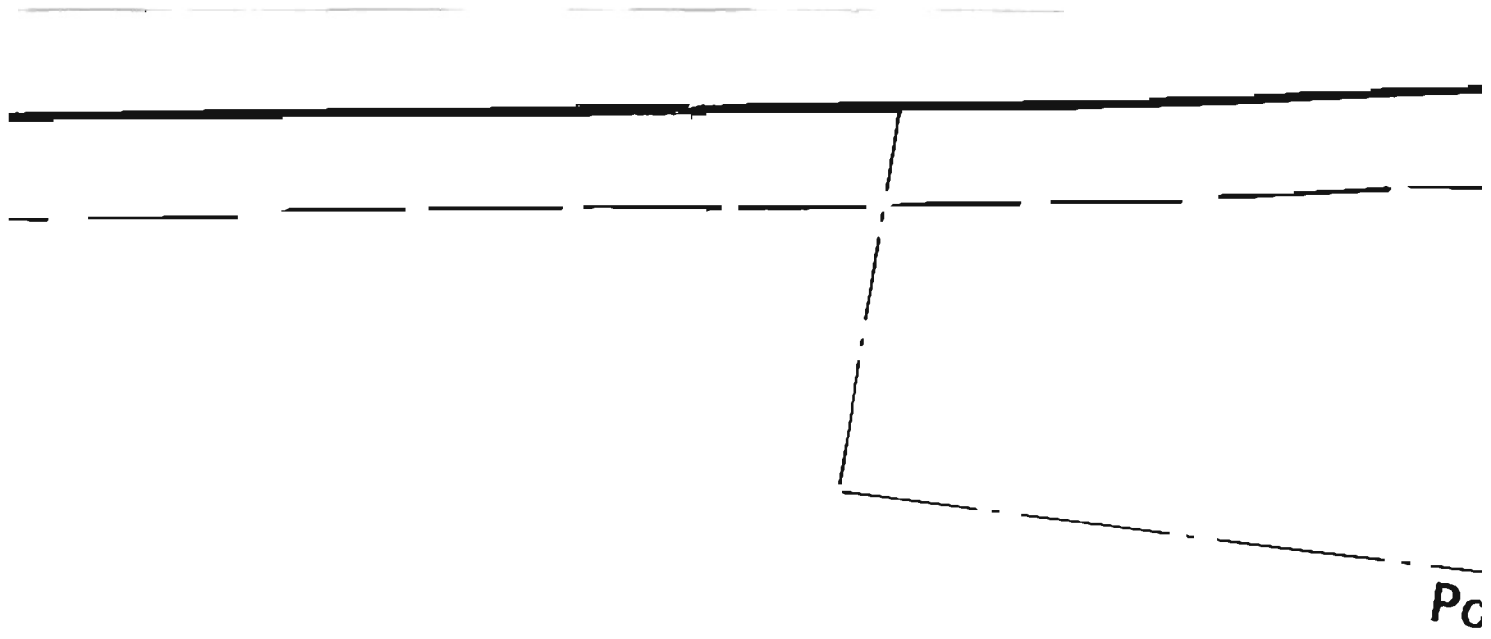

SIDE BACK

Right 1 Left

ze 12

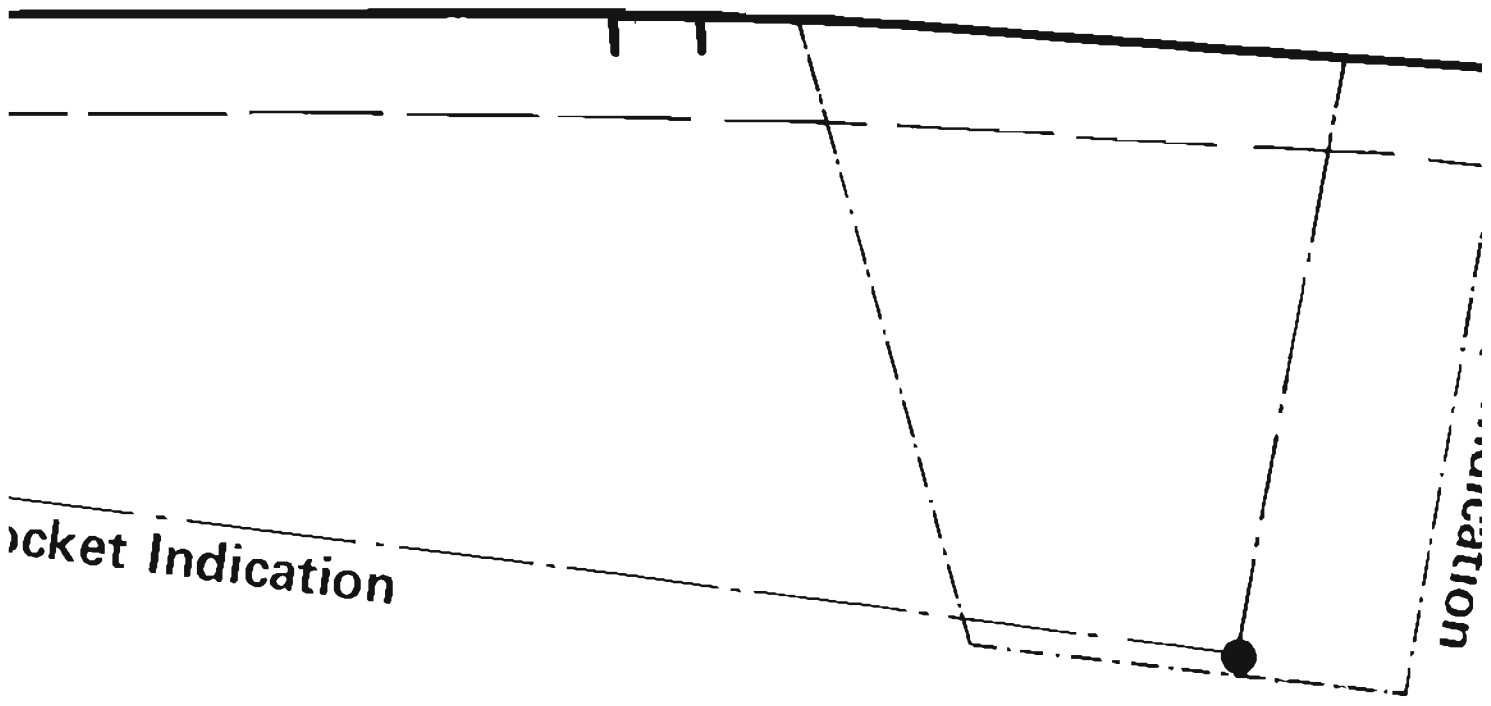

Cut Line

Seam Line

Flap Indica...

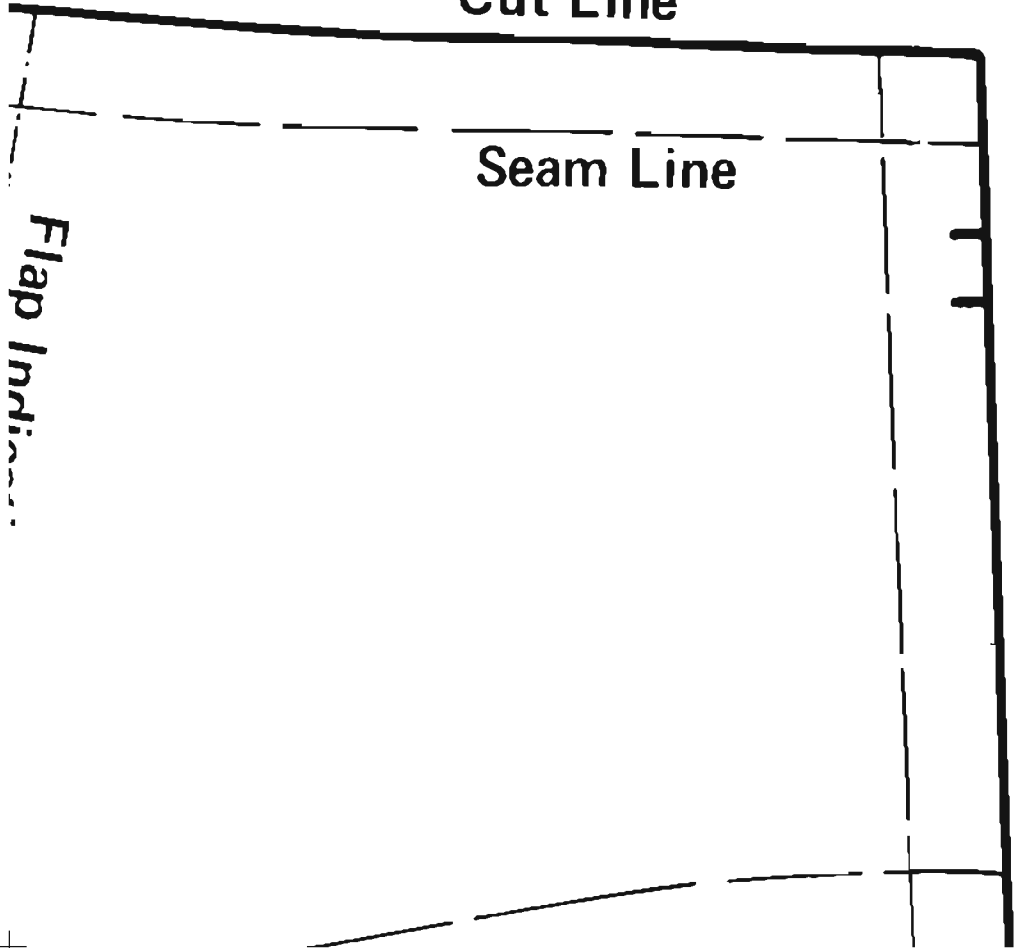

BELT
Cut 1
Size 12

Seam Line

Cut Line

HEM LINE

PATTERN PARTS
LADIES COAT
Size 12

Line

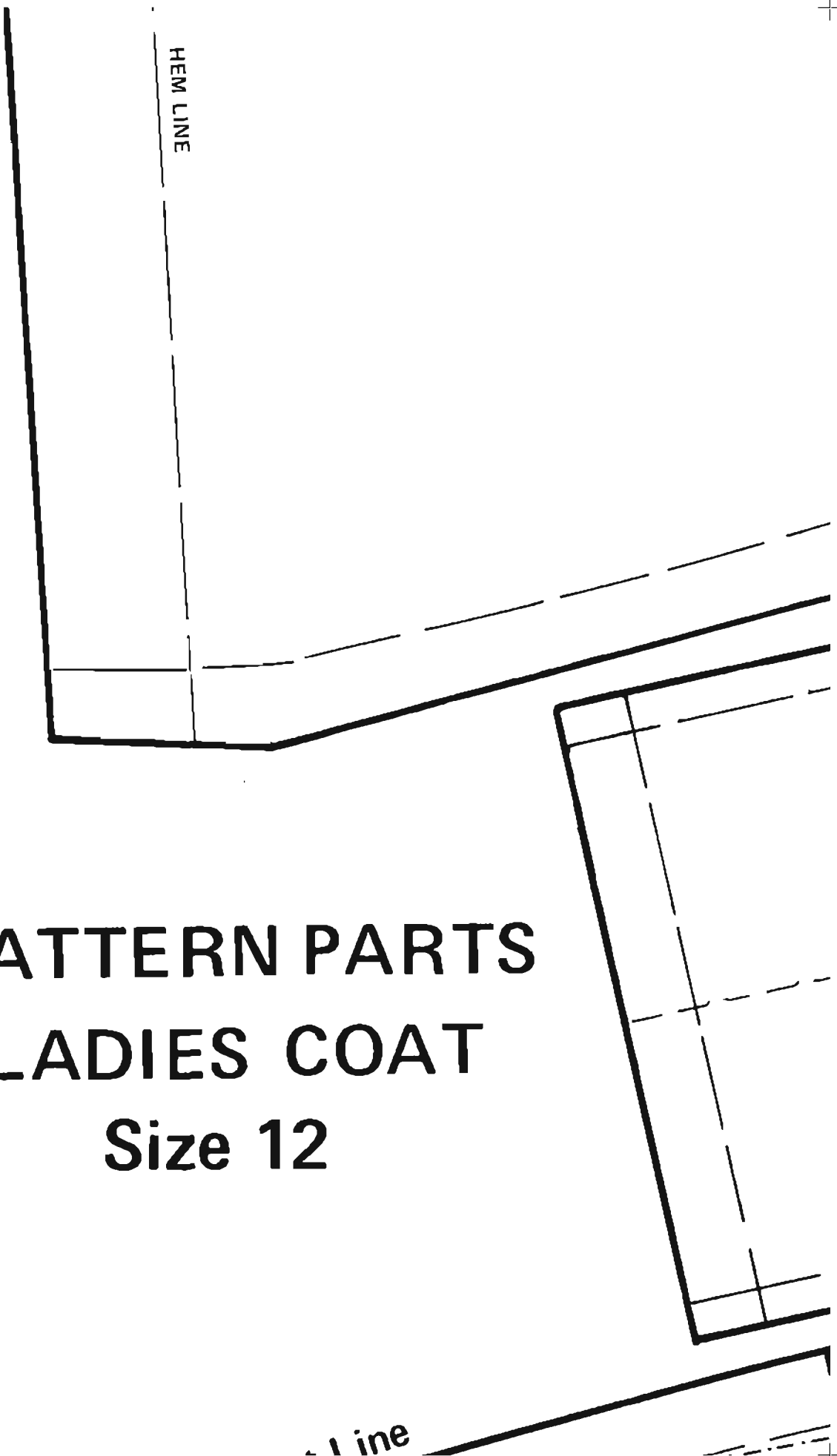

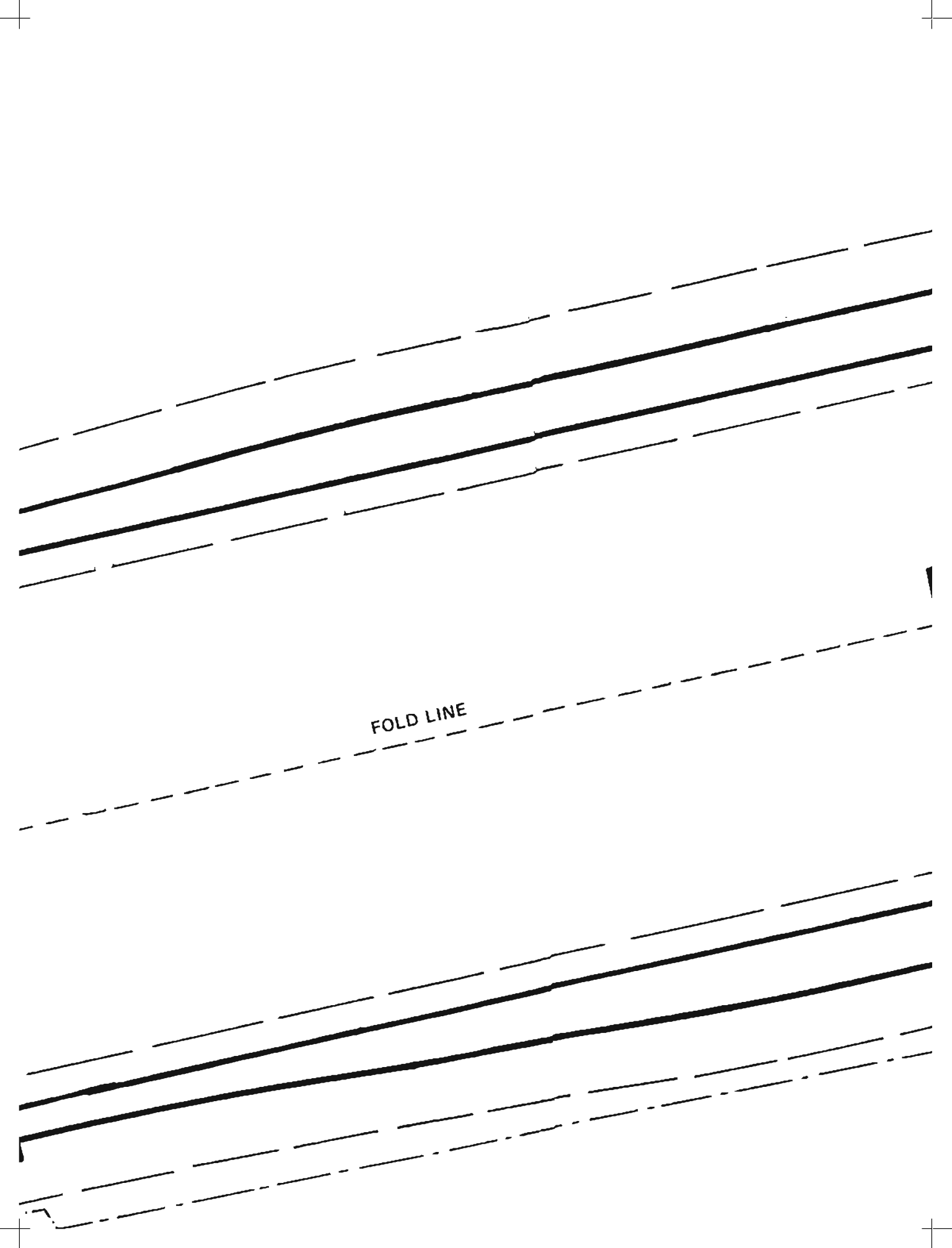

FOLD LINE



BELT
Cut 1
Size 12

BOTTOM SIDE FRC
Cut 2 1 Right 1 L

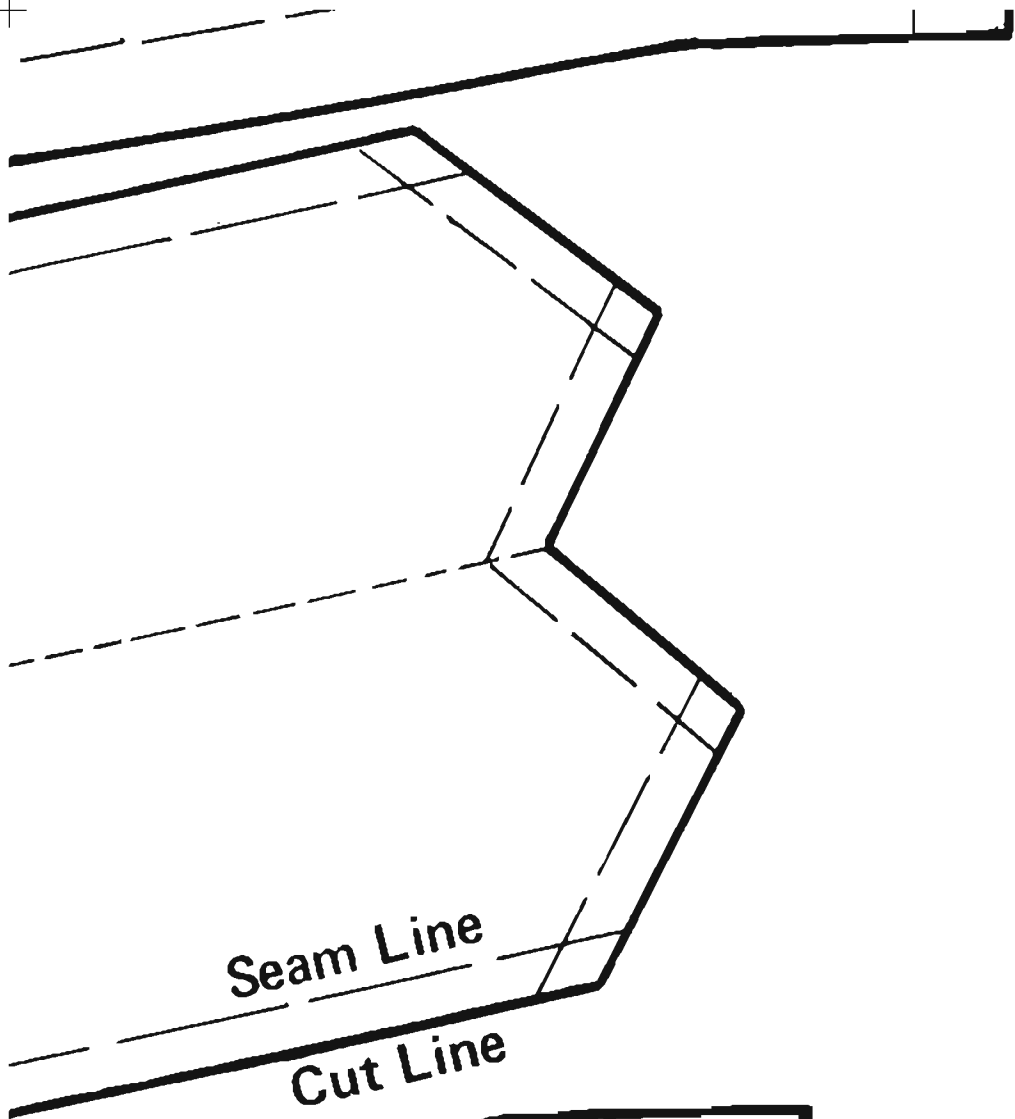

ONT
eft

FOLD LINE

Cut L.

Seam Line

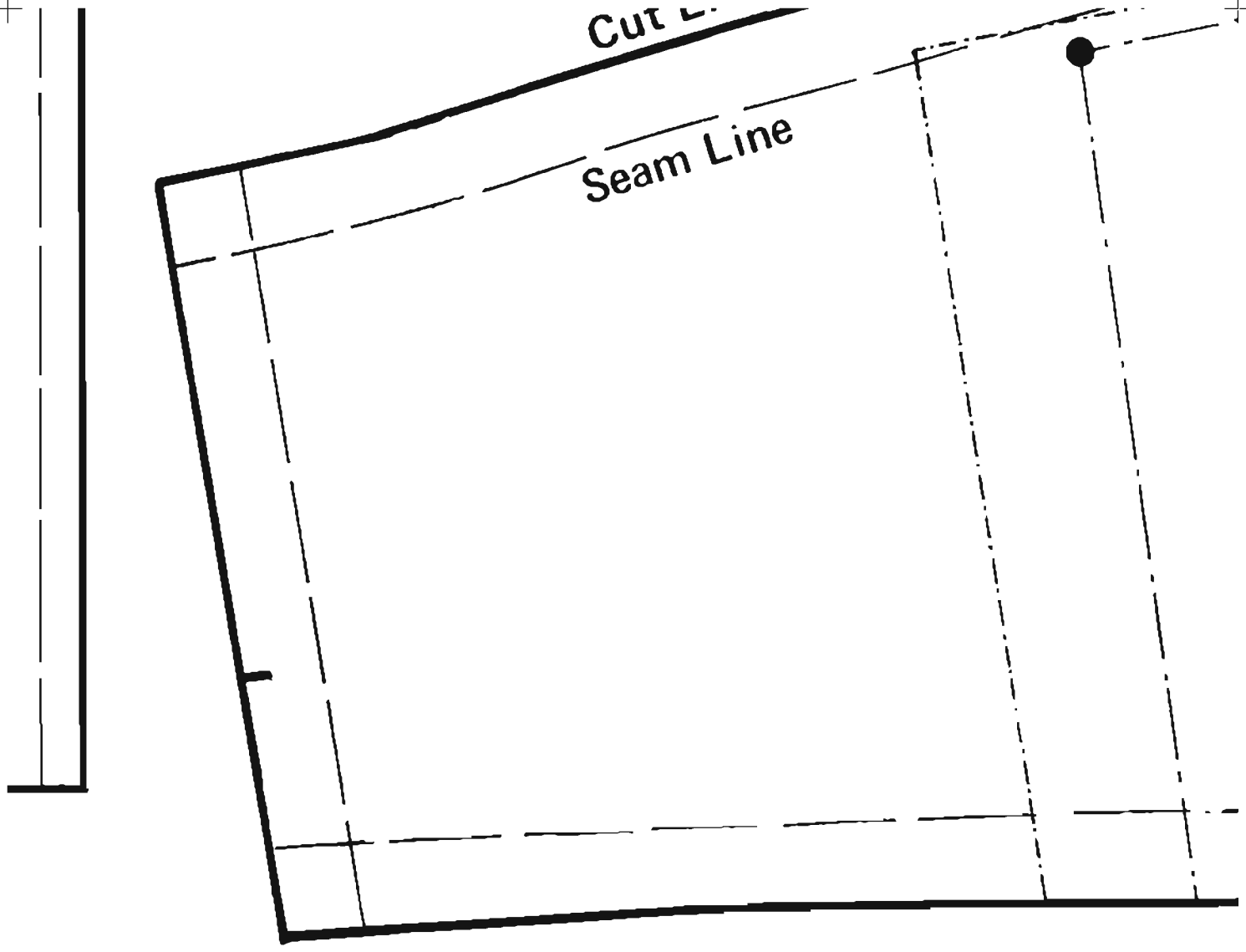

Pocket Flap Indication

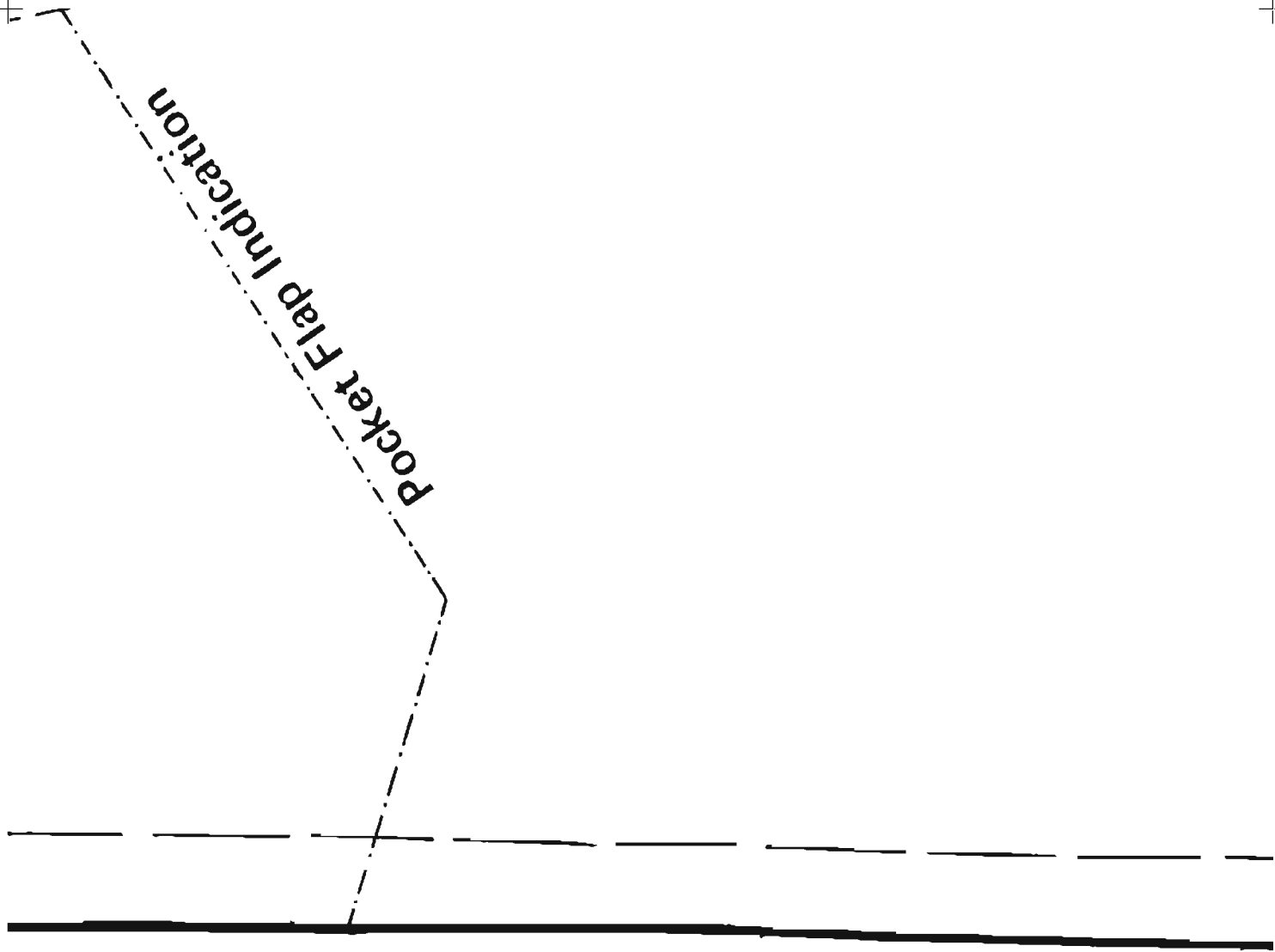

Size 12

Pocket Indication

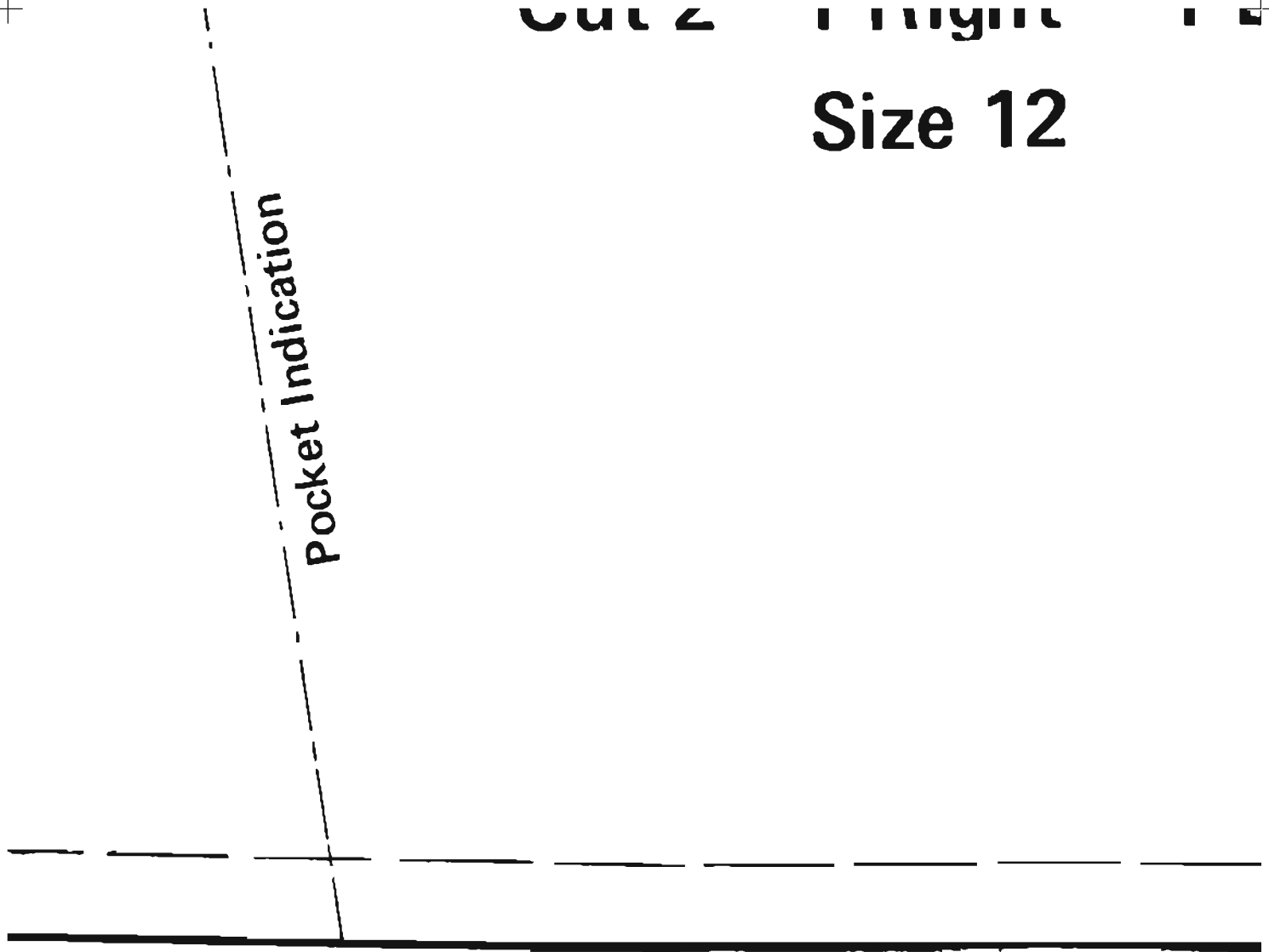

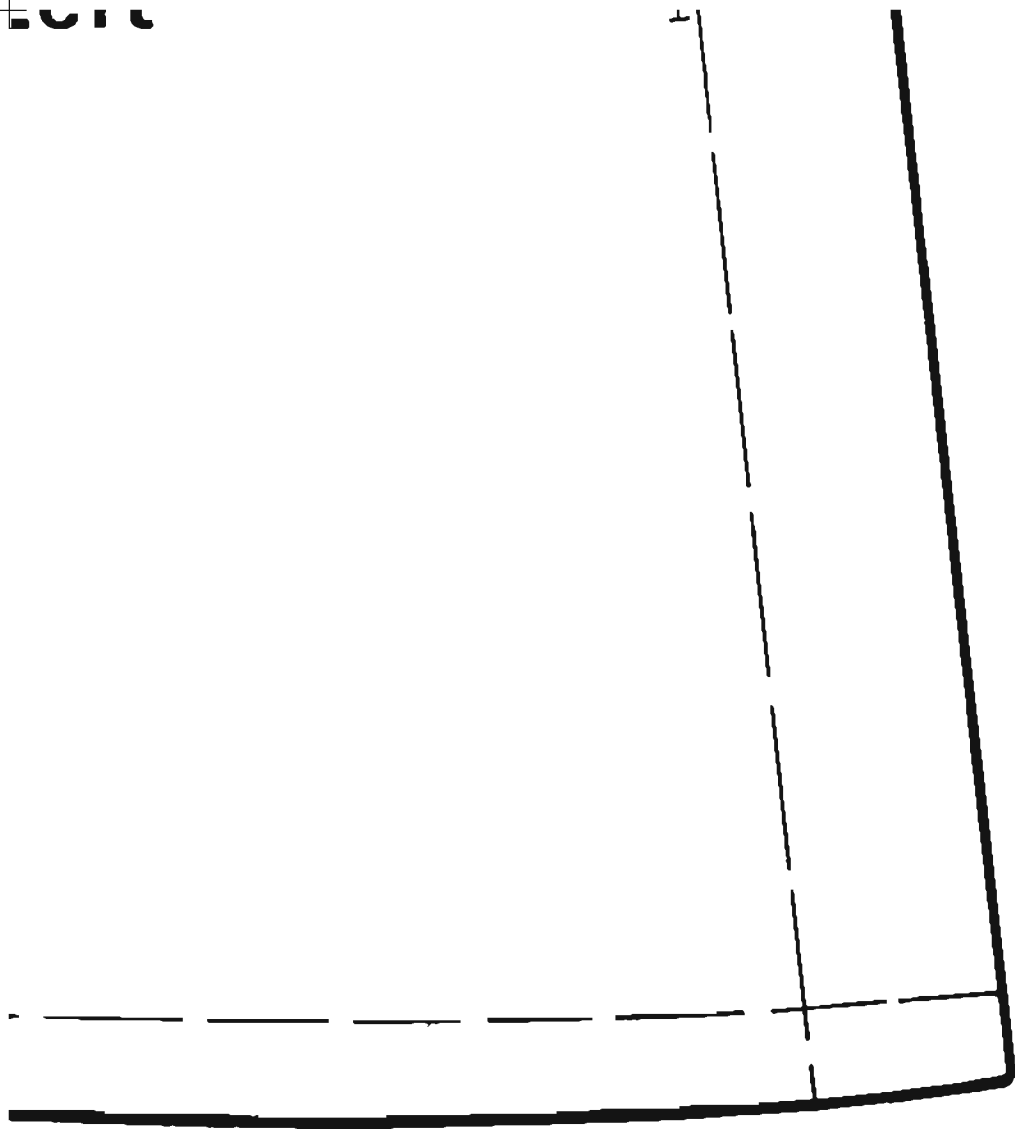

**PATTERN PARTS
LADIES COAT
Size 12**

BOTTOM CENTER BACK
Cut 1
Size 12

HEM LINE

Seam Line

Cut Line

Cut Line

Seam Line

BOTTOM FRONT INTERFACING
Cut 2 1 Right 1 Left
Size 12

Cut Line

UNDER COLLAR

Cut 2 1 Right 1 Left

Cut 2 Interfacing 1 Right 1 Left

Size 12

TOP SIDE FRONT
Cut 2 1 Right 1 Left
Size 12

Seam Line

Cut Line

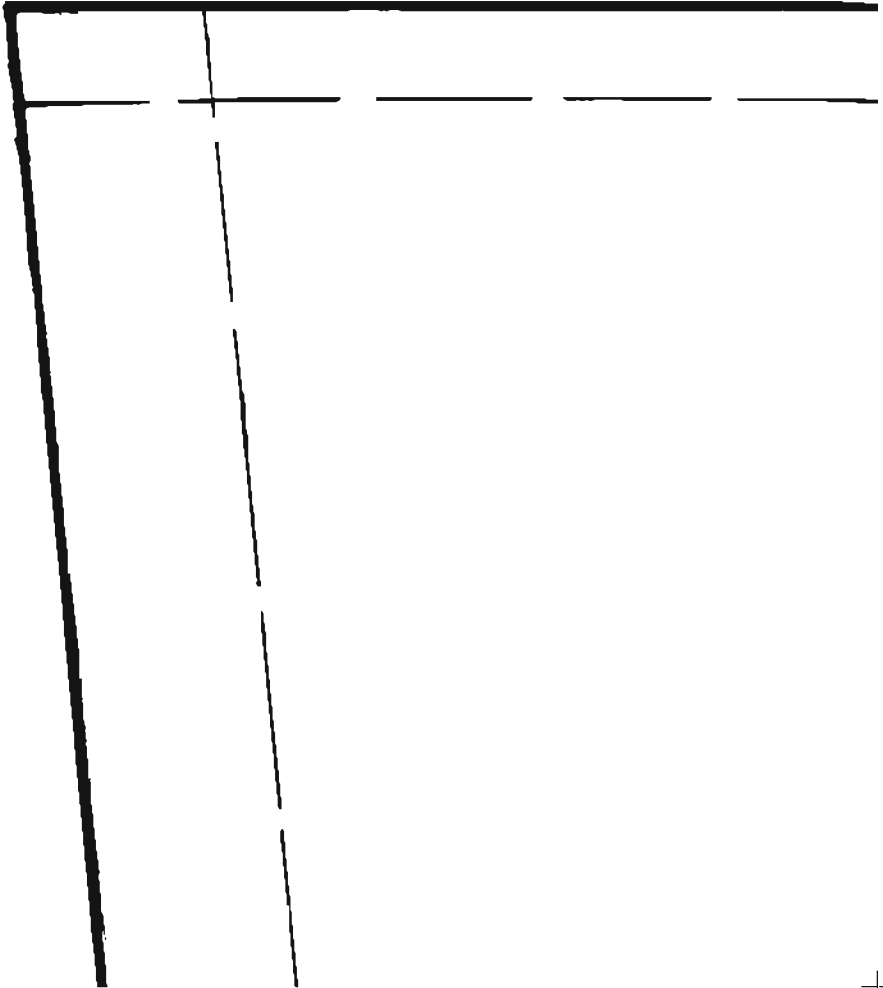

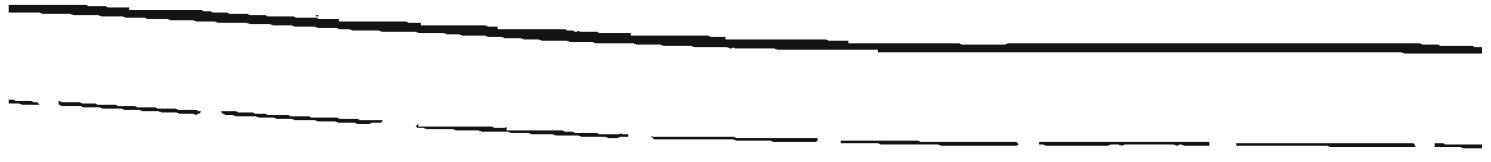

BOTTOM CENTER BACK

Cut 1

0 10

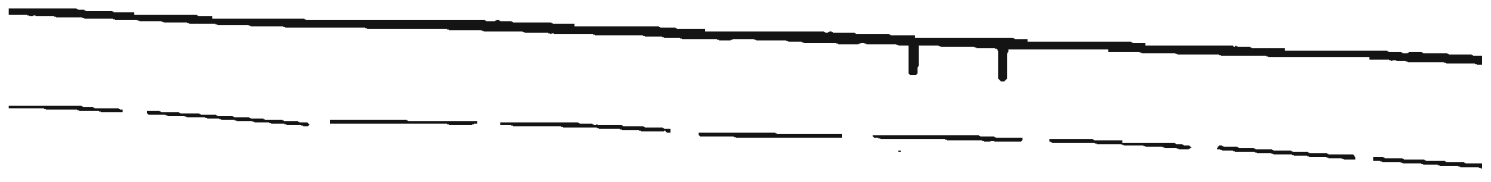

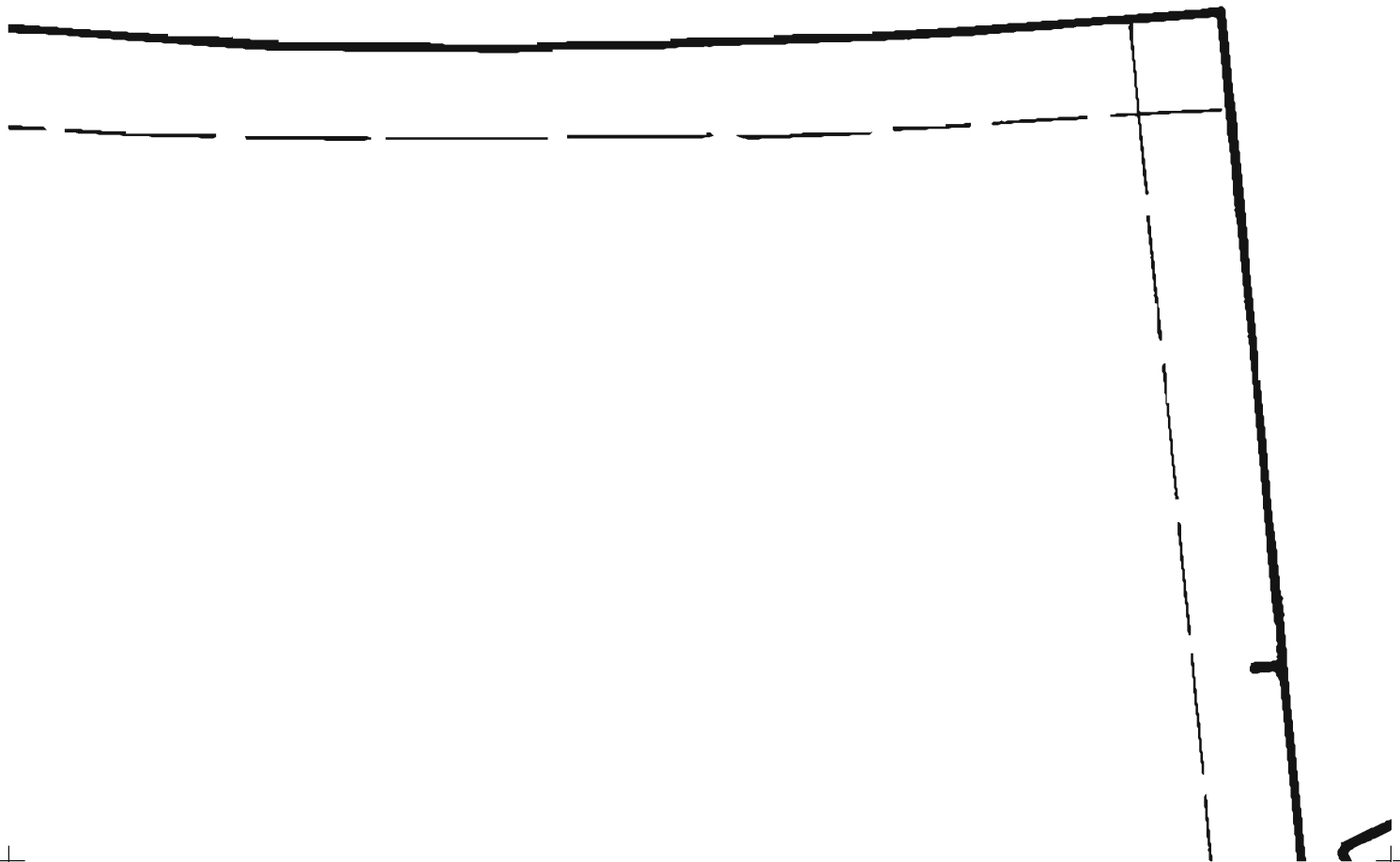

PATTERN PARTS
LADIES COAT
Size 12

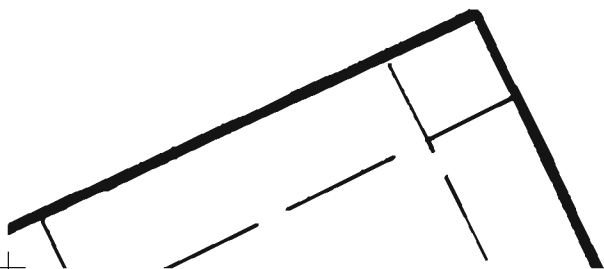



HEM LINE

The image shows a technical drawing of a hemmed fabric edge. A thick solid line represents the outer edge of the fabric. A dashed line, labeled 'HEM LINE', represents the edge of the hemmed portion. The hem is shown as a rectangular strip of fabric folded over the edge. The drawing is oriented vertically on the page.

Size 12

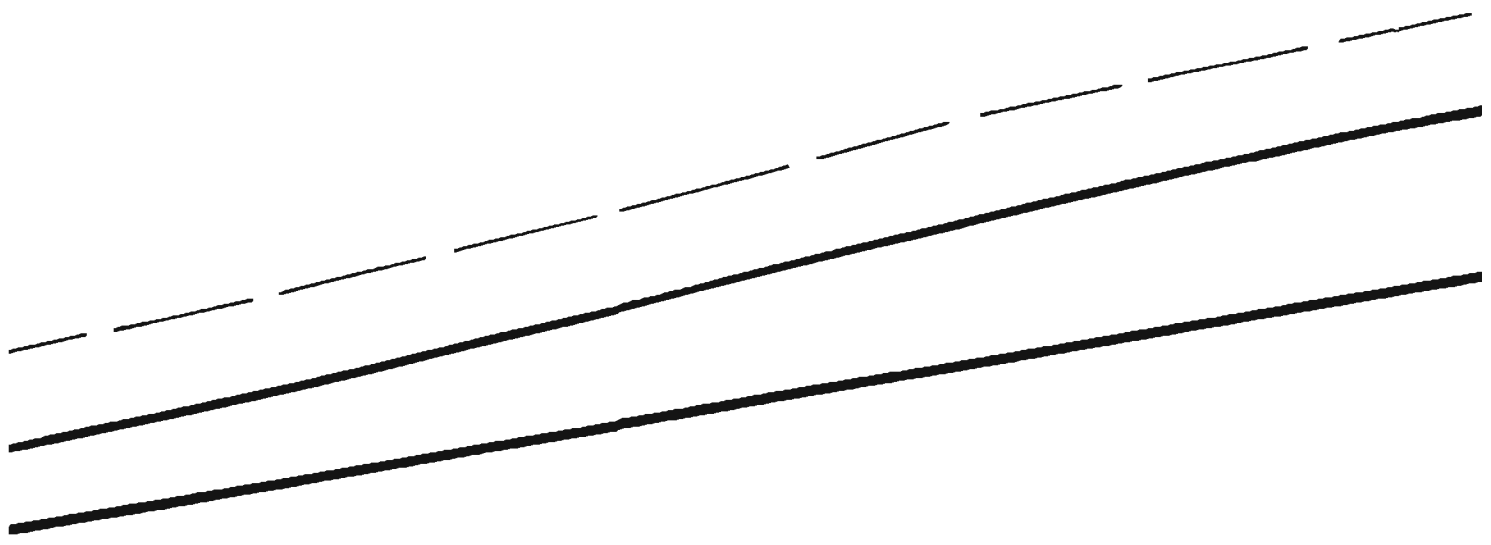

BOTTOM FRONT INTER

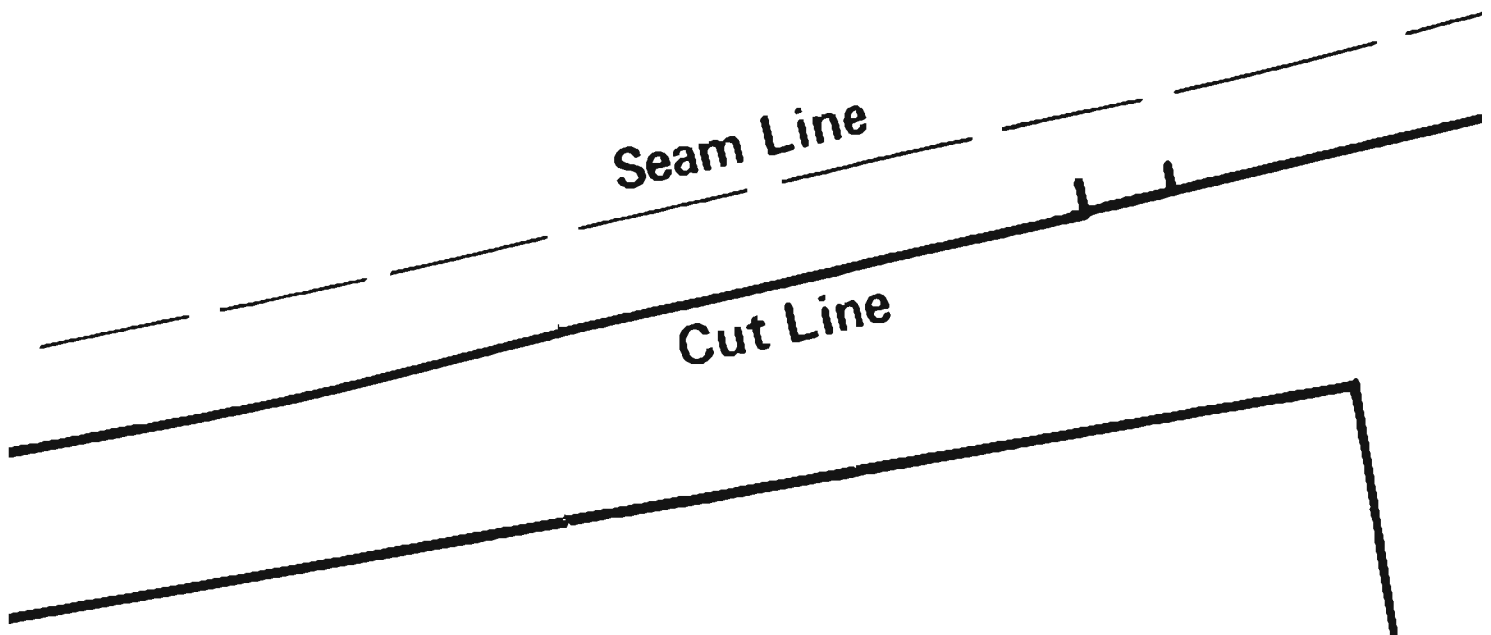

The diagram shows a trapezoidal shape representing a piece of fabric. It features three main lines: a top dashed line labeled 'Seam Line', a middle solid line labeled 'Cut Line', and a bottom solid line. The 'Cut Line' has two small vertical tick marks on its right side. The lines are slightly curved, suggesting a pattern for a curved garment part.

Seam Line

Cut Line

RFACING

Left

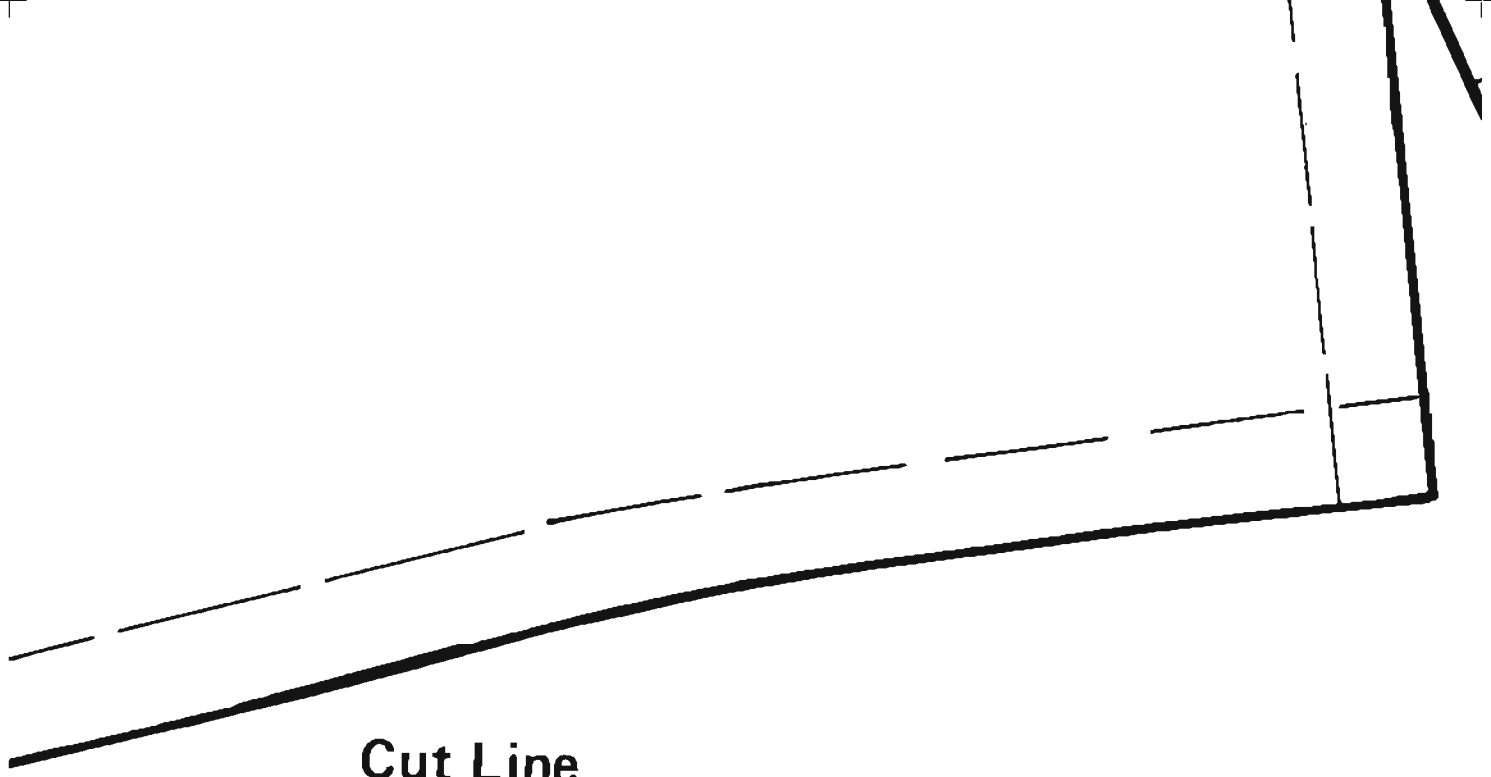

Cut Line

Seam Line

SEWER COLLAR

1 Right 1 Left

acing 1 Right 1 Left

Size 12

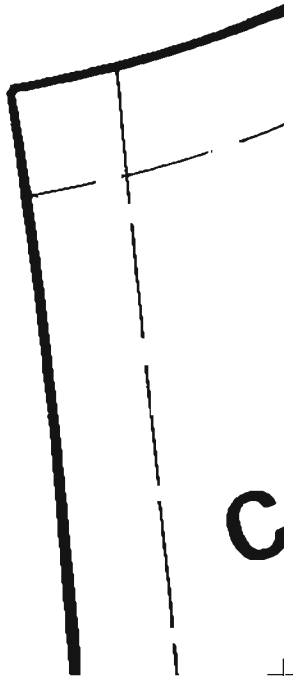

C



TOP SIDE FRONT
cut 2 1 Right 1 Left
Size 12

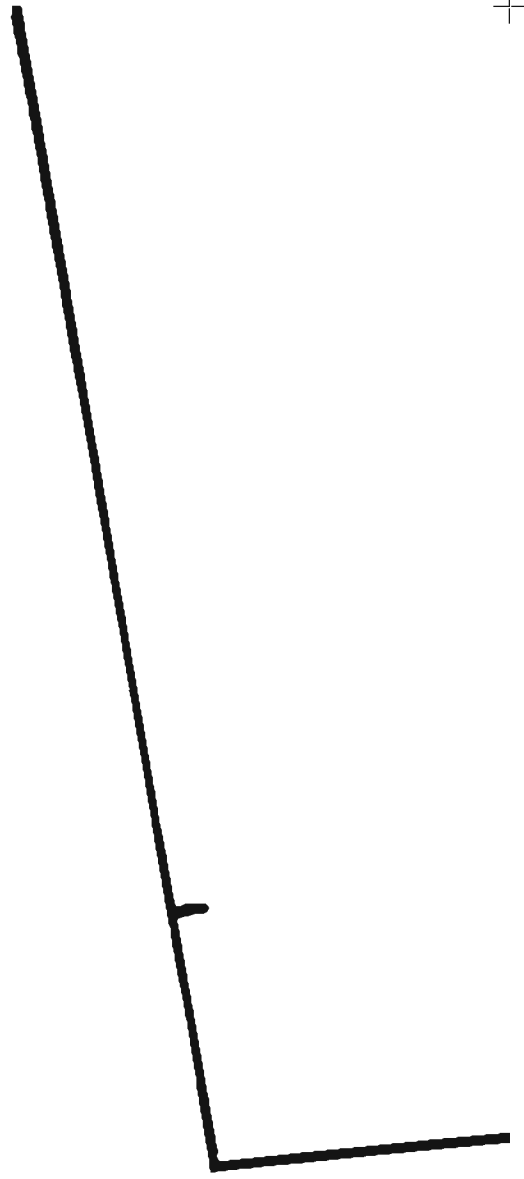

BU I . -

Cut 2

1 Right

Size 12





Cut Line

UNDE

Cut 2

Cut 2 Interface

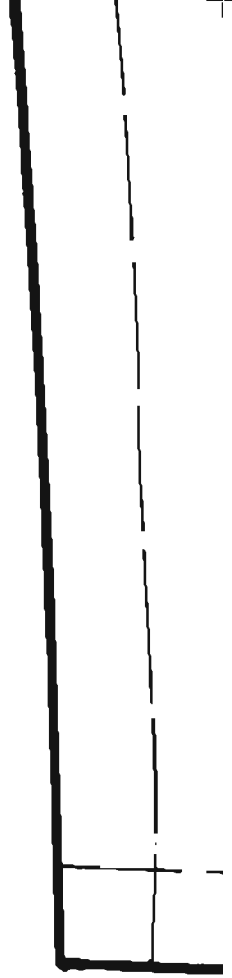
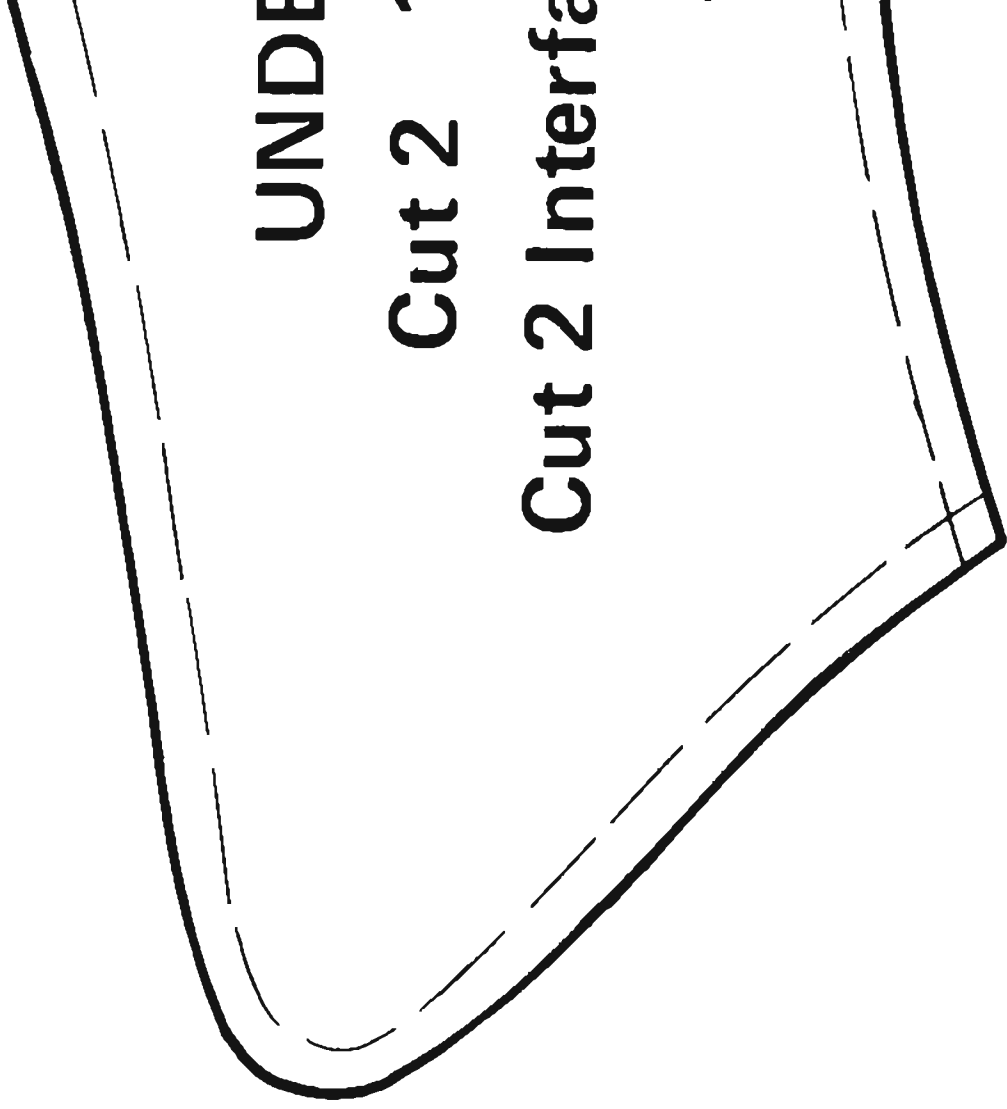

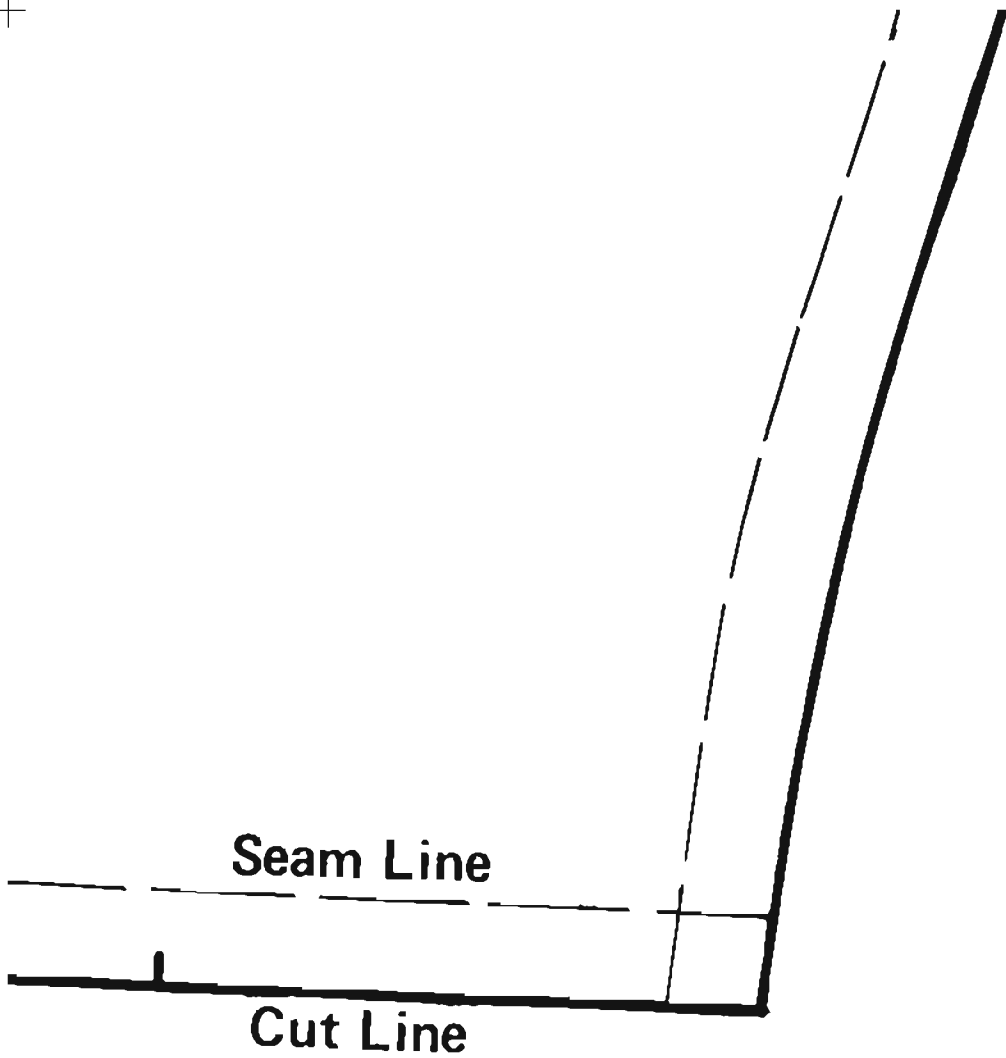

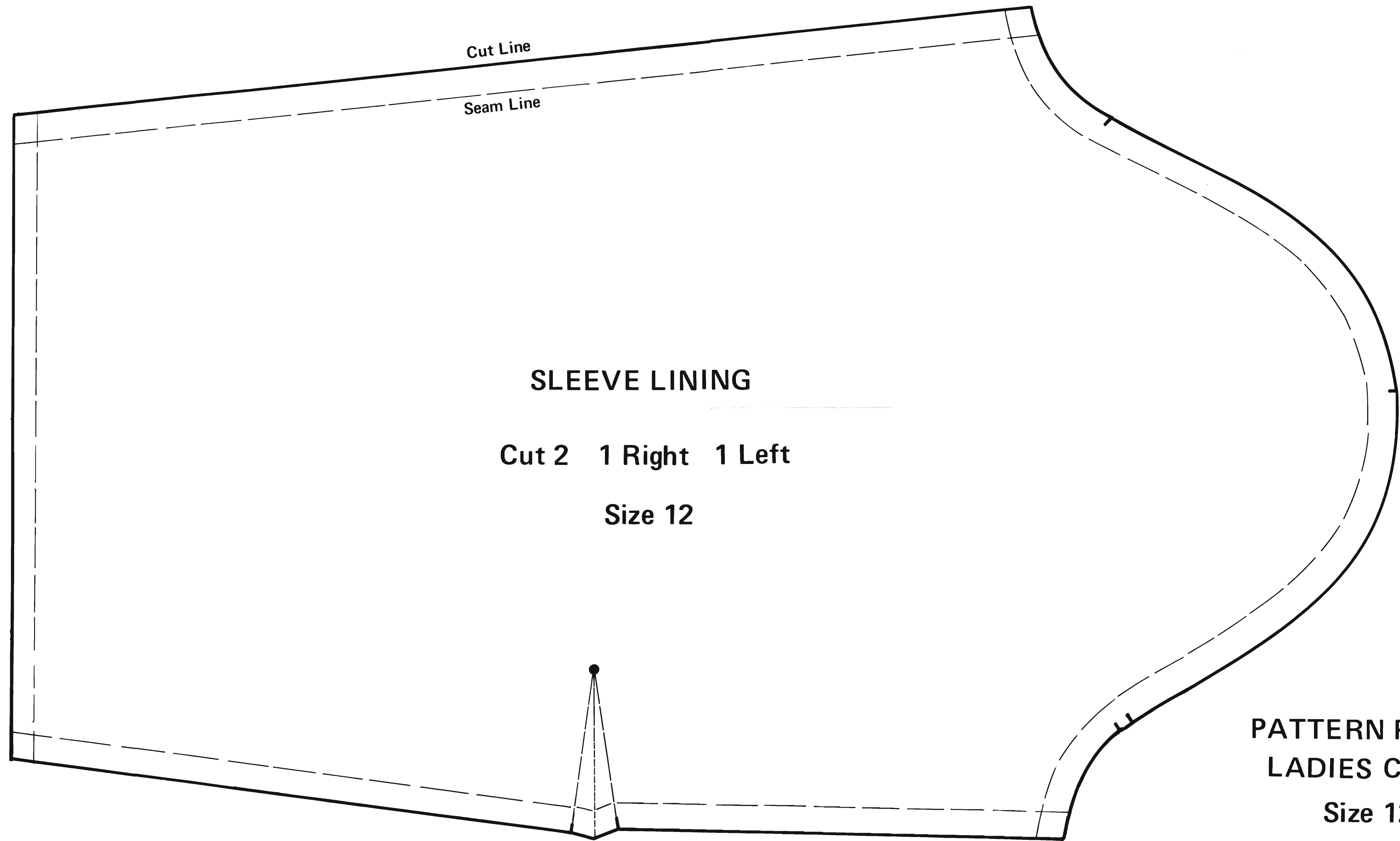

Cut Line

Seam Line

SLEEVE LINING

Cut 2 1 Right 1 Left

Size 12

**PATTERN PARTS
LADIES COAT
Size 12**





Cut Line

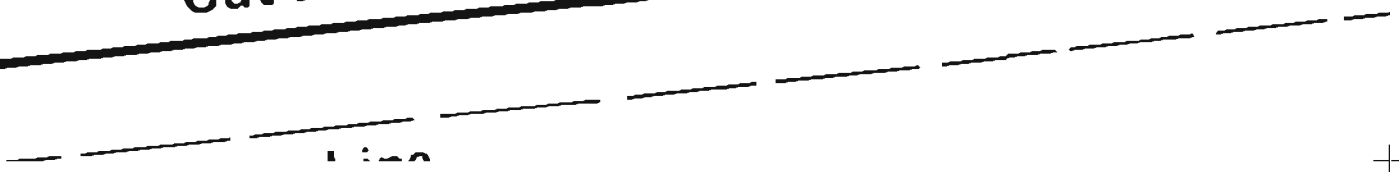

Line

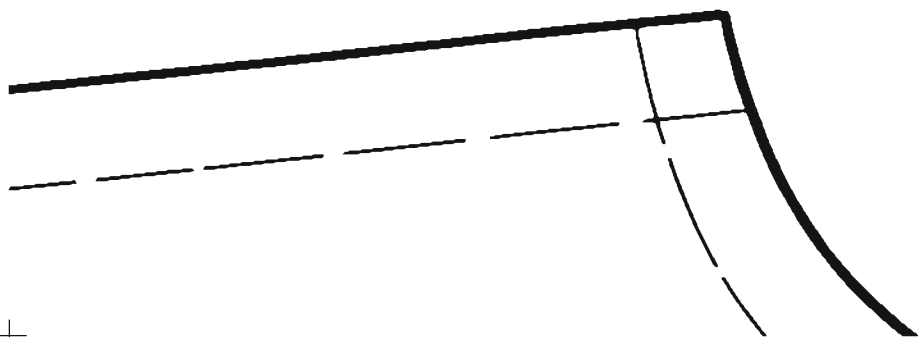





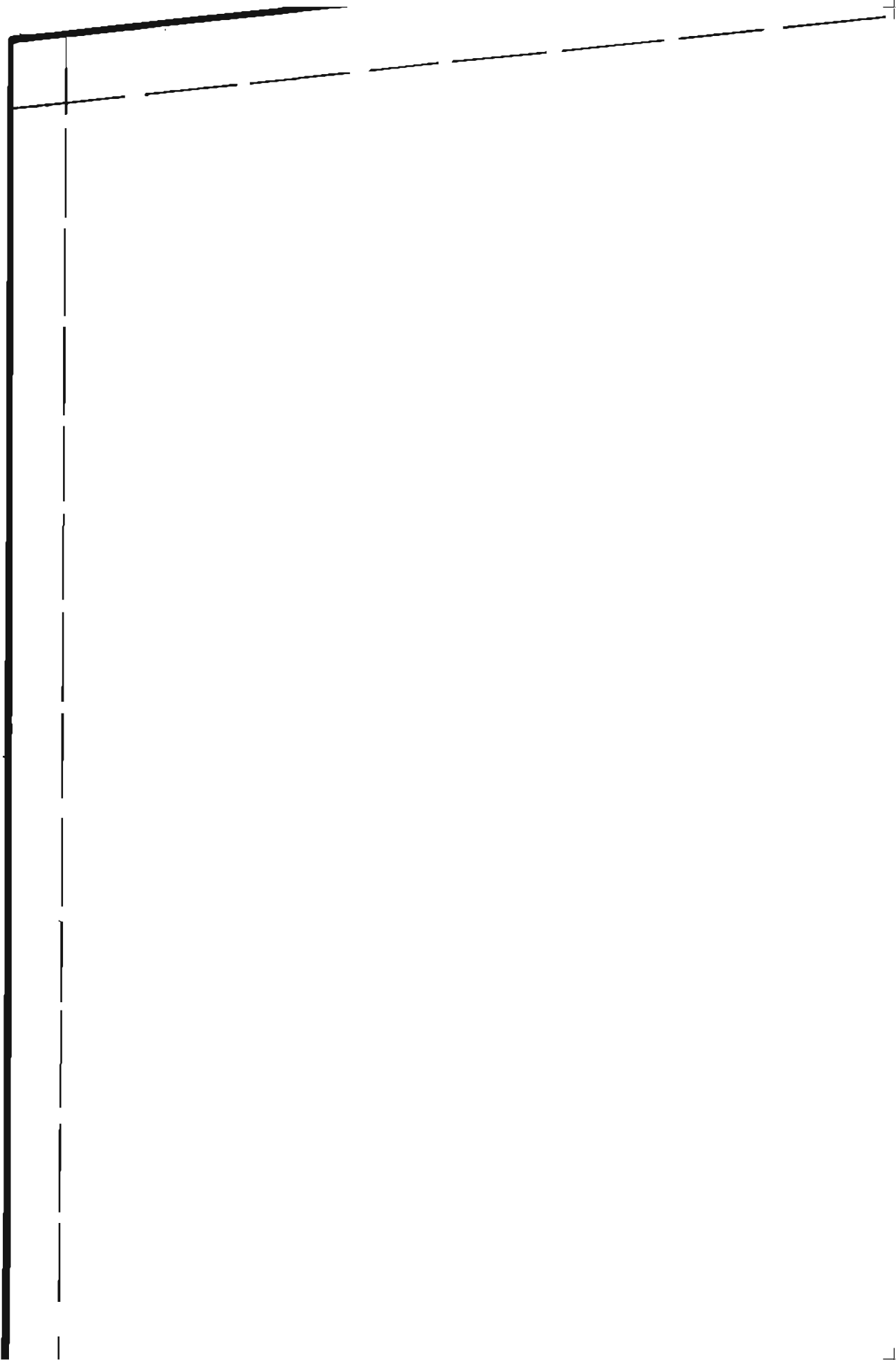

SLEEVE LINING

Cut 2 1 Right 1 Left

Size 12



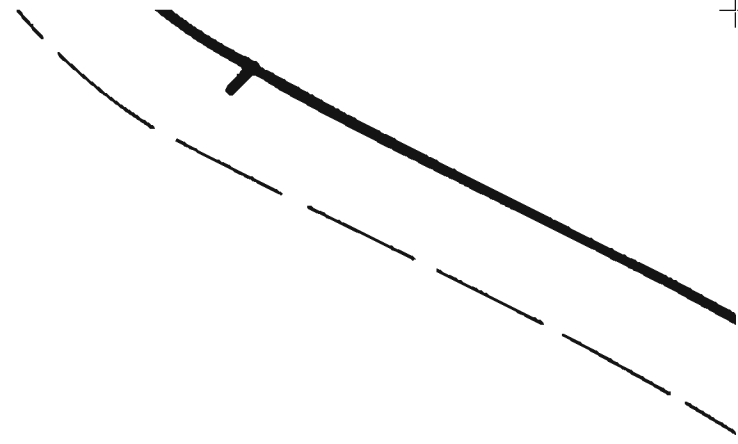

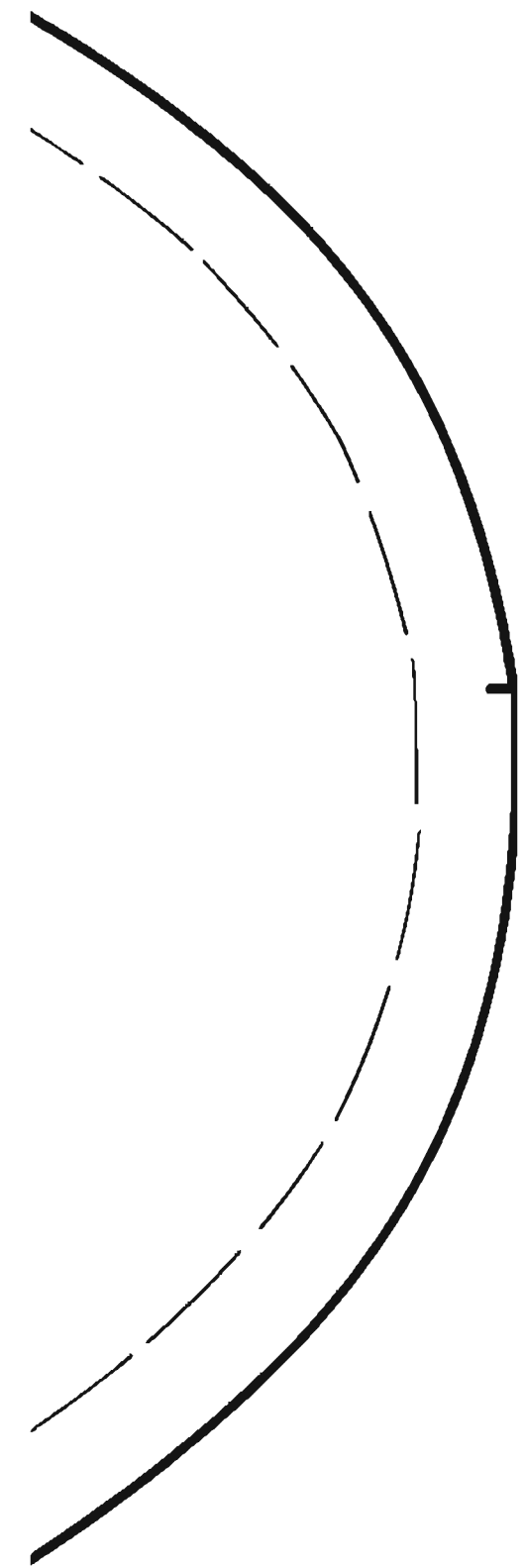



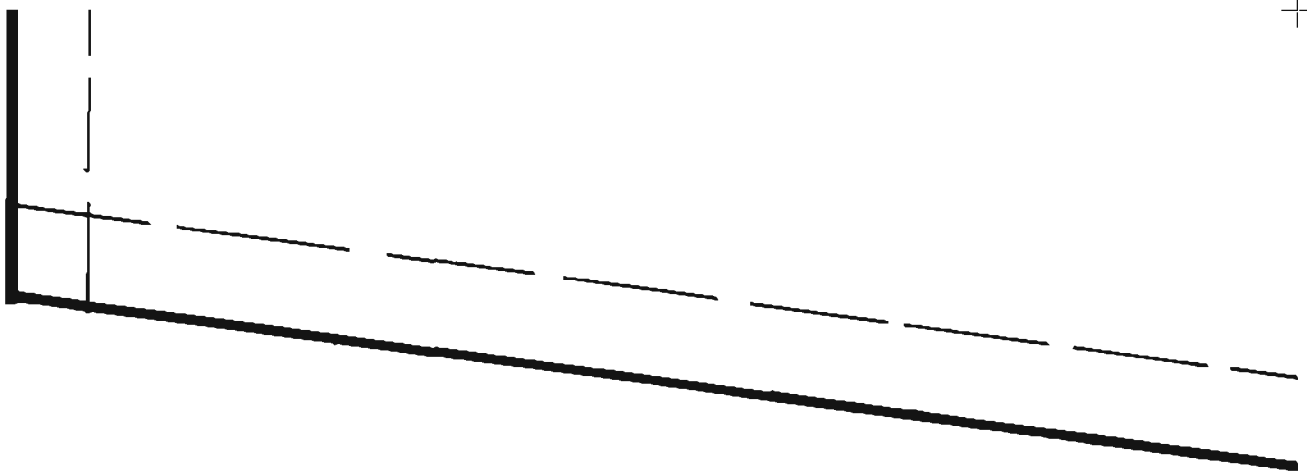

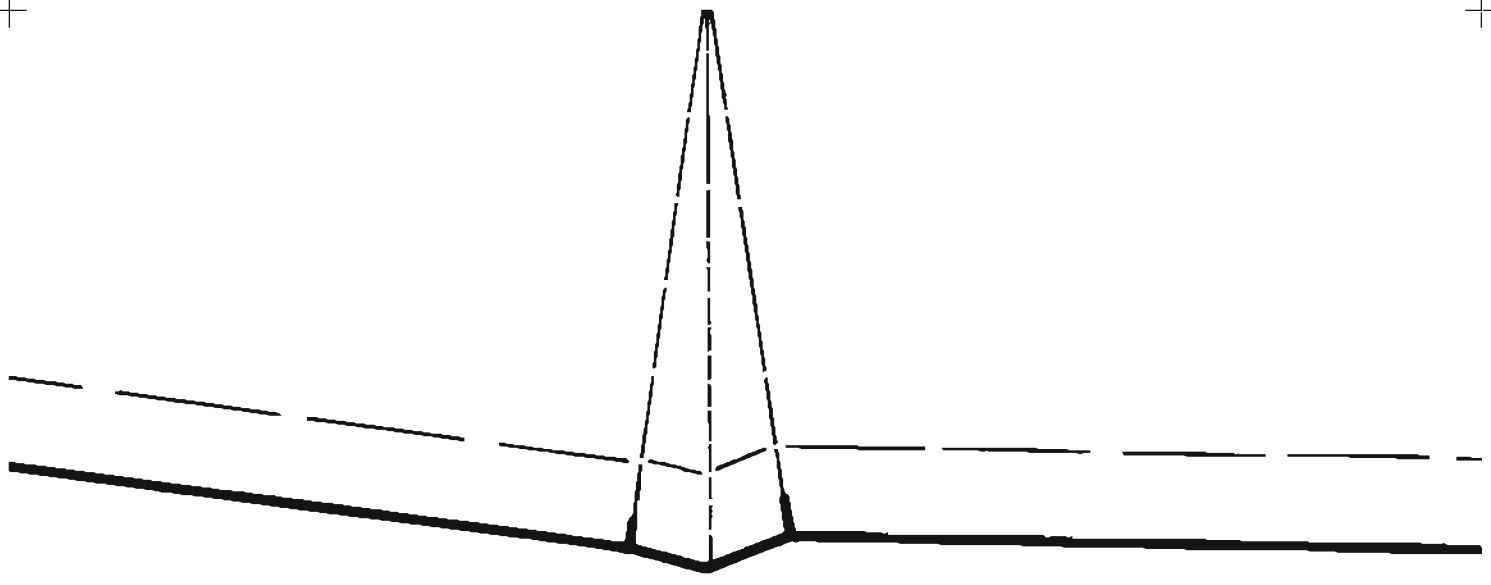

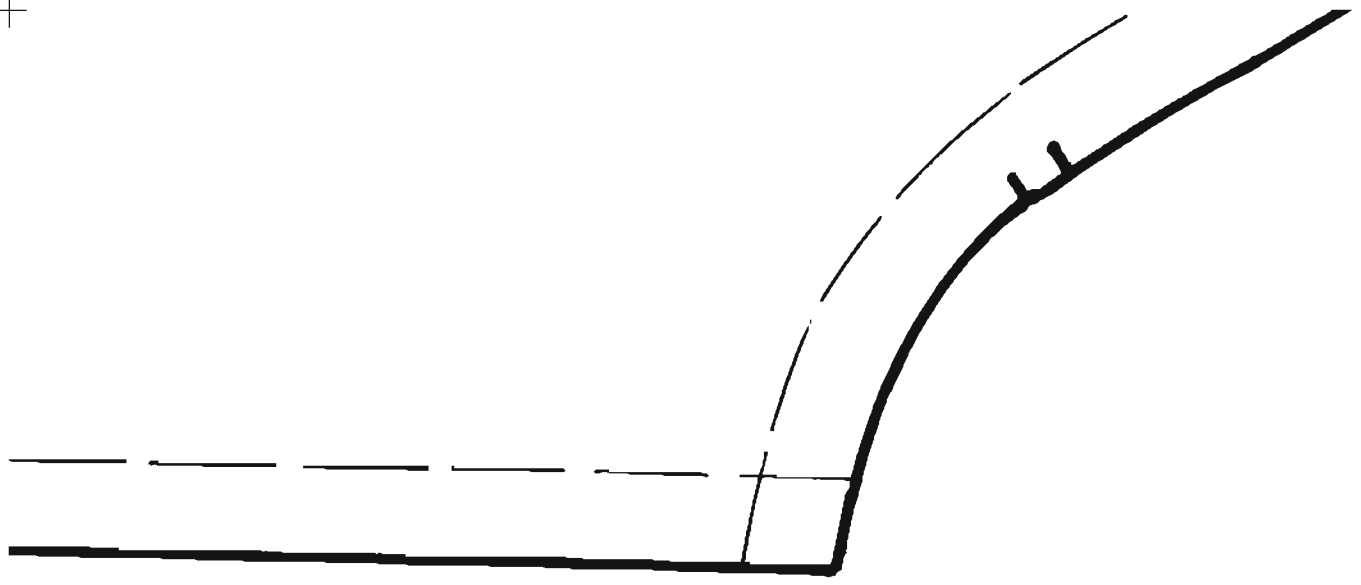

PATTERN PARTS

LADIES COAT

Size 12

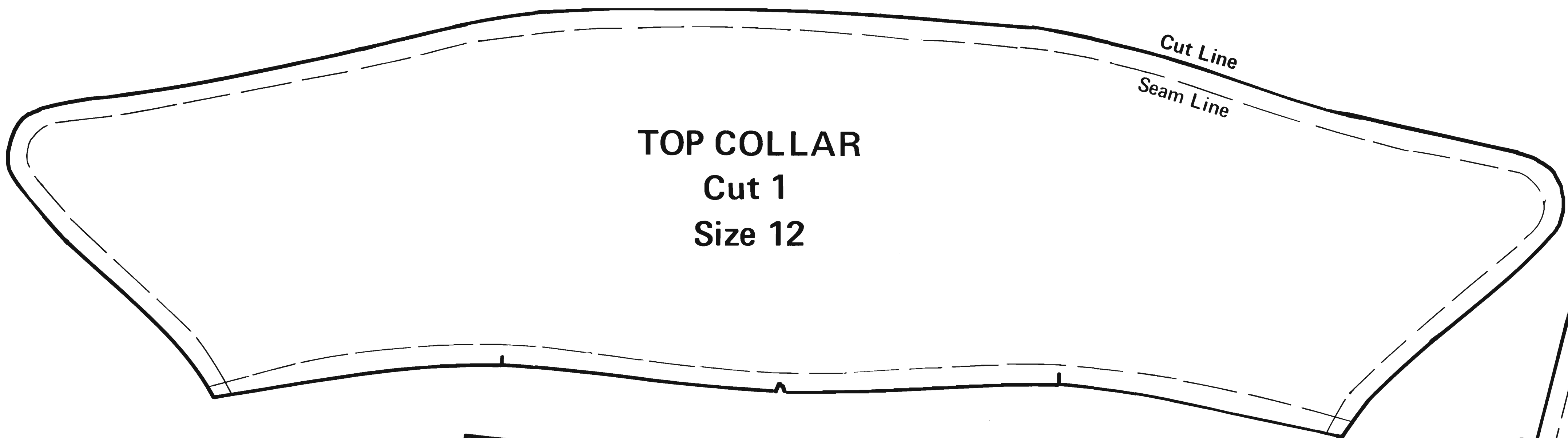

TOP COLLAR
Cut 1
Size 12

Cut Line
Seam Line

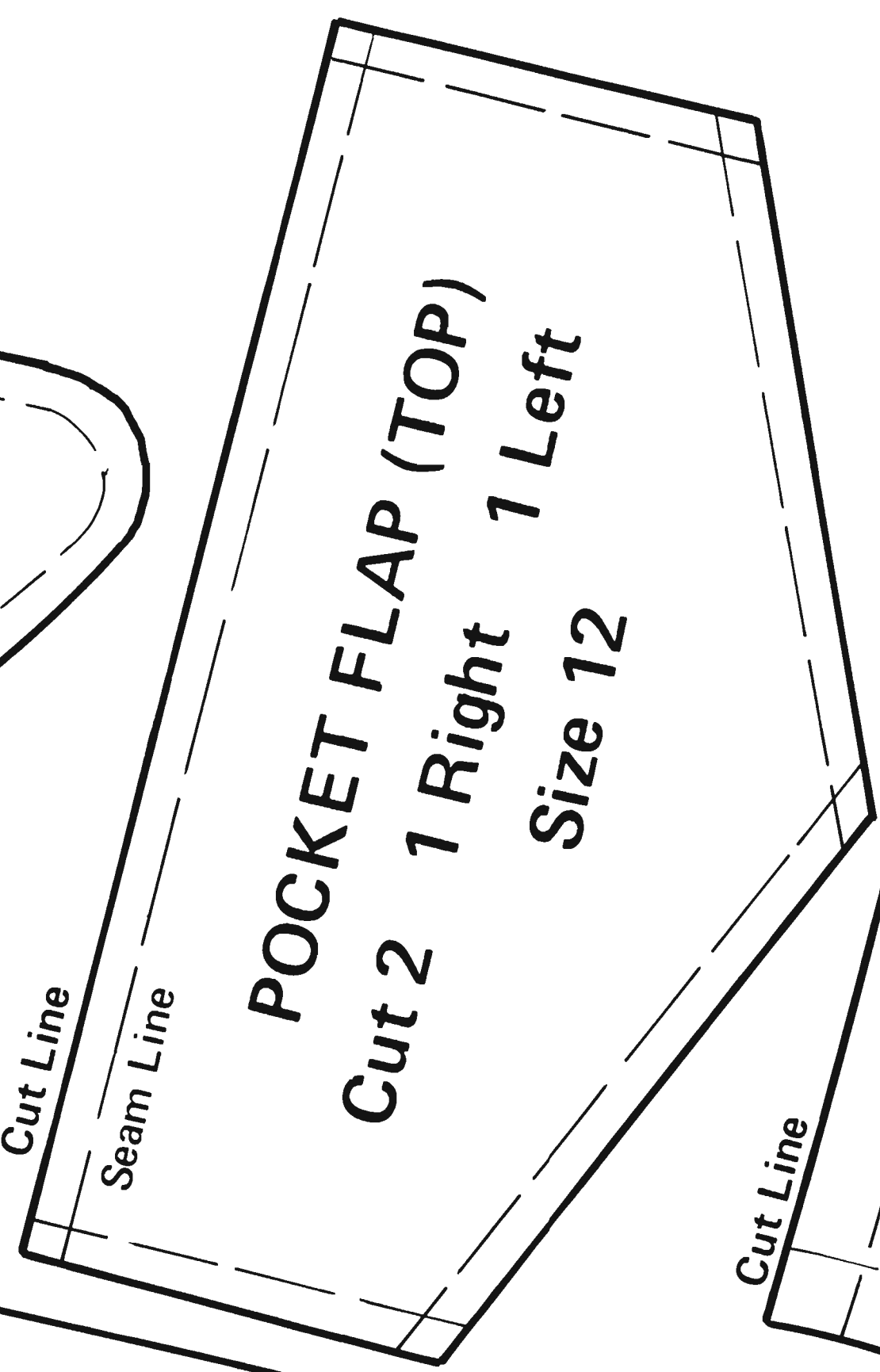

POCKET FLAP (TOP)
Cut 2 1 Right 1 Left
Size 12

Cut Line
Seam Line

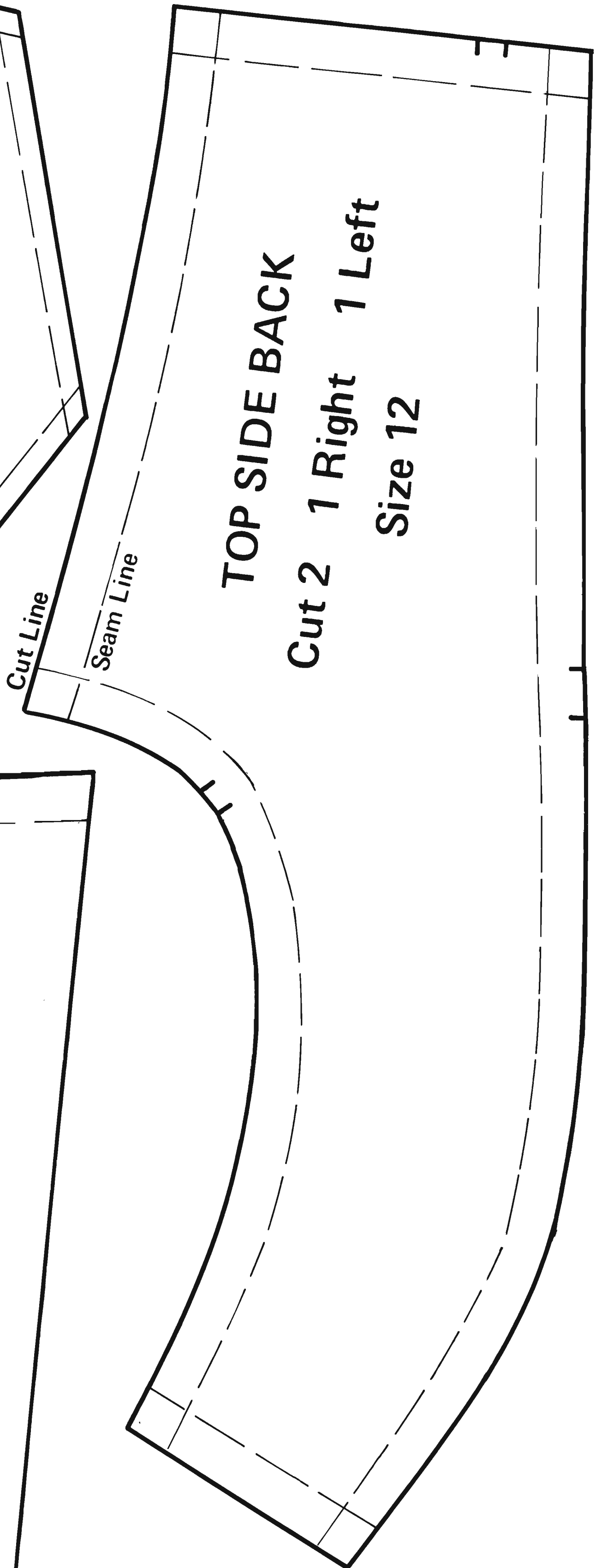

TOP SIDE BACK
Cut 2 1 Right 1 Left
Size 12

Cut Line
Seam Line

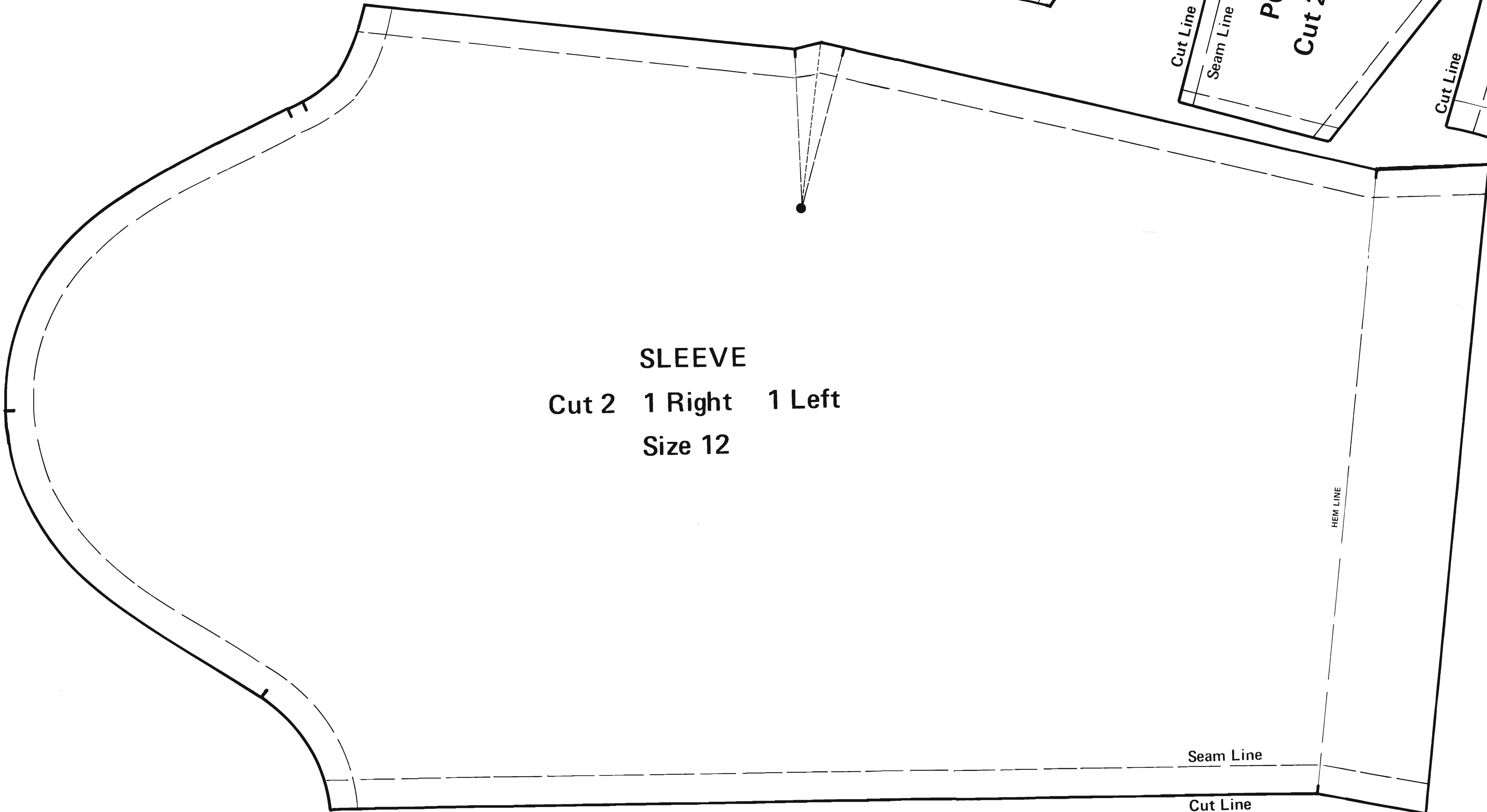

SLEEVE
Cut 2 1 Right 1 Left
Size 12

Seam Line
Cut Line

HEM LINE

PATTERN PARTS
LADIES COAT
Size 12

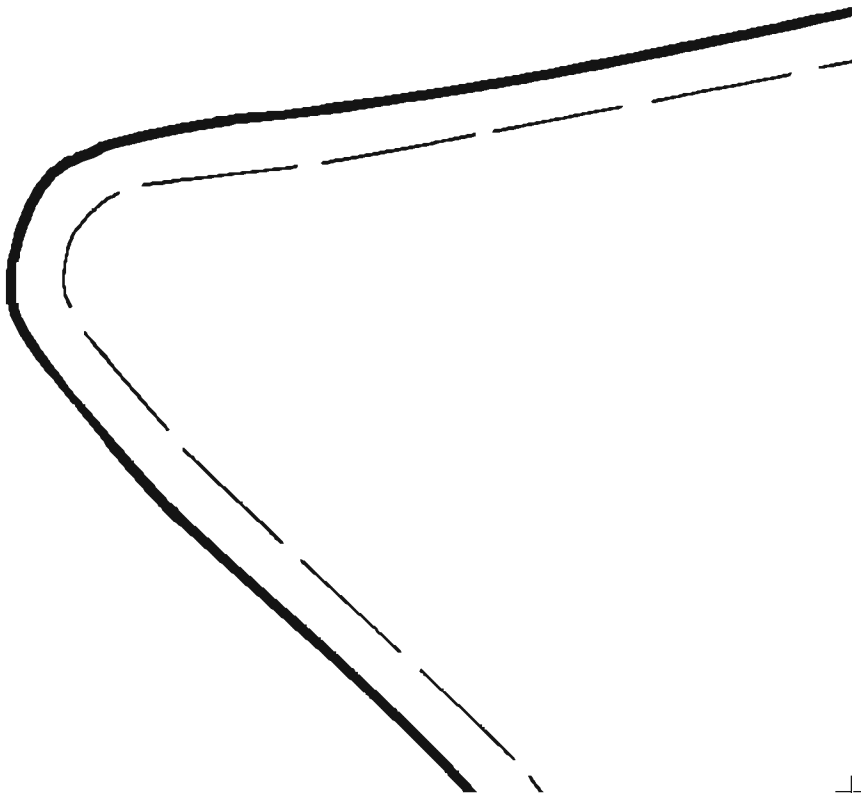

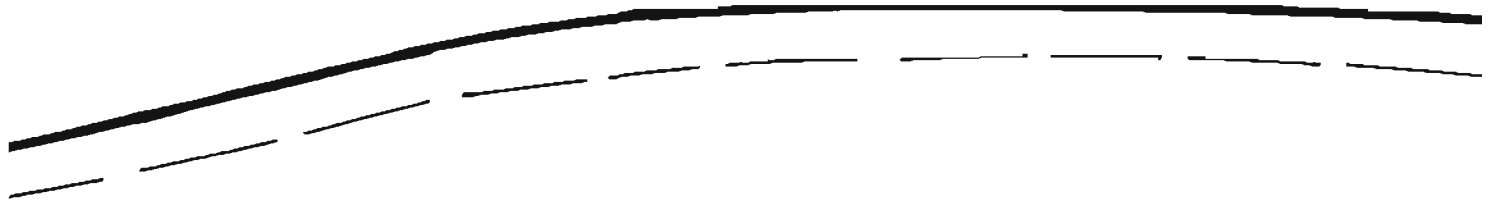

TOP COLLAR

Cut 1

Size 12

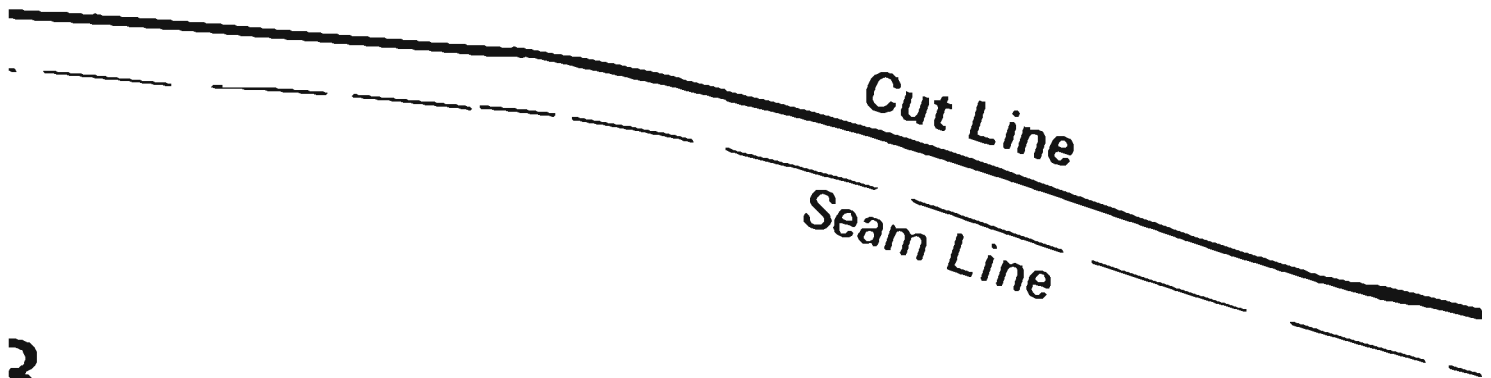

Cut Line

Seam Line

3

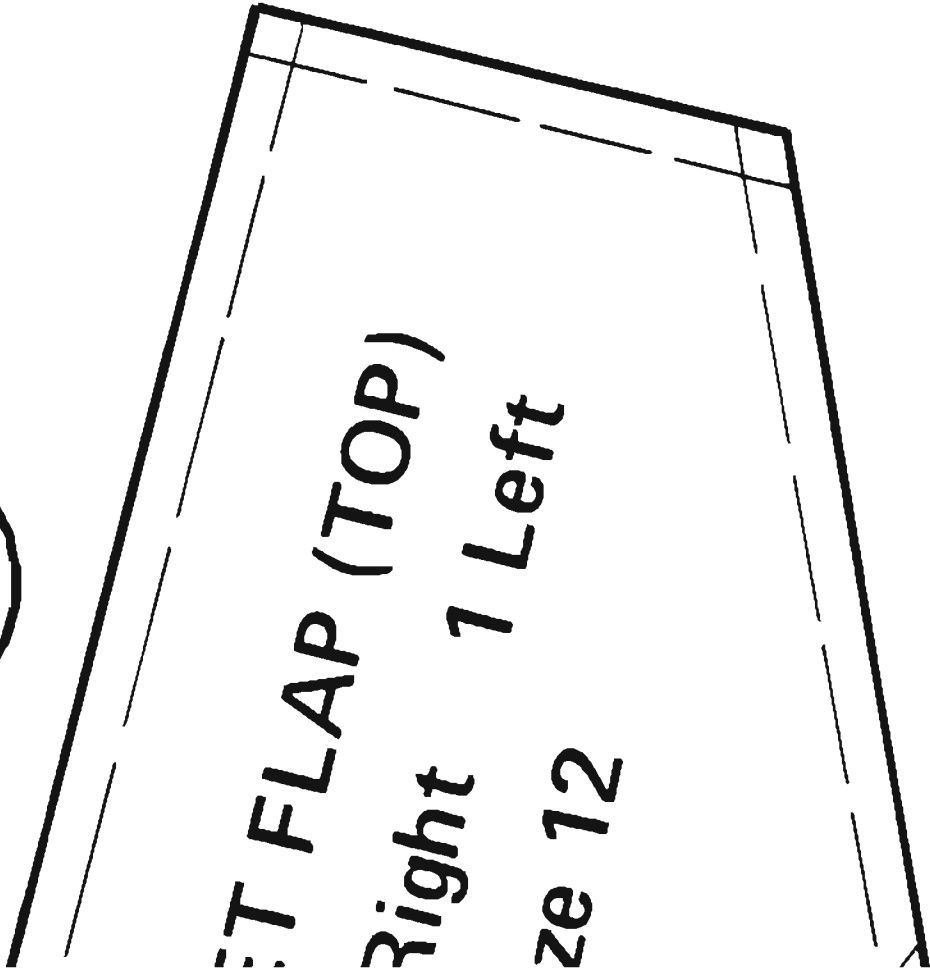
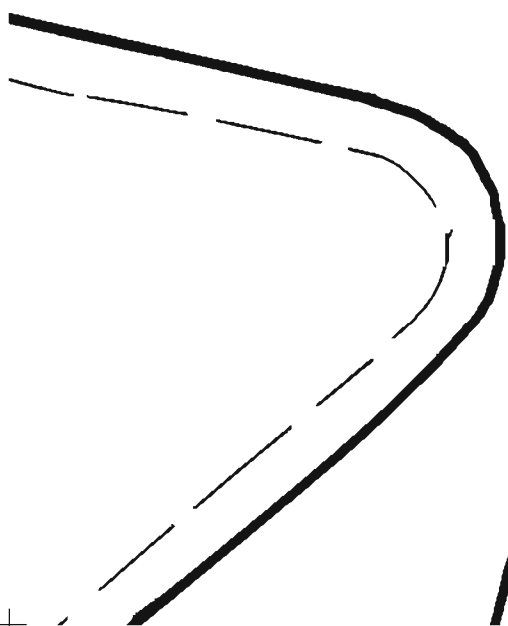

RIGHT FLAP (TOP)

Right 1 Left

ze 12

BACK

1 Left

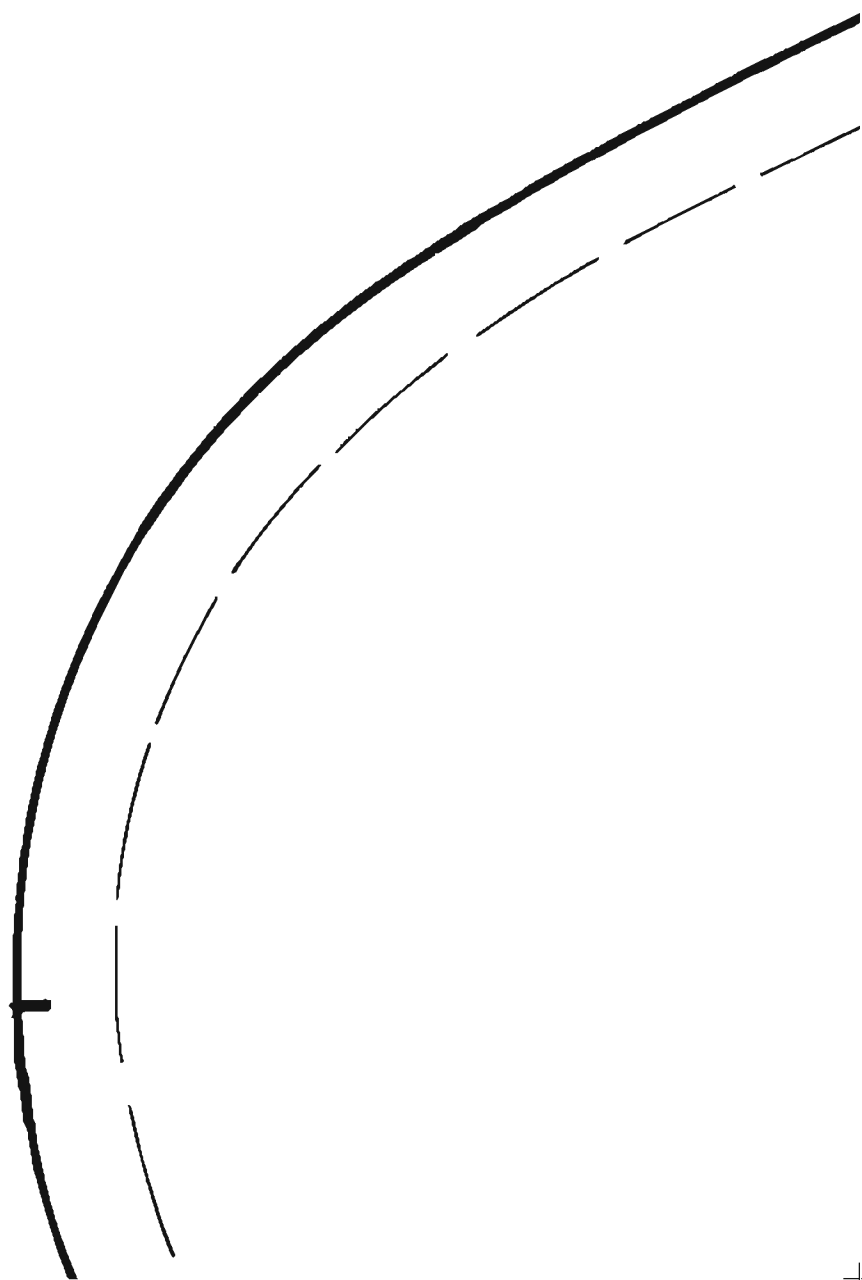
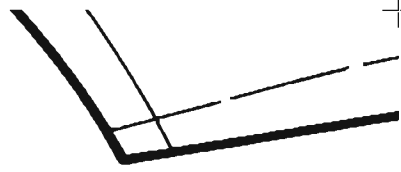

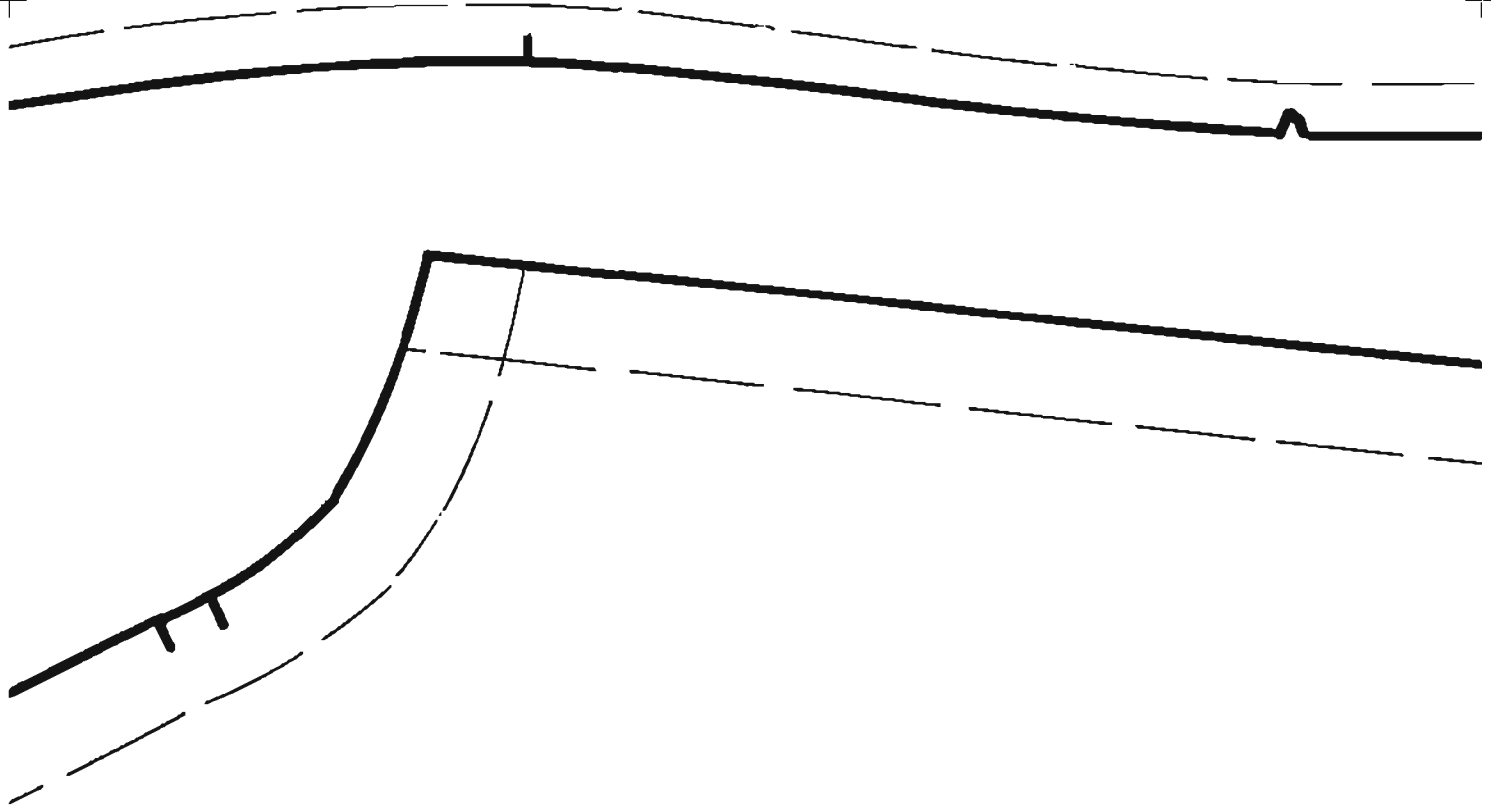

SL
Cut 2 1
Si

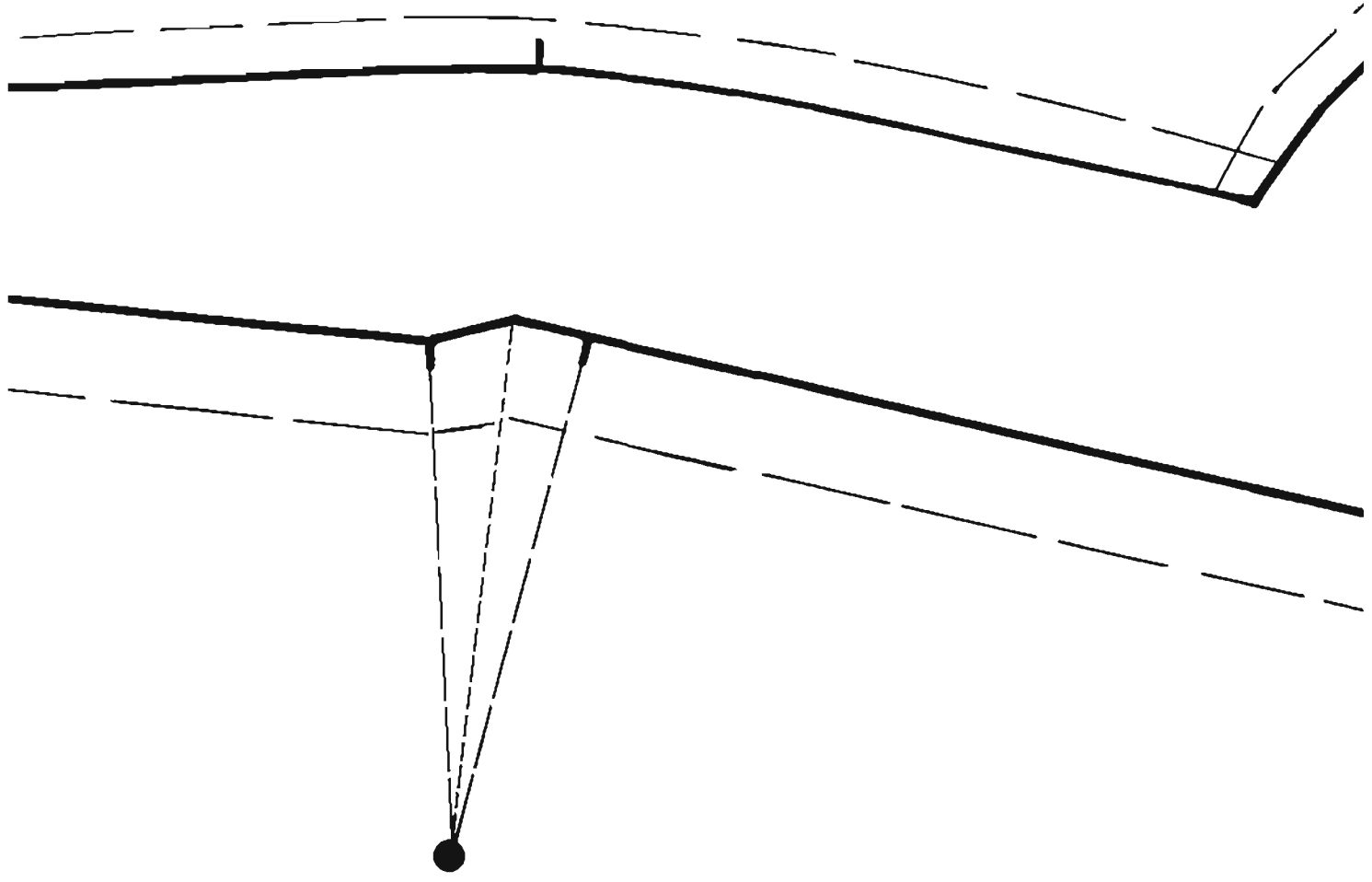

_EEVE

Right 1 Left

ze 12

Cut Line

Seam Line

POCKE

Cut 2 1 F

Si.

Cut Line

Seam r.

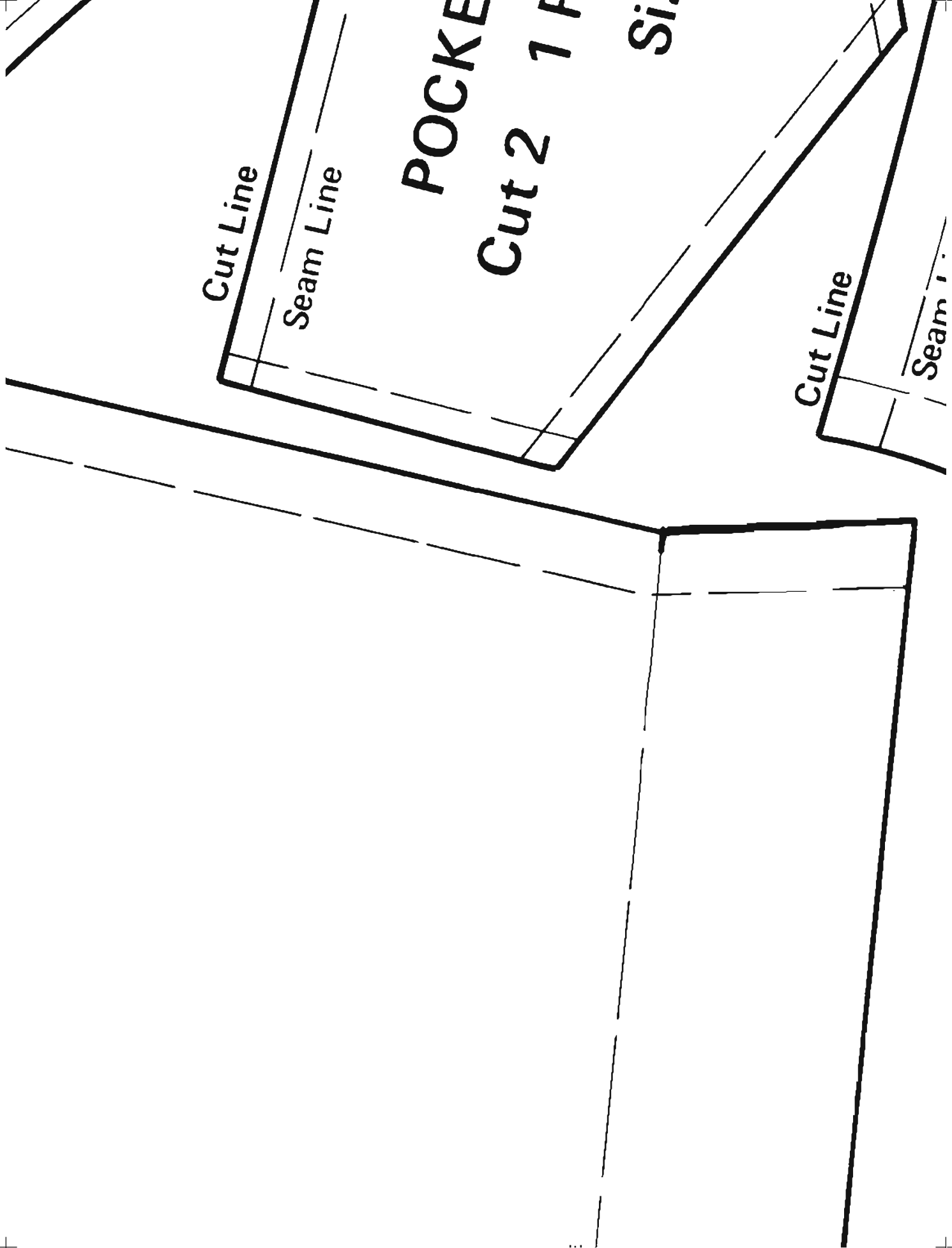

Line

TOP SIDE

Cut 2 1 Right

Size 12

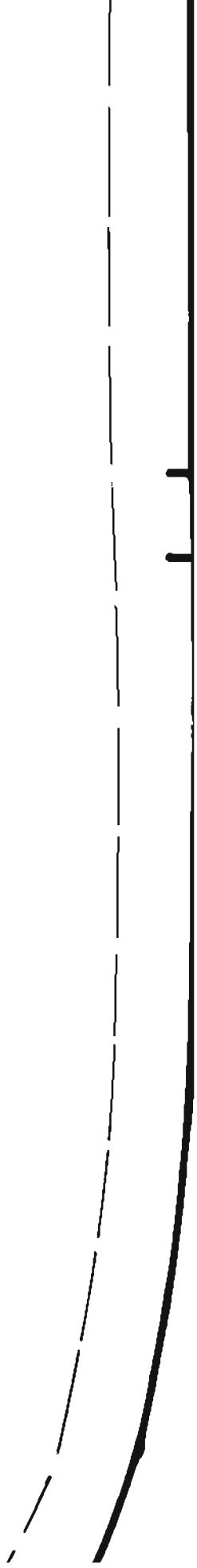
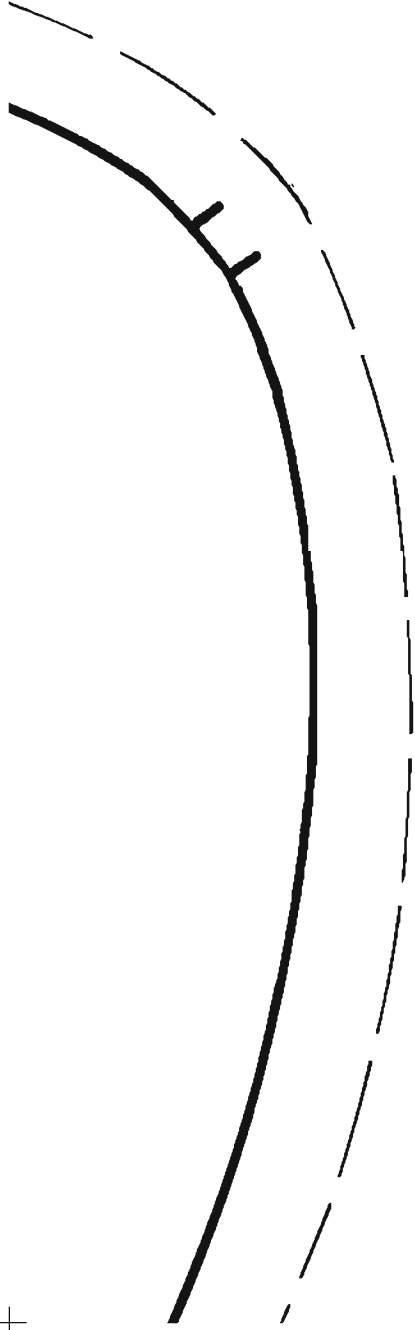

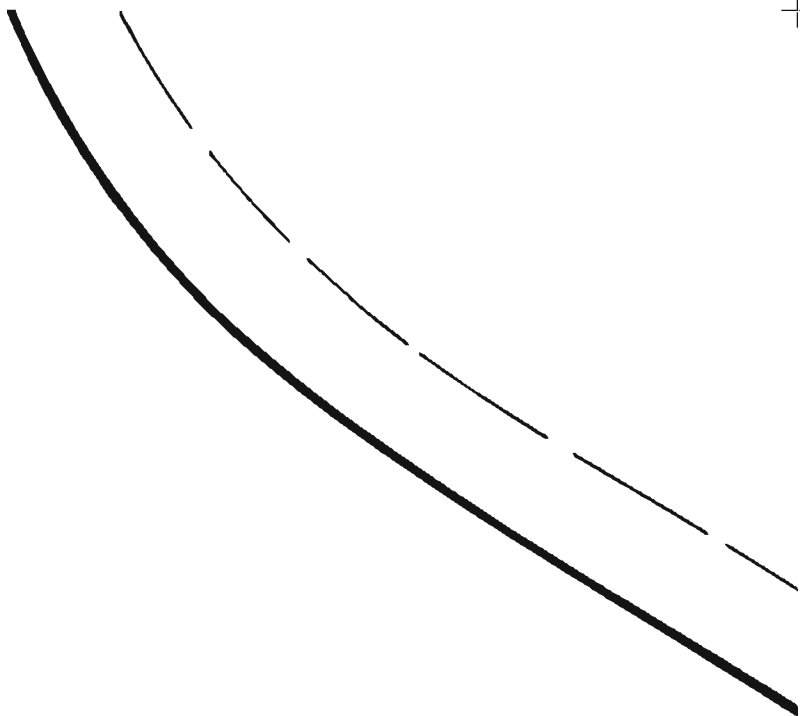



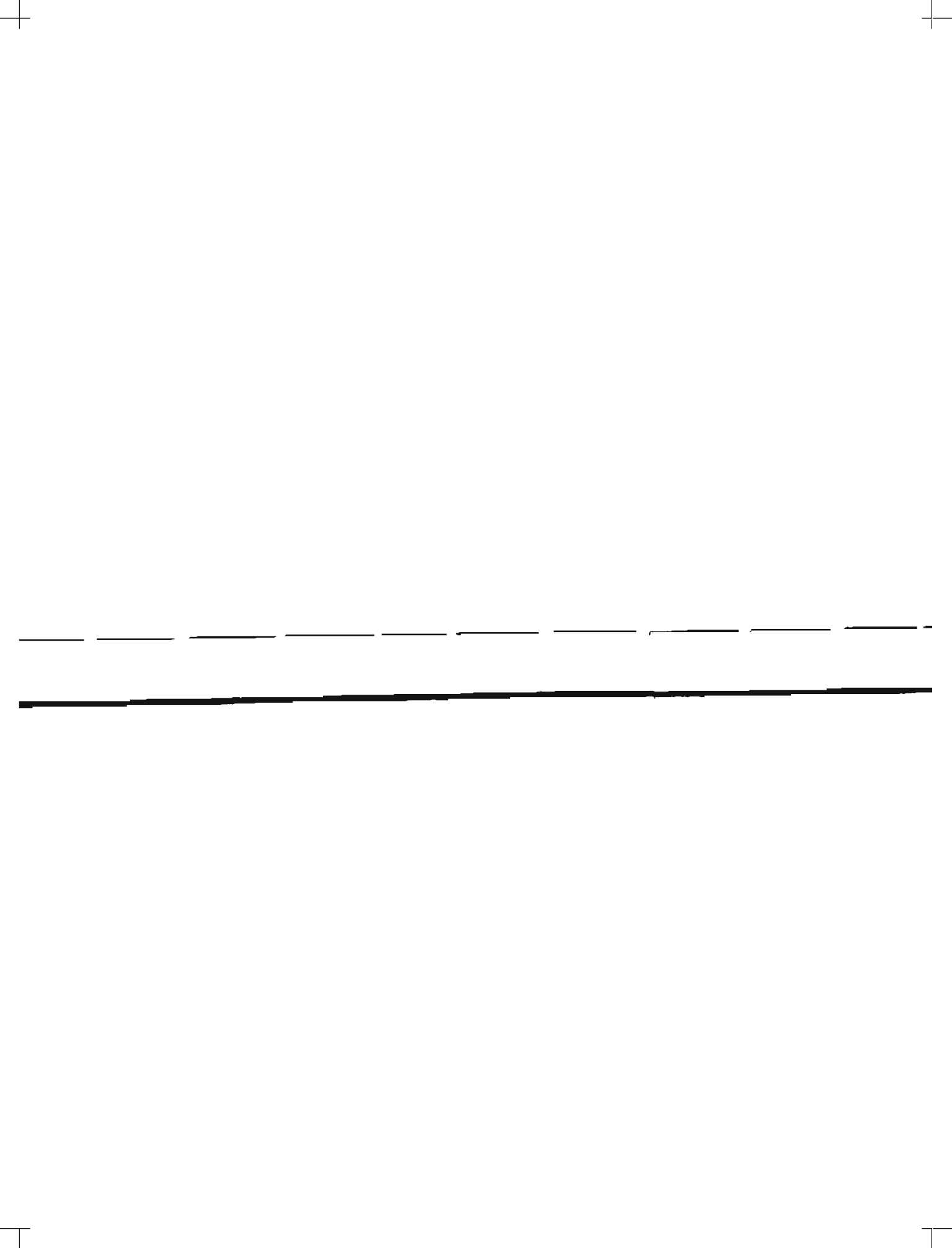

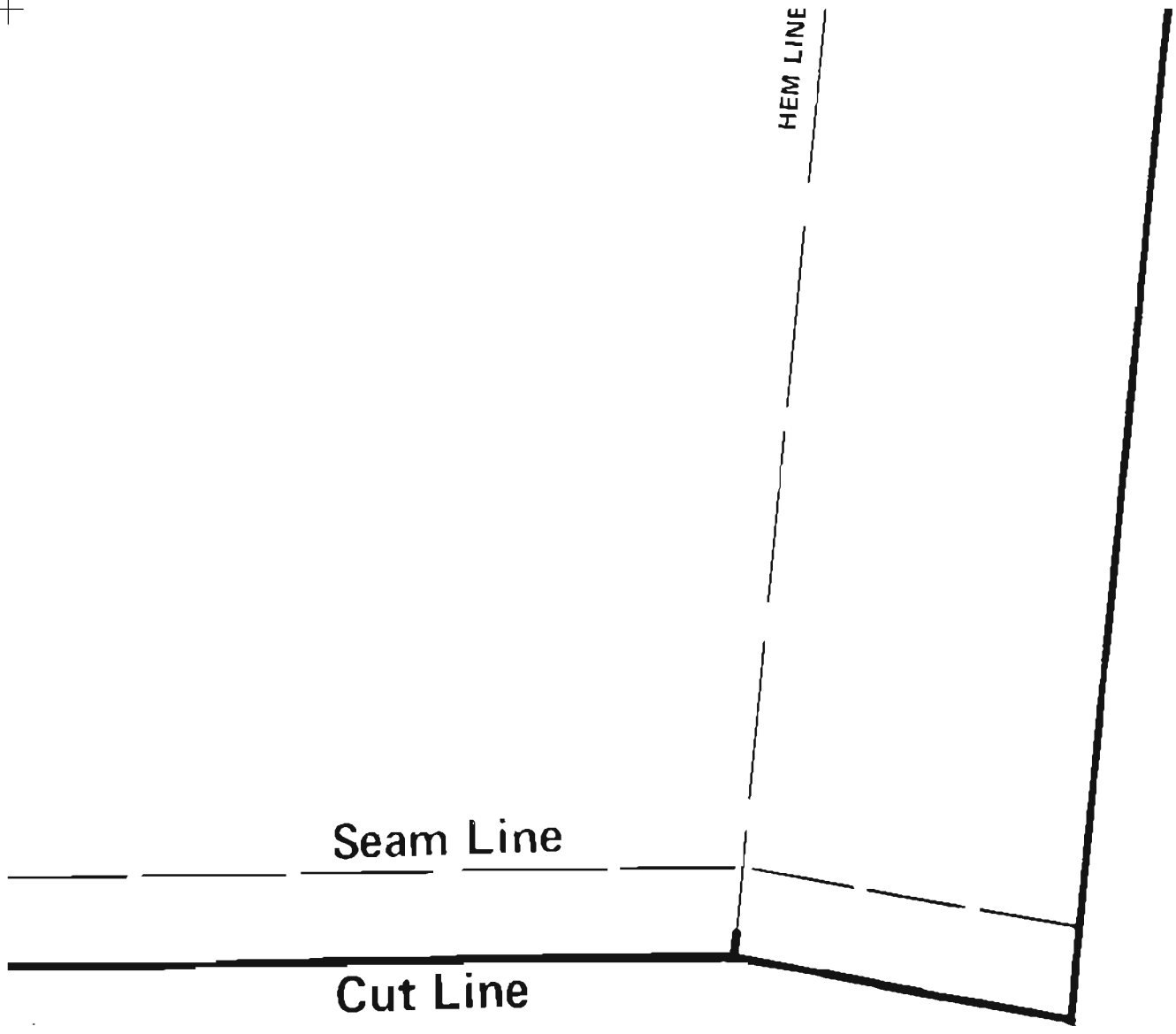

Seam Line

Cut Line

HEM LINE

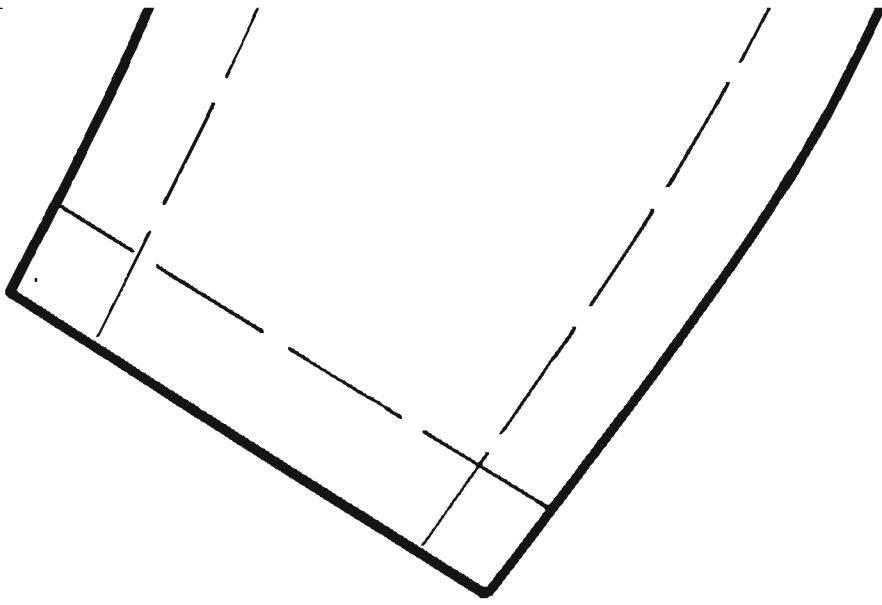

PATTERN PARTS
LADIES COAT
Size 12

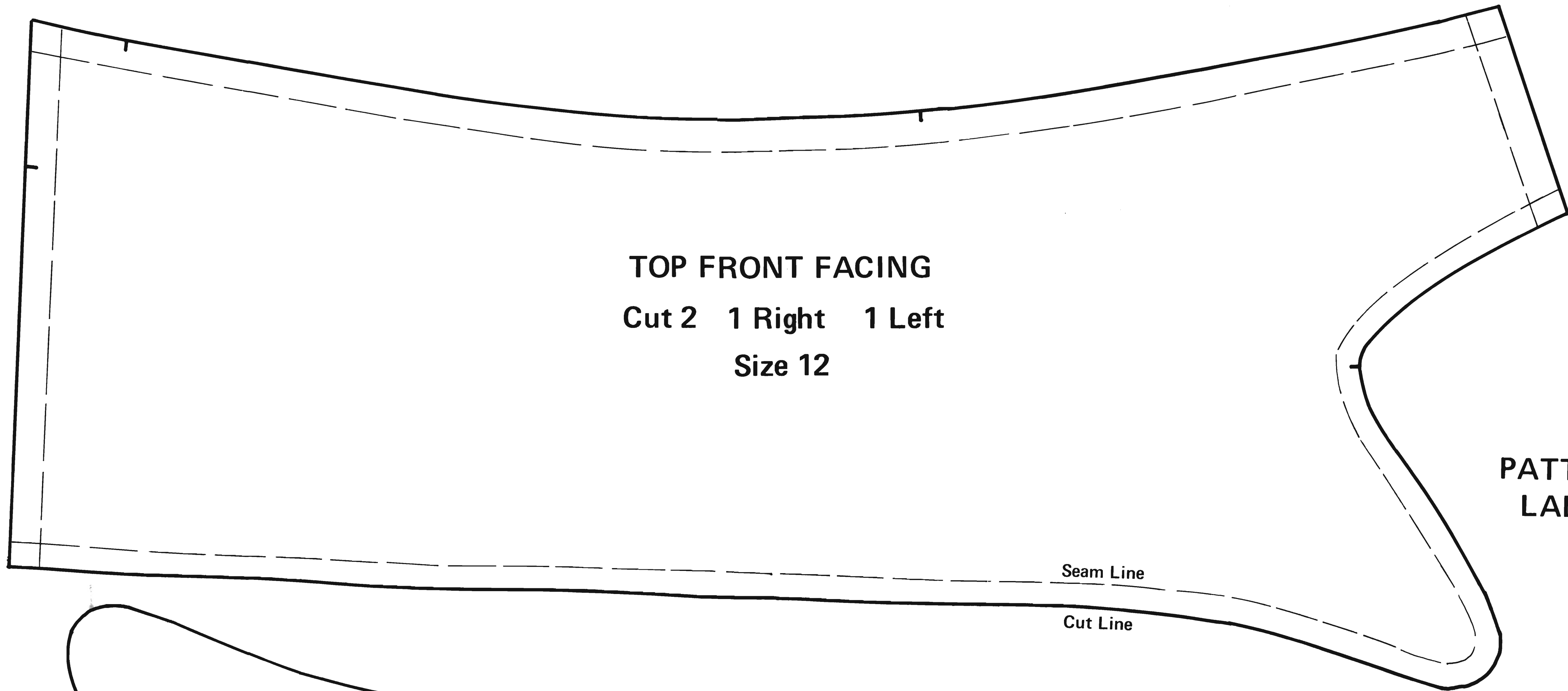

TOP FRONT FACING
Cut 2 1 Right 1 Left
Size 12

PATTERN PARTS
LADIES COAT
Size 12

Seam Line

Cut Line

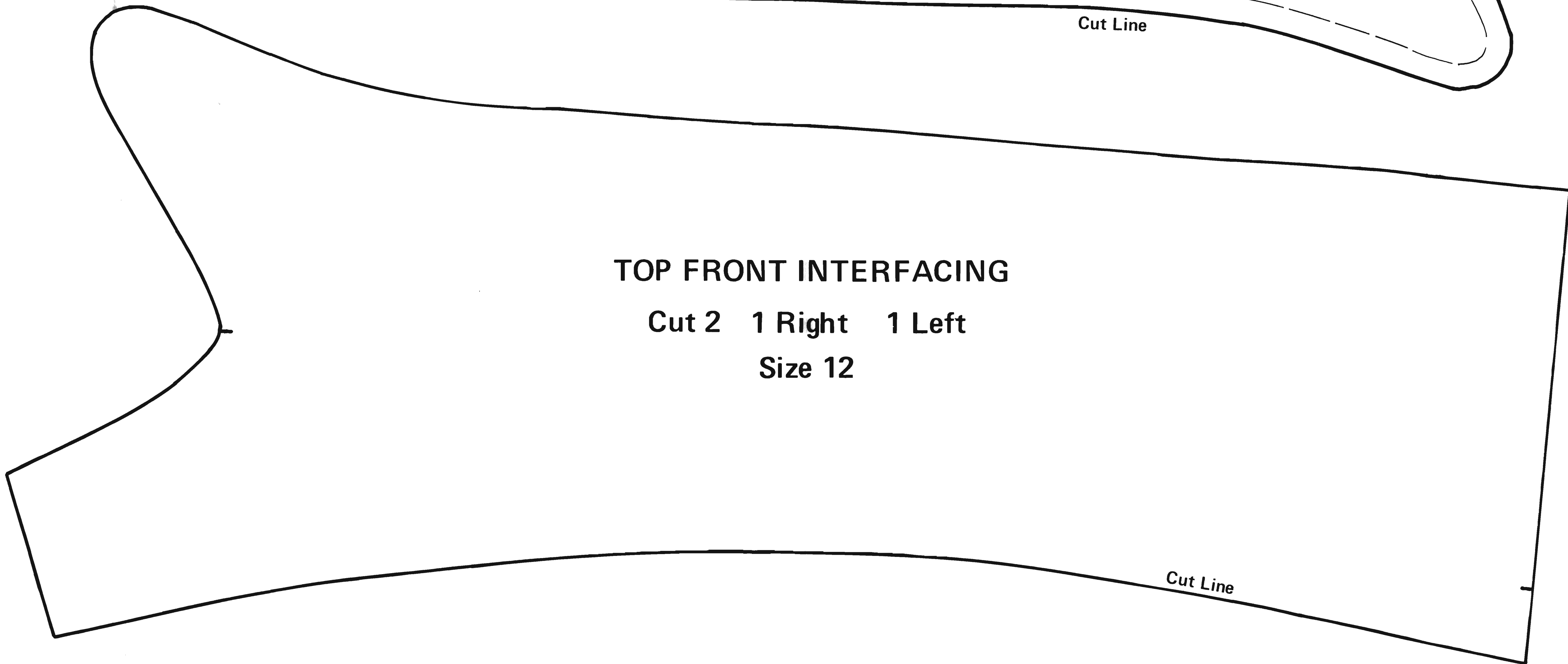

TOP FRONT INTERFACING
Cut 2 1 Right 1 Left
Size 12

Cut Line



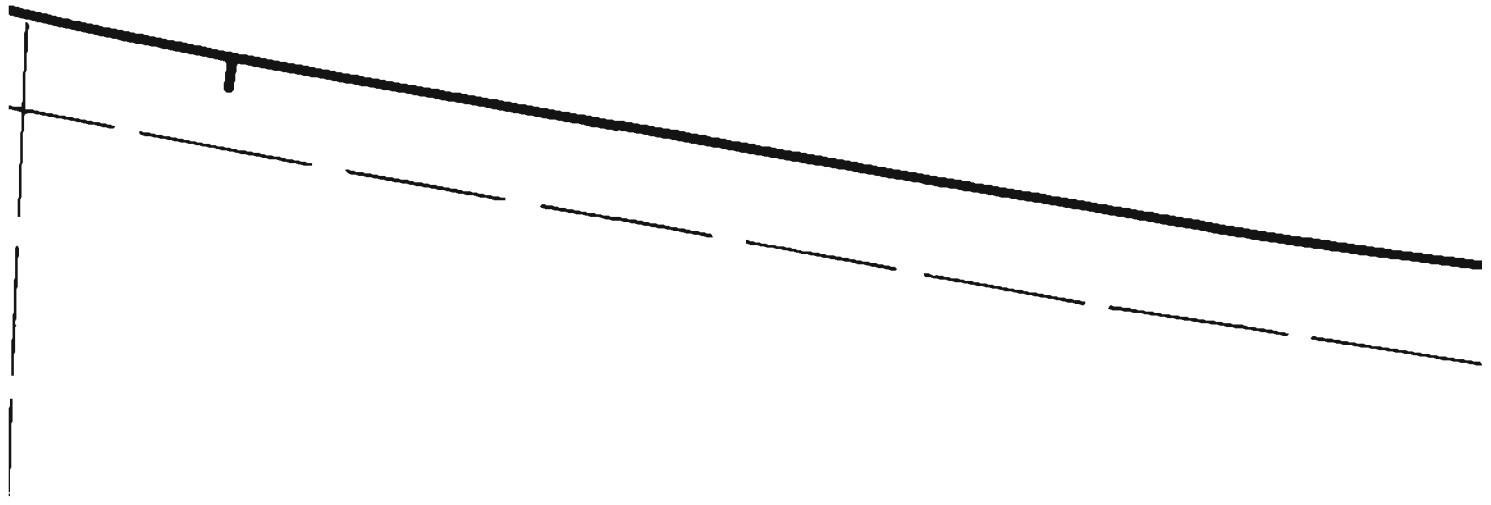

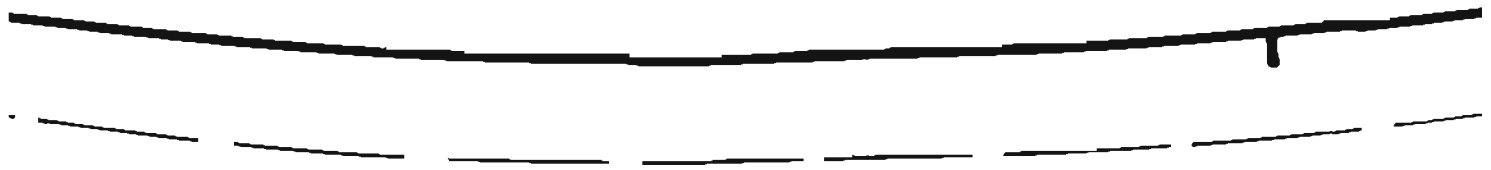

TOP FRONT FACING

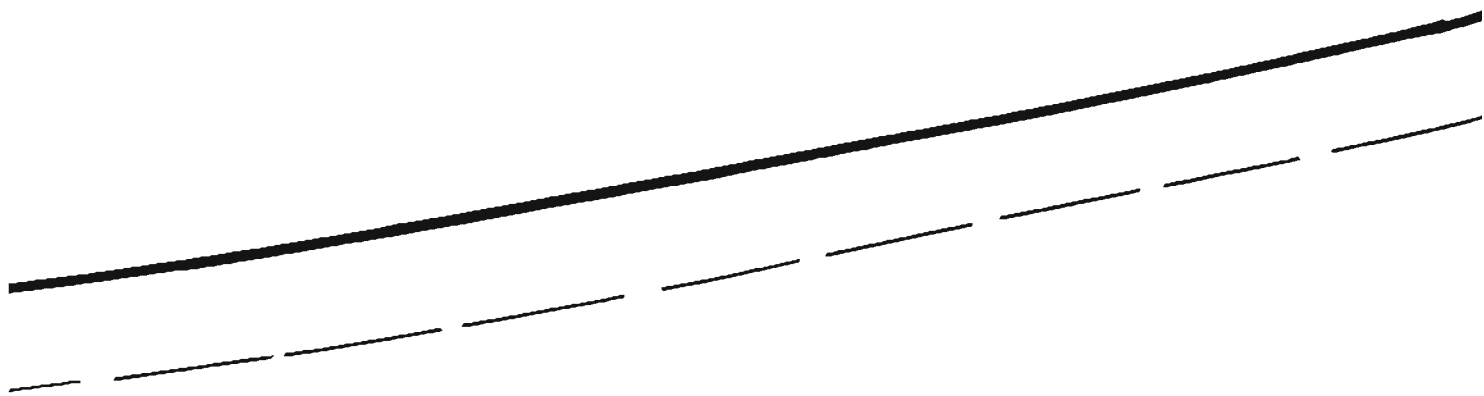

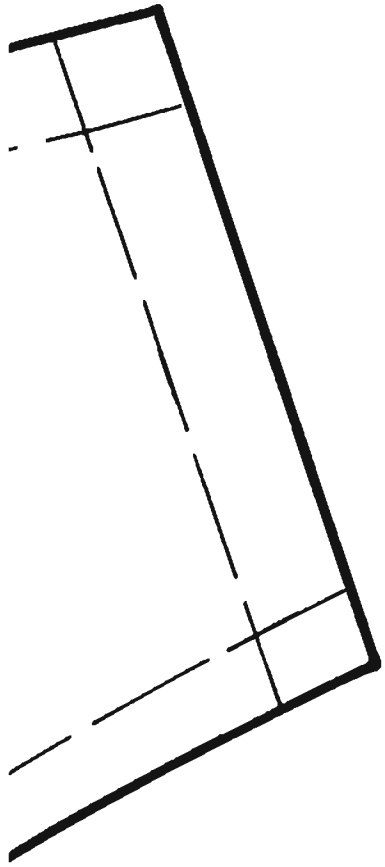

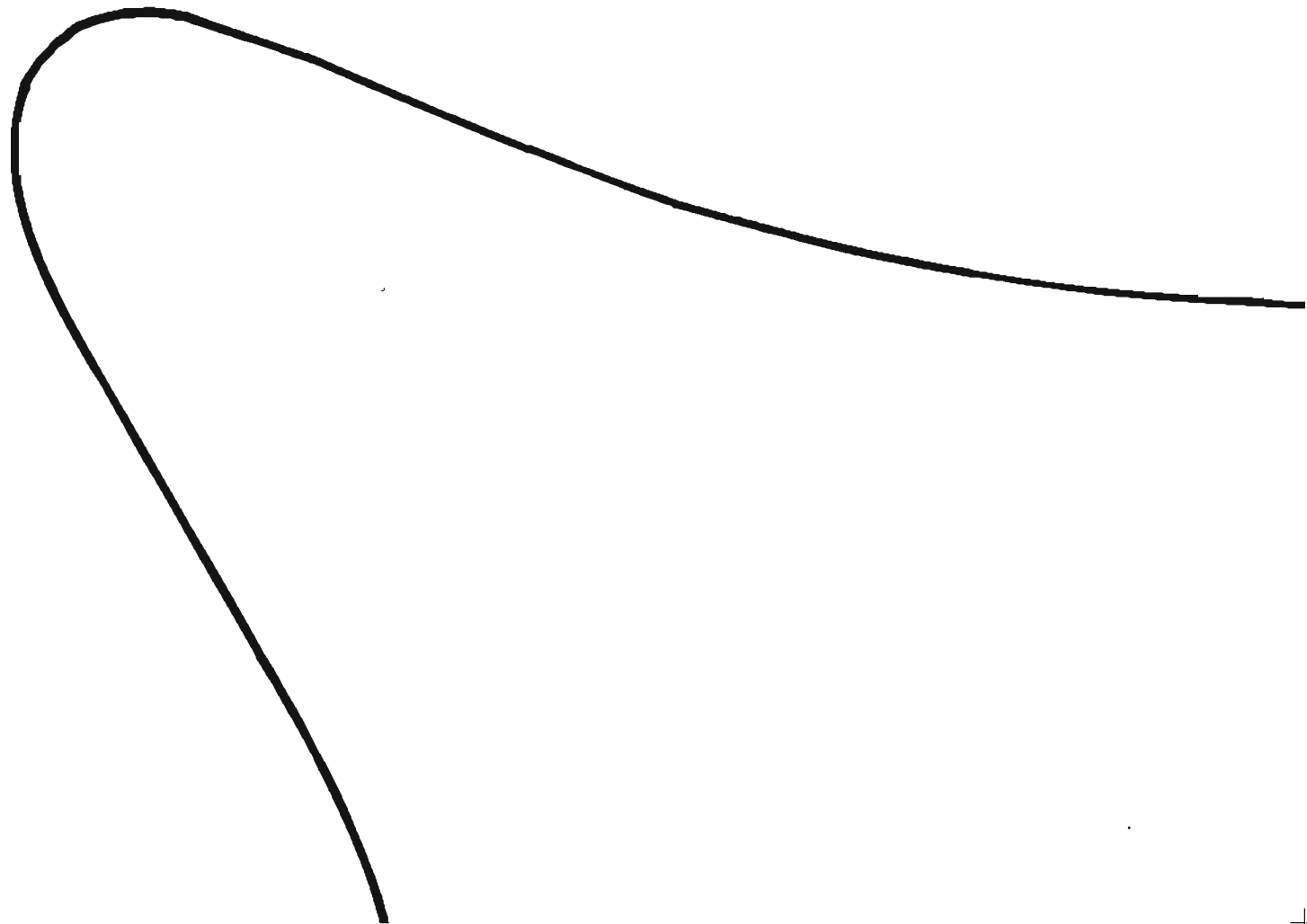
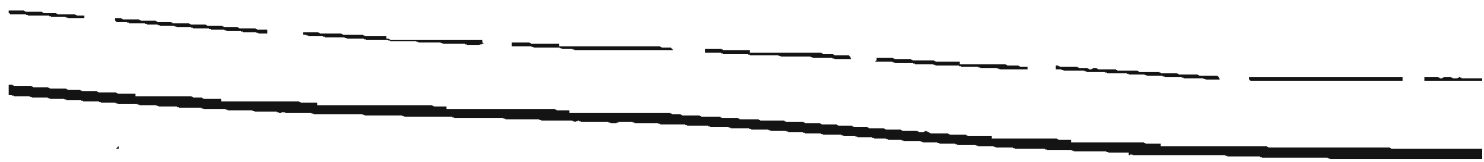

Cut 2

1 Right

1 Left

Size 12

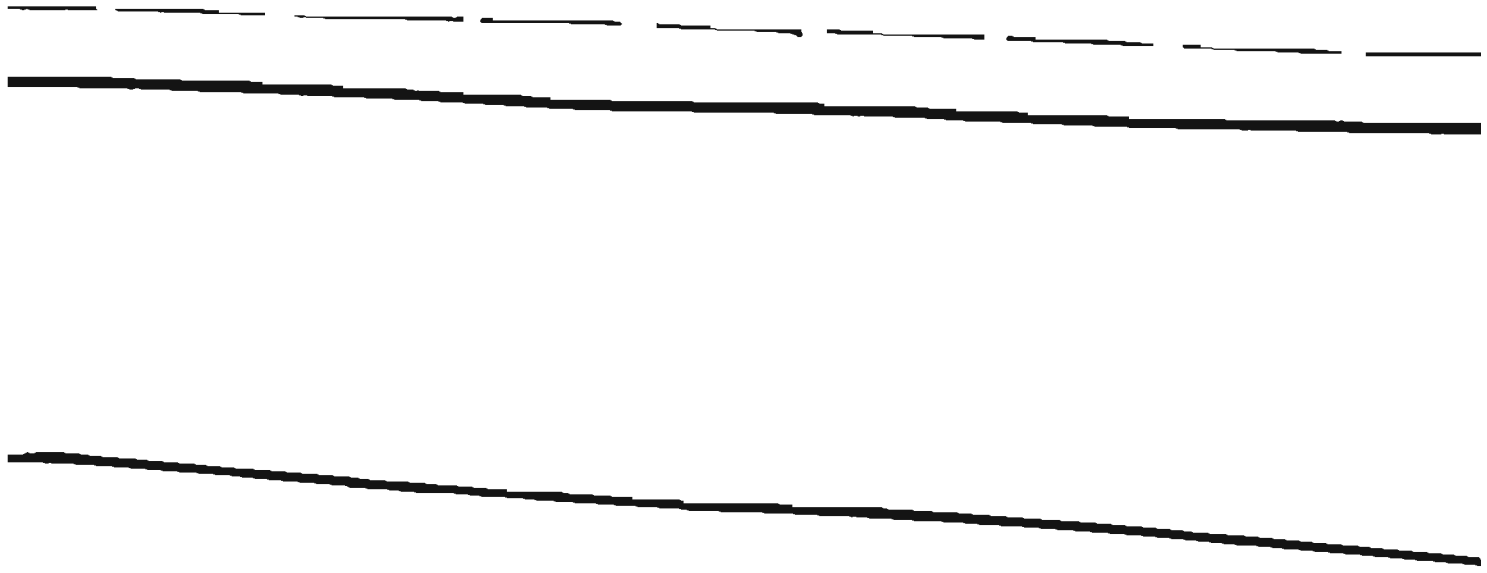

TOP FRONT INTERFACING

Cut 2

1 Right

1 Left



The image shows a technical drawing of a curved seam and cut line. A dashed line, labeled 'Seam Line', curves downwards from left to right. Below it is a solid line, labeled 'Cut Line', which also curves downwards but is positioned further down. The lines are black on a white background. There are some faint marks and a small vertical tick on the right side of the drawing.

Seam Line

Cut Line

PATTERN PARTS
LADIES COAT
Size 12

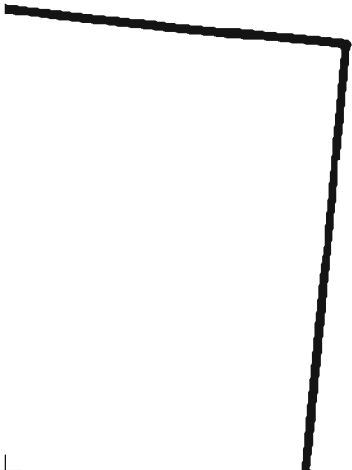

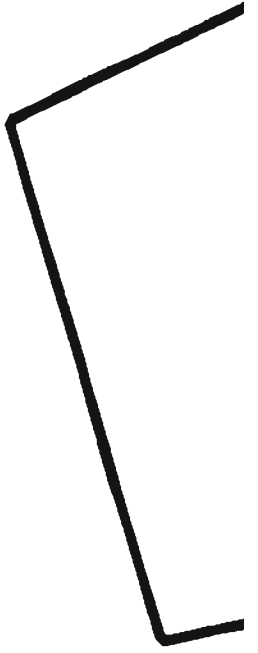

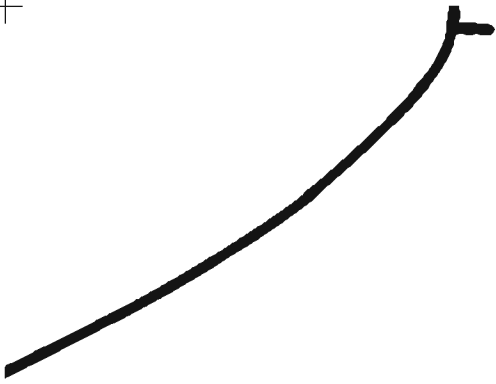

Out 2 | Right | Left

Size 12





Cut Line

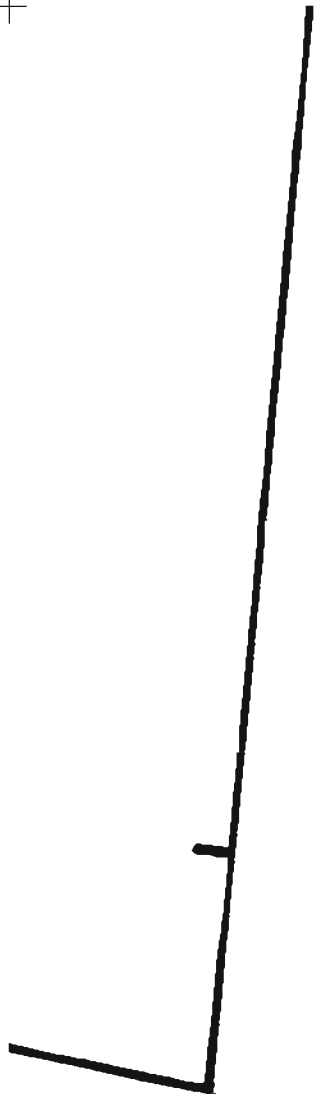

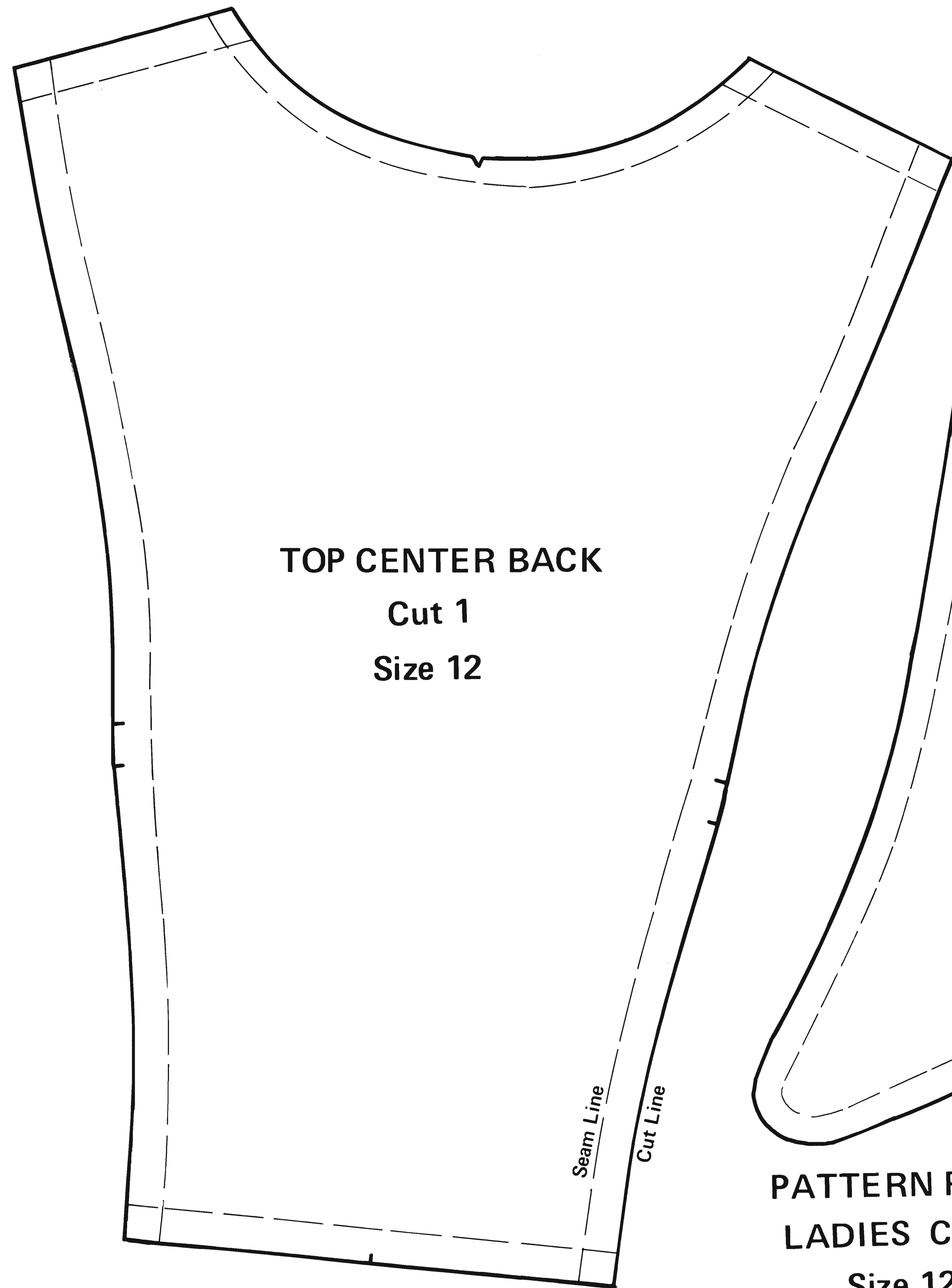

TOP CENTER BACK
Cut 1
Size 12

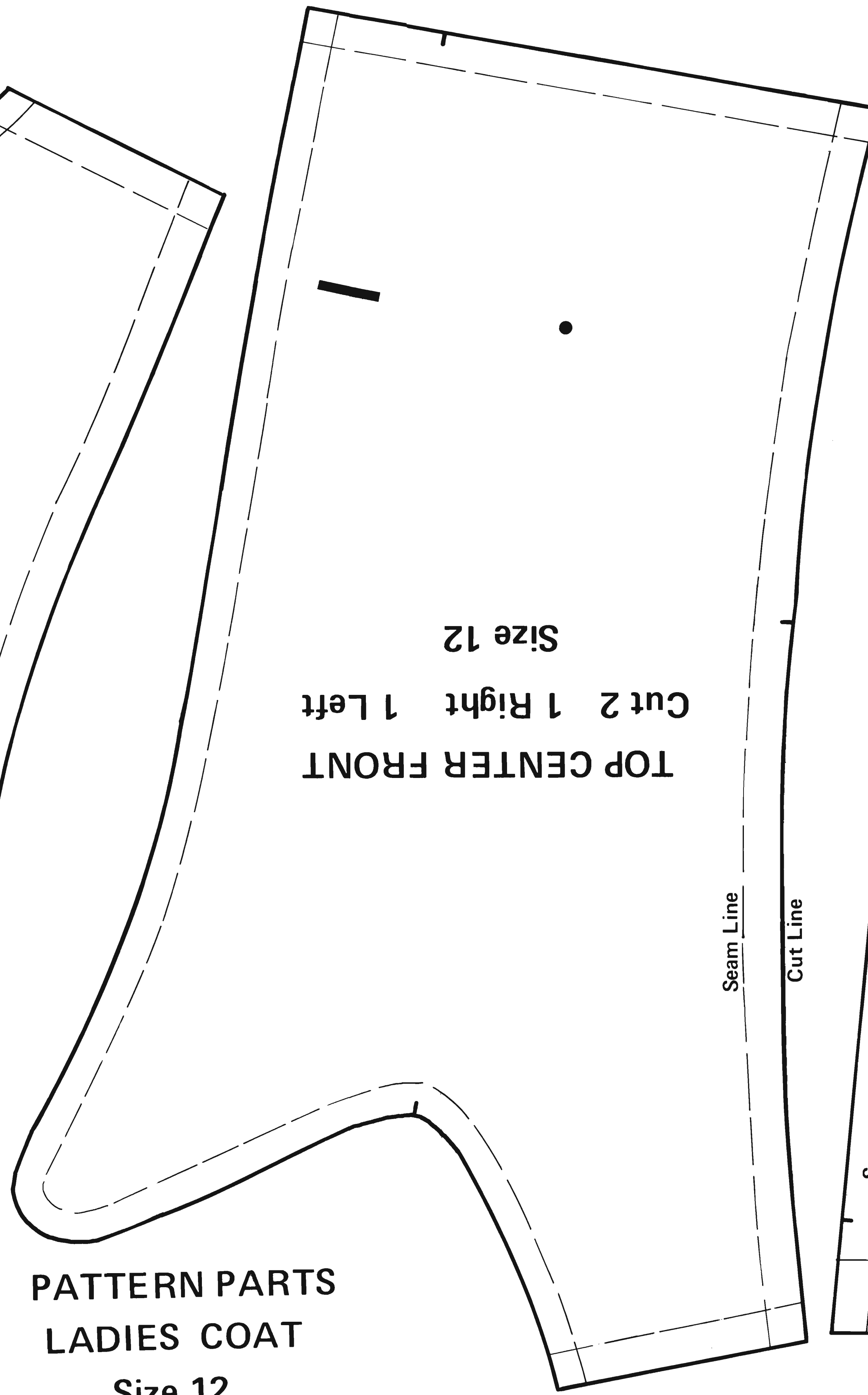

TOP CENTER FRONT
Cut 2 1 Right 1 Left
Size 12

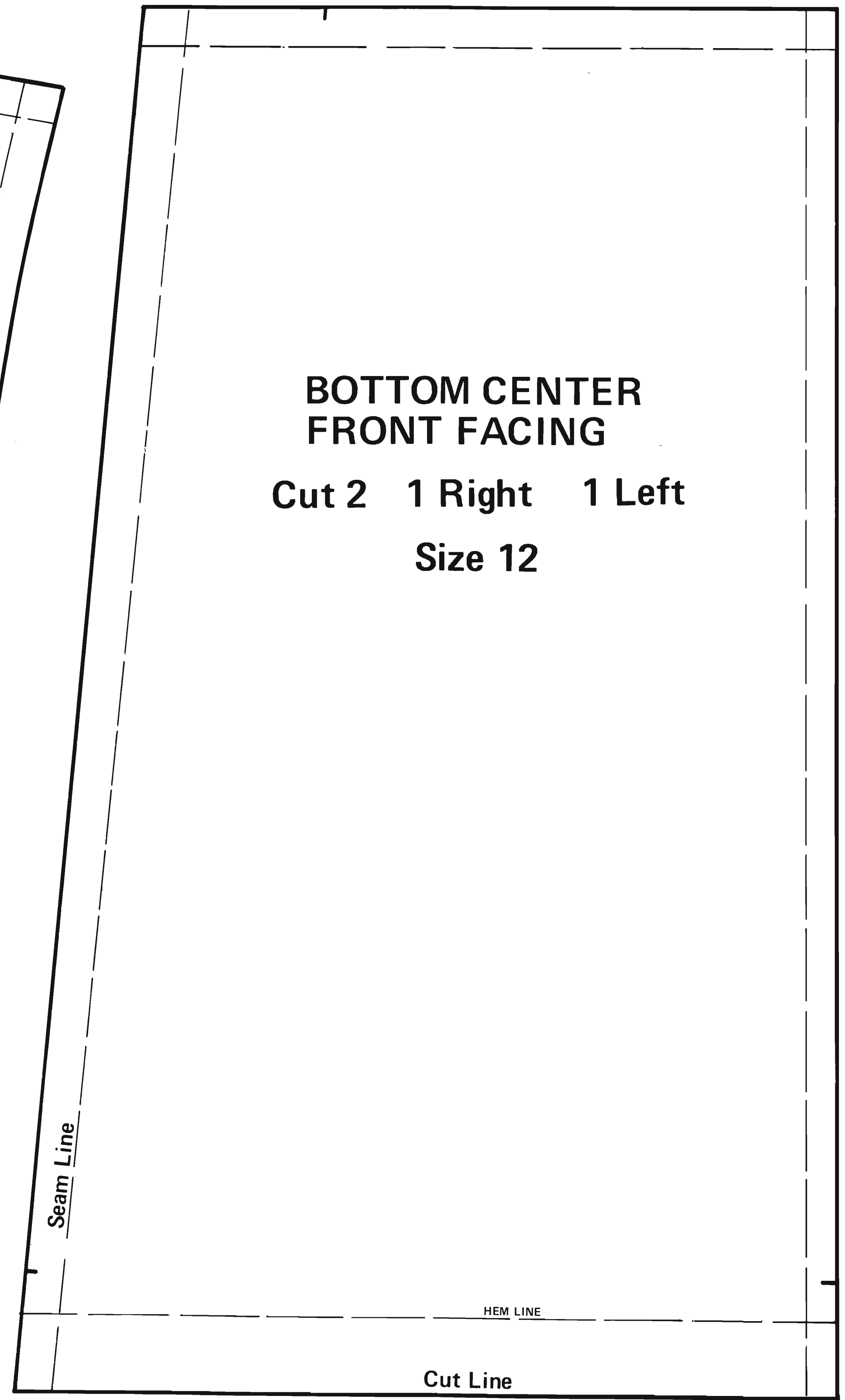

**BOTTOM CENTER
FRONT FACING**
Cut 2 1 Right 1 Left
Size 12

**PATTERN PARTS
LADIES COAT**
Size 12

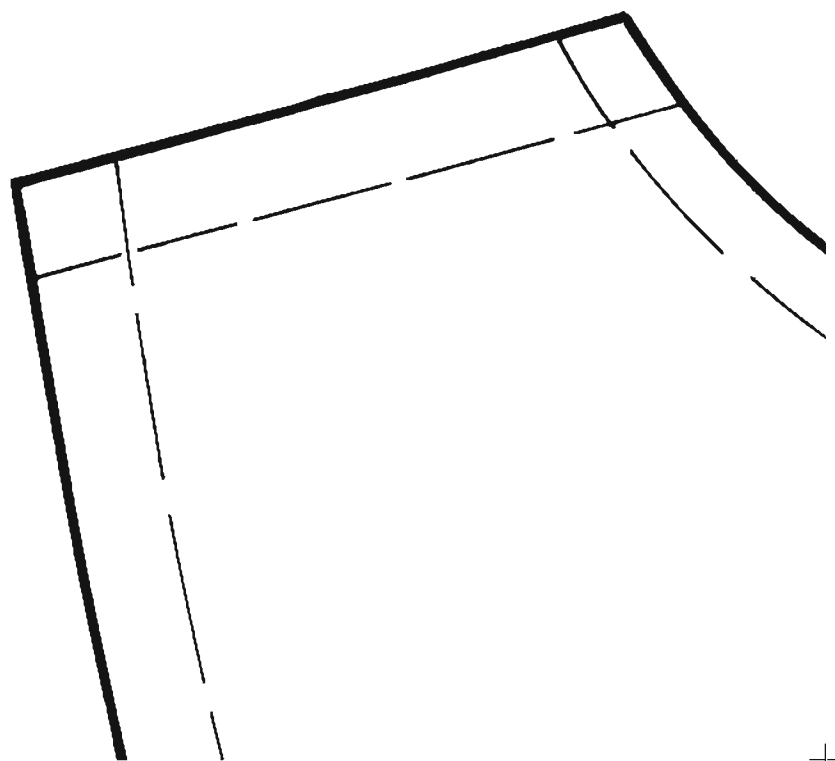



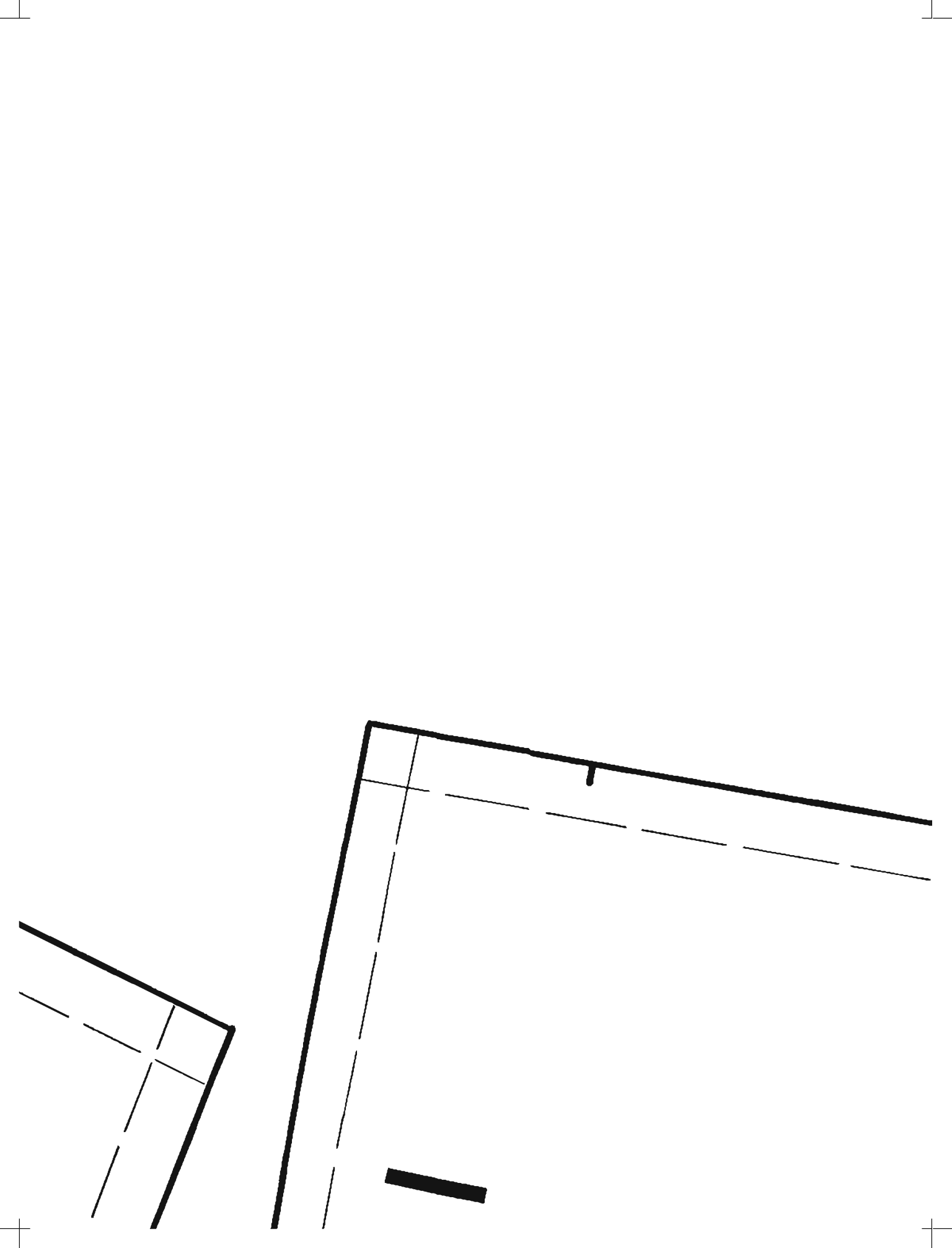

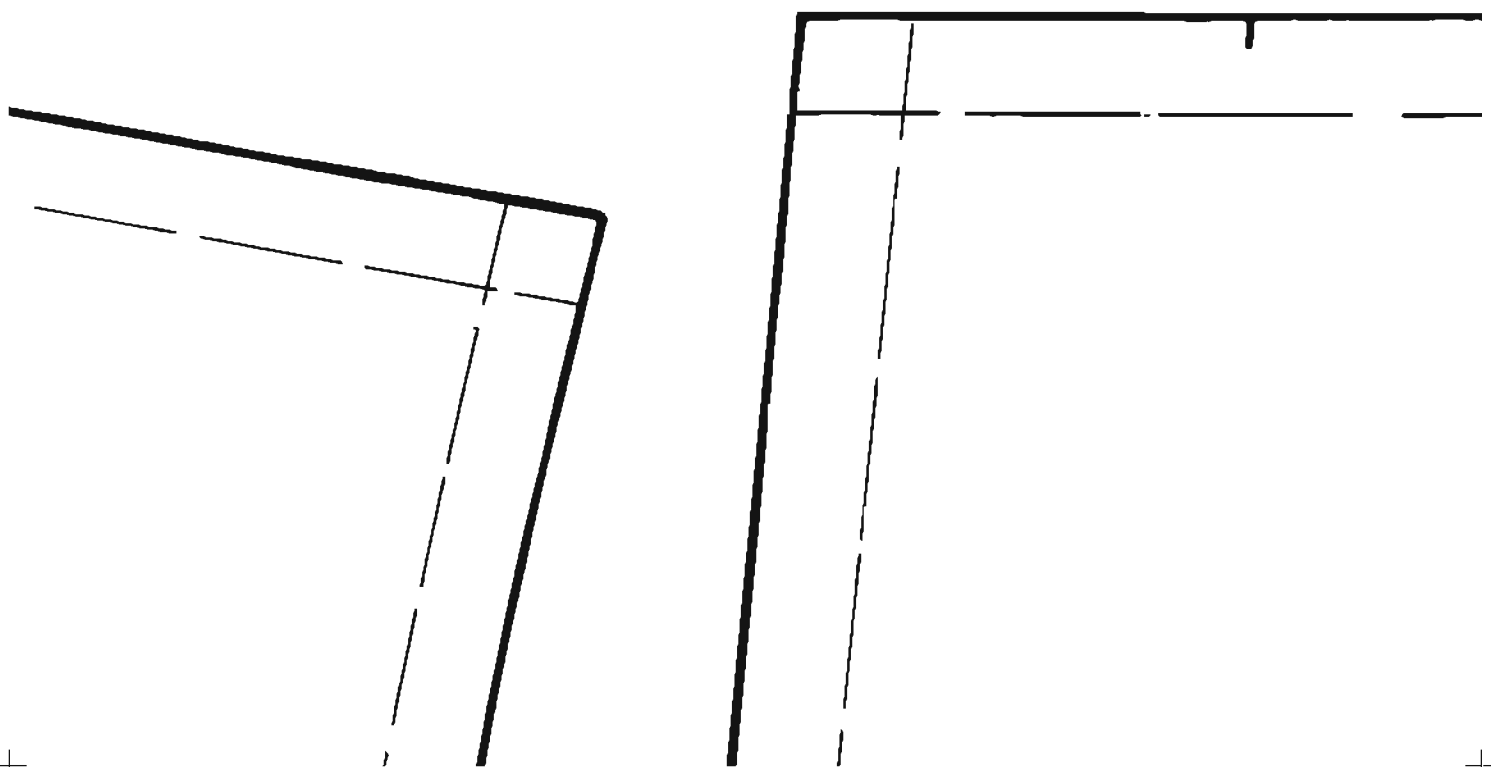

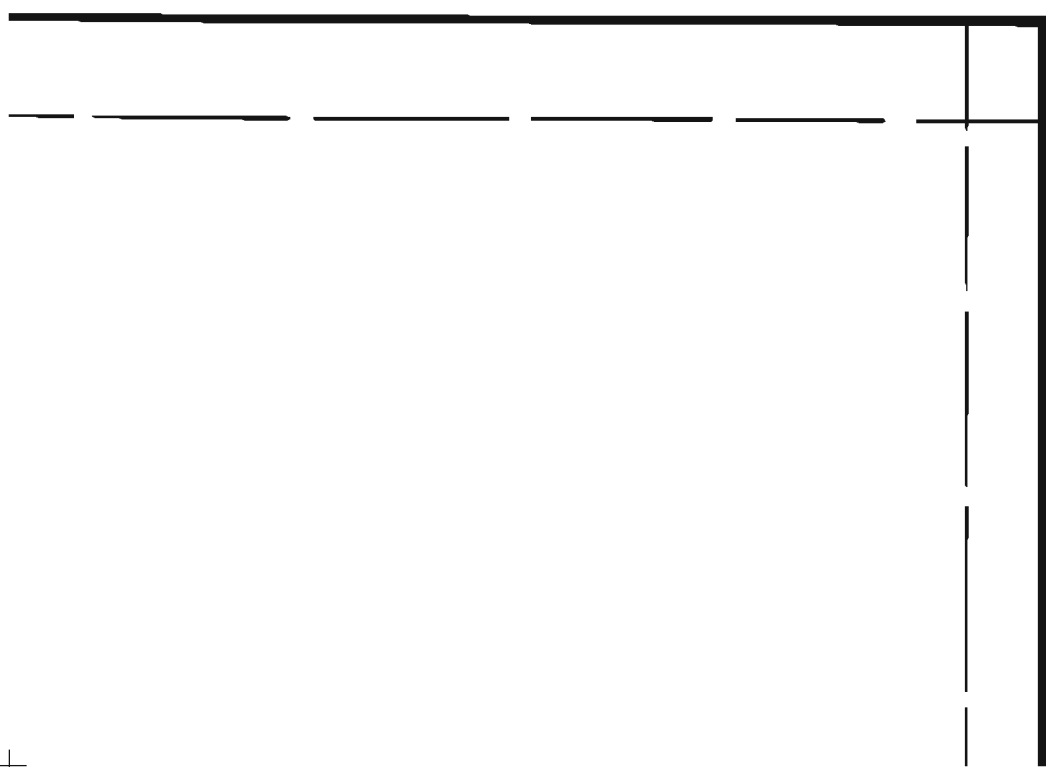

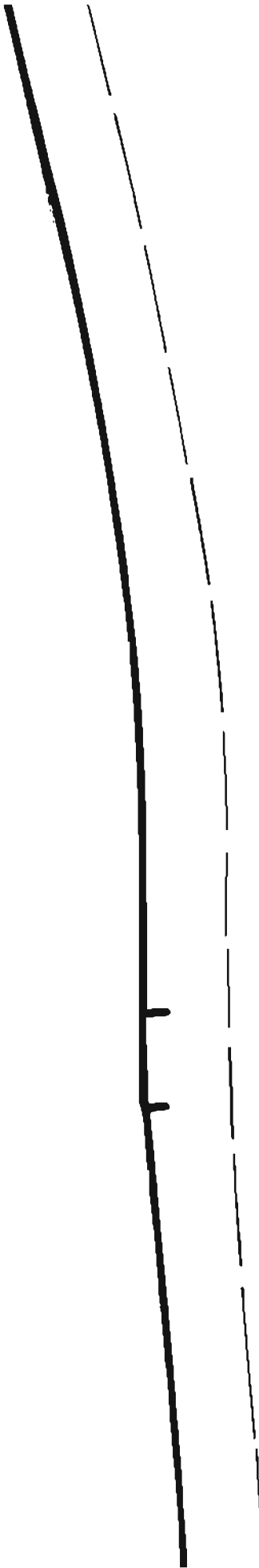

T

OP CENTER BACK

Cut 1

Size 12

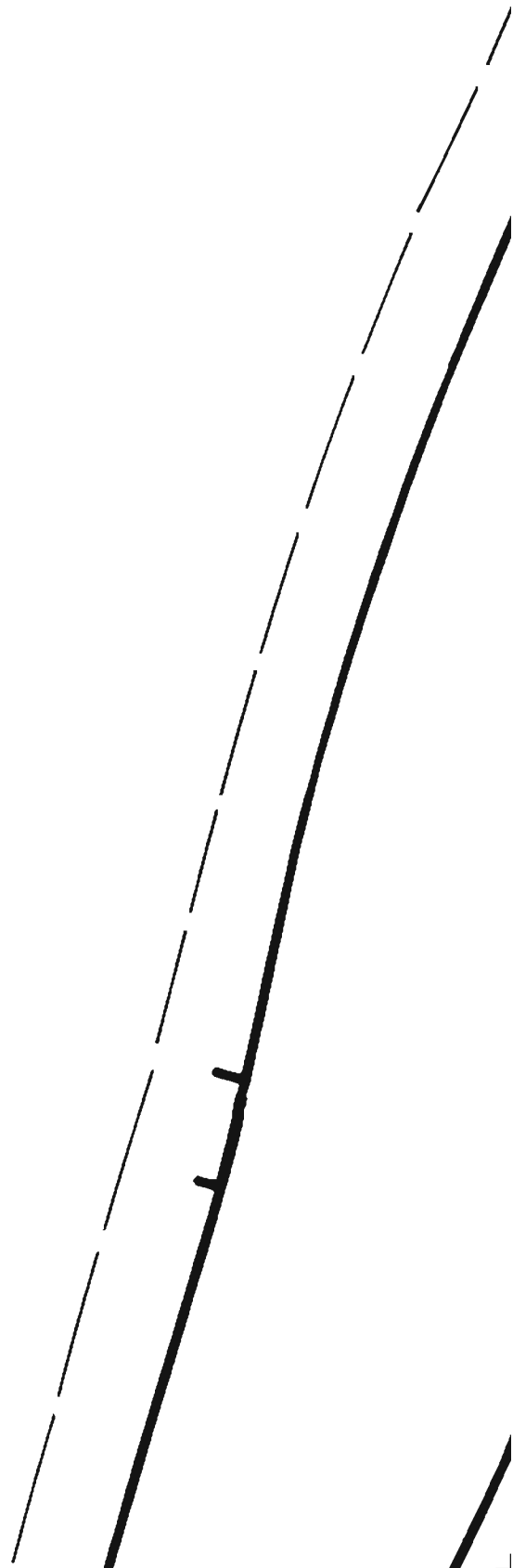

TOP CENTER FRONT
1 Right 1 Left
Size 12

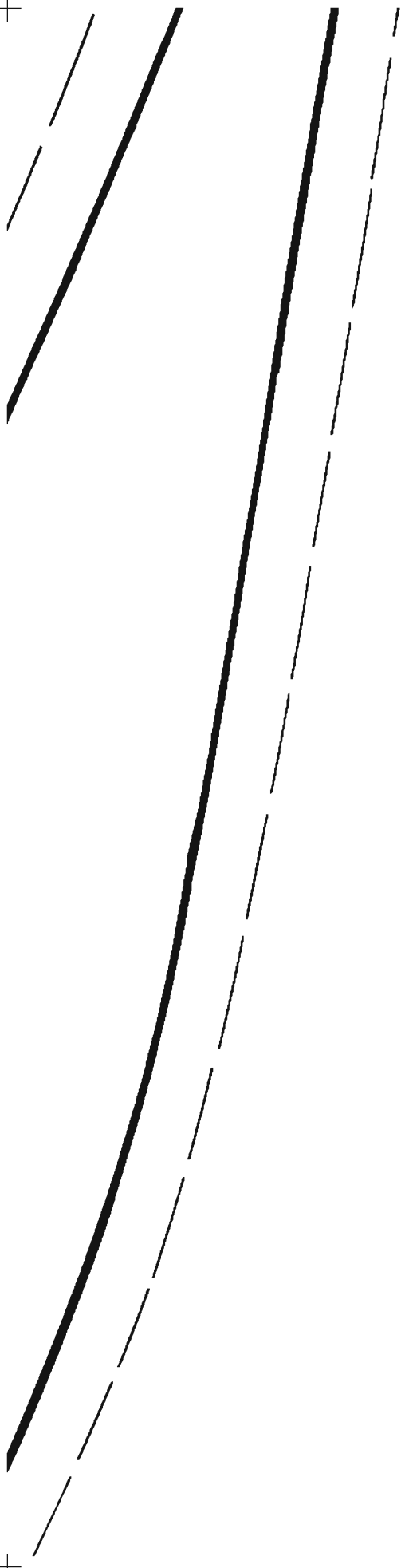

**T
C**

Seam Line

Cut Line

**BOTTO
FRONT
Cut 2 1**

**DM CENTER
T FACING**

| Right 1 Left

Size 12

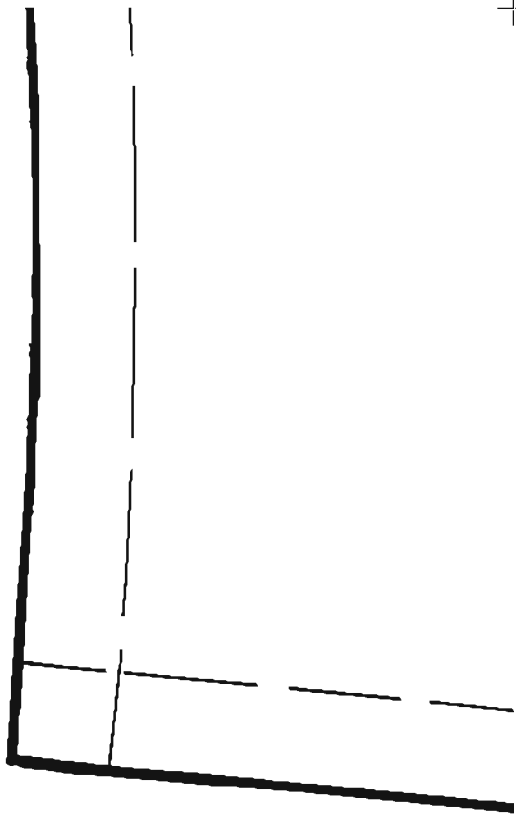

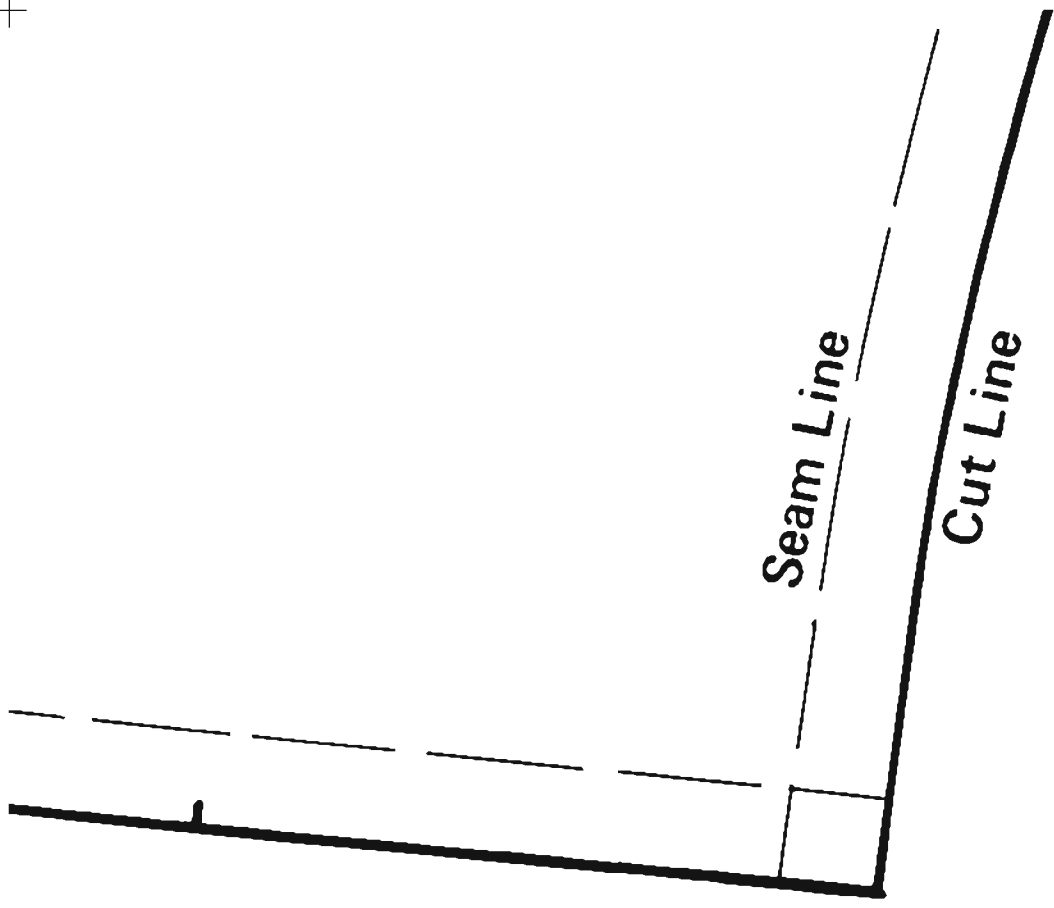

PA1
LA

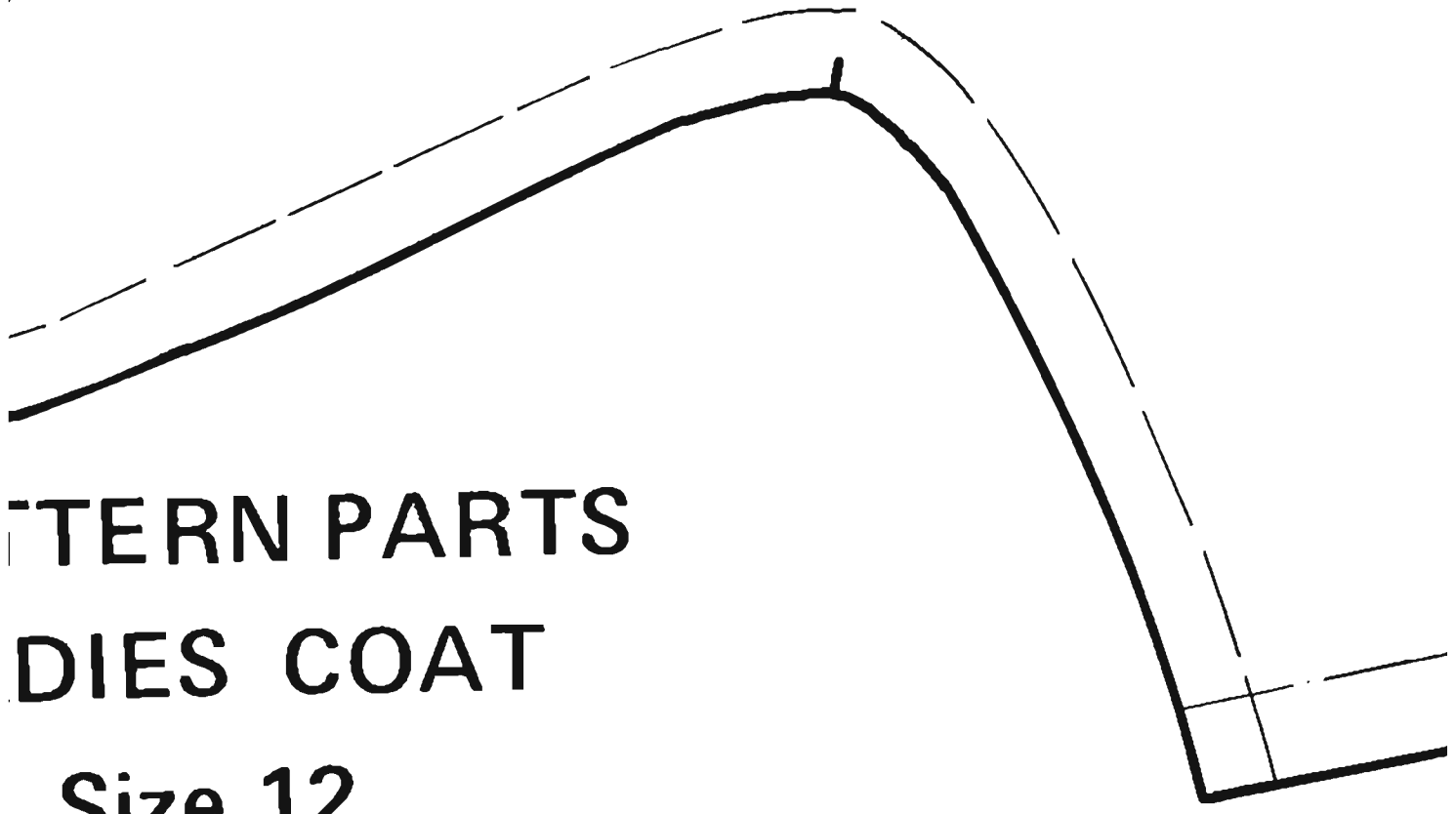

TERN PARTS
DIES COAT
Size 12

Seam Line

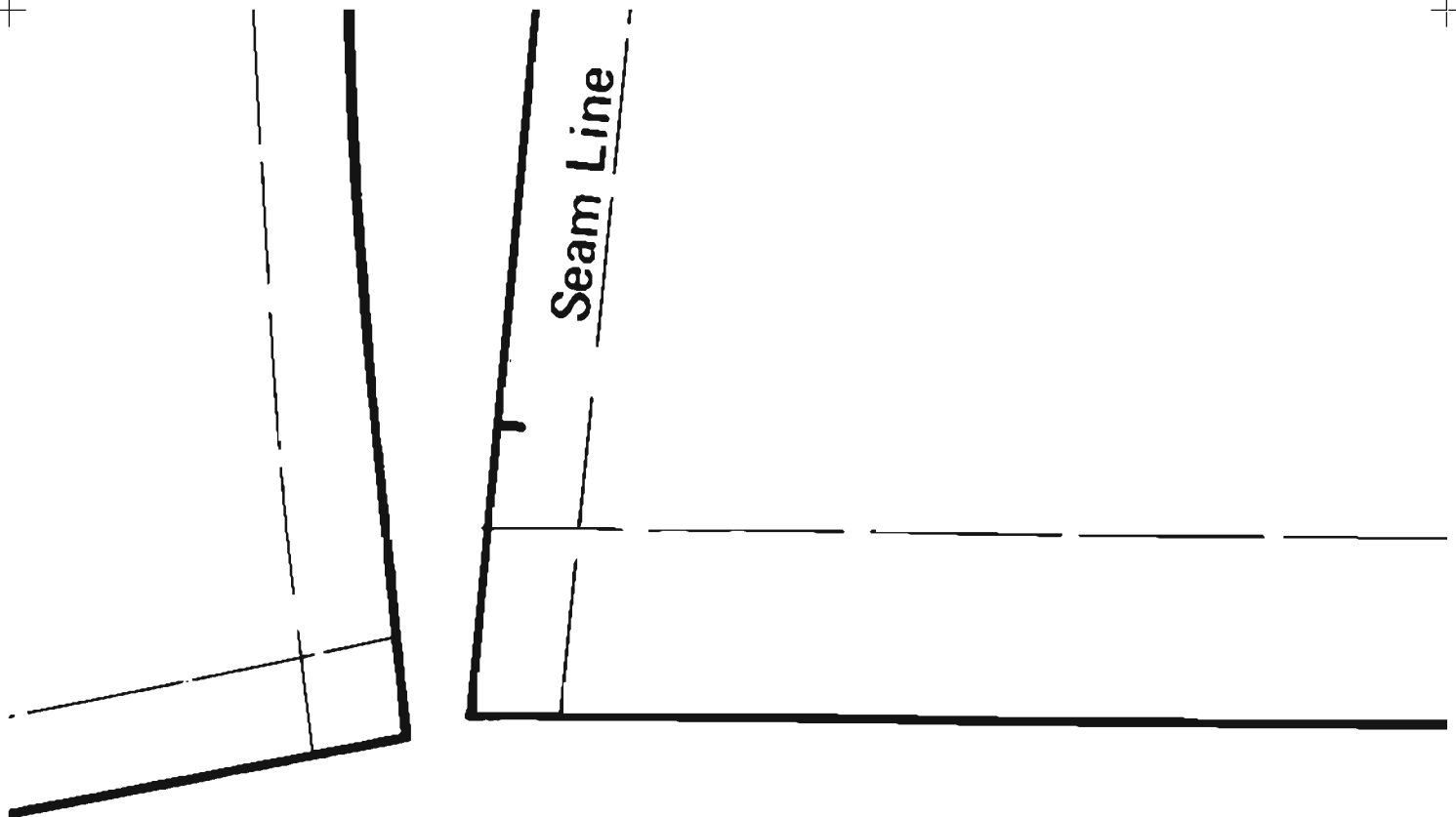

HEM LINE

Cut Line

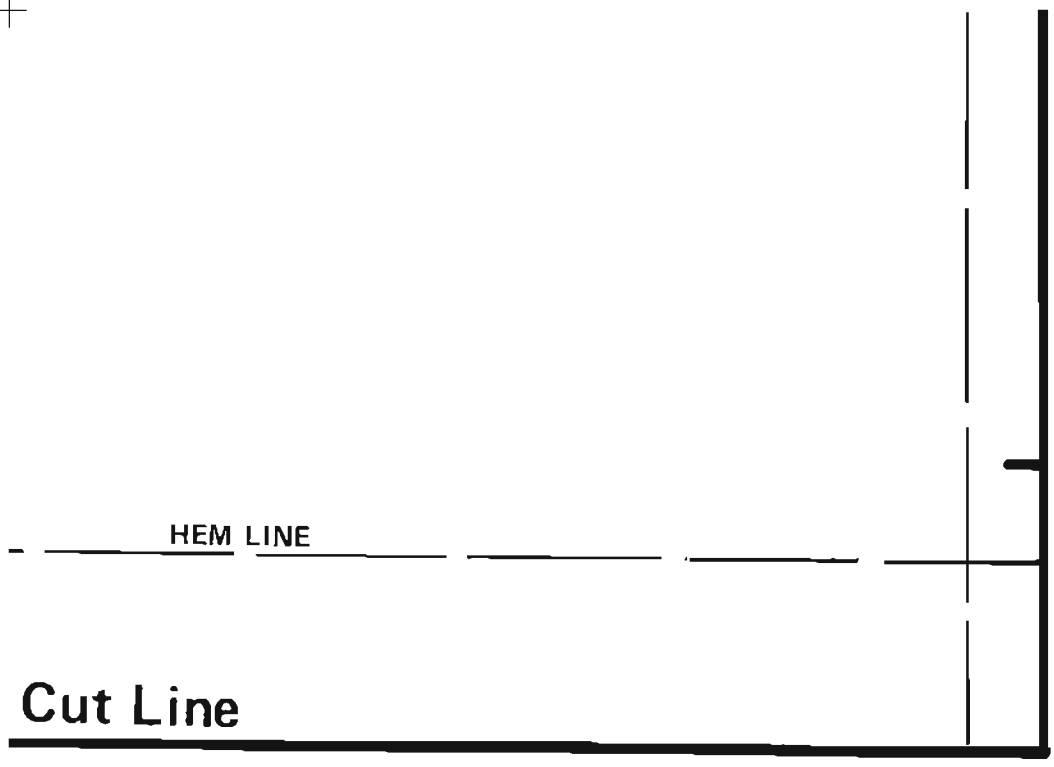

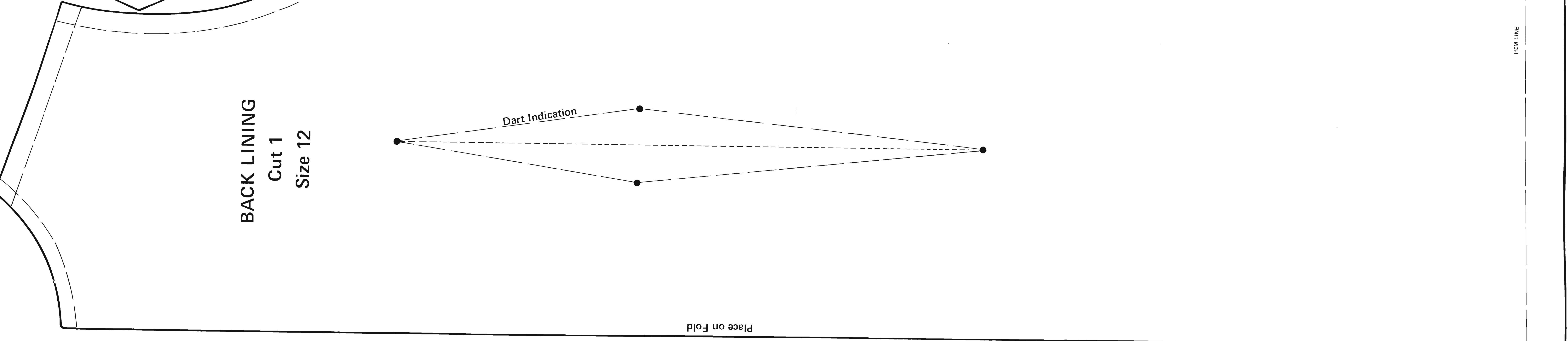
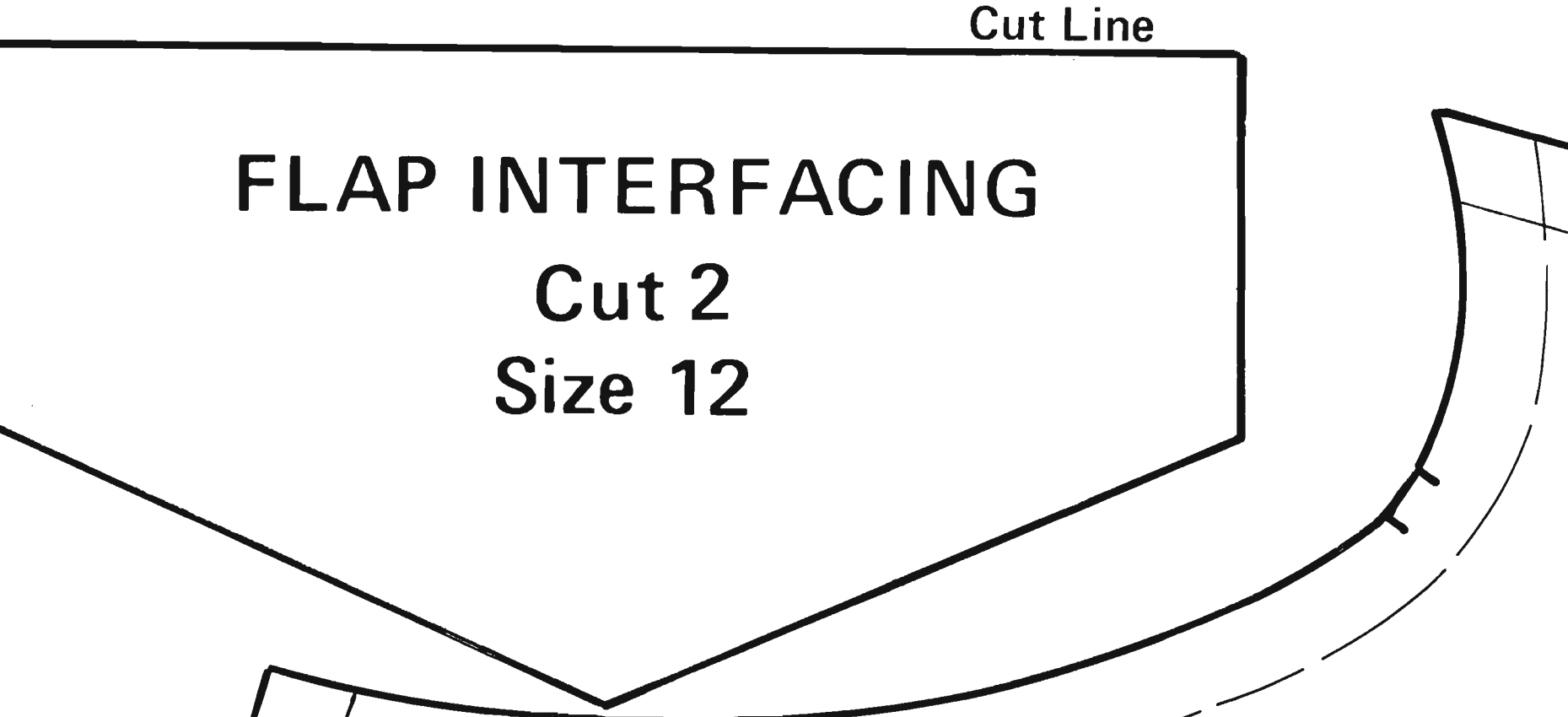
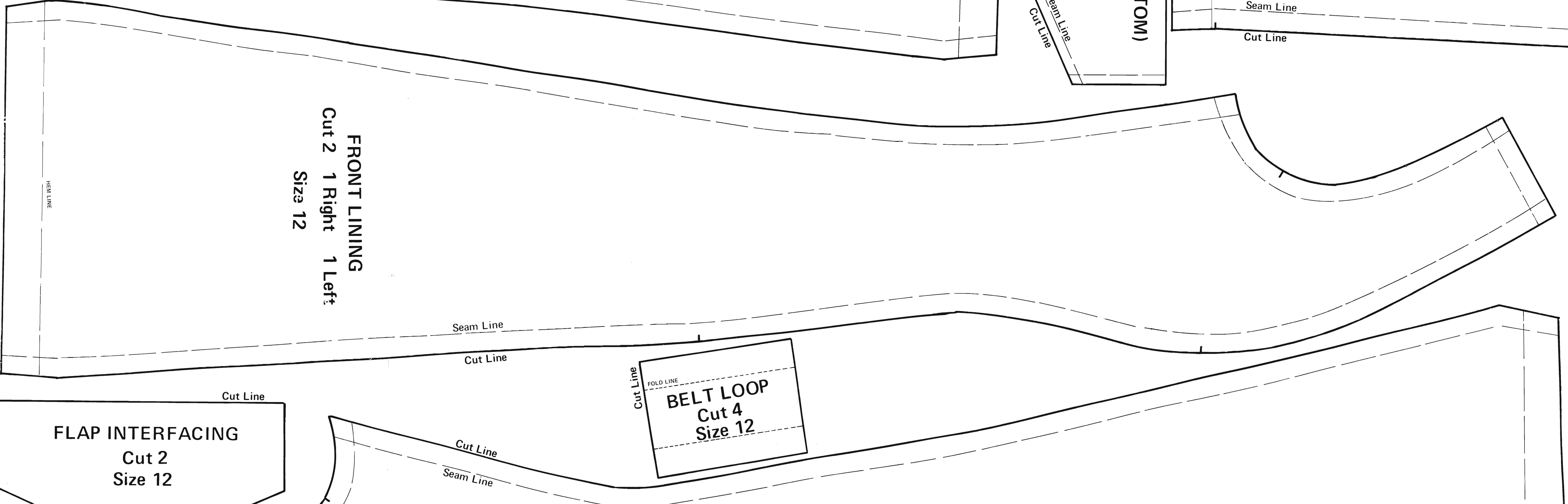
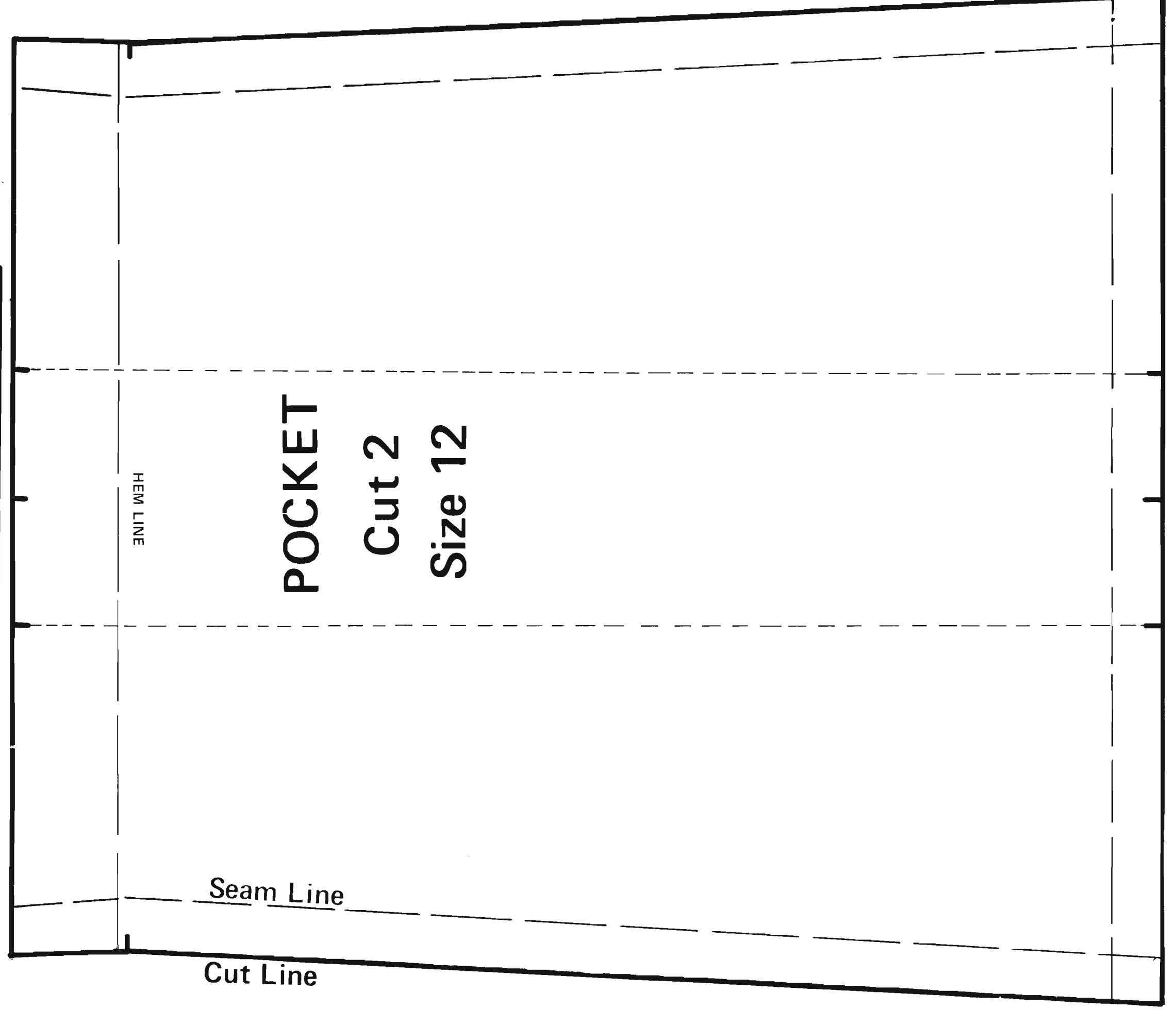
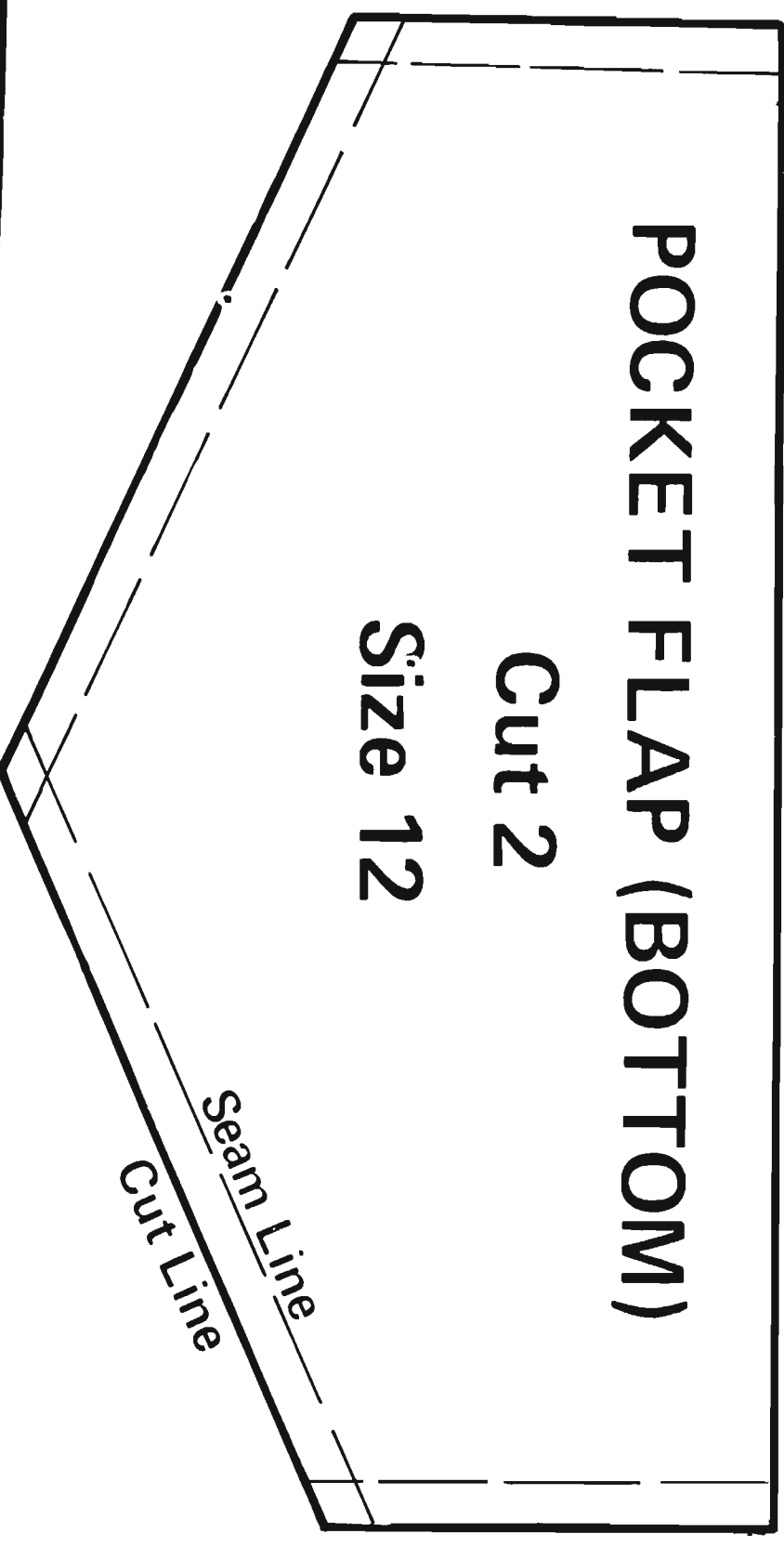
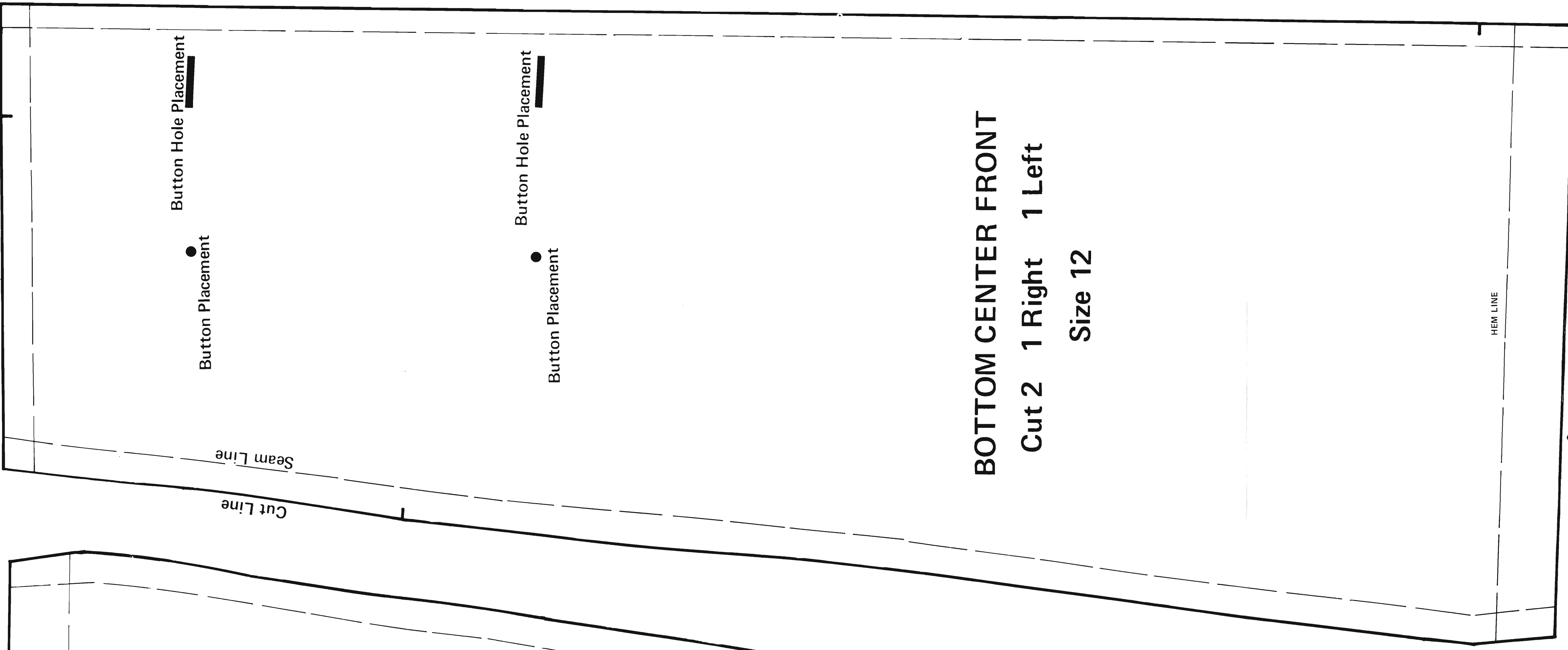

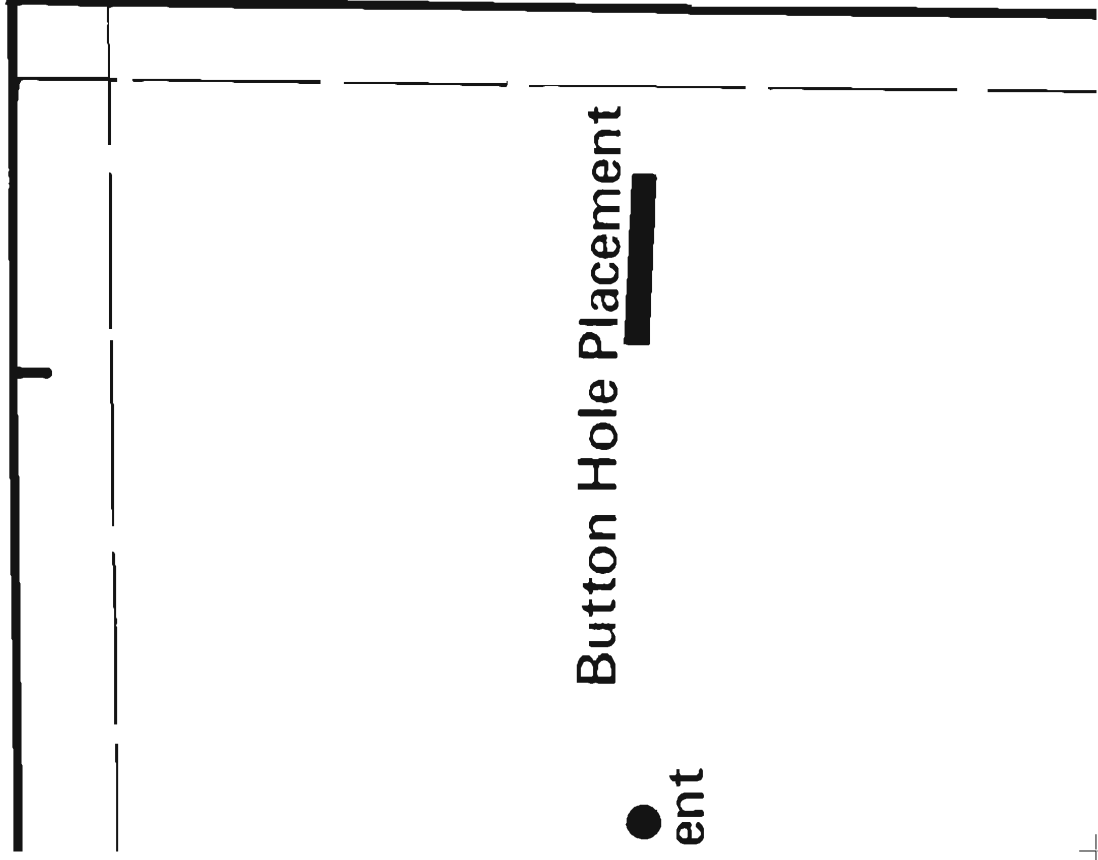

Button Hole Placement

● ent

Button Hole Placement



11



ER FRONT

: 1 Left

2

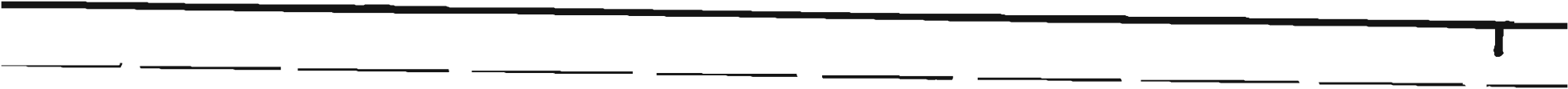

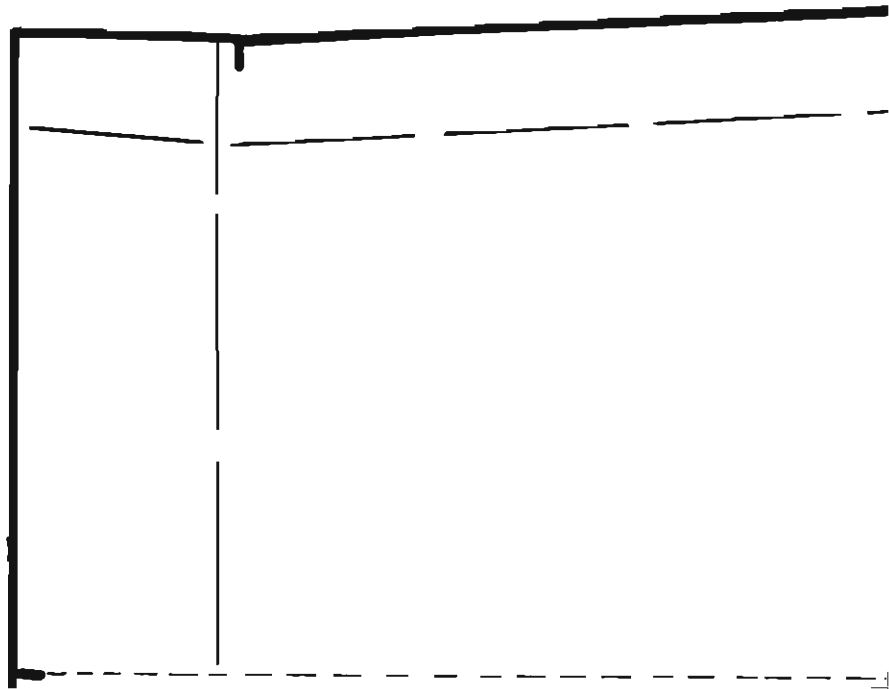
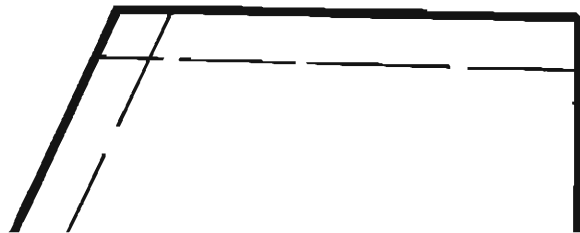
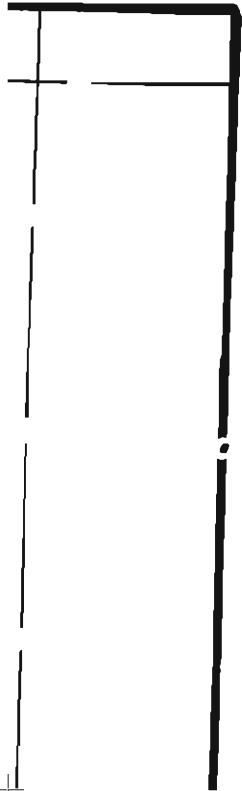

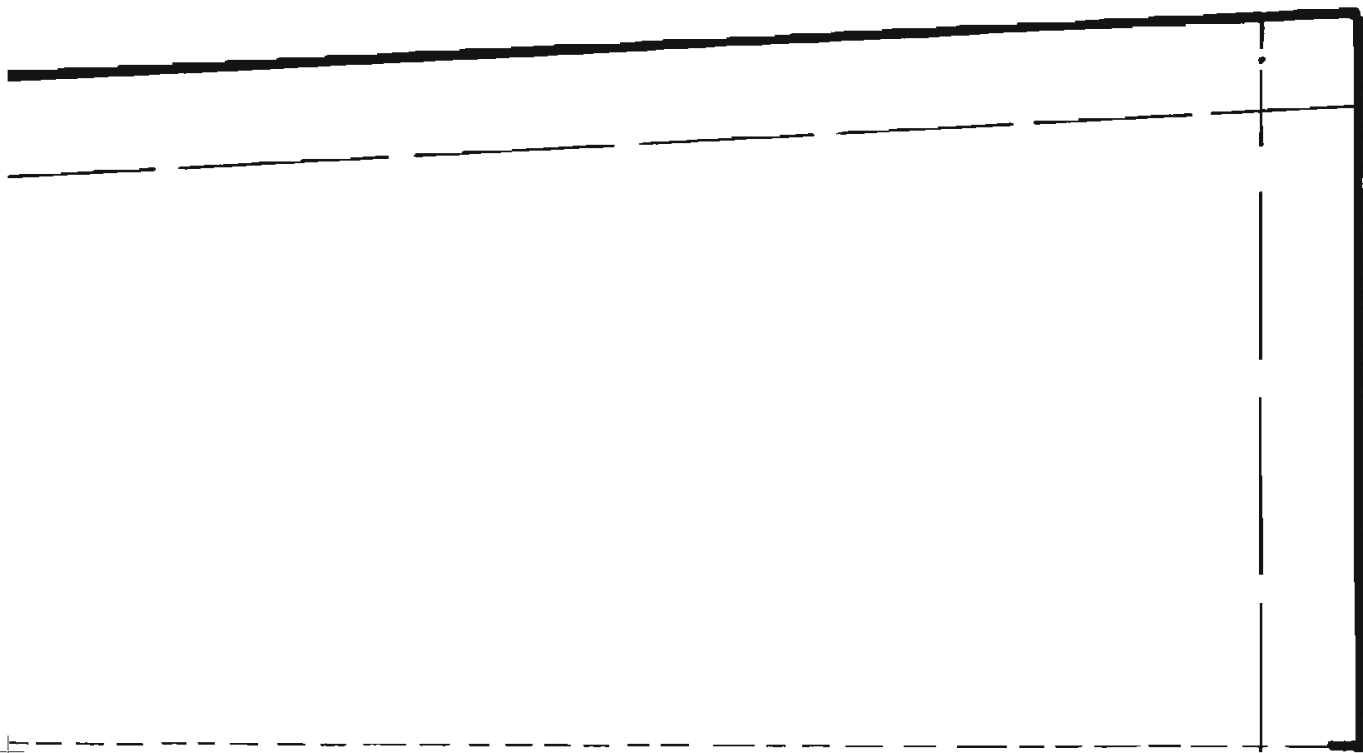

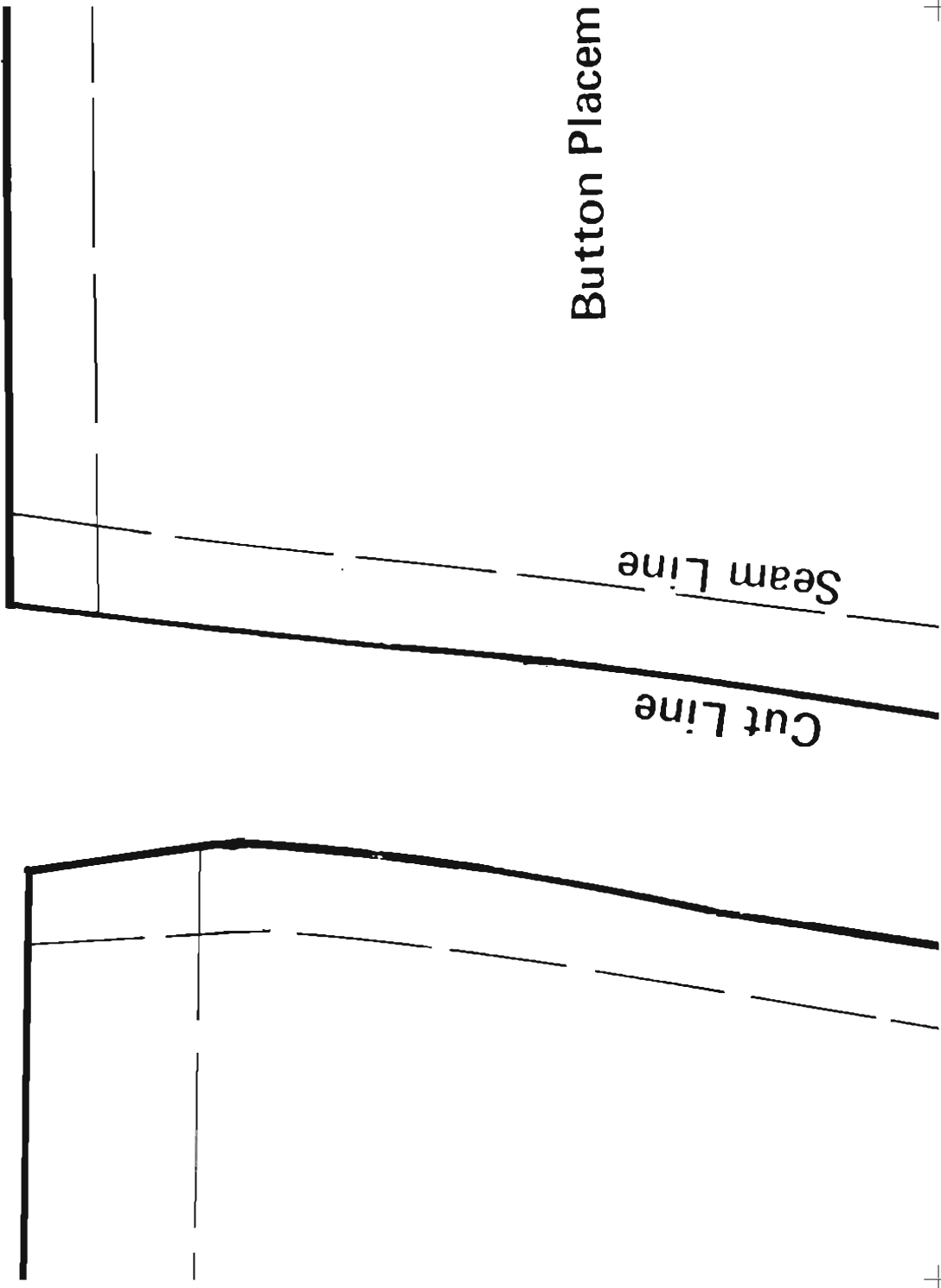

Button Placem

Seam Line

Cut Line

Button Placemer

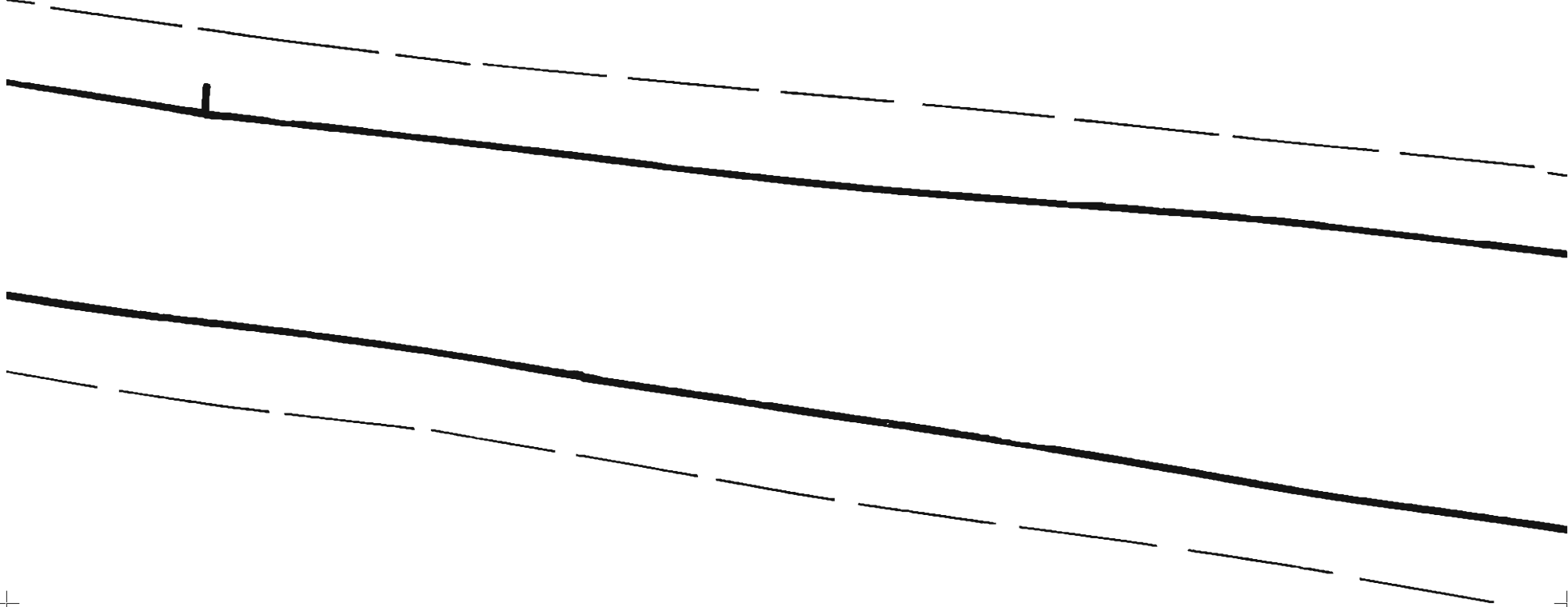

BOTTOM CENT

Cut 2 1 Right

Size 1:

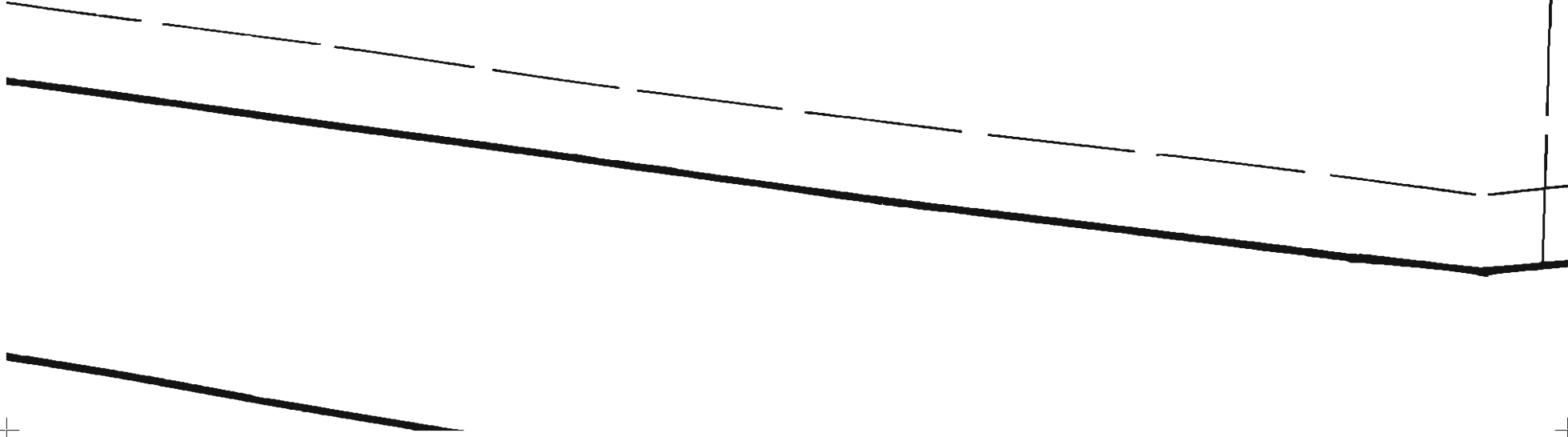

HEM LINE

Size 12

Cut 2

POCKET

HEM LINE

Seam Line

Cut Line

POCKET FLAP (BOTTOM)

Cut 2

Size 12

Seam Line

Cut Line

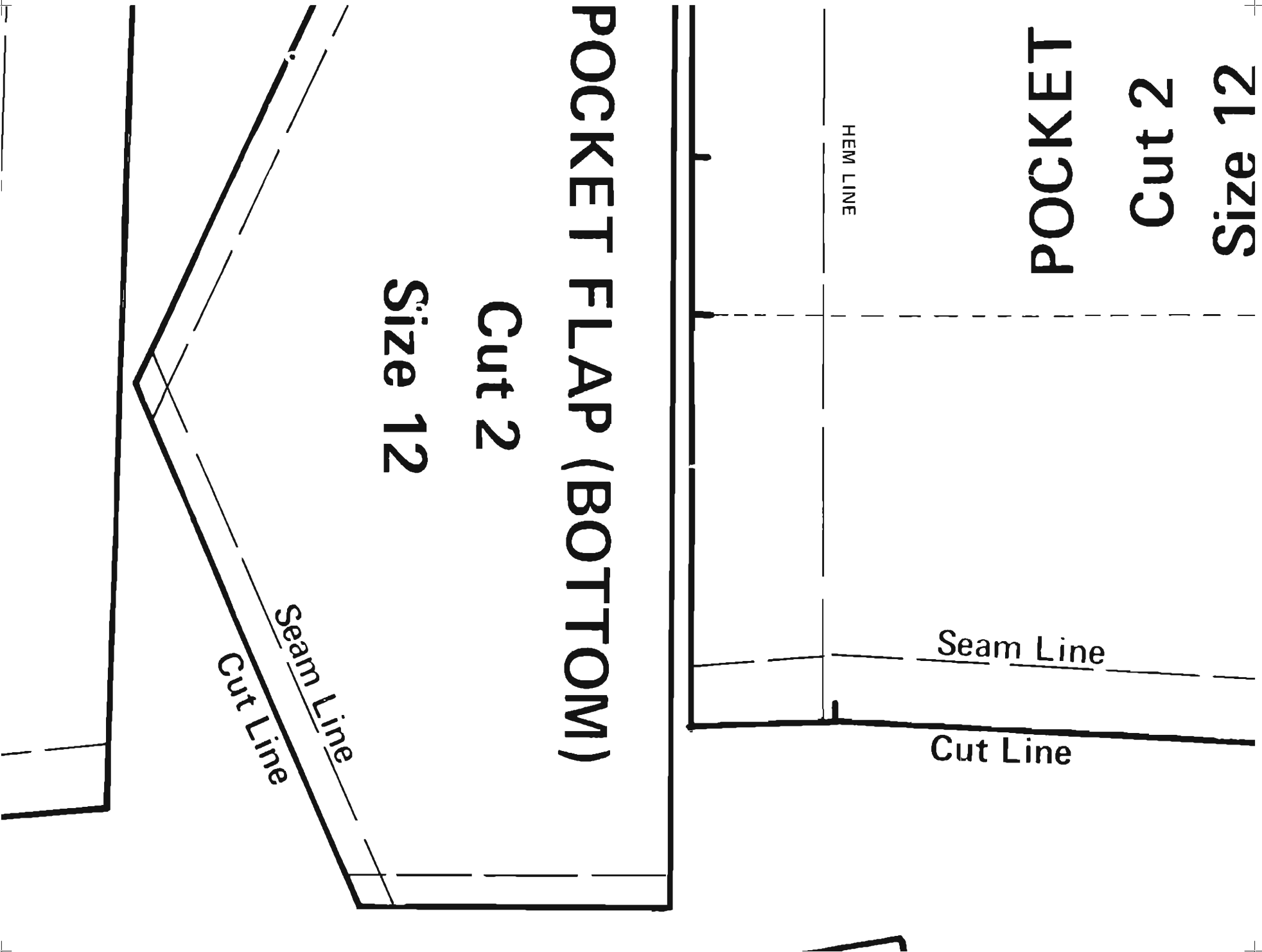

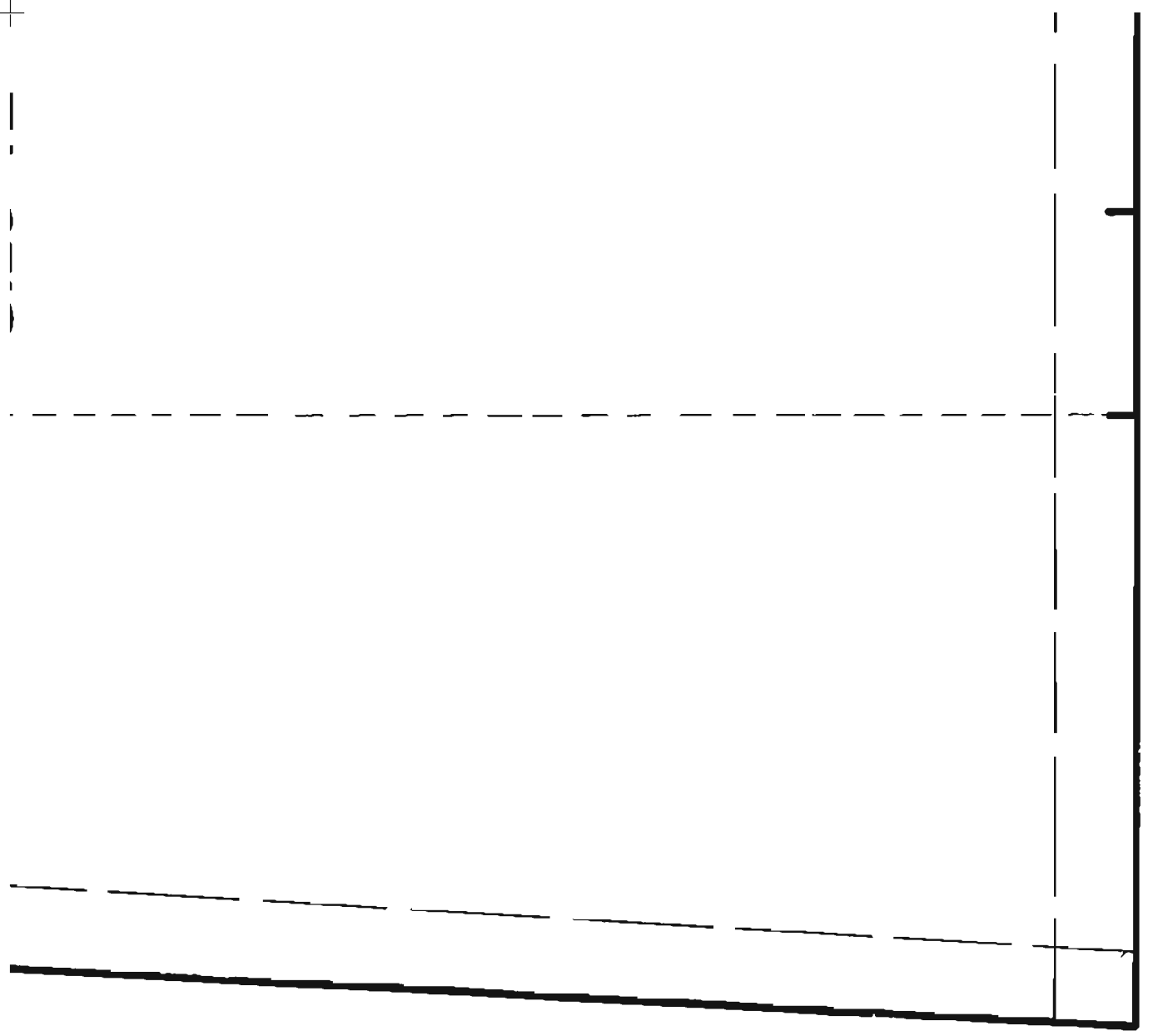

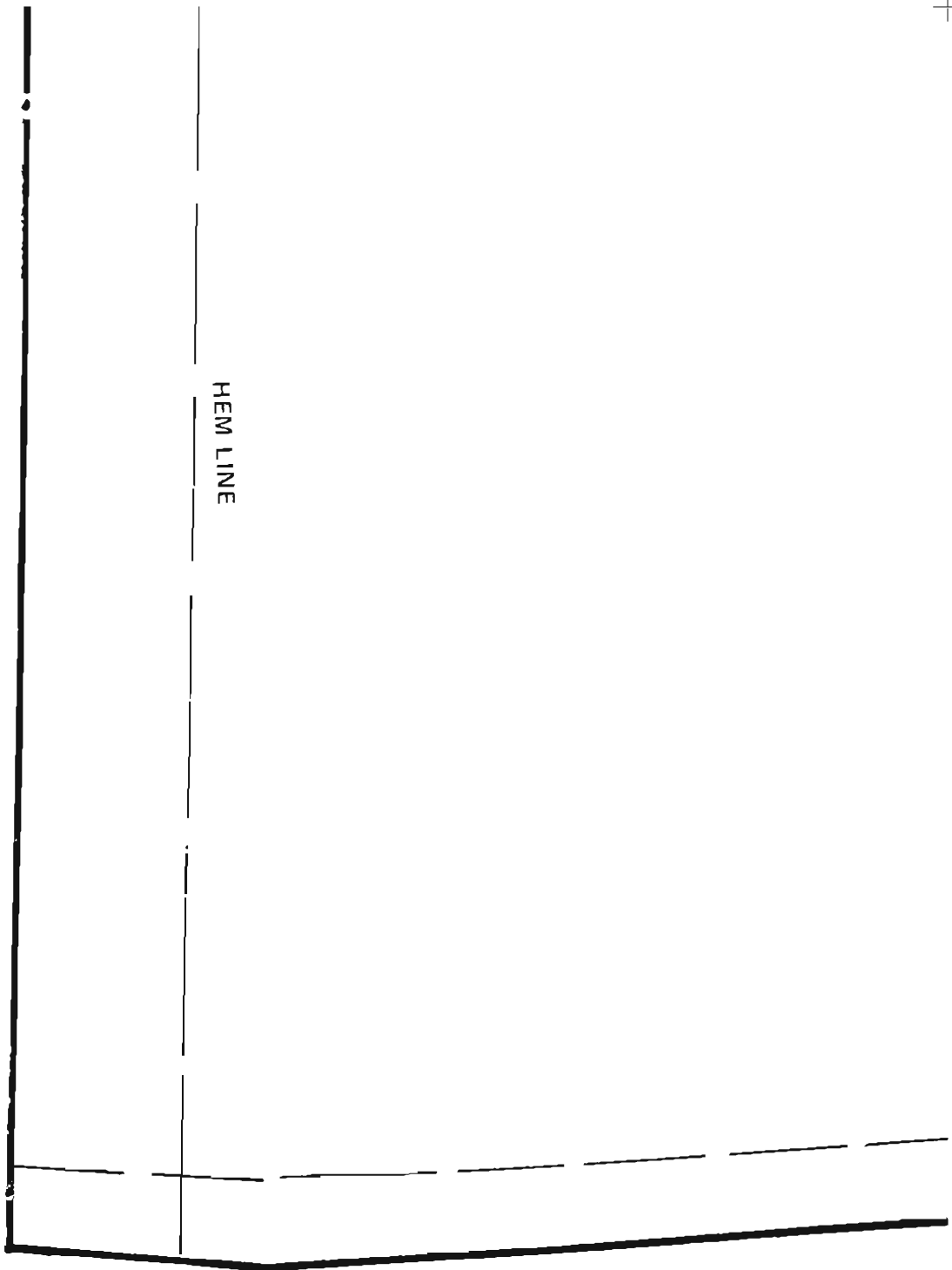

FRONT LINING

Cut 2 1 Right 1 Left

Size 12

Seam Line

Cut Line

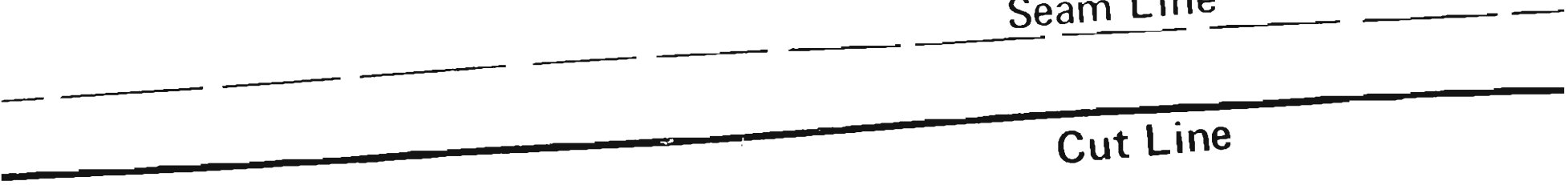

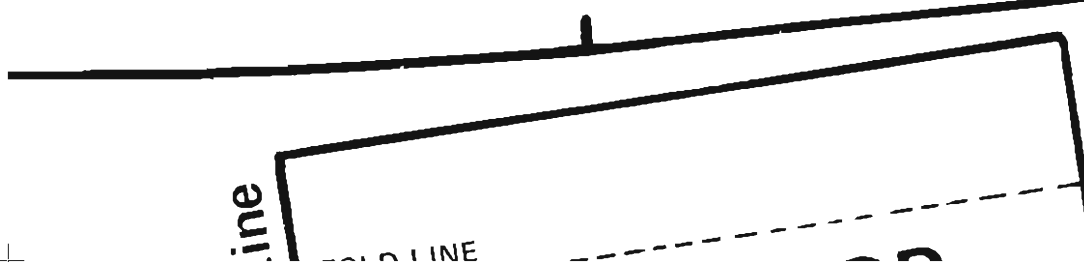
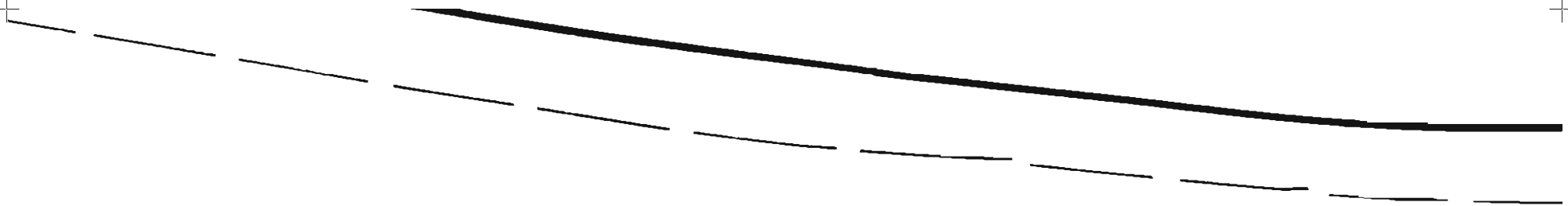

ine
LINE

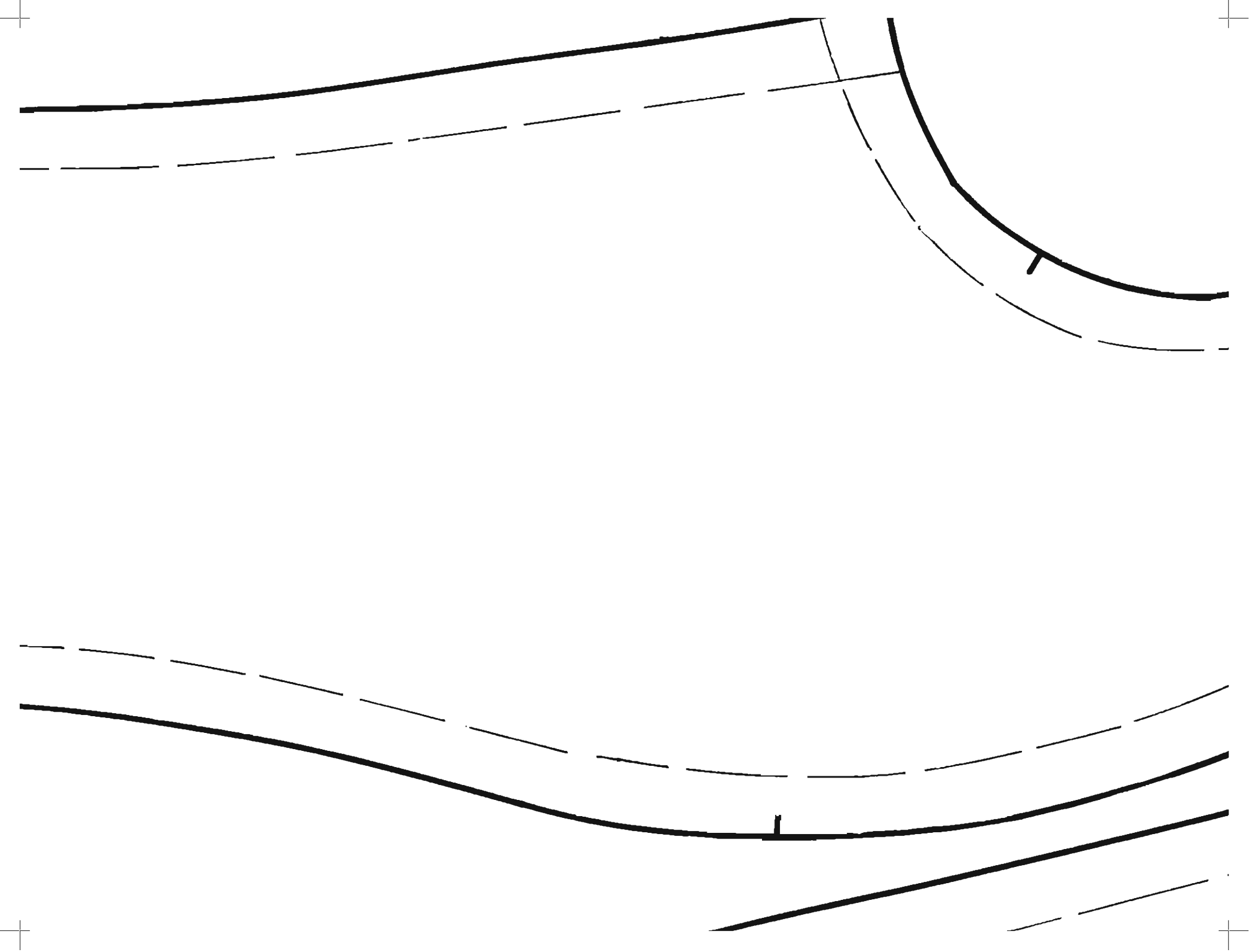

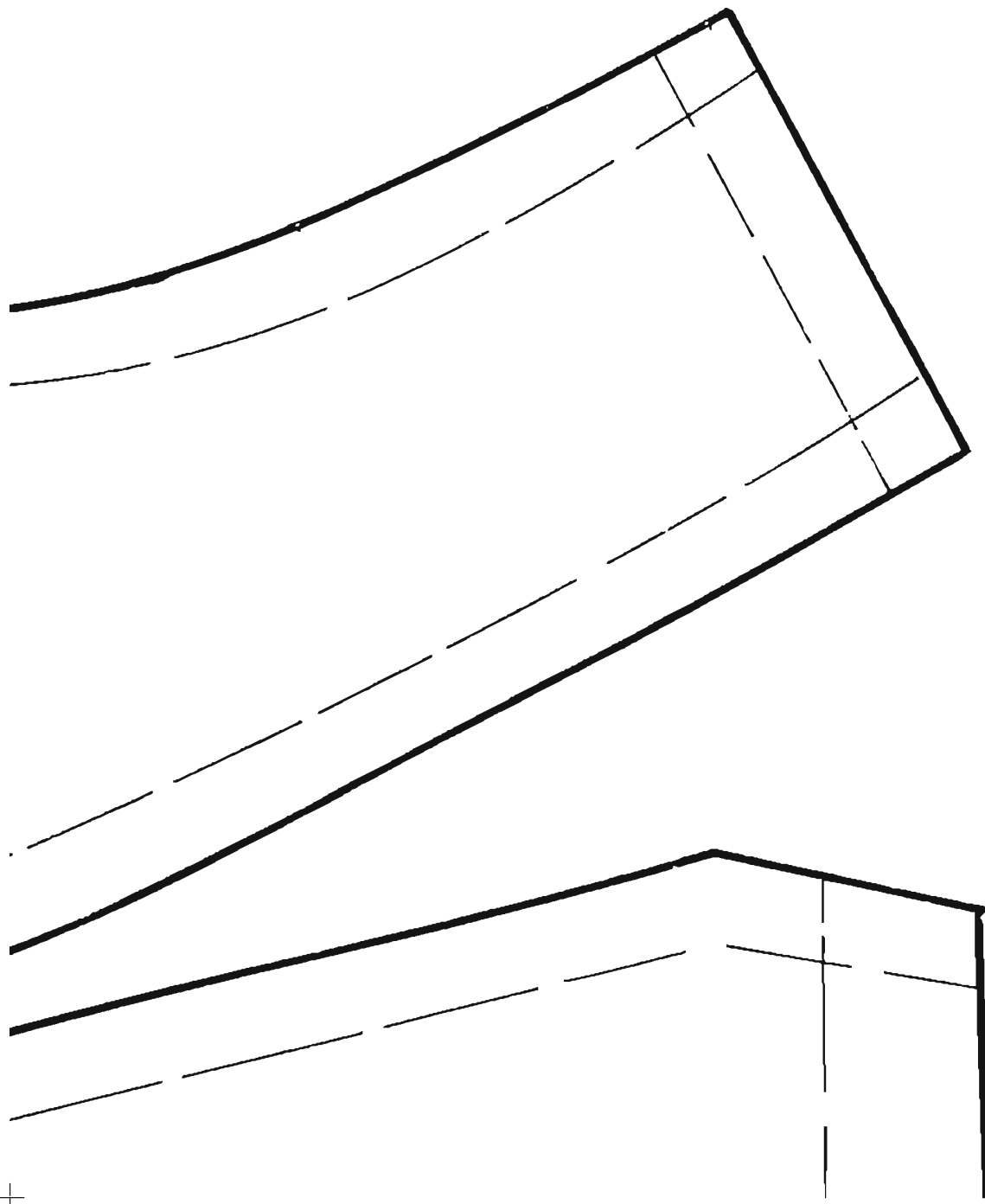

FLAP INTERFACI

Cut 2

Size 12

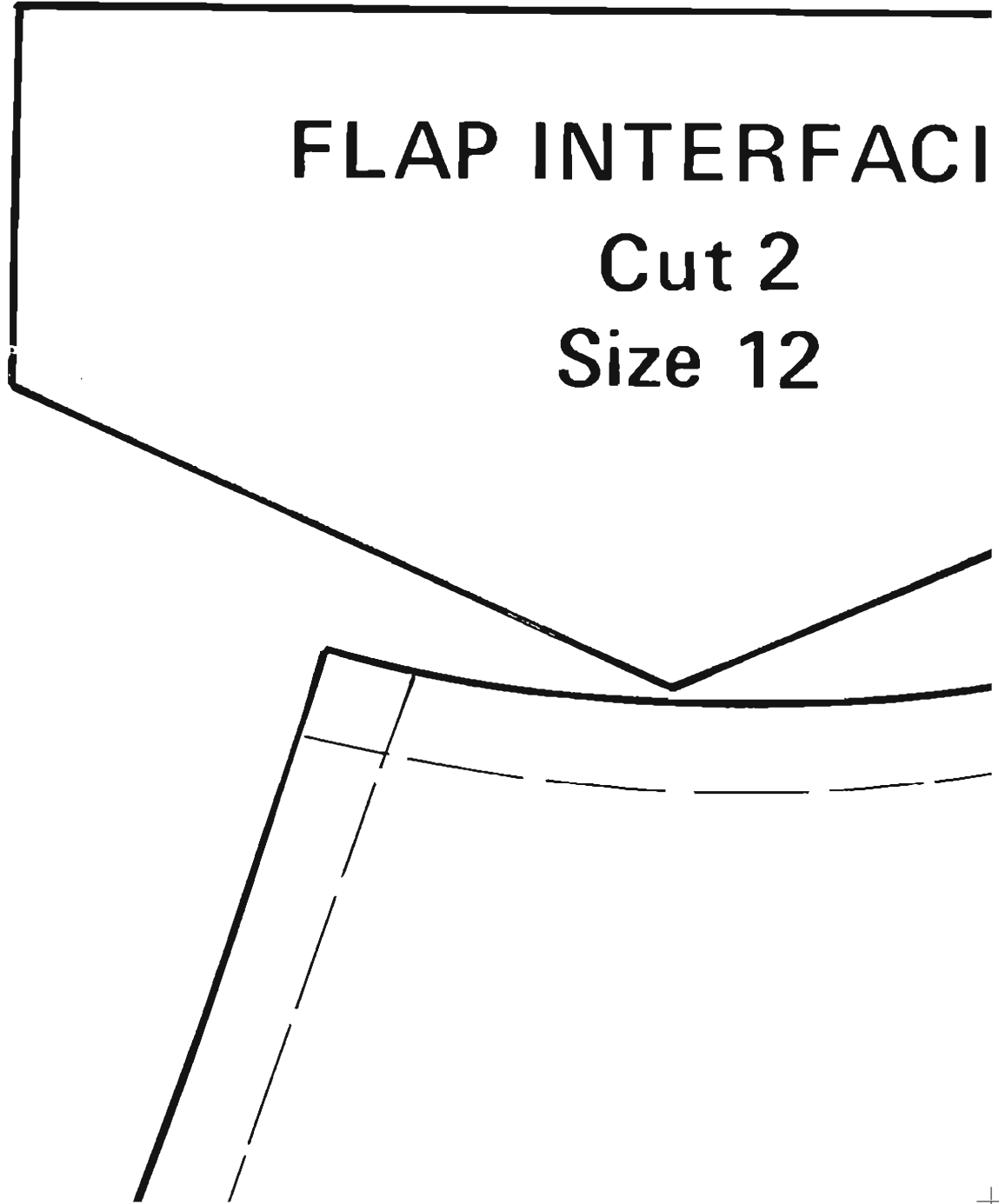

Cut Line

NG

Cut Line

Seam Line

NG

Dart Indication

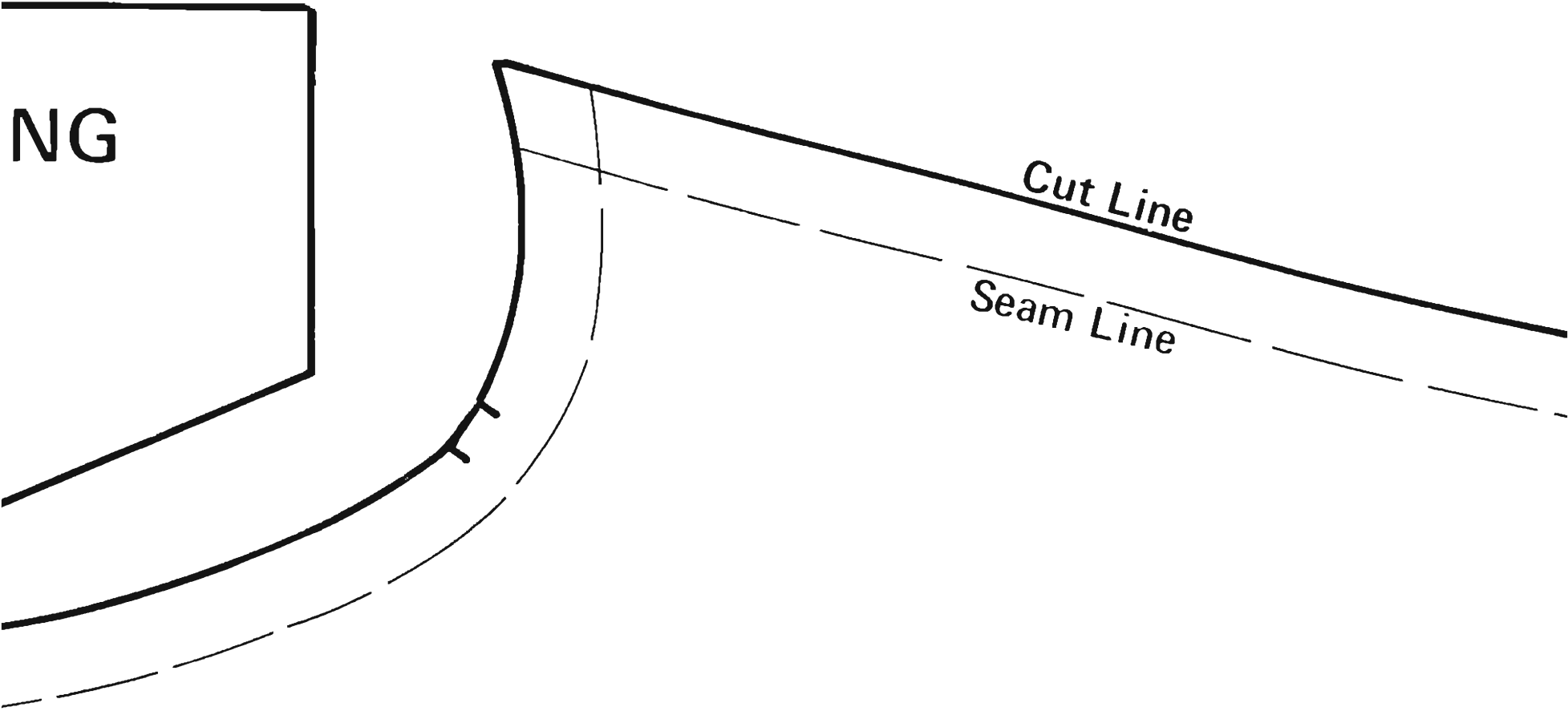

Cut L

FOLD LINE

BELT LOOP

Cut 4

Size 12



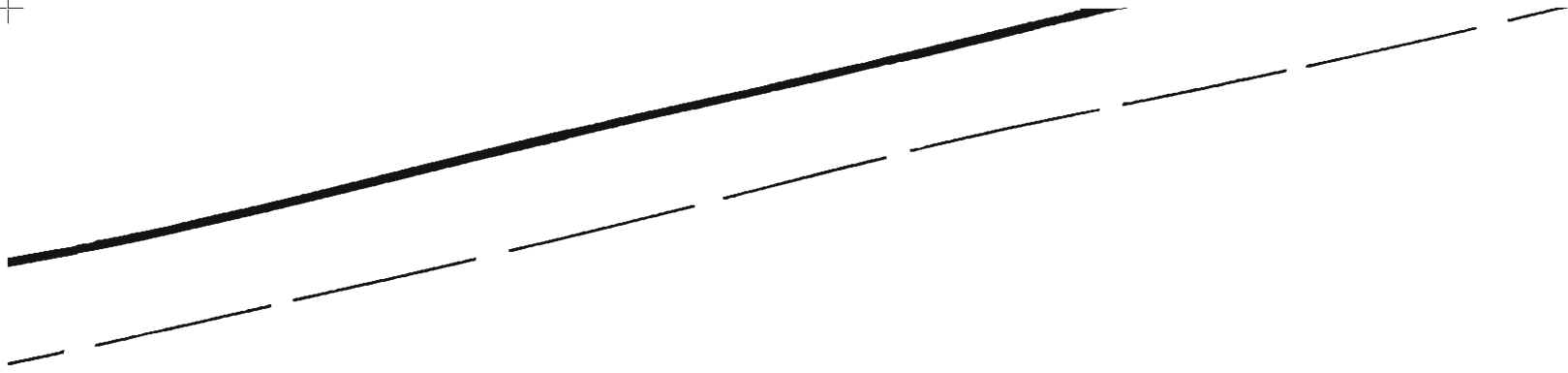

HEM LINE

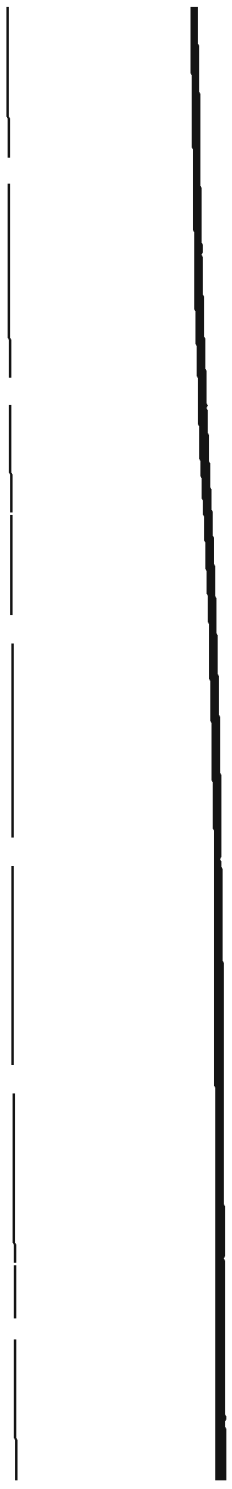

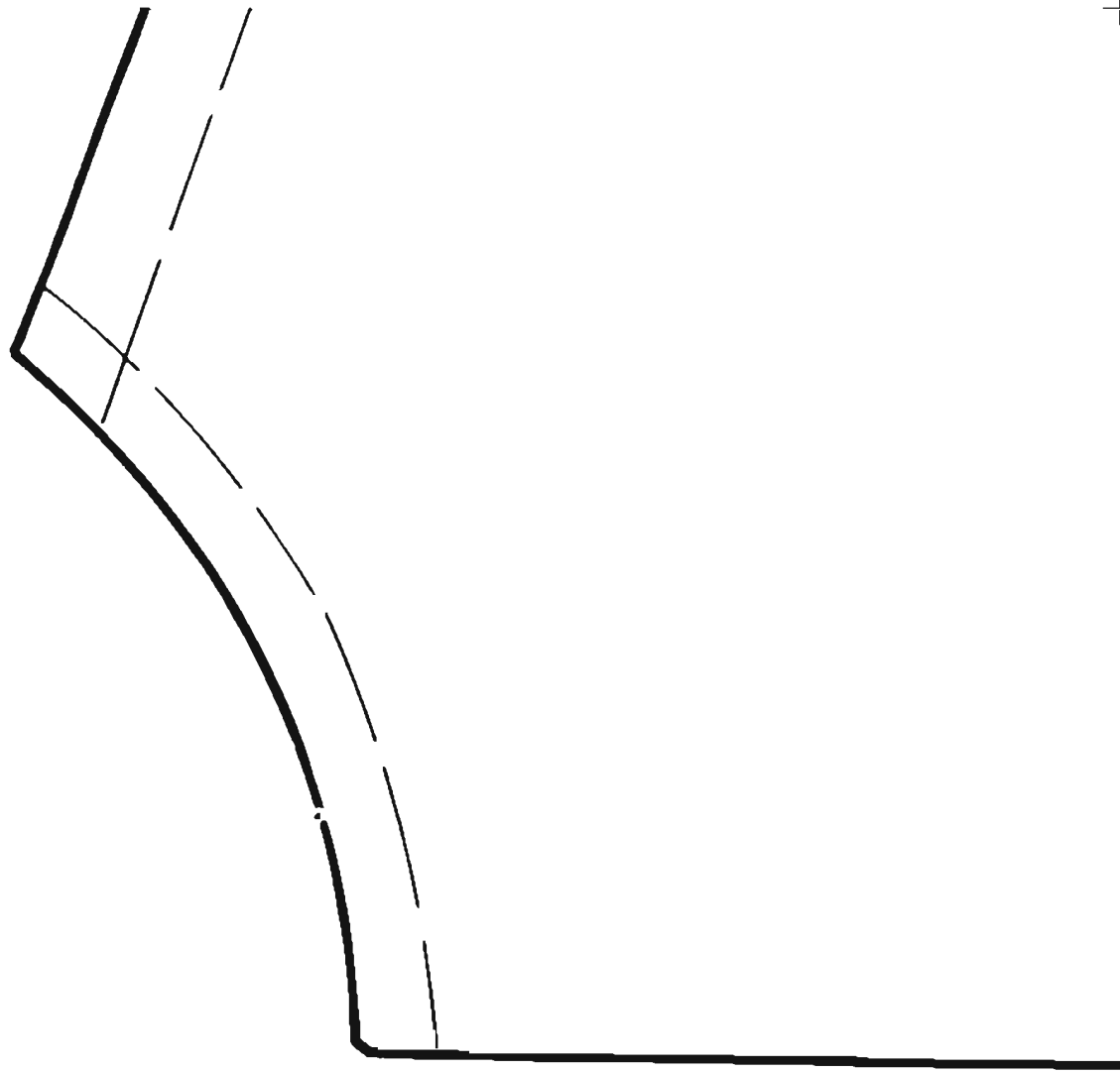

BACK LINI

Cut 1

Size 12

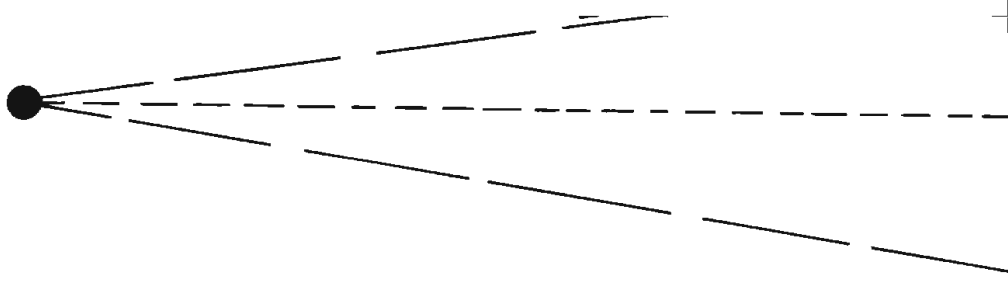

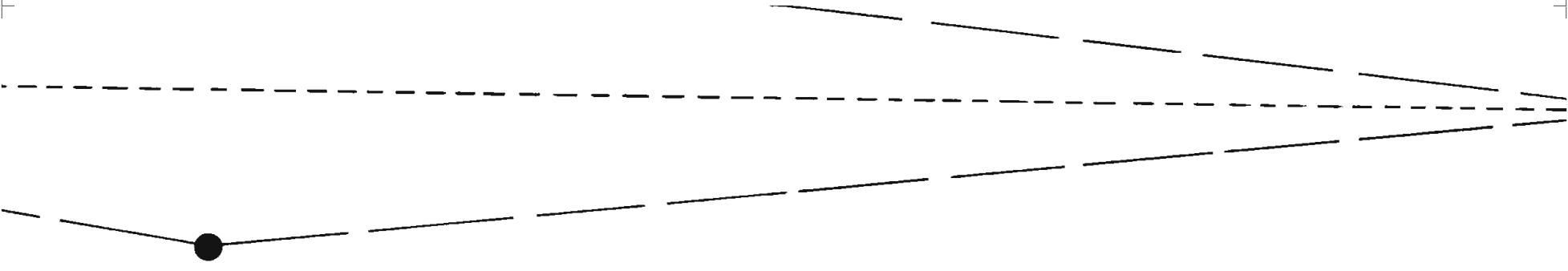

Place on Fold





