

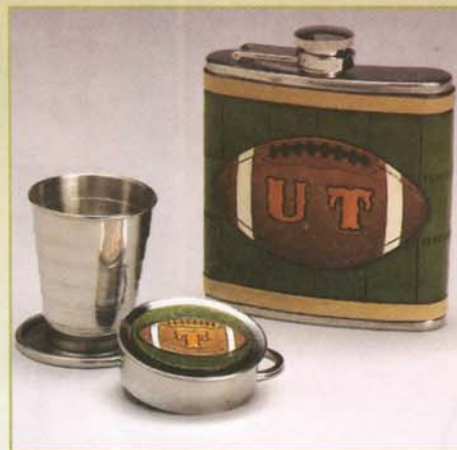

TONY LAIER

CRAFTAID® PATTERN PACK

FLASK & CUP SERIES



Floral, Sports and Oak Leaf Patterns for flask, cup tops, billfolds, checkbooks, key fobs and more

Shown: Flask #4100, Collapsible Cup #44101

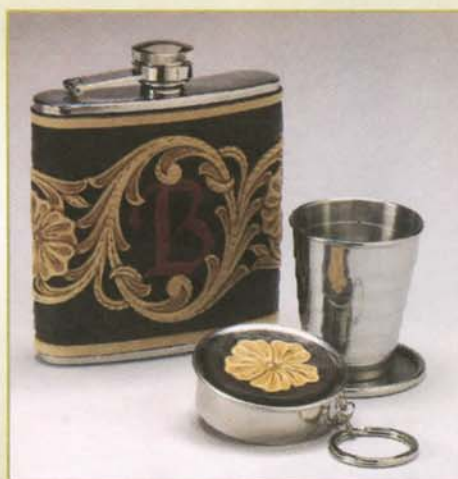

Pack contains Craftaids®, tracing patterns, tips & complete tool listings

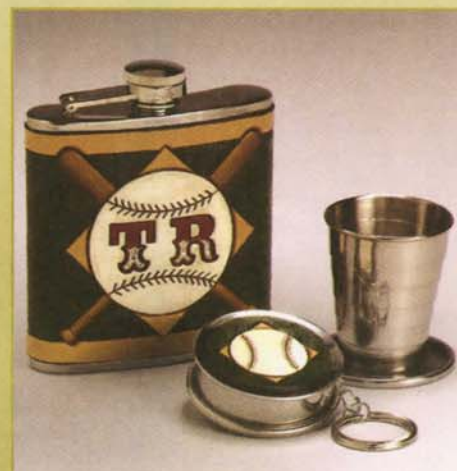



Digital Downloads

This PDF package has been put together to give you options when it comes to printing. Some PDF file downloads may contain some documents larger than an 8-1/2" x 11" image. Pages and patterns that are larger than 8½x11 have been provided in two formats:

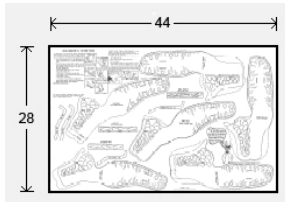

Full Size: If you would like to have a full size print out, take the full size pages to your local print shop and they can print it for you.

Tiled: The tiled pages give you the option of printing the larger patterns at home. You print the tiled pages and then assemble them to make the larger patterns.

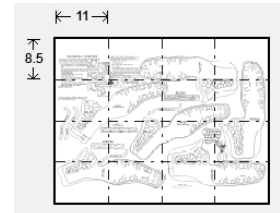

Pattern PDF files are typically laid out as follows: Cover (if applicable), instructions sheets (if applicable), pattern 1 – full sized, pattern 1 – tiled, pattern 2 – full sized, pattern 2 – tiled, pattern 3 – full sized, pattern 3 – tiled. ...Etc.

Doodle Page PDF files are typically laid out as follows: Front – full sized, front – tiled, back – full sized, back – tiled (Some Doodle Pages do not have backs).

Craftaid PDF files contain 1 (one) full Craftaid pattern or Craftaid pattern pack that has been converted into a tracing pattern. All pages in the PDF are full sized. This means that you may have to take the PDF to a print shop for certain oversized Craftaid patterns if your home printer cannot print the larger pages. **NOTE: These digitized patterns do not include any of the physical plastic templates (Craftaids) that may be mentioned, nor does the purchase of this PDF file imply a promise to receive any physical plastic templates (Craftaids).**

NOTE: Digital kit patterns do not include any kit parts that they may reference.

Please note: When printing on a home printer, use the settings seen on the image to the right in the Page Handling area of the Adobe Reader print dialogue box. If your printer is cutting edges off, set "Page Scaling" to "Shrink to Printable Area". This will, however, decrease the size of the pattern a very small amount.

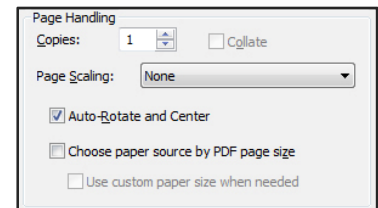

NOTE: Some patterns may reference tools, and other items no longer available.

NOTE: You may take this PDF file to your local print shop to have the full-size pages printed for your own personal use.

This premium has been published by Tandy Leather Factory, 1900 South East Loop 820, Ft. Worth, TX 76140. Copyright © 2011 by Tandy Leather Factory, all rights reserved. The contents of this publication may not be reproduced either in whole or in part without the consent of the copyright owner.

Please respect the copyright by not forwarding or distributing this document.

ABOUT THE ARTIST

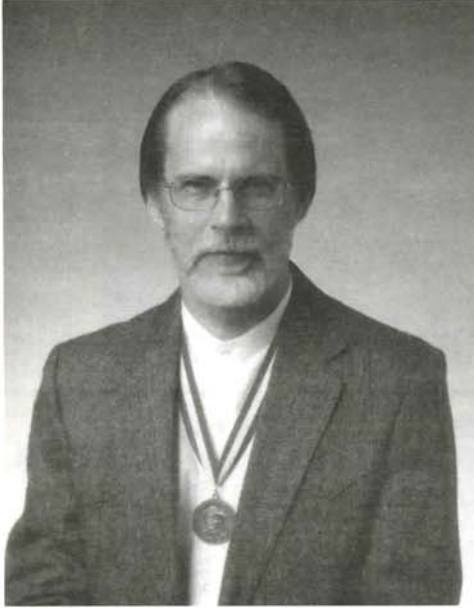

TONY LAIER (*Thomas Anthony Laier*)

Tony, the current Director of Research and Development for The Leather Factory and Tandy Leather Company, has over 30 Years experience in the Leather Industry, as leather artist, designer, writer and teacher. His devoted interests and studies of nature, history, archeology, and Native American culture enhance his skills in all aspects of leatherwork. Recipient of the honored Al Stohlman Award for Achievement in Leathercraft in 1999, Tony now serves on the Board of Trustees for the Al & Ann Stohlman Foundation with the determination to further strengthen the future of Leatherwork through example and teaching.

Look for more *Craftaid*[®] Pattern Packs
by Tony Laier



DISTRIBUTED BY:
Fort Worth, TX 76105
www.leatherfactory.com
www.tandy.com

CRAFTAID® PATTERN PACK #76002-02

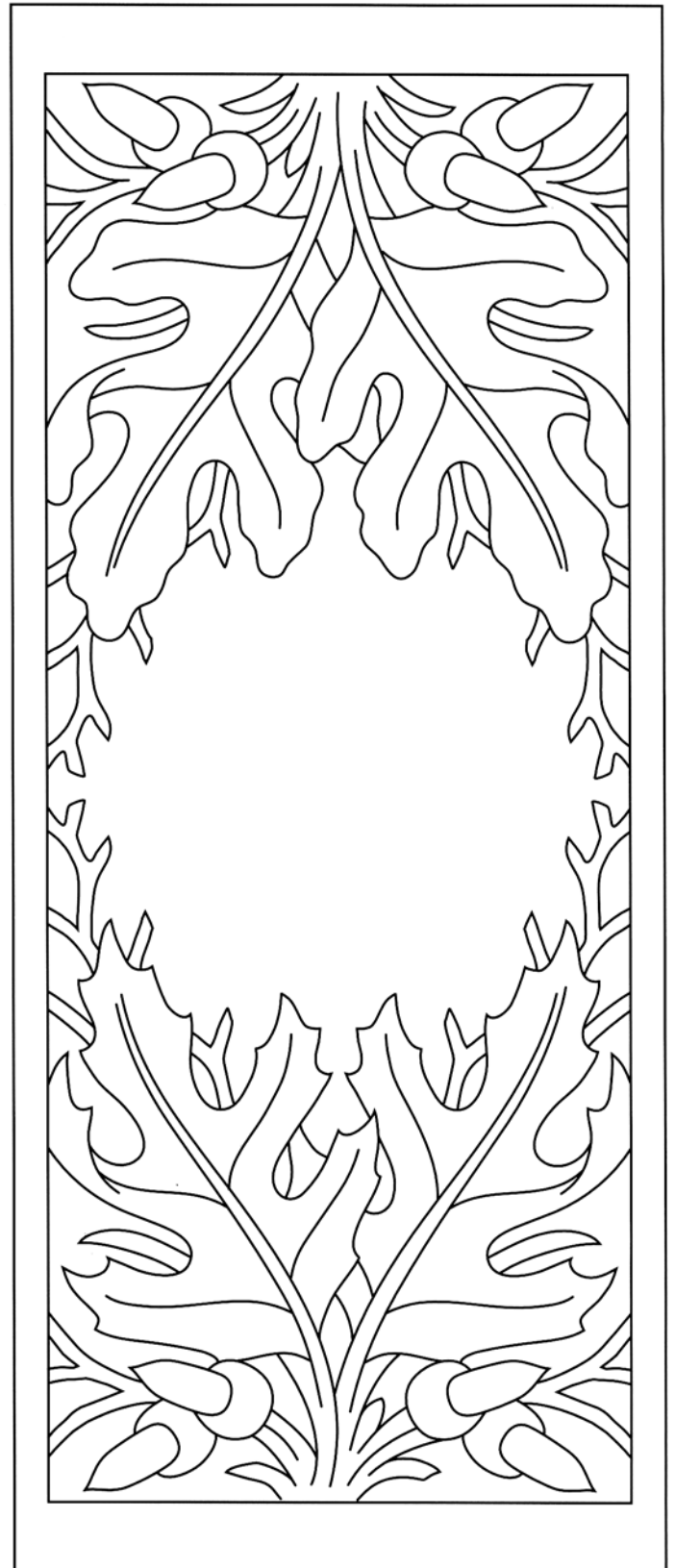
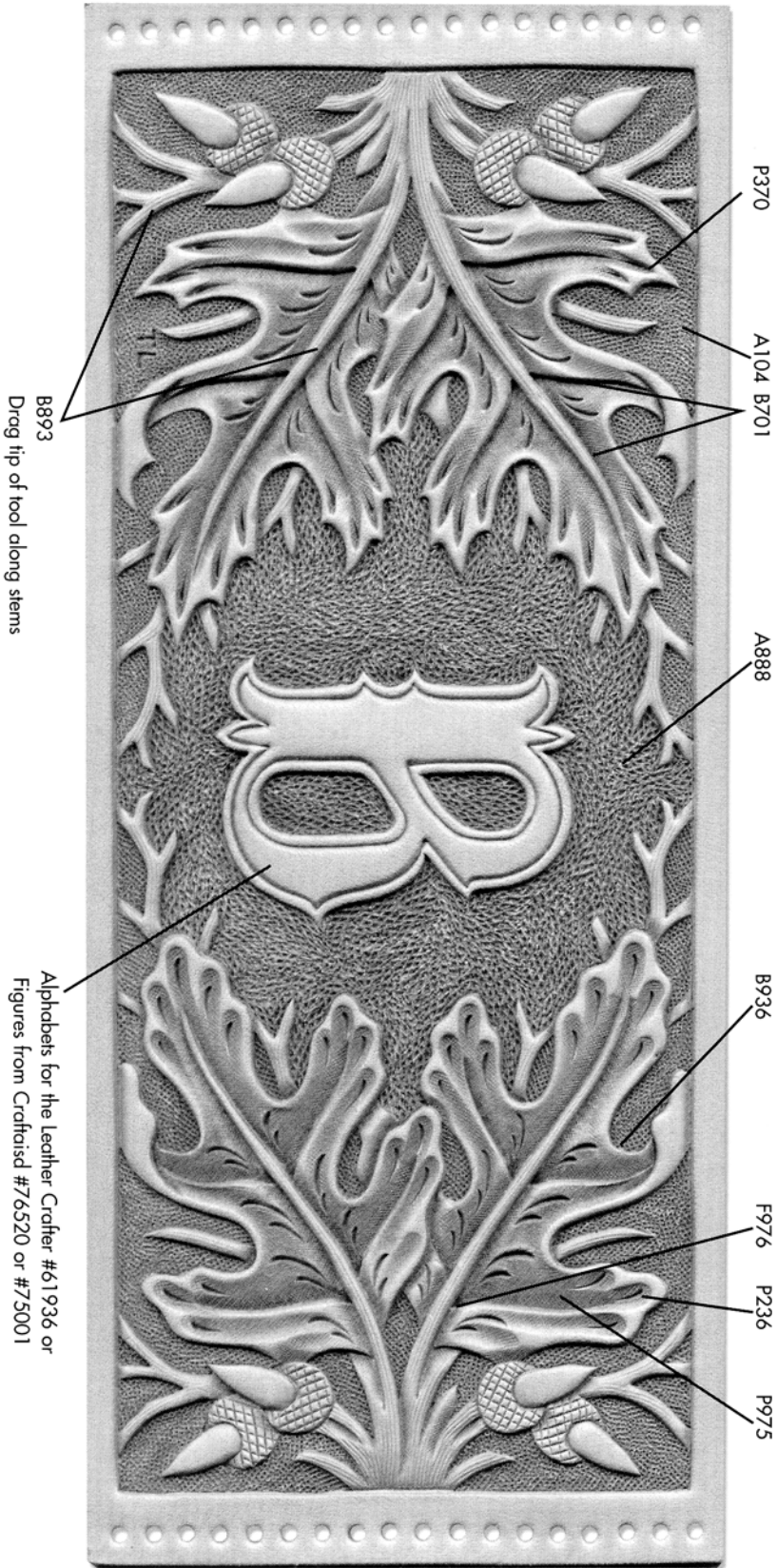

** This pattern includes pointed and round lobed oak leaves. Use "as is" with both types of leaves or use only one type of leaf, then flop Craftaid to complete the other side.*

CRAFTAID® PATTERN PACK #76002-02

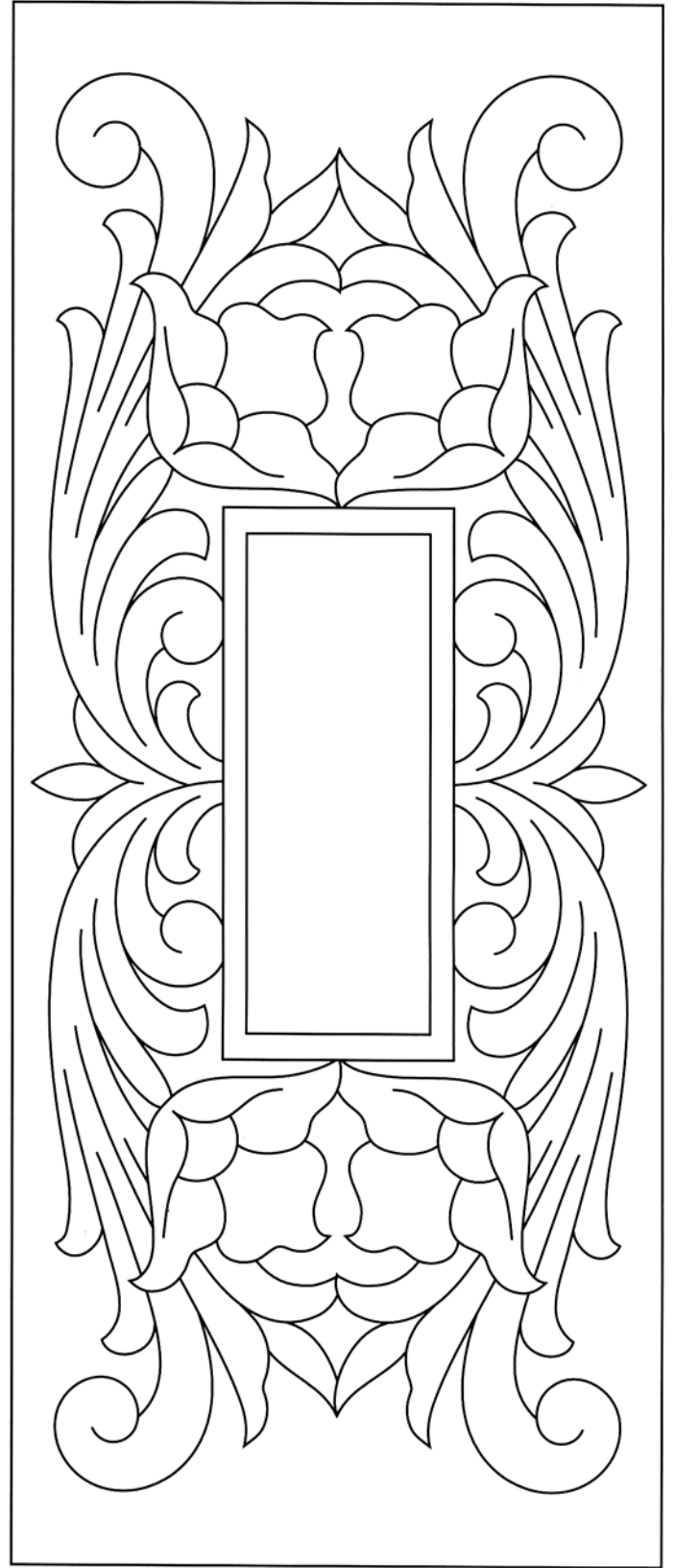
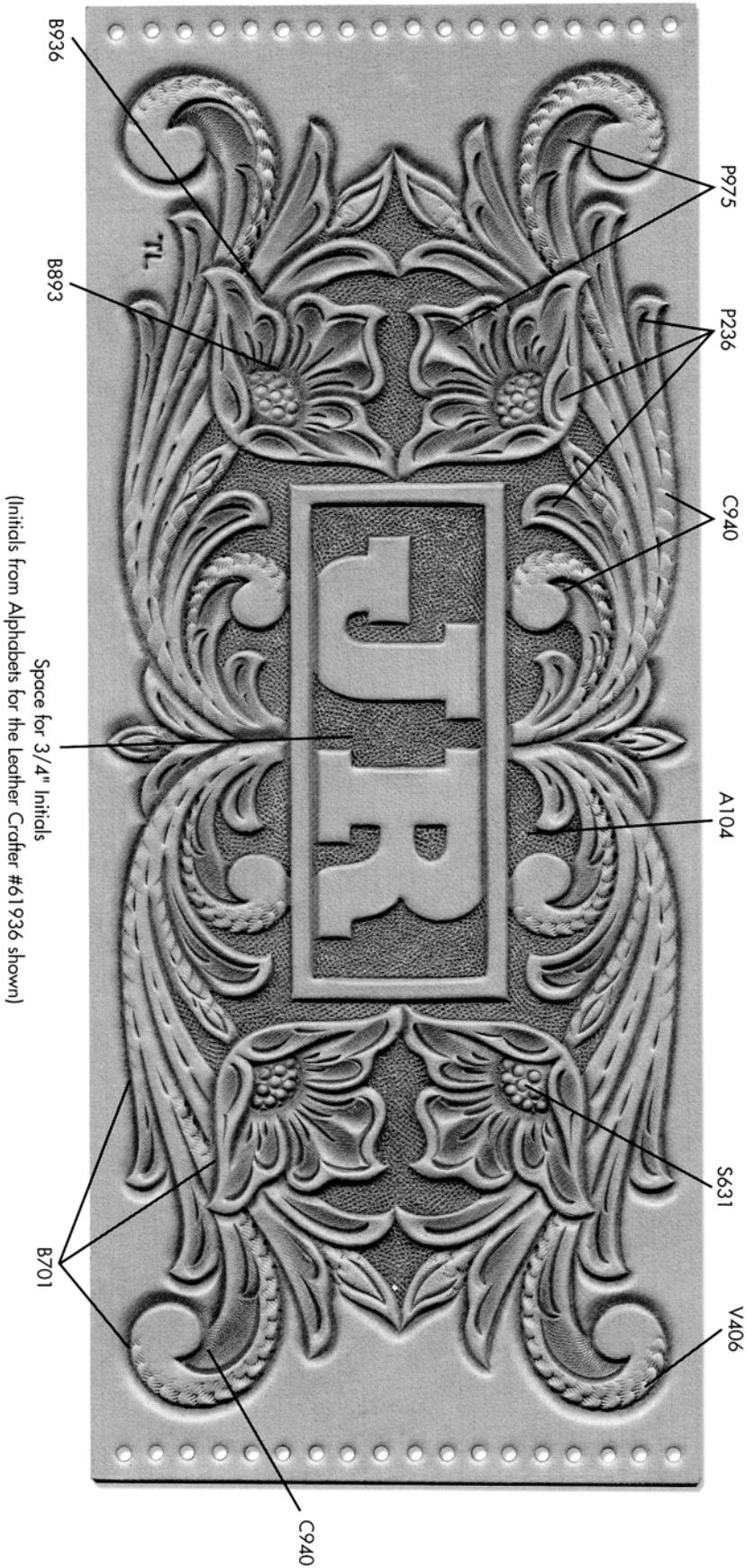

CRAFTAID® PATTERN PACK #76002-02

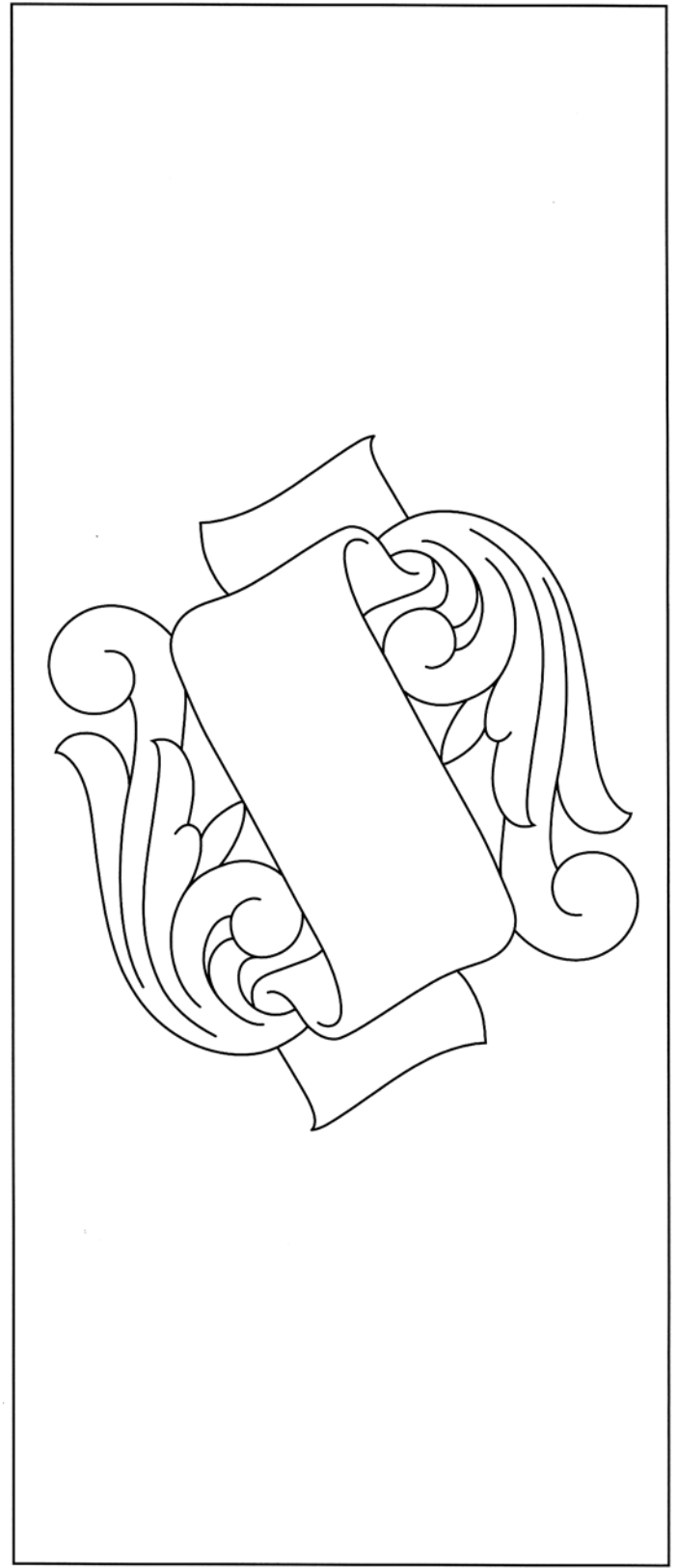
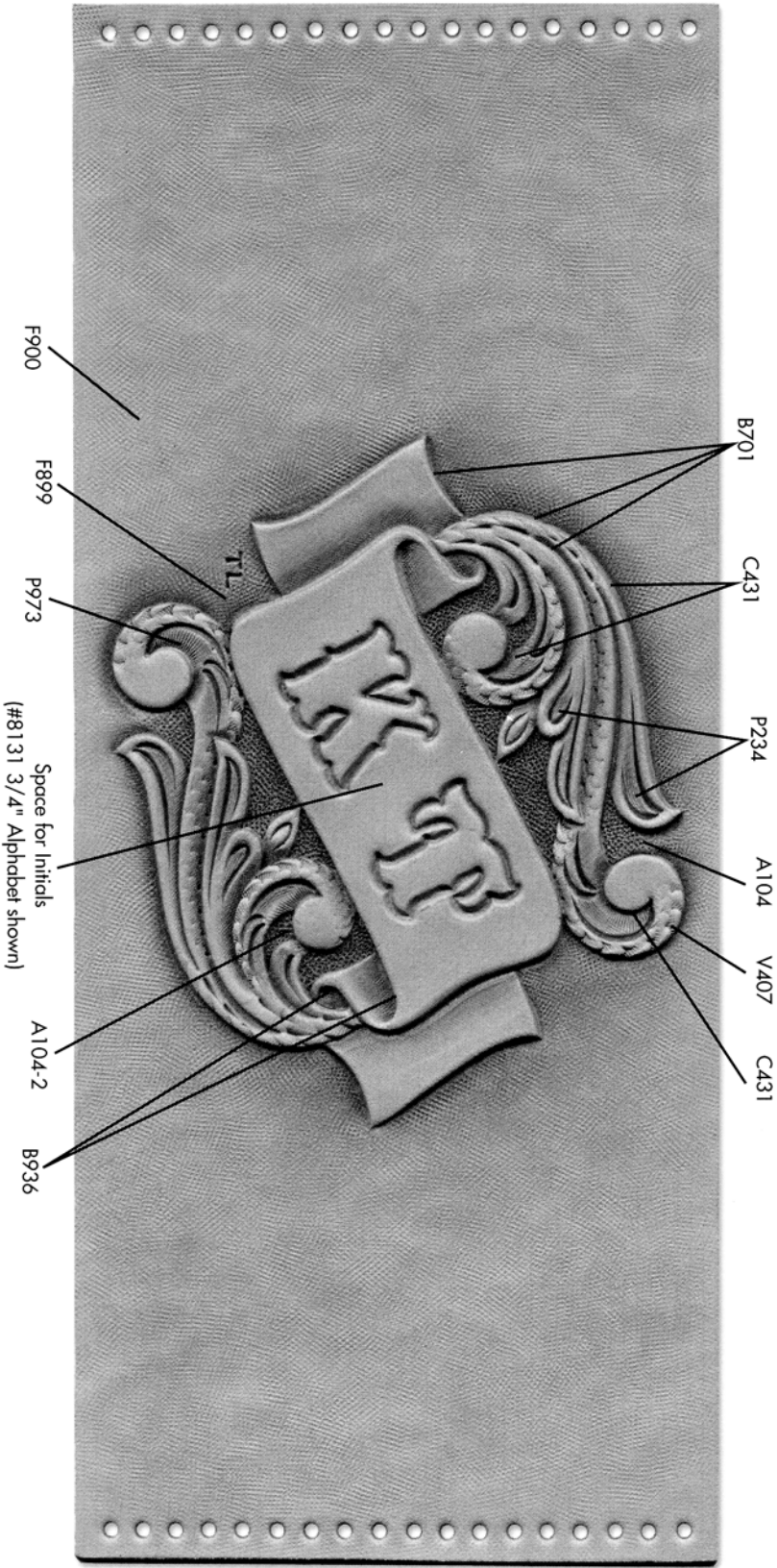

CRAFTAID® PATTERN PACK #76002-02

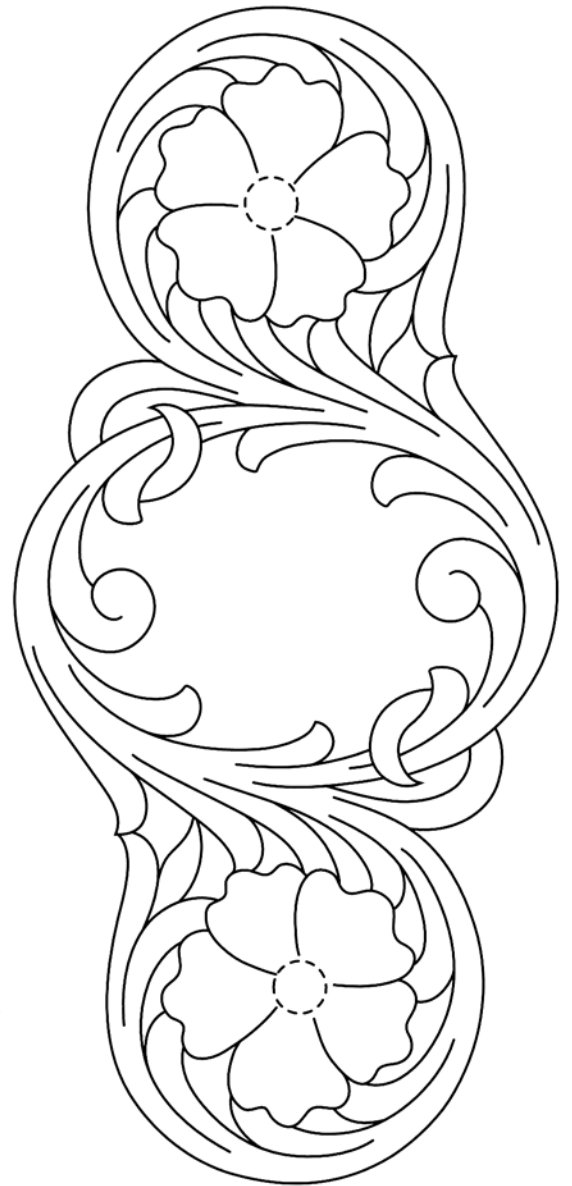
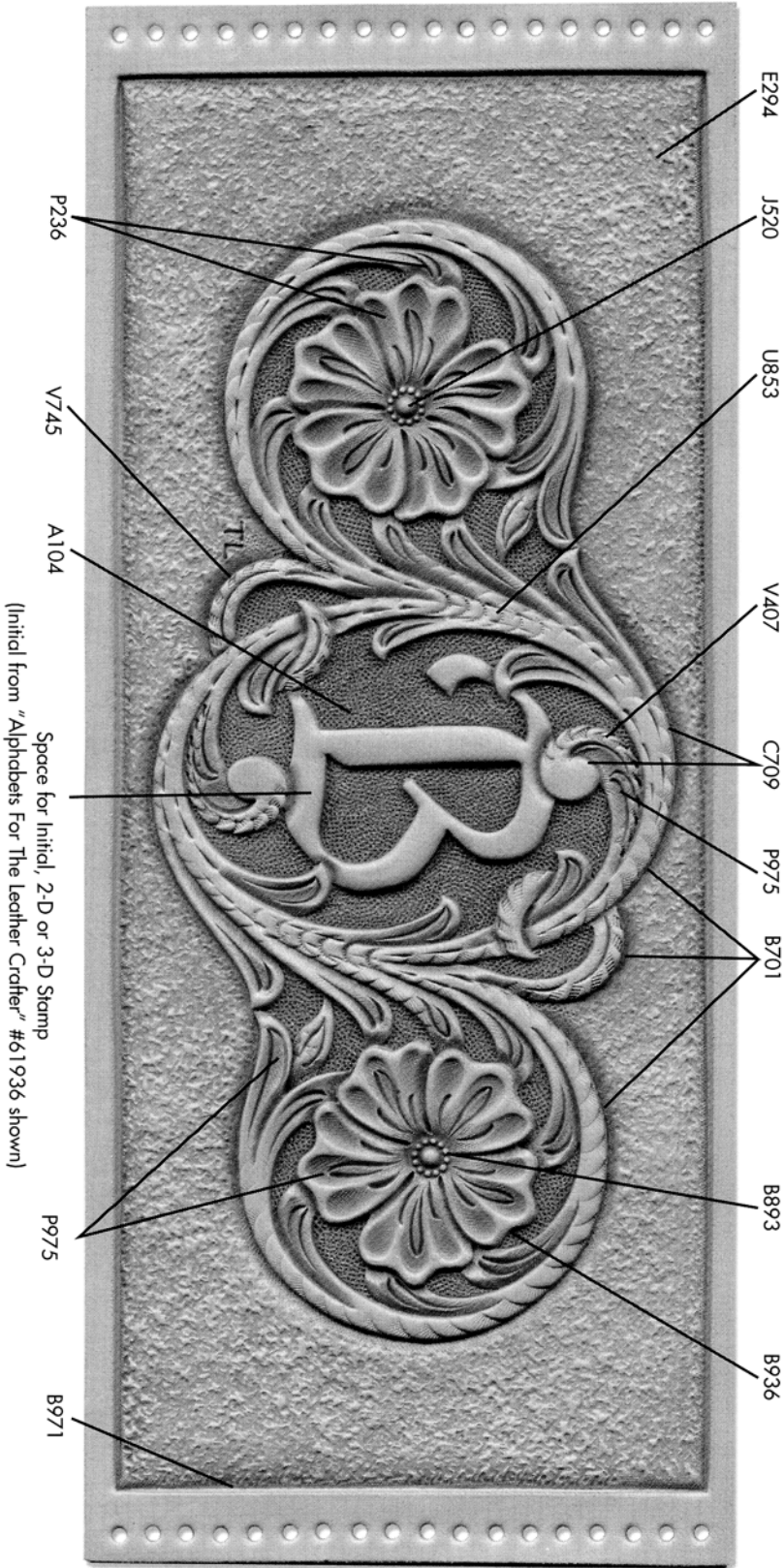

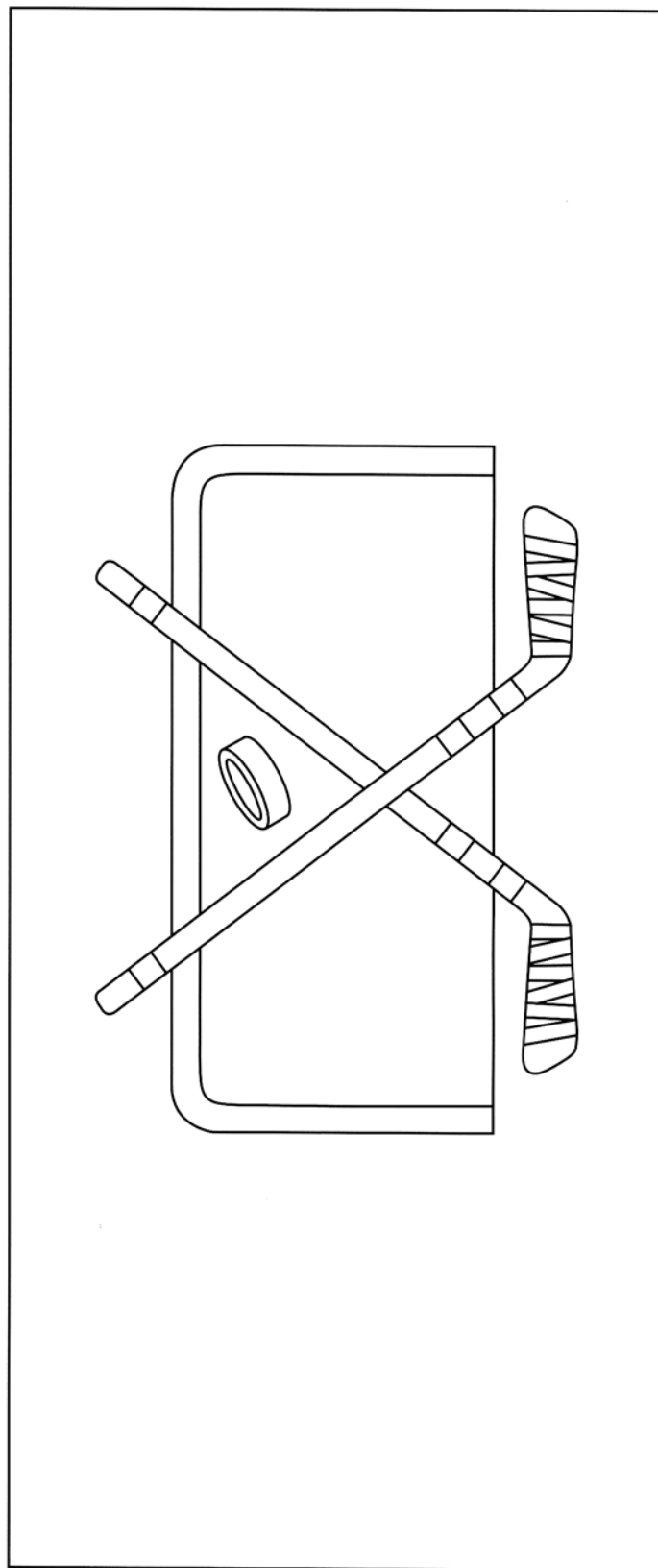
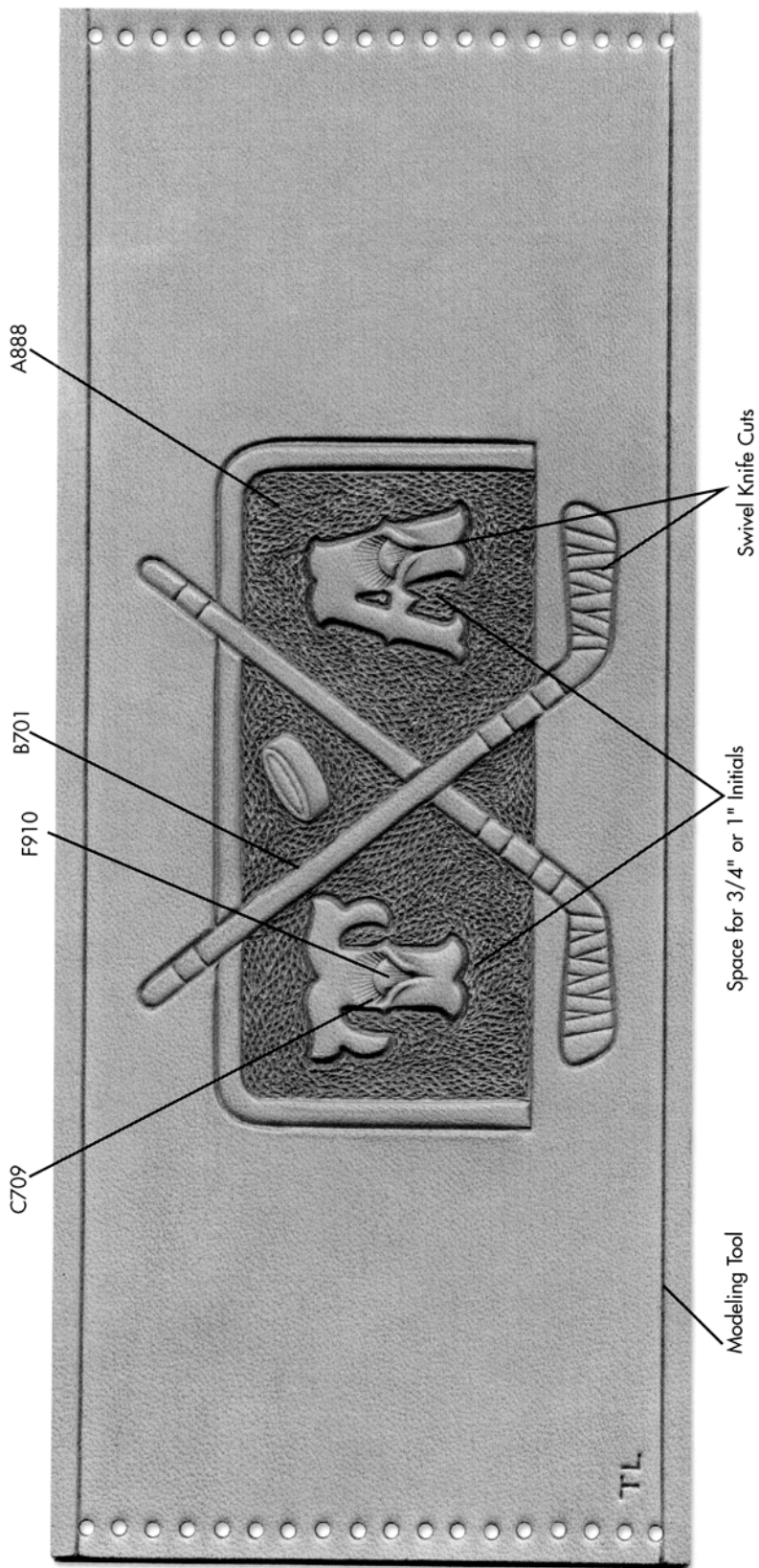

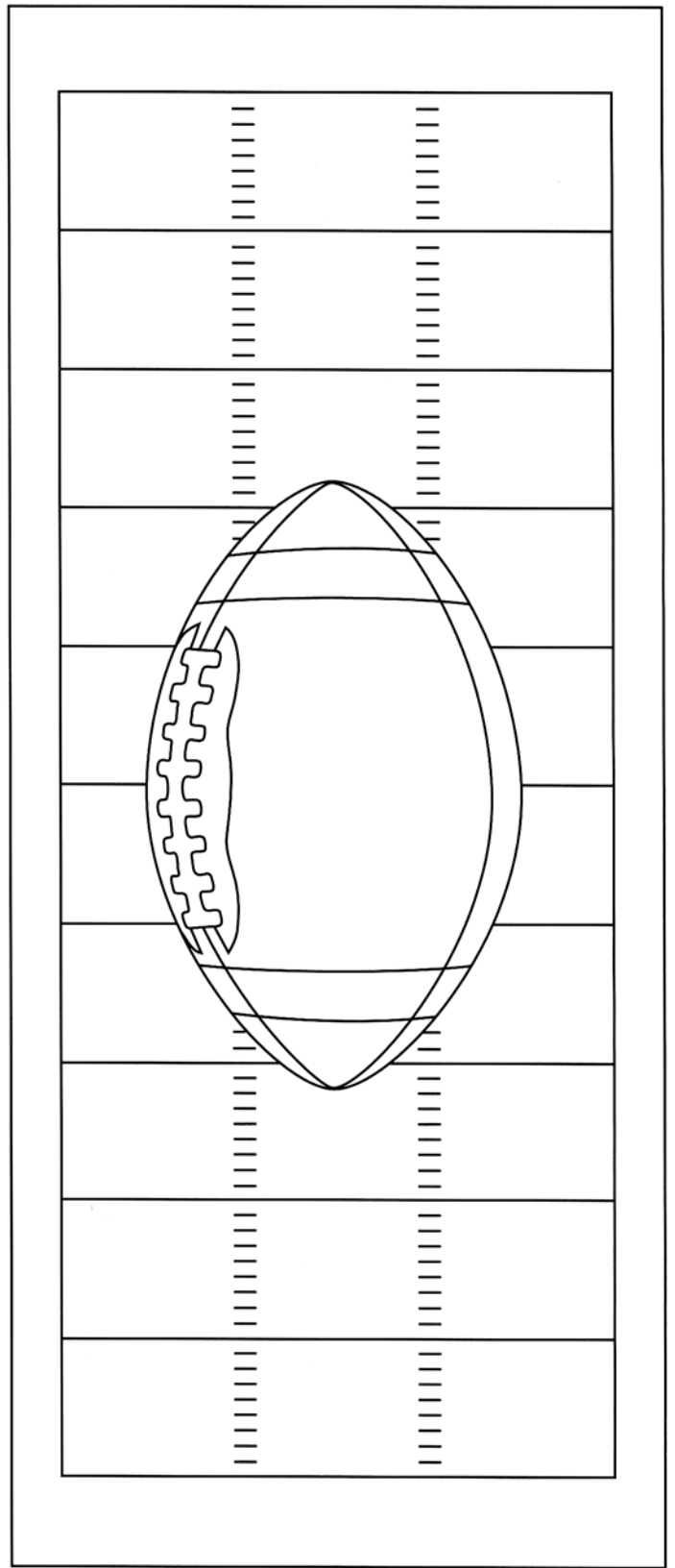
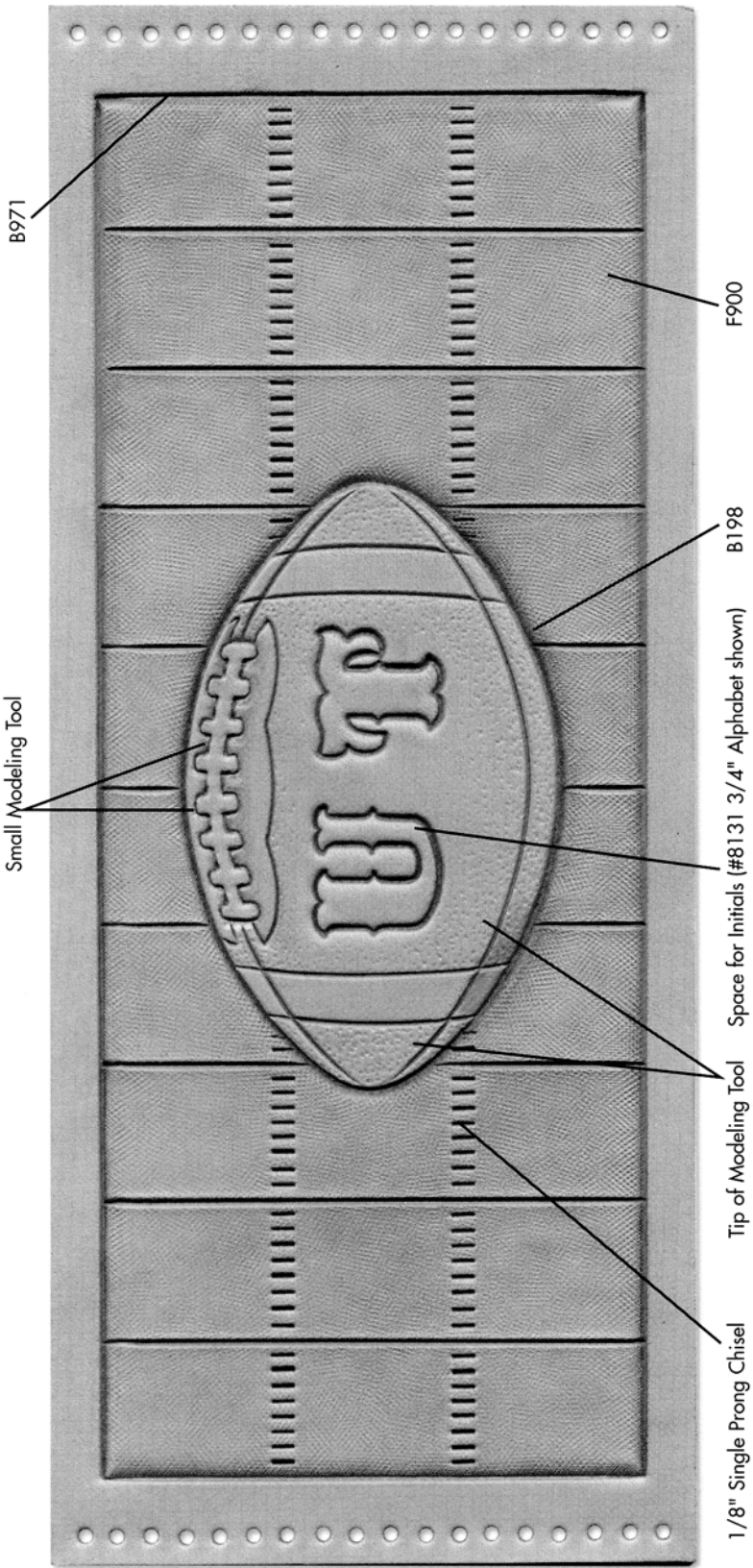

CRAFTAID® PATTERN PACK #76002-02

