

CRUSADER-STYLE SHOULDER SWORD HOLDER

Design by George Hurst. Pattern is reproduced at 100%.
 Visit www.tandy.com for all the supplies needed to complete this project.
 Visit www.LeadercraftLibrary.com for more great carving patterns.

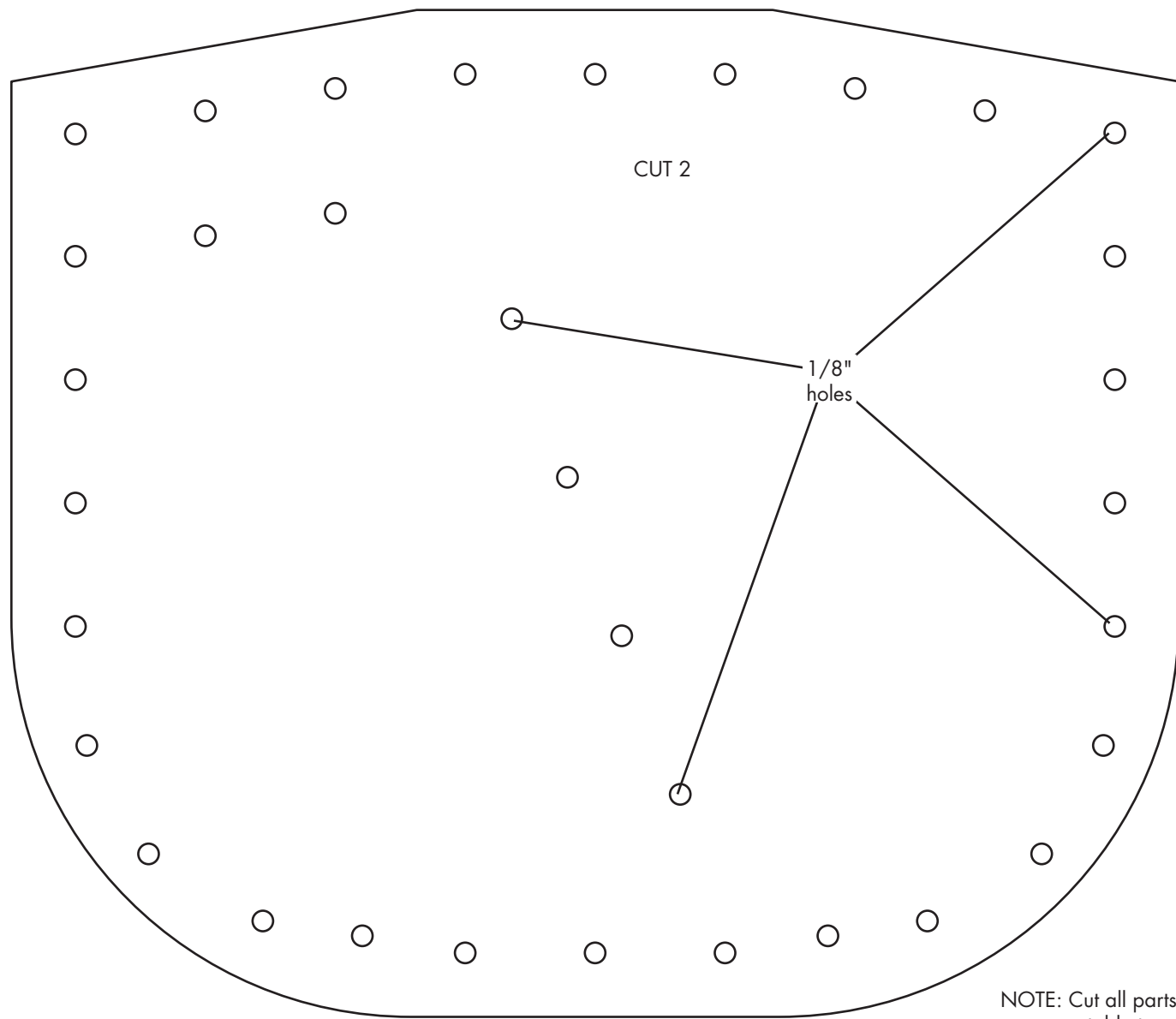

NOTE: Cut all parts from 6 to 7 oz. vegetable tanned cowhide

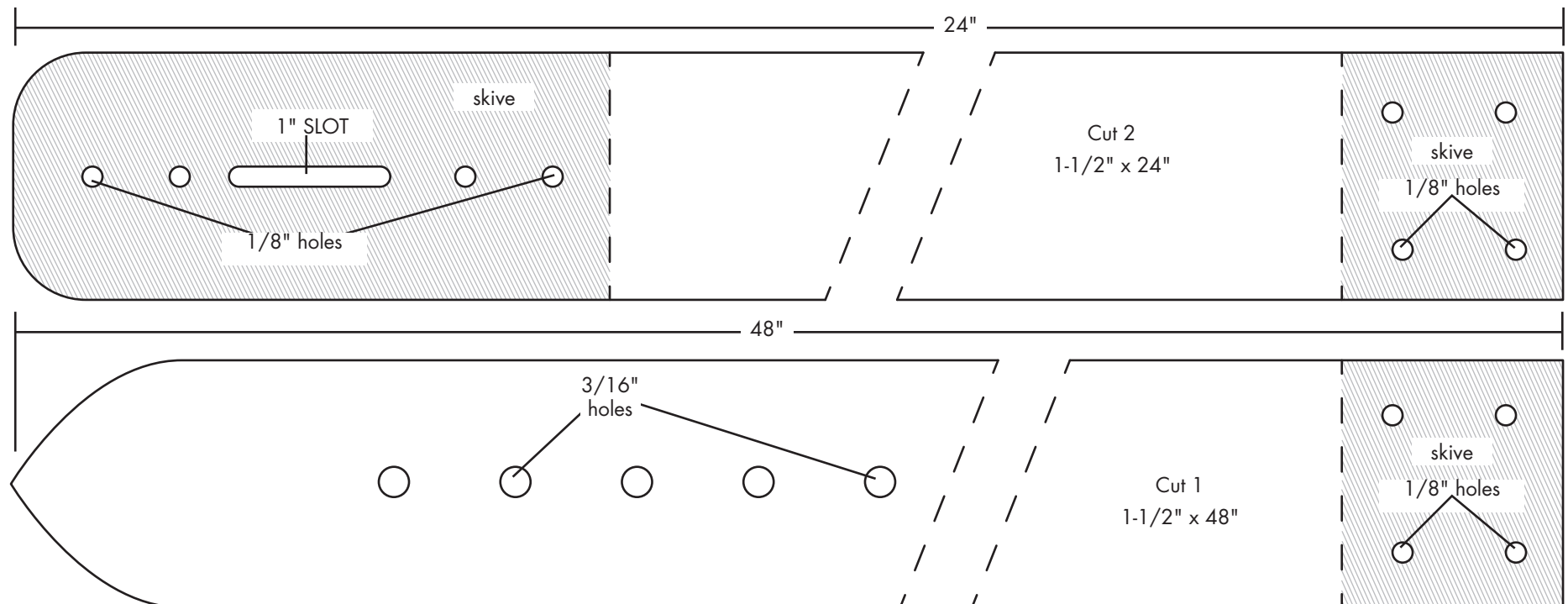
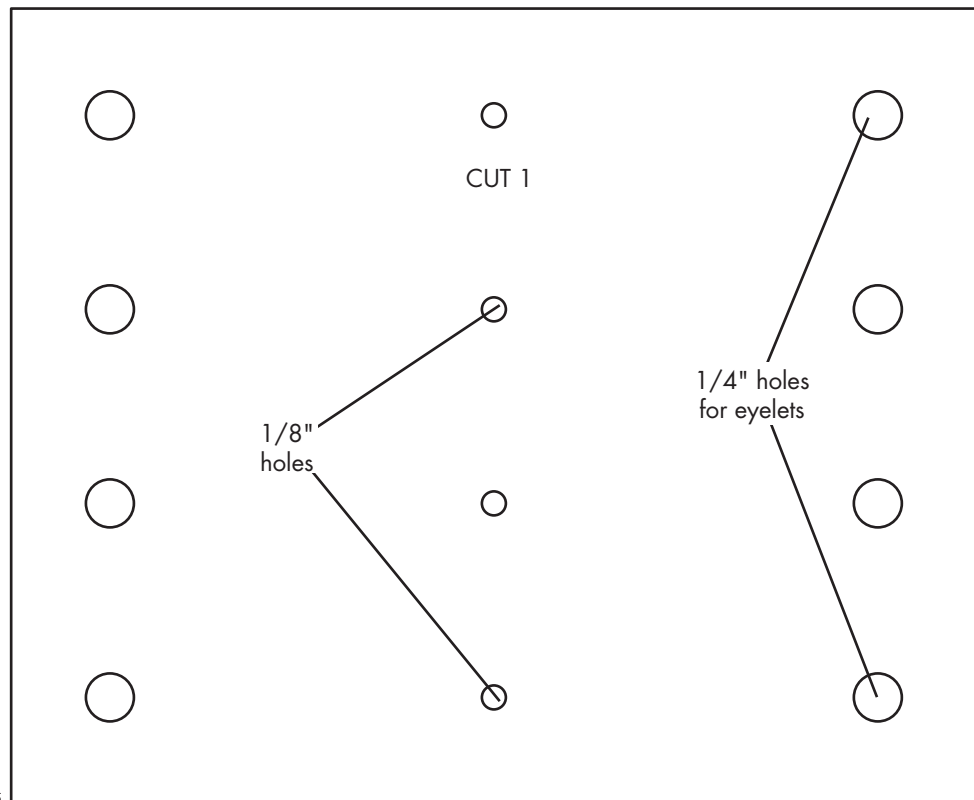

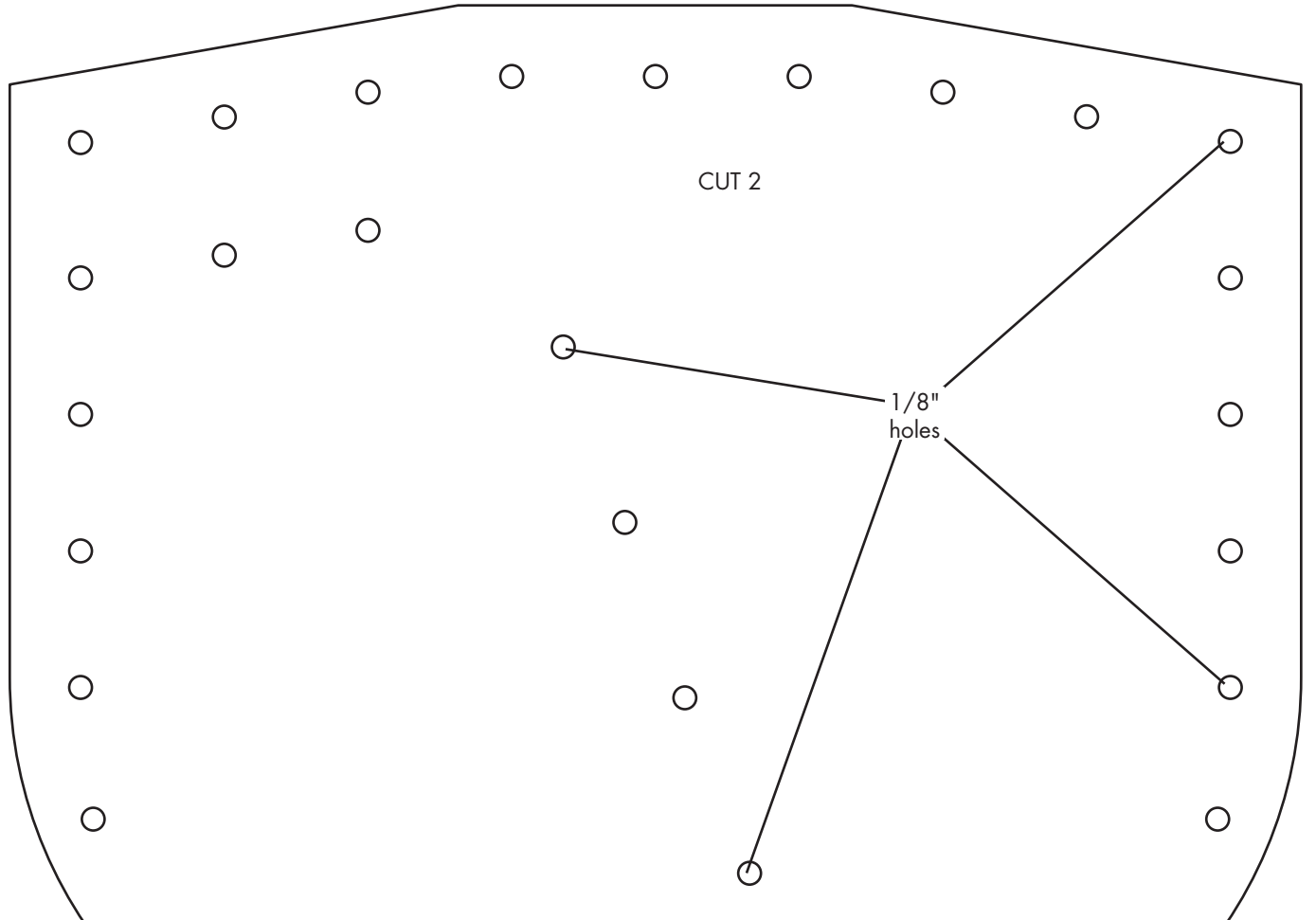



DIGITAL MEDIA FOR LEATHERCRAFTERS
LeathercraftLibrary.com

CRUSADER-STYLE SHOULDER SWORD HOLDER

Design by George Hurst. Pattern is reproduced at 100%.

Visit www.tandy.com for all the supplies needed to complete this project.

Visit www.LeadercraftLibrary.com for more great carving patterns.



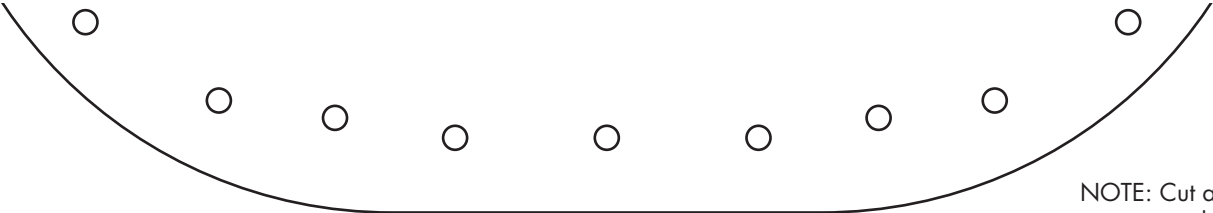

NOTE: Cut all parts from 6 vegetable tanned cowh

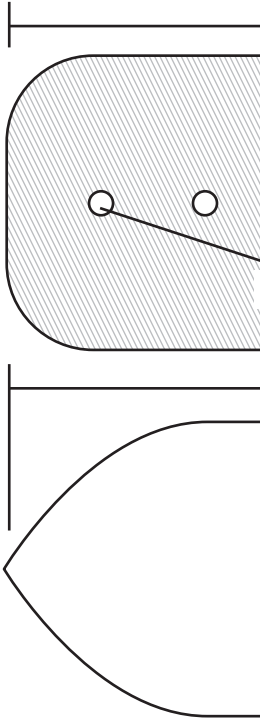
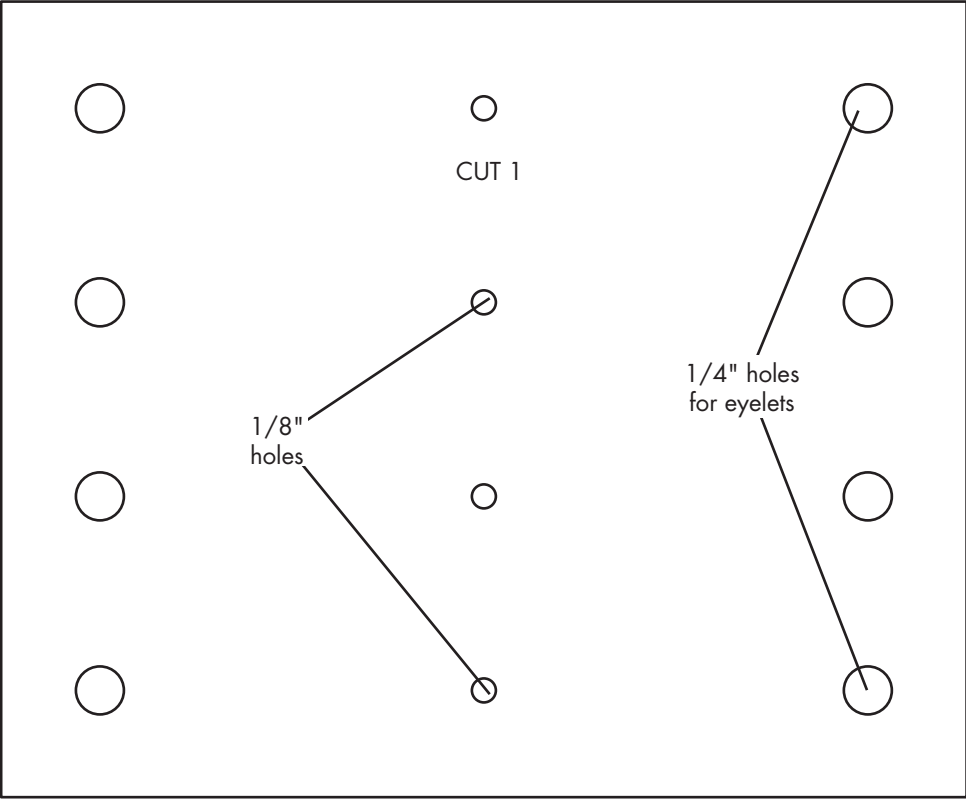

TLF_SHOULDERSWORDHOLDER_1015

to 7 oz.
hide

