

Vintage Pattern Series

Custom Knife Sheath

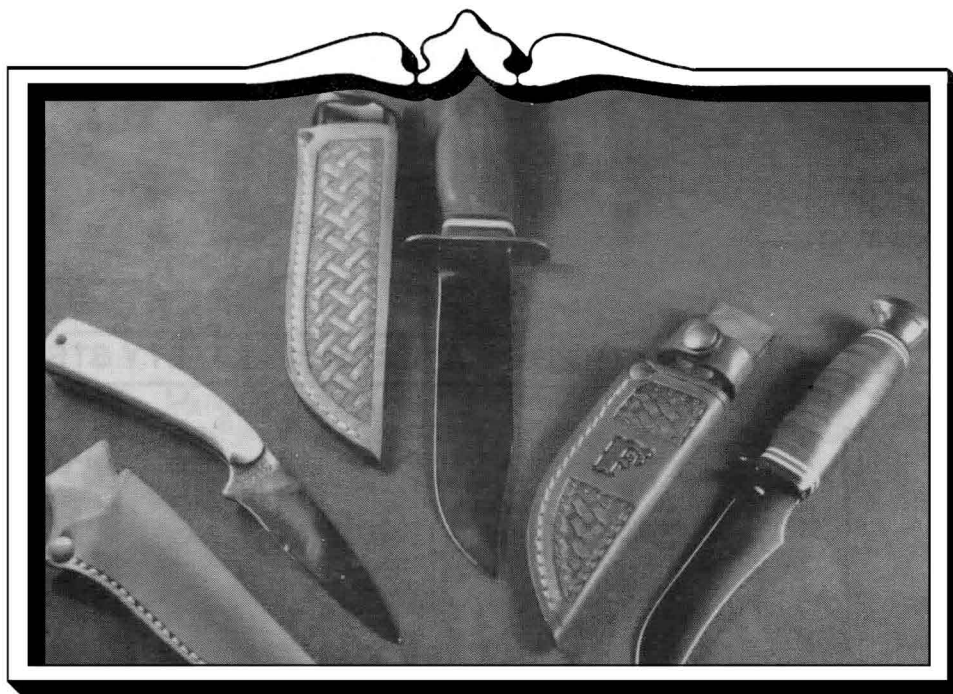

Detailed instructions guide you through every step.

Tandy[®]
LEATHER
EST. 1919
tandy-leather.com



LeathercraftLibrary.com
DIGITAL MEDIA FOR LEATHERCRAFTERS

Pattern Digital Download

This PDF file contains 1 (one) full pattern package. The PDF has been put together to give you options when it comes to printing. Pages and patterns that are larger than 8½x11 have been provided in two formats:

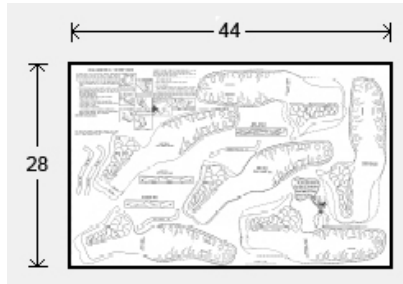

1) Full Size

If you would like to have a full size print out, take the full size pages to your local print shop and they can print it for you.

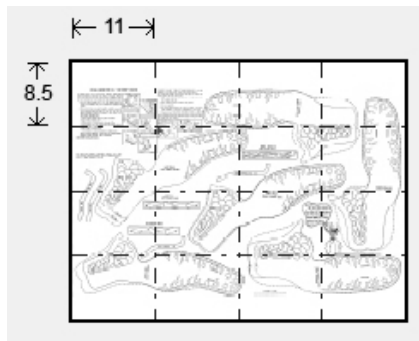

2) Tiled

The tiled pages give you the option of printing the larger patterns at home. You print the tiled pages and then assemble them to make the larger patterns.

The pattern PDF files are typically laid out like this:

Cover(if applicable), instructions sheets (if applicable), pattern 1 – full sized, pattern 1 – tiled, pattern 2 – full sized, pattern 2 – tiled, pattern 3 – full sized, pattern 3 – tiledetc

Please note: When printing on a home printer, the edges may get cut off. To avoid this, make sure “Page Scaling” is set to “Shrink to Printable Area” in the Adobe Reader print dialogue box. This will decrease the size of the pattern a very small amount.

NOTE: Digital kit patterns do not include any kit parts that they may reference.

NOTE: Some patterns may reference tools, and other items no longer available.

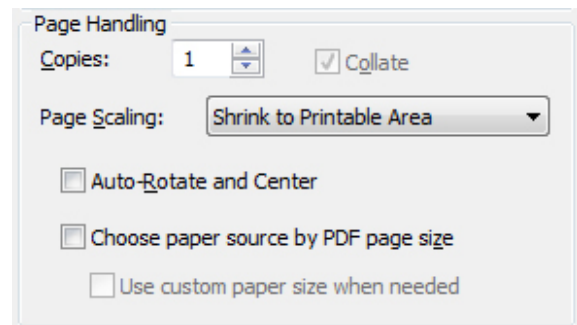

You may take this PDF file to your local print shop to have the full-size pages printed for your own personal use.

CUSTOM KNIFE SHEATH

YOU WILL NEED:

6-7 oz. Vegetable Tanned Leather
 1- Baby Dot Snap
 2- Medium Rivets
 Waxed Thread
 2- Easy Thread Needles
 Paper
 Pencil

Scissors or Sharp Knife
 7075 Baby Dot Setter
 1804 Anvil
 8100 Rivet Setter
 8074 Groover
 No. 6 Overstitch Wheel
 Stitching Awl
 No. 2 Mini Punch



0-0915-02

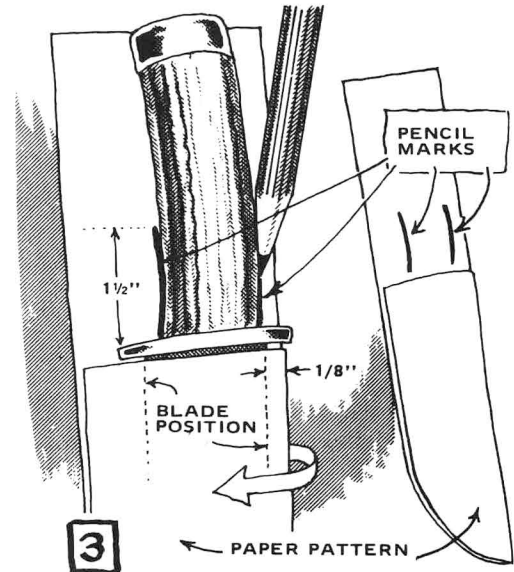
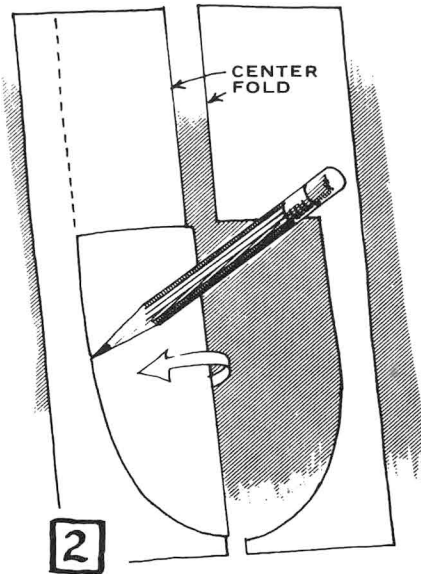
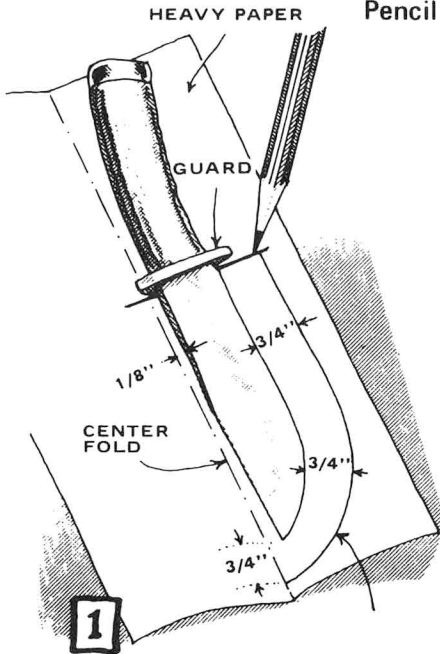

Fold and crease a piece of paper. Lay knife about 1/8" away from center fold, as shown. Pencil a mark under the guard, on both sides of blade. Draw a line, paralleling blade, 3/4" away . . . this will be the pattern cut-line.

Cut out around pattern and up center fold, as shown. Fold over and trace around, the edge of the pattern. Cut out the pattern, straight up on broken line.

Place knife blade in pattern. Blade should be at least 1/8" away from center fold, as leather takes up more room than paper at the folds. Pencil a mark on each side of the handle, as indicated.

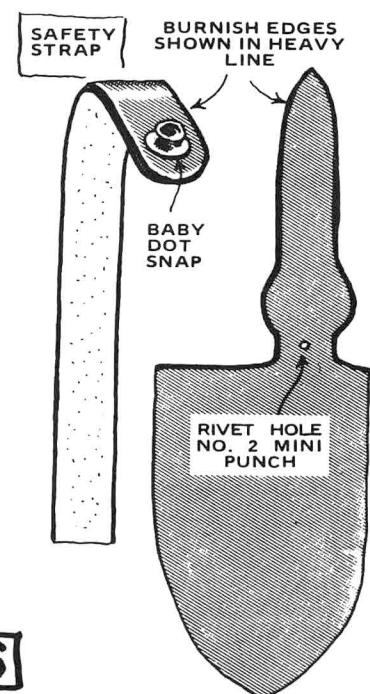
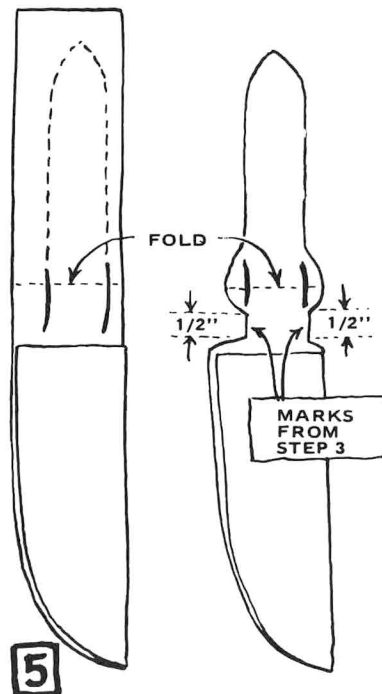
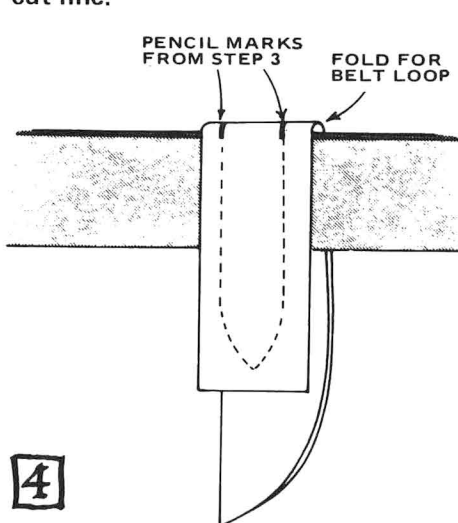

Remove the knife. Fold the pattern over your belt to form the belt loop. Pencil marks should show at top. Allow about 1/8" more room at top of loop to allow for thickness of leather at fold. Draw down from top marks to shape belt loop.

Unfold the loop; pattern should resemble sketch at left. Cut pattern in, to handle marks (as shown). Belt loop can be widened at fold to give more support if desired.

Cut the case from 6-7oz. cowhide. Punch a rivet hole (centered) as shown with No. 2 Mini Punch. Cut a safety strap from 6 oz. cowhide, 1/2" wide and about 6" long.

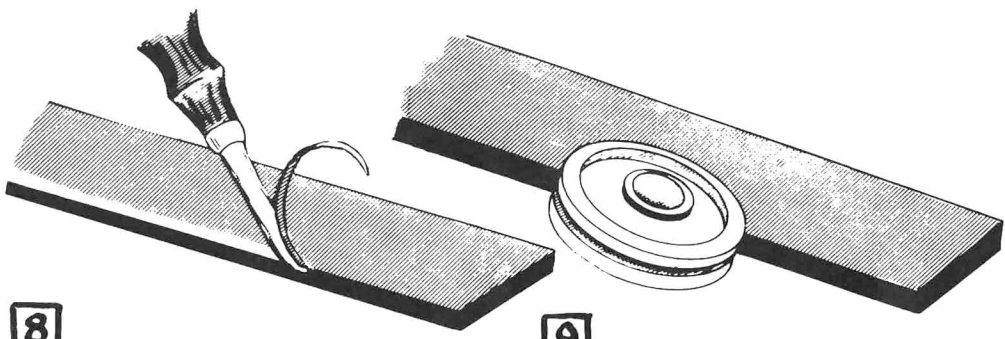
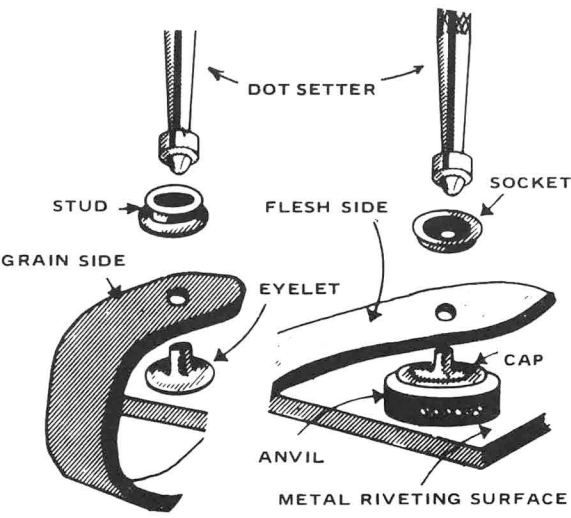

8

Using a No. 2 edge beveler, bevel along edge of safety strap and around top edge and belt strap of sheath.

9

Burnish edges with a circle edge slicker.

7

Set a Baby Dot snap on one end of safety strap following instructions below. Set only stud and eyelet at this time.

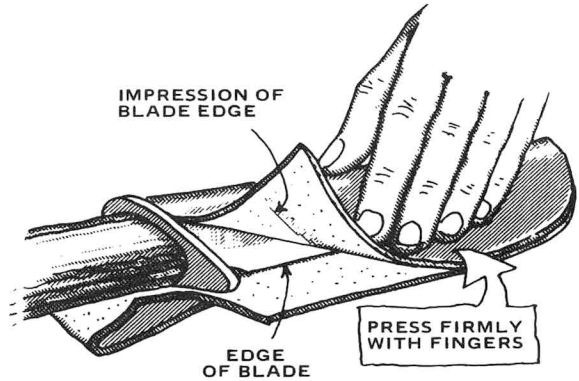
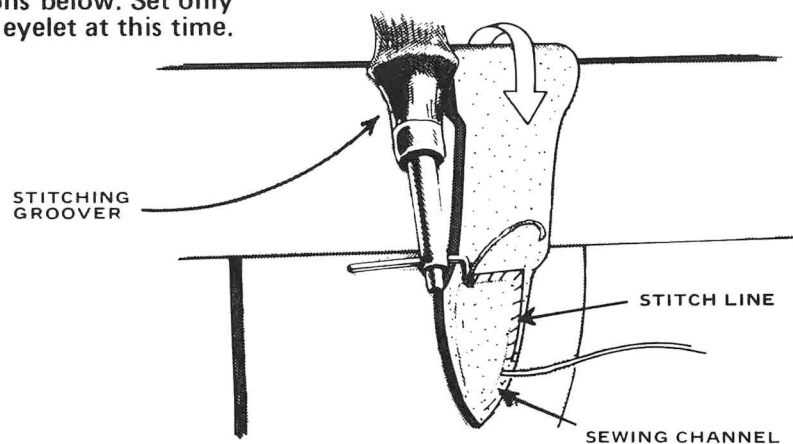

11

Moisten the case, especially well on the flesh side (inside). Fold over knife, against top of blade. Hold in position and firmly press top leather all along blade edge. This will leave its impression on the flesh side of the leather.

10

Mark stitching line on flesh side of belt loop as shown. Using No. 8074 Stitching Groover, gouge a channel on stitch line. Mark stitches with a No. 5 Overstitch Wheel. Fold belt loop over your belt and locate position of end of belt loop. Following Hand Stitching Instructions, stitch end of belt loop to back of sheath.

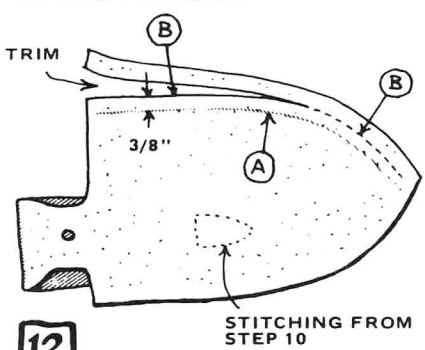

13

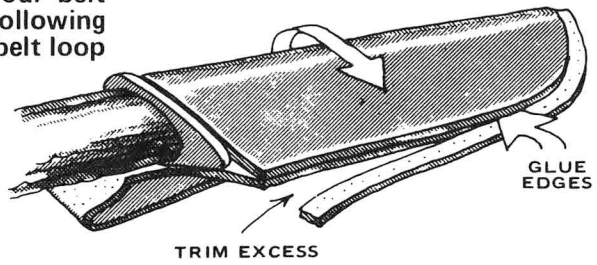

Once again, fold leather over knife. Cement the two edges together and trim off the excess.

12

Unfold the case, note the impression (A) of the blade edge. Scribe a parallel mark (B) 3/8" outside the impression. Trim excess leather off on this line. We want the stitching at least 1/4" from the blade.

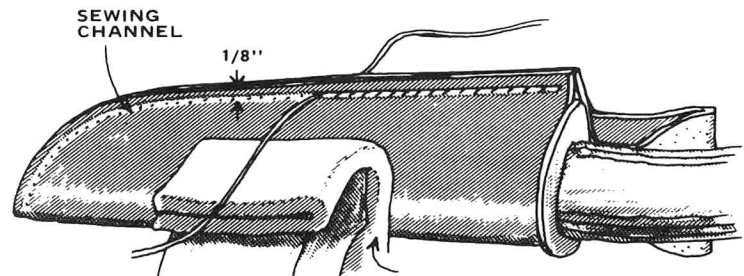

14

Gouge a sewing channel 1/8" from edge on front and back sides as in Step 10. Use No. 6 Overstitch Wheel and mark stitches. Place stitching horse, with knife inside, and sew following handstitching instructions. Finish the edges.

PADDING TO PREVENT MARRING CASE LEATHER

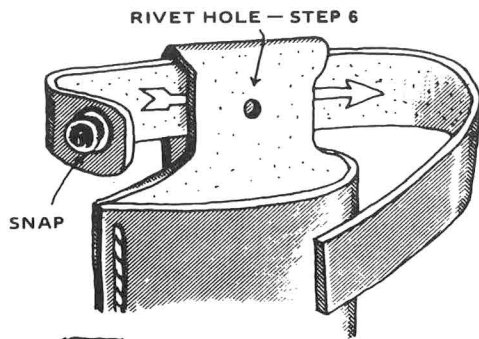

15

Pull safety strap (from Step 6) inside the belt loop, as shown. See back cover for alternate safety straps.

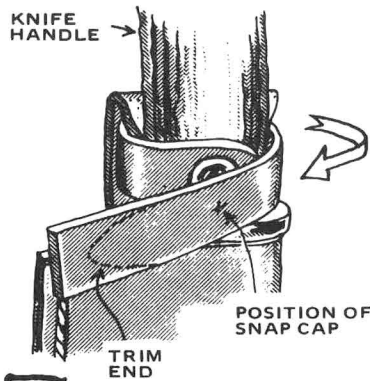

16

Place the knife in the case and pull safety strap tightly around the handle. Mark snap position, and the trim for the end.

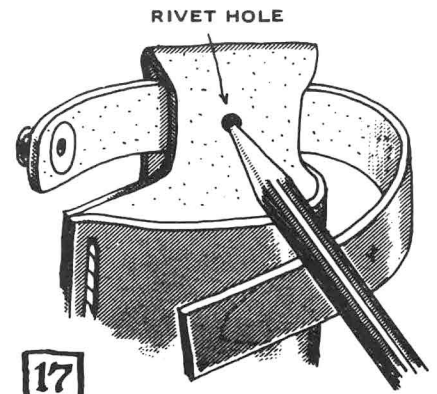

17

Carefully unfold strap and remove knife. Do not allow strap to move . . . mark rivet hole with pencil. Remove strap and punch hole with No. 2 Mini Punch. Point the strap end and burnish the edges.

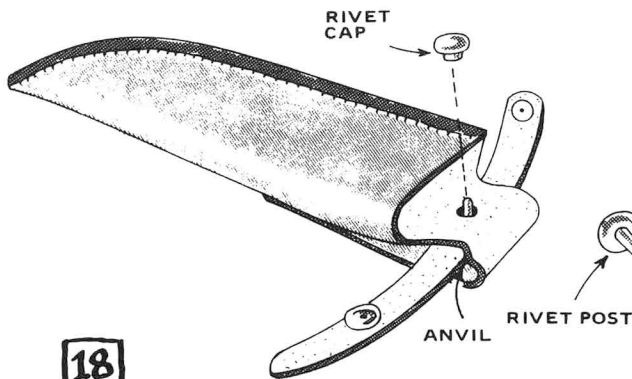

18

Punch hole for snap cap in end of strap with No. 2 Mini Punch. Install snap cap as per instructions in Step 7. Put safety strap through belt loop. Slip No. 1804 Anvil under post and inside belt loop. Place cap of rivet on post. Place rivet setter on cap of rivet and strike sharply with a mallet until rivet is set.

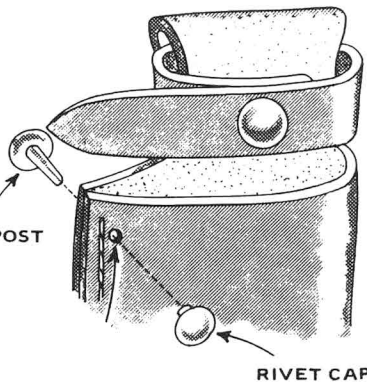

19

Now punch a hole just inside the stitches, as shown. Install other rivet in this hole. The purpose of this rivet is to protect the stitches from the blade.

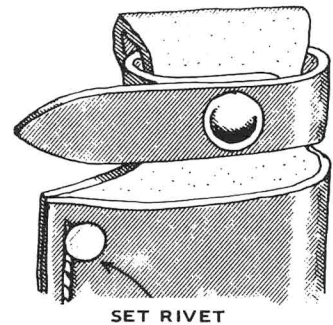

HAND STITCHING INSTRUCTIONS



STEP 1. Push one end of thread through eye of needle about 1/2".

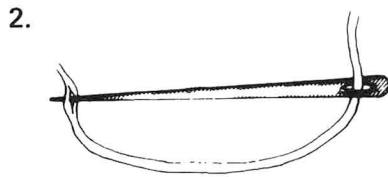

STEP 2. Pierce thread with needle point as shown.



STEP 3. Push thread up on needle to eye. Pull 1/2" end of thread through eye as far as it will go. Hold needle and pull thread over eye of needle. Repeat this on other needle.

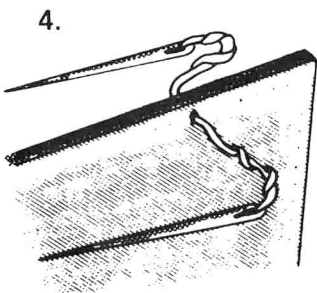

STEP 4. After holes are marked with No. 5 Overstitch Wheel, stab hole with stitching awl. Insert one needle through hole and pull through until you have an even amount of thread on each side of the leather.

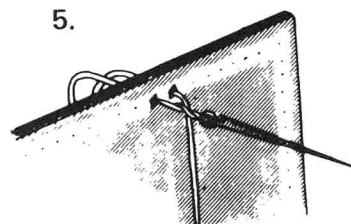

STEP 5. Stab next hole. Insert needle on back or inside of leather through hole and pull thread through.

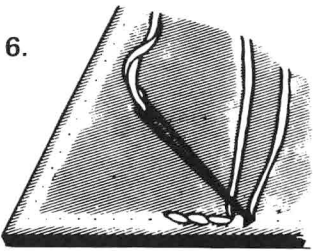

STEP 6. Insert needle from outside or front of leather through same hole, being careful to go over first thread. **DO NOT PIERCE THREAD.** Pull through. Grasp both threads and pull stitch snug. Continue stitching this way until you reach last hole.

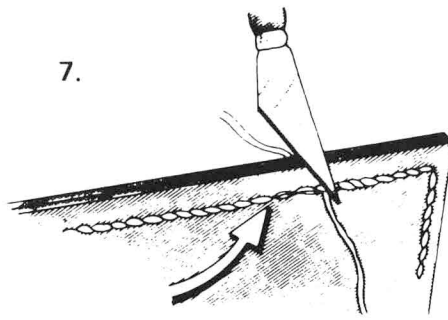

STEP 7. Go through last hole with both threads and pull stitch snug. Stitch through last two stitches to secure thread. Trim thread off close to leather. Tap all stitches down with a mallet.

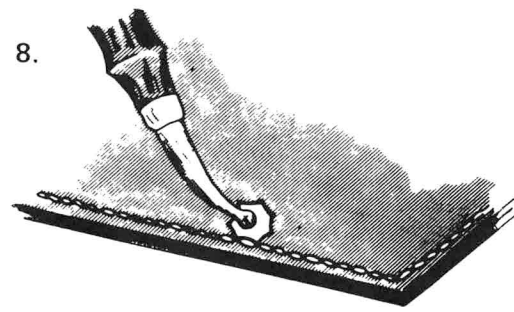

STEP 8. Run Overstitch Wheel over all the stitches.

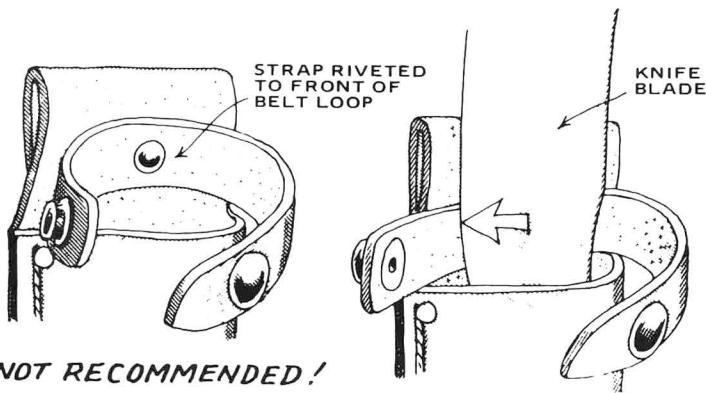

This method of attaching a safety strap is not recommended, as the strap tends always to be in the way of the knife blade as it enters and withdraws from the sheath . . . subjecting it to being cut! It should be inside the loop . . . as in Step 15. So that when unsnapped it can swing away from the blade.

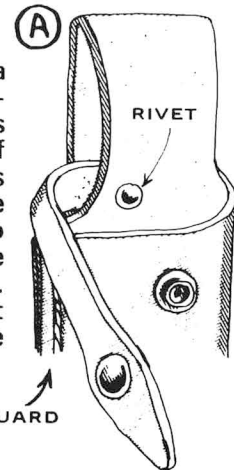

This method can be used when the knife has a long guard. Rivet or sew inside the belt loop.

NOT RECOMMENDED!

OTHER METHOD OF ATTACHING SAFETY STRAPS

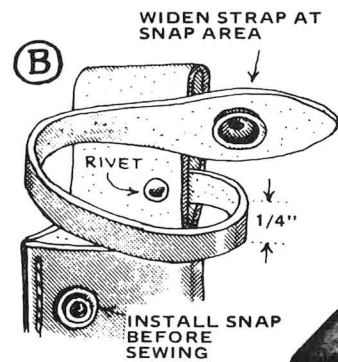
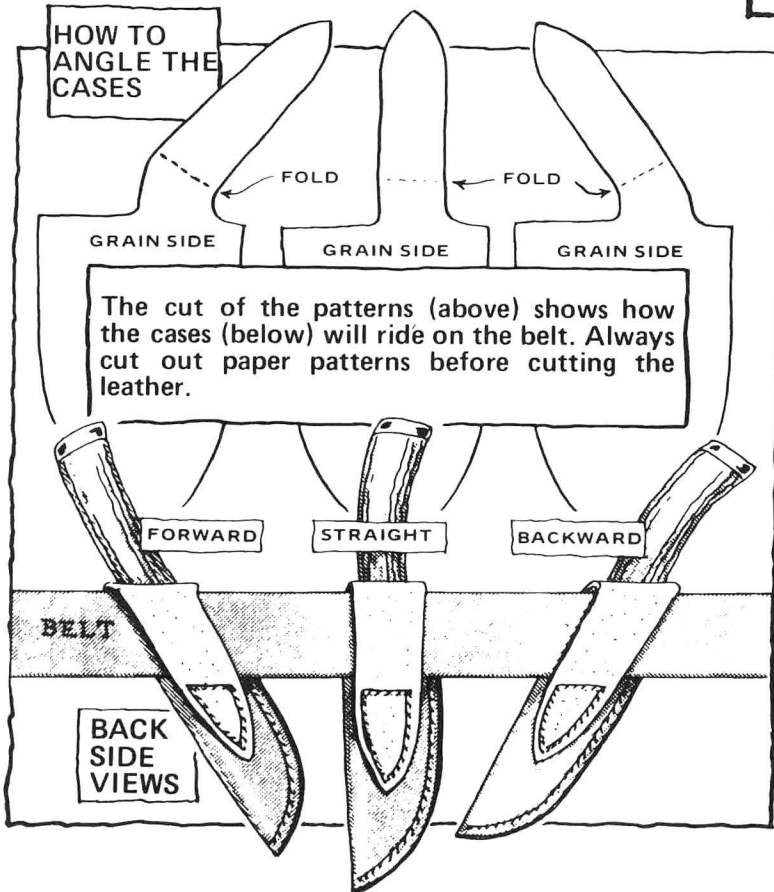

For knives with short guards. Insert snap in wide end. Taper strap down to 1/4". Snap cap to case, wrap strap around handle, and inside loop. Pull tight to locate position of rivethole for strap.

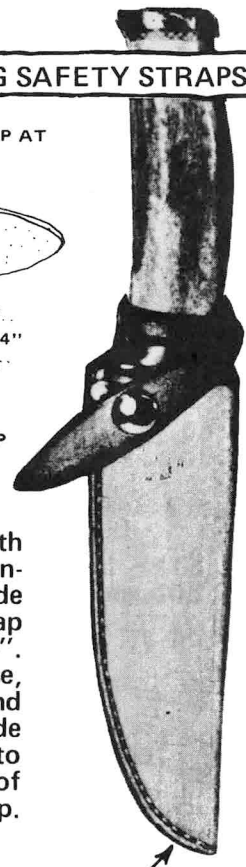

SHORT GUARD