

# Vintage Pattern Series

## Cutting Leather Shapes



Detailed instructions guide you through basic processes.  
Tool in the style of one of the examples or one of your own ideas, then dye and stain.

**Tandy**<sup>®</sup>  
**LEATHER**  
EST. 1919  
tandy-leather.com



**LeathercraftLibrary.com**  
DIGITAL MEDIA FOR LEATHERCRAFTERS

## Pattern Digital Download

This PDF file contains 1 (one) full pattern package. The PDF has been put together to give you options when it comes to printing. Pages and patterns that are larger than 8½x11 have been provided in two formats:

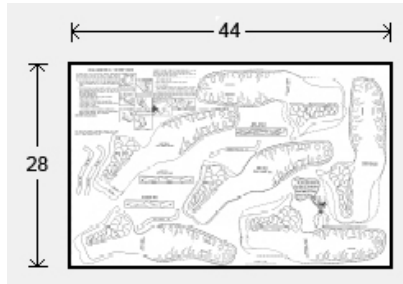

### 1) Full Size

If you would like to have a full size print out, take the full size pages to your local print shop and they can print it for you.

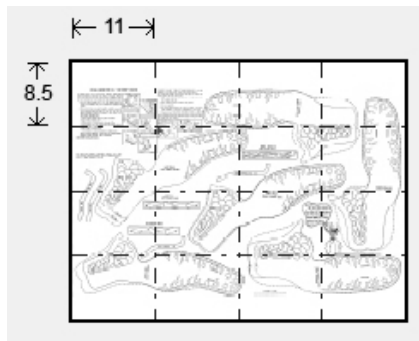

### 2) Tiled

The tiled pages give you the option of printing the larger patterns at home. You print the tiled pages and then assemble them to make the larger patterns.

The pattern PDF files are typically laid out like this:

Cover(if applicable), instructions sheets (if applicable), pattern 1 – full sized, pattern 1 – tiled, pattern 2 – full sized, pattern 2 – tiled, pattern 3 – full sized, pattern 3 – tiled ....etc

Please note: When printing on a home printer, the edges may get cut off. To avoid this, make sure “Page Scaling” is set to “Shrink to Printable Area” in the Adobe Reader print dialogue box. This will decrease the size of the pattern a very small amount.

**NOTE: Digital kit patterns do not include any kit parts that they may reference.**

**NOTE: Some patterns may reference tools, and other items no longer available.**

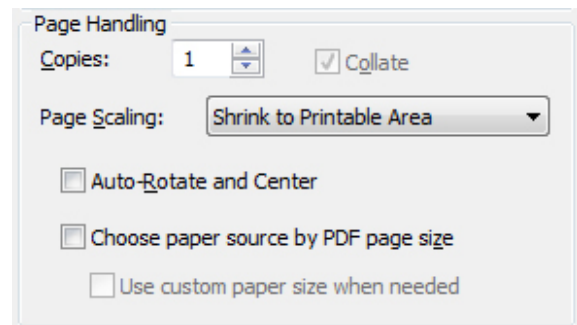

You may take this PDF file to your local print shop to have the full-size pages printed for your own personal use.

# CUTTING LEATHER SHAPES THE EASY WAY



An excellent way to buy leather is by the side. For example, a side contains 18-23 square feet of leather. When properly cut, a side will yield approximately 25 belts, 20 wristbands, 15-20 barretts, 30-40 key fobs and countless pieces for leather jewelry, etc. Cutting a side carefully is the key to making leather inexpensive and useful. All the projects in this book are made from strips, cut in various widths.

#### HOW TO CUT A STRAIGHT EDGE ON A SIDE

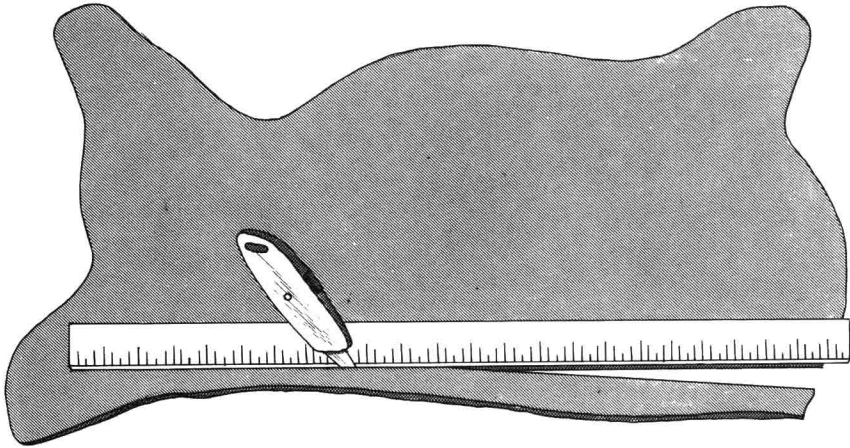

Start by laying the side on a large table. Place your straight edge along one long edge of the side. Use a sharp knife to cut the ragged edge off the side. Be careful not to let the straight edge slip. Try to cut completely through the leather with the first cut.

#### HOW TO CUT STRIPS WITH A STRAP CUTTER

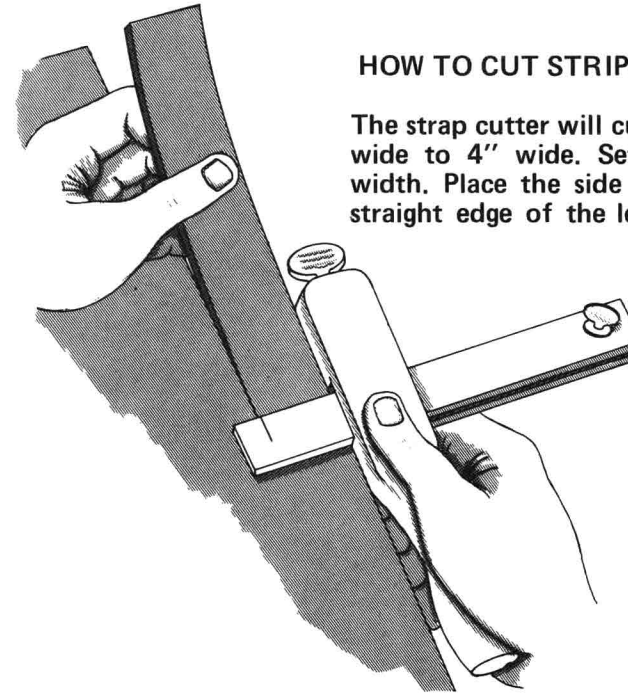

The strap cutter will cut strips of leather from 1/8" wide to 4" wide. Set the cutter for the desired width. Place the side of the cutter flush with the straight edge of the leather with the blade resting against the end of the leather. Carefully pull the cutter down the straight edge of the leather, all the way to the end.

#### HOW TO CUT STRIPS INTO PROJECTS

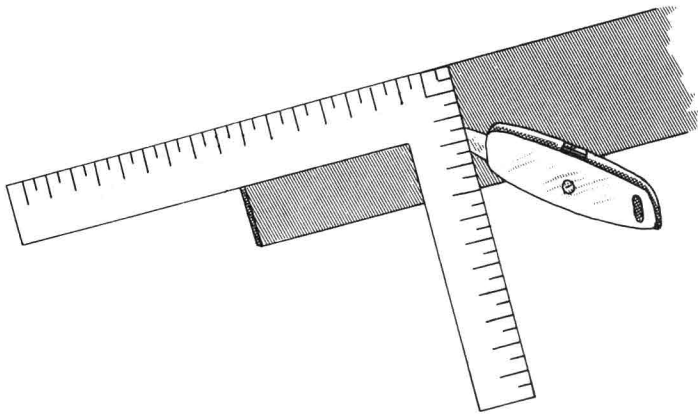

Once you have your strip the desired width, you are ready to cut it into lengths. Use a square rule and a sharp knife. Align outside edge of the square with top edge of the strip, lining it up on the desired length. Cut strip using other edge of the square to guide the knife.

#### HOW TO CUT WITH SUPER SHEARS

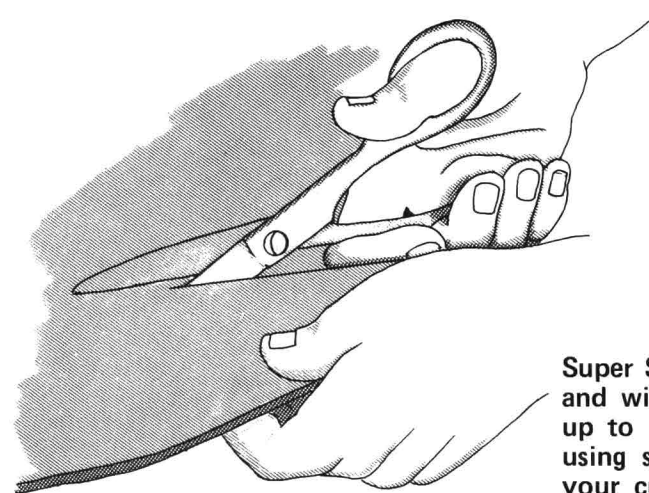

Super Shears are of medium size and will cut through all leathers up to 12 oz. in thickness. When using shears it is best to scribe your cutting line on the leather and then cut on the line. After you have cut your strips into lengths you can use the shears for further shaping of the project.

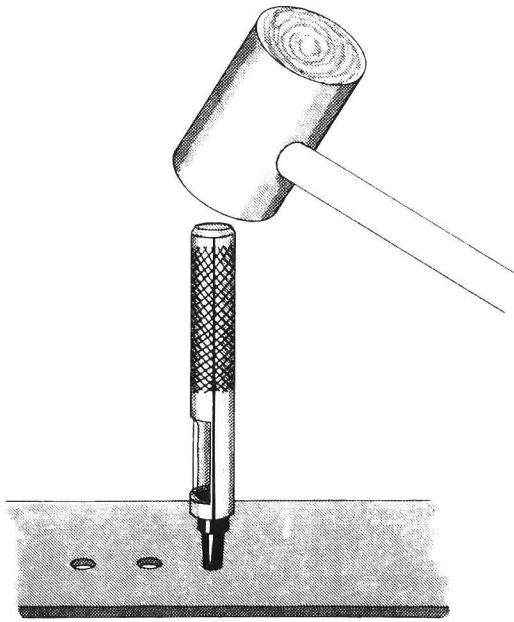

### HOW TO USE THE MINI & MAXI DRIVE PUNCHES

The Mini and Maxi punches are used for punching holes for rivets, eyelets, snaps, buckle tongue slots, and lacing and stitching holes. They come in sizes 0 through 12 (1/16" to 5/16"). Always use a heavy rawhide mallet on all punches, NEVER use a steel hammer. Always place your leather on a pondo board or another piece of leather to protect the cutting edges of your punches.

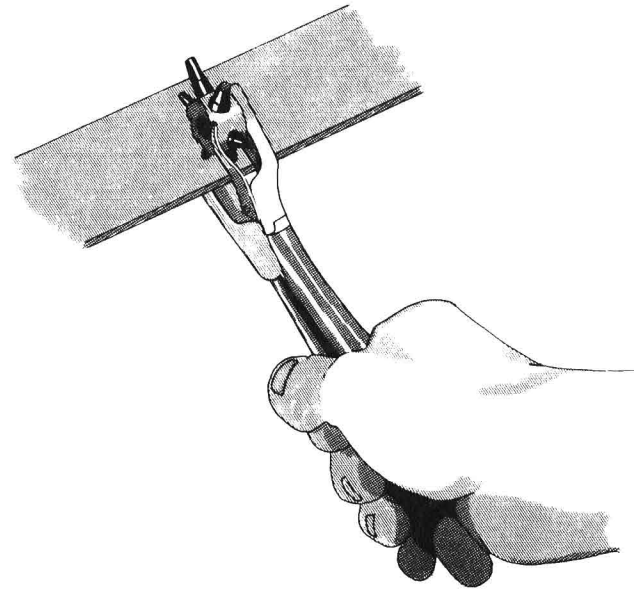

### HOW TO USE A ROTARY PUNCH

The rotary punch with tube sizes 1 through 7 is used on lighter weight leather where the holes are punched close to the edge. When punching holes in leather, twisting the hand to the right or left as you squeeze the handle will make punching easier.

### HOW TO USE THE SKIVER

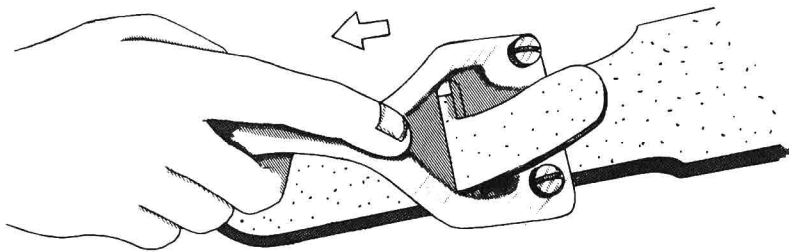

A skiver is used to reduce the thickness of the leather in specific areas; such as the buckle end of a belt, to make it fold easily. Hold the tool as shown, on the flesh side of the project. Do not try to remove the full width of the strap in one operation. More control of the depth is possible by skiving off one side, then the other. Begin second by overlapping first skive. Re-skive over areas that are not uniform in thickness. Remove about 1/3 of the thickness of the leather.

### BELT SIZING CHART

WAIST SIZE	OVERALL LENGTH
18"	24"
20"	26"
22"	28"
24"	30"
26"	32"
28"	34"
30"	36"
32"	38"
34"	40"
36"	42"
38"	44"
40"	46"
42"	48"
44"	50"

### DOG COLLAR SIZING CHART

NECK SIZE	OVERALL LENGTH
12"	15"
14"	17"
16"	19"
18"	21"
20"	23"
22"	25"
24"	27"

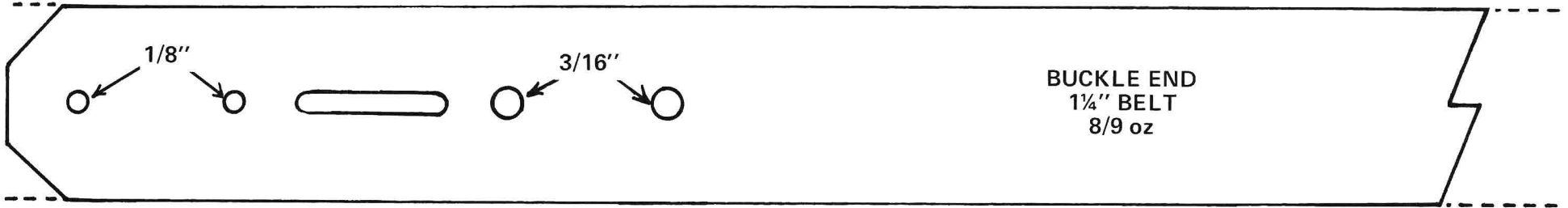
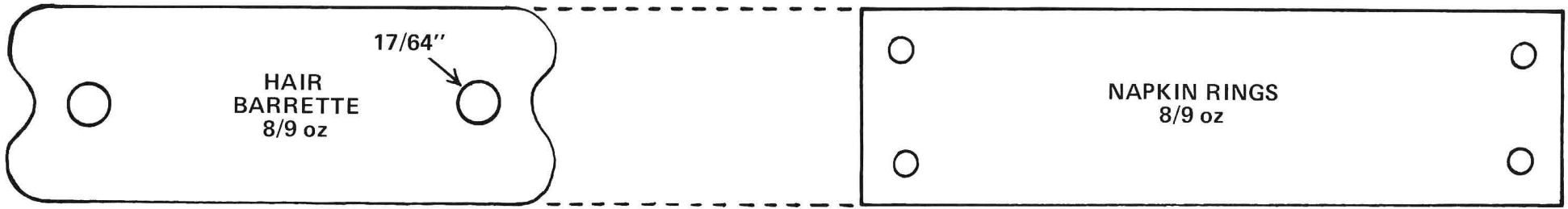

SEE PAGE 3 FOR BELT SIZING CHART

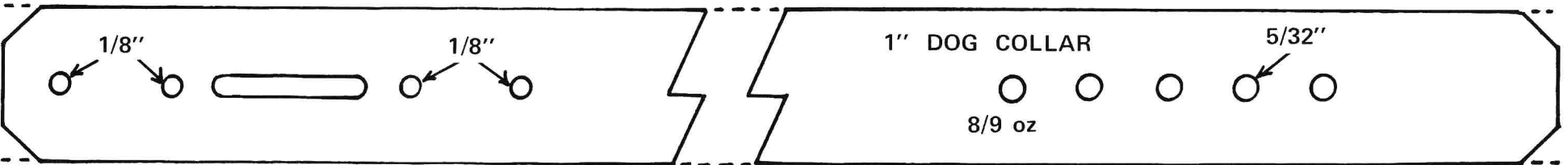
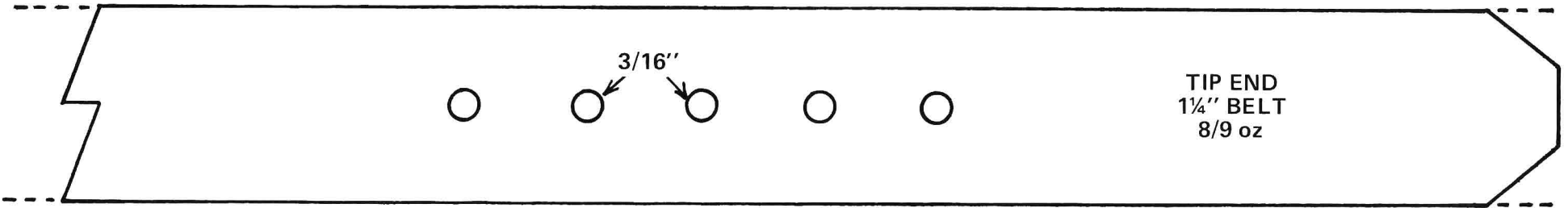

SEE PAGE 3 FOR SIZING CHART

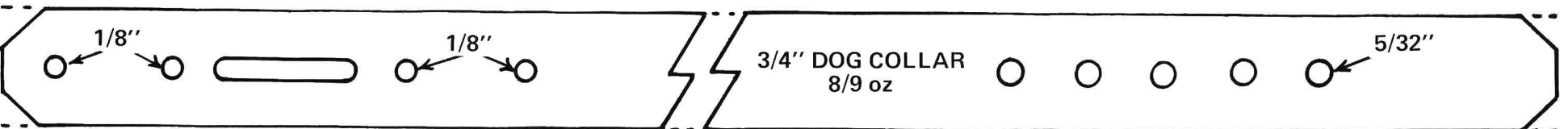



SEE PAGE 3 FOR BELT SIZING CHART

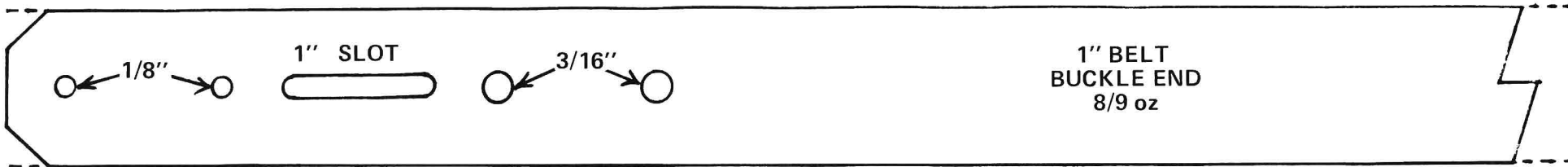
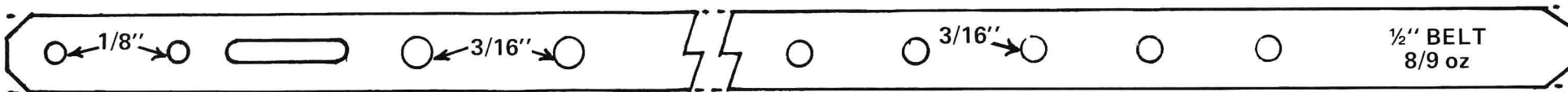
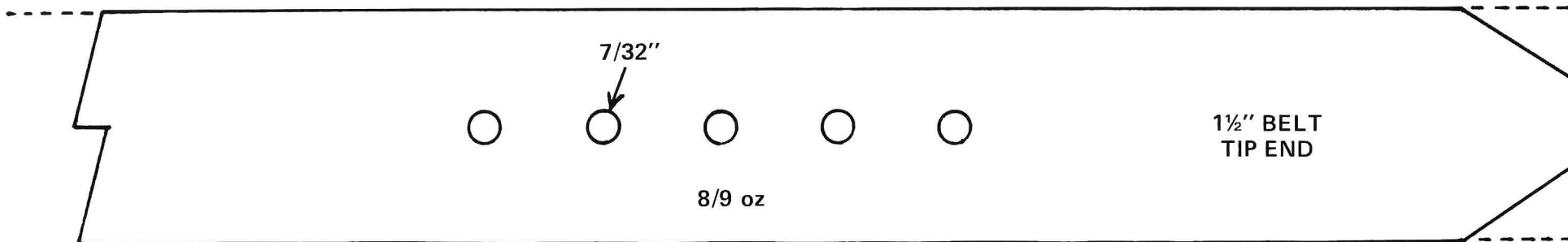

SEE PAGE 3 FOR BELT SIZING CHART

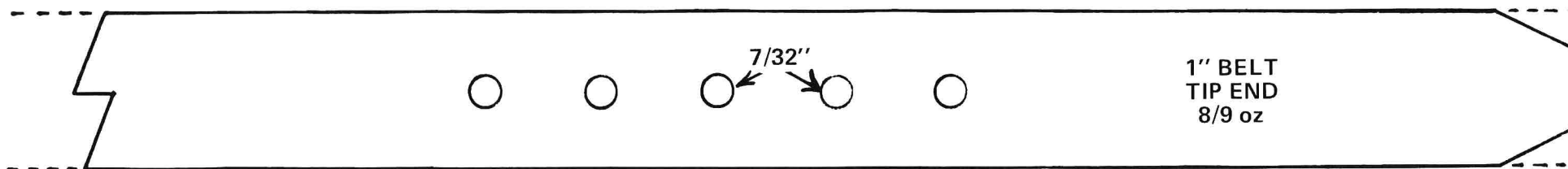

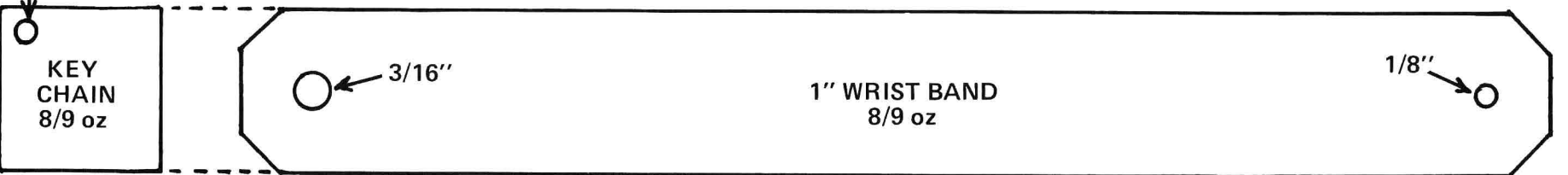
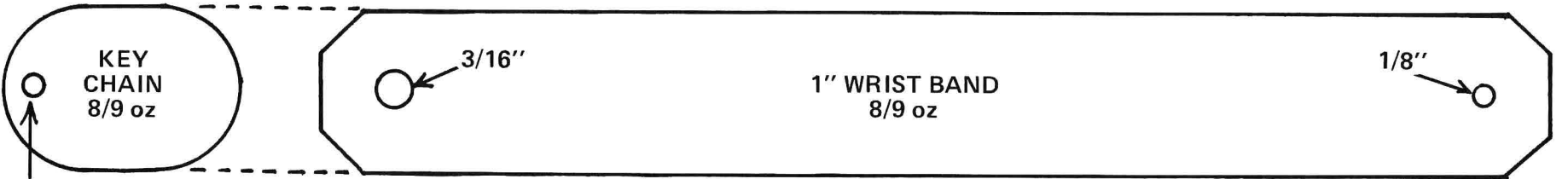
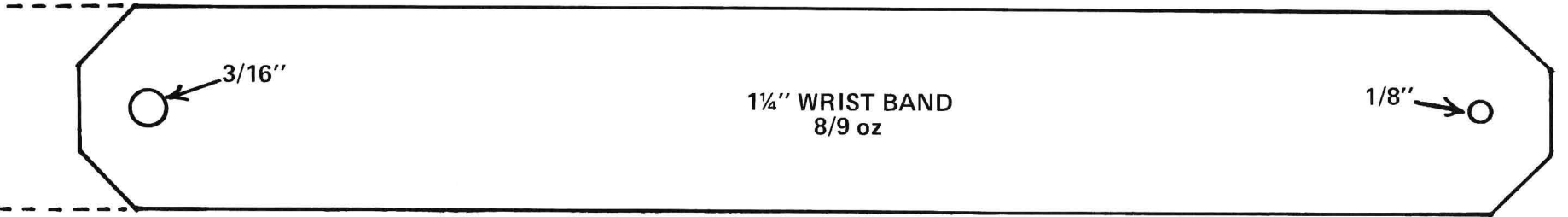
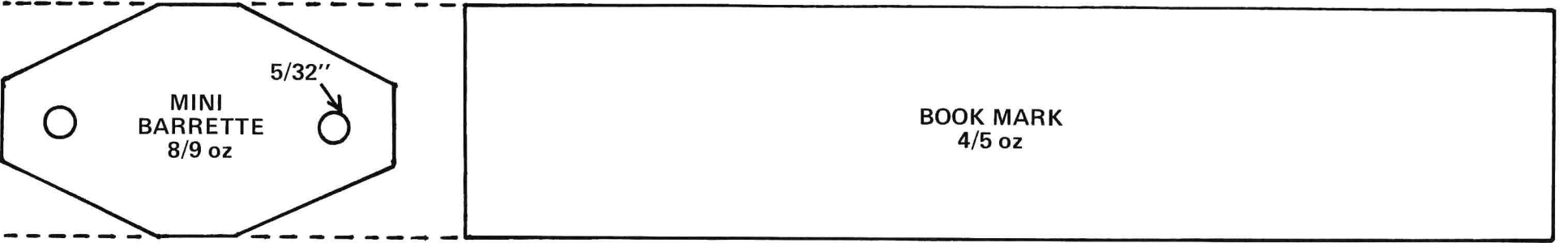



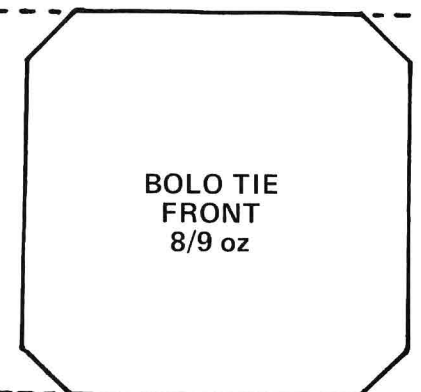
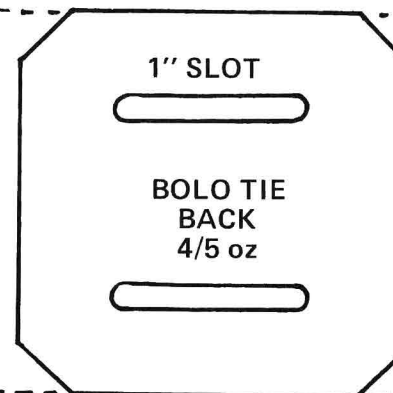
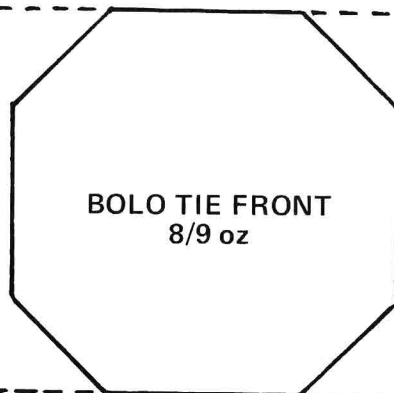
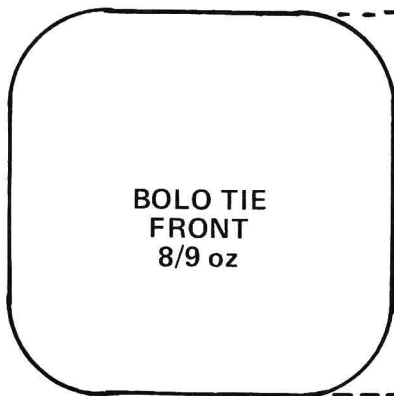
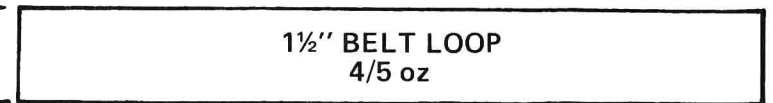
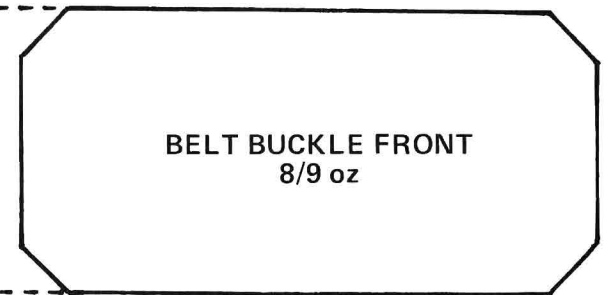
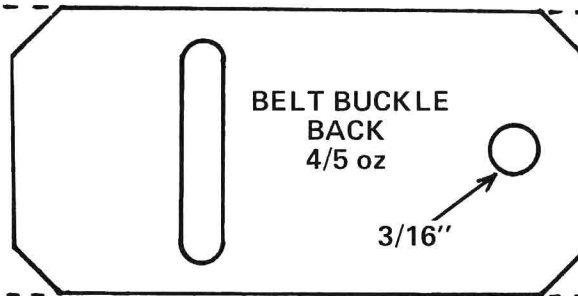
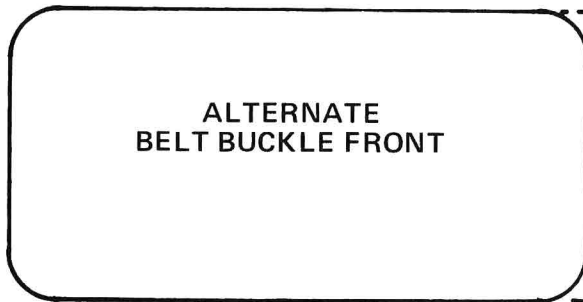
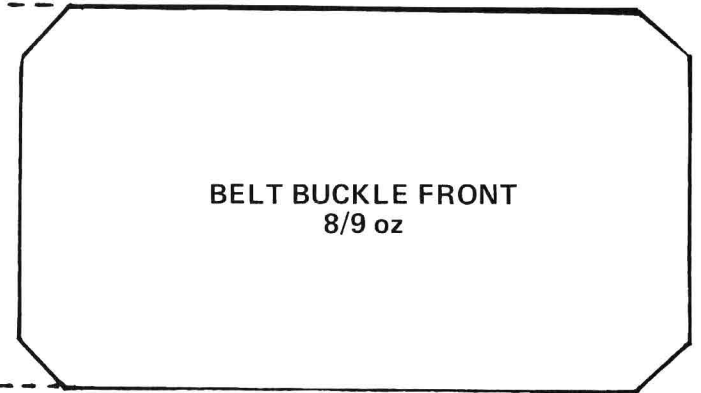
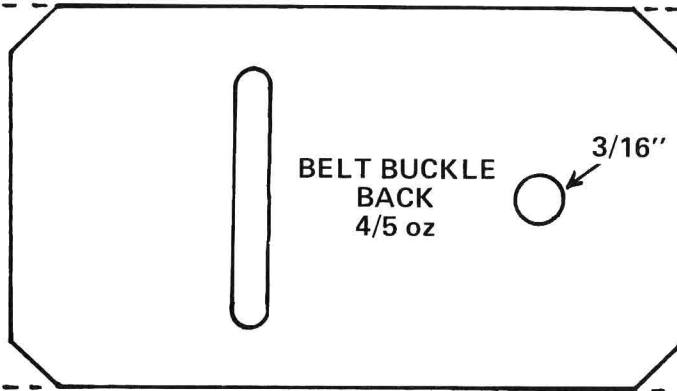
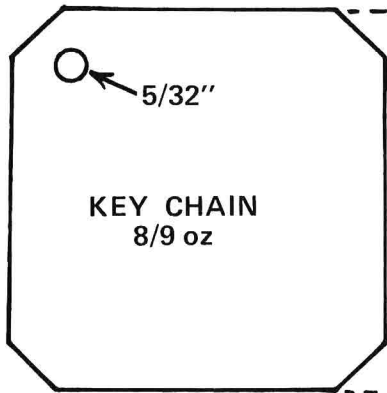

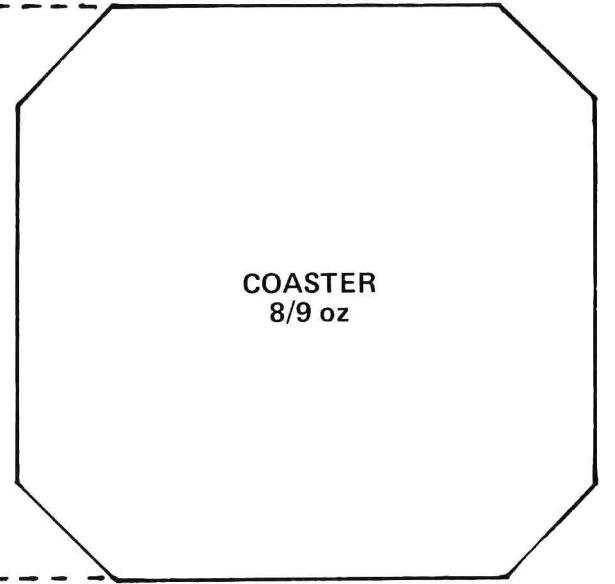
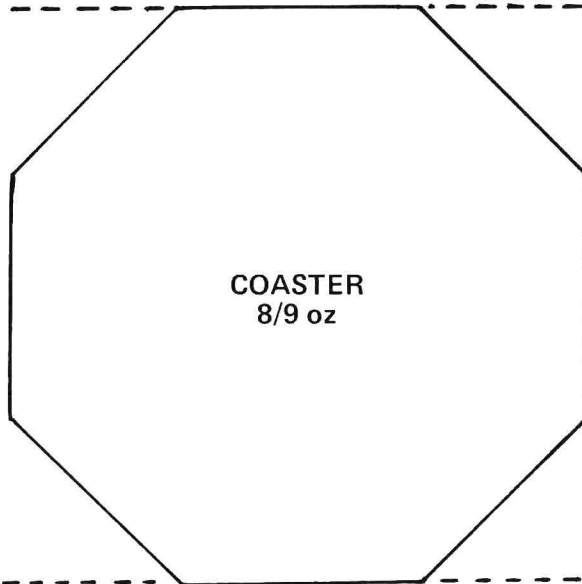
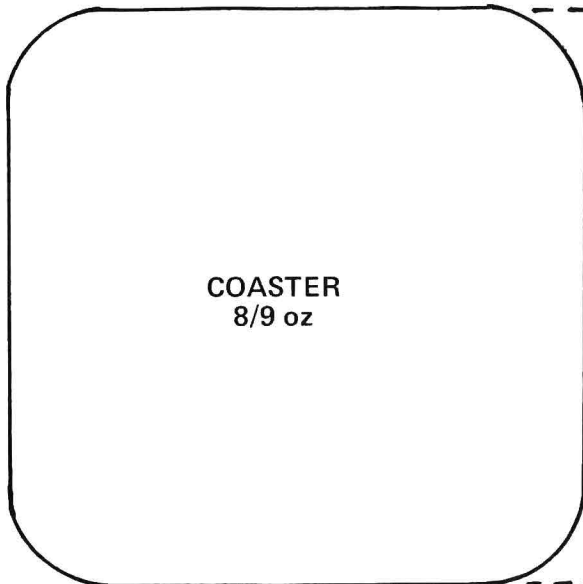
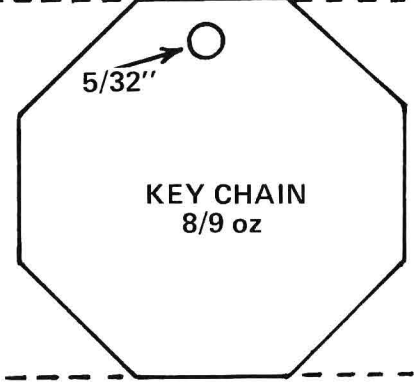
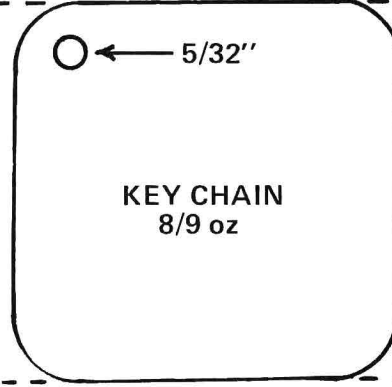
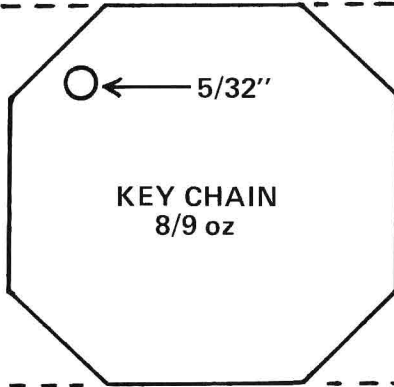
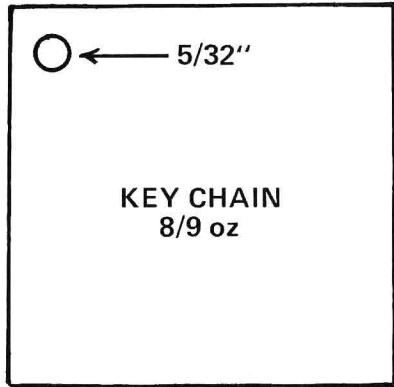
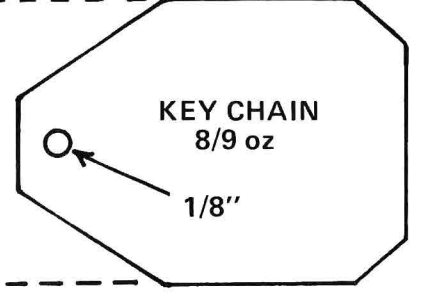
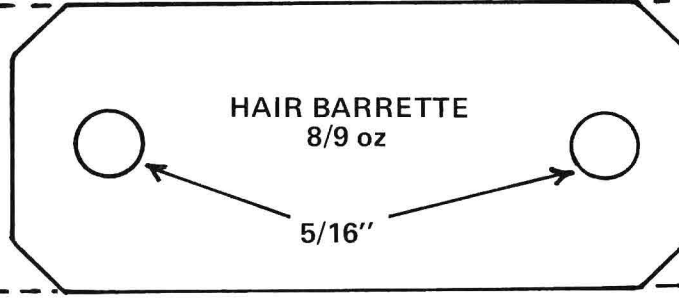
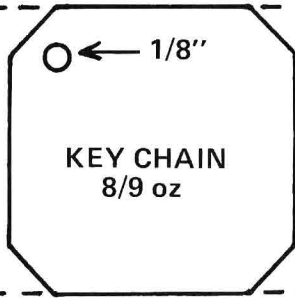
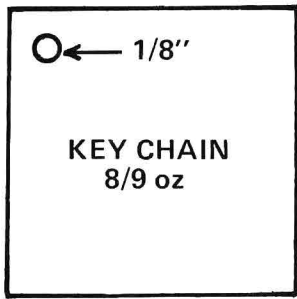

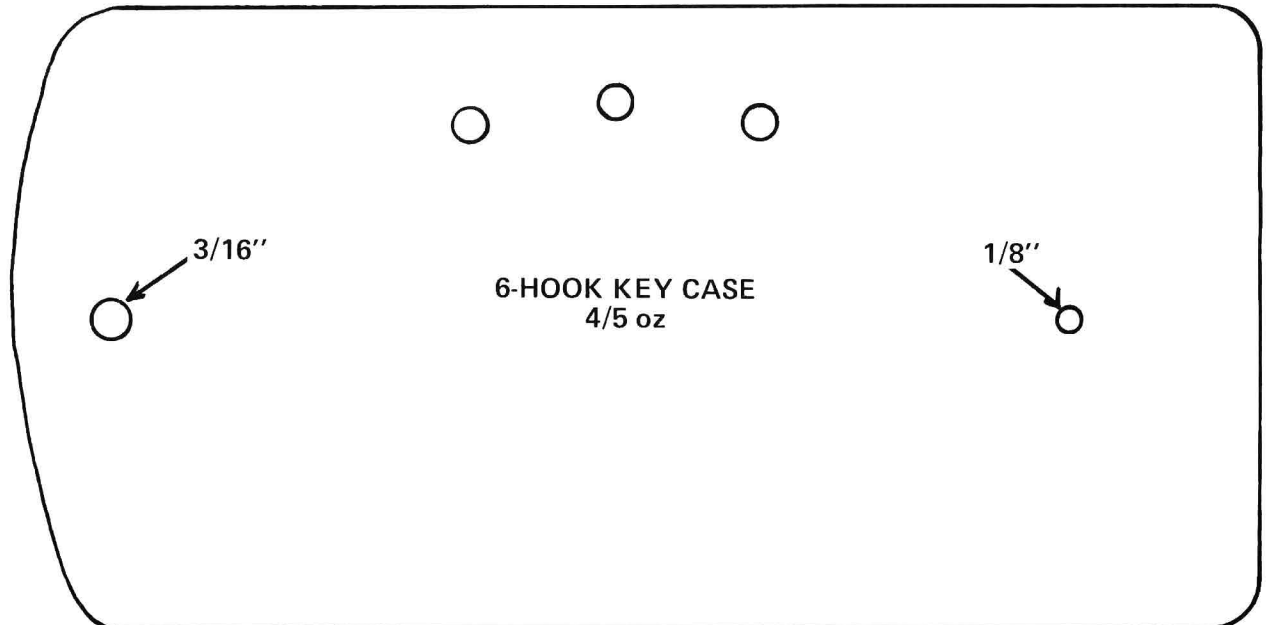
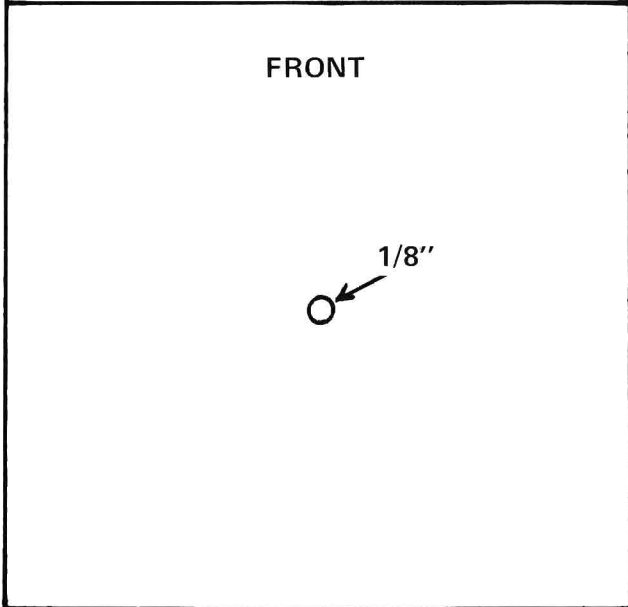
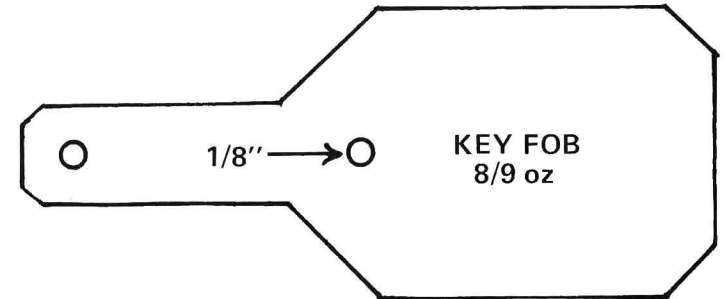
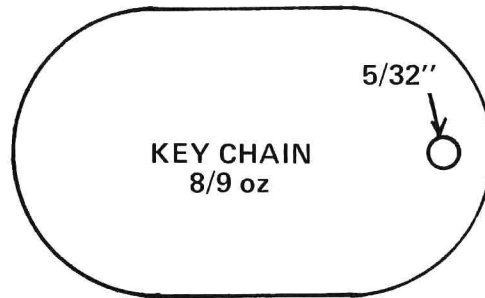
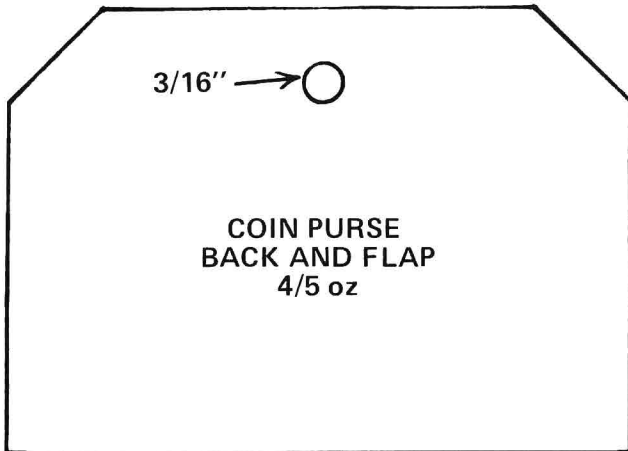
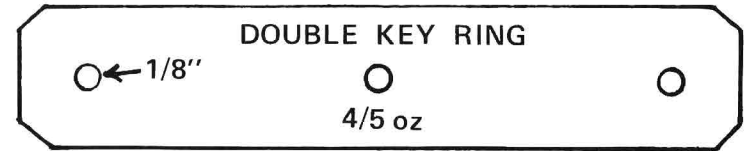
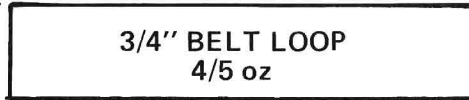
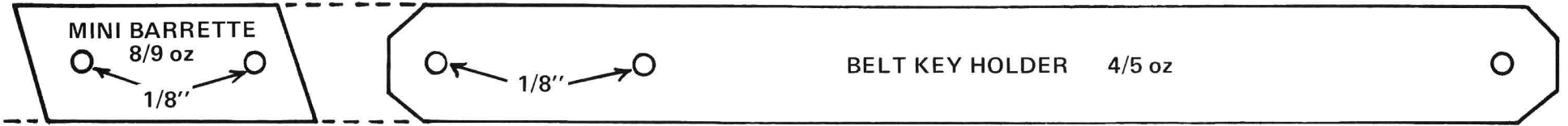

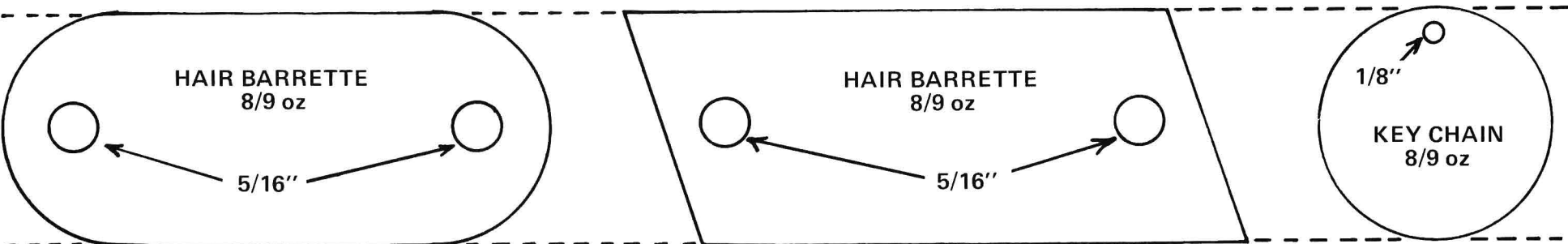
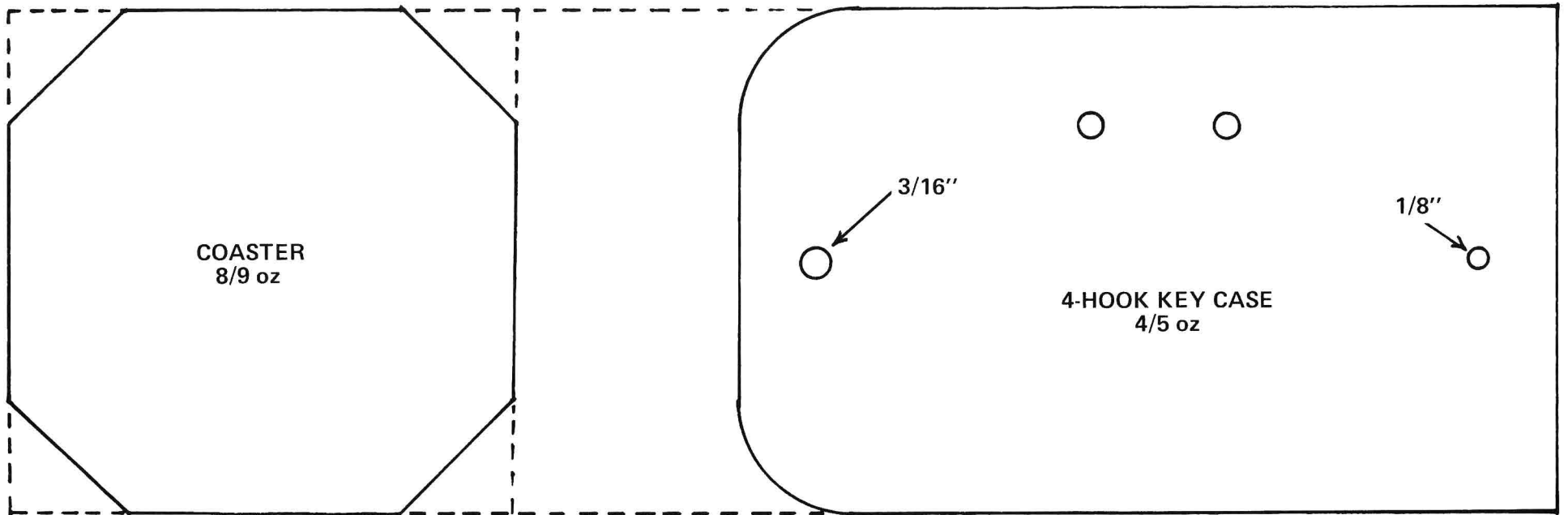
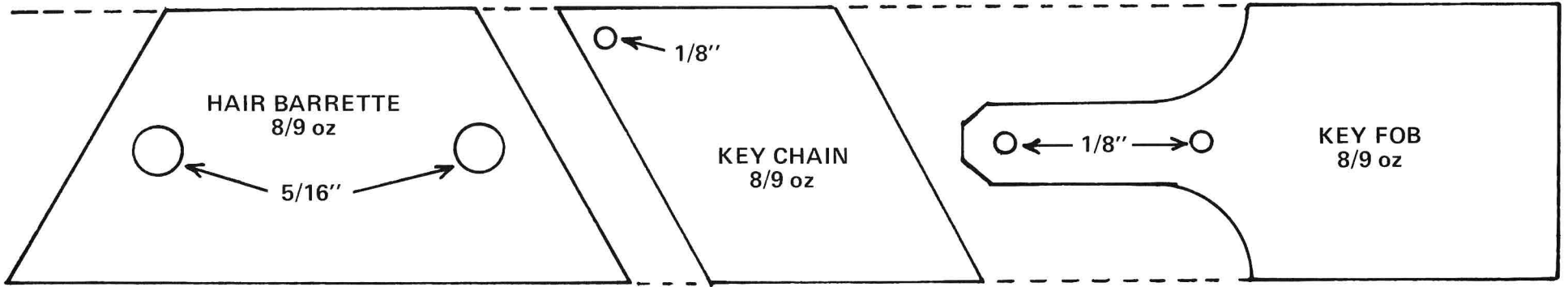

All the designs on this page and the back cover can be done using one or two stamping tools. They are finished with either Antique Leather Stain and Super Shene or Cova Dye or a combination of the three. See your nearby Tandy Leather Store for their complete line of dyes, finishes and Craftool stamping tools.

### KEYFOBS



### KEY CHAINS OR NECKLACE PENDANTS



### BELT KEY FOBS

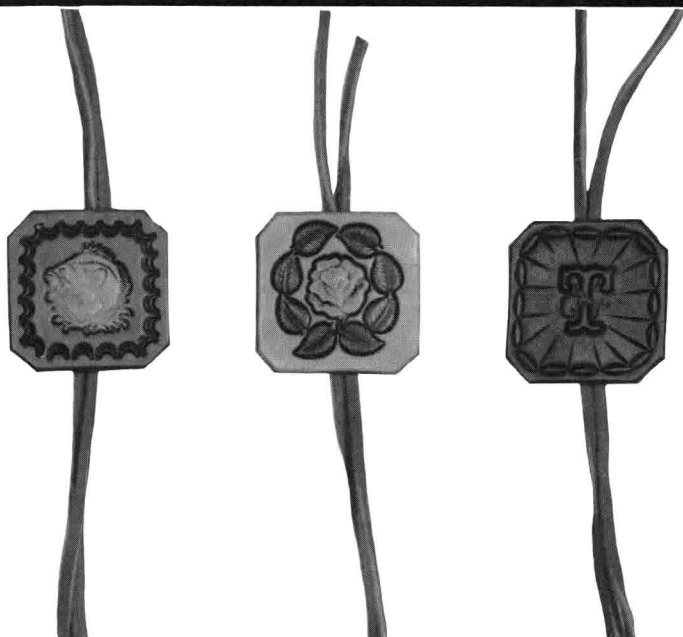

### BELTS

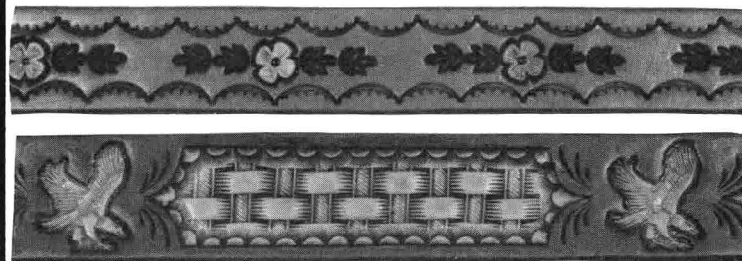

### BUCKLES



### DOG COLLAR



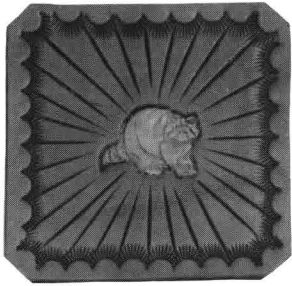

COASTERS



KEY CASES



NAPKIN RING

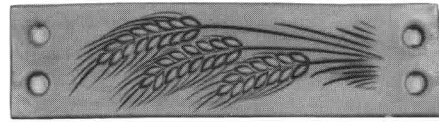

NECKLACE PENDANTS

BARRETTES

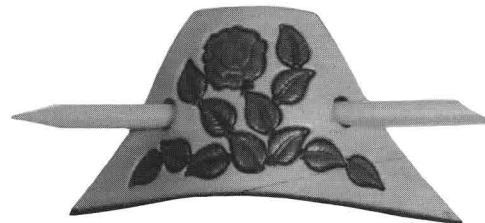
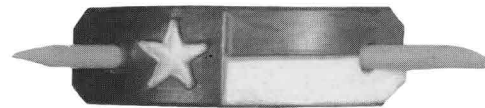

WRIST BANDS

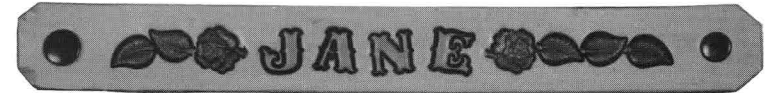

LEATHER COMPANY®

Distributed by Tandy Leather Co.  
Fort Worth, Texas  
A Division of Tandy Crafts, Inc.