



DIGITAL MEDIA FOR LEATHERCRAFTERS
LeathercraftLibrary.com

Visit www.tandy.com for all the supplies needed to complete this project.
 Visit www.LeadercraftLibrary.com for more great carving patterns.

HOT CUP WRAP

Design by George Hurst. Pattern is reproduced at 100%.

Cut wraps from 4 to 5 oz. Vegetable Tanned Cowhide

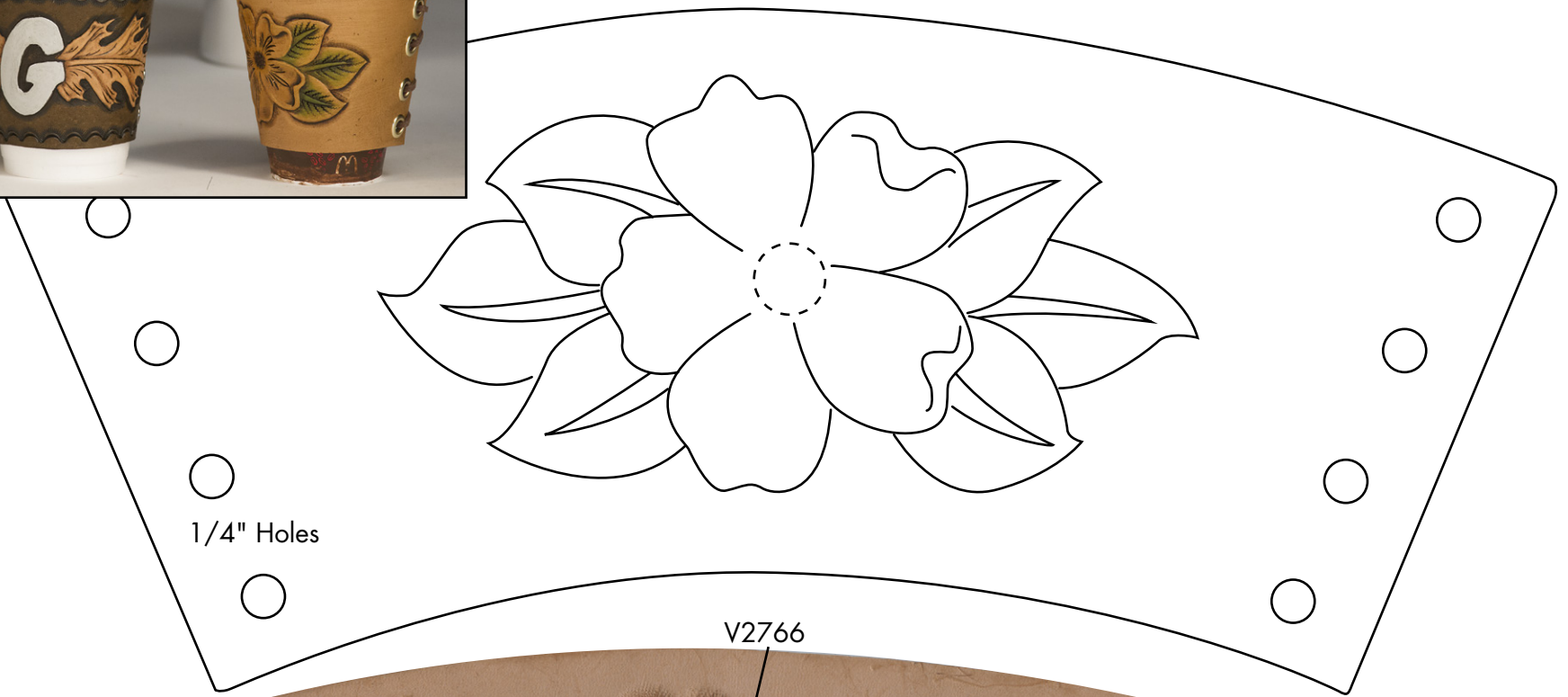

1/4" Holes

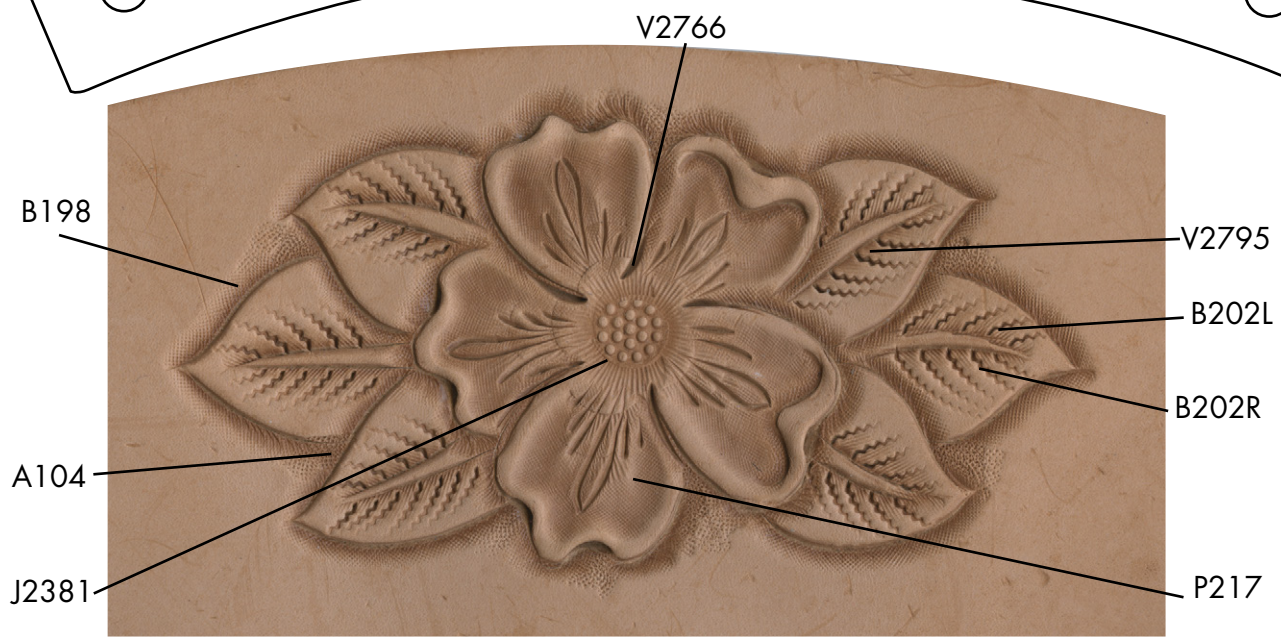

V2766

B198

V2795

B202L

B202R

A104

P217

J2381

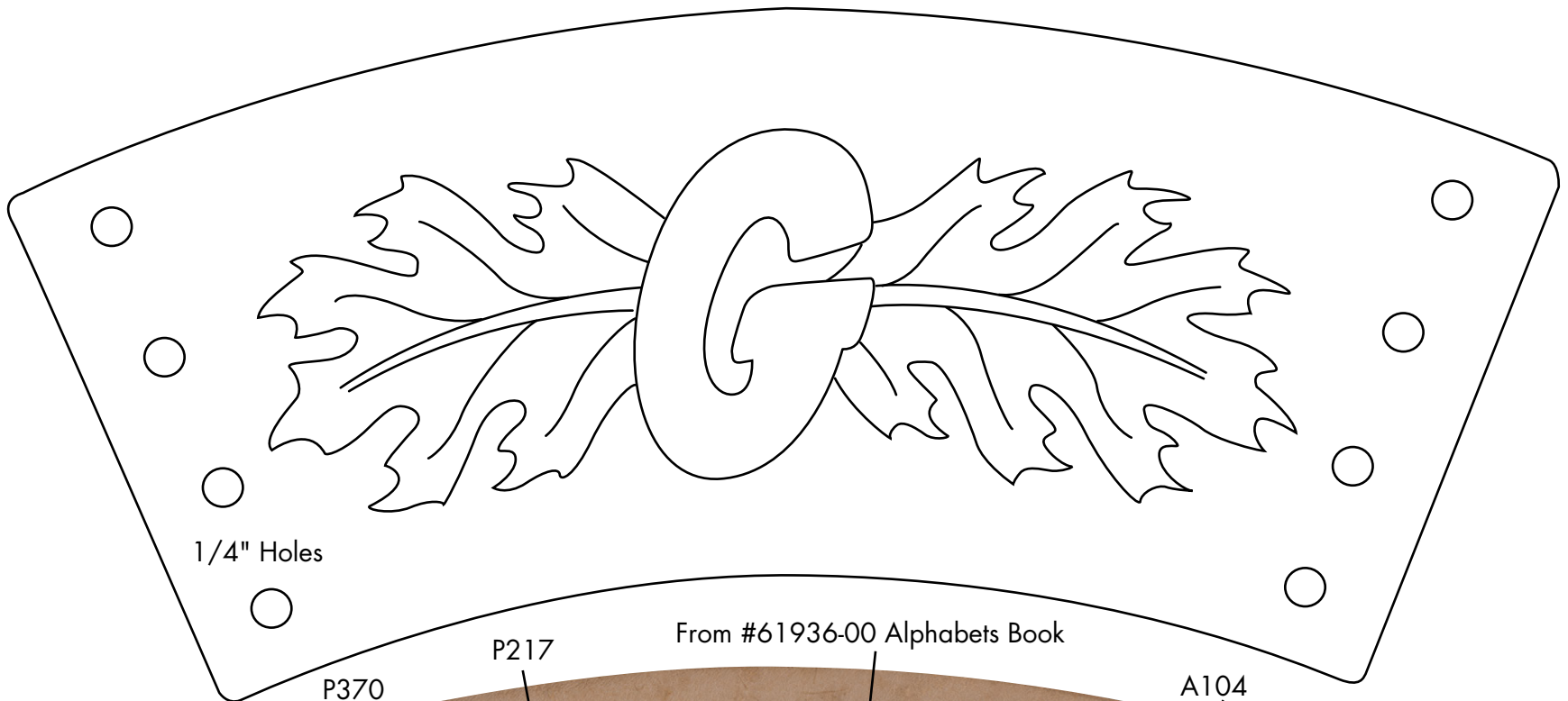

1/4" Holes

From #61936-00 Alphabets Book

P370

P217

A104



B198

B936

Hair Blade

B202L

B202R

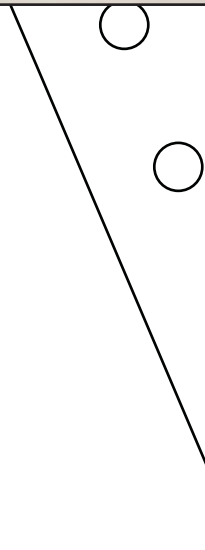
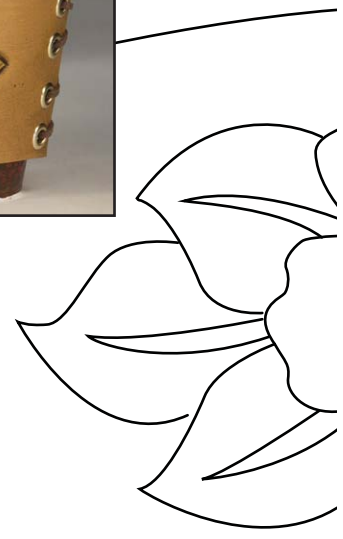

1/4" Holes

B198

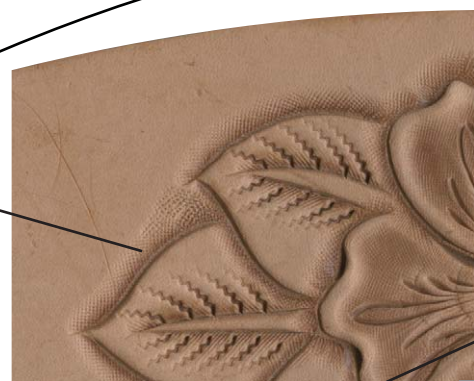



DIGITAL MEDIA FOR LEATHERCRAFTERS

LeathercraftLibrary.com

Visit www.tandyleather.com for all the supplies needed to complete this project.
Visit www.LeanercraftLibrary.com for more great carving patterns.

HOT CUP WRAP

Design by George Hurst. Pattern is reproduced at 100%.

Cut wraps from 4 to 5 oz. Vegetable Tanned Cowhide

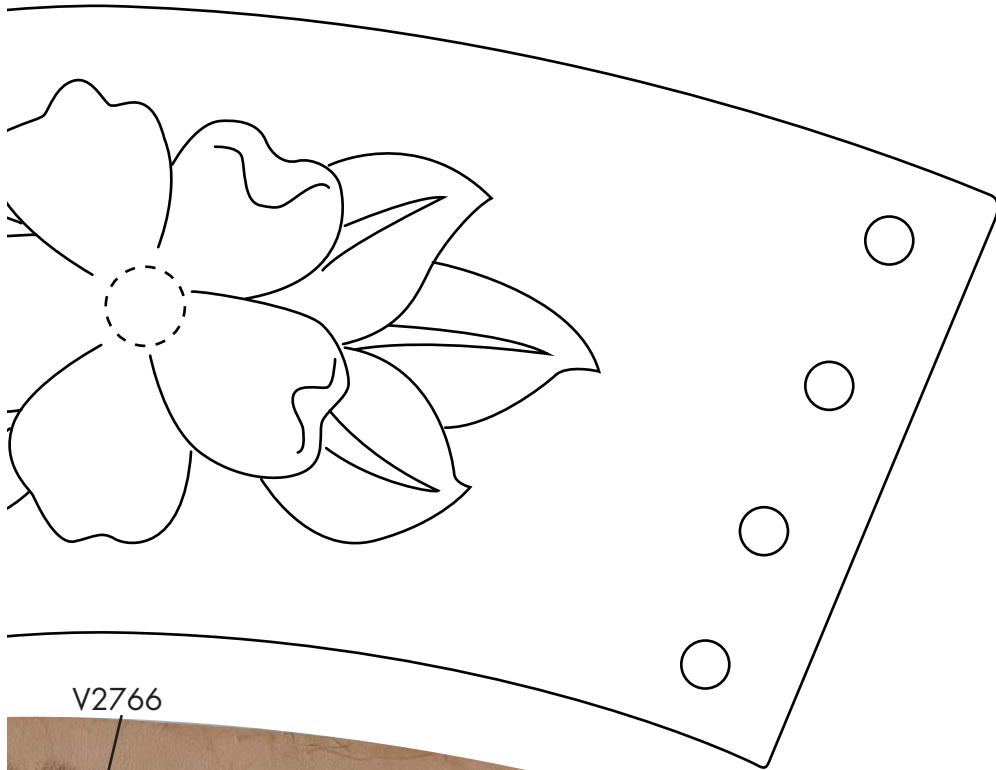

V2766



V2795

B202L

B202R

A104

J2381

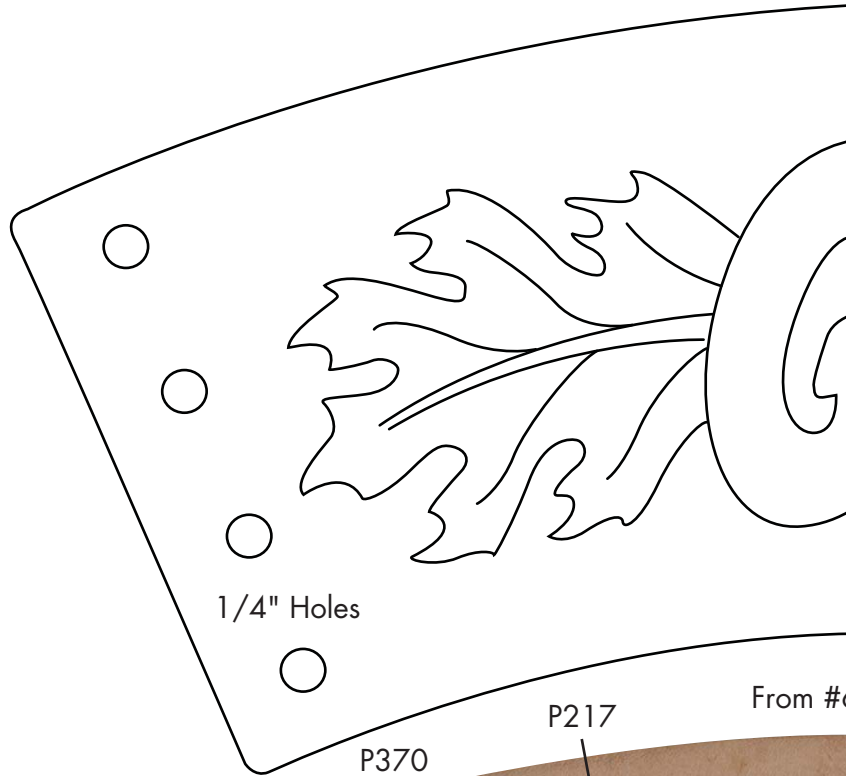
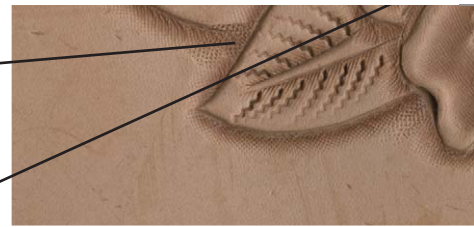

1/4" Holes

From #c

P370

P217



Hair Blade



©2014 Tandy Leather. All rights reserved.

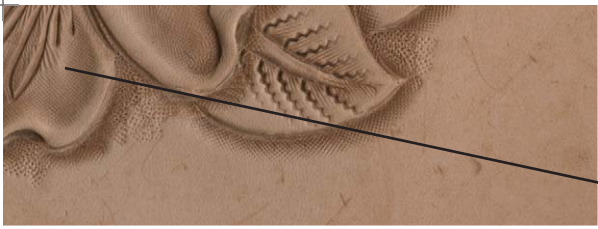

P217

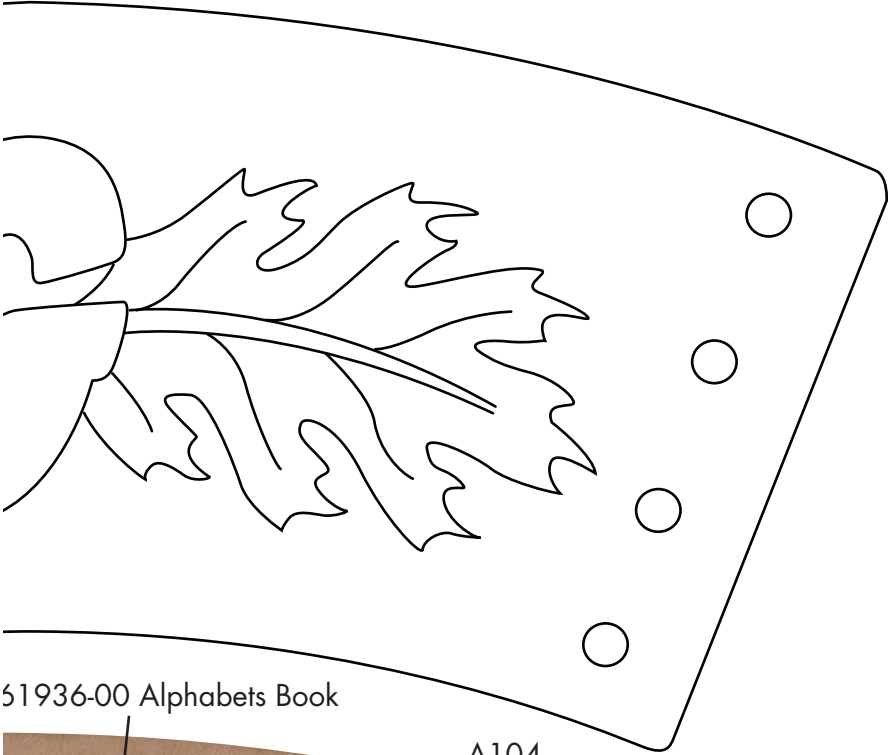

51936-00 Alphabets Book

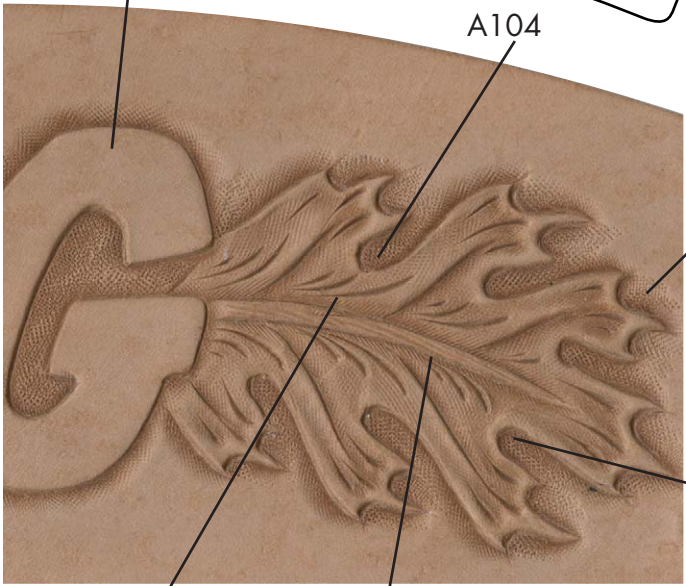

A104

B198

B936

B202L

B202R