

Project Name _____ Qty _____

Type _____ Catalog / Part Number _____

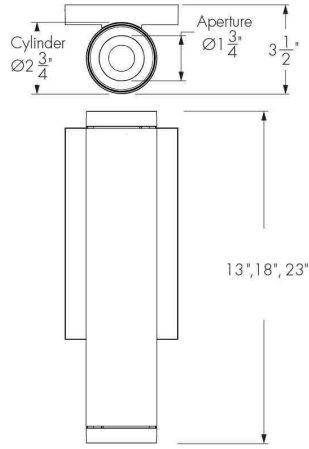

ADA compliant



Top view

Front view

Photometric Summary

Based on Wide Faceted Reflector (nominal 60°), 4000K, CRI 90+

Nominal output [lm]	Delivered output [lm] ^[1]	Power (120V) [W] ^[2]	Efficacy [lm/W]	Power (277V) [W] ^[2]	Efficacy [lm/W]
700	744	6.5	114	8	93
1000	978	8	122	10	98
1300	1,330	11	121	13	102
2000	2,074	18	115	19	109

¹ Photometric performance is measured in compliance with IESNA LM-79-24.

² Consult website for latest IES files.

³ Add 3 watts per fixture when specifying Lumentalk™.

Optics

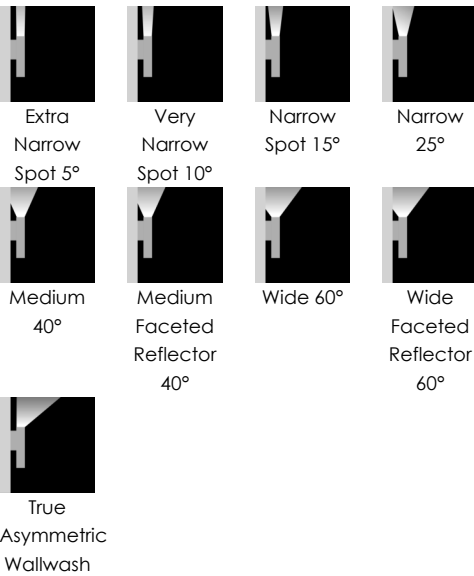

Description

The Lumencore Cylinder Nano Wall Mount Indirect is a high-performance LED luminaire that is ideal for commercial, residential or hospitality applications and delivers up to 2000 lumens from a 2.75 in diameter. The Lumencore Cylinder Nano Wall Mount Indirect comes in a number of finishes, or can be color-specified to fit your taste. Its accessories, beam angles, trims, and optics are easily and quickly changeable in the field.

Features

Mounting	Wall mount (ADA compliant)
Light Direction	Indirect lighting
Length	13 in, 18 in, 23 in
Indirect Lighting Output (Nominal Lumens)	700lm, 1000lm, 1300lm, 2000lm
Indirect Lighting Color Temperature	2200K, 2700K, 3000K, 3500K, 4000K, Dim to Warm (2700K to 2200K), Dim to Warm Plus (3500K to 1800K), Dynamic White (2700K to 6500K), Dynamic Warm White (2200K to 3000K), Dynamic Warm White Plus (2200K to 3500K)
Indirect Lighting Optics (Nominal Distribution)	Extra Narrow Spot 5°, Very Narrow Spot 10°, Narrow Spot 15°, Narrow 25°, Medium 40°, Medium Faceted Reflector 40°, Wide 60°, Wide Faceted Reflector 60°, True Asymmetric Wallwash
Optical Accessories	Snoot, Half Snoot, Honeycomb Louver, Concentric Ring Louver, Clear Glass Lens, Softening Glass Lens, Prismatic Diffuser, Linear Spread Lens Narrow (1° x 40°), Linear Spread Lens Wide (1° x 60°), Decorative Ring
Warranty	5-year limited warranty
Performance	
Maximum Delivered Output	Up to 2,074 lm (wide faceted optic 60°, 4000K, CRI 80)
Maximum Delivered Intensity	Up to 29,582 cd (extra narrow spot optic 5°, 4000K, CRI 80)

Colors and Color Temperatures

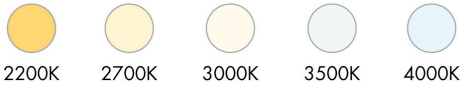

Controls

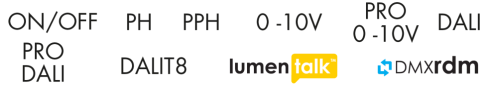

Finishes



Certifications



Efficacy	Up to 134 lm/W (narrow spot optic 15°, 4000K, CRI 80)
Color Consistency	2 SDCM, 3 SDCM (XN optic only)
Color Rendering	CRI 80+, CRI 90+, CRI 95+
Lumen Maintenance	L95 55,000 hrs L70 225,000 hrs
UGR	< 19 (not applicable to WW optic)

Physical

Weight	Up to 4.75 lbs
Housing Material	Aluminum
TIR Optics Material	Clear polycarbonate
Reflector Material	Aluminum

Electrical and Control

Voltage	120 Volts, 277 Volts
Control	On/Off Control, Phase Dimming, Phase Dimming 1%, Standard 0-10V Dimming 1% (Linear or Logarithmic Curve), Professional 0-10V Dimming 0.1% (Linear or Logarithmic Curve), Standard DALI Dimming 1% (Linear or Logarithmic Curve), Professional DALI Dimming 0.1% (Linear or Logarithmic Curve), DALI-2 T8 Enabled Dimming 1%, Professional DALI Dimming 0.1% (Linear or Logarithmic Curve), Lumentalk Enabled Dimming, DMX/RDM Enabled Dimming 1%

Environmental

Environment	Damp location (interior applications only)
Operating Temperature	-4 °F to 86 °F
Ingress Protection Rating	IP20

Accessories (Order Separately)

Control Boxes	DMX/RDM enabled (Daisy Chain or Star Configuration), Ethernet enabled (Daisy Chain or Star Configuration)
Control Systems	Pharos® Designer Lighting Control Kit (PHAROS), Consult Control Systems section for details
Diagnostic and Addressing Tools	LumenID (LID)

Important

Virtual Patent Marking Notice

This website (<https://www.lmpg.com/patents-trademarks>) is provided to satisfy the virtual patent marking provisions of applicable jurisdictions. Some products listed may be covered by additional patents not referenced here.

Fixture Dimension (ADA Compliant)

13 in

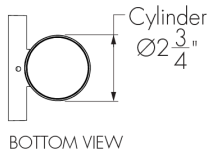
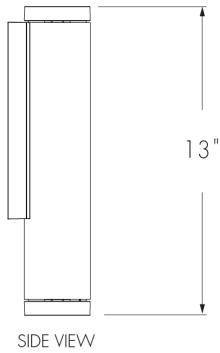
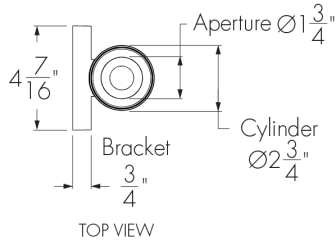

18 in

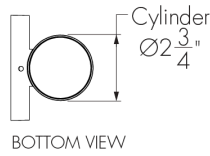
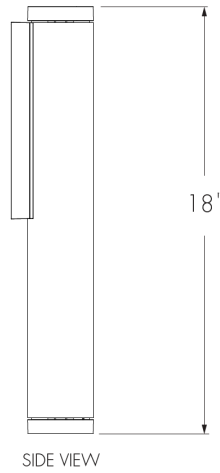
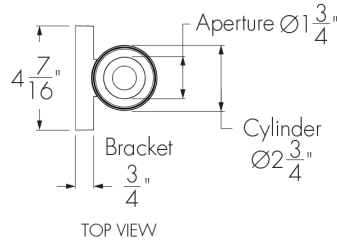

23 in

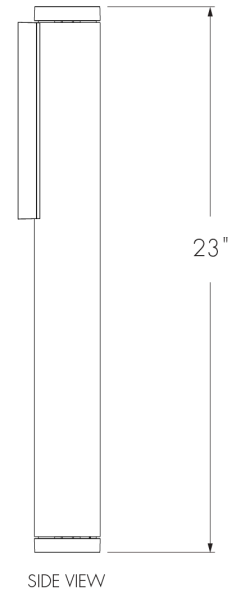
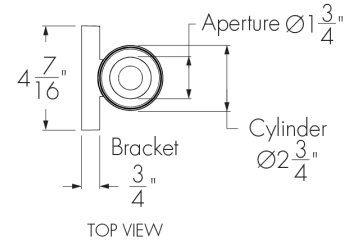

Mounting Bracket Details (ADA compliant)

Fixture 13 in

Fixture 18 in

Fixture 23 in

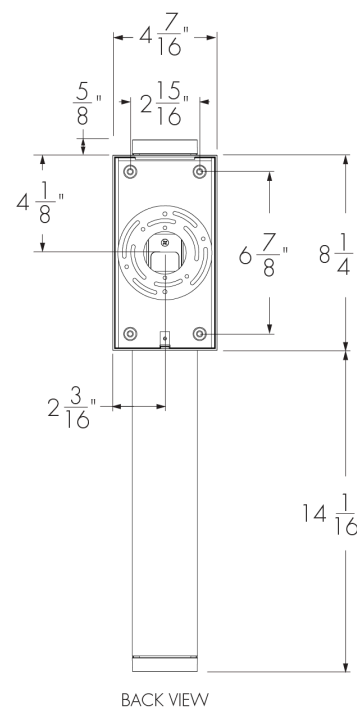
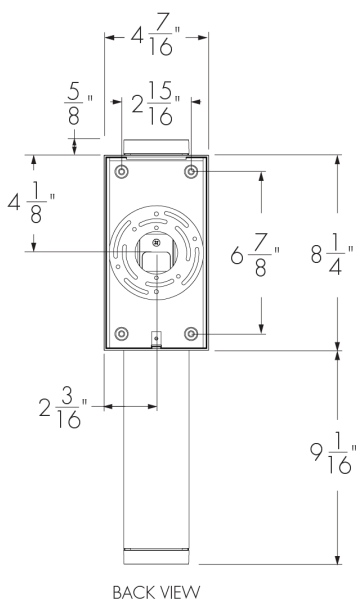
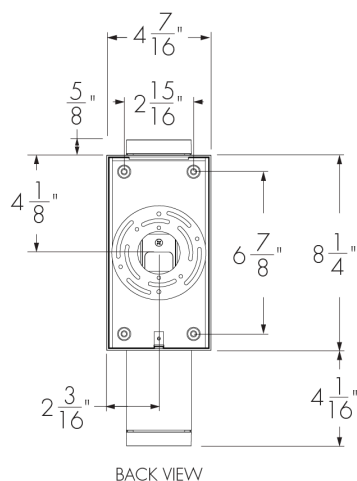

Optical Accessory Dimensions (13 in Fixture Shown)

Snoot

Half Snoot

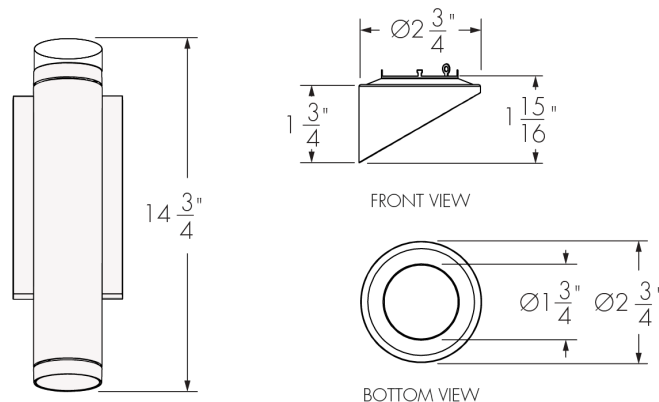
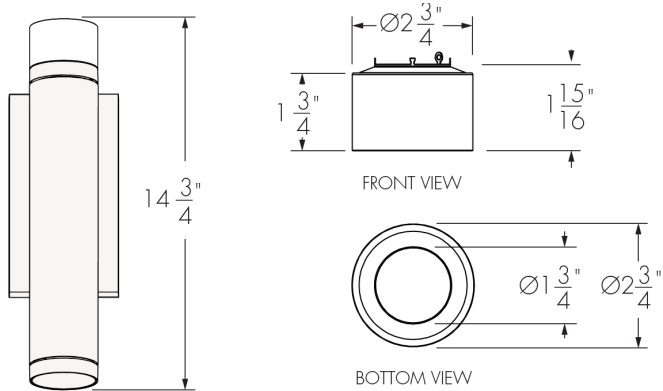

Photometric Information - Color Rendering Options Comparison, 3000K

Color sample	Ra	R1	R2	R3	R4	R5	R6	R7	R8	R9	R10	R11	R12	R13	R14	R15
CRI 80+	84	82	90	97	83	82	88	86	63	15	77	83	68	84	98	75
CRI 90+	94	95	98	99	95	94	97	91	80	55	93	97	83	96	99	89
CRI 95+	97	96	97	99	96	96	95	96	97	97	96	95	86	96	98	97
Radiant CRI 80+	84	83	91	96	81	82	89	83	62	15	79	80	69	85	98	76
Radiant CRI 95+	95	95	94	95	98	94	90	94	96	96	89	95	80	94	98	96

Optics

TIR Optic
XN/VN/NS/N



Semi-Specular reflector
M/W



Faceted reflector
MFR/VFR



Color and Color Temperature

Color Temperature Ranges

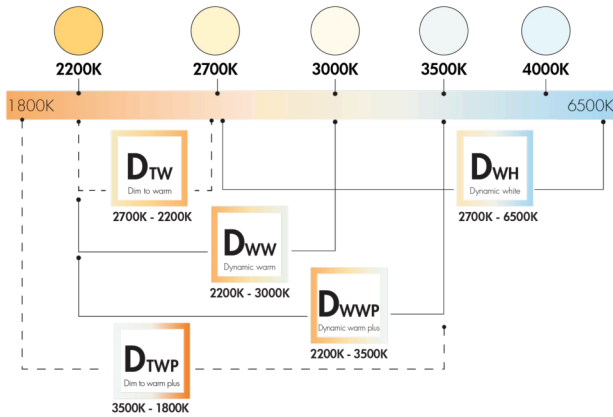

- 1 channel (DTW, DTWP) Compatible with: DA1 SDALI DMXRdm lumen talk
 - 2 channels (DWH, DWW, DWWP) Compatible with: DALI8 DMXRdm lumen talk
 - 3 channels* (DWH, DWW, DWWP) Compatible with: DALI8 DMXRdm lumen talk
- * Can be field changeable via RDM & IT for individual CCT control.

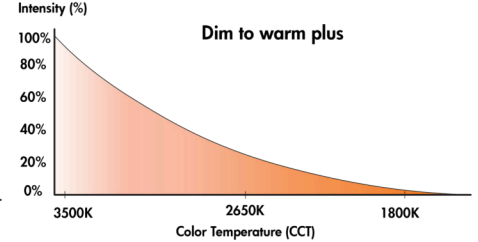
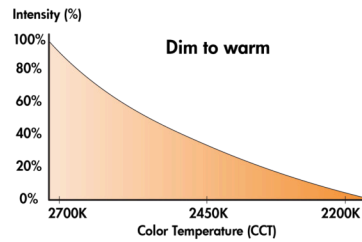

Control

On/off control

NO - On/off control

Phase dimming

PH - Phase dimming

PPH - Phase 1% dimming

Standard 0-10V dimming down to 1%

DAMC - Standard 0-10V dimming to 1% linear curve

DA1 - Standard 0-10V dimming, 1% linear

DA2 - Standard 0-10V dimming, 1% logarithmic

Professional 0-10V dimming down to 0.1%

PDA1 - Pro 0-10V dimming, 0.1% linear

PDA2 - Pro 0-10V dimming, 0.1% logarithmic

Standard DALI dimming down to 1%

SDALI1 - Standard DALI dimming, 1% linear

SDALI2 - Standard DALI dimming, 1% logarithmic

Professional DALI dimming down to 0.1%

DALI1 - Pro DALI dimming, 0.1% linear

DALI2 - Pro DALI dimming, 0.1% logarithmic

Refer to How to Order Pages and the website product configurator for exceptions.

DALI dimming Type 8

DALI8 - DALI-2 dimming Type 8 (multi channel capability)

lumen talk dimming

LT - Lumentalk dimming, 1% minimum dimming value

DMXRdm

DMX/RDM - DMX/RDM enabled

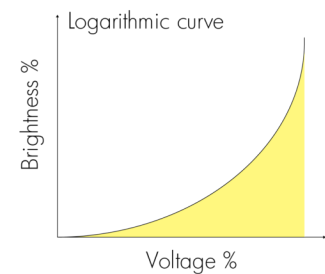
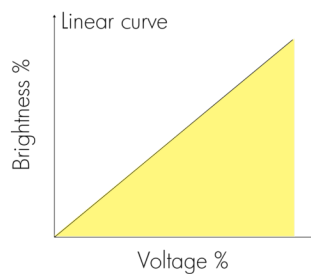

Photometric Information - Indirect Lighting Optics

XN - Extra Narrow Spot (Nominal 5°), 4000K

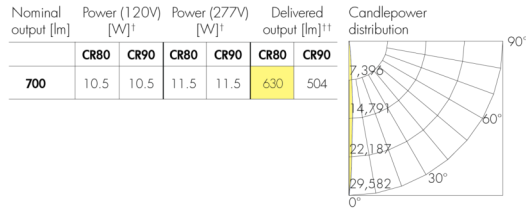

VN - Very Narrow Spot (Nominal 10°), 4000K

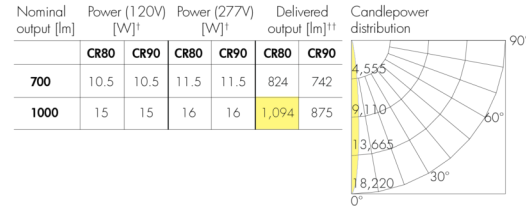

NS - Narrow Spot (Nominal 15°), 4000K

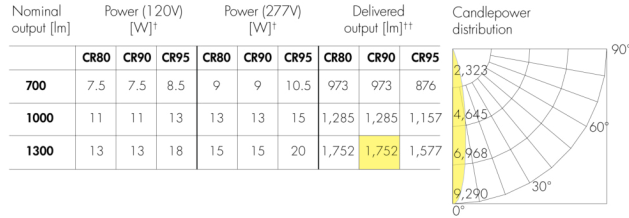

N - Narrow (Nominal 25°), 4000K

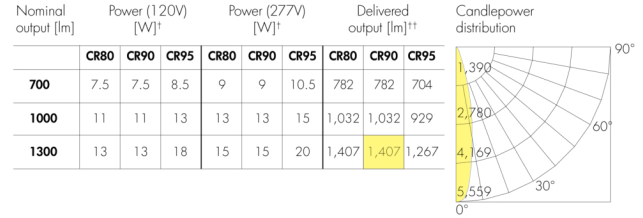

M - Medium (Nominal 40°), 4000K

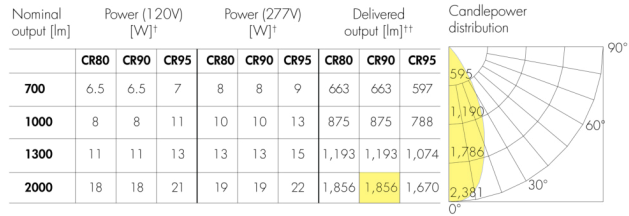

MFR - Medium Faceted Reflector (Nominal 40°), 4000K

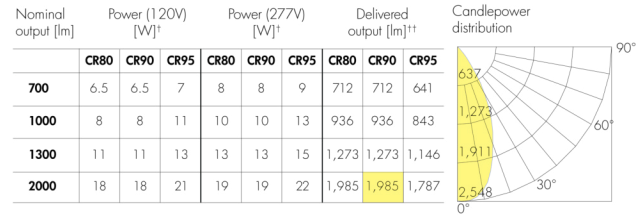

W - Wide (Nominal 60°), 4000K

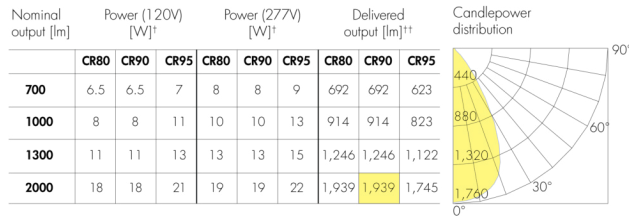

WFR - Wide Faceted Reflector (Nominal 60°), 4000K

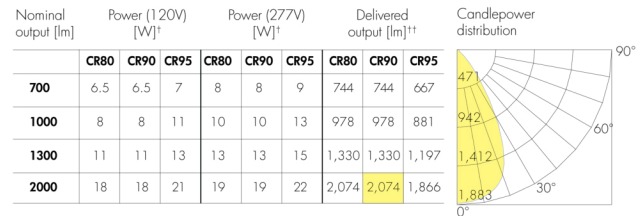

† Delivered wattage: +/- 10% tolerance. Add 3 watts per fixture when specifying Lumentalk™.
†† Consult website for latest IES files. Delivered output: +/- 10% tolerance.

Typical Wiring Diagrams (Refer to Installation Instructions for Additional Wiring Details)

On/Off Control (NO)

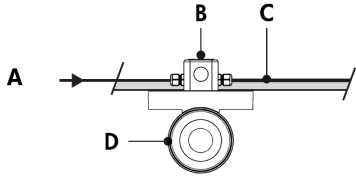

- A** - Power input (120-277V)
- B** - Octagonal or single gang junction box (by others)
- C** - Power wiring (by others)
- D** - Lumencore Cylinder Nano Wall Mount Indirect

On/Off Control (NO) - Wiring Detail

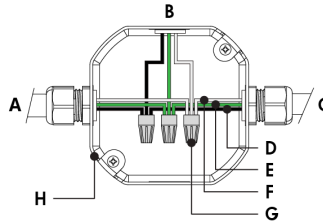

- A** - Power input or from previous fixture
- B** - To fixture
- C** - To next fixture
- D** - Line
- E** - Ground
- F** - Neutral
- G** - Wire-nuts (by others)
- H** - Octagonal or single gang junction box (by others)

Wiring Color Code

Color	USE
Green	Ground
Black	Line
White	Neutral
Red or purple	0-10V / Data +
Orange or grey	0-10V / Data -

- Consult factory for specific applications and maximum fixture count/cable length recommendations.
- Consult Photometric Information pages for wattage information.

Phase Dimming (PH, PPH)

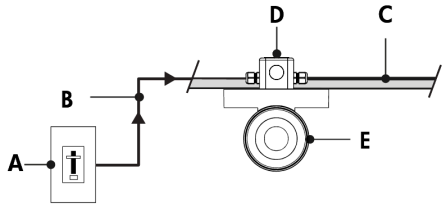

- A** - Phase dimmer (by others)
- B** - Phase dimmed power circuit (120V)
- C** - Power wiring (by others)
- D** - Octagonal or single gang junction box (by others)
- E** - Lumencore Cylinder Nano Wall Mount Indirect

Phase Dimming (PH, PPH) - Wiring Detail

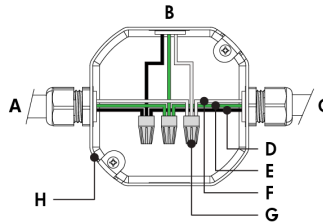

- A** - Power input or from previous fixture
- B** - To fixture
- C** - To next fixture
- D** - Line
- E** - Ground
- F** - Neutral
- G** - Wire-nuts (by others)
- H** - Octagonal or single gang junction box (by others)

Wiring Color Code

Color	USE
Green	Ground
Black	Line
White	Neutral
Red or purple	0-10V / Data +
Orange or grey	0-10V / Data -

- Consult factory for specific applications and maximum fixture count/cable length recommendations.
- Consult Photometric Information pages for wattage information.

0-10V Dimming (DAMC, DA1, DA2, PDA1, PDA2)

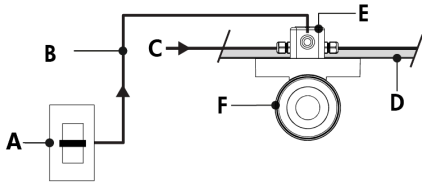

- A - Dimmer (by others)
- B - Data wiring (by others)
- C - Power input (120-277V)
- D - Power and data wiring (by others)
- E - Octagonal or single gang junction box (by others)
- F - Lumencore Cylinder Nano Wall Mount Indirect

0-10V Dimming (DAMC, DA1, DA2, PDA1, PDA2) - Wiring Detail

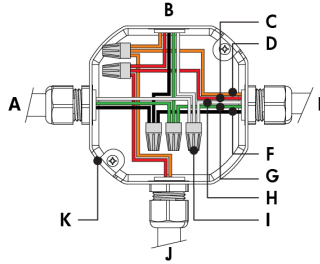

- A - Power input or from previous fixture
- B - To fixture
- C - 0-10V +
- D - 0-10V -
- E - To next fixture
- F - Line
- G - Ground
- H - Neutral
- I - Wire-nuts (by others)
- J - Dimmer (by others)
- K - Octagonal or single gang junction box (by others)

Wiring Color Code

Color	USE
Green	Ground
Black	Line
White	Neutral
Red or purple	0-10V / Data +
Orange or grey	0-10V / Data -

- Consult factory for specific applications and maximum fixture count/cable length recommendations.
- Consult Photometric Information pages for wattage information.

Lumentalk (LT)

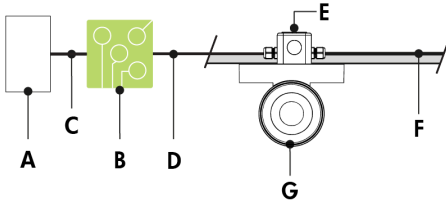

- A - Dimmer/controller (by others)
- B - Lumentranslator 2 (LTL2-DIM, -DMX, -TRIAC, -DALI)
- C - Data wiring (by others)
- D - Power line (120-277V AC)
- E - Octagonal or single gang junction box (by others)
- F - Power wiring (by others)
- G - Lumencore Cylinder Nano Wall Mount Indirect

Lumentalk (LT) - Wiring Detail

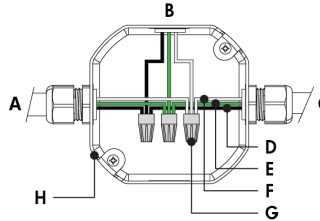

- A - Power input (control over power line via Lumentalk system) or from previous fixture
- B - To fixture
- C - To next fixture
- D - Line
- E - Ground
- F - Neutral
- G - Wire-nuts (by others)
- H - Octagonal or single gang junction box (by others)

Wiring Color Code

Color	USE
Green	Ground
Black	Line
White	Neutral
Red or purple	0-10V / Data +
Orange or grey	0-10V / Data -

- Consult factory for specific applications and maximum fixture count/cable length recommendations.
- Lumentalk enabled fixtures must be commissioned using LumentalkID software and a LID-LT. Consult factory for details.
- Maximum of 1 transmitter (Lumentranslator 2 or Lumenlink) per system. No third party fixtures allowed on the same circuit.
- For DMX applications: 1 DMX controller per Lumentalk network, maximum of 48 DMX channels per Lumentalk network (minimum step transition update rate is 1 second, minimum fade time between two colors is 1 minute). Consult factory for DALI Lumentalk applications. Consult factory for applications that require additional capabilities.
- Consult Photometric Information pages for wattage information.

Optical Accessories

SN - Snoot



LACYN - SN

XLVR - Concentric Ring Louver



LACYN - XLVR

PD - Prismatic Diffuser



LACYN - PD

DR - Decorative Ring



LACYN - DR

Control Boxes (Order Separately)

CBX-DMX/RDM - DMX/RDM Enabled (Daisy Chain or Star Configuration)

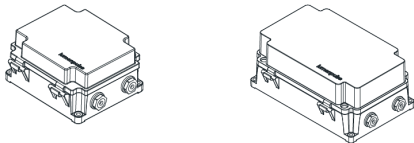

DMX/RDM control box. Up to six power and data outputs to fixtures or fixture runs. Consult CBX specification sheet and installation instructions for details. Lumenterminators provided with CBX (2x for Daisy Chain configuration, 6x for Star configuration), consult factory to order spares.

CBX-ENET - Ethernet Enabled (Daisy Chain or Star Configuration)

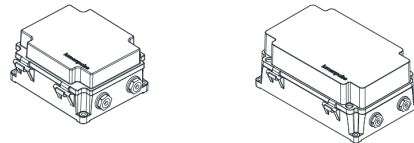

Ethernet control box. Up to four power and data outputs to fixture or fixture runs. Consult Ethernet CBX specification sheet and installation instructions for details.

HSN - Half Snoot



LACYN - HSN

CL - Clear Glass Lens



LACYN - CL

LSN - Linear Spread Lens Narrow (1° x 40°)

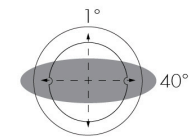

Horizontal Beam Distribution

LACYN - LSN

HL - Honeycomb Louver

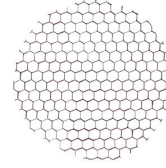

LACYN - HL

SL - Softening Glass Lens



LACYN - SL

LSW - Linear Spread Lens Wide (1° x 60°)

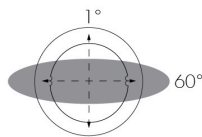

Horizontal Beam Distribution

LACYN - LSW

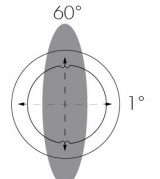

Vertical Beam Distribution

Diagnostic And Addressing Tools (Order Separately)

LID - LumenID



The updated LumenID (LID) is an all-in-one diagnostic and addressing solution for both DMX/RDM and Lumentalk (LT) systems. Engineered for versatility, it streamlines commissioning and troubleshooting across protocols—no need for multiple tools. Cable option may vary; please consult factory. For complete details, refer to the LID specification sheet.

Control Systems (Order Separately)

PHAROS - Pharos® Designer Lighting Control Kit

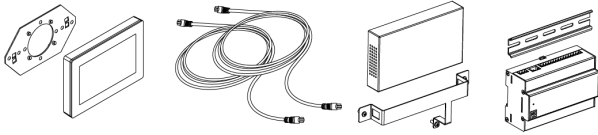

The Pharos Designer Lighting Control Kit, available for 1 or 2 DMX universes, allows for complete control of large lighting installations.

EXPERT - Pharos® Expert Control Kit

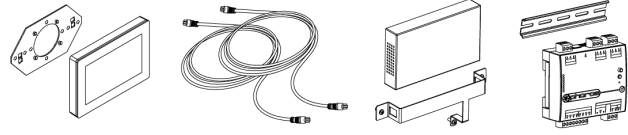

The Pharos Expert Control Kit, available for 1, 2, 4 or 6 DMX universes, allows for complete control of large lighting installations.

How to Order

Housing ⁽¹⁾	Certification	Mounting	Light Direction	Voltage	Length	Indirect Lighting Output (Nominal Lumens)	Indirect Lighting Color Temperature	Indirect Lighting Color Rendering	Indirect Lighting Optics (Nominal Distribution)
LACYN Lumencore Cylinder Nano - Ø2 3/4 in	A UL/cUL	WM Wall mount (ADA compliant)	I Indirect lighting	120 120 Volts	13 13 in	iL07 700lm	22K 2200K ^{(4) (5)}	CR80 CRI 80+ ⁽¹⁰⁾	XN Extra Narrow Spot 5° ⁽¹²⁾
				277 277 Volts	18 18 in	iL10 1000lm ⁽²⁾	27K 2700K	CR90 CRI 90+	VN Very Narrow Spot 10° ⁽¹²⁾
					23 23 in	iL13 1300lm ⁽²⁾	30K 3000K	CR95 CRI 95+	NS Narrow Spot 15° ⁽¹³⁾
						iL20 2000lm ⁽³⁾	35K 3500K	RCR80 Radiant CRI 80+ ^{(5) (11)}	N Narrow 25° ⁽¹³⁾
							40K 4000K	RCR95 Radiant CRI95+ ^{(5) (11)}	M Medium 40°
							DTW Dim to Warm (2700K to 2200K) ^{(6) (7) (8)}		MFR Medium Faceted Reflector 40°
							DTWP Dim to Warm Plus (3500K to 1800K) ^{(6) (7) (8)}		W Wide 60°
							DWH Dynamic White (2700K to 6500K) ^{(7) (8) (9)}		WFR Wide Faceted Reflector 60°
							DWW Dynamic Warm White (2200K to 3000K) ^{(7) (8) (9)}		WW True Asymmetric Wallwash ^{(13) (14)} ⁽¹⁵⁾
							DWWP Dynamic Warm White Plus (2200K to 3500K) ^{(7) (8) (9)}		

Notes:

1. Refer to website product configurator for all exceptions.
2. Available for NS, N, M, MFR, W, WFR and WW optics only.
3. Available for M, MFR, W and WFR optics only.
4. Available for CR80 only.
5. Not available for XN and VN optics.
6. Available for 1000 lumens when combined with CR90 and MFR, W or WFR optics only.
7. MFR and WFR faceted reflector optics are recommended for optimal performance.
8. Not available for WW optic.
9. Available for 700 lumens when combined with CR80 and MFR, W or WFR optics only.
10. Available for 2200K, 2700K, 3000K, 3500K, 4000K and DWH, DWW or DWWP color options only.
11. Radiant CRI options available for 3000K only.
12. Available for 700 lumens when combined with CR80 or CR90 color rendering options only.
13. Available up to 1300 lumens.
14. Accessories not available for WW optic.
15. The color of the true asymmetric wallwash baffle matches the fixture bezel.

How to Order

Indirect Lighting Control ⁽¹⁴⁾	Indirect Lighting Accessories ⁽¹⁴⁾ ⁽³⁶⁾ ⁽³⁷⁾	Finish	Bezel	Bezel Finish
NO On/Off Control ⁽¹⁷⁾ ⁽¹⁸⁾ ⁽¹⁹⁾	NA No Accessory	MWH Matte White	b Bezel	MWH Matte White
PH Phase Dimming ⁽¹⁸⁾ ⁽¹⁹⁾ ⁽²⁰⁾ ⁽²¹⁾	SN Snoot ⁽³⁸⁾	MBK Matte Black		MBK Matte Black
PPH Phase Dimming 1% ⁽⁵⁾ ⁽¹⁹⁾ ⁽²¹⁾ ⁽²²⁾	HSN Half Snoot ⁽³⁸⁾	MBR Matte Brown		MBR Matte Brown
DAMC Standard 0-10V Dimming 1% Linear Curve ⁽¹⁹⁾ ⁽²³⁾ ⁽²⁴⁾ ⁽²⁵⁾	HL Honeycomb Louver ⁽³⁹⁾	MOR Matte Orange		MOR Matte Orange
DA1 Standard 0-10V Dimming 1% Linear Curve ⁽¹⁸⁾ ⁽²⁶⁾ ⁽²⁷⁾	XLVR Concentric Ring Louver ⁽⁴⁰⁾	MGR Matte Green		MGR Matte Green
DA2 Standard 1-10V Dimming 1% Logarithmic Curve ⁽¹⁸⁾ ⁽²⁶⁾ ⁽²⁷⁾	CL Clear Glass Lens	MBL Matte Blue		MBL Matte Blue
PDA1 Professional 0-10V Dimming 0.1% Linear Curve ⁽¹⁸⁾ ⁽¹⁹⁾ ⁽²⁶⁾	SL Softening Glass Lens	MSI Matte Silver		MSI Matte Silver
PDA2 Professional 0-10V Dimming 0.1% Logarithmic Curve ⁽¹⁸⁾ ⁽¹⁹⁾ ⁽²⁶⁾	PD Prismatic Diffuser ⁽⁴¹⁾	GWH Glossy White		GWH Glossy White
SDALI1 Standard DALI Dimming 1% Linear Curve ⁽²⁸⁾	LSN Linear Spread Lens Narrow (1° x 40°) ⁽⁴²⁾ ⁽⁴³⁾	GBK Glossy Black		GBK Glossy Black
SDALI2 Standard DALI Dimming 1% Logarithmic Curve ⁽²⁸⁾	LSW Linear Spread Lens Wide (1° x 60°) ⁽⁴³⁾ ⁽⁴⁴⁾	GYL Glossy Yellow		GYL Glossy Yellow
DALI1 Professional DALI Dimming 0.1% Linear Curve ⁽¹⁸⁾ ⁽¹⁹⁾ ⁽²⁹⁾	DR Decorative Ring ⁽⁴⁵⁾	GLR Glossy Red		GLR Glossy Red
DALI2 Professional DALI Dimming 0.1% Logarithmic Curve ⁽¹⁸⁾ ⁽¹⁹⁾ ⁽²⁹⁾		GVI Glossy Violet		GVI Glossy Violet
DALI8 DALI-2 T8 Enabled Dimming 1% ⁽³⁰⁾ ⁽³¹⁾		GGR Glossy Green		GGR Glossy Green
LT Lumentalk Enabled Dimming ⁽³²⁾ ⁽³³⁾		GIY Glossy Ivory		GIY Glossy Ivory
DMX/RDM DMX/RDM Enabled Dimming 1% ⁽³⁴⁾ ⁽³⁵⁾		CGY Concrete Gray		CGY Concrete Gray
		MLG Metalized Gray		MLG Metalized Gray
		IBR Italian Brick Red		IBR Italian Brick Red
		PWH Parget White		PWH Parget White
		CC Custom Color & Finish ⁽⁴⁶⁾		CC Custom Color & Finish ⁽⁴⁶⁾

Notes:

- 5. Not available for XN and VN optics.
- 14. Accessories not available for WW optic.
- 16. Control options vary according to color temperature, color rendering and optics combination. Refer to website product configurator for details.
- 17. Manufacturer's choice driver. Order code may change to NO1.
- 18. Available up to 1300 lumens (CR80, RCR80, CR90, CR95 or RCR95) for M, MFR, W and WFR optics.
- 19. Not available for DTW, DTWP, DWH, DWW or DWWP color options.
- 20. Manufacturer's choice driver. Order code may change to PH1 or PH2.
- 21. Available for 120V voltage option only.
- 22. Manufacturer's choice driver. Order code is subject to change.
- 23. Manufacturer's choice driver. Order code may change to DAMC1 or DAMC2.
- 24. Not available for XN and VN optics.
- 25. Available up to 2000 lumens when combined with CR80 color rendering option. Available up to 1300 lumens when combined with CR90 or CR95 color rendering options.
- 26. Driver cuts off power to the fixture when the control signal drops below 0.5V.
- 27. Not available for DWH, DWW or DWWP color options.
- 28. Available for DTW and DTWP color options only, when combined with 1000 lumens.
- 29. Consult factory for other DALI control options for static color temperatures.
- 30. Available for DWH, DWW and DWWP color options only. DALI-2 Type 8 controller required.
- 31. Consult factory for DALI8 control option.
- 32. Available up to 1300 lumens (CR80, RCR80, CR90, CR95 or RCR95).
- 33. A Lumentranslator 2 (LTL2) and LumenID (LID) must be specified for Lumentalk applications. Consult Lumentranslator 2 and Lumentalk pages and specification sheets for details.
- 34. A Control Box (CBX-DS or CBX-ST) and LumenID (LID) must be specified.
- 35. Configurable to 1, 2, or 3 channel control via RDM in the field.
- 36. Accessories specified in the fixture code are factory installed but can also be changed in the field. Refer to installation instructions for details. To order accessories separately, refer to the Optical Accessories section of the specification sheet.
- 37. Maximum of two lenses can be installed per fixture. The Snoot (SN) or Half Snoot (HSN) can be combined with any accessory. The Clear Glass Lens (CL) and Softening Glass Lens (SL) cannot be combined together. The Linear Spread Lenses (LSN and LSW) are compatible with the Snoot and Half Snoot accessories only.
- 38. Matte black interior surface, exterior finish matches housing color.
- 39. When combined with another accessory, the HL will be factory-installed in second position (furthest from the LED source).
- 40. Available for XN, VN and NS optics only.
- 41. Can be combined with HL accessory for 2200K, 2700K, 3000K, 3500K and 4000K color options only.
- 42. Nominal 10° x 40° distribution when used with the NS optic.
- 43. Available for XN, VN, NS, N and MFR optics when combined with 2200K, 2700K, 3000K, 3500K, 4000K color options. Available for MFR optic only when combined with DTW, DTWP, DWH, DWW or DWWP color options only.
- 44. Nominal 10° x 60° distribution when used with the NS optic.
- 45. No other accessories can be combined with the decorative ring accessory. A decorative ring replaces the bezel on a fixture. Do not specify a bezel finish.
- 46. Longer lead times can be expected for custom RAL color finishes.