

Project Name _____ Qty _____
 Type _____ Catalog / Part Number _____

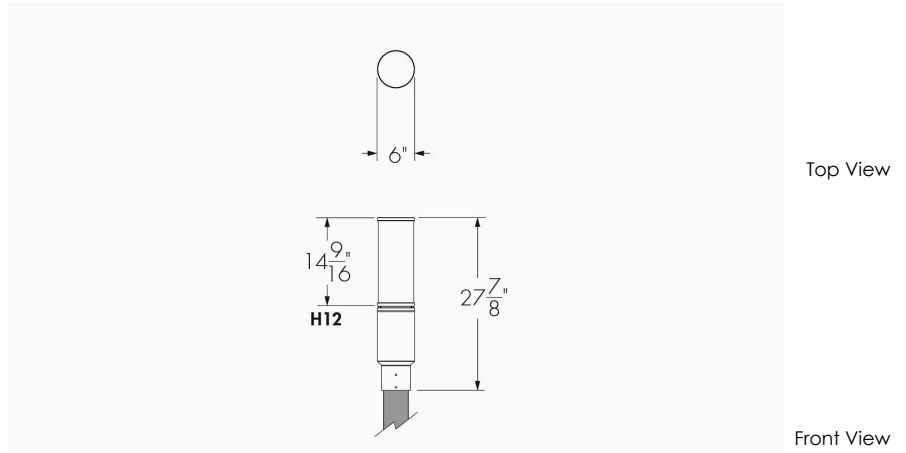

Distributions

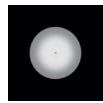

Type V

Color and Color Temperature

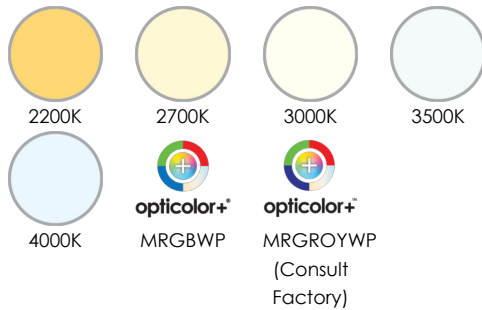

Color Rendering

CRI
90+

Control



Lumencycle™ Program



Ingress Protection Rating

IP66 (optical chamber)

Description

The Lumenalta Small Post-Top Direct View features a sleek, cylindrical form designed for metropolitan wayfinding and artistic applications. Using Lumenpulse's Opticolor+® technology, color-changing, tunable white, and Dim-to-Warm capabilities are blended into a single, versatile luminaire. Offering flawless uniformity and saturation across the lens, its dual-lens design evenly diffuses light for a clean, continuous viewing surface.

Features

Decorative Top Options	SPN00: No Decorative Top
Optical System	DVO: Direct View Optic
Lens Finish	O: Opal Lens
Color and Color Temperature	22K: 2200K 27K: 2700K 30K: 3000K 35K: 3500K 40K: 4000K MRGBWP: Opticolor+® Mix-at-Source Red, Green, Blue Plus White Settable Range 24K to 65K MRGROYWP: Opticolor+® Mix-at-Source Red, Green, Royal Blue Plus White Settable Range 24K to 65K
Distributions	5: Type V
Options	Corrosion-Resistant Coating for Hostile Environments Surge Protector Vibration Rated for Bridge and Overpass Normal Vibration Rating
Mounting Options	TN4: 4 in O.D. Tenon Adapter
Warranty	5-year limited warranty

Impact Resistance Rating

IK06
(PMMA
Lens)

Certifications



Performance

Color Rendering	CRI 90: CRI 90+ (White Light Only)
Maximum Delivered Output	1,844lm (4000K, CRI 90+) 950 lm (MRGBWP Optidrive™ Enabled)
Efficacy	Up to 92.2 lm/W (4000K, CRI 90+)
Color Consistency	1 SDCM for CRI 90+ (White Light Only)
Lumen Maintenance	White: L70 > 90,000 hrs Ta 25°C [77°F] (TM-21 reported) L70 > 100,000 hrs Ta 25°C [77°F] (projected)* Color: L70 > 60,000 hrs Ta 25°C [77°F] (TM-21 reported) L70 > 76,400 hrs Ta 25°C [77°F] (projected)* *Estimated based on in-situ case temperature and LM-80 report

Physical

Head Height	H12: 14 9/16 in
Housing Material	Cast aluminum, Extruded aluminum
Lens Material	Cast acrylic (PMMA)
Hardware Material	Stainless steel
Weight	13.2 lbs
EPA	SPN00: 1.16 ft²
Surface Finish	Super durable resistant exterior polyester powder coating meets AAMA 2604-98 requirements (5-years Florida exposure). A corrosion resistant finish (CRC) pre-finish is available to meet ASTM B-117 & ASTM D-1654 (salt spray resistance) and ASTM D-2247 requirements (humidity resistance).

Electrical and Control

Voltage	120: 120 Volts, 208: 208 Volts, 240: 240 Volts, 277: 277 Volts
Control	DIM: 0-10V Dimming LT: Lumentalk Enabled Dimming DMX/RDM: DMX/RDM Enabled Dimming DALI: DALI Dimming

Environmental

Storage Temperature	-40°C to 50°C [-40°F to 122°F] (device must reach start-up temperature value before operating)
Start-up Temperature	-40°C to 50°C [-40°F to 122°F]
Operating Temperature	-40°C to 50°C [-40°F to 122°F]
Ingress Protection Rating	IP66 (optical chamber)
Impact Resistance Rating	IK06 (PMMA Lens)
Environment	Dry/damp/wet location

Important

Virtual Patent Marking Notice

This website (<https://www.lmpg.com/patents-trademarks>) is provided to satisfy the virtual patent marking provisions of applicable jurisdictions. Some products listed may be covered by additional patents not referenced here.

Lumencycle™ Program

Lumencycle is a comprehensive program designed to maximize the life of Lumenpulse fixtures while preserving their performance, quality, and design intent. Built around three pillars—Repair, Restore, and Recycle—the program provides clear pathways to maintain existing installations, restore fixtures, and responsibly manage them at end of life. For full program details, visit <https://www.lumenpulse.com/lumencycle>.

Photometric Information

4000K, CRI 90+

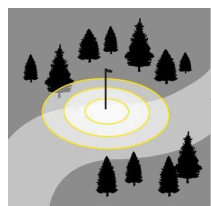
	Typical Delivered Output [lm]	Efficiency (lm/W)	BUG Rating			Typical Maximum Power 120/277V (W)
			B	U	G	
	1,844	92	1	4	2	20

MRGBWP Optidrive™ Enabled

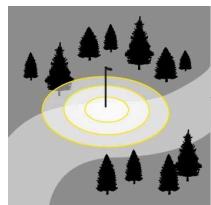
	Typical Delivered Output [lm]	Efficiency (lm/W)	BUG Rating			Typical Maximum Power 120/277V (W)
			B	U	G	
	950	45	0	3	1	21

Photometric performance is measured in compliance with IESNA LM-79-24. Due to rapid and continuous advance in LED technology, photometric information is subject to change without notice.

Typical Wiring Diagrams

Wiring Color Code

Color	Black	White	Green	Purple/Red	Gray/Orange
Use	Line	Line/Neutral	Ground	0-10V+ /Data +	0-10V- /Data -

0-10V Dimming (DIM)

0-10V Dimming (DIM) - Wiring Detail

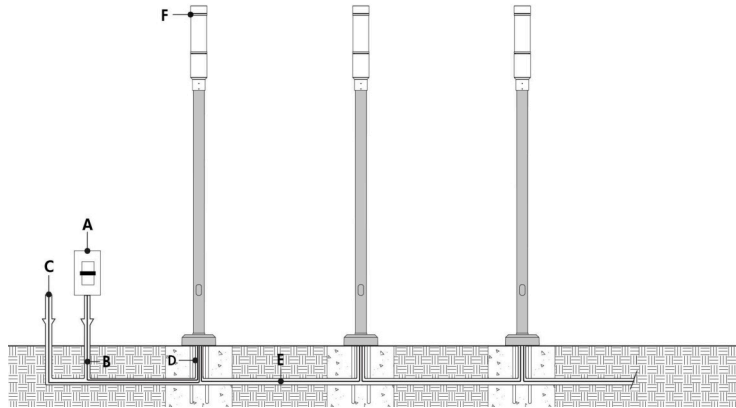

- A - Dimmer (by others)
- B - Data wiring (by others)
- C - Power input (120-277V, wiring by others)
- D - Conduit (by others)
- E - Power and data wiring (by others)
- F - Lumenalta Post-Top

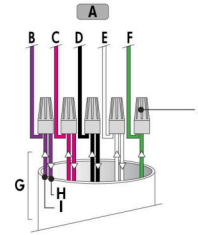

- A - To fixture
- B - 0-10V +
- C - 0-10V -
- D - Line
- E - Neutral
- F - Ground
- G - Conduit (by others)
- H - To next fixture
- I - Power input or from previous fixture
- J - Wire-nuts (by others)

- Consult factory for specific applications and maximum fixture count/cable length recommendations.
- 0-10V mA ratings: passive dimmer (Current Sink): 3mA per fixture, active dimmer (Current Source): 0.5mA per fixture.
- 1% minimum dimming value.

Lumentalk (LT)

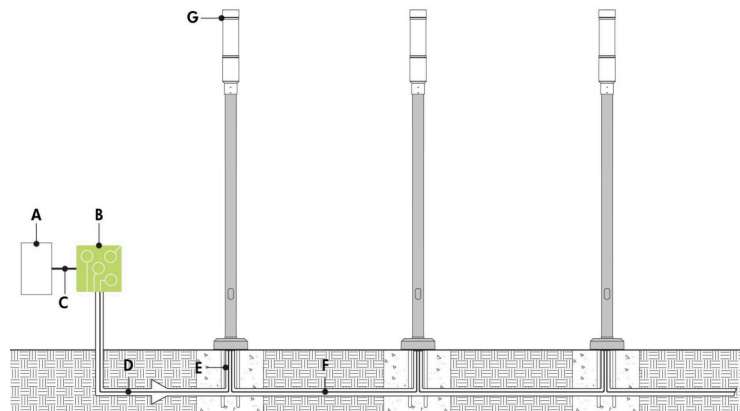

- A** - Dimmer/controller (order separately from Lumenpulse, or by others)
- B** - Lumentranslator (LTL-010, -DMX, -TRIAC, -DALI)
- C** - Data wiring (by others)
- D** - Power line (120-277V, wiring by others)
- E** - Conduit (by others)
- F** - Power wiring (by others)
- G** - Lumenalta Post-Top

Lumentalk (LT) - Wiring Detail

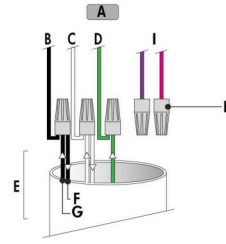

- A** - To fixture
- B** - Line
- C** - Neutral
- D** - Ground
- E** - Conduit (by others)
- F** - To next fixture
- G** - Power input or from previous fixture
- H** - Wire-nuts (by others)
- I** - Not required

- Consult factory for specific applications and maximum fixture count/cable length recommendations.
- Lumentalk enabled fixtures must be commissioned using LumentalkID software and a LID-LT. Consult factory for details.
- Maximum of 1 transmitter (Lumentranslator or Lumenlink) per system.
- No third party fixtures allowed on the same circuit.
- For DMX applications: 1 DMX controller per Lumentalk network, maximum of 48 DMX channels per Lumentalk network (minimum step transition update rate is 1 second, minimum fade time between two colors is 1 minute). Consult factory for applications that require additional capabilities.
- Consult factory for DALI Lumentalk applications.
- 1% minimum dimming value.

DALI Dimming (DALI)

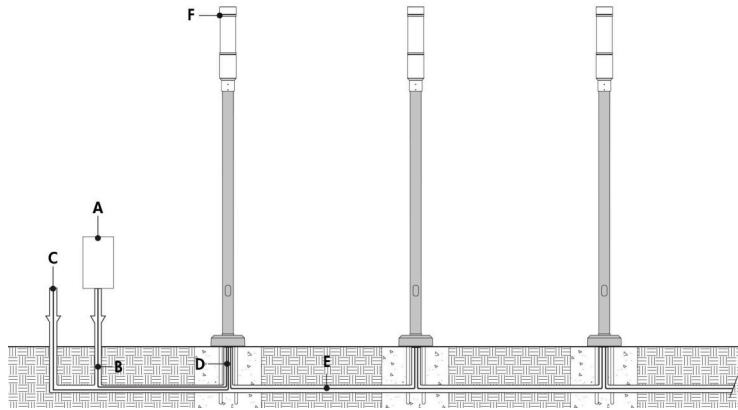

- A** - DALI controller (by others)
- B** - Data wiring (by others)
- C** - Power input (120-277V, wiring by others)
- D** - Conduit (by others)
- E** - Power and data wiring (by others)
- F** - Luminalta Post-Top

- Consult factory for specific applications and maximum fixture count/cable length recommendations.
- Maximum of 64 DALI fixtures per DALI loop.
- 1% minimum dimming value.

DALI Dimming (DALI) - Wiring Detail

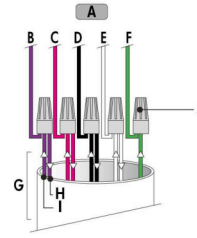

- A** - To fixture
- B** - Data +
- C** - Data -
- D** - Line
- E** - Neutral
- F** - Ground
- G** - Conduit (by others)
- H** - To next fixture
- I** - Power input or from previous fixture
- J** - Wire-nuts (by others)

Star Layout (DMX/RDM)

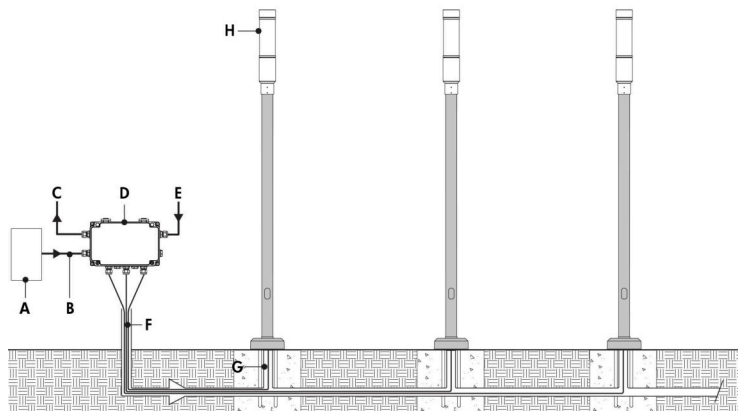

DMX/RDM - Wiring Detail (Star Layout)

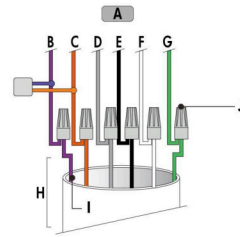

- A** - To fixture
- B** - Data +
- C** - Data -
- D** - DMX Signal common
- E** - Line
- F** - Neutral
- G** - Ground
- H** - Conduit (by others)
- I** - From CBX or from previous fixture
- J** - Wire-nuts (by others)

- A** - DMX/RDM controller (order separately from Lumenpulse, or by others)
- B** - Data input (Belden 9841 or equivalent, by others)
- C** - Data output to next CBX (optional, not isolated/not boosted)
- D** - CBX-ST
- E** - Power input (120-277V, wiring by others)
- F** - Power and data output to fixture (wiring by others)
- G** - Conduit (by others)
- H** - Lumenalta Post-Top

- Consult CBX installation instructions for additional wiring details.
- Consult factory for specific applications and maximum fixture count/cable length recommendations.
- The DMX/RDM protocol states a maximum of 32 DMX/RDM enabled fixtures on any single run.
- Maximum of 4 DMX/RDM repeaters/CBX cascading in line.
- Maximum of 6 outputs per CBX-ST.
- Each fixture requires 1 DMX address.
- DMX terminator is required at the end of each run to maintain data integrity. Six (6x) DMX lumenterminators included per CBX-ST. See installation instructions for details.
- 1% minimum dimming value.
- 100 watts per fixture.

How to Order

Housing	Mounting	Voltage	Decorative Top Options	Optical System	Head Height	Lens Finish	Output	Color and Color Temperature	Color Rendering ⁽³⁾	Distributions
ALTS Lumenalta Small	TN Tenon Mount	120 120 Volts 208 208 Volts 240 240 Volts 277 277 Volts	SPN00 No Decorative Top	DVO Direct View Optic	H12 14 9/16 in	O Opal Lens	21W 21 W/ft	22K 2200K 27K 2700K 30K 3000K 35K 3500K 40K 4000K MRGBWP Opticolor+® Mix-at-Source Red, Green, Blue Plus White Settable Range 24K to 65K ⁽¹⁾ MRGROYWP Opticolor+® Mix-at-Source Red, Green, Royal Blue Plus White Settable Range 24K to 65K ^{(1) (2)}	CRI 90 CRI 90+ (White Light Only)	5 Type V

Notes:

1. Available with DMX/RDM, LT and DALI Control Options only.
2. Consult factory for details.
3. Available for 22K, 27K, 30K, 35K and 40K color temperatures only.

How to Order

Finish	Control	Option	Mounting Options
BK Black Sandtex® BRZ Bronze Sandtex® SI Silver Sandtex® BKTX Textured Black BRZTX Textured Bronze Non-Metallic GRATX Textured Medium Gray GRNTX Textured Green WHTX Textured White CC Custom Color & Finish ⁽⁴⁾ ⁽⁵⁾ ⁽⁶⁾	DIM 0-10V Dimming ⁽⁷⁾ LT Lumentalk Enabled Dimming ⁽⁸⁾ DMX/RDM DMX/RDM Enabled Dimming ⁽⁹⁾ DALI DALI Dimming ⁽¹⁰⁾ ⁽¹¹⁾	VRN Normal Vibration Rating ⁽¹²⁾ VRBO Vibration Rated for Bridge and Overpass ⁽¹²⁾ CRC Corrosion-Resistant Coating ⁽¹³⁾ ⁽¹⁴⁾ SP Surge Protector	TN4 4 in O.D. Tenon Adapter

Notes:

- 4. Specify RAL number followed by "TX" for textured finish (ex: RAL9007TX) or STX for Sandtex finish (ex: RAL9007STX). Textured or Sandtex finishes are recommended for the durability of all products. If a finish is not specified with the RAL number (ex: RAL9007), a glossy finish will be provided. Please consult factory for other RAL textures and glosses, or to match alternate color charts. Final color matching results may vary.
- 5. Setup charges apply for RAL colors. Consult factory for details.
- 6. Longer lead times can be expected for custom RAL color finishes.
- 7. Not available for MRGBWP and MRGROYWP Color Temperatures. Segment control (resolution by foot) not available.
- 8. A Lumentranslator 2 (LT2) and LumenID (LID) must be specified for Lumentalk applications. Consult Lumentranslator 2 and Lumentalk pages and specification sheets for details.
- 9. A Control Box (CBX) and LumenID (LID) must be specified.
- 10. DALI 2 T6 controller required for static white (22K, 27K, 30K, 35K, 40K), provided by others. Segment control (resolution by foot) not available.
- 11. DALI 2 T8 controller required for MRGBWP and MRGROYWP, provided by others. Segment control (resolution by foot) not available.
- 12. VRN or VRBO must be specified for all installations.
- 13. Use only when exposed to salt spray. This option is not required for normal outdoor exposure.
- 14. Setup charges apply. Consult factory for details.