

Project Name _____ Qty _____

Type _____ Catalog / Part Number _____

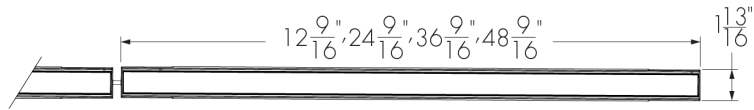

Top view

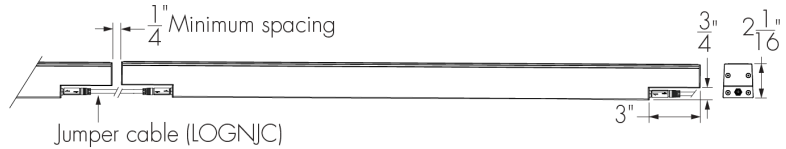

Front and side views

Photometric Summary (8 W/ft)

	Delivered output (lm)	Intensity (peak cd)
8°x8°	2,052	55,453
10°x10°	1,985	43,263
10°x30°	1,924	12,238
10°x60°	1,914	6,527
10°x90°	1,918	3,421
30°x10°	1,930	12,200
30°x30°	1,961	4,528
30°x60°	1,901	2,865
60°x10°	1,912	7,573
60°x60°	1,920	1,420
60°x90°	1,908	1,709
90°x90°	1,876	1,160
W (120°)	1,157	569
WW	2,044	9,914

¹ Based on DWH full output, 4 ft, UCTL control configuration.

² Photometric performance is measured in compliance with IESNA LM-79-24.

Description

The Lumenfacade Nano Interior Dynamic White is a high-efficiency linear LED luminaire with a slim profile that makes it easy to conceal and integrate into architectural facades. Available in 12 in, 24 in, 36 in or 48 in sections, the Lumenfacade Nano Interior Dynamic White can be configured with a wide number of options, including: optics for grazing, floodlighting, or wall washing; colour temperatures from 2200K to 3000K or from 2700K to 6500K; various mounting options, finishes, and controls.

Features

Color and Color Temperature	Dynamic Warm White (2200K to 3000K), Dynamic White (2700K to 6500K)
Optics	8° x 8°, 10° x 10°, 10° x 30°, 10° x 60°, 10° x 90°, 30° x 10°, 30° x 30°, 30° x 60°, 60° x 10°, 60° x 60°, 60° x 90°, 90° x 90°, Wide 120°, Asymmetric Wallwash
Option	3G ANSI C136.31-2010 Vibration Rating for Bridge Applications
Power Consumption	4 W/ft, 8 W/ft
Warranty	5-year limited warranty

Performance

Maximum Delivered Output	1,128 lm (4 W/ft, 48 in fixture, DWH full output, 8° x 8°, UCTL control) 2,052 lm (8 W/ft, 48 in fixture, DWH full output, 8° x 8°, UCTL control) 924 lm (4 W/ft, 48 in fixture, DWH full output, 8° x 8°, UCTL control) 1,606 lm (8 W/ft, 48 in fixture, DWH full output, 8° x 8°, UCTL control)
---------------------------------	--

Optics

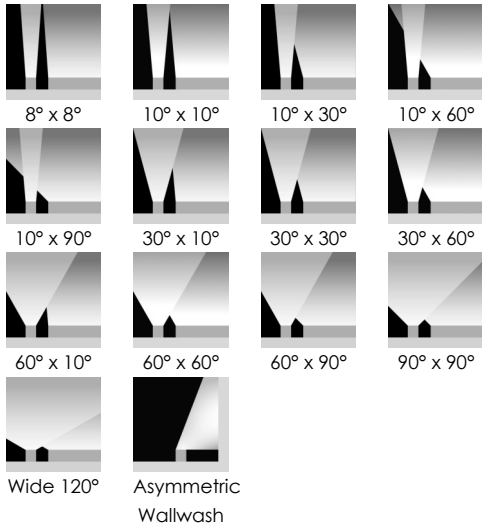

Colors and Color Temperatures



Controls

UCTL/DTW UCTL

Ratings

IP20 IK08

Lumencycle™ Program



Certifications



Maximum Delivered Intensity	30,476cd at nadir (4 W/ft, 48 in fixture, DWH full output, 8° x 8°, UCTL control) 55,453 cd at nadir (8 W/ft, 48 in fixture, DWH full output, 8° x 8°, UCTL control) 24,977 cd at nadir (4 W/ft, 48 in fixture, DWW full output, 8° x 8°, UCTL control) 45,404 cd at nadir (8 W/ft, 48 in fixture, DWW full output, 8° x 8°, UCTL control)
------------------------------------	---

Illuminance at Distance	Minimum 1 fc at 174 ft (4 W/ft, 48 in fixture, DWH full output, 8° x 8°, UCTL control) Minimum 1 fc at 236 ft (8 W/ft, 48 in fixture, DWH full output, 8° x 8°, UCTL control) Minimum 1 fc at 158 ft (4 W/ft, 48 in fixture, DWW full output, 8° x 8°, UCTL control) Minimum 1 fc at 213 ft (8 W/ft, 48 in fixture, DWW full output, 8° x 8°, UCTL control)
--------------------------------	--

Lumen Maintenance	L70 >90,000 hrs
--------------------------	-----------------

Physical

Housing Material	Low copper content extruded aluminum
Lens Material	Clear tempered glass
Hardware Material	Stainless steel
End Cap Material	Machined aluminum
Surface Finish	Electrostatically applied polyester powder coat
Weight	1.4 lbs (12 in) 2.9 lbs (24 in) 4.4 lbs (36 in) 6 lbs (48 in)

Electrical and Control

Voltage	48 VDC
Resolution (DMX/RDM)	Per foot or fixture for UCTL/DTW control option (configured with LumenID V3 software), Per fixture for UCTL control option, 8-bit or 16-bit
Dynamic Warm Color Temperature Mixing	12 LEDs per 12 in (4x 2200K, 4x 2700K, 4x 3000K)
Dynamic White Color Temperature Mixing	12 LEDs per 12 in (4x 2700K, 4x 4000K, 4x 6500K)
Control	Universal control DTW pre-set (Dim to warm via single-channel DMX/RDM, 2700K to 2200K, compatible with 0-10V or DMX/RDM systems), Universal Control (3-Channel Color Temperature Control via DMX/RDM or DALI-2 Type 8 Systems)

Environmental

Environment	Indoor applications only
Storage Temperature	-40 °F to 185 °F (device must reach start-up temperature value before operating)
Start-up Temperature	-13 °F to 122 °F

Operating Temperature	-40 °F to 122 °F
Ingress Protection Rating	IP20
Impact Resistance Rating	IK08 (IK09 for 48 in fixtures)

Accessories (Order Separately)

Cables	Lumenfacade Nano Jumper Cable (LOGNJC), Trunk Power Cable (TKPWR), Trunk Data Cable (TKDMX), Lumenfacade Nano Jumper Cable Joiner (LOGNJC-JOINER)
Control Boxes	Low-Voltage Control Box (LCBX), Low-Voltage Splitter Box (LSBX)
Remote Power Supply	Large Power Supply (LGPSU)
Optical Accessories	Lumenfacade Nano Radial Louver (LOGNRD), Lumenfacade Nano Visor (LOGNVS)
Control Systems	Pharos® Designer Lighting Control Kit (PHAROS), Pharos® Expert Control Kit (EXPERT)
Diagnostic and Addressing Tools	LumenID (LID)

Important

Virtual Patent Marking Notice

This website (<https://www.lmpg.com/patents-trademarks>) is provided to satisfy the virtual patent marking provisions of applicable jurisdictions. Some products listed may be covered by additional patents not referenced here.

Lumencycle™ Program

Lumencycle is a comprehensive program designed to maximize the life of Lumenpulse fixtures while preserving their performance, quality, and design intent. Built around three pillars—Repair, Restore, and Recycle—the program provides clear pathways to maintain existing installations, restore fixtures, and responsibly manage them at end of life. For full program details, visit <https://www.lumenpulse.com/lumencycle>.

Photometric Information

4 W/ft (DWH)

	Delivered output (lm)	Intensity (peak cd)
8°x8°	1,128	30,476
10°x10°	1,091	23,777
10°x30°	1,058	6,726
10°x60°	1,052	3,587
10°x90°	1,054	1,880
30°x10°	1,061	6,705
30°x30°	1,100	2,539
30°x60°	1,066	1,607
60°x10°	1,051	4,162
60°x60°	1,077	796
60°x90°	1,070	959
90°x90°	1,052	651
W (120°)	636	312
WW	1,123	5,449

Based on DWH full output, 4 ft, UCTL control configuration.

Photometric performance is measured in compliance with IESNA LM-79-24.

Chromaticity Data

TM-30 - DWW

CCT	CIE		TM-30	
DWW Full Output	R _a	86	87	R _f
	R _g	26	97	R _g

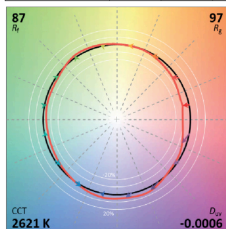

TM-30 - DWH

CCT	CIE		TM-30	
DWH Full Output	R _a	81	80	R _f
	R _g	22	99	R _g

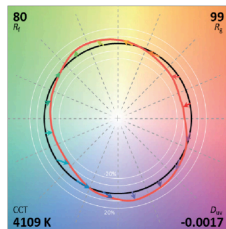

DWW Spectral Power Distribution

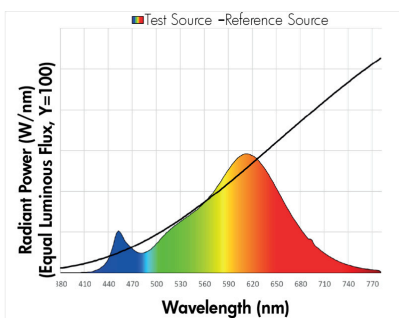

DWH Spectral Power Distribution

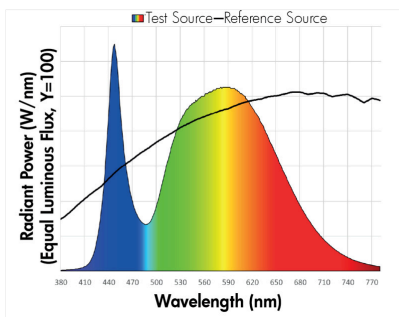

Optical Option Installation Details

HFR - Half-Frosted Lens



Top view



Front view

- Always position frosted side toward the wall.
- Applicable for 8° x 8°, 10° x 10° or asymmetric wallwash optics only.

WW - Asymmetric Wallwash

Recommended setback from wall is 1/10 of the wall height.

Example: 2 ft setback for a 20 ft wall.

Mounting Options

One mounting bracket provided for 12 in fixtures. Two mounting brackets provided for 24 in, 36 in and 48 in fixtures. See installation instructions for details.

SAMN - Slim Adjustable Mounting Nano

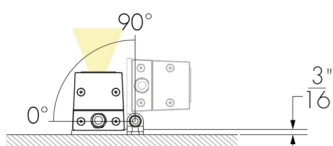

Not suitable when fixture is exposed to wind.

One mounting bracket provided for 12 in fixtures. Two mounting brackets provided for 24 in, 36 in and 48 in fixtures. See installation instructions for details.

UMPN - Fixed Mounting Nano



SAMN - Mounting Hole Pattern

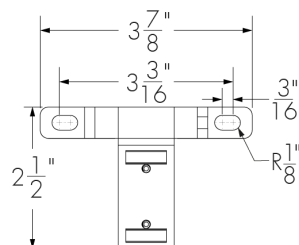

UMPN - Mounting Hole Pattern

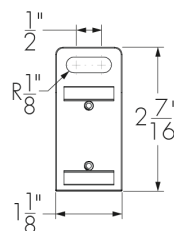

UMASN - Universal Adjustable Mounting Nano

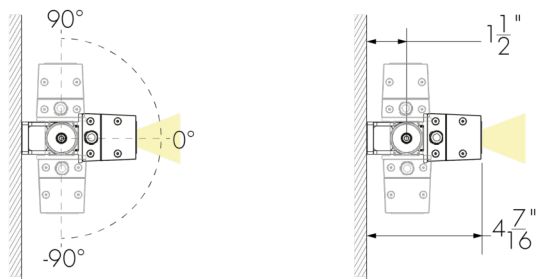

UMASN - Mounting Hole Pattern

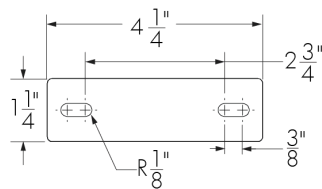

For 1 ft fixtures

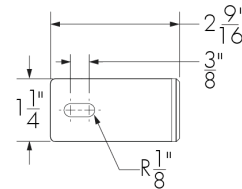

For 2 ft, 3 ft and 4 ft fixtures

WAMN2 - Adjustable Extended Arm Mounting Nano 2 in

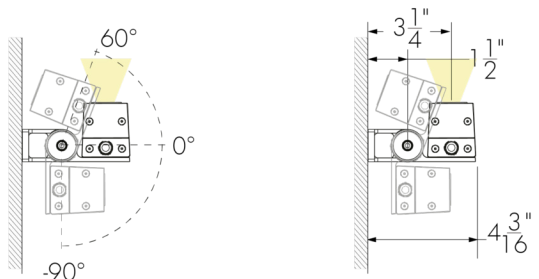

WAMN2 - Mounting Hole Pattern

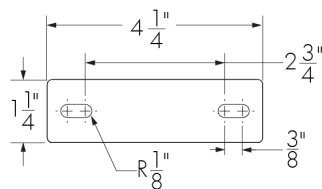

For 1 ft fixtures

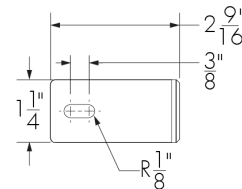

For 2 ft, 3 ft and 4 ft fixtures

WAMN6 - Adjustable Extended Arm Mounting Nano 6 in

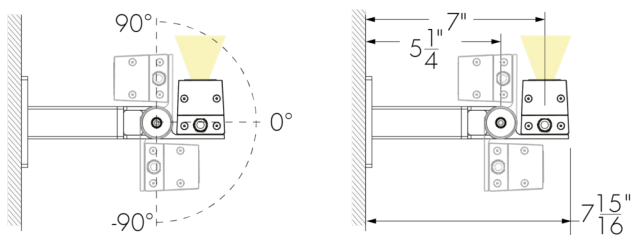

WAMN6 - Mounting Hole Pattern

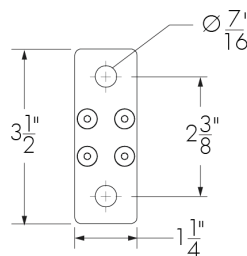

WAMN12 - Adjustable Extended Arm Mounting Nano 12 in

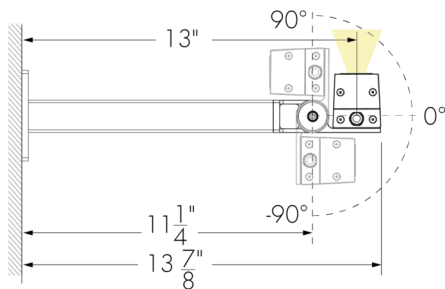

WAMN12 - Mounting Hole Pattern

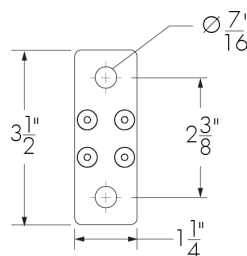

WAMN18 - Adjustable Extended Arm Mounting Nano 18 in

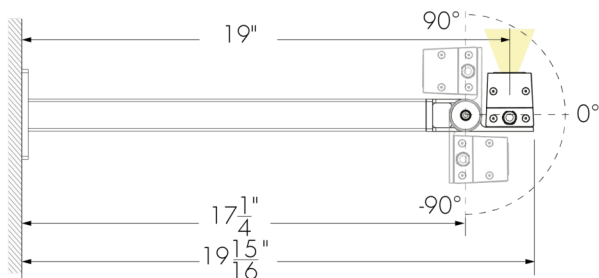

WAMN18 - Mounting Hole Pattern

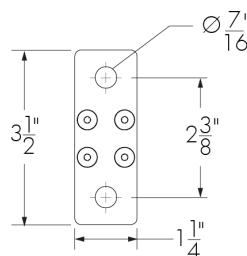

WAMN28 - Adjustable Extended Arm Mounting Nano 28 in

WAMN28 - Mounting Hole Pattern

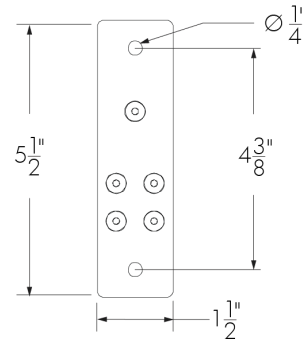
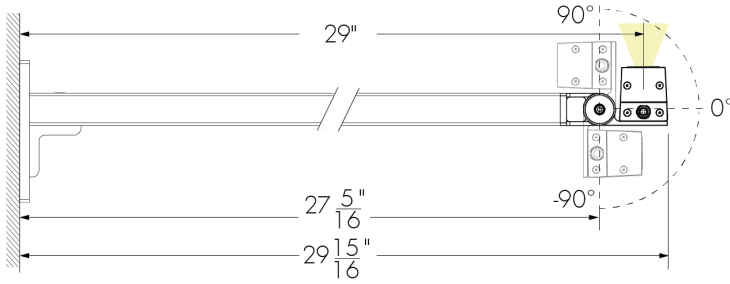

Mounting Bracket Placement (Minimum and Maximum Distances)

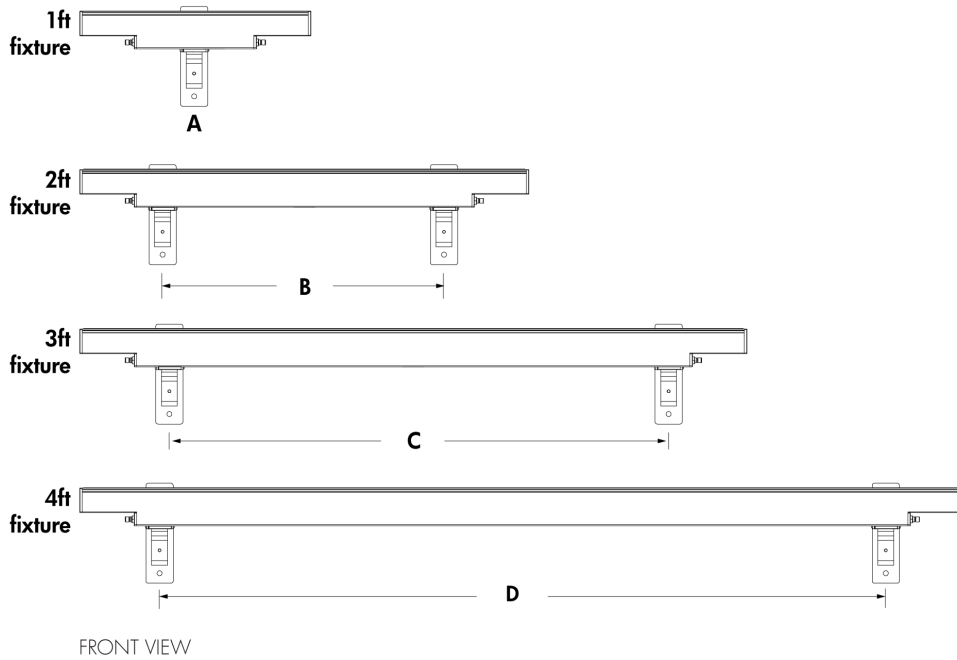

- A - Bracket in the center of the fixture
 - B - Minimum 14 in to maximum 16 in
 - C - Minimum 26 in to maximum 28 in
 - D - Minimum 38 1/2 in to maximum 40 1/2 in
- LOGNI with bracket WAMN28 shown

The mounting bracket(s) to be centered on fixture and as symmetrical as possible. Distances must be respected for all installations.

Cable Management System for Wall Mounting Brackets

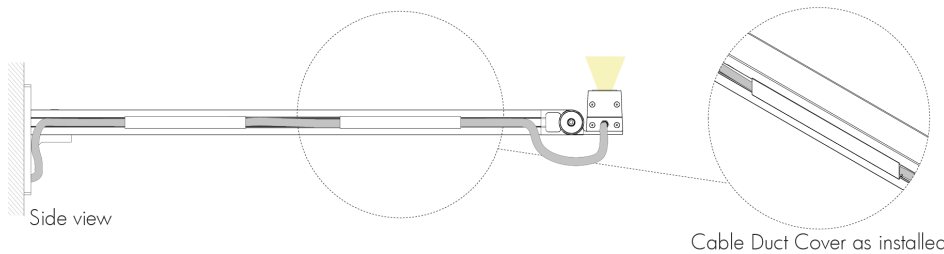

- No Cable Duct Cover provided for WAMN2 and WAMN6 mounting arms.
- 1 Cable Duct Cover provided for WAMN12 mounting arm.
- 2 Cable Duct Covers provided for WAMN18 and WAMN28 mounting arms.

Optical Accessories (Order Separately)

LOGNRD - Radial Louver For Lumenfacade Nano

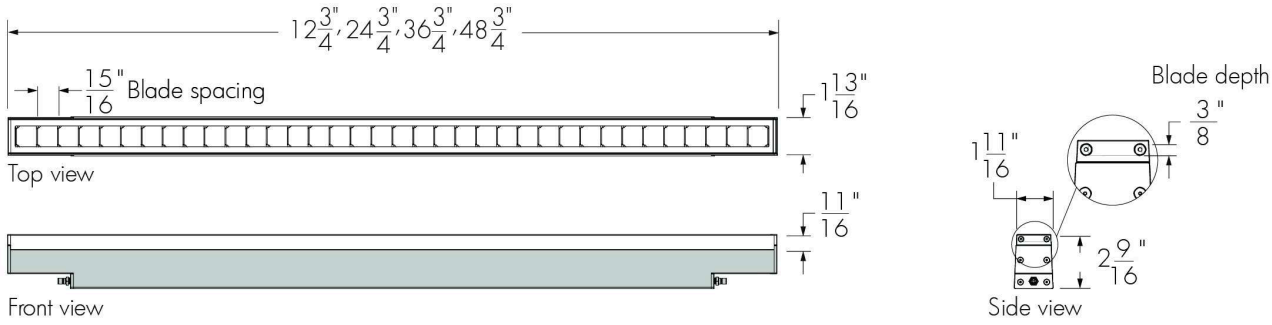

LOGNRD-LENGTH-FINISH-OPTIONS

Please specify:

LENGTH: 12 in, 24 in, 36 in or 48 in; **FINISH:** BK - Black Sandtex®, BRZ - Bronze Sandtex®, SI - Silver Sandtex®, WH - Smooth white or CC - custom color and finish (please specify RAL color); **OPTIONS:** CRC - Corrosion-resistant coating for hostile environments

- The addition of a louver will affect beam distribution. Consult factory for application support.
- Not suitable for wide 120° and asymmetric wallwash optics.
- CRC option is not available for indoor applications.
- Maximum one accessory per fixture. Louvers are field installable.

LOGNVS - Visor For Lumenfacade Nano

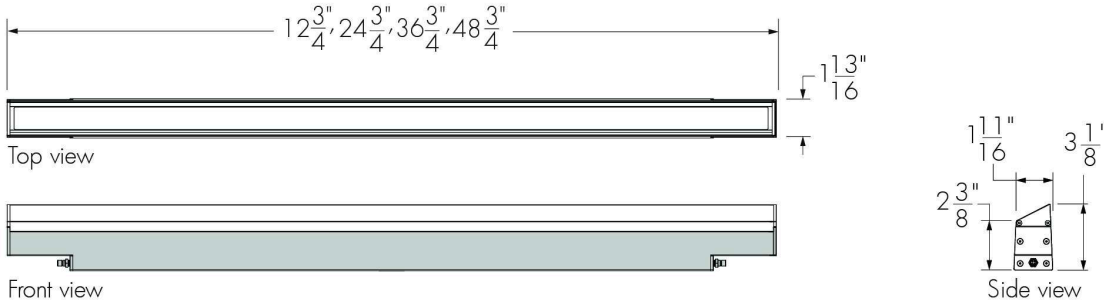

LOGNVS-LENGTH-FINISH-OPTIONS

Please specify:

LENGTH: 12 in, 24 in, 36 in or 48 in; **FINISH:** BK - Black Sandtex®, BRZ - Bronze Sandtex®, SI - Silver Sandtex®, WH - Smooth white or CC - custom color and finish (please specify RAL color); **OPTIONS:** CRC - Corrosion-resistant coating for hostile environments

- The addition of a visor will affect beam distribution. Consult factory for application support.
- Not suitable for wide 120° optic.
- CRC option is not available for indoor applications.
- Maximum one accessory per fixture. Visors are field installable.

Cables (Order Separately)

LOGNJC - Jumper Cable For Lumenfacade Nano

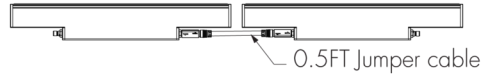

For minimal spacing between fixtures, use a 0.5 ft jumper cable.

LOGNJC-CERTIFICATION-LENGTH-CABLE COLOR

Please specify:

CERTIFICATION: UL or CE; **LENGTH:** 0.5 ft, 1 ft to 30 ft (available in 1 ft increments) or 50 ft; **CABLE COLOR:** black or white (connectors are the same color as the specified cable color).

- Suitable for dimming/data and non-dimming applications.
- Consult Lumenfacade Nano Jumper Cable specification sheet for all available cable lengths and additional information.

Joiner (Order Separately)

LOGNJC-JOINER - Joiner For Lumenfacade Nano Jumper Cable

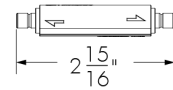

- Use joiners to connect and lengthen jumper cables.
- Joiners add voltage drops. Consult factory to confirm impact on run length.
- Available in black.

Resolution Details

DMX/RDM Control, Resolution Per Foot: Each 12 in Section is Addressed Independently

DMX Addresses:

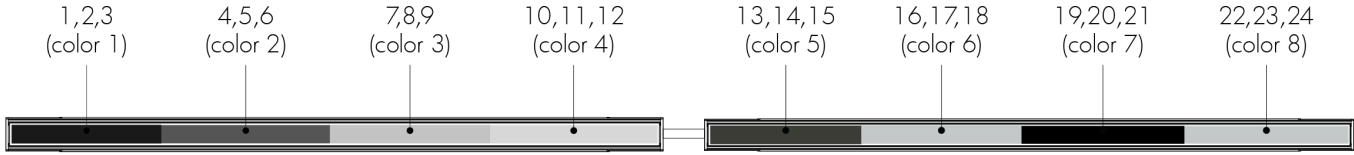

UCTL control option

DMX/RDM Control, Resolution Per Fixture: Each Fixture is Addressed Independently

DMX Addresses:



UCTL control option

Dim To Warm Control, Resolution Per Fixture: Each Fixture is Addressed Independently

DMX Addresses:



UCTL/DTW control option

- 48 in fixtures shown.
- Fixture resolution can be configured on-site within the LumenID V3 software. A DIM/DMX/RDM enabled LCBX or DMX/RDM LSBX is required for DMX/RDM or Dim to warm control.

Typical Wiring Diagrams

Dim to Warm Via UCTL/DTW* or UCTL 3-Channel Via DMX/RDM

*Available For DWW Version Only, 2700K to 2200K

Single Unit - LCBX 60W

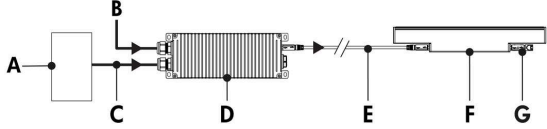

- A - Dimmer (UCTL/DTW only)/controller (order separately from Lumenpulse, or by others)
- B - Power input (120-277V, wiring by others)
- C - Data input (wiring by others)
- D - LCBX (60W)
- E - Jumper cable (LOGNJC)
- F - Lumenfacade Nano Interior
- G - Terminator cap

Continuous Run - LCBX 60W or 120W

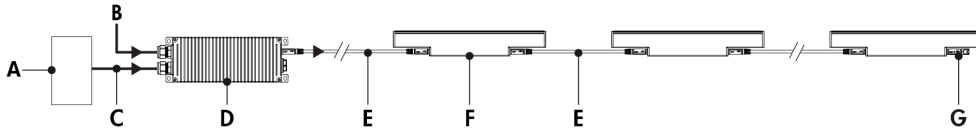

- A - Dimmer (UCTL/DTW only)/controller (order separately from Lumenpulse, or by others)
- B - Power input (120-277V, wiring by others)
- C - Data input (wiring by others)
- D - LCBX (60W or 120W)
- E - Jumper cable (LOGNJC)
- F - Lumenfacade Nano Interior
- G - Terminator cap

Continuous Run - LCBX 200W

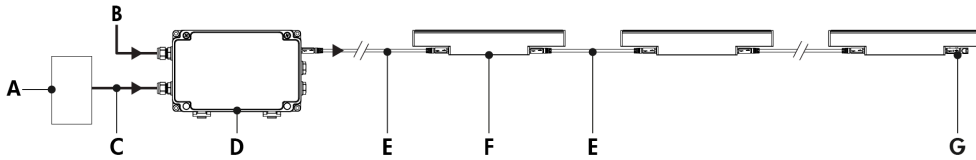

- A - Dimmer (UCTL/DTW only)/controller (order separately from Lumenpulse, or by others)
- B - Power input (120-277V, wiring by others)
- C - Data input (wiring by others)
- D - LCBX (200W)
- E - Jumper cable (LOGNJC)
- F - Lumenfacade Nano Interior
- G - Terminator cap

Continuous Run - Daisy Chain
LCBX 60W or 120W

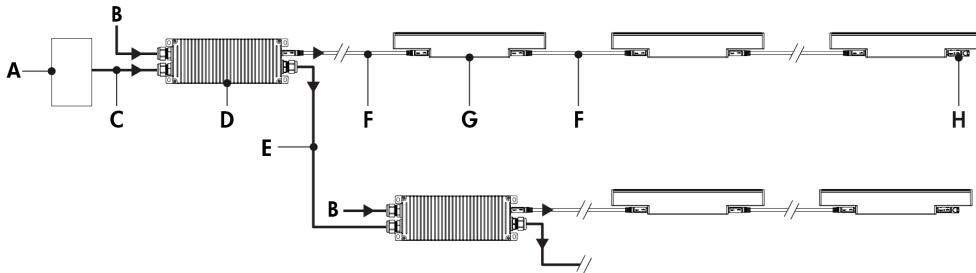

- A - Dimmer (UCTL/DTW only)/controller (order separately from Lumenpulse, or by others)
- B - Power input (120-277V, wiring by others)
- C - Data input (wiring by others)
- D - LCBX (60W or 120W)
- E - Data output to next LCBX (wiring by others)
- F - Jumper cable (LOGNJC)
- G - Lumenfacade Nano Interior
- H - Terminator cap

Continuous Run - Daisy Chain
LCBX 200W

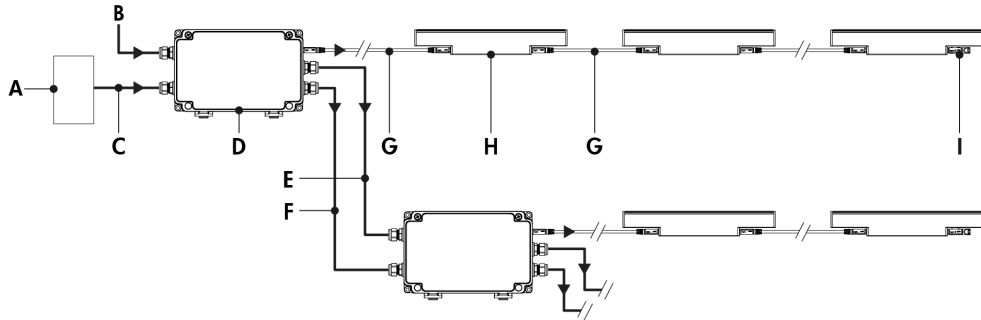

- A** - Dimmer (UCTL/DTW only)/controller (order separately from Lumenpulse, or by others)
- B** - Power input (120-277V, wiring by others)
- C** - Data input (wiring by others)
- D** - LCBX (200W)
- E** - Power output to next LCBX (120-277V, wiring by others)
- F** - Data output to next LCBX (wiring by others)
- G** - Jumper cable (LOGNJC)
- H** - Lumenfacade Nano Interior
- I** - Terminator cap

Maximum Run of Fixtures - Lumenfacade Nano® LOGNI Dynamic White

10ft Jumper Cable		
Wattage	4W/ft	8W/ft
Maximum Run of Fixtures per LCBX 60W	13ft	6ft
Maximum Run of Fixtures per LCBX 120W	25ft	13ft
Maximum Run of Fixtures per LCBX 200W	45ft*	22ft
25ft Jumper Cable		
Wattage	4W/ft	8W/ft
Maximum Run of Fixtures per LCBX 60W	13ft	6ft
Maximum Run of Fixtures per LCBX 120W	25ft	13ft
Maximum Run of Fixtures per LCBX 200W	45ft*	22ft
50ft Jumper Cable		
Wattage	4W/ft	8W/ft
Maximum Run of Fixtures per LCBX 60W	13ft	6ft
Maximum Run of Fixtures per LCBX 120W	25ft	13ft
Maximum Run of Fixtures per LCBX 200W	45ft*	22ft

*Example: 4W/ft = 45ft maximum run of end to end fixtures per LCBX 200W.
(11 fixtures maximum for 4ft LOGNI 4W/ft, 45 fixtures maximum for 1ft LOGNI 4W/ft).
Consult factory for system validation prior to quoting and ordering.

- Consult factory for specific applications and maximum fixture count/run length recommendations.
- Maximum of 1 output to fixture, or fixture run, per LCBX.
- Consult the LCBX specification sheet for more information.
- Fixtures with UCTL/DTW control can be controlled via a 0-10V dimmer or DMX/RDM controller.
- 0-10V mA ratings: Current Sink Mode: 25µA per LCBX; Current Source Mode: 2.5mA per LCBX.
- Dim to warm control requires 1 DMX channel. DMX/RDM control requires 3 DMX channels.
- Fixtures with UCTL control can be controlled via a DMX/RDM or DALI controller.
- For DALI-2 Type 8 applications:
 - The LCBX responds to Color Temperature control.
- 4W version: 4 W/ft, 8W version: 8 W/ft.

Trunk System - LSBX

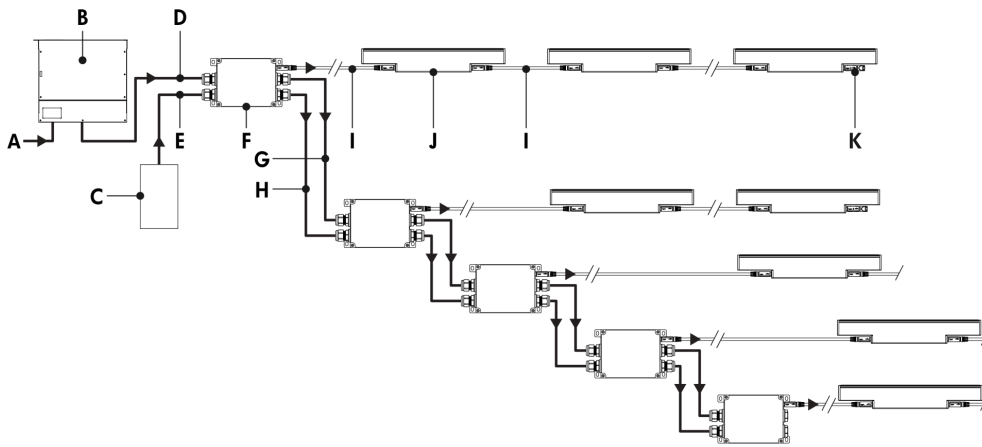

- A** - Power input (120-277V, wiring by others)
- B** - Large Power supply (LGPSU) (order separately from Lumenpulse)
- C** - Controller (order separately from Lumenpulse, or by others)
- D** - Power input (48V, order separately from Lumenpulse - Trunk Power Cable (TKPWR), or equivalent by others. Refer to LSBX specification sheet for details)
- E** - Data input (order separately from Lumenpulse - Trunk Data Cable (TKDMX), or equivalent by others. Refer to LSBX specification sheet for details)
- F** - LSBX
- G** - Power output to next LSBX (48V, order separately from Lumenpulse - Trunk Power Cable (TKPWR), or equivalent by others. Refer to LSBX specification sheet for details)
- H** - Data output to next LSBX (order separately from Lumenpulse - Trunk Data Cable (TKDMX), or equivalent by others. Refer to LSBX specification sheet for details)
- I** - Jumper cable (LOGNJC)
- J** - Lumenfacade Nano Interior
- K** - Terminator cap

- Consult factory for specific applications and maximum fixture count/run length recommendations.
- Maximum of 1 output to fixture run per LSBX.
- The LSBX has a maximum of 200W for output to fixtures. Consult the LSBX specification sheet for more information.
- The Large Power Supply (LGPSU) has a maximum of 1000W (120V) or 1200W (277V). Consult LGPSU specification sheet for more information.
- Dim to warm control requires 1 DMX channel. DMX/RDM control requires 3 DMX channels.
- 4W version: 4 W/ft, 8W version: 8 W/ft.

Control Boxes (Order Separately)

LCBX - Low-Voltage Control Box

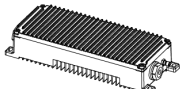

LCBX 60W & 120W

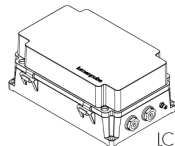

LCBX 200W

Low-voltage control and power box. One power and data output to fixture, or fixture run. Refer to LCBX specification sheet for details.

LSBX - Low-Voltage Splitter Box

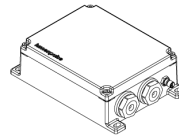

Low-voltage control and power splitter box. One power and data output to fixture run. Refer to LSBX specification sheet for details.

Remote Power Supply (Order Separately)

LGPSU - Large Power Supply

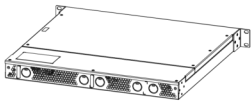

Monté sur rack

Indoor rack-mounted 1.2KW power supply allows for scalable DMX/RDM controlled Lumenfacade Nano systems. Wall Mount version coming soon, consult factory for details.

Control Systems (Order Separately)

PHAROS - Pharos® Designer Lighting Control Kit

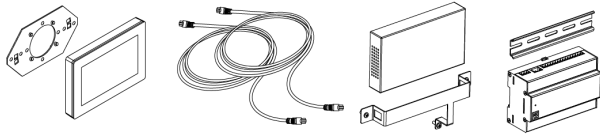

The Pharos Designer Lighting Control Kit, available for 1 or 2 DMX universes, allows for complete control of large lighting installations.

EXPERT - Pharos® Expert Control Kit



The Pharos Expert Control Kit, available for 1, 2, 4 or 6 DMX universes, allows for complete control of large lighting installations.

Diagnostic And Addressing Tools (Order Separately)

LID - LumenID

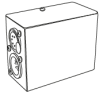

The updated LumenID (LID) is an all-in-one diagnostic and addressing solution for both DMX/RDM and Lumentalk (LT) systems. Engineered for versatility, it streamlines commissioning and troubleshooting across protocols—no need for multiple tools. Cable option may vary; please consult factory. For complete details, refer to the LID specification sheet.

How to Order

--	--	--	--	--	--

Housing	Wattage	Voltage	Length	Color and Color Temperature ⁽¹⁾	Optic
LOGNI Lumenfacade™ Nano Interior	4W 4 W/ft 8W 8 W/ft	48V 48 VDC	12 12 3/4 in (1.4 lbs) 24 24 3/4 in (2.9 lbs) 36 36 3/4 in (4.4 lbs) 48 48 3/4 in (6 lbs)	DWW Dynamic Warm White (2200K to 3000K) DWH Dynamic White (2700K to 6500K)	8x8 8° x 8° 10x10 10° x 10° 10x30 10° x 30° 10x60 10° x 60° 10x90 10° x 90° 30x10 30° x 10° 30x30 30° x 30° 30x60 30° x 60° 60x10 60° x 10° 60x60 60° x 60° 60x90 60° x 90° 90x90 90° x 90° W Wide 120° ⁽²⁾ WW Asymmetric Wallwash ⁽³⁾

Notes:

1. For Dim to Warm control via UCTL/DTW, Dynamic Warm White (DWW) must be specified.
2. Not compatible with louver or visor optical accessories.
3. Not compatible with louver optical accessory.

How to Order

Lens	Mounting Options ^{(8) (9)}	Finish	Control ⁽¹³⁾	Option	Certification	Buy American Act
CL Clear Lens ^{(4) (5)} FR Frosted Lens ⁽⁶⁾ HFR Half-Frosted Lens ⁽⁷⁾	SAMN Slim Adjustable Mounting Nano UMPN Fixed Mounting Nano UMASN Universal Adjustable Mounting Nano WAMN2 Adjustable Wall Mounting Nano 2 in WAMN6 Adjustable Extended Arm Mounting Nano 6 in WAMN12 Adjustable Extended Arm Mounting Nano 12 in WAMN18 Adjustable Extended Arm Mounting Nano 18 in WAMN28 Adjustable Extended Arm Mounting Nano 28 in	BK Black Sandtex® BRZ Bronze Sandtex® SI Silver Sandtex® WH Smooth White CC Custom Color & Finish ⁽¹⁰⁾ _{(11) (12)}	UCTL/DTW Universal control DTW pre-set (Dim to warm via single-channel DMX/RDM, 2700K to 2200K, compatible with 0-10V or DMX/RDM systems) ⁽¹⁴⁾ UCTL Universal Control (3-Channel Color Temperature Control via DMX/RDM or DALI-2 Type 8 Systems)	3GV 3G ANSI C136.31-2010 Vibration Rating for Bridge Applications ⁽¹⁵⁾	UL UL Compliant CE CE Compliant	BAA Buy American ^{(16) (17)}

Notes:

- 4. Not available for 10x10, W or WW optics.
- 5. To use only if fixture is lighting the surface perpendicularly, if the fixture is installed close to the wall, select the Half-Frosted lens to soften the beam on the wall.
- 6. Not available for WW optic.
- 7. Available for 8x8, 10x10 or WW optics only.
- 8. One mounting bracket provided for 12 in fixtures. Two mounting brackets provided for 24 in, 36 in and 48 in fixtures.
- 9. Refer to Mounting Bracket Placement section in the specification sheet for mounting bracket distances that must be respected.
- 10. Lumenpulse offers a wide selection of RAL CLASSIC (K7) colors with a smooth texture and high-gloss finish. Please consult factory for a list of available K7 colors, other RAL textures and glosses, or to match alternate color charts. Final color matching results may vary.
- 11. Setup charges apply for RAL colors. Consult factory for details.
- 12. Longer lead times can be expected for custom RAL color finishes.
- 13. A Low-Voltage Control Box (LCBX) or Low-Voltage Splitter Box (LSBX) and LumenID (LID) must be specified.
- 14. UCTL/DTW fixture is factory set to follow the dim to warm curve via single-channel DMX/RDM. Fixture resolution can be configured on-site within the LumenID V3 software.
- 15. Not available for SAMN mounting option. Mounting bracket distances that must be respected, consult Mounting Bracket Placement section in the specification sheet for details.
- 16. Not available with CE certification option.
- 17. Contact your Lumenpulse Sales Representative for more information on order volume details.