

Project Name \_\_\_\_\_ Qty \_\_\_\_\_

Type \_\_\_\_\_ Catalog / Part Number \_\_\_\_\_

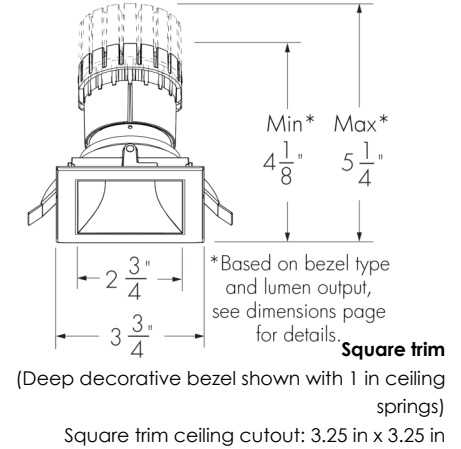
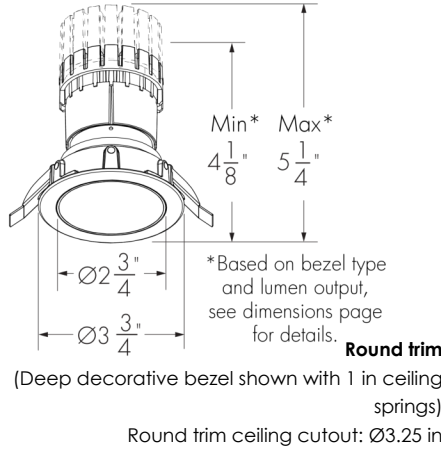

**Photometric Summary**

Based on Wide Faceted Reflector (nominal 60°), 4000K, CRI 90+

Nominal output [lm]	Delivered output [lm] <sup>(1)</sup>	Non-insulated ceiling		Insulated ceiling	
		Power (120V) [W]	Efficacy [lm/W]	Power (120V) [W]	Efficacy [lm/W]
700	666	8.5	78	6.5	102
1000	860	10	86	8	108
1300	1,193	13	92	11	108
2000	1,859	20	93	18	103
3000	2,774	30	92	N/A	N/A

<sup>1</sup> Consult website for latest IES files.  
<sup>2</sup> Photometric performance is measured in compliance with IESNA LM-79-24.

**Optics**

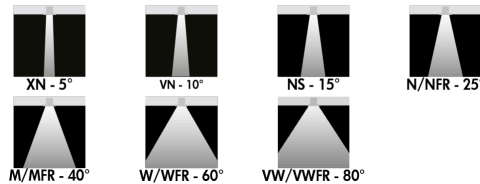

**Color and Color Temperature**

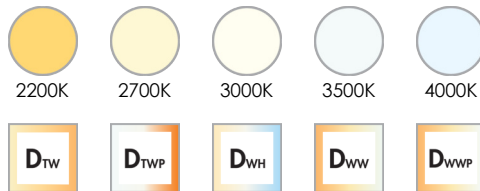

**Color Rendering**

CRI 80+      CRI 90+      CRI 95+

**Description**

The Lumencore Recessed Nano Downlight is a high-performance LED downlight for ceiling applications. Available in an array of trims and finishes, outputs, optics, color renderings, accessories, and a WET IP54 option, these luminaires are here to outperform. The Lumencore Recessed Nano Downlight possesses a previously unseen lifespan, is quick to install, and can be used with a number of different control options.

**Physical**

<b>Cutout</b>	<b>R:</b> Round, <b>S:</b> Square
<b>Decorative Bezel</b>	<b>SB:</b> Standard, <b>MB:</b> Mid/Semi Recess, <b>DB:</b> Deep Recess, <b>DR:</b> Deep Rollover
<b>Trim</b>	<b>RD:</b> Round, <b>SR:</b> Square Trim with Round Hole, <b>TLR:</b> Trimless Round, <b>SQ:</b> Square, <b>TLS:</b> Trimless Square
<b>Ceiling Thickness</b>	<b>1:</b> 0.04 in to 1 in Ceiling Thickness <b>2:</b> 1.05 in to 2 in Ceiling Thickness
<b>Housing Material</b>	Aluminum
<b>TIR Optics Material</b>	Clear polycarbonate
<b>Reflector Material</b>	Aluminum
<b>Weight</b>	3 lbs with RM installation type, 4.2 lbs with NC installation type, 7.2 lbs with PC, IC, IC/AT and RMR installation types (Weights are approximate based on the heaviest fixture configuration)  Please consult factory if exact fixture weight is needed

**Controls**

ON/OFF 0-10V PRO 0-10V PH  
 PPH PHB LUTRON DALI PRO DALI  
 DALI8 DMXrdm lumen talk

**Ceiling Cutout Shapes**

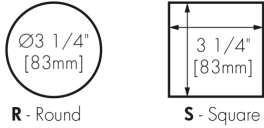

**Decorative Bezels (Round Trim)**



**Decorative Bezels (Square Trim)**



**Standard Finishes - Decorative Bezels**



**Trim Shapes**

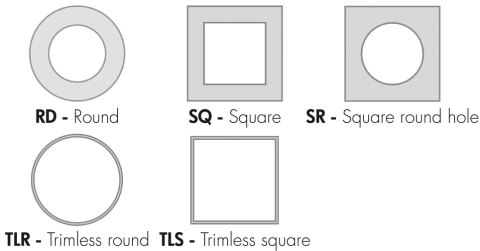

**Ceiling Space Requirements (Length x Width x Height)**

Up to 15 in x 8 in x 12 in with RM installation type, Up to 15 in x 9 in x 12 in with NC installation type  
 Up to 18 in x 15 in x 9 in with PC/IC/ICAT/RMR installation types  
 (Dimensions will vary by output and color rendering, refer to Ceiling Requirements table for details.)

**Features**

**Output (Nominal Lumens)** L07: 700 lm, L10: 1000 lm, L13: 1300 lm, L20: 2000 lm, L30: 3000 lm

**Color and Color Temperature**  
 22K: 2200K  
 27K: 2700K  
 30K: 3000K  
 35K: 3500K  
 40K: 4000K  
 DTW: Dim to Warm  
 DTWP: Dim to Warm Plus  
 DWH: Dynamic White  
 DWW: Dynamic Warm White  
 DWWP: Dynamic Warm White Plus

**Optics (Nominal Distribution)**

XN: Extra Narrow Spot Distribution 5°  
 VN: Very Narrow Spot Distribution 10°  
 NS: Narrow Spot Distribution 15°  
 N: Narrow Distribution 25°  
 NFR: Narrow Faceted Reflector 25°  
 M: Medium 40°  
 MFR: Medium Faceted Reflector 40°  
 W: Wide 60°  
 WFR: Wide Faceted Reflector 60°  
 VW: Very Wide 80°  
 VWFR: Very Wide Faceted Reflector 80°

**Decorative Bezel Finish**

MWH: Matte White  
 MBK: Matte Black  
 MSI: Matte Silver  
 NKS: Nickel Satin  
 DCH: Dark Chrome  
 BCH: Bright Chrome  
 SWT: Satin Wheat  
 CC: Custom Color Trim (Specify 4-Digit RAL K7 Color)  
 SP: Special Color (Choose From standard Point Source Color Palette)

**Trim Finish**

MWH: Matte White  
 MBK: Matte Black  
 MSI: Matte Silver  
 NKS: Nickel Satin  
 CC: Custom Color Trim (Specify 4-Digit RAL K7 Color)  
 SP: Special Color (Choose From standard Point Source Color Palette)

**Standard Finishes for Trim**



MWH - Matte white



MBK - Matte black



MSI - Matte Silver

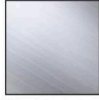

NKS - Nickel satin



CC - Custom color and finish (specify 4-digit RAL K7 color)



SP - Special color (choose from standard Point Source color palette)

**Options**



Emergency battery backup



IP54 rating suitable for wet locations

**Ratings**

IP20

IP54



Wet Location

**Certifications**



**Installation Type**

**RM:** Remodel Non-Insulated Ceiling (Plenum Rated in Accordance to UL 2043 & CAN/ULC-S142)  
**NC:** New Construction Non-Insulated Ceiling (Plenum Rated in Accordance to UL 2043 & CAN/ULC-S142)  
**PC:** Plenum Non-Insulated Ceiling (Enclosed Box)  
**IC:** New Construction Insulated Ceiling (Enclosed Box)  
**IC/AT:** New Construction Insulated Ceiling (Chicago Plenum/airtight, enclosed box)  
**RMR:** Remote Recessed Insulated Ceiling/Plenum (enclosed box)

**Options**

**EBB:** Emergency Battery Backup with Hanger Bar (Bodine BSL17C-C2)  
**EBI:** Emergency Battery Backup with Hanger Bar (Iota ILB-CP07-A TBTS)  
**WET:** IP54 rating suitable for wet locations. For IP55 Shower Rated "Dead Front" applications see Lumencore Nano Shower Rated specification sheet

**Certifications**

UL compliant (this luminaire is listed & labeled for such use in accordance with UL2043 & CAN/ULC-S142), UL Wet Location (WET option only), ENERGY STAR®, RoHS

**Warranty**

5-year limited warranty

**Electrical and Control**

**Voltage**

**120:** 120 Volts, **277:** 277 Volts, **347:** 347 Volts

**Wattage Range**

8.5W to 30W (wattage will vary based on voltage, output, color temperature, color rendering, optic, control and installation type, refer to Power Consumption table for details)

**Control**

**NO:** On/Off Control  
**NO3:** On/Off Control 347V  
**DAMC:** Standard 0-10V Dimming 1% Linear Curve  
**DA1:** Standard 0-10V Dimming 1% Linear Curve  
**DA2:** Standard 1-10V Dimming 1% Logarithmic Curve  
**DA3:** Standard 0-10V Dimming 1% Linear Curve (347V)  
**PDA1:** Professional 0-10V Dimming 0.1% Linear Curve  
**PDA2:** Professional 0-10V Dimming 0.1% Logarithmic Curve  
**PH:** Phase Dimming  
**PPH:** Phase Dimming 1%  
**PHB:** Pro Phase Dimming ERP PHB Series  
**ESP:** Lutron® Hi-lume Premier 0.1% EcoSystem® PEQ0 Soft-on/Fade-to-Black  
**SDALI1:** Standard DALI Dimming 1% Linear Curve  
**SDALI2:** Standard DALI Dimming 1% Logarithmic Curve  
**DALI1:** Professional DALI Dimming 0.1% Linear Curve  
**DALI2:** Professional DALI Dimming 0.1% Logarithmic Curve  
**DALIT8:** DALI-2 T8 Enabled Dimming 1%  
**DMX/RDM:** DMX/RDM Enabled Dimming 1%  
**LT:** Lumentalk Enabled Dimming

**Performance**

**Maximum Delivered Output**

Up to 2,868 lm (Very Wide Faceted Reflector optic 80°, 4000K, CRI 80)

**Maximum Delivered Intensity**

Up to 31,473 cd (Extra Narrow Spot optic 5°, 4000K, CRI 80)

<b>Color Consistency</b>	2 SDCM, 3 SDCM (XN optic only)
<b>Color Rendering</b>	<b>80:</b> CRI 80+, <b>90:</b> CRI 90+, <b>95:</b> CRI 95+
<b>Lumen Maintenance</b>	L95 55,000 hrs (Ta 25 °C) L70 225,000 hrs (Ta 25 °C)

### Environmental

<b>Ingress Protection Rating</b>	IP20, IP54 (with CL accessory and WET option specified)
<b>Environment</b>	Damp location rating (interior applications only) Wet location rating (with WET option only)
<b>Operating Temperature (Ceiling Cavity Ambient Temperature)</b>	-4 °F to 104 °F (DA1, DA2, DA3, PDA1, PDA2, SDALI1, SDALI2, DALI1, DALI2, DALIT8, LT, DMX/RDM, PH and PPH control options), 14 °F to 104 °F (NO control option), 32 °F to 104 °F (NO3, ESP control options and EBB and EBI options)

### Accessories (Order Separately)

<b>Control Systems</b>	Pharos® Designer Lighting Control Kit (PHAROS), Pharos® Expert Control Kit (EXPERT)
<b>Diagnostic and Addressing Tools</b>	LumenID (LID)

### Important

#### Virtual Patent Marking Notice

This website (<https://www.lmpg.com/patents-trademarks>) is provided to satisfy the virtual patent marking provisions of applicable jurisdictions. Some products listed may be covered by additional patents not referenced here.

Photometric Information

XN - Extra Narrow Spot (Nominal 5°), 4000K

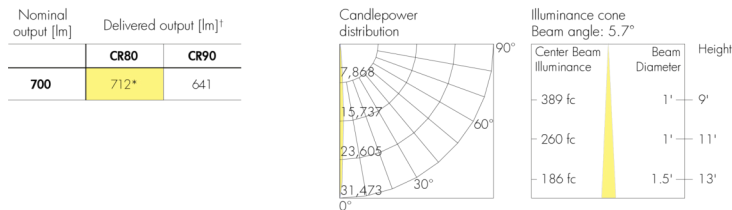

VN - Very Narrow Spot (Nominal 10°), 4000K

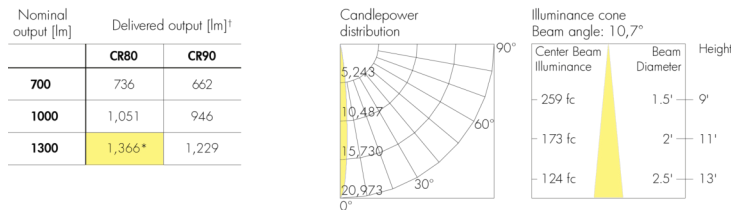

NS - Narrow Spot (Nominal 15°), 4000K

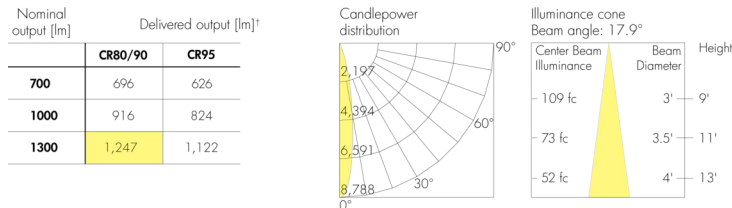

N - Narrow (Nominal 25°), 4000K

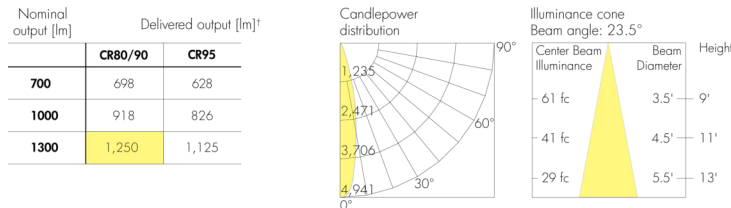

NFR - Narrow Faceted Reflector (Nominal 25°), 4000K

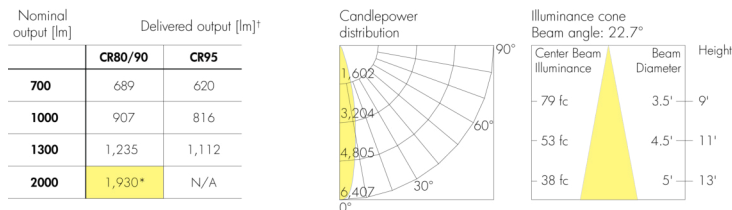

M - Medium (Nominal 40°), 4000K

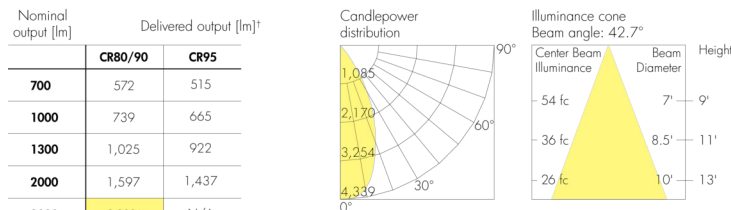

MFR - Medium Faceted Reflector (Nominal 40°), 4000K

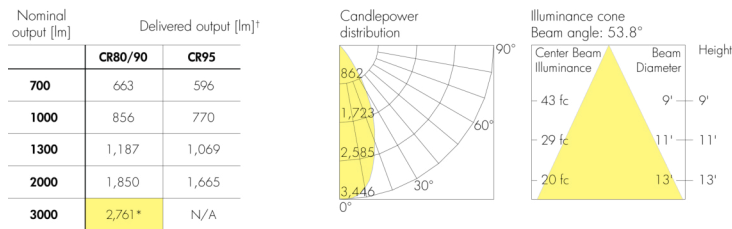

W - Wide (Nominal 60°), 4000K

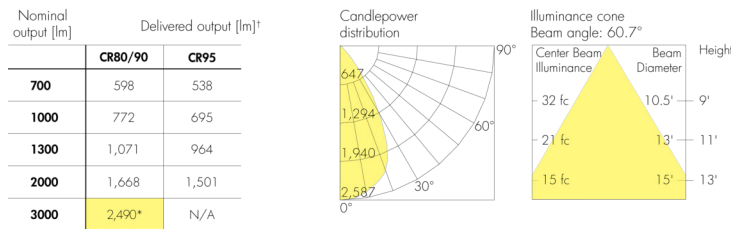

WFR - Wide Faceted Reflector (Nominal 60°), 4000K

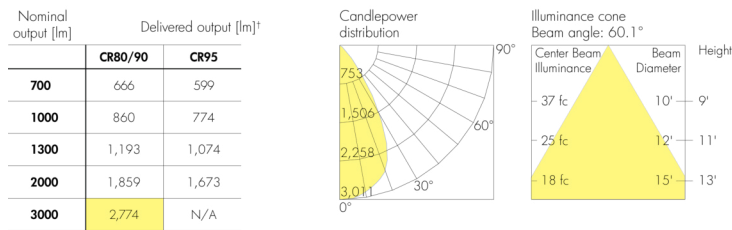

VW - Very Wide (Nominal 80°), 4000K

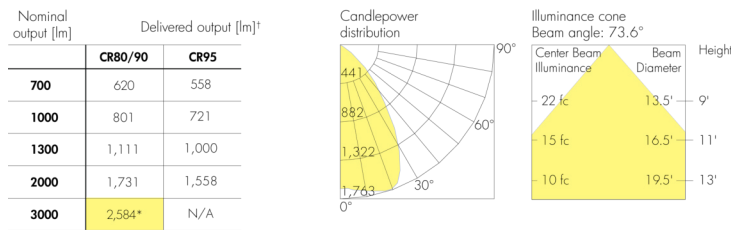

**VWFR - Very Wide Faceted Reflector (Nominal 80°), 4000K**

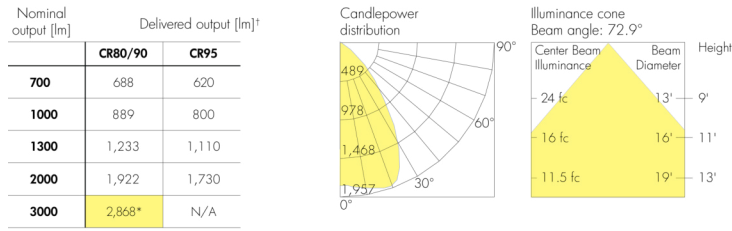

Based on Standard Bezel and Round or Square trim configuration.

† Consult website for IES files. Delivered output: +/- 10% tolerance.

Consult Power consumption section for more wattage information.

\*Photometric performance is measured in compliance with IESNA LM-79-24.

**TM-30**

**CRI 80+**

CRI 80 +				
CCT	CIE		TM-30	
3500K	R <sub>a</sub>	84	84	R <sub>f</sub>
	R <sub>g</sub>	15	97	R <sub>g</sub>

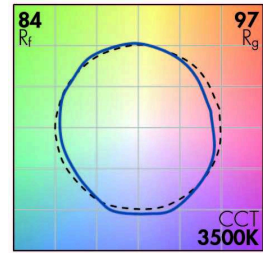

**CRI 90+**

CRI 90 +				
CCT	CIE		TM-30	
3500K	R <sub>a</sub>	94	91	R <sub>f</sub>
	R <sub>g</sub>	55	98	R <sub>g</sub>

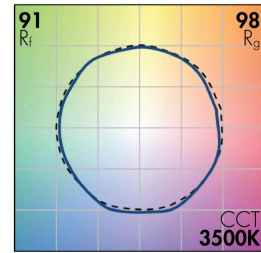

**CRI 95+**

CRI 95 +				
CCT	CIE		TM-30	
3500K	R <sub>a</sub>	97	91	R <sub>f</sub>
	R <sub>g</sub>	97	99	R <sub>g</sub>

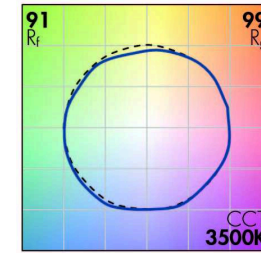

Refer to TM-30 Reference Guide for details.

**Exploded Overview - Part Selection**

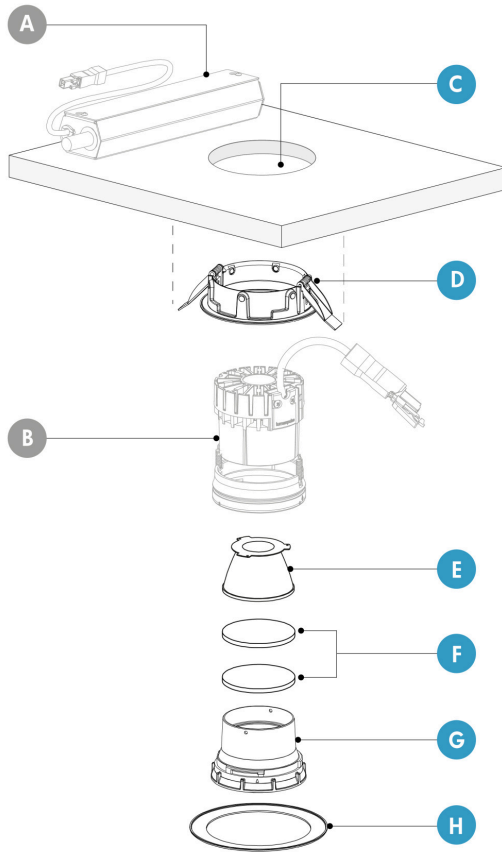

**Standard parts**

- A** - MTG kit
- B** - LUM Core (heatsink, universal fixing ring, LED module)
- MTG: Mounting Kit
- LUM: Luminaire

**Customizable Parts**

- C** - Ceiling cutout shape (round or square)
- D** - Ceiling mounting ring (round or square, based on ceiling cutout selection)
- E** - Optic\*
- F** - Optical accessory (up to two optical accessories can be combined in the fixture, field changeable)
- G** - Decorative bezel\*\*
- H** - Trim (round or square, based on ceiling ring selection)\*\*

\*Field changeable. Consult Interchangeable Optics section of the specification sheet for details. Consult factory for ordering details.

\*\*Field changeable, consult installation instructions for details. Consult factory for ordering details.

## Ceiling Requirements

### Ceiling Cavity Space Requirements (Length x Width x Height)

Installation type	Control	Output/Color Rendering						
		L07	L10	L13	L20		L30	L40
		CR80/90/95			CR80/90	CR95	CR80/90	CR95
RM	NO/PH/PHB/ESP	12"x 8"x 6" (with trim) 12"x 8"x 8" (trimless)			12"x 10"x 8"		N/A	
	DA/DAMC/PDA/SDALI/DALI/LT/DMX-RDM	15"x 8"x 8" (with trim) 15"x 8"x 12" (trimless)					N/A	
NC	NO/PH/PHB/ESP	15"x 10"x 6" (with trim) 15"x 10"x 8" (trimless)			15"x 10"x 8"		N/A	
	DA/DAMC/PDA/SDALI/DALI/LT/DMX-RDM	15"x 10"x 8" (with trim) 15"x 9"x 12" (trimless)					N/A	
PC/IC/ICAT/RMR	ALL	14.5"x 10"x 7"		18"x 15"x 9"		N/A		

See Installation Type section for dimensional view of keep out and/or MTG mounting kit option.

Above dimensions include any keep out requirements for proper airflow and thermal cooling.

**Installation Types**

**RM : Remodel Non-Insulated Ceiling (Plenum Rated in Accordance to UL 2043 & CAN/ULC-S142) (NO, PH, ES and ESP Controls Only)**

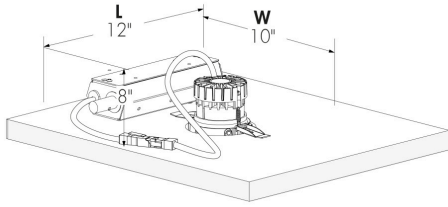

Ceiling cavity space requirements for L20 CR95 and L30 CR80/CR90 shown.

**RM: Remodel Non-Insulated Ceiling (Plenum Rated in Accordance to UL 2043 & CAN/ULC-S142) (Other Controls)**

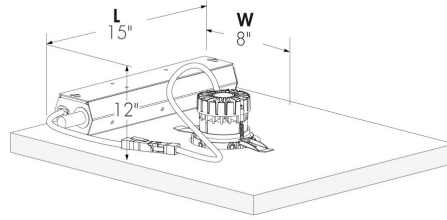

Ceiling cavity space requirements up to L20 CR95 and L30 CR80/CR90 shown, trimless version.

**NC: New Construction Non-Insulated Ceiling (Plenum Rated in accordance to UL 2043 & CAN/ULC-S142) (NO, PH, ES and ESP Control Options only)**

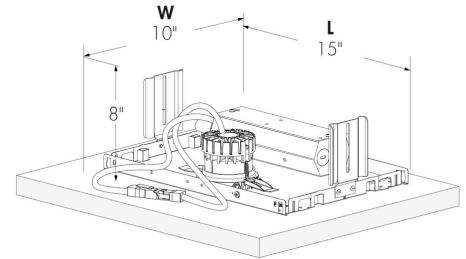

Ceiling cavity space requirements for L20 CR95 and L30 CR80/CR90 shown.

**NC: New Construction Non-Insulated Ceiling (Plenum Rated In Accordance To UL 2043 & CAN/ULC-S142) (Other Controls)**

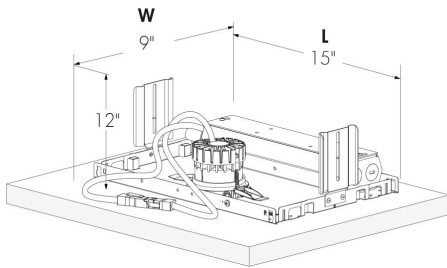

Ceiling cavity space requirements up to L20 CR95 and L30 CR80/CR90 shown, trimless version.

**IC, PC, IC/AT: New Construction Insulated and Non-Insulated Ceiling (Enclosed Box)**

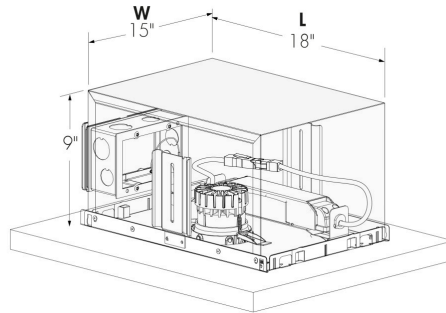

**IC** - New construction insulated ceiling (enclosed box)

**PC** - Plenum non-insulated ceiling (enclosed box)

**IC/AT** - New construction insulated ceiling (Chicago Plenum/airtight, enclosed box)

Ceiling cavity space requirements for L13 CR80/90/95 and L20 CR80/CR90 shown.

**RMR: Remote Recessed Insulated Ceiling/Plenum (Enclosed Box)**

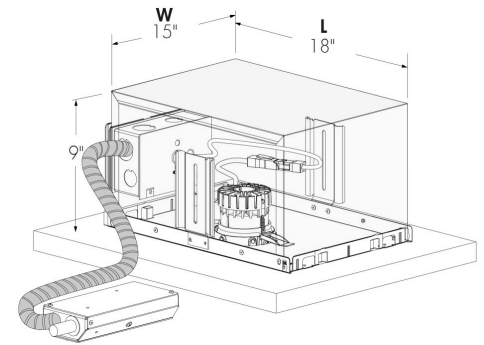

Luminaire ceiling cavity space requirements for L13 CR80/90/95 and L20 CR80/CR90 shown. Refer to remote driver box dimensions in installation instructions for space required for driver.

Remote distance is a maximum of 75 ft, consult Lumenpulse Application Engineering Team for longer remote distances.

Fixture shown for reference only. Refer to Ceiling Requirements section and installation instructions for dimensions and ceiling cutout requirements.

## Ceiling Requirements

### Ceiling Cutout

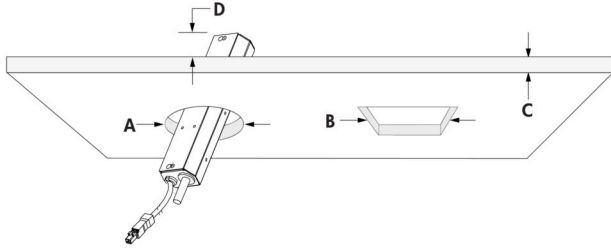

- A - Ceiling cutout: Ø3.25 in
- B - Ceiling cutout: 3.25 in x 3.25 in
- C - Maximum ceiling thickness: 2 in
- D - Minimum ceiling height: refer to Ceiling Cavity Space Requirements table

### Ceiling Thickness Options

#### Ceiling Thickness 1

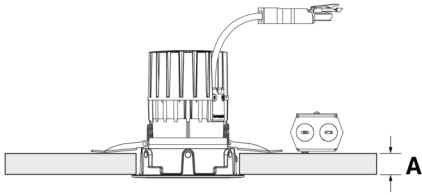

- A - Ceiling thickness range: 0.04 in to 1 in

#### Ceiling Thickness 2

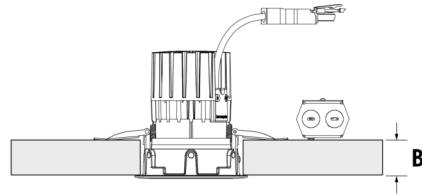

- B - Ceiling thickness range: 1.05 in to 2 in

Ceiling springs are field changeable, consult installation instructions and factory for details.

**Dimensions**

**SB - Standard**

**L07, L10, L13**

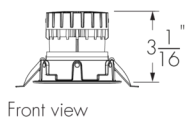

**L20, L30\***

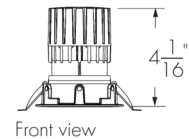

\*Also applicable to L13 for VN optic (CR80/90), L13 for NS and N optics (CR90/95), L13 for DTW and DTWP, L13 for DWH, DWW and DWWP

**SB - Standard (Trimless Version)**

**L07, L10, L13**

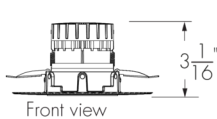

**L20, L30\***

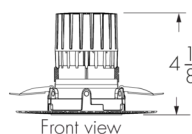

\*Also applicable to L13 for VN optic (CR80/90), L13 for NS and N optics (CR90/95), L13 for DTW and DTWP, L13 for DWH, DWW and DWWP

**MB - Mid/Semi Recess**

**L07, L10, L13**

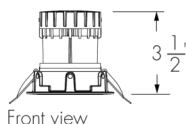

**L20, L30\***

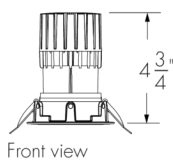

\*Also applicable to L13 for VN optic (CR80/90), L13 for NS and N optics (CR90/95), L13 for DTW and DTWP, L13 for DWH, DWW and DWWP

**TLR - Trimless Round**

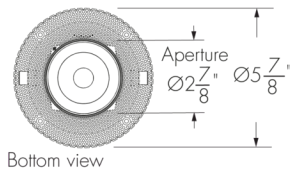

**DB - Deep Recess**

**DR - Deep Rolled Over**

**L07, L10, L13**

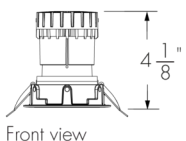

**L20, L30\***

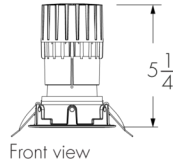

\*Also applicable to L13 for VN optic (CR80/90), L13 for NS and N optics (CR90/95), L13 for DTW and DTWP, L13 for DWH, DWW and DWWP

**TLS - Trimless Square**

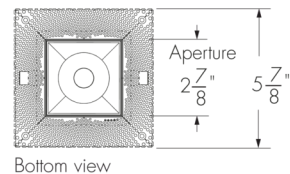

**RD - Round Shape, Round Trim**

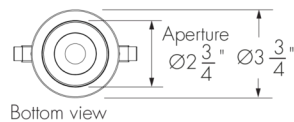

**SQ - Square Shape, Square Trim**

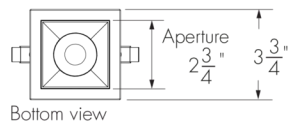

**SR - Square Shape, Round Hole**

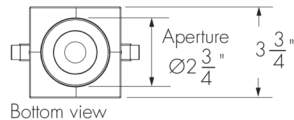

Round ceiling cutout: Ø3.25 in

Square ceiling cutout: 3.25 in x 3.25 in

**Beam Cutoff Angle**

**SB - Standard Decorative Bezel**

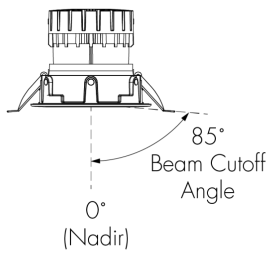

Front view

**MB - Mid/Semi Recess**

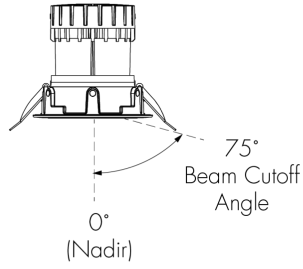

Front view

**DB - Deep Recess**

**DR - Deep Rolled Over**

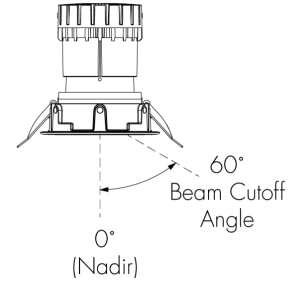

Front view

**Delivery - How it Works**

**Standard Shipping (1 delivery)**

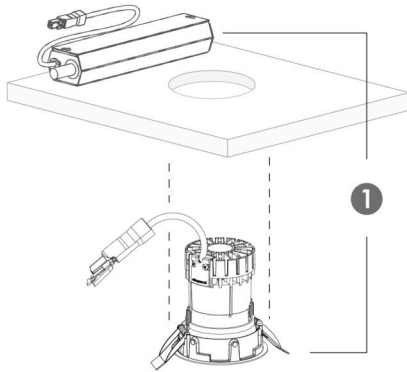

**Included**

- 1. MTG kit and complete fixture assembly

**Advanced Shipping of Mounting kit (2 Separate Deliveries)**

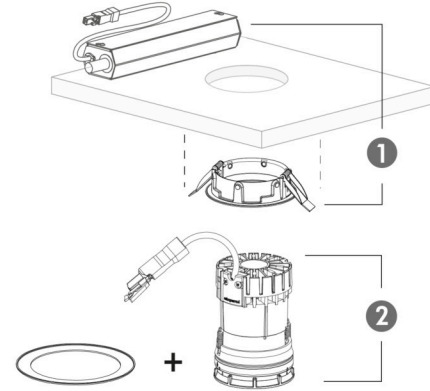

**Included**

- 1. Optional advanced delivery: MTG kit and ceiling mounting ring
- 2. Second delivery: LUM Core (heatsink, universal fixing ring, LED module, optic, accessories, decorative bezel) and trim

Consult factory for Advanced Shipping details.

### Ceiling Cutout Shape Options

#### RD - Round Ceiling Cutout

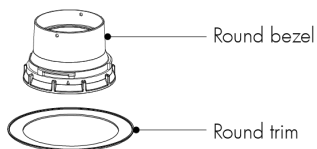

#### SQ - Square Ceiling Cutout

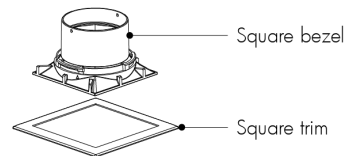

### Decorative Bezel Options

#### RD - Compatible Round Decorative Bezels



#### SQ - Compatible Square Decorative Bezels



### Standard Finishes - Decorative Bezels



\*Custom color: specify 4-digit RAL K7 color.

\*\*Special color: choose one of the standard Point Source colors from the Point Source product brochure or Lumencore Cylinder specification sheets. Contact manufacturer for additional information.

## Trim Shape Options

---

### RD - Compatible Round Trim Shapes



**RD** - Round



**SR** - Square trim with round hole



**TLR** - Trimless round

### SQ - Compatible Square Trim Shapes



**SQ** - Square



**TLS** - Trimless Square

## Standard Finishes - Trims

---



**MWH** - Matte white



**MBK** - Matte black



**MSI** - Matte silver



**NKS** - Nickel satin



**CC** - Custom colour\*



**SP** - Special colour\*\*

\*Custom color: specify 4-digit RAL K7 color.

\*\*Special color: choose one of the standard Point Source colors from the Point Source product brochure or Lumencore Cylinder specification sheets. Contact manufacturer for additional information.

**Optical Accessories**

**HL - Honeycomb Louver**

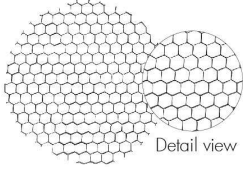

**XLVR - Concentric Ring Louver**

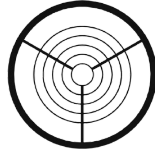

**CL - Clear Glass Lens**



**SL - Softening Glass Lens**



**PD - Prismatic Diffuser**

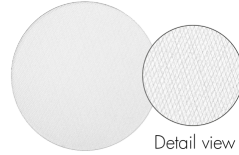

**LSN - Linear Spread Lens Narrow (1° x 40°)**

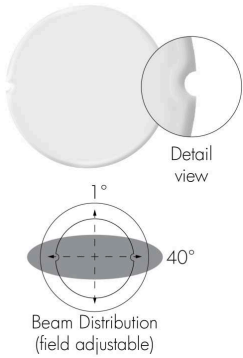

**LSW - Linear Spread Lens Wide (1° x 60°)**

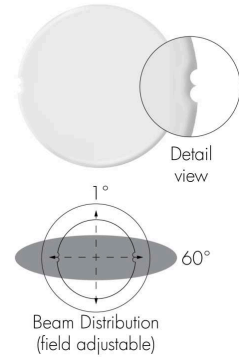

**BW1 - Beam Widening Lens (+10°)**

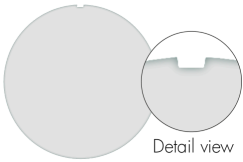

**BW2 - Beam Widening Lens (+20°)**

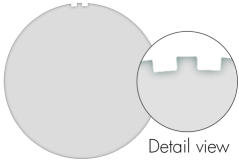

**BW3 - Beam widening lens (+30°)**

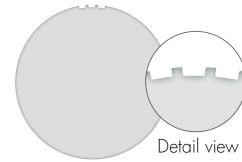

Refer to Beam Widening Lens table for beam distribution based on optic installed in the fixture.

Refer to Beam Widening Lens table for beam distribution based on optic installed in the fixture.

Refer to Beam Widening Lens table for beam distribution based on optic installed in the fixture.

### Optical Accessories - Installation Options (Field Changeable)

#### One Optical Accessory Installed

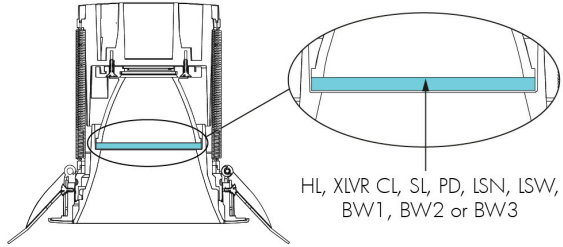

#### Two Optical Accessories Installed

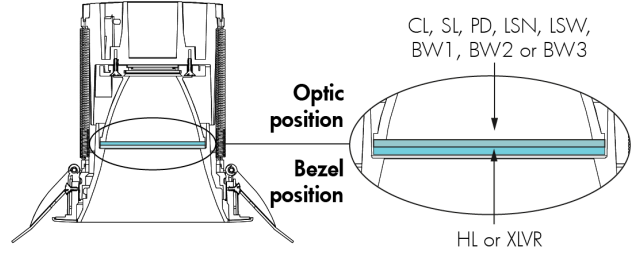

Accessories specified in the fixture code will ship from the factory in the order shown above.

**Optics**

**TIR Optic - Total Internal Reflection**



Applicable to XN (5°), VN (10°), NS (15°) and N (25°) distributions.

**Semi-Specular Reflector**



Applicable to M (40°), W (60°) and VW (80°) distributions.

**Faceted Reflector**



Applicable to NFR (25°), MFR (40°), WFR (60°) and VWFR (80°) distributions.

**Beam Widening Lenses**

	Optic installed in fixture										
	XN 5°	VN 10°	NS 15°	N 25°	NFR 25°	M 40°	MFR 40°	W 60°	WFR 60°	VW 80°	VWFR 80°
<b>BW1</b>	11°	14°	21°	26°	26°	51°	51°	61°	61°	81°	81°
<b>BW2</b>	21°	22°	27°	31°	31°	54°	54°	63°	63°	82°	82°
<b>BW3</b>	30°	32°	35°	38°	38°	58°	58°	67°	67°	85°	85°

The above beam angles are nominal beam angles.

Variations in beam angles can be seen due to different LES sizes. For exact beam calculations please consult factory.

Beam widening lenses should not be used with other accessories with the nominal results above.

**Interchangeable Optics**

	Optic installed in fixture										
	XN 5°	VN 10°	NS 15°	N 25°	NFR 25°	M 40°	MFR 40°	W 60°	WFR 60°	VW 80°	VWFR 80°
<b>Interchangeable optics</b>	N/A	N/A	N NFR	NS NFR	NS N	MFR W WFR VW VWFR	M W WFR VW VWFR	M MFR WFR VW VWFR	M MFR W VW VWFR	M MFR W WFR VWFR	M MFR W WFR VW

The optic options listed above are field changeable. Consult factory and installation instructions for details.

## Power Consumption

### Static White Color Temperatures

Power consumption [W]										
Output [lm]	XN (5°) - VN (10°)		NS (15°) - N (25°) - NFR (25°)				M (40°) - MFR (40°) - W (60°) - WFR (60°) - VW (80°) - VWFR (80°)			
	120 V	277 V	120 V		277 V		120 V		277 V	
	CR80/90		CR80/90	CR95	CR80/90	CR95	CR80/90	CR95	CR80/90	CR95
700	13	15	9.5	10	10.5	12	8.5	9	9.5	11
1000	17*	18*	13	14.5	14	16	10	13	12	15
1300	23*	24*	15	20	16	21	13	15	15	16
2000	N/A	N/A	23**	N/A	24**	N/A	20	23	21	24
3000	N/A	N/A	N/A	N/A	N/A	N/A	30	N/A	30	N/A

\*Not applicable to XN optic.

\*\*Not applicable to NS and N optics.

### Dynamic Colors

Power consumption [W]				
Output [lm]	NFR (25°) - M (40°) - MFR (40°) - W (60°) - WFR (60°) - VW (80°) - VWFR (80°)			
	120 V		277 V	
	DTW - DTWP	DWW - DWH - DWWP	DTW - DTWP	DWW - DWH - DWWP
1000	14	N/A	15	N/A
1300	17	26	19	26

- Power consumption values are for non-insulated ceiling (RM and NC) and remote recessed insulated ceiling/plenum (RMR) installation types. For plenum ceiling (PC), new construction insulated ceiling (IC and IC/AT) installation types, remove 2 watts per fixture.
- Add 3 watts per fixture when specifying LT control option.
- Add 2 watts per fixture when specifying DMX/RDM control option.
- Add 4 watts per fixture when specifying 347V.

## Control

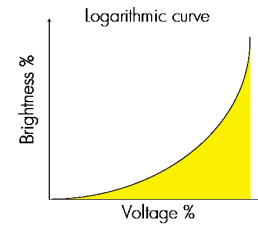
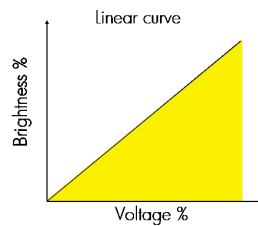

Dimming	Control options with linear dimming curve						Control options with logarithmic dimming curve			
Dimming down to 0.1%	PDA1	ESP	DALI1				PDA2	DALI2	DALI8	
Dimming down to 1%	DA1	DA3	DAMC	PPH	PHB	SDALI1	DA2	SDALI2	DALI8	DMXrDM*

\*DMX/RDM control can be programmed onsite via RDM for linear dimming curve option. Logarithmic curve is standard from factory. Consult factory for further details.

Refer to website product code for exceptions.

## Color and Color Temperature

### Color Temperature Ranges

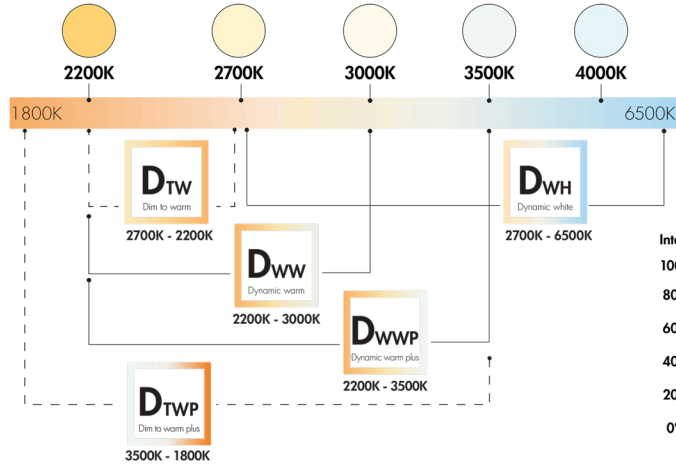

--1 channel (DTW, DTWP) Compatible with: DA1 SDALI1 SDALI2 DMXrdm lumen talk

—2 channels\* (DWH, DWW, DWWP) Compatible with: DALI8 DMXrdm lumen talk

—3 channels (DWH, DWW, DWWP) Compatible with: DALI8 DMXrdm lumen talk

\*Can be changed in the field via RDM & IT for individual CCT control.

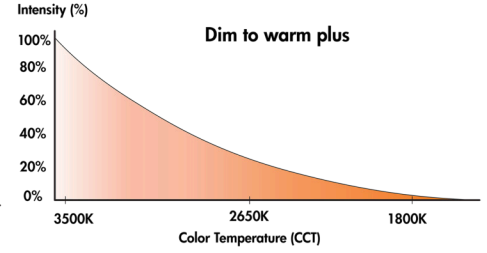
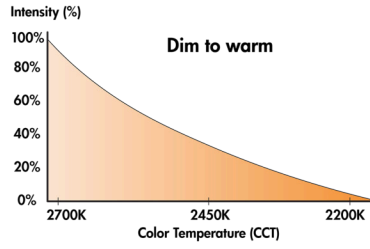

**Wiring Details RM: Remodel Non-Insulated Ceiling (Plenum Rated in Accordance to UL 2043 & CAN/ULC-S142)**

**NO And PH Controls - Wiring Detail**

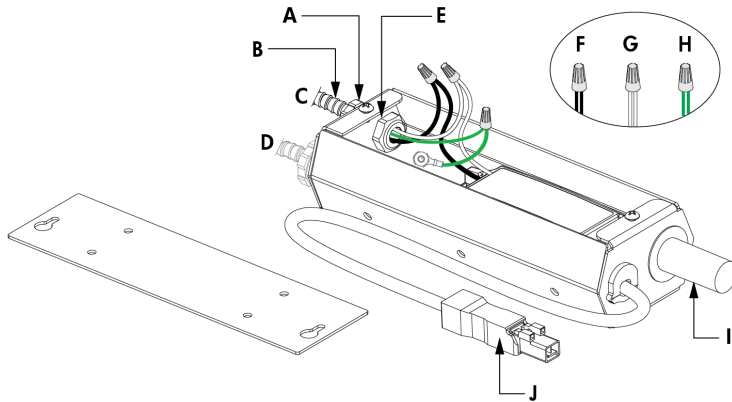

- A - Conduit fitting (by others)
- B - Conduit (by others)
- C - Power Input
- D - Optional Output
- E - Locknut (by others)
- F - Line
- G - Neutral
- H - Ground
- I - Thermal protector
- J - Output to luminaire

**Other Controls - Wiring Detail**

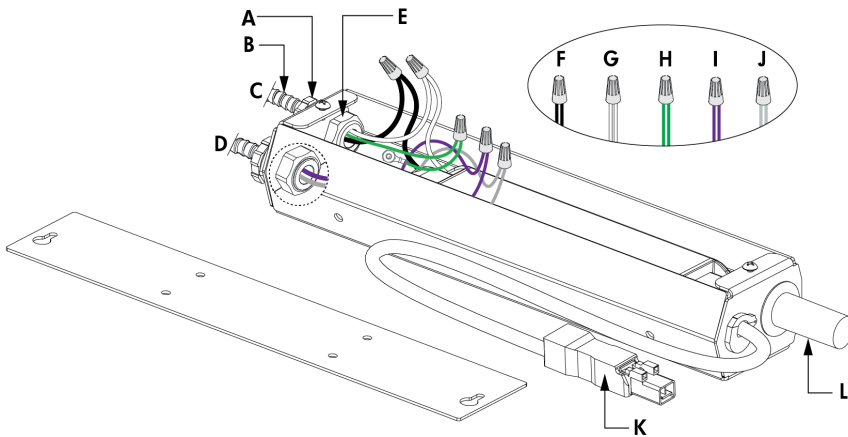

- A - Conduit fitting (by others)
- B - Conduit (by others)
- C - Power Input
- D - Data Input from Control System
- E - Locknut (by others)
- F - Line
- G - Neutral
- H - Ground
- I - Data +
- J - Data -
- K - Output to luminaire
- L - Thermal protector

**Other Controls - Daisy Chain Layout Wiring Detail**

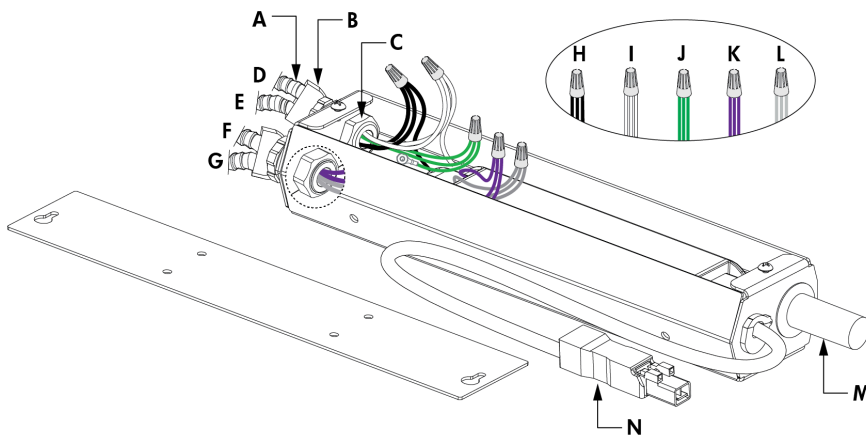

- A - Conduit (by others)
- B - Duplex connector (by others)
- C - Locknut (by others)
- D - Power Output to next luminaire
- E - Power input
- F - Data Output to next luminaire
- G - Data Input from Control System
- H - Line
- I - Neutral
- J - Ground
- K - Data +
- L - Data -
- M - Thermal protector
- N - Output to luminaire

Remodel driver box varies by control option. Refer to installation instructions for additional wiring details.

**Options**

**EBB - Emergency Battery Backup With Hanger Bar (Bodine BSL17C-C2)**

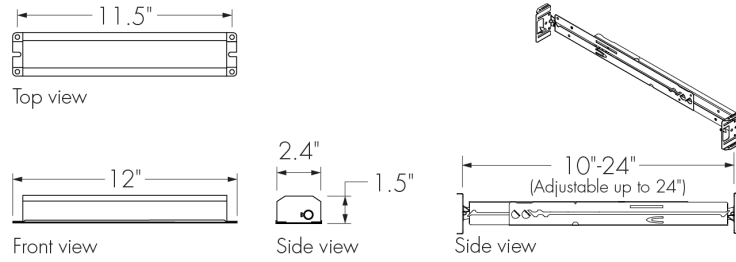

Hardware to mount the battery backup to the hanger bar is included. A test button is included. The unit comes pre-wired with 2 ft flexible conduit in and out. Refer to installation instructions for details.

**EBI - Emergency Battery Backup With Hanger Bar (Iota ILB-CP07-A TBTS)**

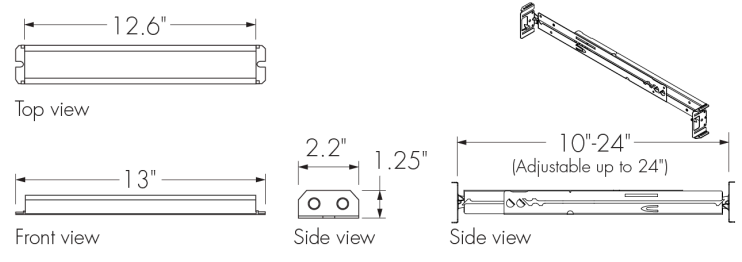

Hardware to mount the battery backup to the hanger bar is included. A test button is included. The unit comes pre-wired with 2 ft flexible conduit in and out. Refer to installation instructions for details.

**Diagnostic And Addressing Tools (Order Separately)**

**LID - LumenID**

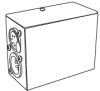

The updated LumenID (LID) is an all-in-one diagnostic and addressing solution for both DMX/RDM and Lumentalk (LT) systems. Engineered for versatility, it streamlines commissioning and troubleshooting across protocols—no need for multiple tools. Cable option may vary; please consult factory. For complete details, refer to the LID specification sheet.

**Control Systems (Order Separately)**

**PHAROS - Pharos® Designer Lighting Control Kit**



The Pharos Designer Lighting Control Kit, available for 1 or 2 DMX universes, allows for complete control of large lighting installations.

**EXPERT - Pharos® Expert Control Kit**



The Pharos Expert Control Kit, available for 1, 2, 4 or 6 DMX universes, allows for complete control of large lighting installations.

How to Order

Housing <sup>(1)</sup>	EZ Ship	Certification	Type	Voltage	Cutout	Output (Nominal Lumens)	Color and Color Temperature	Color Rendering	Optics (Nominal Distribution)	Control <sup>(24)</sup>
LCRN Lumencore Recessed Nano - 2.75 in	EZ Ship <sup>(2)</sup>	A UL/cUL  ESR UL/cUL & ENERGY STAR® <sup>(5)</sup>	FD Downlight	120 120 Volts 277 277 Volts 347 347 Volts <sup>(4)</sup> <sup>(5)</sup> <sup>(6)</sup> <sup>(7)</sup> <sup>(8)</sup>	R Round  S Square	L07 700 lm <sup>(9)</sup> L10 1000 lm L13 1300 lm L20 2000 lm L30 3000 lm <sup>(9)</sup> <sup>(10)</sup> <sup>(11)</sup>	22K 2200K <sup>(7)</sup> <sup>(12)</sup> <sup>(13)</sup> 27K 2700K <sup>(13)</sup> 30K 3000K <sup>(13)</sup> 35K 3500K <sup>(13)</sup> 40K 4000K <sup>(13)</sup>  DTW Dim to Warm (2700K to 2200K) <sup>(7)</sup> <sup>(14)</sup> <sup>(15)</sup> <sup>(16)</sup> DTWP Dim to Warm Plus (3500K to 1800K) <sup>(7)</sup> <sup>(14)</sup> <sup>(15)</sup> <sup>(16)</sup> DWH Dynamic White (2700K to 6500K) <sup>(7)</sup> <sup>(15)</sup> <sup>(17)</sup> <sup>(18)</sup> DWW Dynamic Warm White (2200K to 3000K) <sup>(7)</sup> <sup>(15)</sup> <sup>(17)</sup> <sup>(18)</sup> DWWP Dynamic Warm White Plus (2200K to 3500K) <sup>(7)</sup> <sup>(15)</sup> <sup>(17)</sup> <sup>(18)</sup>	80 CRI 80+  90 CRI 90+  95 CRI 95+ <sup>(7)</sup>	XN Extra Narrow Spot Distribution 5° <sup>(7)</sup> <sup>(19)</sup>  VN Very Narrow Spot Distribution 10° <sup>(7)</sup> <sup>(20)</sup>  NS Narrow Spot Distribution 15° <sup>(21)</sup>  N Narrow Distribution 25° <sup>(21)</sup>  NFR 25° Faceted Reflector <sup>(22)</sup>  M Medium 40° <sup>(23)</sup>  MFR 40° Faceted Reflector <sup>(23)</sup>  W Wide 60° <sup>(23)</sup>  WFR 60° Faceted Reflector <sup>(23)</sup>  VW 80° Reflector <sup>(23)</sup>  VWFR 80° Faceted Reflector <sup>(23)</sup>	NO On/Off Control <sup>(7)</sup> <sup>(25)</sup> <sup>(26)</sup> NO3 On/Off Control 347V <sup>(4)</sup> <sup>(5)</sup> <sup>(7)</sup> <sup>(27)</sup> DAMC Standard 0-10V Dimming 1% Linear Curve <sup>(6)</sup> <sup>(7)</sup> <sup>(26)</sup> <sup>(28)</sup> <sup>(29)</sup> DA1 Standard 0-10V Dimming 1% Linear Curve <sup>(26)</sup> <sup>(30)</sup> DA2 Standard 1-10V Dimming 1% Logarithmic Curve <sup>(26)</sup> <sup>(30)</sup> DA3 Standard 0-10V Dimming 1% Linear Curve (347V) <sup>(4)</sup> <sup>(5)</sup> <sup>(7)</sup> <sup>(27)</sup> PDA1 Professional 0-10V Dimming 0.1% Linear Curve <sup>(26)</sup> <sup>(30)</sup> PDA2 Professional 0-10V Dimming 0.1% Logarithmic Curve <sup>(26)</sup> <sup>(30)</sup> PH Phase Dimming <sup>(31)</sup> <sup>(32)</sup> PPH Phase Dimming 1% <sup>(5)</sup> <sup>(6)</sup> <sup>(7)</sup> <sup>(32)</sup> <sup>(33)</sup> PHB Pro Phase Dimming ERP PHB Series <sup>(6)</sup> <sup>(29)</sup> <sup>(34)</sup> <sup>(35)</sup> ESP Lutron® Hi-lume Premier 0.1% EcoSystem® PEQO Soft-on/Fade-to-Black <sup>(7)</sup> <sup>(26)</sup> <sup>(36)</sup> <sup>(37)</sup> SDALI1 Standard DALI Dimming 1% Linear Curve <sup>(7)</sup> <sup>(26)</sup> SDALI2 Standard DALI Dimming 1% Logarithmic Curve <sup>(7)</sup> <sup>(26)</sup> DALI1 Professional DALI Dimming 0.1% Linear Curve <sup>(7)</sup> <sup>(26)</sup> DALI2 Professional DALI Dimming 0.1% Logarithmic Curve <sup>(7)</sup> <sup>(26)</sup> DALI8 DALI-2 T8 Enabled Dimming 1% <sup>(5)</sup> <sup>(7)</sup> <sup>(26)</sup> <sup>(38)</sup> <sup>(39)</sup> DMX/RDM DMX/RDM Enabled Dimming 1% <sup>(7)</sup> <sup>(26)</sup> <sup>(40)</sup> <sup>(41)</sup> <sup>(42)</sup> LT Lumentalk Enabled Dimming <sup>(7)</sup> <sup>(26)</sup> <sup>(43)</sup>

Notes:

1. Refer to website product configurator for all exceptions.
2. Refer to website for EZ Ship configurations.
3. Refer to website for ENERGY STAR certified product configurations.
4. Not available for 700 lumens. Not available for 1000 lumens when combined with 80 color rendering option.
5. Not available for XN and VN optics.
6. Not available for DTW, DTWP, DWH, DWW or DWWP color options.
7. Not available for ENERGY STAR certification.
8. Not available for CR90.
9. For ENERGY STAR certification, not available with RM or NC installation types when combined with 90 color rendering option.
10. Available for M, MFR, W, WFR, VW and VWFR optics only.
11. Not available with PC, IC, IC/AT or RMR installation types.
12. Available for CRI 80 only.
13. Compatible with all control options except for DALI8.
14. Available for 1000 and 1300 lumens when combined with 90 color rendering option and MFR, W, WFR, VW or VWFR optics only.
15. MFR, WFR and VWFR faceted reflector optics are recommended for optimal performance.
16. Compatible with DA1, SDALI1, SDALI2, DMX/RDM and LT control options only.
17. Available for 1300 lumens when combined with 80 color rendering option and MFR, W, WFR, VW or VWFR optics only.
18. Compatible with LT, DMX/RDM and DALI8 control options only.
19. Available for 700 lumens when combined with 80 or 90 color rendering options and 27K, 30K, 35K or 40K color temperature options only.
20. Available up to 1300 lumens when combined with 80 or 90 color rendering options and 27K, 30K, 35K or 40K color temperature options only.
21. Available up to 1300 lumens when combined with 80, 90 or 95 color rendering options only.
22. Available up to 2000 lumens when combined with 80 color rendering option and up to 1300 lumens when combined with 80, 90 or 95 color rendering options only.
23. Available up to 3000 lumens when combined with 80 color rendering option and up to 2000 lumens when combined with 80, 90 or 95 color rendering options only.
24. Control options vary according to color temperature, color rendering, optics and installation type combination. Refer to website product configurator for details.
25. Manufacturer's choice driver. Order code may change to NO1.
26. Not available with 347V.
27. Not available for 3000 lumens.
28. Manufacturer's choice driver. Order code may change to DAMC1 or DAMC2.
29. Not available for XN and VN optics.
30. Driver cuts off power to the fixture when the control signal drops below 0.5V.

- 31. Manufacturer's choice driver. Order code may change to PH1 or PH2.
- 32. Available for 120V voltage option only.
- 33. Manufacturer's choice driver. Order code is subject to change.
- 34. Not available for 700 lumens.
- 35. Not available for M, MFR, W, WFR, VW and VWFR optics when combined with 1000 lumens.
- 36. One EcoSystem® address per fixture. Lutron® EcoSystem® Enabled dimming not available for 1300 lumens combined with VN optic. Available for static white color temperatures only.
- 37. Not available for 3000 lumens.
- 38. Available for DWH, DWW and DWWP color options only. DALI-2 Type 8 controller required.
- 39. Not available for PC, IC or IC/AT installation types.
- 40. Configurable between 8 or 16-bit dimming control via RDM. DMX/RDM requires LumenID, LumenID software and onsite commissioning.
- 41. A Control Box (CBX-DS or CBX-ST) and lumenID (LID) must be specified.
- 42. Configurable to 1, 2, or 3 channel control via RDM in the field.
- 43. A Lumentranslator 2 (LTL2) and LumenID (LID) must be specified for Lumentalk applications. Consult Lumentranslator 2 and Lumentalk pages and specification sheets for details.

How to Order

Decorative Bezel	Decorative Bezel Finish	Trim <sup>(49)</sup>	Trim Finish	Installation Type	Ceiling Thickness <sup>(56)</sup>	Option	Accessories <sup>(64)</sup>
<b>SB</b> Standard	<b>MWH</b> Matte White	<b>RD</b> Round <sup>(50)</sup>	<b>MWH</b> Matte White	<b>RM</b> Remodel Non-Insulated Ceiling (Plenum Rated in Accordance to UL 2043 & CAN/ULC-S142) <sup>(52)</sup>	<b>1</b> 0.04 in to 1 in Ceiling Thickness	<b>WET</b> IP54 Rating Suitable for Wet Locations <sup>(57)</sup> <sup>(58)</sup> <sup>(59)</sup> <sup>(60)</sup>	<b>NA</b> No Accessory
<b>MB</b> Mid/Semi Recess	<b>MBK</b> Matte Black <sup>(44)</sup>	<b>SR</b> Square Trim with Round Hole <sup>(50)</sup>	<b>MBK</b> Matte Black	<b>NC</b> New Construction Non-Insulated Ceiling (Plenum Rated in Accordance to UL 2043 & CAN/ULC-S142) <sup>(52)</sup>	<b>2</b> 1.05 in to 2 in Ceiling Thickness	<b>EBB</b> Emergency Battery Backup with Hanger Bar (Bodine BSL17C-C2) <sup>(6)</sup> <sup>(7)</sup> <sup>(26)</sup> <sup>(61)</sup> <sup>(62)</sup> <sup>(63)</sup>	<b>HL</b> Honeycomb Louver <sup>(7)</sup> <sup>(65)</sup>
<b>DB</b> Deep Recess	<b>MSI</b> Matte Silver	<b>TLR</b> Trimless Round <sup>(50)</sup>	<b>MSI</b> Matte Silver	<b>IC</b> New Construction Insulated Ceiling (Enclosed Box) <sup>(37)</sup> <sup>(53)</sup> <sup>(54)</sup>		<b>EBI</b> Emergency Battery Backup with Hanger Bar (Iota ILB-CP07-A TBTS) <sup>(6)</sup> <sup>(7)</sup> <sup>(26)</sup> <sup>(61)</sup> <sup>(62)</sup> <sup>(63)</sup>	<b>XLVR</b> Concentric Ring Louver <sup>(7)</sup> <sup>(66)</sup> <sup>(67)</sup>
<b>DR</b> Deep Rollover	<b>NKS</b> Nickel Satin <sup>(45)</sup>	<b>SQ</b> Square <sup>(51)</sup>	<b>NKS</b> Nickel Satin	<b>IC/AT</b> New Construction Insulated Ceiling (Chicago Plenum/airtight, enclosed box) <sup>(37)</sup> <sup>(53)</sup> <sup>(54)</sup>			<b>CL</b> Clear Glass Lens <sup>(60)</sup>
	<b>DCH</b> Dark Chrome <sup>(44)</sup>	<b>TLS</b> Trimless Square <sup>(51)</sup>	<b>CC</b> Custom Color Trim <sup>(47)</sup>	<b>RMR</b> Remote Recessed Insulated Ceiling/Plenum (enclosed box) <sup>(37)</sup> <sup>(53)</sup> <sup>(54)</sup> <sup>(55)</sup>			<b>SL</b> Softening Glass Lens <sup>(7)</sup>
	<b>BCH</b> Bright Chrome <sup>(45)</sup>		<b>SP</b> Special Point Source Color <sup>(48)</sup>				<b>PD</b> Prismatic Diffuser <sup>(60)</sup> <sup>(68)</sup>
	<b>SWT</b> Satin Wheat <sup>(46)</sup>						<b>LSN</b> Linear Spread Lens Narrow (1° x 40°) <sup>(7)</sup> <sup>(69)</sup> <sup>(70)</sup>
	<b>CC</b> Custom Color Trim <sup>(46)</sup> <sup>(47)</sup>						<b>LSW</b> Linear Spread Lens Wide (1° x 60°) <sup>(7)</sup> <sup>(70)</sup> <sup>(71)</sup>
	<b>SP</b> Special Point Source Color <sup>(46)</sup> <sup>(48)</sup>						<b>BW1</b> Beam Widening Lens (+10°) <sup>(7)</sup> <sup>(70)</sup>
							<b>BW2</b> Beam Widening Lens (+20°) <sup>(7)</sup> <sup>(70)</sup>
							<b>BW3</b> Beam Widening Lens (+30°) <sup>(7)</sup> <sup>(70)</sup>

Notes:

- 6. Not available for DTW, DTWP, DWH, DWW or DWWP color options.
- 7. Not available for ENERGY STAR certification.
- 26. Not available with 347V.
- 37. Not available for 3000 lumens.
- 44. For ENERGY STAR certification, not available with MB, DB and DR decorative bezels when combined with RM or NC installation types or PC, IC and IC/AT installation types when combined with 90 color rendering option.
- 45. For ENERGY STAR certification, not available with MB, DB and DR decorative bezels when combined with RM or NC installation types.
- 46. For ENERGY STAR certification, not available with MB, DB and DR decorative bezels.
- 47. Longer lead times can be expected for custom RAL color finishes.
- 48. Refer to Cylinder specification sheet and brochure for color options.
- 49. Not applicable to DR bezel option.
- 50. Cannot be combined with square ceiling cutout.
- 51. Cannot be combined with round ceiling cutout.
- 52. Available for 700 lumens when combined with XN optic and up to 1300 lumens when combined with VN, NS and N optics. Available up to 2000 lumens when combined with NFR optic and up to 3000 lumens when combined with M, MFR, W, WFR, VW and VWFR optics. Refer to optic option notes for color rendering limitations.
- 53. Available for 700 lumens when combined with XN optic and up to 1300 lumens when combined with VN, NS, N and NFR optics. Available up to 2000 lumens when combined with NFR optic and up to 3000 lumens when combined with M, MFR, W, WFR, VW and VWFR optics. Refer to optic option notes for color rendering limitations.
- 54. Not available for DWH, DWW or DWWP color options.
- 55. Remote distance is a maximum of 75 ft. For longer remote distances, please contact Lumenpulse Application Engineering Team for application validation.
- 56. Ceiling springs are field changeable, consult factory and installation instructions for details.
- 57. IP54 rating only if installation is interior covered recessed ceiling-mounted or exterior canopy-mounted.
- 58. DR bezel is recommended for outdoor canopy installations.
- 59. A CL, SL or PD must be specified to maintain an IP54 rating. A second accessory may be specified.
- 60. For ENERGY STAR certification, not available with RM or NC installation types when combined with 90 color rendering option combined and 2000 lumens.
- 61. Available for RM and NC installation types only.
- 62. Emergency battery backup options are field installed and not presided by Lumenpulse. Refer to related installation instructions for details.
- 63. Emergency battery backup options require ceiling access for test button use. The battery will operate for 90 minutes minimum and maintain a minimum of 1 fc from a 7 ft 2 in height as per UL 924. For indoor use only in dry or damp locations.
- 64. Maximum two accessories per fixture.
- 65. Not available for DTW and DTWP color options.
- 66. Available for XN, VN and NS optics only.
- 67. Can be combined with PD accessory only.
- 68. Recommended to be combined with HL or XLVR accessory only.
- 69. Recommended for XN, VN, NS, N and NFR optics when combined with 2200K, 2700K, 3000K, 3500K, 4000K color temperature options. Nominal 10° x 40° distribution when used with the NS optic. Recommended for MFR optic when combined with DTW, DTWP, DWH, DWW or DWWP color options only.
- 70. For optimal performance, it is not recommended to mix with other accessories.
- 71. Recommended for XN, VN, NS, N and NFR optics when combined with 2200K, 2700K, 3000K, 3500K, 4000K color temperature options only. Nominal 10° x 60° distribution when used with the NS optic. Recommended for MFR optic when combined with DTW, DTWP, DWH, DWW or DWWP color options only.