

# Voilà

4" Round Downlight  
Fixed/Adjustable

# LUMENWERX

Project: \_\_\_\_\_

Type: \_\_\_\_\_

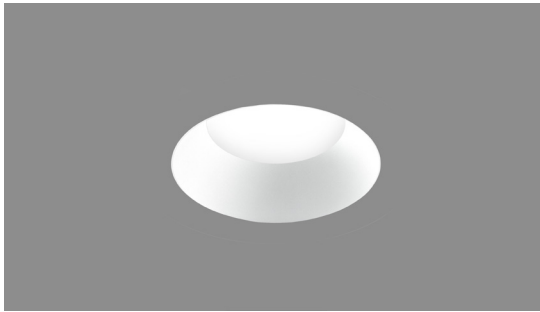

Trimless



Trim

Voila 4" round downlights feature innovative Hyflex™ optics for precise beam control. Shallow construction requires only 4" recess depth. Driver can be replaced through 2" aperture. The Voila COB source with 90 CRI and 2-step color consistency matches other Lumenwerx luminaires, and is available with Chromawerx SOLA (dim-to-warm) and DUO (tunable white), as well as emergency option. Complete Voila offering includes 2" and 4" apertures; downlights, adjustables, and wall washers; round and square trim; and cylinders; see separate specifications.

## Performance

LUMEN OUTPUT <sup>1</sup>	WATTS	EFFICACY LM/W
1501 lm	14 W	107 lm/W
2037 lm	20 W	102 lm/W
2744 lm	28 W	98 lm/W

<sup>1</sup> Lumens packages are assuming 3500K, 80CRI, 30° beam, round white baffle

Delivered Lumens for Round White Standard Baffles at 35K

BEAM	90 CRI							
	10	20	30	40	50	60	75	90
Low - 13.8 W	1257	1203	1410	1424	1379	1363	1333	1302
Medium - 19.7 W	1576	1508	1912	1933	1871	1849	1808	1766
High - 28 W	1932	1848	2576	2604	2520	2492	2436	2380



Some restrictions may apply.

### Aperture Size

4.00"

### Configurations



Fixed, adjustable & wall wash (see other spec sheets for all the configurations)

### Baffle Depth







Standard 1.00"

### Trim





Trim & Trimless

### Baffle & Trim Flange Finishes

- Textured matte white 
- Textured matte black 
- Mixed black & white 
- Custom RAL 

### Color Temperature

- 2700K 
- 3000K 
- 3500K 
- 4000K 
- SOLA 
- DUO 

Delivered 1294-2800 lm  
14-28 Watts, up to 111 lm/W

### Integral Drivers

0-10V, TRIAC, ELV, eldoLED & Lutron

### Remote Drivers

Lutron, eldoLED and other drivers

Emergency battery pack

## 1 - Housing (Example: VO4RR-TRM-SW-OF-ASB-120-14W-D1)

Product Specification

LUMINAIRE ID	TRIM STYLE	LIGHT SOURCE	INSTALLATION TYPE	MOUNTING OPTION	VOLTAGE	WATTAGE (80 CRI) <sup>3</sup>	DIMMING		
<b>VO4RR</b>									
<b>VO4RR</b> - Voila 4" Round Recessed	<b>TRM</b> - Flanged trim <b>TLMP</b> - Trimless drywall mudplate <b>TLMW</b> - Trimless millwork	<b>SW</b> - Static white  <b>SOLA</b> - Dim-to-warm  <b>DUO</b> - Tunable white	<b>OF</b> - Open frame type non-IC <b>IC</b> <sup>1</sup> - IC rated <b>CP</b> <sup>1</sup> - Chicago Plenum type-IC (CCEA)  <sup>1</sup> IC/CP with low output only.	<b>ACB</b> - Adjustable commercial bar hangers (grid and drywall) <b>ASB</b> - Adjustable standard bar hangers (grid and drywall) <b>FMB</b> - Flush mount bars (drywall only) <b>AHC</b> - Adjustable hat channel bars	<b>120</b> - 120V <b>UNV</b> - 120V-277V <b>347</b> <sup>2</sup> - 347V  <sup>2</sup> Available with 0-10V dimming options D1, RD1 and RSD1 only. Consult factory for details.	<b>14W</b> - Low output 1294-1532 lm <b>20W</b> <sup>4</sup> - Medium output 1623-2078 lm <b>28W</b> <sup>4</sup> - High output 1988-2800 lm  For other lumen packages, please consult factory.  <b>SOLA</b> <b>13W</b> - Low output 920 lm (20° only) <b>25W</b> <sup>4</sup> - High output 1800-1981 lm (40° and up)  <b>DUO</b> <b>10W</b> - Low output 700 lm (20° only) <b>20W</b> <sup>4</sup> - High output 1100-1200 lm (40° and up)  <sup>3</sup> For delivered lumens and other CRI, see multiplier tables on page 3. <sup>4</sup> Available with <b>OF</b> housing only.	<b>INTEGRAL</b> <b>D1</b> - 1% 0-10V <b>ELV</b> <sup>5</sup> - ELV 120V <b>TRI</b> <sup>5</sup> - TRIAC 120V <b>LTEA2W</b> <sup>5,6</sup> - Lutron 1% - 2 wire FP 120V <b>LDE1</b> <sup>6</sup> - Lutron Hi-Lume 1% Eco <b>LDE5</b> <sup>6</sup> - Lutron 5% EcoSystem <b>DA</b> <sup>6</sup> - DALI <b>ELDO</b> <sup>6</sup> - eldoLED 0.1% <b>ELD1</b> <sup>6</sup> - eldoLED 1% <b>DEB</b> <sup>7</sup> - 0-10V with onboard emergency battery backup  <b>SOLA</b> <b>SDI</b> - Single 0-10V input  <b>DUO</b> <b>PSQO</b> <sup>7</sup> - Lutron T-Series 1% tunable white  <sup>5</sup> Available with 120V only. <sup>6</sup> Not available with <b>CP</b> installation type. <sup>7</sup> Available with <b>OF</b> housing only.	<b>REMOTE</b> <b>RD1</b> - 1% 0-10V <b>RELV</b> <sup>8</sup> - ELV 120V <b>RTRI</b> <sup>8</sup> - TRIAC 120V <b>RLTEA2W</b> <sup>8</sup> - Lutron 1% - 2 wire FP 120V <b>RLDE1</b> - Lutron Hi-lume 1% Eco <b>RLDE5</b> - Lutron 5% EcoSystem <b>RDA</b> - DALI <b>RELD0</b> - eldoLED 0.1% <b>RELD1</b> - eldoLED 1%  <b>SOLA</b> <b>RSD1</b> - Single 0-10V input  <b>DUO</b> <b>RDMX</b> - To specify, see pages 7 to 9 <b>RDDA</b> - DALI <b>RDD1</b> - Dual 0-10V input for CCT/intensity <b>RPSQO</b> - Lutron T-Series 1% tunable white  <sup>8</sup> Available with 120V only.	<b>+EB</b> <sup>9</sup> - Emergency battery  <sup>9</sup> Specify with remote dimming only. The code will be like the following example: <b>RD1 + EB</b> .

## 2 - Light (Example: VO4-SW-10-2-90-27-LS)

LUMINAIRE ID	LIGHT SOURCE	BEAM	COLOR QUALITY	CRI	COLOR TEMP	OPTION	
<b>VO4</b>							
<b>VO4</b> - Voila 4"	<b>SW</b> - Static white  <b>SOLA</b> - Dim-to-warm <b>DUO</b> - Tunable white	<b>10</b> - 10° Narrow spot <b>20</b> - 20° Spot <b>30</b> - 30° Narrow flood <b>40</b> - 40° Flood <b>50</b> - 50° Wide flood <b>60</b> - 60° Very wide flood <b>75</b> - 75° Very wide flood <b>90</b> - 90° Open flood	<b>SOLA/DUO</b> <b>20</b> <sup>10</sup> - 20° Spot <b>40</b> <sup>11</sup> - 40° Flood <b>50</b> <sup>11</sup> - 50° Wide flood <b>60</b> <sup>11</sup> - 60° Very wide flood <b>75</b> <sup>11</sup> - 75° Very wide flood <b>90</b> <sup>11</sup> - 90° Open flood  <sup>10</sup> Available with low output only. <sup>11</sup> Available with high output only.	<b>2</b> - 2 Step MacAdam Ellipse  <b>3</b> - 3 Step MacAdam Ellipse	<b>90</b> - 90 CRI <b>80</b> - 80 CRI <b>97</b> - 97 CRI (not available for 3500K)  <b>90</b> - 90 CRI ( <b>SOLA</b> and <b>DUO</b> )	<b>27</b> - 2700K <b>30</b> - 3000K <b>35</b> - 3500K <b>40</b> - 4000K  <b>SOLA</b> - Dim-to-warm 35K-22K <b>DUO</b> - Tunable white 27K-65K	<b>LS</b> <sup>12</sup> - Linear spread <b>HEX</b> <sup>12</sup> - Hex louver <b>NA</b> - None  <sup>12</sup> Hex louver & linear spread cannot be combined together.

## 3 - Baffle (Example: VO4RRB-TRM-SDL-SR-TMW-TMW)

LUMINAIRE ID	TRIM STYLE <sup>13</sup>	LENS <sup>13</sup>	BAFFLE POSITION	BAFFLE FINISH <sup>13</sup>	TRIM FLANGE FINISH <sup>13</sup>
<b>VO4RRB</b>			<b>SR</b>		
<b>VO4RRB</b> - Voila 4" Round Recessed Baffle	<b>TRM</b> - Flanged trim <b>TLMP</b> - Trimless drywall mudplate <b>TLMW</b> - Trimless millwork	<b>SDL</b> - Soft diffused lens <b>FDL</b> - Frosted diffused lens <b>NOL</b> - No lens	<b>SR</b> - Standard regress	<b>TMW</b> - Textured matte white <b>TMB</b> - Textured matte black <b>CF#</b> - Custom finish, specify RAL# (e.g. <b>CF1028</b> )	<b>TMW</b> <sup>14</sup> - Textured matte white <b>TMB</b> <sup>14</sup> - Textured matte black <b>CF#</b> <sup>14</sup> - Custom finish, specify RAL# (e.g. <b>CF1028</b> ) <b>NA</b> - None  <sup>14</sup> Applicable for <b>TRM</b> only.

<sup>13</sup>IP44 rated for bathrooms, showers, outdoor canopies and marquees when specified with lens options (**SDL**, **FDL**), trim option (**TRM**), and the same finish for both the baffle and trim.

## Photometrics

Please follow the multiplier tables to ensure correct lumen value. Beams, baffle color, lensing, CCT, CRI, baffle shape and accessories will change the lumen value.

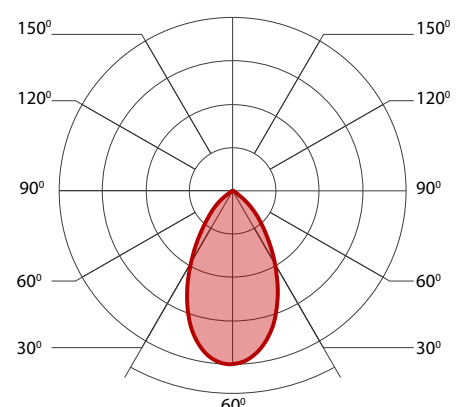
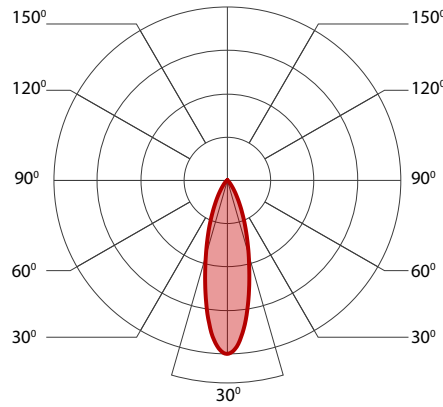
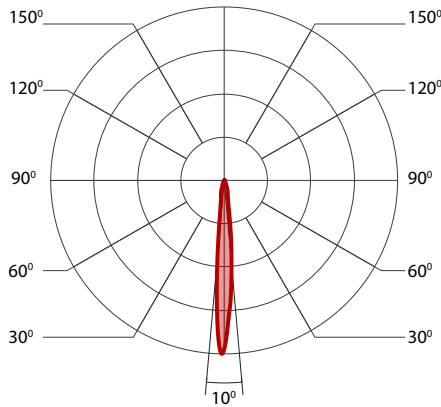

Delivered Lumens for Round White Standard Baffles - At 35K

CRI	80 CRI								90 CRI							
	10	20	30	40	50	60	75	90	10	20	30	40	50	60	75	90
Low - 13.8 W	1348	1294	1501	1532	1475	1455	1424	1394	1257	1203	1410	1424	1379	1363	1333	1302
Medium - 19.7 W	1692	1623	2037	2078	1995	1975	1933	1892	1576	1508	1912	1933	1871	1849	1808	1766
High - 28 W	2072	1988	2744	2800	2688	2660	2604	2548	1932	1848	2576	2604	2520	2492	2436	2380

Delivered Lumens - At 30K

97 CRI							
10	20	30	40	50	60	75	90
1080	1053	1213	1225	1186	1172	1146	1120
1355	1297	1644	1663	1609	1590	1555	1519
1820	1736	2212	2122	2156	2128	2100	2044

Efficacy Based on Delivered Lumens - High 28 W

BEAM	LPW							
	10	20	30	40	50	60	75	90
80 CRI	74	71	98	100	96	95	93	91
90 CRI	69	66	92	93	90	89	87	85
97 CRI	65	62	79	79	77	76	75	73

SOLA and DUO Max Wattage

BEAM	90 CRI							
	10	20	30	40	50	60	75	90
DUO	NA	10	NA	19	19	19	19	19
SOLA	NA	13	NA	26	26	26	26	26

Multiplier - CCT

CCT	
2700K	0.9
3000K	0.95
3500K	1
4000K	1.05

Multiplier - Baffle Color and Shape

BAFFLE VARIABLES		
White	Round standard	1
White	Square standard	0.89
Black	Round standard	0.95
Black	Square standard	0.87

Multiplier - Optical Options

LENS AND LOUVERS	
No lens	1
Soft diffused lens	0.94
Frosted lens	0.78
Hex louvers	0.82

For SOLA and DUO, please consult factory.

## Technical Specification

**DESCRIPTION** Compact fixed or adjustable 4" downlight with multiple outputs, color, beam, and dimming options.

**HOUSING CONSTRUCTION** For new construction, 20 gauge powder coated steel. Open frame, type-IC, or Chicago Plenum (CCEA) rated. 18 gauge galvanized steel junction box with ½" trade size knockouts. Adjustable hanger bars and butterfly brackets are included. Hat channel and flush mounted brackets are also available.

**Clearance Height:** Open frame/Type-IC/Chicago Plenum: 4";  
Open frame with DEB or PSQO (DUO) options: 8"

**Ceiling Thickness:** Can accommodate ½" to 1"

**Housing weight:** Type-IC/Chicago Plenum - 8 lbs -3.6 kg

**Open Frame** - 6 lbs -2.7 kg

**Ceiling cut out:** Ø5 ½" for round, 4 2 ½"x4 2 ½" for square

### FIELD REPLACEABLE LIGHT ELEMENT

**Adjustability:** Hot aiming, lockable, 360° rotation and 30° vertical tilt with shift to ensure beam stays centered.

**LED Module:** Integral COB module. 90 CRI and 2 SDCM, Standard with options of 80 CRI, or 97 CRI. L80 > 60,000 hours

**Light Output:** From 1294-2800 lumens

**HyFlex™ Optics:** Proprietary TIR/reflector with field interchangeable beam smoothing lenses.

**Optical Accessories:** Linear spread lens and hex cell louver can accommodate up to two in the light element.

**Thermal Management:** Cold-forged aluminum heat sink to maximize thermal dissipation.

### BAFFLE

Round and square, die-cast aluminum retained with rare earth magnets. **Trim style options:** Round and square with flanged trim, trimless with mudplate for drywall, or trimless for millwork.

**CHROMAWERX** SOLA (dim-to-warm) and DUO (tunable white). See page 6 for more information.

### ELECTRICAL

**Integral:** 0-10V, ELV, TRIAC, Lutron EcoSystem, Lutron Hi-lume, DALI, eldoLED 0.1%, eldoLED 1%, Lutron T-Series (tunable white).

**Remote:** 0-10V, ELV, TRIAC, Lutron EcoSystem, Lutron Hi-lume, DALI, eldoLED 0.1%, eldoLED 1%, DMX, Lutron T-Series (tunable white).

**Emergency Options:** Emergency battery back-up options are available as integral (Fulham), or remote (Fulham, Bodine, or IOTA). The battery provides 10W of power.

**ENVIRONMENT** Ambient temperature at fixture location shall be within 0°C/32°F - 25°C/77°F, indoor dry or damp as well as outdoor damp use (canopies or marquees).

**LISTING** cETLus listed to UL 1598 and CAN/CSA Standard C22.2 No. 250.0. IP44 rated for bathrooms, showers, outdoor canopies, and marquees when specified with lens options (SDL, FDL), trim option (TRM), and the same finish for both the baffle and trim.

**WARRANTY** 5 year limited warranty on LED module and power supply. Guaranteed to maintain 70% lumen maintenance.

## Installation Types

### Open Frame

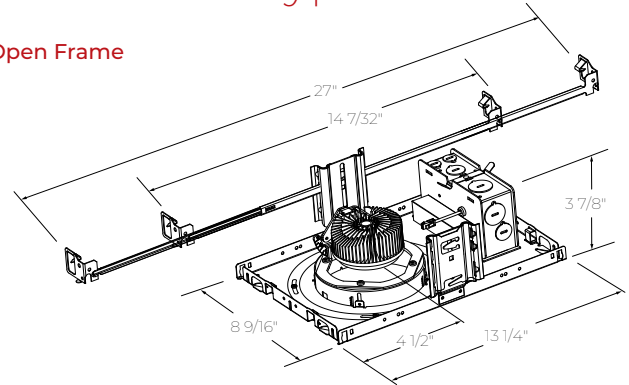

### Type-IC / Chicago Plenum

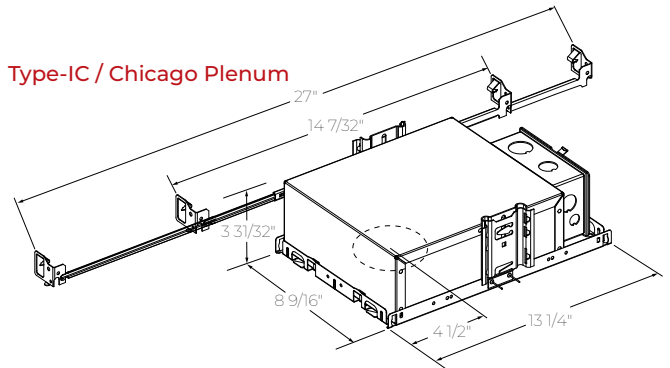

### Mounting Options

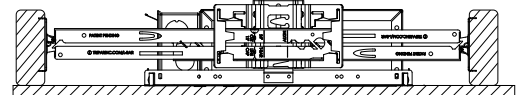

### ACB - Adjustable Commercial Bar Hangers

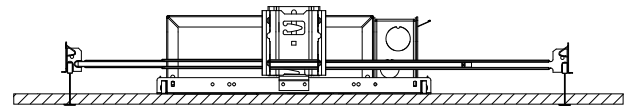

### ASB - Adjustable Standard Bar Hangers

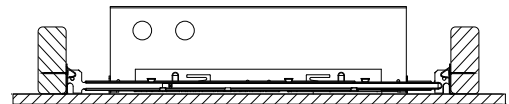

### FMB - Flush Mount Bars

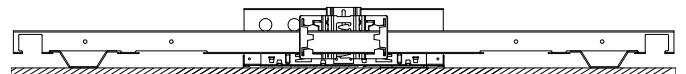

### AHC - Adjustable Hat Channel Bars

# Voilà

4" Round Downlight  
Fixed/Adjustable

# LUMENWERX

Project: \_\_\_\_\_

Type: \_\_\_\_\_

## Light

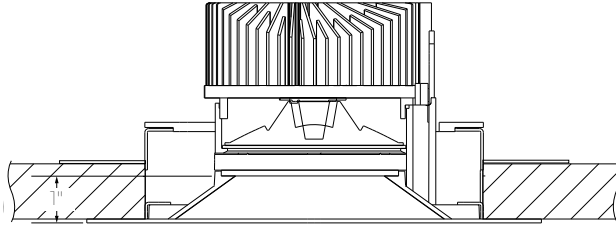

Standard Baffle

### Adjustment Mechanism

Flexible trim Collar

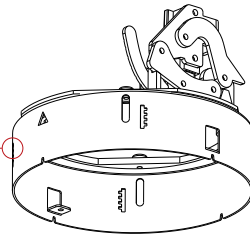

### Light Element

Heat Sink  
LED Module  
Hyflex™ Optics

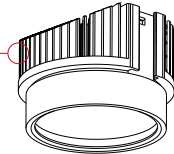

### Optical Accessories (Optional)

Linear Spread  
Hex Louver

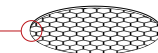

### Retaining Ring

Magnetic Snap

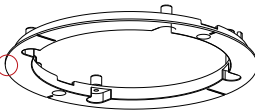

### Baffle & Lens

Standard Regress  
Soft Diffused  
Frosted Diffused

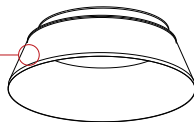

### Trim

Trim and Trimless



## Optics

Hyflex™ optics provide precise optical control in a remarkably compact form. The core of this four-tier system is a compound reflector with a central TIR element, just 1.06" deep. Beam smoothing discs perfect beam angles up to 90°. Beam angles are easily interchanged in the field.

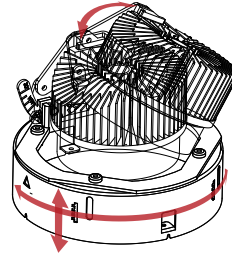

## Adjustability

Adjustable Light Element rotates 360° and tilts up to 30°. Screw thread mechanism provides easy tilt adjustment, fixes the aiming angle, and is accessed by removing aperture trim (see below). Supporting collar allows ceilings from 1/2" to 1" thick.

## Light Source - LED

Compact COB (Chip-On-Board) LED module, available in 2700K, 3000K, 3500K and 4000K with a choice of 80 CRI or 90 CRI with elevated R9 value (for 97 CRI, consult factory). Color consistency is maintained to within 2 SDCM. All LEDs have been tested in accordance with IESNA LM-80-08 and the results have shown L80 lumen maintenance greater than 60,000 hours. Absolute product photometry is measured and presented in accordance with IESNA LM-79, unless otherwise indicated.

## Beam Angles

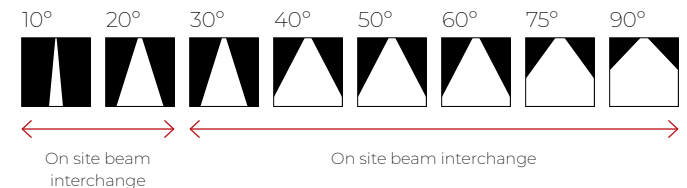

## Options



Linear Spread



Hex Louver

# Voilà

4" Round Downlight  
Fixed/Adjustable

# LUMENWERX

Project: \_\_\_\_\_

Type: \_\_\_\_\_

## Integral Driver

Unless otherwise specified, Voilà comes standard with an integral, 120-277VAC/60Hz, electronic, 1% 0-10V dimming, constant-current LED driver. The driver is field replaceable and features a high power factor, low THD and sources 1 mA on the 0-10V dim line. All integral drivers are located inside the housing and are easily accessible from below the ceiling through the aperture. All dimming drivers comply with IEEE C62.41 surge protection requirements.

## Emergency Integral

Factory installed, long-life, high-temperature, LED driver with integrated emergency backup using a recyclable LiFePO4 battery pack. Features a remote test switch with charge indicator, minimum of 90 minutes operation and 10W per downlight emergency lighting output. Recharge time of 12 hours.

## Emergency Remote

Long-life, high-temperature, emergency LED driver with Lithium Ion battery pack. Features a test switch with charge indicator, minimum of 90 minutes operation and 10W per downlight emergency lighting output. Recharge time of 24 hours.

## Trim Dimensions

### Trimless

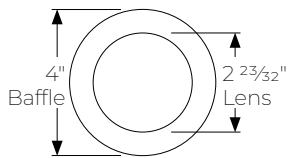

### Trim

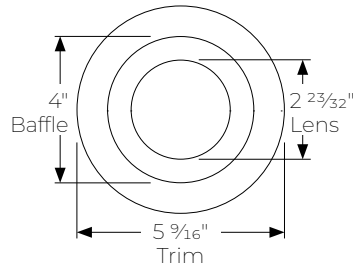

## Baffle



Standard Regress

### Trimless

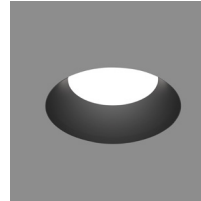

Black Baffle

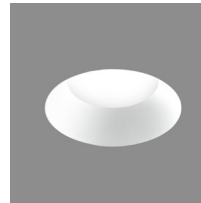

White Baffle

### Trim

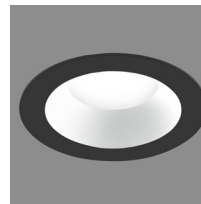

White Baffle,  
Black Trim

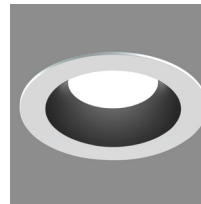

Black Baffle,  
White Trim

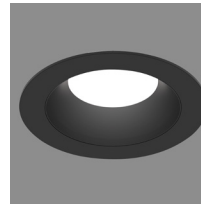

Black Baffle,  
Black Trim



White Baffle,  
White Trim



Chromawerx Sola is single-channel control that dims output while warming the color temperature in a pre-determined relationship. A simple analog control adjusts a specially populated LED array to emulate the effect of dimming a filament source.



Chromawerx Duo offers a two-channel control system which uses analog or digital protocols for synchronous control of both warm (2700K) to cool (6500K) LED arrays - maintaining a CRI above 90. The range of color DUO offers is useful for entraining circadian rhythms, stimulating alertness, and compensating for jet lag among other applications. The Chromawerx drivers are programmed to limit maximum light output and power usage across all color temperatures.

**DUO** GENERIC DMX NETWORK ARCHITECTURE

A qualified DMX integrator is required to assure proper installation and commissioning of the DMX network. **When placing the PO, please provide the contact information of your DMX integrator.**

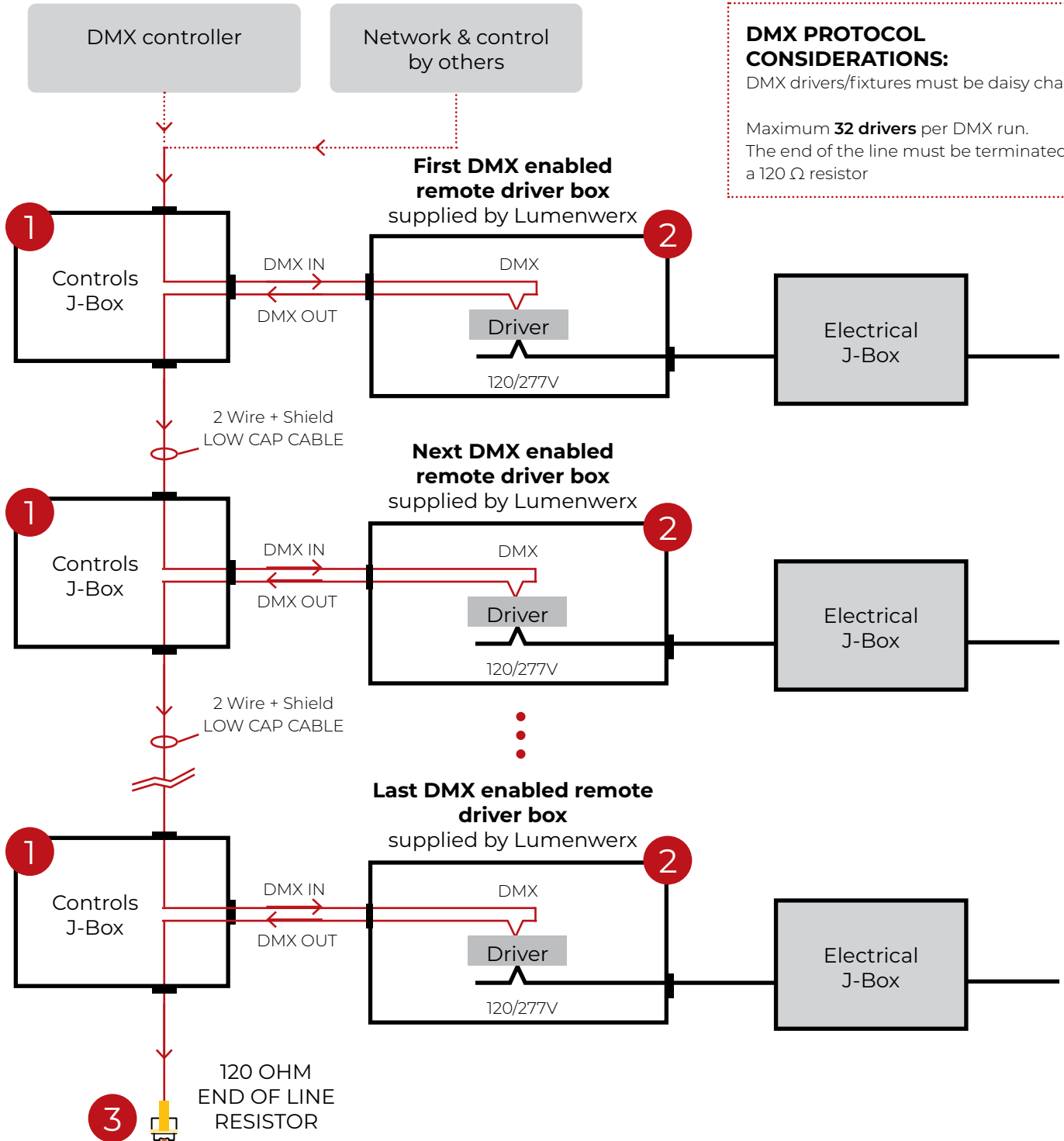

**DMX PROTOCOL CONSIDERATIONS:**  
DMX drivers/fixtures must be daisy chained.  
  
Maximum **32 drivers** per DMX run.  
The end of the line must be terminated by a 120 Ω resistor

## 1 J-BOX DMX DAISY CHAIN DETAIL

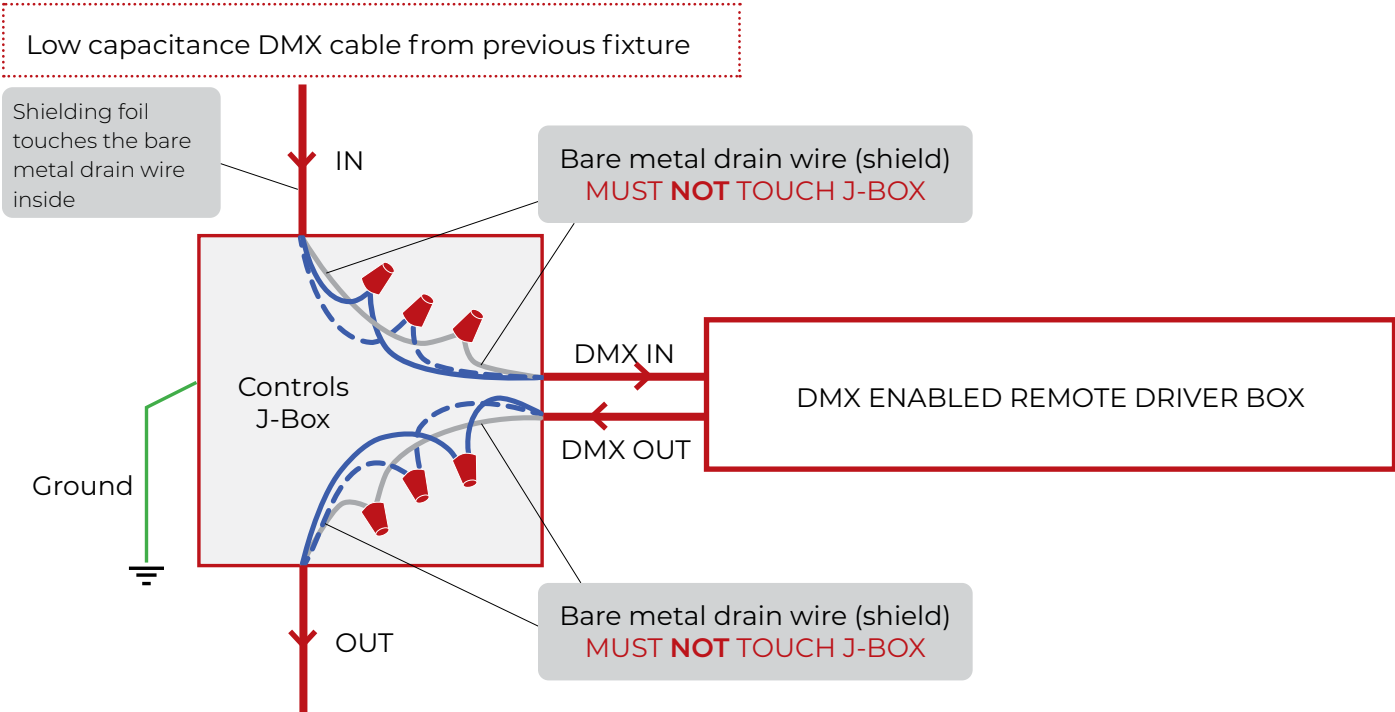

Low capacitance DMX cable to next fixture

## 2 DMX CONNECTION REMOTE DRIVER

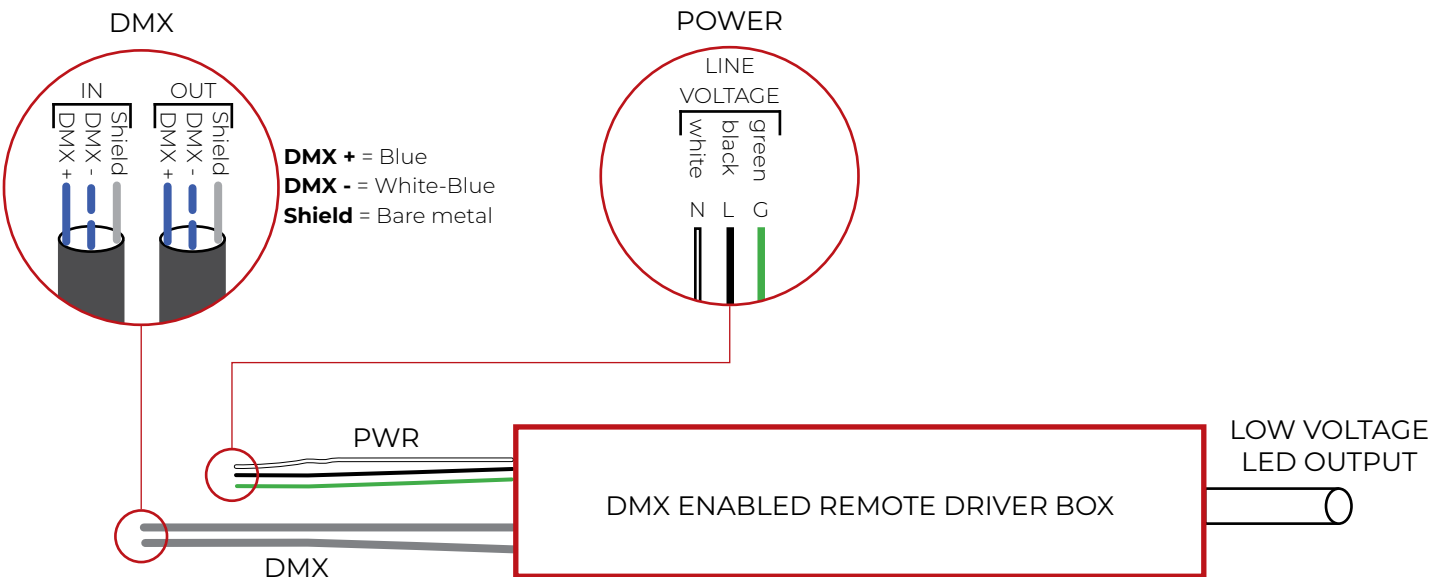



### 3 LAST DMX CONNECTION DETAIL

