

# CONTAX **TN1**



**Instruction manual • Bedienungsanleitung**

**E/G**

***We greatly appreciate your purchase of this Contax N1 camera. The Contax N1 is an autofocus single lens reflex camera based on the Contax' fundamental principle of "building cameras for creating works of art". Automatic or manual focus can be selected according to the subject and setting so that the user can achieve the desired results with accuracy.***

The Contax N1 is equipped with many features that will maximize creative photographic possibilities. Read these instructions carefully before using the camera to ensure proper use and a long service life. Some of the notable features include:

- ① A 5-frame autofocus detection site pattern that is spread wider throughout the viewfinder. The user can select a single site or have the sites detect focus automatically.
- ② A high speed shutter with an automatic shutter speed range of 32 seconds to 1/8000 second, with flash sync at 1/250 second.
- ③ Focus Auto-Bracket Control, for automatic shifting of the focusing distance during a sequence of exposures.
- ④ Use of high-performance Carl Zeiss T\* lenses and various accessories for expanding the range of photographic possibilities.

## <Attaching the strap>

**1** Attach the protector to the suspension ring.

**2** Attach the triangular ring to the suspension ring.

**3** Pass the strap through the protector and triangular ring and attach it as shown on the diagram.

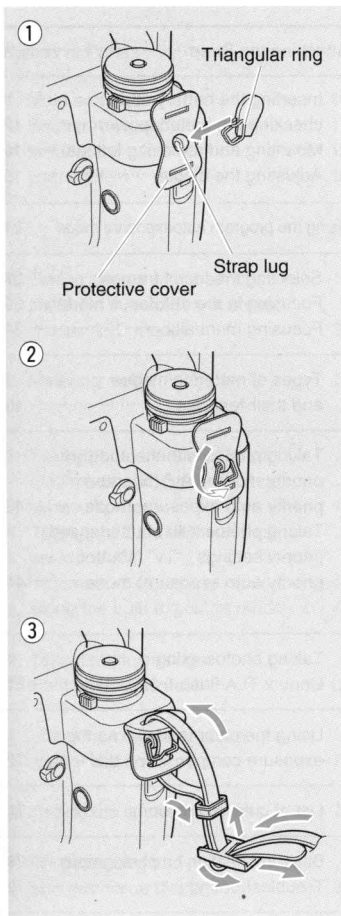

# CONTENTS

	Attaching the Strap ..... 3
<b>BASIC OPERATIONS PRIOR TO SHOOTING</b>	1. Inserting the battery and checking the battery power ..... 12 2. Mounting and removing lenses ..... 14 3. Adjusting the diopter ..... 15
<b>SIMPLE SHOOTING PROCEDURE</b>	Using the program autoexposure mode .... 24
<b>FOCUSING</b>	1. Selecting the focus frames ..... 27 2. Focusing in the autofocus mode .... 29 3. Focusing manually ..... 34
<b>SELECTING THE METERING MODE</b>	1. Types of metering modes and their features ..... 40
<b>APPLIED PHOTOGRAPHIC TECHNIQUES</b>	1. Taking photos with the aperture priority mode "Av" (aperture priority auto exposure) mode ..... 43 2. Taking photos with shutter speed priority settings "Tv" (shutter priority auto exposure) mode ..... 44
<b>FLASH PHOTOGRAPHY</b>	1. Taking photos using a Contax TLA flash ..... 61
<b>APPLIED COMMAND DIAL OPERATIONS</b>	1. Using the command dial as the exposure compensation dial ..... 72
<b>CUSTOM FUNCTIONS</b>	1. List of custom functions ..... 74
<b>REFERENCE</b>	1. Basic information on photography ..... 78 2. Troubleshooting ..... 79
<b>MAIN ACCESSORIES</b>	1. LCD viewfinder FE-1 ..... 85 2. Contax Data back D-10 ..... 86 3. Contax Power pack P-8 ..... 89

Names of Parts ..... 6	Display Panel and Viewfinder Display .... 8
4. Main switch ..... 16	8. Removing film ..... 21
5. Shutter release button ..... 17	9. Setting the film speed manually .... 22
6. Holding the camera ..... 17	10. Switching the drive mode ..... 23
7. Loading film ..... 18	
4. Taking photos with the focus shifted in three different steps (Focus ABC mode)..... 36	
2. Metering range ..... 41	
3. Taking photos in the program auto mode "P" (program auto exposure) mode ..... 45	6. Taking photos with exposure compensation ..... 48
4. Taking photos with the exposure set manually "M" (manual exposure) mode ..... 46	7. Taking Multiple exposure ..... 55
5. Using the bulb exposure mode ..... 47	8. Using the self timer ..... 57
	9. Checking the depth of field ..... 58
	10. Cable switch socket ..... 59
	11. Replacing the camera back ..... 59
2. Taking photos using a Contax TLA360 flash ..... 66	3. Taking photos using other flashes with the X contact ..... 70
2. Using the command dial as the shutter dial ..... 72	
2. Setting the custom functions ..... 76	
3. Shutter speed and aperture value display ..... 81	4. Camera Care and Precautions ..... 82
4. Contax Cable switch LA type ..... 91	7. Contax Flexible case C-8 ..... 96
5. Contax Mount adapter NAM-1 ..... 92	Main Specifications ..... 97
6. Focusing screens FX type ..... 93	



This manual is for reference and historical purposes, all rights reserved.

**This page is copyright© by M. Butkus, NJ.**

This page may not be sold or distributed without the expressed permission of the producer  
I have no connection with any camera company

On-line camera manual library

This is the full text and images from the manual. This may take 3 full minutes for the PDF file to download.

**If you find this manual useful, how about a donation of \$3 to: M. Butkus, 29 Lake Ave., High Bridge, NJ 08829-1701 and send your e-mail address so I can thank you. Most other places would charge you \$7.50 for a electronic copy or \$18.00 for a hard to read Xerox copy.**

**This will allow me to continue to buy new manuals and pay their shipping costs.**

**It'll make you feel better, won't it?**

**If you use Pay Pal or wish to use your credit card,  
click on the secure site on my main page.**

PayPal Name Lynn@butkus.org

Venmo @mike-butkus-camera Ph. 2083

[www.PayPal.me/lynnbutkus](http://www.PayPal.me/lynnbutkus)

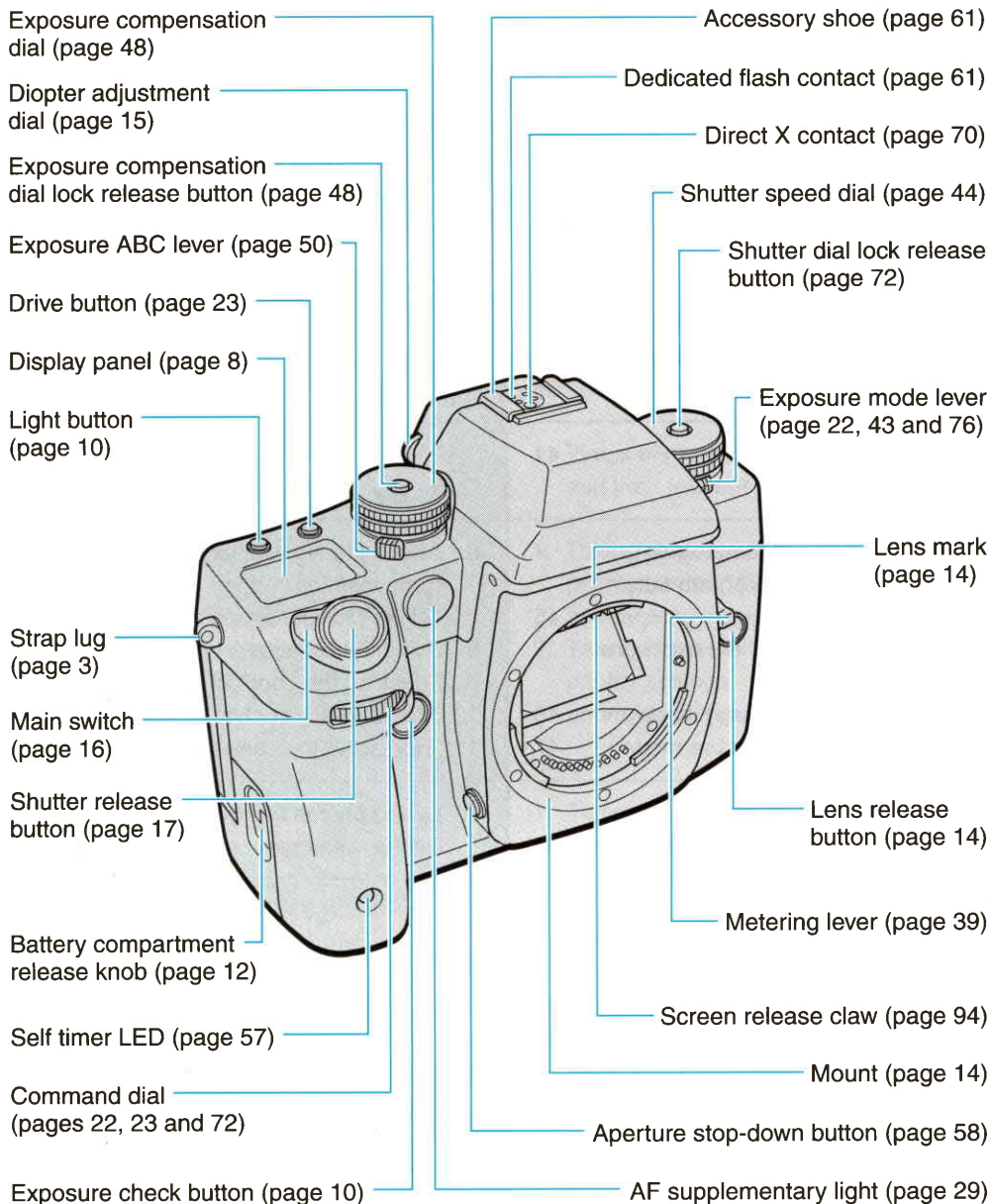

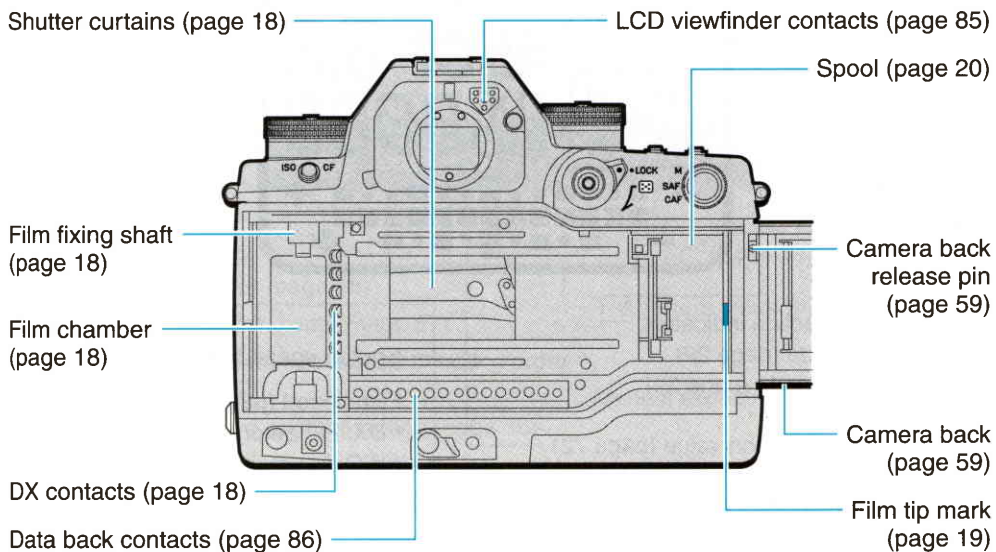
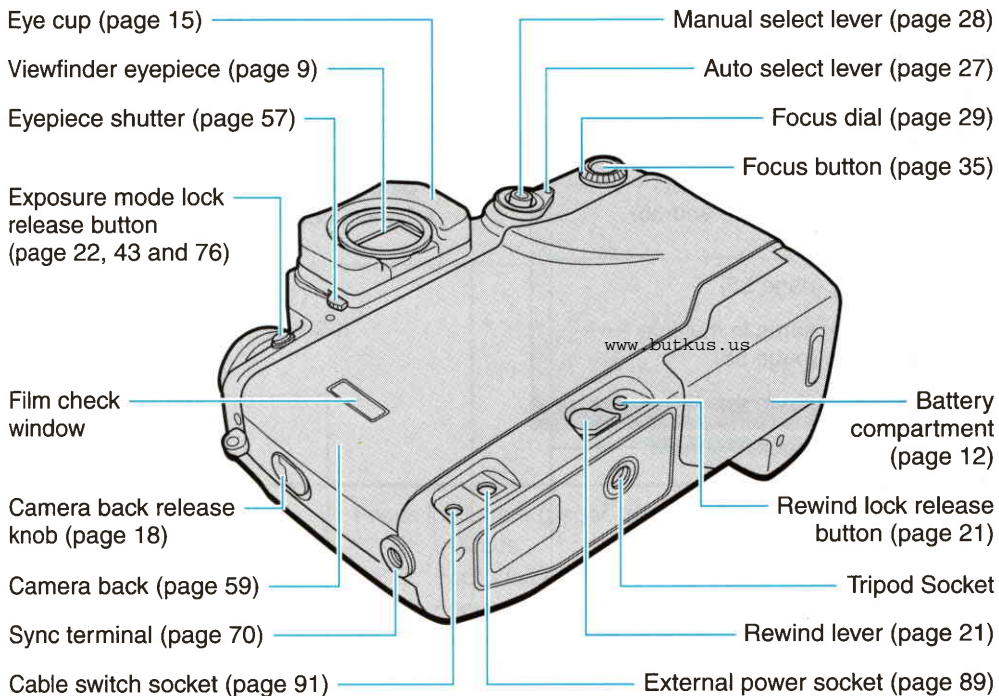

## <Display panel>

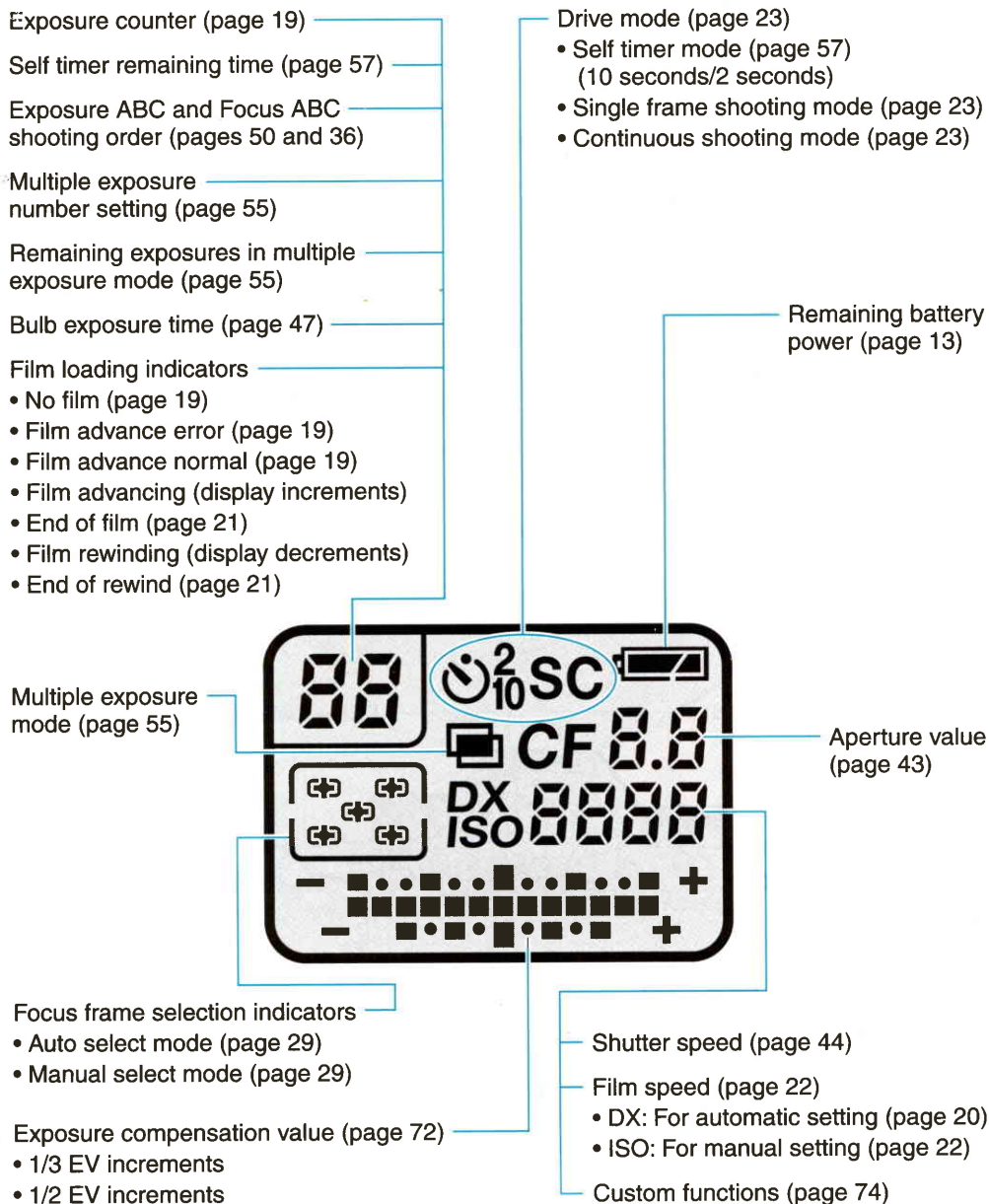

## <Viewfinder display>

Spot metering range  
(Area approx. 3 mm in diameter at center of viewfinder) (page 40)

Focus frame (page 27)

- Auto select mode (page 27)
- Manual select mode (page 28)

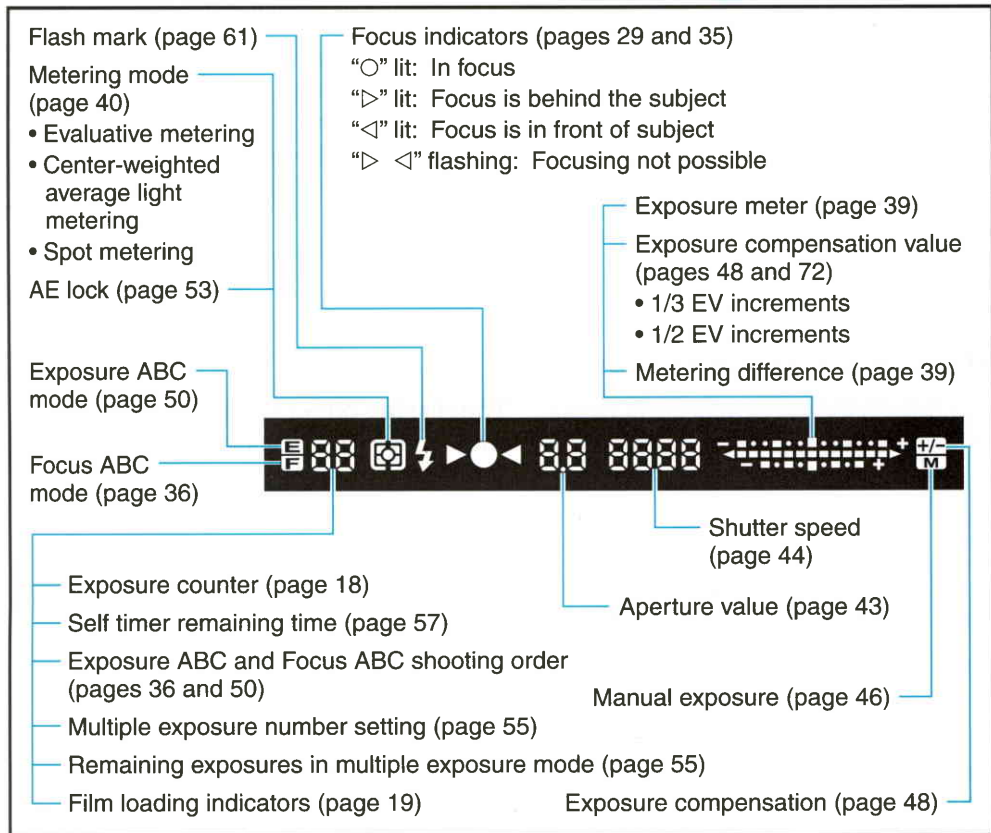
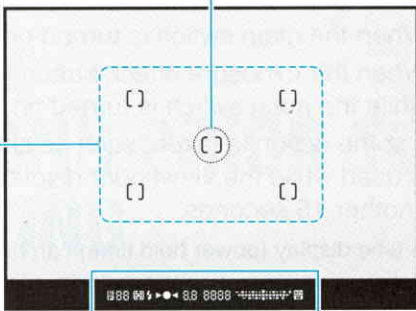

The Contax N1's viewfinder serves as the main information source for focus, exposure and film status.

The viewfinder display turns on when the operations below are performed, then automatically turns off after 16 seconds to save power.

- ① When the main switch is turned on.
- ② When the exposure check button is pressed or shutter button is half-pressed while the main switch is turned on.

If some action is taken, such as changing aperture, shutter speed or any dial is used while the viewfinder display is lit, the display time is extended another 16 seconds.

- The time display (power hold time) can be changed. (Page 74)

#### The viewfinder display turns off in the following cases:

- During shooting.
- When the end of the film is reached.
- While the film is rewinding.
- When rewinding is completed.
- In the all imprint mode.
- When there is a film advance error.
- When the battery is spent.
- When the exposure mode lever is set to ISO or CF.

#### <Display panel illumination>

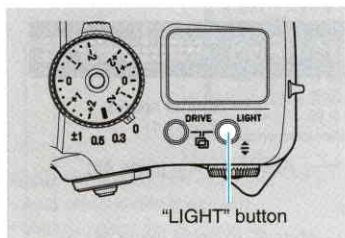

The display panel can be illuminated when viewing conditions require. The light turns on and off each time the "LIGHT" button is pressed.

- If other dials or buttons are operated while the display panel is lit, the duration of illumination is automatically extended. The display panel light turns off as soon as the shutter is released.

# **BASIC OPERATIONS PRIOR TO SHOOTING**

This section describes procedures that should be taken prior to photographing and includes basic operations of this camera.

If you already have basic knowledge on handling a camera and wish to start taking photographs immediately, proceed to "SIMPLE SHOOTING PROCEDURE" on page 24.

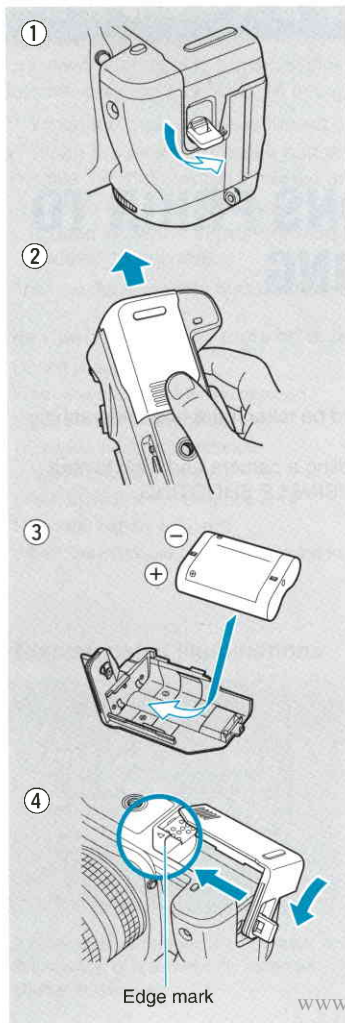

## <Inserting the battery>

Turn the main switch off before inserting the battery.

**1** Lift the battery compartment release knob and turn it in the direction of the arrow until it stops.

**2** Press on the center, slide in the direction of the arrow to remove the battery compartment.



**3** Insert a 6V lithium battery (2CR5) into the battery compartment. Ensure that the battery contacts and those in the battery compartment match.

**4** Line up the edge of the battery compartment with the edge mark on the camera's body, then slide in the direction of the arrow to attach.

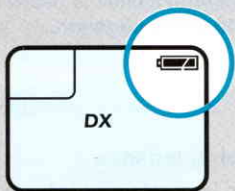
5





## 5 Turn the battery compartment release knob clockwise to fasten.

- Lower the release knob into its original position.
- The “” battery mark appears in the display panel.
- Even when using a new battery, during continuous shooting or at low temperatures the voltage may decrease momentarily and the “” mark may light. If this happens, turn the main switch off then back on 2 or 3 times. If the “” mark lights, there is enough battery power.

### <Checking the battery power>

The “” marks mean the following:

Check the battery power with the main switch turned on.

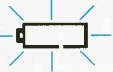
Display when main switch is on	Meaning
	There is sufficient battery power.
	Battery power is low and will need replacement soon.
 (flashing)	Replace with a new battery.
 (flashing)	Camera will not operate.

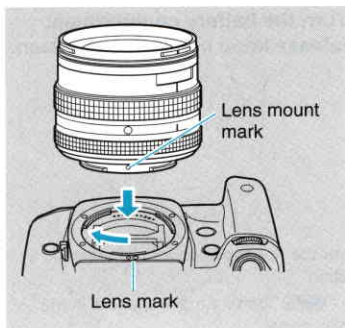

### <Mounting lenses>

**1** Remove the camera's body cap and the lens rear cap.

**2** Line up the mount mark on the lens with the lens mark on the camera, insert the lens, then turn it clockwise until a click is heard and the lens is firmly engaged.

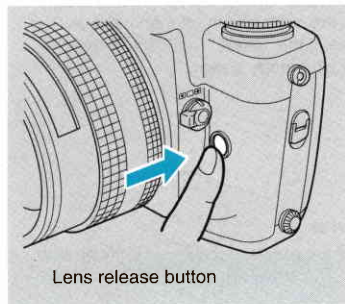

### <Removing lenses>

Press the lens release button and turn the lens counterclockwise all the way until it stops, then pull it forward to remove it.

- Be careful not to touch the lens surface or the inside of the body when mounting and removing lenses.
- When replacing the lens while film is loaded in the camera, do so in the shade, avoiding direct sunlight.

### 3. Adjusting the diopter

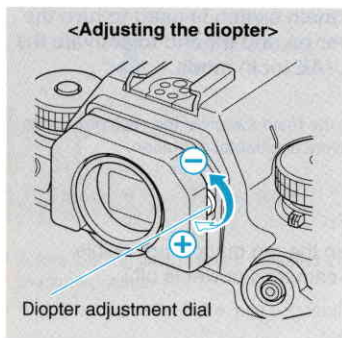

This camera is equipped with a built-in diopter correction mechanism. Turn the diopter adjustment dial and adjust for your vision.

The adjustment range is  $-3D$  to  $+1D$  (Diopter).

- If the diopter cannot be sufficiently adjusted using the camera's diopter correction mechanism, use a separately sold FM type diopter lens.

The diopter adjustment range is as follows:

Diopter lens	Adjustment range
Built in	$-3D$ to $+1D$
FM $-3$	$-6D$ to $-2D$
FM $+2$	$-1D$ to $+3D$

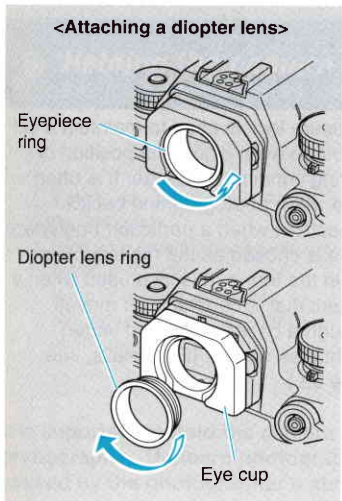

#### <Attaching a diopter lens>

Remove the camera's eyepiece ring and screw in the diopter lens.

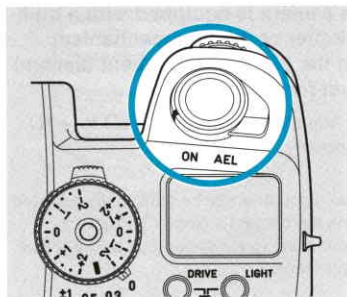

<When off>

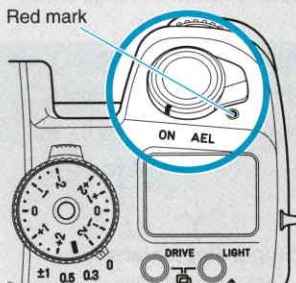

<When on>

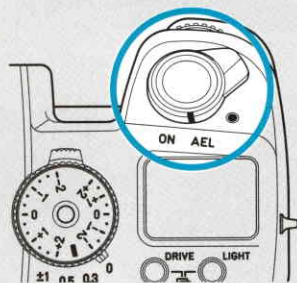

<When in the AEL (AE lock) mode>

The main switch is used to turn the power on and off and to activate the AEL (AE lock) mode.

- Set the main switch at the click position to prevent accidental operation.

### OFF:

When the red mark is not visible  
The camera's power is off.

### ON:

The camera's power is on.

### AEL:

Use this when you want to lock the exposure (AE lock). Automatic exposure lock is used to maintain a set exposure even when composition or lighting conditions change. It is often used when photographing backlit subjects or when a particular brightness value is chosen as the main subject within the frame. It is also used when a subject that is constantly lit moves through a background with varied brightness values. (For details, see page 53.)

## 5. Shutter release button

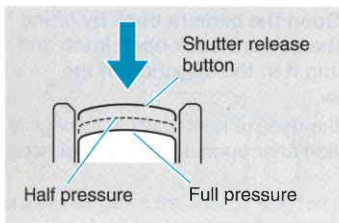

The shutter release button operates in two steps.

When the shutter button is half-pressed, the viewfinder display turns on and the autofocus and metering functions are activated. When pressed further (full pressure), the shutter is released and the photo is taken.

- Before loading film, practice pressing the shutter release button to get used to the half-pressure position.
- To prevent camera shake, use a smooth motion when pressing the shutter release button.

## 6. Holding the camera

- ① Tuck in your elbows and stabilize the camera.
- ② Hold your breath when pressing the shutter button.
- ③ Keep your arms and hands relaxed and press the shutter button gently.

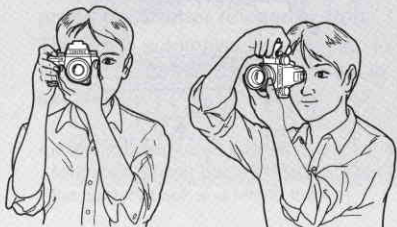

**It is important to hold the camera firmly in order to achieve sharp photographs. Unsharp photographs are often due to camera shake caused by the photographer's abrupt motion when taking a picture.**

Practice working with the camera and making both vertical and horizontal compositions. Find positions that are comfortable for you. Propping yourself or the camera against a building or tree can often be effective.

- When taking photographs in dark places or in other cases where the shutter speed is slow, use a tripod to avoid camera shake.

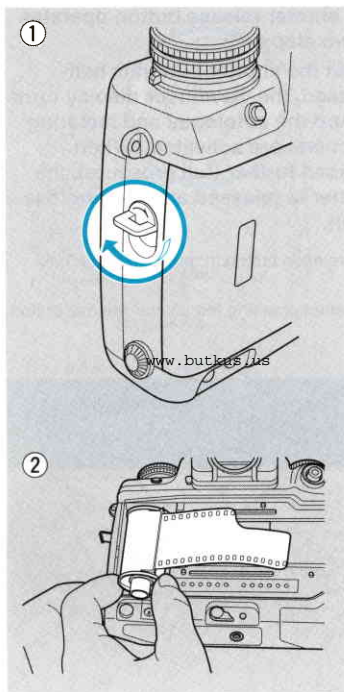

**1** Open the camera back by lifting the camera back open knob and turning it in the direction of the arrow.

Set the release knob back in its original position after opening the camera back.

- The first time you use the camera be sure to remove the protective sheet inside the camera before loading film.
- Be careful not to touch the DX and data back contacts. If they become dirty clean them off with a soft cloth.
- Load and remove film out of direct sunlight.

**2** Insert the film at an angle as shown on the diagram.

### Shutter curtain

The shutter curtain is a precision part. Be extremely careful not to touch it or poke it with the tip of the film or your finger. In particular, never press the shutter release button when the tip of the film is positioned over the shutter curtain.

3

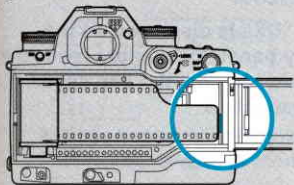

**3** Pulling on the tip of the film, draw out the film to the position of the orange “I” mark, then set it over the spool.

Make sure the film is flush (not bulging out), as shown in the diagram.



- If the drawn out section of the film is too long, do not try to continue loading the film. Wind it back up into the film cartridge to adjust the length.

4

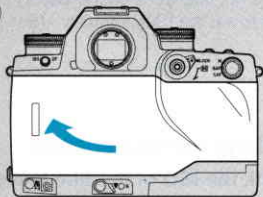

**4** Securely close the camera back, turn the main switch on and press the shutter release button.

The film is automatically advanced to the first frame and the film counter is set to “01”.

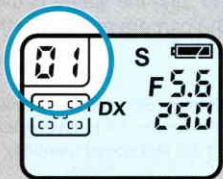

- If “00” still flashes on the film counter, the film has not been properly loaded. Open the camera back and reload the film.

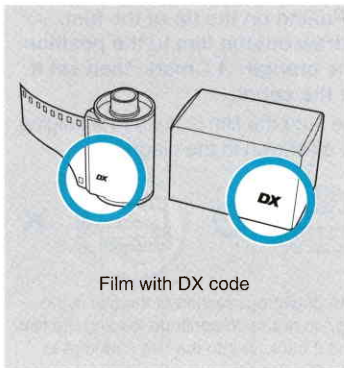

### <Automatic setting of the ISO film speed>

When “DX” is displayed on the display panel, the camera reads the DX code and sets the film speed automatically.

The automatic film speed settings range from ISO 25 to 5000.

- When film with no DX code is loaded, the film speed is automatically set to ISO 100.
- If “DX” is not displayed on the display panel, be sure to set the ISO manually. (See page 22.)

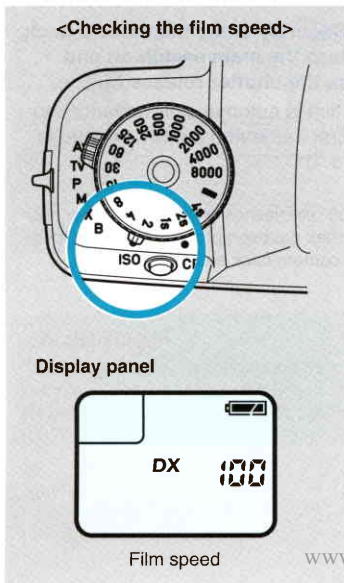

### <Checking the film speed>

To check the ISO of the film loaded in the camera, set the exposure mode lever to “ISO”.

“DX” or “ISO” and the speed of the film loaded in the camera appear on the display panel.

- To set a different ISO from that indicated for the film (for example, for push processing), see “Setting the film speed manually” on page 22.

## 8. Removing film

Once the film has been fully exposed, film advance stops and the first and second digits of the film counter flash alternately.

**1** With the main switch on, turn the rewind lever in the direction of the arrow while pressing the rewind lock release button.

The numbers on the film counter decrease while the film is rewinding. Once the film is completely rewound, the motor stops and "00" flashes on the film counter.

**2** Check that the motor has stopped and that "00" is flashing on the film counter, then open the camera back and remove the film.

- Remove the film in a place out of direct sunlight.
- If the end of the film is left out of the film cassette at film rewinding, set the custom function on page 74.
- Be sure to remove the film after rewinding it. After the film has been rewound, the camera will not operate until the camera back has been opened.
- After removing the film, have it developed as soon as possible.
- Note that if more photographs than the regular number of frames on the film have been taken, the last frame may be cut during the developing process.
- For midroll rewind, follow steps 1 and 2 described above.

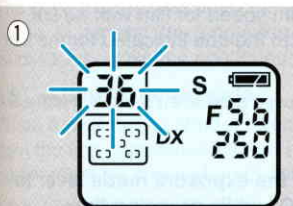

First and second digits flash alternately

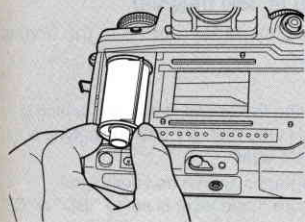
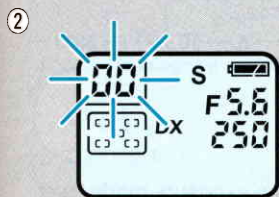
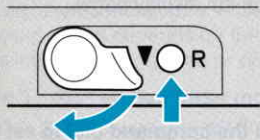

Use the procedure described below to set the film speed for film with no DX code or when you want to set a different ISO from the one indicated for the film.

- The manual ISO setting range is ISO 6 to 6400.
- If you set the film speed manually this setting will be used even when using film with a DX code.

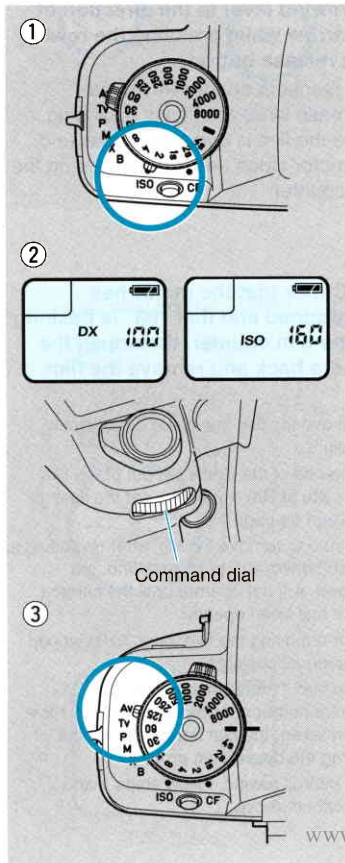

**1** Set the exposure mode lever to “ISO” while pressing the exposure mode lock release button. “DX” or “ISO” and the film speed appear on the display panel.

**2** Turn the command dial to set the film setting to “DX” or the desired value.

DX ↔ 6 ↔ 8 ↔ 10 ↔ • ↔ 5000 ↔ 6400 ↔ DX ↔ 6 (repeated)

**3** Set the exposure mode lever back to the exposure mode. The setting is now finished.

The display panel returns to the normal display.

- Once the film speed is set, this setting is stored in the memory until the setting is changed again.
- Photographs cannot be taken if the exposure mode lever is set to “ISO” or “CF”.

## 10. Switching the drive mode

The drive modes described below can be selected according to the subject and scene. In general, the single frame mode is for still subjects such as portraits or landscapes, while the continuous mode is best for moving subjects.

### “S” — Single frame mode

When the camera's shutter release button is pressed, a single frame is taken, then the film is advanced to the next frame and stops. The shutter release button must be pressed again for another exposure.

### “C” — Continuous shooting mode

When pressure is maintained on the shutter release button frames are exposed and film is advanced continuously. A maximum of about 3.5 frames per second can be taken continuously while the shutter release button is pressed. (The shooting speed depends on the shutter speed, the film speed, whether data back imprint function is on or off and the condition of the battery.)

### “ $\odot_{10}$ ” “ $\odot^2$ ” — Self timer mode

Set this mode to use the self timer. For details, see page 57.

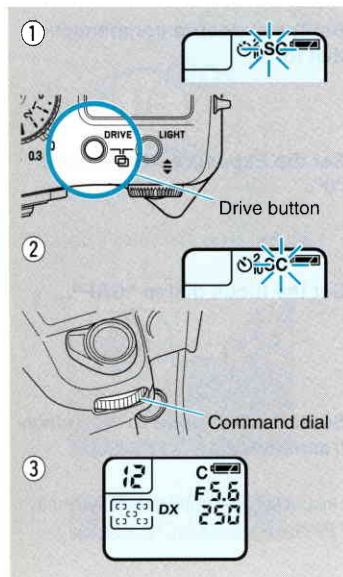

### 1 Press the drive button to set the drive mode.

All the drive modes appear on the display panel and the currently selected drive mode flashes.

### 2 Turn the command dial until the desired drive mode indicator is flashing.

The drive mode switches as follows when the command dial is turned.

“S” ↔ “C” ↔ “ $\odot^2$ ” ↔ “ $\odot_{10}$ ”

### 3 Press the drive button to set the selected drive mode. The display panel returns to the normal display.

# SIMPLE SHOOTING PROCEDURE

<Using the program autoexposure mode>

In the program auto mode, the camera automatically sets the combination of the shutter speed and aperture (the exposure value) according to the brightness of the subject. We recommend using this mode if you are using a camera for the first time or if you want to take photos without worrying about the aperture and shutter speed settings.

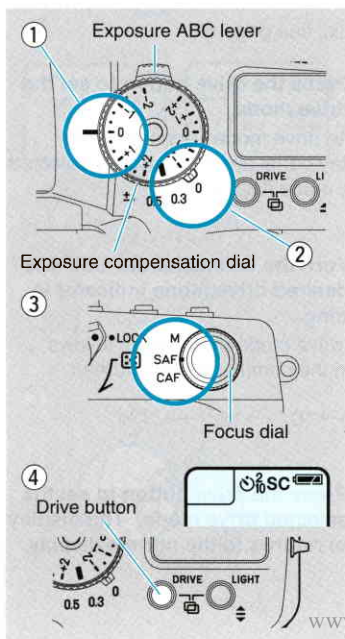

First turn the main switch on and set the various modes as described below.

**1** Set the exposure compensation dial to “0”.

**2** Set the Exposure ABC lever to “0”.

**3** Set the focus dial to “SAF”.

**4** Set the drive mode to “S” (single frame mode).

- For instructions on setting the drive mode, see page 23.

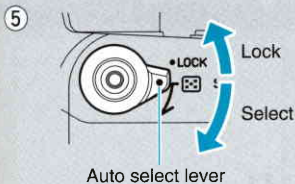

**5** Move the auto select lever several times in the direction of the arrow to set the focusing frame selection indicator to “”, then move the lever upwards to lock.

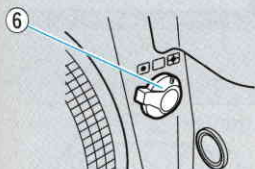

**6** Set the metering mode to evaluative metering (“”).

**7** Turn the exposure mode lever while pressing the exposure mode lock release button and set the exposure mode to “P”.

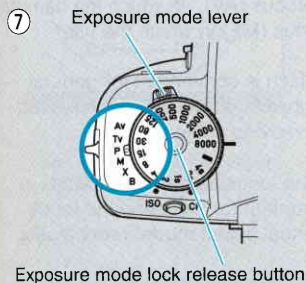

**8** Point the camera at the subject, position the subject within the focus frame in the viewfinder, then half-press the shutter button.  
(Use any one of the five focus frame.)

**9** Focusing is performed. When the subject is in focus, the focus frame used to focus flashes red once and “○” (focus mark) lights.



**10** With the shutter button still half-pressed, determine the composition, then press the shutter button all the way in to take the photo.

# FOCUSING

This camera offers two types of focusing: autofocus (AF), in which the camera adjusts the focus automatically, and manual focus (MF) in which the user adjusts the focus manually.

There are two AF modes: “SAF” (single AF) which is convenient for general photography when photographing stationary subjects, and “CAF” (continuous AF) which comes in handy for taking photos of moving subjects.

In addition, there are two modes for selecting the focusing frame or frames in the AF modes. The “auto select mode” is convenient for adjusting the focus within a certain range in general, while the “manual select mode” can be used for focusing accurately on a selected point.

This camera is also equipped with the functions described below. Use them according to the subject and scene.

- ① The camera’s “dual focus mechanism” allows you to switch to the manual focus mode by turning the lens’ focus ring when the focus is set in the SAF mode (page 30).
- ② “One shot auto focus” for focusing automatically while the focus button is pressed in the manual focus (MF) mode (page 35).

# 1. Selecting the focus frames

## Focus frames



## <Auto select mode>

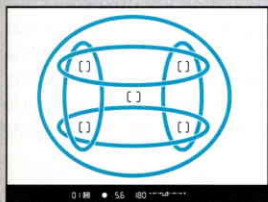

## <Switching Auto Select Mode>

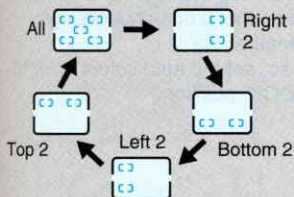

## Auto select lever

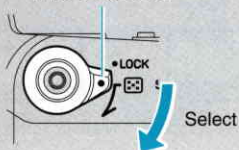

This camera has five focusing frames: the frame at the center of the picture and four peripheral frames positioned on diagonal lines. There are two modes for selecting the focusing frame or frames: the “**auto select mode**” in which the camera automatically selects the most appropriate focusing frame from among the different focusing frames according to the position of the subject, and the “**manual select mode**” in which a specific focusing frame can be designated.

There are two auto focusing frame select modes. In one mode the most appropriate frame is selected from among the five focus frames. In the other mode the focus frame is selected from two adjacent peripheral frames (top/bottom, left/left or right/right). When the operation for switching the auto select mode is performed, the selected focusing frames flash(es) red once.

## <Auto select mode>

The auto select mode switches as shown on the diagram each time the auto select lever is moved in the direction of the arrow.

- This cannot be set in the manual focus mode.

“” : This mode is suited for general photography. The camera automatically selects the most appropriate of the five focusing frames.

“” : This mode is suited for compositions containing subjects at equal distances at the edges of the picture. The camera selects the frame for which the shooting distance is shortest from among the two selected focusing frames.

### <Manual select mode>



Focus frame  
(Select one of the five.)

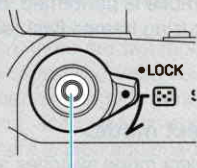

Manual select lever

### <Manual select mode>

Select the desired focusing frame using the manual select lever. Move the lever in the direction of the desired focusing frame to select one of the peripheral focusing frames, push it to select the center focusing frame. This mode is suited for cases in which you want to focus accurately on the selected frame.

### <Locking the selected focusing frame>

The selected focusing frame can be locked so that it does not change accidentally.

To do so, set the auto select lever to the “LOCK” position.

### <Locking the selected focusing frame>

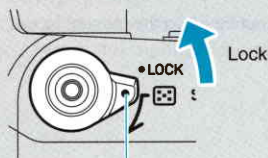

Auto select lever

### Display panel (example)

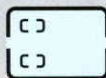

Auto select mode

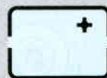

Manual select mode

## 2. Focusing in the autofocus mode

The auto focus mechanism is activated when the shutter button is half-pressed while the focus dial is at the "SAF" or "CAF" position. The focusing frame selected when the shutter button is half-pressed lights red momentarily. After the distance is measured, the frame for which the focus was adjusted lights red momentarily.

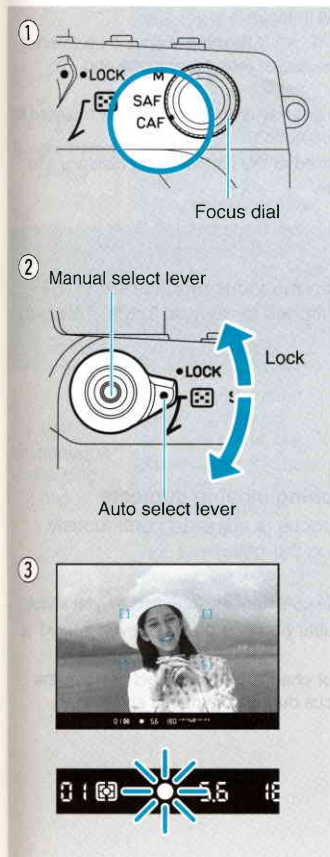

**1** Set the focus dial to "SAF" (single auto focus) or "CAF" (continuous autofocus).

**2** Select the focusing frame. Use the auto select lever or manual select lever to select the frame, then lock it.

**3** Frame the camera at the subject on which you want to focus, position the subject within the selected focusing frame, then half-press the shutter button.

The focus is adjusted automatically. When the subject is in focus, the focus mark ("O") lights in the viewfinder.

**4** Now press the shutter button all the way in to take the picture.

### AF supplementary light

If the subject is dark or its contrast is so low that it is difficult to focus, the camera automatically projects AF supplementary light on it to increase the precision of the autofocus unit.

The irradiation section at this time is the center of the picture.

The effective range of the AF supplementary light is approximately 5m.

### <“SAF” (single auto focus)>

**This mode is recommended for general photography (still life, portraits, landscapes, etc.).**

Half-press the shutter button to focus. Once the subject is in focus, the focus is locked at that position.

- The shutter cannot be released if the subject is not in focus.
- It is not possible to focus on the desired subject if “▷ ◁” is flashing. Focus on a different object at the same distance as the subject, lock the focus, then recompose and photograph the original subject. (Page 32)
- If “▷ ◁” is flashing but you want to take the photo anyway, the shutter can be released by pressing the shutter button while pressing the focus button.
- When the drive mode is set to “C”, the focus is locked at the first focusing distance and remains at that set distance for subsequent photos.

### <Dual focus mechanism>

If the lens' focus ring is turned by hand when the focus mode is set to “SAF” and the focus mark (“O”) is lit, the mode switches to manual focus. This is a way to fine tune focus.

### <“CAF” (continuous autofocus)>

**This mode is recommended for photographing moving subjects.**

When the shutter button is half-pressed, the focus is adjusted continuously. Check that the subject is in focus before taking the picture.

- In the “C” (continuous shooting) mode, the focus is continuously adjusted as you shoot.
- In this mode, the shutter is released when the shutter button is pressed, even if “▷ ◁” is flashing.
- In some instances, depending on the movement or change in the subject position, the camera may not be able to keep the subject in focus during continuous shooting.

## <Relationship between the focus mode and drive mode>

Focus mode Drive mode	"SAF" (single auto focus)	"CAF" (continuous auto focus)	"M" (manual focus)
"S" (single frame mode)	<p>When the shutter button is half-pressed, the focus is adjusted. Once the subject is in focus, the focus is locked at that position (focus lock).</p> <ul style="list-style-type: none"> <li>• The shutter cannot be released if the subject is not in focus.</li> </ul>	<p>The focus is adjusted continuously while the shutter button is half-pressed.</p> <ul style="list-style-type: none"> <li>• The shutter can be released even if the subject is not in focus.</li> </ul>	<p>The focus is adjusted by turning the lens' focus ring by hand.</p>
"C" (continuous shooting mode)	<p>Focusing is performed in the same way as in the single frame mode. In the continuous shooting mode, the focus is locked at the distance at which the first frame (photo) was exposed and remains at that position for subsequent frames.</p>	<p>Focusing is performed in the same way as in the single frame mode. In the continuous shooting mode, the focus is readjusted for each new frame of film exposed.</p>	<p>Focusing is performed in the same way as in the single frame mode.</p>

## <Focus lock>

If the subject is not within a focusing frame with the desired composition, use the procedure described below to lock the focus on that subject.

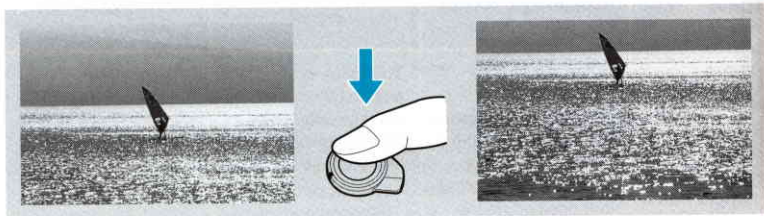

### ❖ In the “SAF” (single auto focus) mode

**1** Point the camera at the subject on which you want to focus, position the subject within a focusing frame, then half-press the shutter button.

The focus is adjusted automatically. When the subject is in focus, the focus mark (“○”) lights in the viewfinder and the focus is locked at that position.

**2** Still half-pressing the shutter button, position the camera to achieve the desired composition, then press the shutter button all the way in to take the picture.

- The focus is locked as long as the shutter button is half-pressed, so it does not change when the camera is repositioned.
- The focus lock is canceled when you release your finger from the shutter button.

## ❖ In the “CAF” (continuous auto focus) mode

**1** Point the camera at the subject on which you want to focus, position the subject within the focusing frame, then half-press the shutter button.

The focus is adjusted continuously while the shutter button is half-pressed.

**2** Check that the focus mark in the viewfinder is lit, then press the focus button.

The focus is locked when the focus button is pressed.

**3** Still pressing the focus button, position the camera to achieve the desired composition, then press the shutter button all the way in to take the picture.

• The focus is locked as long as the focus button is pressed.

### <Subjects that may cause problems for the autofocus system>

For the subjects described below, the camera may not be able to focus automatically and the “▷ ◁” (focusing not possible) mark may flash. In such cases, either use the focus lock function to first focus on a different object at the same distance as the subject or adjust the focus in the manual focus mode.

- ① Extremely bright or extremely dark subjects.
- ② Subjects which have little or no contrast.
- ③ When the sun or other strong light sources are within or near the focusing frame.
- ④ When there are two or more subjects at extremely different distances within the focusing frames.
- ⑤ Subjects with repeating patterns.
- ⑥ When the ambient light level is very low or an ND or polarizing filter is used.

### <Focus lock>

If the subject is not within a focusing frame with the desired composition, use the procedure described below to lock the focus on that subject.

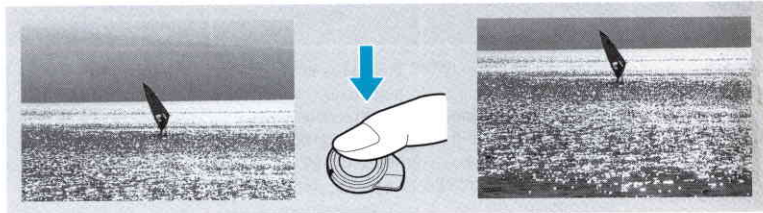

#### ❖ In the “SAF” (single auto focus) mode

**1** Point the camera at the subject on which you want to focus, position the subject within a focusing frame, then half-press the shutter button.

The focus is adjusted automatically. When the subject is in focus, the focus mark (“O”) lights in the viewfinder and the focus is locked at that position.

**2** Still half-pressing the shutter button, position the camera to achieve the desired composition, then press the shutter button all the way in to take the picture.

- The focus is locked as long as the shutter button is half-pressed, so it does not change when the camera is repositioned.
- The focus lock is canceled when you release your finger from the shutter button.

## ◆ In the “CAF” (continuous auto focus) mode

**1** Point the camera at the subject on which you want to focus, position the subject within the focusing frame, then half-press the shutter button.

The focus is adjusted continuously while the shutter button is half-pressed.

**2** Check that the focus mark in the viewfinder is lit, then press the focus button.

The focus is locked when the focus button is pressed.

**3** Still pressing the focus button, position the camera to achieve the desired composition, then press the shutter button all the way in to take the picture.

• The focus is locked as long as the focus button is pressed.

## <Subjects that may cause problems for the autofocus system>

For the subjects described below, the camera may not be able to focus automatically and the “▷ ◁” (focusing not possible) mark may flash. In such cases, either use the focus lock function to first focus on a different object at the same distance as the subject or adjust the focus in the manual focus mode.

- ① Extremely bright or extremely dark subjects.
- ② Subjects which have little or no contrast.
- ③ When the sun or other strong light sources are within or near the focusing frame.
- ④ When there are two or more subjects at extremely different distances within the focusing frames.
- ⑤ Subjects with repeating patterns.
- ⑥ When the ambient light level is very low or an ND or polarizing filter is used.



Picture is in focus.



Picture is not in focus.

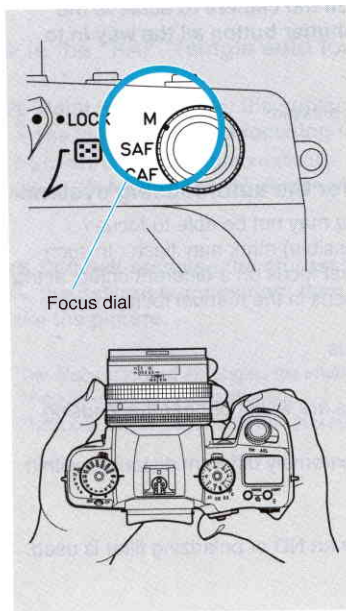

#### <Adjusting the focus>

Set the focus dial to "M".

Adjust the focus by turning the lens' focus manually.

This camera is equipped with an FX-2 focusing screen as standard (full screen matte).

The image on the matte surface is clearly visible when the subject is in focus, blurry when subject is out of focus.

- If the manual focus mode is set, the selection of focus frame will be "Manual select mode".

In the manual focus mode, the focus indicators in the viewfinder show the result of measuring the distance to the subject within the selected focusing frame.



“▷” flashing: The camera is focused at a point further than the subject (focus far).

“○” lit: The subject is in focus.

“◁” flashing: The camera is focused at a point closer than the subject (focus near).

- When the object in the selected focusing frame is in focus, the focusing frame lights red.
- The focusing frame can be changed to suit the shooting purposes or applications. For details, see page 93.

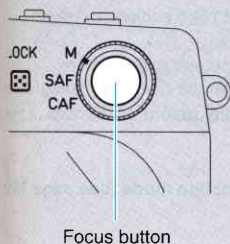

### <One shot auto focus>

The autofocus mechanism can be used while in the manual focus mode. To do so, press the focus button. The camera adjusts the focus automatically while the focus button is pressed, and when the subject is in focus the focus is locked at that position.

Use this function for taking individual shots with the auto focus mechanism while using the camera in the manual focus mode.

## 4. Taking photos with the focus shifted in three different steps (Focus ABC mode)

This function allows you to make three photographs in a series with focus shifted in each frame. The shift is from selected focus to closer to further away from the selected focusing distance. Use the Focus ABC when you are trying to achieve subtle differences in focusing effects.

For the first frame, focus manually. The camera adjusts the focus automatically for the second (focus near) and third (focus far) frames. Readjust the focus for the first frame each time you use the Focus ABC mode.

\* ABC: Automatic Bracketing Control

### <Amount of shift of the focus>

- ① The focus shifts by an extremely small amount, so the effects achieved when using this mode may not be apparent with general photography or when photographing with smaller apertures.
- ② The focus shifts by an amount equivalent to the depth of field at the maximum aperture of the mounted lens.
- ③ The effect achieved by shifting the focus depends on the lens being used, the shooting distance and the aperture. In general:
  - The longer the shooting distance, the less apparent the effect on the resulting photographs.
  - The smaller the aperture, the less apparent the effect on the resulting photographs.
  - The greater the percentage of the picture occupied by the main subject, the less apparent the effect on the resulting photographs.
  - The smaller the distance between the main subject and the rest of the picture (background or foreground), the less apparent the effect on the resulting photographs.
  - The more the resulting photographs are enlarged, the more apparent the effect of the shifted focus.

**The following can be done by changing the custom function mode (see page 74):**

- The amount of shift of the focus can be doubled.
- The first frame can be focused in the "SAF" mode.
- The third frame in the series can be cancelled.

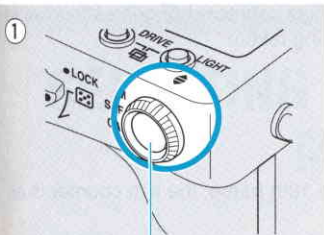

Focus dial

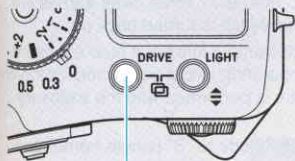
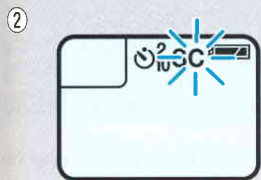

Drive mode button

www.butkus.us

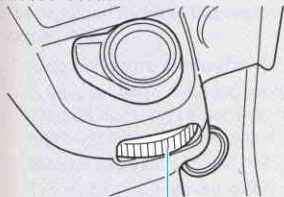

Electronic dial

**1** Set the focus dial to “ $\diamond$ ” to set the Focus ABC mode. Set the focus mode to manual.

**2** Set the drive mode to “C” (continuous shooting).

- For instructions on setting the drive mode, see page 23.

**3** Focus on the subject, then press and hold in the shutter button.





The camera automatically takes three frames: standard (focus position), focus near and focus far, in that order. When the drive mode is set to “S”, the camera is set to the Focus ABC mode for single frame shooting. When the drive mode is set to “ $\odot^2$ ” or “ $\odot_{10}$ ”, the camera is set to the Focus ABC mode with a delay of 2 or 10 seconds prior to actual exposure after the shutter release button is pressed.

- When “Focus Far Off” is set for the custom function (see page 75), shooting stops after the second frame.

When shooting in the Focus ABC mode, the film counter changes as follows to indicate the order in which the photos are being taken:

- Standard : Both digits flashing
- Focus near : Only left digit flashing
- Focus far : Only right digit flashing

For example, if the Focus ABC is used at the 18th frame, the film counter is as follows:

	1st frame	2nd frame	3rd frame	4th frame (repeated)
Focus position	Standard	Focus near	Focus far	Standard
Counter				
Display	Both left and right flashing	Left flashing	Right flashing	Both left and right flashing

- To cancel in the middle of the operation, set the Focus ABC dial to any position other than “”.
- If the main switch is turned off during the Focus ABC operation, three more frames are taken in order in the Focus ABC mode when the main switch is turned back on.
- When used together with the Exposure ABC mode (3-frame continuous auto exposure compensation mode, page 50), the Exposure ABC operation is first performed for the first frame (focus position), then the Focus ABC procedure is performed with the exposure value set for the first frame.
- To use a flash with the Focus ABC mode, set the drive mode to “S” (single frame) and check that the flash is charged before shooting.
- This mode cannot be used when a Contax 645 lens is mounted using the mount adapter.

# SELECTING THE METERING MODE

This camera is equipped with three metering modes: evaluative metering, average metering and spot metering. The mode is selected with the metering lever.

To achieve highly effective photos with higher precision, read "Types of metering modes and their features" on the next page carefully and select the metering mode according to the shooting conditions and your desire to achieve a certain exposure effect.

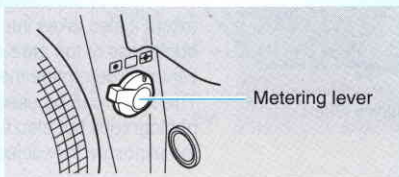

## <Exposure meter>

The exposure meter in the viewfinder indicates the following according to the exposure modes:

### ① Auto exposure mode (Tv, Av or P mode):

In the evaluative metering mode, the meter indicates the difference with the average metering value. In the average and spot metering modes it indicates the exposure compensation value.

### ② Manual exposure mode ("M") and flash photography mode ("X"):

The meter indicates the difference between the manual exposure setting and the camera-recommended autoexposure setting.

### ③ Bulb mode: Not displayed.

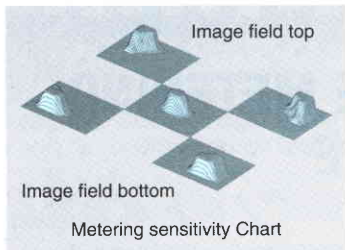

## <Evaluative metering (“☒” mark)>

With evaluative metering, the picture is divided into five sections, as illustrated. The autoexposure system calculates the appropriate exposure based on an analysis of subject conditions and positioning. Because of this, evaluative metering can be used not only for general photography but also when the subject is lit from behind, with virtually no exposure compensation or adjustment required.

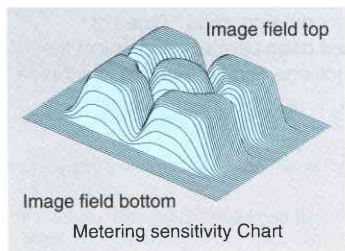

## <Average metering (center-weighted average meter) (“□” mark)>

In this mode, the light is measured with emphasis on the brightness of the subject at the center of the viewfinder. To a certain extent it also takes into consideration the brightness of the area surrounding the center to determine the exposure value. This mode can be used for general photography but also for easily determining the exposure for subjects in motion.

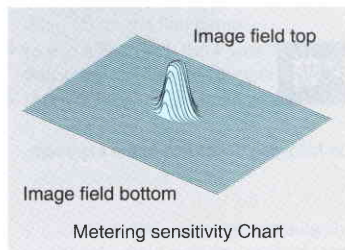

## <Spot metering (“□” mark)>

In this mode, only the brightness value of the subject at the focusing frame at the center of the image in the viewfinder is measured. Use spot metering in cases when the difference between the brightness value of the subject and the background is high. A good example is people lit from behind or standing in spot lights on theater stages. It can also be used for making very selective readings of specific areas within the scene.

## 2. Metering range

LENS	APERTURE	EV
50mm	f/1.4	0
50mm	f/1.8	1
50mm	f/2.2	2
50mm	f/2.8	3
50mm	f/3.5	4
50mm	f/4.5	5
50mm	f/5.6	6
50mm	f/7.1	7
50mm	f/9.0	8
50mm	f/11.3	9
50mm	f/14.0	10
50mm	f/17.5	11
50mm	f/22.0	12
75mm	f/1.4	1
75mm	f/1.8	2
75mm	f/2.2	3
75mm	f/2.8	4
75mm	f/3.5	5
75mm	f/4.5	6
75mm	f/5.6	7
75mm	f/7.1	8
75mm	f/9.0	9
75mm	f/11.3	10
75mm	f/14.0	11
75mm	f/17.5	12
75mm	f/22.0	13
100mm	f/1.4	2
100mm	f/1.8	3
100mm	f/2.2	4
100mm	f/2.8	5
100mm	f/3.5	6
100mm	f/4.5	7
100mm	f/5.6	8
100mm	f/7.1	9
100mm	f/9.0	10
100mm	f/11.3	11
100mm	f/14.0	12
100mm	f/17.5	13
100mm	f/22.0	14
135mm	f/1.4	3
135mm	f/1.8	4
135mm	f/2.2	5
135mm	f/2.8	6
135mm	f/3.5	7
135mm	f/4.5	8
135mm	f/5.6	9
135mm	f/7.1	10
135mm	f/9.0	11
135mm	f/11.3	12
135mm	f/14.0	13
135mm	f/17.5	14
135mm	f/22.0	15
200mm	f/1.4	4
200mm	f/1.8	5
200mm	f/2.2	6
200mm	f/2.8	7
200mm	f/3.5	8
200mm	f/4.5	9
200mm	f/5.6	10
200mm	f/7.1	11
200mm	f/9.0	12
200mm	f/11.3	13
200mm	f/14.0	14
200mm	f/17.5	15
200mm	f/22.0	16

- The autoexposure system in the camera measures light in a shutter speed range of 32 seconds to 1/8000 second in the auto exposure mode.
- The parts indicated in color within the range indicate the automatic metering range when using ISO 100 film and an F1.4 lens.

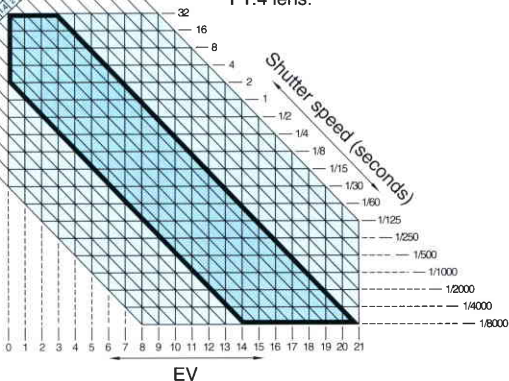

### <Automatic metering range>

This table shows the mutual relationship between aperture, shutter speed and EV (exposure value). For example, when using ISO 100 film and an f/1.4 lens in the average metering mode, the automatic metering range is the range indicated by the points where the line extending diagonally from 16 (the Planar T\*50 mm minimum aperture is f/16) and "1.4" (the maximum aperture) on the aperture table's ISO 100 section intersects with the vertical line (the EV line) and horizontal line (the shutter speed line). Thus, that is EV "0" to EV "21".

- The EV expresses the combinations of aperture and shutter speed that achieve the same exposure effect on film. For example, the table shows that at EV 13 the same exposure effect can be achieved at f/16 at 1/30 and f/8 at 1/125 second. While the EV represents an equivalent exposure the image effects of faster and slower shutter speeds and larger and smaller apertures differ.



# APPLIED PHOTOGRAPHY TECHNIQUES



This camera allows for a wide range of creative possibilities.

# 1. Taking photos with the aperture priority mode "Av" (aperture priority auto exposure) mode ("Av" stands for "Aperture value").

In this mode, when the aperture is set the camera automatically sets the shutter speed for a correct exposure. The zone of sharpness (depth of field) depends on the aperture value. Refer to the examples below and adjust the aperture according to your purpose. For details on depth of field, see page 58.

**Example 1:** When photos are taken with a larger aperture, the zone of sharpness (depth of field) is narrower. Use a larger aperture when you want the subject to stand out against a less sharp background.

**Example 2:** When photos are taken with a smaller aperture, the zone of sharpness is greater. Use a smaller aperture when you want both the subject and the background to be sharp.

**Example 1:** Large aperture



**Example 2:** Small aperture

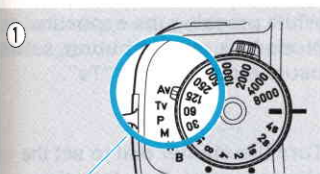

Set to "Av".

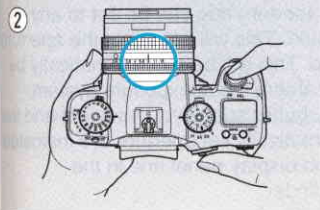

**1** While pressing the exposure mode lock release button, set the exposure mode lever to "Av".

**2** Turn the lens' aperture ring to set the aperture, then take the picture.

The shutter dial can be set to any position. This will not affect the shutter speed, as the camera will select the appropriate speed automatically.

The aperture you have set and the automatically selected shutter speed are indicated on the display panel and in the viewfinder.

## 2. Taking photos with shutter speed priority settings "Tv" (shutter priority auto exposure) mode ("Tv" stands for "Time value".)

www.butkus.us

When you select the shutter speed in this mode the camera automatically selects the aperture for the correct exposure. This mode is suited for setting fast shutter speeds for freezing the motion of moving subjects, photographing at slow shutter speeds to create an intentional blur in moving subjects or to set a shutter speed that will insure steady pictures when using long-range telephoto lenses handheld.

**Example 1:** To freeze the action of a moving subject, set a fast shutter speed.

**Example 2:** To express the movement of water, for example, set a slow shutter speed.

- When using a slow shutter speed, use a tripod to prevent camera shake.

**Example 1:** Fast shutter speed



**Example 2:** Slow shutter speed



- 1 Set to "Tv".

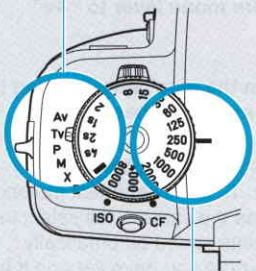

- 2 Set the shutter speed.

**1** While pressing the exposure mode lock release button, set the exposure mode lever to "Tv".

**2** Turn the shutter dial to set the shutter speed, then take the picture.

The aperture ring can be set to any position. This will not affect the aperture value. This will be set automatically by the camera's autoexposure system.

The shutter speed you have set and the automatically set aperture are indicated on the display panel and in the viewfinder.

www.butkus.us

### 3. Taking photos in the program auto mode "P" (program auto exposure) mode

In this mode, the camera automatically selects the combination of the aperture and shutter speed most suitable for the brightness of the subject. This mode is convenient when you want to take photographs easily without worrying about the exposure settings.

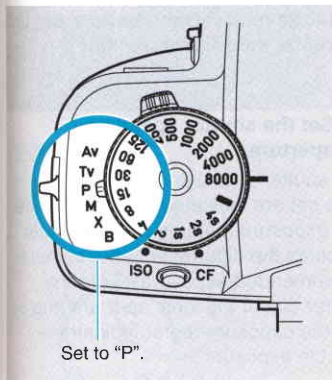

**1** While pressing the exposure mode lock release button, set the exposure mode lever to "P".

**2** Take the picture.

The automatically set aperture and shutter speed are indicated on the display panel and in the viewfinder. The aperture ring and shutter dial can be set to any position.

#### <Program auto mode control diagram>

The combinations of the aperture and shutter speed in the program auto mode are as shown on the diagram. This program line shifts according to the lens' focal distance. (F1.4/50 mm lens, ISO 100)

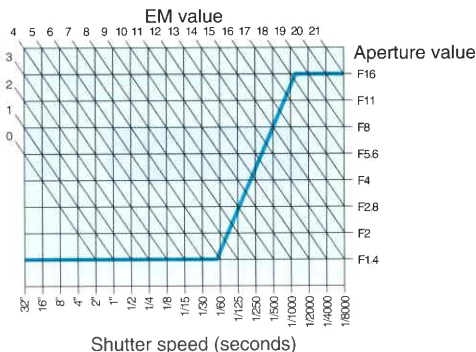

## 4. Taking photos with the exposure set manually "M" (manual exposure) mode

www.butkus.us

In this mode, you set the aperture and shutter speed yourself. This mode can also be used to intentionally achieve over- or under-exposure effects. Refer to the exposure meter display in the viewfinder to set the exposure.

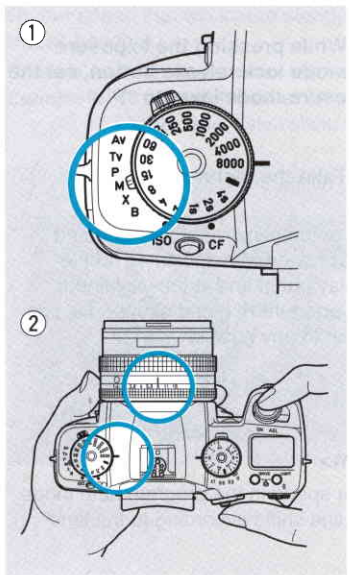

**1** While pressing the exposure mode lock release button, set the exposure mode lever to "M".

**2** Set the shutter speed and aperture.

The shutter speed and aperture you have set are indicated in the viewfinder. The exposure meter in the viewfinder indicates the difference to the camera-recommended exposure. Turn the shutter dial or the lens' aperture ring so that the exposure meter indicates a suitable exposure.

**3** Adjust the focus, then take the picture.

### Examples of exposure meter displays



1EV over



Camera Recommended



2EV or more under

www.butkus.us

## 5. Using the bulb exposure mode



Use the bulb mode for nighttime or astronomical photography requiring long exposure times.

**1** While pressing the exposure mode lock release button, set the exposure mode lever to “B”.

“buLb” is displayed in the shutter speed section of the viewfinder display panel.

**2** Set the aperture and take the picture.

The shutter is released and the film is exposed while the shutter button is pressed.

- To prevent the camera from shaking, either fix it to a tripod or place it on a stable surface, and connect a separately sold LA type cable switch to the camera and use it when taking the picture.
- While the film is being exposed, the display panel's film counter switches to a timer display indicating the elapsed bulb shooting time. The counter counts from “00” to “59” (59 seconds), then starts over from “00”.
- The entire viewfinder display remains off while the film is being exposed.

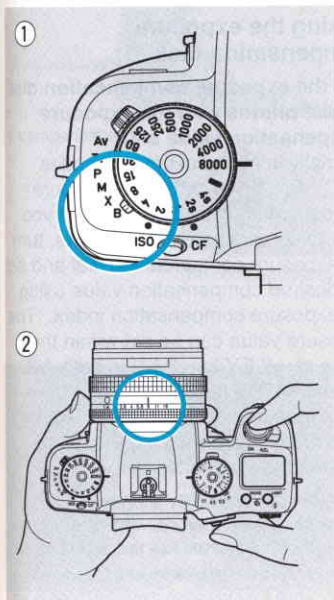

Exposure compensation can be used to help render tonal values on film properly and to add personal nuances to certain scenes. In most cases the evaluative meter will handle tough exposure conditions. Exposure compensation is most often used when photographing with center-weighted or spot metering mode. For example, subjects such as white snow in daylight read by a spot meter should be compensated anywhere from +1 to -2 EV, otherwise the meter's tendency to meter to middle gray will result in gray rather than white snow rendition. You can also use exposure compensation to deliberately underexpose certain scenes for increased color saturation or overexpose for a high key effect.

Exposure can be compensated using the two methods described below.

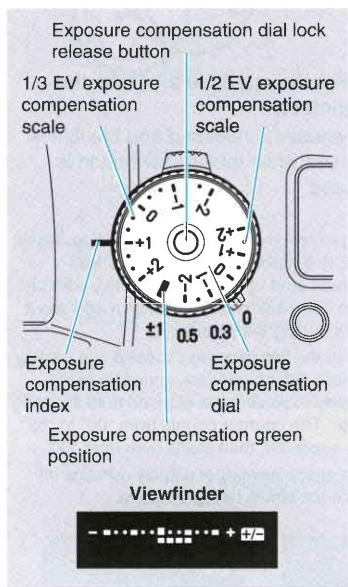

### <Using the exposure compensation dial>

**Use the exposure compensation dial to take photos with the exposure compensation value set.**

Normally in all the exposure modes ("Av", "Tv", "P" or "M"), the exposure compensation dial is set to "0". If you wish to compensate the exposure, turn the exposure compensation dial and set the desired compensation value using the exposure compensation index. The exposure value can be set within the range of +2 EV to -2 EV in both 1/3 EV and 1/2 EV steps.

The exposure value and the "+" or "-" mark are displayed on the exposure meter in the viewfinder.

- To switch between 1/3 EV and 1/2 EV, turn the exposure compensation dial while pressing the exposure compensation lock release button.
- Not displayed on the viewfinder's exposure meter when the evaluative metering mode is set.

Exposure mode	What is compensated
Aperture priority auto (Av)	Shutter speed
Shutter priority auto (Tv)	Aperture
Program auto (P)	Aperture and shutter speed

- In the "M" mode, the exposure cannot be compensated with the exposure compensation dial. Compensation is set manually and is displayed on the exposure meter in the viewfinder. To compensate the exposure, turn the shutter speed dial or aperture ring so that the desired difference (amount of compensation) is displayed on the exposure meter.
- After taking the picture, be sure to set the exposure compensation dial back to "0".



(+ compensation)



(no compensation)

### When the subject is lit from behind

**Compensate within the range of +1/3 EV or +1/2 EV to +2 EV.**

In the average metering mode, when the percentage of the picture occupied by a bright background is large (for example people with a light, a bright sky or the sea behind them, people in front of a window, etc.), the people tend to be under-exposed and appear as dark silhouettes. In such cases, compensate the exposure within the range of +1/3 EV or +1/2 EV to +2 EV to increase the exposure on the main subject.



(- compensation)



(no compensation)

### When the background is dark

**Compensate within the range of -1/3 EV or -1/2 EV to -2 EV.**

When the percentage of the picture occupied by a dark background is large (people standing in spotlights, etc.), if the photo is taken in the average metering mode the people tend to be over-exposed. In such cases, compensate the exposure within the range of -1/3 EV or -1/2 EV to -2 EV to reduce the exposure.

## <Taking photos with the Exposure Auto Bracketing Mode (Exposure ABC mode)>

The Exposure ABC mode can be used to automatically take a series of three photographs with three exposures: standard, overexposed and underexposed.

Use this when shooting under difficult lighting conditions to ensure correct exposure.

\* ABC stands for "Automatic Bracketing Control".

In the Exposure ABC mode, exposure is compensated according to the exposure mode set.

Exposure mode	What is controlled
"Av" (aperture priority auto)	Shutter speed
"Tv" (shutter priority auto)	Aperture
"P" (program auto)	Aperture and shutter speed
"M" (manual exposure)	Shutter speed

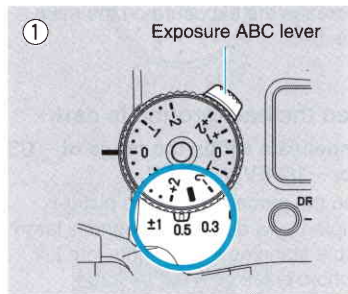

**1** The Exposure ABC mode is set when the Exposure ABC lever is moved to set the compensation range.

The compensation range can be set to  $\pm 0.3$  EV,  $\pm 0.5$  EV or  $\pm 1$  EV.

- When the exposure compensation dial is set to anything other than "0", the Exposure ABC mode functions based on that compensation value.
- The camera measures the light value and sets the corresponding compensation each time a series of photos is taken. To use the Exposure ABC mode without being influenced by changes in the surrounding brightness, lock the exposure lever beforehand.
- After taking the series of pictures, be sure to set the Exposure ABC lever back to "0".
- It is not possible to use the Exposure ABC mode together with flash.

2

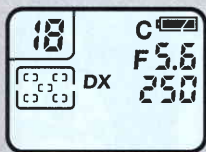

## 2 Set the drive mode to “C” (continuous shooting).

- For instructions on setting the drive mode, see page 53.

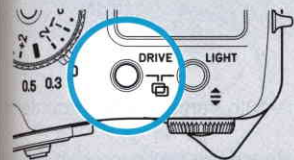

## 3 Focus on the subject then press and hold in the shutter button.

Three frames are taken using the set compensation range: standard, over and under, in that order.

3

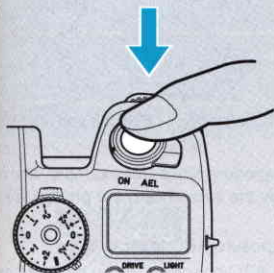

When the drive mode is set to “S”, the camera is set to the Exposure ABC mode for single frame shooting. When the drive mode is set to “ $\infty^2$ ” or “ $\infty_{10}$ ”, the camera is set to the Exposure ABC mode with a delay of 2 or 10 seconds between pressing on the shutter release and exposure.

When shooting in the Exposure ABC mode, the film counter changes as follows to indicate the order in which the photos are being taken:

- Standard : Both digits flashing
- Over : Only left digit flashing
- Under : Only right digit flashing

- The “E” mark lights in the viewfinder.





For example, if the Exposure ABC is used at the 18th frame, the film counter is as follows:

	1st frame	2nd frame	3rd frame	4th frame (repeated)
Focus position	Standard	Over	Under	Standard
Counter				
Display	Both left and right flashing	Left flashing	Right flashing	Both left and right flashing

- If the compensation range exceeds the camera's exposure limits (for example, above 1/8000 second or at larger apertures than offered by the lens in use) the photos are taken within those limits.
- To cancel in the middle of the operation, set the Exposure ABC lever to "0".
- If the main switch is turned off during the Exposure ABC operation, three more frames are taken in order in the Exposure ABC mode when the main switch is turned back on.
- The exposure order can be switched to over → standard → under. (Page 74)

## <Taking photos with the AE lock>

AE lock allows you to hold a certain exposure value even if the light changes or the composition is altered. It allows you to customize exposure in autoexposure modes. Use it when the subject is lit from behind or when you want to take a series of photos of a moving subject with a constant exposure.



This locks the exposure (AE lock).

**1** Position the main subject in the center of the viewfinder, then switch the main switch from “ON” to “AEL”.

This locks the exposure (AE Lock).

When you want to set the exposure on a select area within the frame, set the metering lever to the spot metering position then lock the exposure.

- When the exposure is locked, the metering mark in the viewfinder flashes.
- Set the AE lock mode while the display in the viewfinder is lit.



## 2 Reposition the camera for the desired composition, then take the picture.

- When the exposure is locked, the exposure remains in the memory and photos can be taken as many times as you want with the same exposure value. To save energy, the mark turns off after 16 seconds.
- In the continuous shooting mode (drive mode “C”) the exposure can be locked on a moving subject so that it is possible to take multiple photographs with the same exposure regardless of changes in the background.
- When AE Lock is set the camera stores the exposure determined by the combination of the shutter speed and aperture. In the “Av” mode, if the aperture is changed after the exposure is locked, the shutter speed is shifted so that the overall exposure remains constant.
- If the position of the exposure compensation dial is changed while the exposure is locked, the exposure compensation changes, depending on the exposure mode, as shown below

Exposure mode	What is compensated
Aperture priority auto (Av)	Shutter speed
Shutter priority auto (Tv)	Aperture
Program auto (P)	Aperture and shutter speed

## 7. Taking Multiple exposure

With the multiple exposure function, unique photographs can be taken by superimposing different subjects or the same subject several times within the same frame.

### ① Multiple exposure setting mode

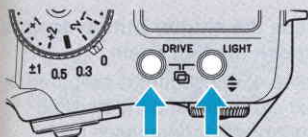
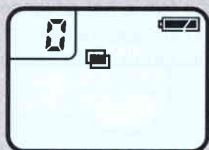

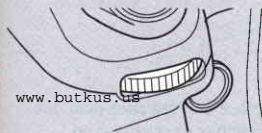
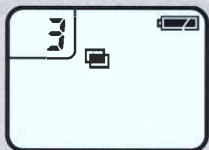

Press simultaneously for at least 2 seconds

②

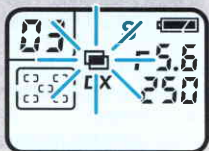

### ③ Multiple exposure shooting mode



**1** Press the “DRIVE” button and “LIGHT” button (“”) simultaneously for at least 2 seconds to set the multiple exposure mode.

The “” mark and “0” (multiple exposure number) appear on the display panel.

**2** Turn the command dial to set the number of multiple exposures.

The multiple exposure number can be set as follows:

0 ↔ 2 ↔ 3 ↔ ... ↔ 9. For example, when “3” is displayed, the same frame will be exposed three times.

**3** Press the drive button to set the multiple exposure shooting mode.

The multiple exposure number display changes to a 2-digit display (“03”) and the “” mark starts flashing.

- Note that the multiple exposure mode is canceled if the main switch is turned off before any exposures have been taken in the multiple exposure mode.

“” lit: Multiple exposure setting mode

“” flashing: Multiple exposure shooting mode

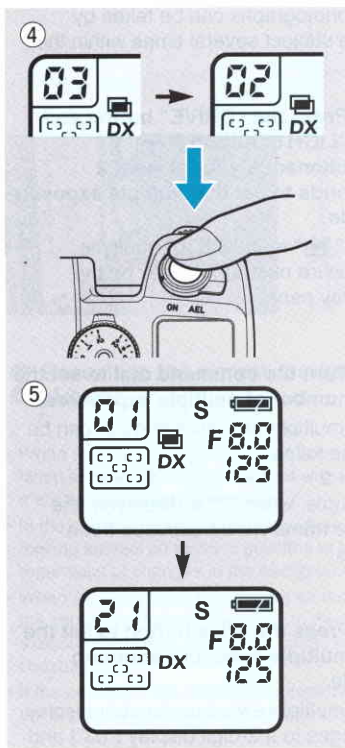

#### 4 Press the shutter button once to expose the film one time.

When the shutter button is pressed once, the film is exposed one time, and only the shutter is prepared for the next exposure (the film is not advanced). The multiple exposure number display on the display panel decreases by 1.

#### 5 Press the shutter button again to expose the film again.

As in step 4, the shutter is prepared for the next exposure and the multiple exposure number decreases by 1.

**When the last exposure is made, the film is advanced and the display panel returns to the normal display.**

- If the main switch is turned off in the middle of the multiple exposure operation, the multiple exposure operation continues when the main switch is next turned on.
- To change the multiple exposure number in the middle of the multiple exposure operation, press the drive button and light button simultaneously for at least 2 seconds. This sets the multiple exposure mode. Use the command dial to change the number of multiple exposures, then follow the procedure from step 3.
- To cancel multiple exposure shooting before all the exposures have been made, return to the multiple exposure setting mode and change the multiple exposure number to "0". The multiple exposure shooting mode is canceled and the film is advanced.
- When the self timer is set, the camera is set to the multiple exposure shooting mode with a delay of 2 or 10 seconds after the shutter release has been pressed.

## 8. Using the self timer

There are two self timer modes.

“ $\odot_{10}$ ” (10 seconds): Use this mode to include yourself in the photograph.

“ $\odot_2$ ” (2 seconds) : Use this mode to prevent camera shake when the shutter is released (when taking close-ups, making photocopies, etc.).

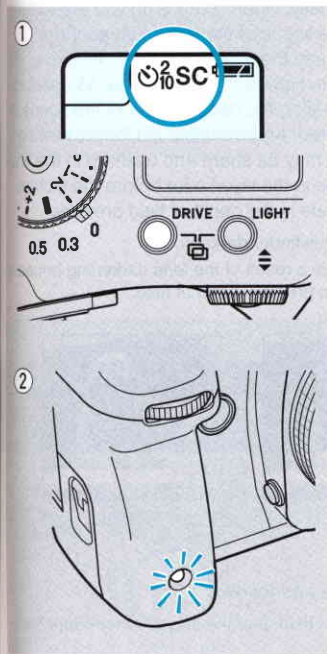

### 1 Set the drive mode to “ $\odot_{10}$ ” or “ $\odot_2$ ”.

- For instructions on setting the drive mode, see page 53.

### 2 Adjust the focus, then press the shutter button.

The self timer is activated and the shutter is released after 10 or 2 seconds. The self timer LED on the front of the camera flashes while the self timer is operating.

- If you are not looking through the viewfinder when an auto exposure is made the exposure made be adversely affected due to light entering through the eyepiece. In such cases, close the eyepiece shutter before taking the photo.
- Use a tripod when taking photos with the self timer.
- If the shutter button is pressed after the self timer has been activated, the self timer time is reset.
- To cancel the self timer after it has been activated, turn the main switch off.

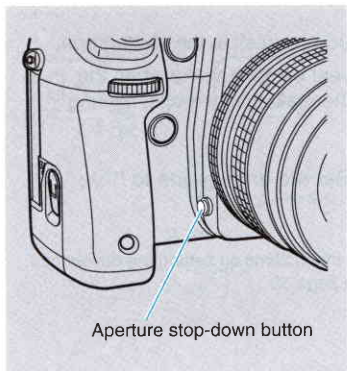

Depth of field defines the perception of sharpness in a photograph of subjects at different distances from the camera. It is affected by the focal length of the lens, the distance from the camera to the subject and the aperture setting of the lens. Normally, when composing you are looking at the scene at the maximum aperture, thus see the shallowest depth of field of the scene. However, when the taking aperture is smaller, the depth of field of the scene is affected. An invaluable aid for previewing what may be sharp and unsharp in the final image in the viewfinder before the picture is made is the depth of field preview.

- When the depth of field preview is activated the viewfinder darkens.
- This darkening does not indicate the exposure. It is a result of the lens darkening because of the smaller aperture and only should be used to preview depth of field.

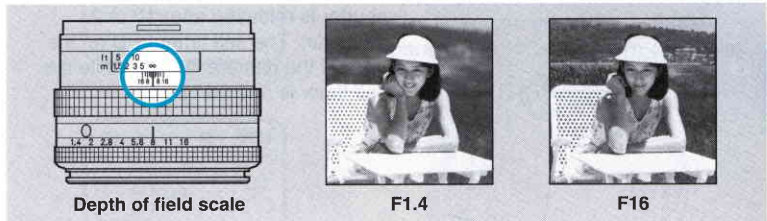

### <About depth of field>

With the same lens, the depth of field changes as follows:

- ① The smaller the aperture the greater the depth of field, and the larger the aperture the shallower the depth of field.
- ② The greater the distance to the subject, the greater the depth of field, and the closer the distance to the subject, the shallower the depth of field.
- ③ The depth of field also depends on the lens. The shorter the focal length, the greater the depth of field, and the longer the focal length the shallower the depth of field. The depth of field is deeper behind the focused subject than in front.

### Depth of field scale

This scale can be used to check the actual range of the depth of field when using different lenses.

## 10. Cable switch socket

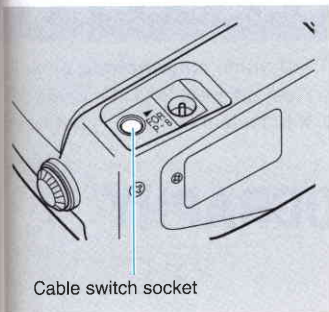

This is a contact for connecting an LA type cable switch or when using the auto bellows. The electronic signals from the connected accessory are transmitted through this contact to operate the shutter.

- When taking photographs using an LA type cable switch and shooting automatically without looking through the viewfinder, it may not be possible to achieve the proper exposure due to light entering through the eyepiece. In such cases, close the eyepiece shutter when taking the photo.

## 11. Replacing the camera back

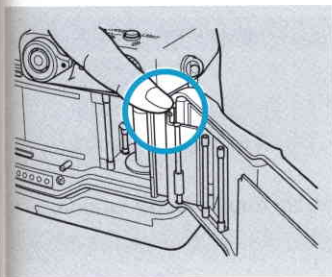

**The camera back can be removed and replaced with the separately sold D-10 data back (page 86). Remove the camera back by pressing down on the release pin.**

# FLASH PHOTOGRAPHY

This camera is equipped with a "TTL direct metering" function for controlling the flash automatically from the camera when it is used together with a Contax TLA flash system.

When using the TLA360 flash, be sure to read both to "Taking photos using a Contax TLA flash" (page 61) and "Taking photos using a Contax TLA360 flash" (page 66).

When using a non-dedicated flash with only an X contact, set the exposure mode lever to 70 page.

# 1. Taking photos using a Contax TLA flash

The flash is automatically controlled from the camera.

## <Taking photographs using the TTL auto flash function>

The amount of light from the flash reflected off the subject onto the film is measured (TTL direct metering) to control the intensity of the flash.

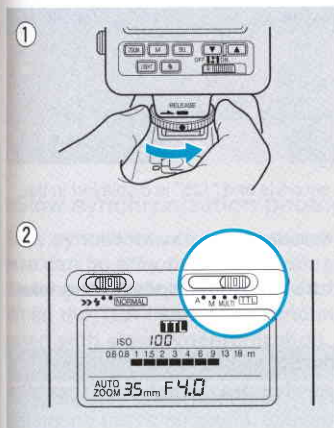

**1** Mount the flash on the camera's accessory shoe and turn on the flash.

**2** Set the flash to the "TTL auto mode".

Once the flash is charged, the "⚡" mark lights in the viewfinder and the shutter speed is set automatically.

## ♦ Av (aperture priority auto) mode

Metered value of natural light	Automatically set shutter speed	(Display)
32 to 1/60 sec.	1/60 sec.	"60" lit
1/60 to 1/250 sec.	1/60 to 1/250 sec.	"60" to "250" lit
1/250 to 1/8000 sec.	1/250 sec.	"250" lit

## ♦ Tv (shutter priority auto) mode

Shutter dial setting	Automatically set shutter speed	(Display)
4 (32) to 1/250 sec. "()" – when command dial set	4 (32) to 1/250 sec.	Same as shutter dial setting
1/250 to 1/8000 sec.	1/250 sec.	"250" lit

❖ **P (program auto) mode**

Metered value of natural light	Automatically set shutter speed	(Display)
32 to 1/60 sec.	1/60 sec.	"60" lit
1/60 to 1/250 sec.	1/60 to 1/250 sec.	"60" to "250" lit
1/250 to 1/8000 sec.	1/250 sec.	"250" lit

❖ **M (manual), X (flash) and B (bulb) modes**

- In the "M" mode, the shutter speed is not set automatically. Be sure to set it to 1/250 seconds or slower.
- The set shutter speed is displayed in the viewfinder.
- In the "X" mode, the shutter speed is set to 1/125 seconds and "125" is displayed in the viewfinder.
- In the "B" mode, the bulb mode is set and "buLb" is displayed in the viewfinder.

**3 Use the following table to set the aperture or shutter speed, then take the picture.**

Exposure mode	Aperture or shutter speed
P	No setting is necessary. The camera makes the settings automatically.
Av, M, X and B	Set the aperture. The photograph is taken with the set aperture.
Tv	Set the shutter speed to 1/250 seconds or slower. The appropriate aperture for the ambient light is set automatically. When the subject is bright, the aperture is automatically reduced.

- If the flash exposure is correct, the "⚡" mark in the viewfinder flashes for 2 seconds.
- If the "⚡" mark does not flash after exposure, the picture was under-exposed. Open the aperture or shorten the shooting distance and take the photo again.
- When taking close-ups, the picture may be over-exposed even if the "⚡" mark flashes after the photo was taken. Take the photo within the distance range indicated in the flash's operating instructions.
- Be sure to set the Exposure ABC lever to "0".
- When taking photos with the drive mode set to "C" (continuous shooting mode), make sure the flash is fully charged before continuing to photograph.
- The coupling range of film speeds is ISO 25 to 800 (without exposure compensation).

Slow synchronization photography

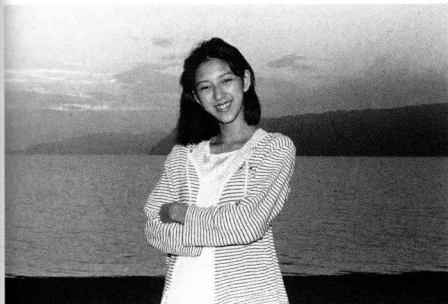

Normal flash photography



### <Slow synchronization photography>

Slow synchronization with the shutter speed set at 1/30 second or slower less can be effective for shooting evening or night views using a flash. Slow synchronization often adds more ambient light to the final picture. When the TLA flash's TTL auto mode is used, photographs can easily be taken with slow synchronization.

#### ◆ When the exposure mode is set to "P" or "Av"

Determine the composition, then set the main switch to "AEL". The shutter speed is locked at the metered value of the ambient light. Check that the flash is charged, then take the photo.

#### ◆ When the exposure mode is set to "Tv"

Determine the composition, then set the main switch to "AEL". The aperture is locked at the metered value of the ambient light. Check that the flash is charged, then take the photo.

#### ◆ When the exposure mode is set to "M"

Set the shutter speed to 1/30 seconds or less. Adjust the aperture to set the exposure to the metered value of the ambient light so that the exposure meter indicates that the exposure is appropriate, then check that the flash is charged and take the photo.

- The shutter speed is slow when slow synchronization is used, so use a tripod to prevent camera shake.



Daylight synchronization  
photography



When no flash is used

### <Daylight synchronization photography>

**When taking photos outdoors, for example of people in bright sunlight or lit from behind, the people tend to be dark in the resulting photo. In such cases, photos in which both the people and the background are well exposed can be achieved by using a TLA flash and the TTL auto mode.**

#### ❖ **When the exposure mode is set to “P”**

In bright scenes, the aperture and shutter speed are adjusted automatically and the daylight synchronization mode is set.

#### ❖ **When the exposure mode is set to “Tv”**

In bright scenes, the aperture is adjusted automatically and the daylight synchronization mode is set.

#### ❖ **When the exposure mode is set to “Av”**

If “250” flashes in the shutter speed indication after the flash is charged, the picture will likely be overexposed. Decrease the aperture so that a shutter speed of under 250 is displayed, then take the picture.

#### ❖ **When the exposure mode is set to “M” or “X”**

When in the “M” mode, set the shutter dial to “250” or less. Adjust the aperture so that the exposure meter in the viewfinder indicates that the exposure is appropriate, then take the photo.



Second curtain synchronization



First curtain synchronization

### <Second curtain synchronization>

**Taking photographs with second curtain synchronization is effective for shooting moving subjects using slow synchronization.**

Normally with flash photography the flash is emitted directly after the shutter's front curtain has finished traveling (first curtain synchronization). When this camera is used together with a Contax flash equipped with the second curtain synchronization function, the flash can be emitted directly before the shutter's rear curtain starts traveling (second curtain synchronization).

The "ghost" movement of the subject thus appears more natural.

- For instructions on second curtain synchronization settings, refer to the flash's operating instructions.
- Exposure is controlled in the same way as with regular flash photography (first curtain synchronization).

### <Using the exposure compensation dial>

With TTL auto photography, the flash's intensity is set in accordance with the camera's exposure system. You can also use exposure compensation to adjust the flash intensity, thus achieve certain effects.

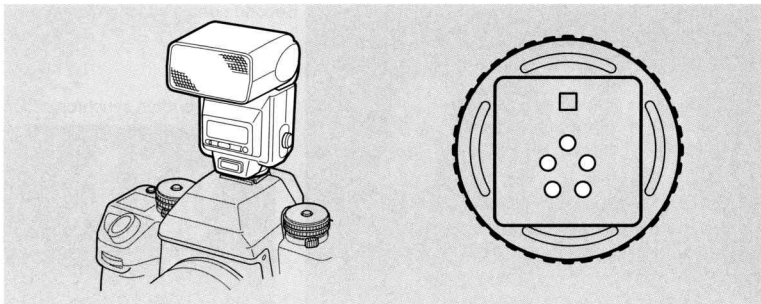

The TLA360 flash has a guide number 36 (ISO 100/35 mm lens angle of view). When used with this camera it offers the six functions described below in addition to regular TTL auto flash photography.

- These functions can be used when the flash unit is directly attached to the accessory shoe on the camera top. The flash system is not automatically set when it is used off the accessory shoe and through the TLA extension code or TLA lighting system.
- With Contax TLA flashes equipped with the flash auto set function, the flash mount has five contacts.

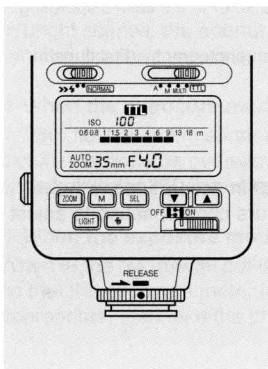

### <1. Auto set function>

Function	Auto setting of film speed	Auto setting of aperture value
Flash photography mode		
TTL auto	<input type="radio"/>	<input type="radio"/>
External metering auto	<input type="radio"/>	—
Manual	<input type="radio"/>	<input type="radio"/>
Multi-flash	<input type="radio"/>	<input type="radio"/>

○: The camera's settings are automatically set for the flash as well (after the flash is charged).

—: The flash is not automatically set.

## <2. Auto setting of the angle of illumination>

The flash's angle of illumination is set automatically according to the focal length of the lens mounted on the camera.

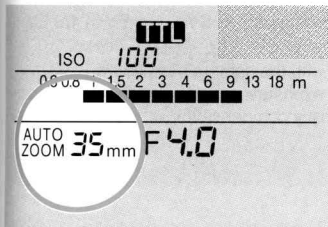

### ❖ Making the setting

Mount the flash on the camera's accessory shoe and turn it on the flash. The angle of illumination is set automatically according to the lens mounted on the camera.

The flash display panel indicates the automatically set angle of illumination for the focal distance of a 35 mm lens.

- The focal length of the lens is set to 24 mm, 28 mm, 35 mm, 50 mm, 70 mm or 85 mm.
- When a zoom lens is mounted, this function works automatically in conjunction with the lens setting within the above range.
- The focal distances indicated on the zoom lens' focal distance scale and on the flash may not be exactly the same, but this presents no problem with respect to luminous intensity distribution characteristics.
- If the lens is replaced when "AUTO ZOOM" is indicated on the flash, the angle of illumination is reset according to the new lens.

## <3. Manual setting of the angle of illumination>

When the flash's zoom button is pressed, the manual setting mode is set. The zoom focal length switches each time the zoom button is pressed. Display the desired focal distance on the display panel.

#### <4. Flash intensity compensation>

**This is available only in the TTL auto flash photography mode. Compensation is not possible in other modes.**

- The flash intensity can be compensated within the range of  $-3$  EV to  $+1$  EV in  $1/3$  EV steps.
- The flash intensity is compensated in conjunction with the camera's exposure compensation value. If for example the camera's exposure compensation is  $+1$  and the flash's compensation is set to  $+1$ , the flash intensity compensation is  $+2$ EV".

#### **1** Press the flash's "SEL" button.

- The compensation scale appears on the display panel and the  $+/-$  mark flashes.

#### **2** Use the flash's "▲" and "▼" (up and down) buttons to set the compensation scale to the desired value.

#### **3** Press the "SEL" button again.

The  $+/-$  mark stops flashing, remaining lit, and the compensation is set.

- The compensation scale on the flash's display panel indicates the compensation value for the flash.
- If the flash's compensation value is set to "0" (no compensation), the compensation scale turns off after 8 seconds.

#### <5. "Auto off" and "auto on" functions>

**When the flash's power switch is set to "auto off", the flash's power turns off automatically after approximately 80 seconds. When the camera's shutter release button is half-pressed, the flash automatically turns on and charging starts.**

**These functions help save power when using the flash for long periods of time.**

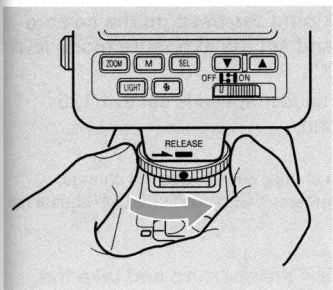

## <6. Shoe stopper>

The TL360's mount is equipped with a shoe stopper that prevents the flash from accidentally coming off the camera.

When attaching and removing the flash from the camera, be sure to line up the flash's mount mark with the mark on the shoe lock ring.

\* The TL360 is equipped with a variety of other functions as well. Be sure to read the TL360's operating instructions to take advantage of all the flash photography possibilities the TL360 has to offer.

### 3. Taking photos using other flashes with the X contact

www.butkus.us

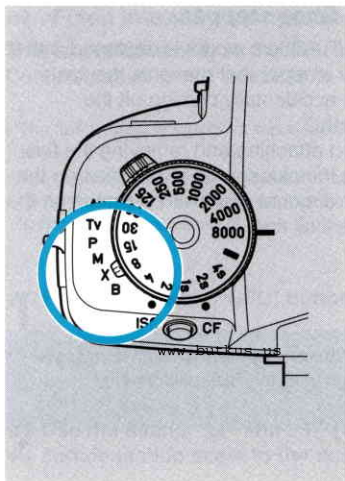

**1** Mount the flash on the camera and set the exposure mode lever to "X".

The shutter speed is set to 1/125 second.

- The shutter speed does not change, regardless of the position of the shutter dial.

**2** Set the aperture and take the picture.

Determine the aperture by following the flash's operating instructions.

- For non-direct contact flashes requiring cords, connect the flash to the synchronization terminal on the side of the camera.



# APPLIED COMMAND DIAL OPERATIONS



The command dial is used to make various settings, including the drive mode, manual setting of the ISO sensitivity, etc. It can also be used as the exposure compensation dial or shutter speed dial.

This may allow you to better concentrate on your shooting and operate the camera quickly without changing your grip or taking your eye away from the viewfinder.

# 1. Using the command dial as the exposure compensation dial

www.butkus.us

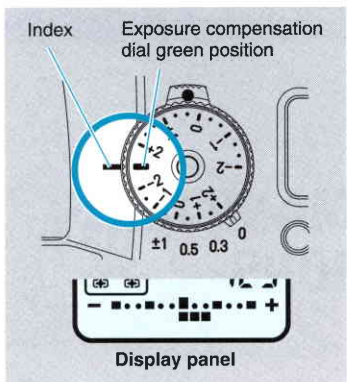

While pressing the exposure compensation dial lock release button, turn the exposure compensation dial and set the green position to the index. When this is done, the exposure compensation scale appears on the display panel and the amount of exposure compensation is set to 1/3 EV steps.

- The exposure compensation amount can be changed to 1/2 EV steps (page 74).

# 2. Using the command dial as the shutter dial

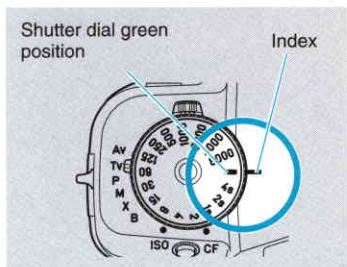

Set the shutter dial's green position to the index.

- The shutter speed can be set to 1/2 Tv steps (page 74).
- To cancel the setting, turn the shutter dial while pressing the shutter dial lock release button.

When both the shutter dial and exposure compensation dial are set to the green position, the command dial operates as follows according to the currently set exposure mode:

When the exposure mode is set to "Tv" or "M" : Shutter speed setting

When the exposure mode is set to "Av" or "P" : Exposure compensation value setting

www.butkus.us



# CUSTOM FUNCTIONS



The functions of this camera can be customized to match your shooting style. As you work with this camera you will develop your own personal approach.

This camera is equipped with the 20 custom functions, shown on the table below. When the camera is first purchased, these are all set to the standard or "default" functions (standard setting number "0"). Note that all the explanations in this manual assume the functions are set to "0" To change the custom functions, refer to "Setting the custom functions" (page 76).

- When the custom functions are set, the camera's functions and operating procedures change. Read this section carefully and be sure to use these features to your best advantage.

## <List of Custom Functions>

Setting number Function no.	Standard setting (0)	Changed setting (1)	Changed setting (2)	Changed setting (3)
① Power hold time	16 sec.	12 sec.	8 sec.	4 sec.
② AE lock by half-pressing the shutter button	No AE lock	AE lock on	—	—
③ Using the exposure check button as AE lock switch	No AE lock	AE lock on	—	—
④ Command dial shutter setting step	1.0 Tv	0.5 Tv	—	—
⑤ Command dial exposure compensation setting step	0.3 EV	0.5 EV	—	—
⑥ Evaluative metering meter display	Difference with average metering	Difference with spot metering	(Not displayed)	—
⑦ Exposure ABC order	Standard → over → under	Over → standard → under	—	—
⑧ Focus ABC compensation range	Depth of field at open aperture of mounted lens	Depth of field at open aperture of mounted lens x 2	—	—
⑨ Focus ABC focus mode	MF	SAF	—	—

Setting number Function no.	Standard setting (0)	Changed setting (1)	Changed setting (2)	Changed setting (3)
⑩ Focus ABC focus far on/off	Focus far on	Focus far off	—	—
⑪ AF supplemental light on/off	On	Off	—	—
⑫ AF focus beep on/off	Focus beep on	Focus beep off	—	—
⑬ Superimpose when shutter button half-pressed	On	Off	—	—
⑭ Superimpose when focused	On	Off	—	—
⑮ Rewind auto return	Auto return off	Auto return on	—	—
⑯ Leave film tip when rewinding	Film tip not left	Film tip left	—	—
⑰ Selection of aperture stop down button operation	Aperture stopped down while pressed	Aperture switches between stopped down and open each time button is pressed	—	—
⑱ Rewind silencing	Normal	Low speed/low noise	—	—
⑲ Focusing screen metering compensation	Compensation off	Compensation on (FX-1)	—	—
⑳ Focus button function in "M" mode	SAF	CAF	—	—

The custom functions (① to ⑳) are all reset to the standard settings.

• Note that if the exposure mode selector lever is set to any position other than "CF" at this time, all the custom functions are reset to the standard settings.

CLE: Resetting of custom functions

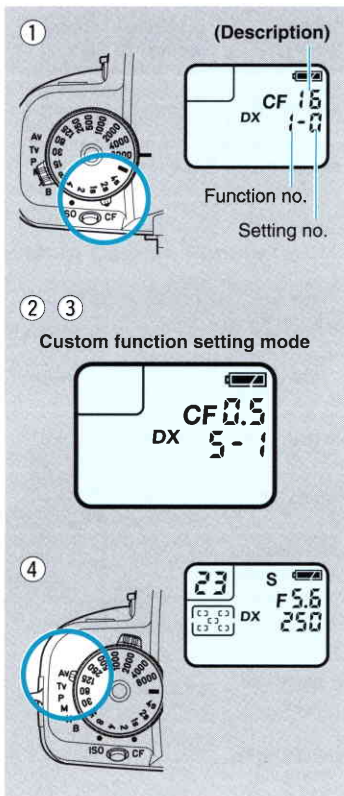

**1** Set the exposure mode lever to “CF”. The function number and setting number appear on the display panel and the camera is set to the custom function setting mode.

**2** Turn the command dial to select the function number.

**3** Press the focus button to select the setting number.

**4** Set the exposure mode lever back to a shooting mode position (any position other than “CF” or “ISO”).

The display panel returns to normal and “CF” turns off.

- To reset all the set custom functions, display “CLE” at step 2 above, then set the exposure mode lever back to an exposure mode position (any position other than “CF” or “ISO”).



# REFERENCE



This section contains reference information on photography and data pertaining to this camera.

## <Exposure>

Exposure is the act of exposing the film to light, thus converting brightness values in a scene to tonal values on film. Exposure is composed of the size of the opening in the lens (the aperture) and the duration of time in which the light passes through the lens to strike the film (the shutter speed.)

## <Shutter speed>

The camera adjusts the amount of light to which the film is exposed by adjusting the length of time in which the shutter is open. The length of time that the shutter is open is called the shutter speed.

## <Aperture value>

The aperture is an opening in the lens. The amount of light passing through the aperture to the film is adjusted by increasing or decreasing the diameter of the opening. The size of this opening is called the aperture value.

## <Film speed or sensitivity (ISO value)>

The film speed indicates the extent to which the film reacts to light, and is expressed as a figure determined by the ISO (International Standardization Organization).

The lower the ISO number, the lower the film's sensitivity to light. Film with a lower sensitivity is suited for achieving photographs with high detail and high picture quality.

The higher the ISO number, the higher the film's sensitivity to light. Film with a high sensitivity reacts to smaller amount of light, so it is suited for taking photographs in dark places with high shutter speeds. However, the resulting photographs have less detail and the color and tonal gradations are less distinct than slower speed film.

## 2. Troubleshooting

If there seems to be a problem, check the following table before assuming the camera is malfunctioning.

Symptom	Cause	Solution	See page ...
1. Nothing appears on the display panel	<ul style="list-style-type: none"><li>• No battery is loaded.</li><li>• Battery is fully spent.</li></ul>	<ul style="list-style-type: none"><li>• Insert battery.</li><li>• Replace the battery with a new one.</li></ul>	13 13
	<ul style="list-style-type: none"><li>• Battery is loaded upside-down.</li></ul>	<ul style="list-style-type: none"><li>• Insert the battery properly.</li></ul>	13
2. Battery mark ("  ") is flashing	<ul style="list-style-type: none"><li>• Battery is spent.</li></ul>	<ul style="list-style-type: none"><li>• Replace the battery with a new one.</li></ul>	13
3. Film counter flashes "00" when film is loaded and camera back is closed	<ul style="list-style-type: none"><li>• Film has not been advanced properly.</li></ul>	<ul style="list-style-type: none"><li>• Reload the film.</li></ul>	18
4. Viewfinder display is not clear	<ul style="list-style-type: none"><li>• Diopter is not properly adjusted.</li></ul>	<ul style="list-style-type: none"><li>• Turn the diopter adjustment dial to adjust.</li></ul>	15
5. Shutter cannot be released	<ul style="list-style-type: none"><li>• Drive mode is set to the self timer mode.</li></ul>	<ul style="list-style-type: none"><li>• Switch to a different drive mode.</li></ul>	23
6. Photographs are blurry	<ul style="list-style-type: none"><li>• Focus is not properly adjusted.</li></ul>	<ul style="list-style-type: none"><li>• Adjust the focus properly.</li></ul>	26
	<ul style="list-style-type: none"><li>• Camera is shaking when shutter button is pressed.</li></ul>	<ul style="list-style-type: none"><li>• Press the shutter button gently so that the camera does not shake.</li></ul>	17
	<ul style="list-style-type: none"><li>• Shutter speed is slow.</li></ul>	<ul style="list-style-type: none"><li>• Use a tripod.</li></ul>	17
7. Exposure compensation mark flashes	<ul style="list-style-type: none"><li>• Exposure compensation is still set.</li></ul>	<ul style="list-style-type: none"><li>• Set the exposure compensation dial back to "0".</li></ul>	48
8. Shutter only released for one frame in Exposure ABC mode	<ul style="list-style-type: none"><li>• Finger is released from shutter button too quickly.</li></ul>	<ul style="list-style-type: none"><li>• Keep the shutter button pressed until all three frames are taken.</li></ul>	50

Symptom	Cause	Solution	See page ...
9. Film counter is flashing (other than "00")	<ul style="list-style-type: none"> <li>Exposure ABC or Focus ABC mode is set.</li> </ul>	<ul style="list-style-type: none"> <li>Set the Exposure ABC lever to "0" or the focus dial to a mode other than Focus ABC.</li> </ul>	36 50
10. Metering mark flashes when shutter button half-pressed	<ul style="list-style-type: none"> <li>Custom function is set to "2-1".</li> </ul>	<ul style="list-style-type: none"> <li>Set the custom function to "2-0".</li> </ul>	74
11. Film counter reads "03" when film is loaded	<ul style="list-style-type: none"> <li>D-10 "all imprint switch" is turned on (when data back is mounted).</li> </ul>	<ul style="list-style-type: none"> <li>Turn the "all imprint switch" off next time film is loaded.</li> </ul>	—
12. Rewinding stops before film is fully rewind	<ul style="list-style-type: none"> <li>Same as above.</li> </ul>	<ul style="list-style-type: none"> <li>Same as above.</li> </ul>	—

\* For symptoms 11 and 12, refer to the operating instructions of the Contax Data back D-10.

### 3. Shutter speed and aperture value display

The shutter speed and aperture value are displayed as described below.

- The shutter speed display indicates shutter speeds between "8000" (1/8000 seconds) and "32" (32 seconds). When the camera's exposure mode is set to "Av" or "P", the shutter speed value with respect to the aperture is displayed in steps of 1/2, and when the exposure mode is set to "Tv" or "M", the set shutter speed value is displayed.

When set to "X", "125" is displayed for the shutter speed.

When set to "B", "buLb" is displayed for the shutter speed.

- The aperture value is displayed in steps of 1/2 within the aperture range of the currently mounted lens. When operating with a precision of greater than 1/2 step, the closest value is displayed. For example, when the aperture is f3.3, the aperture is displayed "3.5".

Shutter speed		Aperture value	
Av or P and when command dial set for Tv or M (0.5 Tv)		When shutter dial set for Tv or M and when command dial set for Tv or M (1 Tv)	All modes
8000	10	8000	45
6000	8	4000	38
4000	6	2000	32
2800	4	1000	27
2000	3	500	22
1400	2	250	19
1000	0" 7	125	16
700	1"	60	13
500	1" 4	30	11
350	2"	15	9.5
250	2" 8	11	8.0
180	4"	8	6.5
125	5" 6	4	5.6
90	8"	2	4.5
60	11"	1"	4.0
45	16"	2"	3.5
30	22"	4"	2.8
20	32"	8"	2.4
15		16"	2.0
		32"	1.7
			1.4
			1.2

- To remove dust and dirt on the lens and viewfinder glass, blow off with an air blower or wipe gently with a soft lens brush. If they are soiled with fingerprints, wipe off lightly with lens tissue. That is enough. Never use a bomb type blower. With its air pressure, dust and dirt may get farther into the camera interior. Wipe off dust and dirt on the mirror lightly with a lens brush.
- To clean the camera exterior, wipe with the soft cloth. Never use benzene, thinner or other solvents.
- After taking pictures in a dusty place such as at the seaside or on mountains, clean the camera thoroughly. Salt air will cause corrosion and sand and dust will adversely affect the internal precision parts of the camera.
- Do not leave the camera in hot places (on an ocean beach in summer, in a parked car under direct sunlight, etc.) for a long time, because the camera, film and battery may be adversely affected.
- The lens and viewfinder may be clouded if the camera is brought into a warm room from outside where it is cold. This cloudiness will disappear soon, but it is always advisable to avoid sudden temperature changes because water droplets will cause internal corrosion.
- If you are going to use the camera for important events such as an overseas trip or wedding ceremony, be sure to test it beforehand to make sure it functions properly. It is also advisable to bring a spare battery with you.
- Because the camera is a precision device, do not expose it to excessive shock such as by dropping, etc.

### **Note on the Shutter Curtain:**

The shutter curtain is made of a very thin material.

Never push it with a finger, or touch or wipe it.

When changing film, take care that the film edge does not touch the shutter curtain.

When using an air blower, do not blow air strongly on the curtain because it may be damaged or deformed.

Never use a pressurized blower.

### **Microcomputer Protection Circuit:**

This camera incorporates a safety circuit to protect its microcomputer against strong external static electricity.

Though rarely, it may fail to function because this safety circuit has come into action. In this case, set the main switch to OFF, remove the batteries, reload them and use the camera again.

### **Caution on use of tripods**

This compact camera is not designed to be mounted on a large tripod with Planer T\*85 mm F1.4, Macro-Planer T\*60 mm F2.8 or other wide diameter lenses attached. When the camera is mounted on such a tripod, the pedestal of the universal head comes into contact with the lens which could render the lens inoperable or even damage it. Attach a separately sold quick shoe adapter between the camera and the tripod to prevent this from happening.

### **About infrared film**

Please note that this camera is not designed to operate with infrared film.

### **<Camera Storage>**

- Keep the camera away from heat, moisture and dust. Do not store it in a wardrobe drawer containing mothballs or in a laboratory where there are chemicals that will cause damage to it.
- If you are not likely to use the camera for an extended period of time, remove the batteries to prevent possible damage by battery leakage.



# MAIN ACCESSORIES



This section describes the main accessories for expanding the range of photographic possibilities.

## 1. LCD viewfinder FE-1

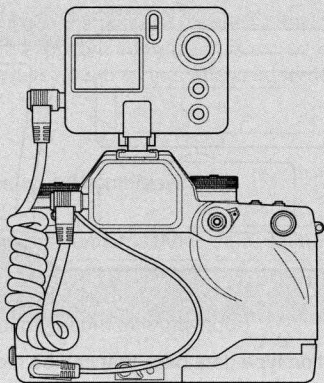

This is a LCD viewfinder that can be mounted on the Contax N1.

It offers the following main functions:

- ① The image and liquid crystal display on the focusing screen in the camera's viewfinder are displayed on the FE-1's LCD panel.
  - ② The LCD panel changes according to the exposure compensation setting.
  - ③ When the camera is set for Exposure ABC compensation, the LCD panel changes according to the compensation for the next exposure.
    - When used together with exposure compensation in ②, the exposure compensation is applied to the display on the LCD panel.
  - ④ When the camera is set to the AE lock mode, the LCD panel changes according to the locked exposure value.
  - ⑤ The display can be switched between color and black & white.
- The brightness range that can be displayed on the LCD panel is narrower than that of the film, so the displayed data is not the same as the film's.

## 2. Contax Data back D-10 (multifunction type) [www.butkus.us](http://www.butkus.us)

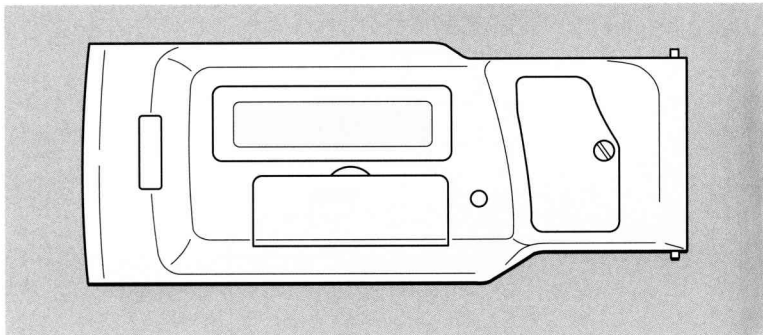

The D-10 is a multifunction type data back that can be mounted in place of the Contax N1's camera back. It offers an "all imprint" function for imprinting all the exposure data on the first two frames of the film. It can also be used with the "between-frame imprint" function for imprinting data such as the date and exposure of the individual frames in the space between the frames. These two functions can be used together. This makes it possible to imprint the exposure data with the "all imprint" function and the date and time or counter number, etc., with the "between-frame imprint" function. This data can be used to classify the photographs and to store and organize the exposure data. The D-10 is also equipped with an interval shooting function.

- Note that the Data back D-10 cannot be used to imprint the data on the photographs.

### <All imprint function>

When this function is chosen the first two frames of the film are left empty. As exposures are made the exposure information is stored in the camera's memory. When the film is rewound all the data is imprinted on the first two frames of the film.

#### ◆ Imprinted data

- ① Date film was loaded (year/month/day/hour)
- ② Camera used - "N1"
- ③ Exposure data (exposure compensation value, shutter speed, aperture and exposure mode)
- ④ Frame number (in sets of 5 frames)
- ⑤ Date film was rewound (year/month/day/hour)

### <Between-frame imprint function>

One of the following modes can be selected to imprint the corresponding data in the space between the frames.

- ① Date (year/month/day)
- ② Date (month/day/year)
- ③ Date (day/month/year)
- ④ Time (day/hours/minutes)
- ⑤ Exposure data: Exposure compensation value, shutter speed, aperture and exposure mode or two characters
- ⑥ Counter number (4-digit accumulated counter + film counter) + two characters
- ⑦ Any fixed 6-digit number + two characters
- ⑧ No data imprinted

### <Interval shooting function>

The D-10 can be used to automatically take a set number of photographs at a set interval, even starting from a set time. This can be used to take photographs to observe changes over time or for unattended shooting.



# Contax Power pack P-8

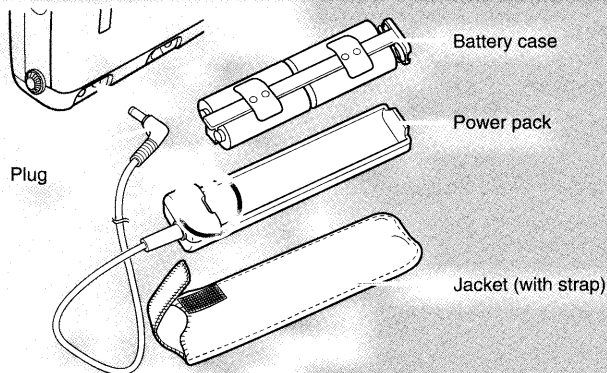

The Power pack P-8 is an external power supply using four 1.5V LR6/AA batteries or four 1.2V LR6/AA Ni-Cd batteries. This pack allows the camera to be used with a remote power supply kept in a warm place. This prevents loss of battery performance due to the influence of cold working conditions.

## <Mounting>

### 1. Load the batteries in the Power pack P-8.

- ① Load the three LR6/AA batteries in the battery case included with the Power pack P-8 in the indicated direction, then attach the battery case to the P-8's main unit.
- ② Place the P-8 main unit inside a jacket (case).

### 2. Connect the plug at the tip of the P-8 cord to the external power socket.

- When shooting, place the power pack in a warm place to improve warmth retention.
- When replacing the batteries, do not mix different types of batteries or old batteries with new ones. Replace all four batteries at the same time with new batteries of the same type.
- When not using the power pack for long periods of time, remove the batteries from the battery case to prevent leakage of battery fluid.
- Handle the plug to disconnect. Do not pull on the cord.

## <Specifications of the P-8>

**Includes** : Power pack (main unit), battery case, jacket (with strap). Cord length: 1.5 meters

**Power supply:** Four 1.5V LR6/AA batteries or four 1.2V LR6/AA nickel hydrogen batteries (LR6/AA manganese batteries have a low capacity, so they cannot be used.)

## <Batteries used and number of photos that can be taken>

- for 36-exposure film at normal temperature using new batteries and based on Contax testing standard.

Batteries used	Rolls of film	
	①	②
Four 1.5V LR6/AA alkaline batteries 4	Approx. 5	Approx. 10
Four 1.5V LR6/AA lithium batteries 4	Approx. 15	Approx. 50
Four 1.2V LR6/AA nickel hydrogen batteries 4	Approx. 2 (*15)	Approx. 5 (*50)

\* Fully charge nickel hydrogen batteries before using them.

### ❖ Figures given for the rolls of film (number of rolls of film that can be taken) are calculated based on the conditions described below.

- ① Drive mode set to "S", using a Vario-Sonnar T\* 24–85 mm lens, with one focusing operation from infinity to close range and back, 1 release, then a 16-second wait for each frame, this operation repeated.
- ② Drive mode set to "S", using a Vario-Sonnar T\* 24–85 mm lens, with one focusing operation from infinity to close range and back, 1 release, then a 4-second wait for each frame, this operation repeated.

- For some batteries, the voltage may temporarily drop and the "☐" mark light or flash when the batteries are first loaded. This is due to the properties of the batteries. If this should happen, try turning the main switch off then back on. If the "☐" mark lights, the camera can be used normally.
- When using LR6/AA nickel hydrogen batteries (1.2V), the "☐" mark will light or start flashing relatively early. This is due to the properties of such batteries. If this happens, however, you may continue to use the camera. The approximate number of rolls of film that can be taken in this case under the above conditions is the number within parentheses.

\* Please note that specifications and design are subject to change without notice.

## 4. Contax Cable switch LA type

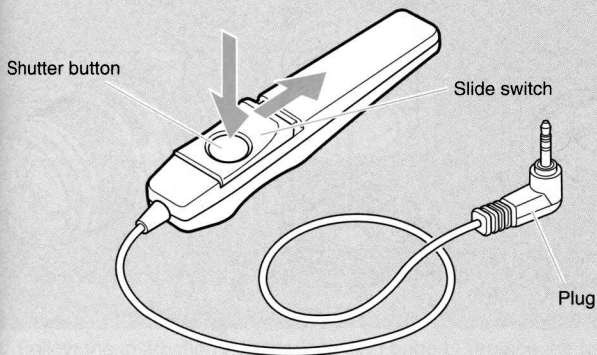

The Cable switch LA type can be used for close-up or telephoto photography when using a tripod or to release the shutter remotely from the camera. It is especially suited for close-up or telephoto photography because it eliminates the risk of camera shake when the shutter is released.

Photographs are taken using the cable switch's shutter button (which also has a half-press function). The slide switch offers convenience for extended exposures and continuous shooting.

The cord length is 50 cm for the LA-50, 5 meters for the LA-500.

### <Attaching>

Insert the cable switch's plug into the camera's cable switch socket.

### <Taking photographs>

The cable switch's shutter button functions in the same way as the camera's shutter button. Half-press it to measure the distance or light or to lock the focus, press it all the way in to release the shutter.

When taking long-time exposures or using continuous advance, use the slide switch for convenience. The shutter operates continuously when the slide switch is pulled forward (when the red mark is visible), and closes (exposure stops) when the switch is set back to its original position.

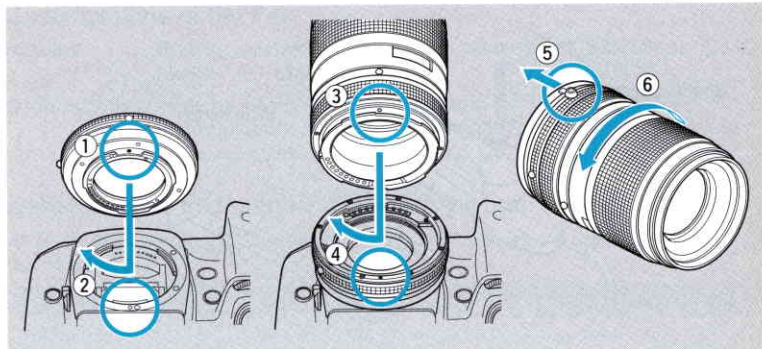

The Mount adapter NAM-1 allows Contax 645 system lenses to be used on the Contax N1. When mounted, the lenses can be used except in the Focus ABC mode and with some other functions.

- When using a Contax TLA360 flash, the focal distance set for the flash changes for the lenses below, but this presents no problem with respect to luminous intensity distribution characteristics.

Lens	Flash setting
① Distagon T *f/2.8–45mm	50 mm
② Planar T *f/2–80mm	85 mm

### <Mounting the mount adapter and lens>

1. Line up the body mount mark ① on the mount adapter with the camera's lens mark ②. Insert, then turn in the direction of the arrow to mount.
2. Line up the mark on the lens (red) ③ with the lens mount mark on the adapter ④, then turn in the direction of the arrow to mount.

### <Removing>

1. To remove the lens, slide the mount adapter's release button ⑤, hold it there, then turn the lens counterclockwise ⑥ and remove it.
2. To remove the mount adapter, turn it counterclockwise while pressing the camera's lens release button.

## 6. Focusing screens FX type

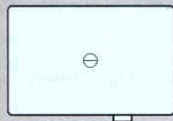

**FX-1**



**FX-2**

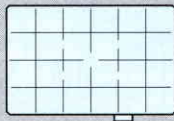

**FX-3**

Three types of FX focusing screens (FX-1 to FX-3) are available for use on the N1. Follow the instructions on the following page to replace the focusing screen. (The focusing frames are not printed on the focusing screens.)

• The focusing screens are high precision parts. Never touch them directly.

### ◆ **FX-1 (horizontal split image type)**

The FX-1 allows manual focusing with two parts: the split image at the center and on the matte section.

### ◆ **FX-2 (full screen matte type)**

The FX-2 is included with the camera as standard. It is a screen with the entire surface in matte form and is suited for general photography.

### ◆ **FX-3 (grid matte type)**

The FX-3 is a full surface type screen with a grid. It is often used as a compositional aid and is also suited for precise framing of copy material.

• Metering compensation is required when using the FX-1. Set the custom functions to "19-1". (Page 75)

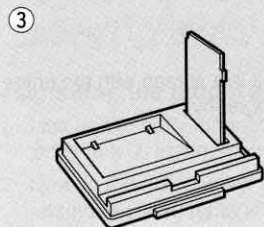
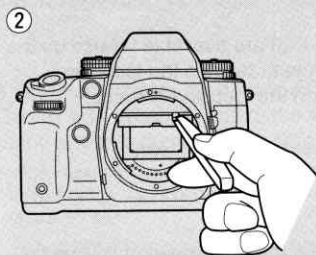
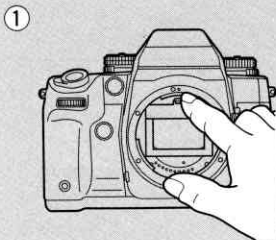

## <Replacing the focusing screen>

- The screens include tweezers for use when replacing them. Be sure to use the included tweezers.

Replace the screen as described below.

### 1. Removing a screen

**1** Remove the lens, then gently press on the camera's screen replacement pawl with the tip of your finger, etc.

The screen lowers together with its frame. Lower it gently.

**2** Use the tweezers included with the screen to grasp the projecting part of the screen and remove it.

**3** After removing the screen, place it vertically in the groove in the case to protect it from dirt and scratches.

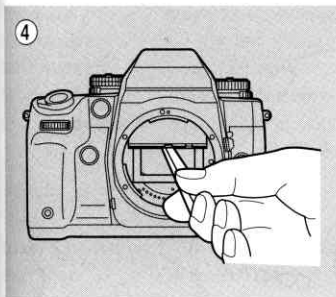

## 2. Mounting a screen

**4** Grasp the projecting part of the screen to be mounted using the tweezers included with the screen and place it in the lowered frame, then gently lift the projecting part of the frame (the replacement claw) with the tweezers until a click is heard and it stops.

Finally, press gently with a finger to check that it is securely mounted.

- Be sure to use the included tweezers when replacing the focusing screen. Be careful not to scratch or get fingerprints on the surface of the mirror or screen.
- If there is dirt on the screen, use a blower to blow it off or gently wipe it off using a lens brush.
- If the focusing screen is not properly mounted, it may fall off and break while using the camera or make it impossible to remove the lens. Fixing this requires special procedures. If this happens, take the camera to your nearest service station.
- When not using a screen, store it in the screen case as illustrated.

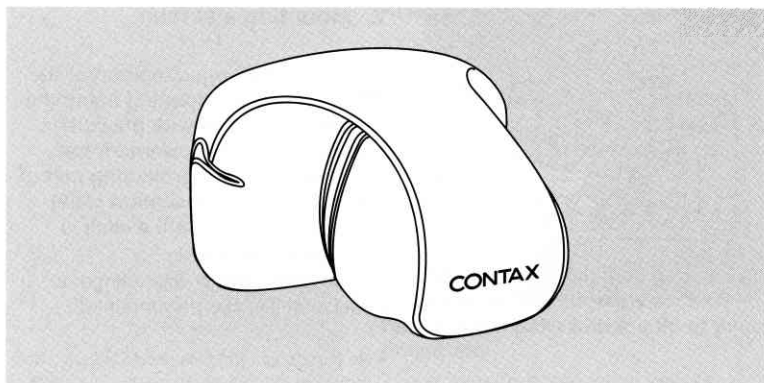

By extending or contracting the tip of the case, the N1 can be placed in the case with the Data back D-10 and the following Carl Zeiss T\* lenses mounted:

<b>Case</b>	<b>Lens (with 1 filter and lens cap)</b>
Contracted	P50/1.4 (N mount) VS24-85 (N mount)
Extended	MP100 (N mount) VS70-300 (N mount)

## main Specifications

- Type:** 35 mm focal plane type AF/AE single lens reflex camera
- Picture size:** 24 × 36 mm
- Lens mount:** Contax N mount
- Shutter type:** Vertical travel focal plane shutter
- Shutter speed:** Av and P: 32 to 1/8000 sec.  
Tv and M: Shutter dial setting ..... 4 to 1/8000 sec.  
Tv and M: Command dial setting ..... 32 to 1/8000 sec.  
B: Bulb  
X: 1/125 sec.
- Direct X contact:** 1/250 sec. or less, direct contact and synchronization terminal included
- Self timer:** Electronic type, 2 or 10 sec. delay
- Shutter release:** Electronic magnetic release type, provided with cable switch socket
- Exposure control:** ① Aperture priority auto ② Shutter priority auto ③ Program auto  
④ Manual exposure ⑤ TTL auto flash
- Metering system:** TTL evaluative metering/Center-weighted average metering/spot metering selectable
- Metering range (ISO 100, F1.4):**  
Evaluative metering : EV 0 to 21  
Average metering : EV 0 to 21  
Spot metering : EV 3 to 21
- Film speed range:** With DX code : ISO 25 to 5000  
Manual setting : ISO 6 to 6400
- AE lock:** Exposure value memory
- Exposure compensation:** +2 EV to -2 EV (In steps of 1/3 or 1/2)
- Exposure ABC mode:** Automatic exposure compensation in three steps, compensation range ±0.3 EV, ±0.5 EV or ±1 EV
- Automatic flash intensity adjustment method:** TTL direct metering on film plane
- Flash synchronization:** Automatic setting of shutter speed with dedicated Contax TLA flashes
- Second curtain synchronization:** Possible with a dedicated Contax flashes
- Auto Focus:** 5-point TTL phase difference detection type
- Focus ABC mode:** Automatic focus compensation in three steps
- Viewfinder:** Pentaprism eye-level type (long-eye point type)  
Field of view ..... 95%  
Magnification ..... 0.73 x  
(with 50 mm standard lens at infinity, -1D, eyepiece shutter included)
- Diopter correction:** Built-in diopter adjuster, correctable range -3D to +1D (two FM diopter lens types sold separately)

- Focusing screen:** Full matte type (standard), interchangeable (FX types)  
Screen replaceable (FX type)
- Viewfinder display:** Focus frame, Exposure ABC mark, Focus ABC mark, film counter, self timer, Exposure ABC/Focus ABC shooting order, multiple exposure number, film loading status, metering mark, flash mark, focus indicator, aperture value, shutter speed, exposure meter/compensation value/metering difference, compensation mark, manual exposure mark
- Display panel:** Film counter, self-timer remaining time, Exposure ABC/Focus ABC shooting order, multiple exposure number, bulb time, film loading status, Focus frame selection indicator, compensation value, shutter speed, film speed, custom function, DX/ISO mark, aperture value, CF mark, battery mark, self timer (2/10 sec.) mark, continuous shooting mark, single frame shooting mark, multiple exposure shooting mark
- Film loading:** Auto loading type with automatic to first frame
- Film advance:** Automatic with built-in motor
- Film rewind:** Automatic with built-in motor (with auto return/auto stop function), mid-roll rewinding possible
- Drive modes:** Single frame, continuous, 2/10 sec. self timer
- Winding speed:** Max. Approx. 3.5 frames/sec. continuous shooting ("C") mode (using a new battery, at normal temperature, based on Contax testing standard)
- Film counter:** Auto reset additive type for display panel and viewfinder
- Accessory shoe:** Direct X contact (with TLA flash interlocking contacts)
- Custom functions:** See list of custom functions on page 74.
- Camera Back:** Opened and closed with camera back opening knob, detachable, film check window included
- Battery:** One 6V lithium battery (2CR5)
- Battery check:** Auto checking, indicated on display panel
- Number of films shootable:**  
Approx. 20 at normal temperature (+20°C), approx. 5 at low temperature (-10°C) (using 36-exposure film, new batteries, drive mode set to "S", a Vario-Sonnar T\* 24-85 mm lens, with one focusing operation from infinity to close range and back, 1 release, then a 16-second wait for each exposure, this operation repeated)  
Approx. 50 at normal temperature (+20°C), approx. 10 at low temperature (-10°C) (using 36-exposure film, new batteries, drive mode set to "S", a Vario-Sonnar T\* 24-85 mm lens, with one focusing operation from infinity to close range and back, 1 release, then a 4-second wait for each exposure, this operation repeated)

**Others:** Exposure check button, aperture stop-down button,  
AF supplemental light

**Dimensions and weight:** 152 (width) × 116.5 (height) × 69 (depth) mm  
795 g (not including battery)

\* Note that specifications and design are subject to change without notice. In order to take full advantage of the functions of this product, we recommend using Carl Zeiss interchangeable lenses and Contax accessories. Contax warranties do not cover accidents or damage resulting from the use of products of other manufacturers, even when such products are sold for use with Contax products.