



LEICA D-LUX 8

INSTRUCTION MANUAL

FOREWORD

Dear Customer,

We wish you a great deal of fun and success taking photographs with your new Leica D-Lux 8. Please read this manual thoroughly to familiarize yourself with the full scope of functions your camera has to offer. You can find all information about the Leica D-Lux 8 whenever you need it at <https://leica-camera.com>.

Your Leica Camera AG

SCOPE OF DELIVERY

Before using your camera for the first time, please check that the accessories supplied are complete*.

- Leica D-Lux 8
- Lithium-ion battery (Leica BP-DC15)
- Flash unit
- Lens cap with safety tie
- Hand strap
- Quick Start Guide

* Subject to change with regard to construction and appearance.

REPLACEMENT PARTS / ACCESSORIES

Please contact Leica Customer Care or visit the Leica Camera AG website for information on the extensive range of Leica replacement parts/accessories:

<https://leica-camera.com/en-US/photography/accessories>

Only the accessories specified and described in this manual or by Leica Camera AG must be used with the camera (battery, charger, mains plug, mains cable, etc.). These accessories must only be used with this product. Third-party accessories may result in malfunctions or damage to the product.

Please read the chapters “Legal information”, “Safety remarks”, and “General information” before using your camera for the first time.

Knowledge of the content will prevent inadvertent damage to the product, possible injuries and other risks.

LEGAL INFORMATION

COPYRIGHT NOTICE

- Compliance with copyright laws is mandatory. The recording and publication of pre-recorded media like tapes, CDs, or other published or broadcast material may breach copyright laws. The same applies for all software supplied as part of the scope of delivery.
- The following applies for all video material created with this camera: This product is governed by the AVC Patent Portfolio license and is meant for private use by a consumer only. The device may furthermore be used for purposes for which the consumer receives no remuneration, e.g. (i) encoding in accordance with the AVC Standard ("AVC Video") and/or (ii) decoding of AVC Video that was encoded by a consumer in accordance with the AVC Standard within the scope of personal use and/or which the consumer has received from the provider, who is in possession of a license to offer AVC Video. No license is granted or implied for any other use. Any other use, specifically the provision of AVC video in exchange for remuneration, may require a separate license agreement with MPEG LA, L.L.C. Please visit the MPEG LA, L.L.C. website at: www.mpegla.com for more information.
- The designations SD, SDHC, SDXC, microSDHC and their associated logos are registered trademarks of SD-3C, LLC.

LEGAL INFORMATION ABOUT THIS MANUAL

COPYRIGHT

All rights reserved.

All text, images and graphics are subject to copyright and other laws to protect intellectual property. They must not be copied, modified or used for any purpose including trade purposes.

TECHNICAL DATA

Product changes with regards to the products or services may occur after the editorial deadline. The manufacturer reserves the right to effect structural or shape changes, color deviations and changes to the scope of delivery or service, where these changes or deviations are reasonably acceptable for the customer, while taking into consideration the interests of Leica Camera AG. To that extent, Leica Camera AG reserves the right to changes and errors. The images in this manual may depict accessory, special features or other items that are not part of the standard scope of delivery or service. Some pages may contain model types and services, which are not offered in specific countries.

BRANDS AND LOGOS

The brand names and logos used in this document are protected trademarks. These brands or logos must not be used without prior approval by Leica Camera AG.

LICENSE RIGHTS

Leica Camera AG intends to provide you with innovative and informative documentation. Due to the amount of creativity that has gone into its design, we ask for your understanding that Leica Camera AG must protect its intellectual property, including patents, trademarks and copyrights, and that possession of the documentation does not infer any licensing rights of the intellectual property of Leica Camera AG.

REGULATORY INFORMATION

You will find the manufacturing date of your camera on the stickers in the Warranty Card and/or on the packaging.

The date format is year/month/day.

COUNTRY-SPECIFIC LICENSES

Specific regional approvals for this device can be found in the camera menu.

- Select **Camera Information** in the main menu
- Select **Regulatory Information**

LICENSE INFORMATION

The device-specific license information can be found in the camera menu.

- Select **Camera Information** in the main menu
- Select **License Information**

CE MARK

The CE mark on our products documents compliance with the fundamental requirements of applicable EU guidelines.

English

Declaration of Conformity (DoC)

"Leica Camera AG" hereby declares that this product is in compliance with the basic requirements and other relevant provisions of Directive 2014/53/EU.

Customers can download a copy of the original DoC for our Radio Equipment products from our DoC server:

<https://cert.leica-camera.com>

Please contact Leica Camera AG, Am Leitz-Park 5, 35578 Wetzlar, Germany in case of any further questions

Usable frequency band/ Usage limitations:

see technical data

DISPOSAL OF ELECTRICAL AND ELECTRONIC EQUIPMENT

(Applies within the EU and for other European countries with active waste separation policies.)



This device contains electrical and/or electronic components which must not be disposed of in general household waste. Instead, it should be disposed of at a recycling collection point provided by your local authority.

This service is free of charge. Any standard or rechargeable batteries used in this device must be removed and disposed of separately in accordance with local regulations.

Please contact your local authorities, waste disposal collection point or the retailer, from whom you purchased the device for more information on correct waste disposal.

IMPORTANT NOTES REGARDING THE USE OF WLAN/BLUETOOTH®

- Appropriate measures must be taken to ensure security and protect against disruptions to the systems in place where devices or computer systems are in use that require more stringent security than WLAN devices.
 - Leica Camera AG shall not accept liability for damages arising from the use of the camera for purposes other than as a WLAN device.
 - It is assumed that the WLAN function will be used in countries where this camera is sold. There may be a risk of breaching statutory wireless communication regulations when using the camera in other countries. Leica Camera AG shall not accept liability for such breaches.
 - Please note that there is a risk of unauthorized third party interception of wirelessly communicated data. We highly recommend that you activate encryption in the wireless access point settings to ensure data safety.
 - Avoid using the camera in areas where it can be exposed to magnetic fields, static electricity or other interferences, e.g. near a microwave oven. RF transmissions may otherwise not reach the camera.
 - Using the camera near devices like microwave ovens or wireless phones that use the 2.4 GHz RF band may negatively affect the performance of both devices.
 - Do not attempt to connect to wireless networks you are not authorized to use.
 - The device will automatically search for wireless networks, once the WLAN function is enabled. A list, including networks you are not authorized to access, will be displayed (SSID: Network identifier for a WLAN network). Do not attempt to connect to third party network, as this could be construed as unauthorized access.
- We recommend disabling the WLAN function while on an aircraft.
 - The use of the WLAN-RF band between 5150 MHz and 5350 MHz is permitted only in enclosed spaces.
 - Please read the important notes on specific functions of Leica FOTOS on p.190.

SAFETY REMARKS

GENERAL INFORMATION

- Do not use your camera in the immediate vicinity of devices that generate powerful magnetic, electrostatic or electromagnetic fields (e.g. induction ovens, microwave ovens, television sets or computer screens, video game consoles, cell phones, broadcasting equipment). Their electromagnetic fields can interfere with image capturing.
- Strong magnetic fields, e.g. from speakers or large electric motors can damage the stored data or disrupt shooting.
- Switch off the camera, remove the battery briefly, replace it and switch the camera back on in case of a camera malfunction due to the effects of electromagnetic fields.
- Do not use the camera in the immediate vicinity of radio transmitters or high-voltage power lines. Their electromagnetic fields may also interfere with image capturing.
- Always store small parts e.g. the accessory shoe cover as follows:
 - out of the reach of children
 - in a safe location, where they will not get lost or stolen
- State-of-the-art electronic components are sensitive to static discharge. You can easily pick up charges of several 10,000 volts by simply walking on synthetic floor coverings. A static discharge can occur when you touch the camera and especially if it is placed on a conductive surface. A static discharge on the camera housing poses no risk for the electronics. Despite built-in safety circuits, you should avoid direct contact with external camera contacts like those in the flash shoe.

- Take care not to soil or scratch the sensor for lens detection in the bayonet. You must similarly prevent direct contact of the bayonet with grains of sand or similar particles, as these could cause irreparable damage. This component must only be cleaned with a dry cloth (in system cameras).
- Use a cotton or linen cloth instead of a microfiber cloth from an optician's (synthetic) when cleaning the contacts. Make sure to discharge any electrostatic charge by deliberately touching a heating or water pipe (conductive, grounded material). Dirt deposits and oxidation on the contacts can be avoided by storing your camera in a dry location with the lens cap and the flash shoe/viewfinder cap (in system cameras) attached.
- Only use accessories specified for this model to prevent faults, short circuits or electric shock.
- Do not attempt to remove parts of the housing (covers) yourself. Repairs must be done at authorized service centers only.
- Protect the camera against contact with insect sprays and other aggressive chemicals. Petroleum spirit, thinner and alcohol must not be used for cleaning. Some chemicals and liquids can damage the camera housing or the surface finish.
- Rubber and plastics are known to expel aggressive chemicals and should therefore not be kept in contact with the camera for extended periods of time.
- Prevent any sand or dust or water penetration into the camera, e.g. during snowfall or rain or on the beach. Be extra careful when changing the lens (in system cameras) and when inserting or removing the memory card and rechargeable battery. Sand and dust can damage the camera, the lens, the memory card and the battery. Moisture can cause malfunctions and irreparable damage to the camera and memory card.

LENS

- A camera lens can have the effect of a magnifying glass when exposed to direct frontal sunlight. The camera must therefore be protected against extended exposure to direct sunlight.
- Attaching the lens cap and keeping the camera in the shade or ideally in its camera case, will help prevent damage to the interior of the camera.

RECHARGEABLE BATTERY

- Improper use of the batteries or the use of unapproved battery types may result in an explosion!
- Do not expose the rechargeable battery to sunlight, heat, humidity or moisture for prolonged periods of time. Likewise, the batteries must not be placed in a microwave oven or a high-pressure container as this would pose a fire or explosion hazard!
- Do not under any circumstances charge or insert a damp or wet battery into the camera!
- A safety valve in the battery ensures that any excess pressure caused by improper handling is discharged safely. It is nevertheless important to dispose of a bloated battery immediately. It may pose an explosion hazard!
- Keep the battery contacts clean and easily accessible. Although lithium-ion batteries are secured against short circuits, they should still be protected against contact with metal objects like paper clips or jewelry. A short-circuited battery can get very hot and cause severe burns.
- When a battery is accidentally dropped, make sure to check the housing and the contacts immediately for any damage. A damaged battery can damage the camera.
- The battery must be removed from the camera or charger and must be replaced immediately in case of a strange smell, discoloration, deformation, over-

heating or leakage. Continued use of the battery may result in overheating, which can cause fire and/or explosion!

- Never throw batteries into a fire as they may explode.
- Keep the battery away from sources of heat in case of leakage or if you smell burning. Leaked fluid can catch fire!
- The use of other chargers not approved by Leica Camera AG can cause damage to the batteries – and in extreme cases – cause serious or life-threatening injuries.
- Make sure that the power socket is freely accessible at all times.
- Do not attempt to open the battery or the charger. Repairs must only be carried out by authorized workshops.
- Keep batteries out of the reach of children. Batteries can cause suffocation when swallowed.

FIRST AID

- Battery fluid may cause blindness if it comes into contact with the eyes. Rinse the eyes thoroughly with clean water immediately. Avoid rubbing. Seek medical attention immediately.
- Leaked battery fluid poses an injury hazard when it comes in contact with clothing or skin. Rinse the affected areas thoroughly with clean water.

CHARGER

- Using the charger in the vicinity of broadcasting receivers may interfere with reception. Ensure a distance of at least 1 m between the charger and the receiver.
- When the charger is in use, it may emit a buzzing sound – that is normal and not a malfunction.

- Disconnect the charger from the mains when it is not in use, as it consumes electricity (a very small amount), even if no battery is inserted.
- Always keep the charger contacts clean, and never short-circuit them.
- Only the mains cables supplied must be used. The mains cables must only be used for the supplied charger unit. Do not attempt to use the mains cable or charger unit for other purposes.

MEMORY CARD

- Never remove the memory card during a data save or card reading process. The camera must not be switched off or be subjected to impact or vibrations while working.
- Do not open the cover/remove the memory card or the battery from the camera while the status LED is lit, which indicates memory access. Data on the card may otherwise be destroyed and camera malfunctions may occur.
- Do not drop or bend memory cards as this will cause damage and result in the loss of stored data.
- Do not touch the connections on the reverse of the memory card and keep them clean and dry.
- Keep memory cards out of the reach of children. Swallowing a memory card may cause suffocation.

SENSOR

- Cosmic radiation (e.g. during flights) may cause pixel defects.

CARRY STRAP

- Carry straps are usually made of very robust material. You should therefore keep it out of the reach of children. A carry strap is not a toy and poses a strangulation risk.

- Use the carry strap only for its intended purpose on a camera or on binoculars. Any other use poses the risk of injury and may possibly result in damage to the carry strap and is therefore not permitted.
- Carry straps should also not be used for cameras/binoculars during sports activities that pose a risk of entanglement (e.g. when mountain climbing and similar outdoor activities).

TRIPOD

- When using a tripod, make sure it is standing securely and turn the camera only by turning the tripod, not the actual camera. Ensure that the tripod screw is hand-tightened only. Avoid transporting the camera while the tripod is attached. You might injure yourself or others, and the camera could suffer damage.

FLASH

- The use of incompatible flash units with your Leica D-Lux 8 may result in irreparable damage to the camera and/or the flash unit.

IMPORTANT NOTES ON CHARGING VIA USB

- Use a switching adapter with a max. 100 W output or less, which complies with the USB-PD standard. Ensure compliance with the safety standards IEC62368-1 (ES1, PS2-compliant – 60V or less, 100 W or less). Contact the manufacturer of the switching adapter if you are not sure that it complies with the safety standards.

GENERAL INFORMATION

Please read the section about “Care/Storage” for more information about what to do in case of problems.

CAMERA/LENS

- Make a note of the serial numbers of your camera and lenses, as this information will be extremely important in case of loss.
- Depending on model, you will find the serial number of your camera on the flash shoe or engraved in the underside of the camera.
- Never store the camera bayonet cover or the lens back cover in a pants pocket, as they will attract lint and dust, which could then be accidentally introduced into the camera.

LCD PANEL

- Condensation may form on the LCD panel if the camera is exposed to great temperature fluctuations. Wipe the screen carefully with a soft, dry cloth.
- The screen image will initially be slightly darker than normal if the camera is very cold when it is switched on. The normal level of brightness will be reached as soon as the LCD panel warms up.

RECHARGEABLE BATTERY

- The rechargeable battery must only be charged within a specific temperature range. See chapter “Technical Data” (p. 208) for details about operating conditions.
- Lithium-ion batteries can be charged at any time, regardless of their current charge level. A partially charged battery will charge to full capacity faster than a fully discharged one.
- The rechargeable batteries come only partly charged ex works and should therefore be charged fully before their first use.

- A new battery only reaches its full capacity after it has been fully charged and – by using it in the camera – depleted 2 to 3 times. This depletion process should be repeated roughly every 25 cycles.
- Battery and charger heat up during the charging process. That is normal and not a malfunction.
- Rapid flashing of the LED (> 2 Hz) when charging commences indicates a charging error (e.g. maximum charging time exceeded, voltages or temperatures outside permitted ranges or a short circuit). Disconnect the charger from the mains and remove the battery. Ensure that the above temperature conditions are met and then restart the charging process. Please contact your dealer, the Leica representative in your region or Leica Camera AG if the problem persists.
- Rechargeable lithium-ion batteries generate power by way of internal chemical reactions. These reactions are influenced by ambient temperature and humidity. Do not expose the battery to extreme temperatures (high or low) for extended periods of time (e.g. in a parked car in the summer or winter) to ensure a maximum service life.
- However, every battery has its limits – even in optimal conditions! After several hundred charging cycles, the operating times will get significantly shorter.
- The replaceable battery supplies power to a backup battery, which is permanently installed in the camera. This backup battery retains the date and time for some weeks. Once the backup battery is depleted, it must be replenished by inserting a charged main battery. The time and date will have to be set again after a full depletion of both batteries.
- As the battery capacity deteriorates or if using an older battery, warning messages may appear and some functions may be restricted or blocked entirely.
- Always remove the battery if the camera will not be used for an extended period of time. Make sure to switch the camera off via the main switch before removing the battery. Leaving the battery in the cam-

era will result in a deep discharge after a few weeks. Voltage levels will decrease significantly, as the camera uses a low idle current to maintain settings.

- Dispose of damaged batteries in accordance with the relevant regulations at an approved collection point for proper recycling.
- The date of manufacture can be found on the battery. The date format is week/year.

MEMORY CARD

- The range of available SD/SDHC/SDXC cards on the market is too extensive for Leica Camera AG to test for compatibility and quality. Generally, any type of memory card may be used without any damage to the camera or memory card. As some “no name” cards may not fully comply with the SD/SDHC/SDXC standards, Leica Camera AG cannot provide any guarantee of function.
- We recommend formatting the memory card from time to time, as fragmented residual data from deleted files may block some of the storage capacity.
- Generally, it is not necessary to format (initialize) memory cards that have been previously used. Formatting will, however, be necessary if you insert an unformatted memory card or a card that was formatted in another device (e.g. a computer) for the first time.
- We recommend backing up your data on a PC, because electromagnetic fields, static electricity and any damage to the memory card or camera defects may result in irretrievable damage or loss of your data.
- SD, SDHC, and SDXC memory cards come with a write protection slider to prevent accidental overwriting. This slider is located on the non-beveled side of the card. All data on the card is protected when the slider is set to its lower position, marked LOCK.

- All data stored on the memory card will be lost during formatting. Formatting will not be prevented by a deletion protection set for individual shots.

SENSOR

- Depending on particle size, any dust or dirt particles adhering to the sensor glass may result in noticeable dark spots or blemishes in recordings (in system cameras). Alternatively, send your camera to the Leica Customer Care department for sensor cleaning (see p. 214). This service is not part of the warranty offering and will therefore incur charges.

DATA

- All data, including personal information, may be changed or deleted due to incorrect or accidental operation, static discharge, accidents, malfunctions, repairs and other measures.
- Please note that Leica Camera AG does NOT accept liability for direct or consequential damage due to the manipulation or destruction of data and personal information.

FIRMWARE UPDATE

Leica is continuously working on the further improvement and optimization of Leica D-Lux 8. As digital cameras have many functions that are controlled electronically, improvements and enhancements to the functions can be installed on the camera retroactively. Leica releases so-called firmware updates at irregular intervals. Cameras are always supplied ex works with the latest firmware installed or you can download the latest version from our website yourself and transfer it to your camera.

You will receive a newsletter informing you of the availability of a new firmware update if you register your camera on the Leica Camera homepage.

Visit the download section or the "Customer Area" for information about how to register or how to get firmware updates for your Leica D-Lux 8. Additionally, you can find information about changes or additions to the manual at: <https://club.leica-camera.com>

WARRANTY TERMS LEICA CAMERA AG

Dear Leica Customer, congratulations on the purchase of your new Leica product – you are now the proud owner of a world-class brand product. In addition to your statutory warranty claims against your seller, we, Leica Camera AG ("LEICA"), grant you voluntary warranty services for your Leica product in accordance with the following stipulations ("Leica Warranty"). The Leica warranty therefore does not limit your statutory rights as a consumer under applicable law or your rights as a consumer against the dealer with whom you have concluded the purchase contract.

LEICA WARRANTY

You have purchased a Leica product that has been manufactured according to special quality guidelines and tested by experienced specialists during the various stages of production. We provide the following Leica Warranty, valid as of April 1, 2023, for this Leica product and including the accessory parts in the original packaging. Please note that we do not offer any warranty for commercial use.

We offer an extended warranty for some Leica products, provided you register for a Leica account. Please visit www.leica-camera.com for more details.

LEICA WARRANTY SCOPE

During the warranty period, complaints based on manufacturing and material defects will be remedied free of charge, at LEICA's discretion, by way of repair, replacement of defective parts, or exchange for a similar Leica product in perfect condition. Replaced parts or products become the property of LEICA.

Further claims of any kind and on any legal grounds whatsoever in connection with this Leica Warranty are excluded.

EXCLUDED FROM THE LEICA WARRANTY

Parts subject to wear and tear (e.g. eyecups, leather coverings, carry straps, armoring, batteries), and parts under mechanical stress are excluded from the Leica Warranty, unless the defect was caused by manufacturing or material defects. That also applies to any exterior damage.

VOIDED CLAIMS UNDER LEICA WARRANTY

Claims under the warranty are void if the defect in question is due to improper handling; they may also be void if e.g. third-party accessories have been used, the Leica product has not been opened professionally or has not been repaired professionally. Claims for warranty services shall similarly be void if the serial number is unrecognizable.

CLAIMS UNDER THE LEICA WARRANTY

We require a copy of the proof of purchase of your Leica product from a LEICA-authorized dealer ("Authorized Leica Dealer") before we can accept any claim under the warranty. The purchase receipt must show the date of purchase, the Leica product with its article number and serial number, and details of the Authorized Leica Dealer. We reserve the right to request the original receipt. Alternatively, you may send us a copy of the warranty card; please note that the Warranty Card must be filled out correctly, and the product must have been purchased from an Authorized Leica Dealer.

Please send your Leica product with a copy of your purchase receipt or the Warranty Card alongside a description of the issue.

Leica Camera AG, Customer Care, Am Leitz-Park 5, 35578 Wetzlar, Germany

Email: customer.care@leica-camera.com

Phone: +49(0)6441 2080-189

or to an Authorized Leica Dealer.

Leica Product Image	Warranty Term
all products	2 years

TABLE OF CONTENTS

FOREWORD.....	2
SCOPE OF DELIVERY.....	2
REPLACEMENT PARTS / ACCESSORIES.....	3
LEGAL INFORMATION.....	4
SAFETY REMARKS.....	8
GENERAL INFORMATION.....	12
WARRANTY TERMS LEICA CAMERA AG.....	15
TABLE OF CONTENTS.....	16
PART DESIGNATIONS.....	22
DISPLAYS.....	24
PHOTO	24
VIDEO	26
PREPARATION.....	28
ATTACHING THE SAFETY CORD.....	28
ATTACHING THE HAND STRAP.....	28
CHARGING VIA USB.....	29
INSERTING/REMOVING THE BATTERY.....	29
INSERTING/REMOVING THE MEMORY CARD.....	30
DIOPTR SETTINGS.....	32
CAMERA OPERATION.....	34
CONTROL ELEMENTS	34
MAIN SWITCH.....	34
SHUTTER BUTTON.....	35
ZOOM LEVER.....	36
SHUTTER-SPEED DIAL.....	36
THUMBWHEEL.....	37
THUMBWHEEL BUTTON.....	37
DIRECTIONAL PAD/CENTER BUTTON.....	38
PLAY BUTTON/MENU BUTTON.....	38
LCD PANEL.....	39
FUNCTION BUTTONS.....	40
LCD PANEL (TOUCH SCREEN).....	41
MENU CONTROL	42

CONTROL ELEMENTS	42
MENU SECTIONS	42
SETTINGS IN PHOTO AND VIDEO MODE.....	43
SWITCHING MENU SECTIONS.....	44
STATUS SCREEN	45
MAIN MENU	47
MENU NAVIGATION	48
SUBMENU	50
KEYBOARD/NUMBER PAD.....	50
MENU BAR.....	51
SCALE MENU.....	51
DATE/TIME MENU.....	52
COMBI MENU (IMAGE PROPERTIES).....	52
USER-DEFINED OPERATION	54
DIRECT ACCESS TO MENU FUNCTIONS.....	54
USER PROFILES.....	55
CAMERA BASIC SETTINGS.....	58
MENU LANGUAGE	58
DATE/TIME	58
POWER SAVE MODE (STANDBY MODE)	59
LCD PANEL/VIEWFINDER SETTINGS	60
LCD PANEL/EVF USE.....	60
EYE SENSOR SENSITIVITY.....	61
BRIGHTNESS.....	61
LCD PANEL.....	61
COLOR RENDERING	62
LCD PANEL.....	62
EVF.....	62
LCD FRAME RATE.....	62
EVF FRAME RATE.....	62
ACOUSTIC SIGNALS	63
VOLUME.....	63
ELECTRONIC SHUTTER SOUND.....	63
STILL IMAGE SETTINGS	64
FILE FORMAT.....	64
RESOLUTION.....	65
JPG RESOLUTION.....	65
IMAGE PROPERTIES.....	65
FILM STYLE.....	66

HIGHLIGHT/SHADOW	66	AF PHOTOGRAPHY	86
COLOR PROFILE	67	AUTOFOCUS MODES	86
MONOCHROME PROFILE	67	INTELLIGENT AF	86
CUSTOMIZING PHOTO PROFILES	68	AFs (single)	86
AUTOMATIC OPTIMIZATION	69	AFc (continuous)	86
NOISE REDUCTION	69	AUTOFOCUS METERING METHODS	87
NOISE REDUCTION FUNCTION FOR LONG-TERM EXPOSURE .	69	MULTI-FIELD METERING	87
NOISE REDUCTION IN JPG IMAGES	70	SPOT/FIELD METERING	87
IMAGE STABILIZATION	70	ZONE	88
DARK AREA OPTIMIZATION (IDR)	71	TRACKING	88
DYNAMIC RANGE	71	PERSON DETECTION (EYE/FACE DETECTION)	89
iDR FUNCTION	71	AF QUICK SETTING	89
DATA MANAGEMENT	72	ACCESSING AF QUICK SETTING	89
FORMATTING A MEMORY CARD	72	ADJUSTING THE AF FRAME SIZE	89
DATA STRUCTURE	73	MF ASSIST FUNCTIONS	90
EDIT FILE NAMES	74	AF ASSIST LAMP	90
LOGGING THE SHOOTING LOCATION	74	ACOUSTIC AF CONFIRMATION	90
DATA TRANSFER	75	SHIFTING THE AF FRAME	90
PRACTICAL DEFAULT SETTINGS	76	MANUAL FOCUSING (MF)	91
TOUCH AF	76	MF ASSIST FUNCTIONS	91
TOUCH AF + SHUTTER BUTTON	77	FOCUS PEAKING.....	91
TOUCH AF IN EVF MODE	77	ENLARGEMENT IN MF MODE.....	92
AUXILIARY DISPLAYS	77	MACRO FUNCTION	93
INFO DISPLAYS IN SHOOTING MODE	78	ISO SENSITIVITY	93
SHOW AVAILABLE	78	FIXED ISO VALUES	93
INFO BARS	78	AUTOMATIC SETTING	94
GRID.....	79	LIMITING SETTING RANGES	94
FOCUS PEAKING.....	79	WHITE BALANCE	95
LEVEL GAUGE	80	AUTOMATIC CONTROL/FIXED SETTINGS	95
CLIPPING	81	MANUAL SETTING VIA METERING	96
HISTOGRAM.....	81	DIRECT SETTING OF THE COLOR TEMPERATURE	96
TEMPORARY ACTIVATION/DEACTIVATION OF		EXPOSURE	97
INDIVIDUAL FUNCTIONS	82	SHUTTER TYPE	97
MF ASSIST FUNCTIONS	82	EXPOSURE METERING METHODS	98
AF ASSIST LAMP	82	EXPOSURE MODES	99
PHOTOGRAPHY	84	SELECTING A MODE.....	99
DRIVE MODE	84	FULLY AUTOMATIC EXPOSURE SETTING – P	100
ZOOM	85	PROGRAM AE MODE – P	100
FOCUSING	86	CHANGING THE PRESET SHUTTER SPEED AND APERTURE	
		COMBINATIONS (SHIFT).....	100
		SEMI-AUTOMATIC EXPOSURE SETTING – A/S	101

APERTURE-PRIORITY MODE - A	101	JUMPING TO A SPECIFIC PICTURE IN THE GROUP	127
SHUTTER-PRIORITY MODE - S	101	RESUMING PLAYBACK	127
MANUAL EXPOSURE SETTING - M	102	SCROLLING THROUGH THE INDIVIDUAL PICTURES OF A SERIES	127
SETTING SHUTTER SPEEDS	103	CROPPED SECTION ZOOM	128
LONG-TERM EXPOSURE	104	DISPLAYING MULTIPLE IMAGES AT ONCE	129
FIXED SHUTTER SPEEDS	104	TAGGING/RATING OF IMAGES	131
T FUNCTION	104	DELETING IMAGES	131
NOISE REDUCTION	105	DELETING INDIVIDUAL IMAGES	132
EXPOSURE CONTROL	106	DELETING MULTIPLE IMAGES	133
EXPOSURE PREVIEW	106	DELETING UNRATED IMAGES	134
EXPOSURE LOCK	106	DELETING PICTURE SERIES	134
EXPOSURE COMPENSATION	109	PREVIEW OF LATEST IMAGE	135
SHOOTING MODES	110	PREVIEW OF LATEST IMAGE	135
CONTINUOUS SHOOTING	110	VIDEO SETTINGS	136
INTERVAL SHOOTING	111	FILE FORMAT	136
EXPOSURE BRACKETING	113	VIDEO FORMAT	136
SELF-TIMER	114	MP4	136
SPECIAL SHOOTING MODES	115	AVAILABLE RESOLUTIONS	137
SCENE MODE	115	AVAILABLE FRAME RATES	137
FLASH PHOTOGRAPHY	116	SETTING THE VIDEO FORMAT	137
COMPATIBLE FLASH UNITS	116	IMAGE PROPERTIES	138
FLASH EXPOSURE METERING (TTL METERING)	117	VIDEO STYLE	138
SETTINGS ON THE FLASH UNIT	118	COLOR PROFILE	139
FLASH MODES	118	MONOCHROME PROFILE	139
AUTOMATIC FLASH ACTIVATION	118	CUSTOMIZING VIDEO PROFILES	140
MANUAL FLASH ACTIVATION	118	AUDIO SETTINGS	140
AUTOMATIC FLASH ACTIVATION AT SLOWER SHUTTER SPEEDS (LONG-TERM SYNCHRONIZATION)	119	MICROPHONE	140
FLASH CONTROL	119	WIND NOISE REDUCTION	141
SYNC POINT	119	AUTOMATIC OPTIMIZATION	141
FLASH EXPOSURE COMPENSATION	120	VIDEO STABILIZATION	141
REVIEW MODE	122	DARK AREA OPTIMIZATION (IDR)	142
CONTROL ELEMENTS IN REVIEW MODE	122	DYNAMIC RANGE	142
DIRECT ACCESS IN REVIEW MODE	123	IDR FUNCTION	142
CONTROL ELEMENTS ON THE LCD PANEL	123	DATA MANAGEMENT	143
STARTING/EXITING REVIEW MODE	124	FORMATTING A MEMORY CARD	143
SELECTING/SCROLLING THROUGH IMAGES	124	DATA STRUCTURE	144
INFO DISPLAYS IN REVIEW MODE	125	EDIT FILE NAMES	145
PICTURE SERIES REVIEW (INTERVAL SHOOTING)	126	DATA TRANSFER	145

PRACTICAL DEFAULT SETTINGS	146	DIRECT SETTING OF THE COLOR TEMPERATURE	167
TOUCH AF.....	146	EXPOSURE MODES	168
TOUCH AF IN EVF MODE	147	SELECTING A MODE.....	169
AUXILIARY DISPLAYS	147	FULLY AUTOMATIC EXPOSURE SETTING – P	169
SHOW AVAILABLE	148	PROGRAM AE MODE – P	169
INFO BARS	148	CHANGING THE PRESET SHUTTER SPEED AND	
GRID.....	148	APERTURE COMBINATIONS (SHIFT).....	170
ZEBRA	149	SEMI-AUTOMATIC EXPOSURE SETTING – A/S	170
FOCUS PEAKING.....	149	MANUAL EXPOSURE SETTING – M	171
LEVEL GAUGE	150	SETTING SHUTTER SPEEDS.....	172
HISTOGRAM	151	EXPOSURE COMPENSATION.....	172
TEMPORARY ACTIVATION/DEACTIVATION OF		SPECIAL SHOOTING MODES	173
INDIVIDUAL FUNCTIONS.....	152	PLAYBACK MODE	174
MF ASSIST FUNCTIONS	152	CONTROL ELEMENTS IN PLAYBACK MODE.....	174
ACOUSTIC AF CONFIRMATION	152	DIRECT ACCESS IN PLAYBACK MODE	175
RECORDING VIDEO	154	STARTING/EXITING PLAYBACK MODE	176
START/EXIT VIDEO MODE	155	SELECTING/SCROLLING THROUGH IMAGES	176
START/END VIDEO RECORDING	155	INFO DISPLAYS IN PLAYBACK MODE	177
FOCUSING.....	156	DISPLAYING MULTIPLE IMAGES AT ONCE.....	178
AUTOFOCUS MODES	156	TAGGING/RATING OF RECORDINGS	179
CONTROLLING THE AUTOFOCUS	157	DELETING RECORDINGS	180
TOUCH AF.....	157	DELETING INDIVIDUAL RECORDINGS	180
CONTINUOUS FOCUSING	157	DELETING MULTIPLE RECORDINGS.....	181
AUTOFOCUS METERING METHODS	158	DELETING UNRATED RECORDINGS.....	182
PERSON DETECTION (EYE/FACE DETECTION).....	159	VIDEO PLAYBACK	183
AF QUICK SETTING	160	OTHER FUNCTIONS.....	186
ACCESSING AF QUICK SETTING	160	RESETTING THE CAMERA TO FACTORY SETTINGS	186
ADJUSTING THE AF FRAME SIZE	160	FIRMWARE UPDATES	187
SHIFTING THE AF FRAME.....	161	EXECUTING A FIRMWARE UPDATE	188
MANUAL FOCUSING (MF).....	161	LEICA FOTOS	190
MF ASSIST FUNCTIONS.....	162	CONNECTIVITY (iPhone users).....	190
FOCUS PEAKING.....	162	FIRST-TIME CONNECTION TO A MOBILE DEVICE	190
ENLARGEMENT IN MF MODE.....	162	CONNECTING WITH PAIRED DEVICES.....	191
MACRO FUNCTION	163	CONNECTIVITY (Android users)	191
ISO SENSITIVITY	164	FIRST-TIME CONNECTION TO A MOBILE DEVICE	191
FIXED ISO VALUES	164	CONNECTING WITH PAIRED DEVICES.....	192
AUTOMATIC SETTING	164	EXECUTING A FIRMWARE UPDATE.....	192
WHITE BALANCE.....	165		
AUTOMATIC CONTROL/FIXED SETTINGS.....	165		
MANUAL SETTING VIA METERING.....	166		

CARE/STORAGE	194
FAQ	196
MENU OVERVIEW	202
TECHNICAL DATA	208
LEICA CUSTOMER CARE	214
LEICA AKADEMIE	214

Definition of the various categories of information found in this manual

Note

Additional information

Important

Failure to comply with instructions may result in damage to the camera, the accessories or the data files

Attention

Non-compliance may result in personal injury

PART DESIGNATIONS

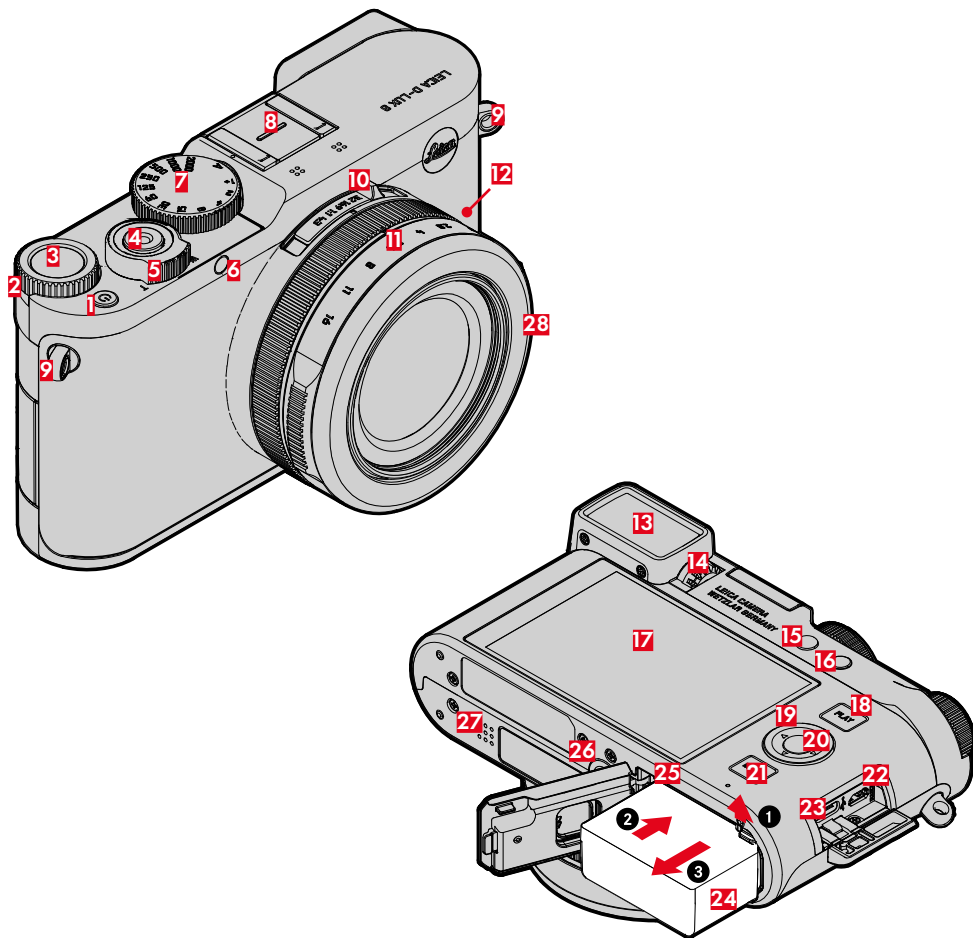

LEICA D-LUX 8

28 Thread protection ring

- 1** Main switch
- 2** Thumbwheel
- 3** Thumbwheel button
- 4** Shutter button
- 5** Zoom lever
- 6** Self-timer LED/AF assist lamp
- 7** Shutter-speed dial
- 8** Accessory shoe
- 9** Strap lugs
- 10** Image format selector
- 11** Aperture ring
- 12** Focus mode setting dial
- 13** Viewfinder eyepiece
- 14** Diopter wheel
- 15** Function button 1
- 16** Function button 2
- 17** LCD panel
- 18** **PLAY** button
- 19** Directional pad
- 20** Center button
- 21** **MENU** button
- 22** HDMI port
- 23** USB-C socket
- 24** Battery compartment
- 25** Memory card slot
- 26** Tripod thread
- 27** Speaker

DISPLAYS

The images displayed on the LCD panel and in the viewfinder are identical.

PHOTO

STATUS SCREEN

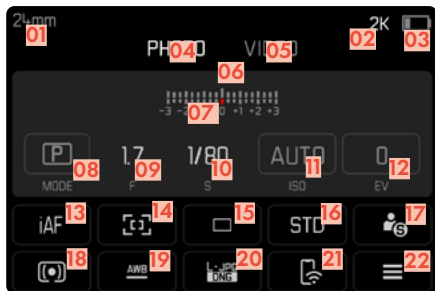

IN SHOOTING MODE

All displays/values refer to the actual settings.

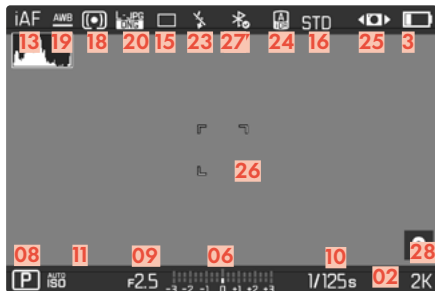

IN REVIEW MODE

All displays/values refer to the displayed image.



ACTIVATED Capture Assistants

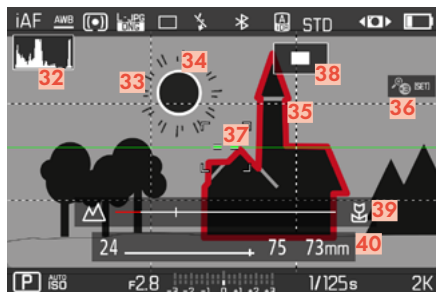

- 01 Focal length
- 02 Remaining storage capacity
- 03 Battery capacity
- 04 Menu section **PHOTO**
- 05 Menu sections **VIDEO**
- 06 Light balance
- 07 Exposure compensation scale
- 08 Exposure mode
- 09 Aperture value
- 10 Exposure time
- 11 ISO Sensitivity
- 12 Exposure compensation value
- 13 Focus mode
- 14 Autofocus metering method
- 15 Shooting mode (**Drive Mode**)
- 16 Color rendering (**Film Style**)
- 17 User profile
- 18 Exposure metering method
- 19 White balance mode
- 20 File format/compression level/resolution
- 21 Leica FOTOS
- 22 Main menu
- 23 Flash mode/flash exposure compensation
- 24 iDR
- 25 Stabilization activated
- 26 AF Field
- 27 Bluetooth® (Leica FOTOS)
- 28 Geotagging
Automatic storage of the shooting location (Exif data)
- 29 Icon for marked picture
- 30 File name
- 31 File number of the image shown
- 32 Histogram
- 33 Grid lines
- 34 Clipping identification of overexposed subject elements
- 35 Automatic magnification as focus assistance for manual focusing (3x  or  6x magnification available)
- 36 Focus peaking
(identification of in sharp edges in the object)
- 37 Level gauge
- 38  Display of cropped section size and position
(only visible for enlarged sections)
- 39 Distance scale in MF mode
- 40 Zoom level

VIDEO

STATUS SCREEN

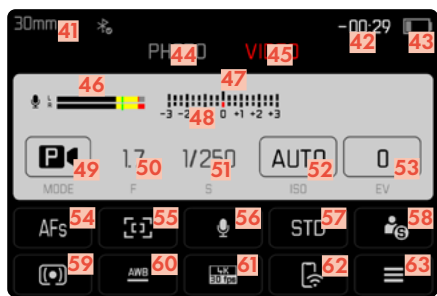

IN RECORDING MODE

All displays/values refer to the actual settings.

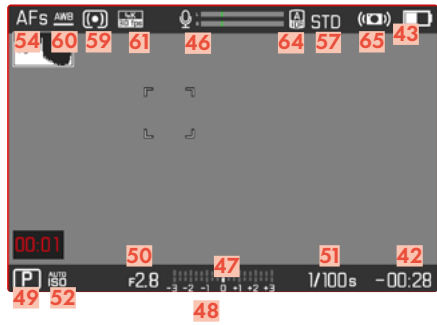

IN PLAYBACK MODE

All displays/values refer to the displayed image.

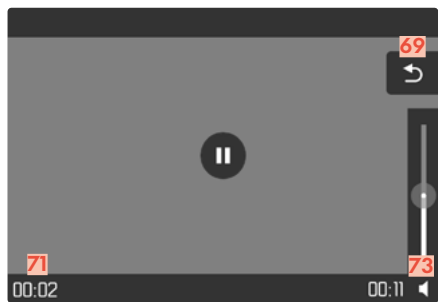

- 41 Focal length
- 42 Remaining storage capacity
- 43 Battery capacity
- 44 Menu section **PHOTO**
- 45 Menu sections **VIDEO**
- 46 Microphone recording level
- 47 Light balance
- 48 Exposure compensation scale
- 49 Exposure mode
- 50 Aperture value
- 51 Exposure time
- 52 ISO Sensitivity
- 53 Exposure compensation value
- 54 Focus mode
- 55 Autofocus metering method
- 56 Microphone sensitivity (**Microphone Gain**)
- 57 Color rendering (**Video Style**)
- 58 User profile
- 59 Exposure metering method
- 60 White balance mode
- 61 Resolution / Frame rate
- 62 Leica FOTOS
- 63 Main menu
- 64 iDR
- 65 Stabilization activated
- 66 Indicates for video recording in progress
- 67 Length of video recording
- 68 Icon for marked video recording
- 69 Exiting video playback
- 71 Current playback time
- 73 Volume bar

CHARGE STATUS INDICATOR ON THE LCD PANEL

The battery charge status is displayed in the status screen and in the header line at the top right.



Display	Charge status
	Approx. 75% or more
	Approx. 74–50%
	Approx. 49–25%
	Approx. 24% or less
	Approx. 0% The battery needs charging or replacing

Note

- The displayed battery charge is an approximate value. The exact level of charge depends on ambient and operating conditions.

PREPARATION

Please read the chapters “Legal information”, “Safety remarks”, and “General information” before using your camera for the first time. Knowledge of the content will prevent inadvertent damage to the product, possible injuries and other risks.

ATTACHING THE SAFETY CORD

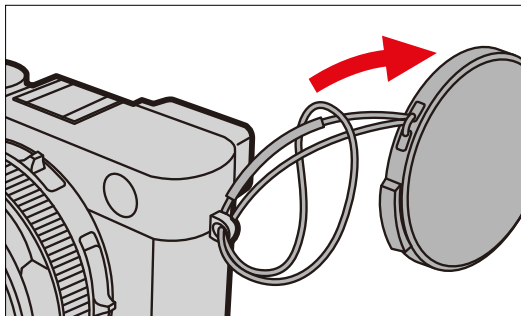
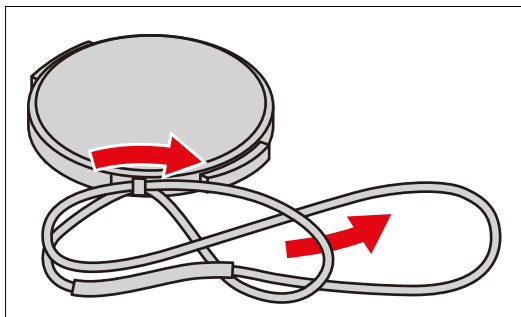

ATTACHING THE HAND STRAP

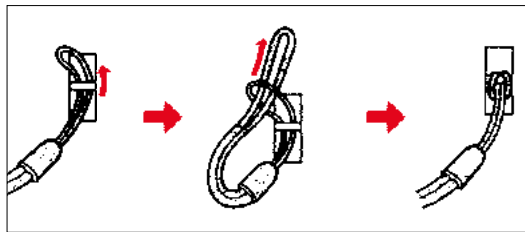

Attention

- Once you have attached the carry strap, make sure that it is secured correctly to prevent the camera from falling.

CHARGING VIA USB

The rechargeable battery in the camera can be automatically charged when the camera is connected to a computer or another suitable power source via USB cable.

Note

- The charging process will commence automatically once the camera is switched off.

INSERTING/REMOVING THE BATTERY

- Ensure that the camera is switched OFF (see p. 34)

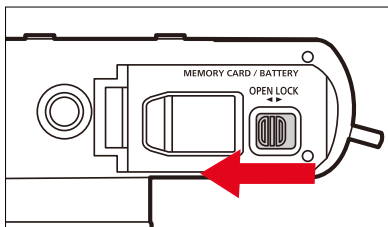

- Slide the battery compartment locking lever to the **OPEN** position
 - The battery compartment opens.

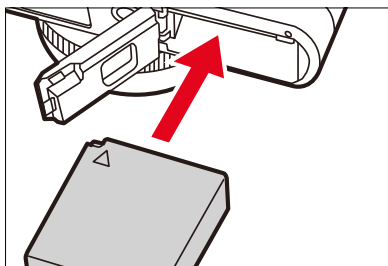

- Insert the battery into the compartment with the marking facing upward.
 - The battery release lever clicks audibly.

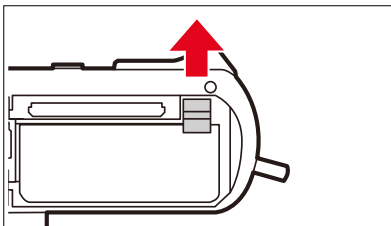

- Slide the battery release lever upward
 - Battery is pushing out slightly.
- Remove the battery

Important

- Removing the battery while the camera is switched on may result in the loss of custom settings or damage to the memory card.

INSERTING/REMOVING THE MEMORY CARD

The camera will save exposures to an SD (Secure Digital), SDHC (High Capacity) or SDXC (eXtended Capacity) memory card.

Notes

- Various manufacturers offer SD/SDHC/SDXC memory cards in a range of sizes and read/write speeds. Memory cards with high storage capacities and high read/write speeds offer quick storage and rendering.
- The memory card may not be supported (capacity) or will have to be formatted in the camera before first use (see p. 72). The camera will in that case display a relevant message. Please see the section "Technical Data" for information about supported cards.
- Check the memory card for correct alignment if you are having difficulties inserting it into the camera.
- See p. 10 and p. 13 for additional information.
- Video shootings require a high write speed.

→ Ensure that the camera is switched OFF (see p. 34)

OPENING THE BATTERY COMPARTMENT

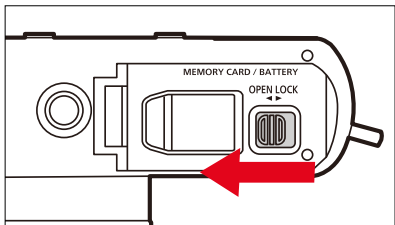

- Slide the battery compartment locking lever to the **OPEN** position
- The battery compartment opens.

CLOSE THE BATTERY COMPARTMENT

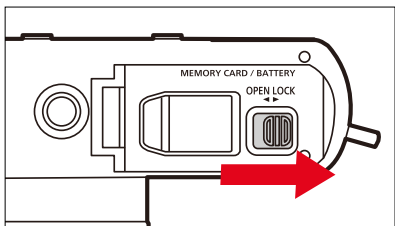

- Close and hold down the cover
- Slide the battery compartment locking lever to the **LOCK** position

INSERTION

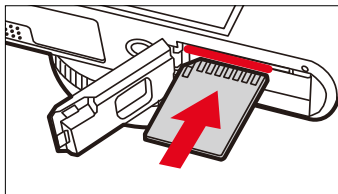

- Push the memory card into the slot with the contacts pointing towards the LCD panel until you hear and feel it clicking into place

REMOVAL

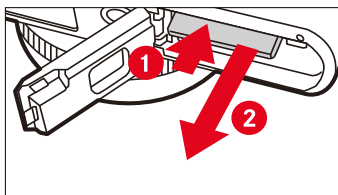

- Push down on the card until you hear a click
- The card pushes out slightly.
- Remove the memory card

DIOPTER SETTINGS

The viewfinder has a diopter setting function with a range between -4 and $+2$ diopter to allow glasses wearers the use of the camera without eyeglasses (diopter compensation).

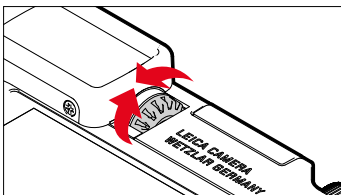

- Look through the viewfinder
- Aiming at and focusing on an object
- Turn the diopter setting wheel until you see the image in the viewfinder and the displays in perfect focus

CAMERA OPERATION

CONTROL ELEMENTS

MAIN SWITCH

The main switch switches the camera on and off.

SWITCHING THE CAMERA ON

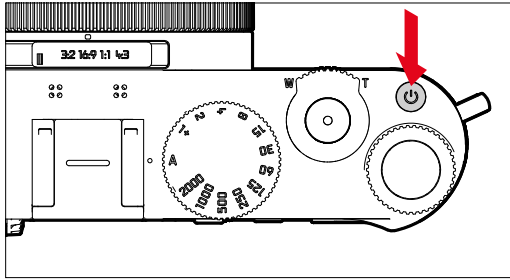

Notes

- Once switched on, the camera will be ready to use after approx. 1 s.
- The LED lights up briefly and the displays in the viewfinder appear.

SWITCHING THE CAMERA OFF

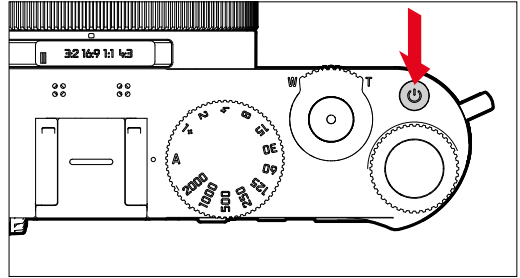

Note

- The function **Auto Power Off** (see p. 59) deactivates the camera automatically if no operation occurs within a preset time. Use the main switch to deactivate the camera if this function is **Off** to prevent inadvertent exposures and battery discharge when the camera is not in use.

SHUTTER BUTTON

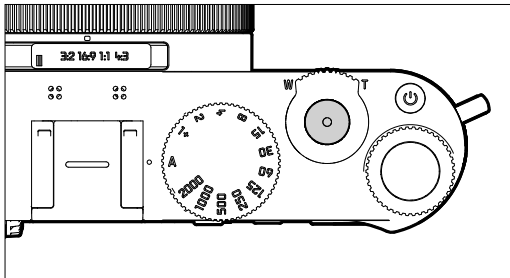

The shutter button works in two stages.

Tapping (= Pressing the shutter button to the 1st pressure point)

- Activating the camera electronics and displays
- Exposure lock (metering & saving):
 - AF mode: range measurement (AF-L)
 - (semi) automatic exposure mode: exposure metering (AE-L)
- Canceling a running self-timer delay time
- Return to shooting mode
 - from review mode
 - from menu control

Press down fully

- Shutter release
 - The data is then transferred to the memory card.
- Starting a video shooting
- Starting a preselected self-timer delay time
- Starting a continuous shooting or interval shooting

Notes

- Press down the shutter button in a smooth motion until you hear the click of the shutter to prevent camera shake.
- The shutter button remains locked:
 - if the memory card inserted and/or the internal buffer memory are (temporarily) full
 - if the battery has exceeded its performance limits (capacity, temperature, age)
 - if the memory card is write-protected or damaged
 - if the sensor is too hot

ZOOM LEVER

Zooming will change the lens focal length and with it the image section to be recorded. It additionally determines the size of the depicted object.

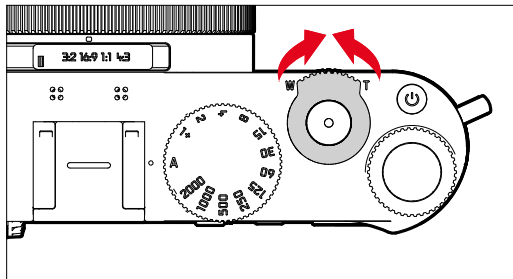

- **T**: Longer (Tele) focal lengths enlarge the object
- **W**: Shorter (Wide angle) focal lengths record a larger image section

Notes

- Do not touch the lens tube while zooming
- Set the focal length first, then image sharpness
- A whirring sound may be heard, or the camera may vibrate when turning the zoom lever. That is not a functional error.

SHUTTER-SPEED DIAL

The shutter-speed dial has no stop, which means it can be turned in either direction from any position. It will click at each engraved position. Intermediate positions outside the click positions must not be used. Please read the section "Exposure" (see p. 97 and 168) for details about correct exposure settings.

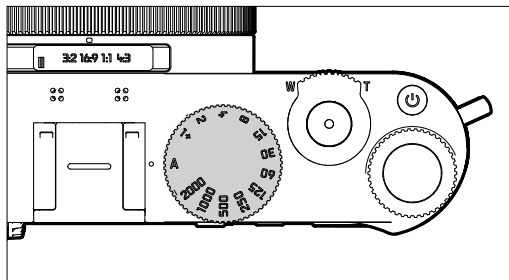

- **A**: aperture-priority mode (Automatic shutter speed control)
- **2000 - 1+**: Fixed shutter speeds

THUMBWHEEL

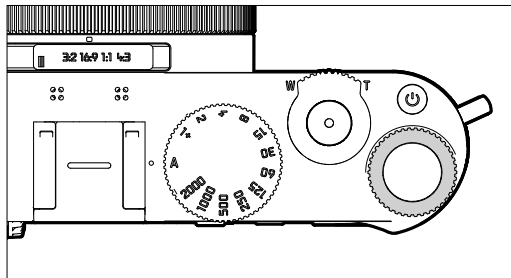

- Menu navigation
- Exposure compensation value selection
- Setting the ISO value
- Enlarging/reducing viewed images
- Setting selected menu items/functions
- Setting the program shift

THUMBWHEEL BUTTON

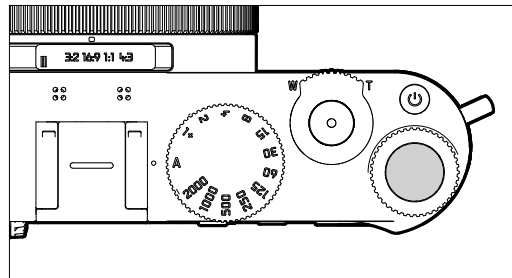

- Applying menu settings
- Direct access to menu functions
- Accessing the submenu

DIRECTIONAL PAD/CENTER BUTTON

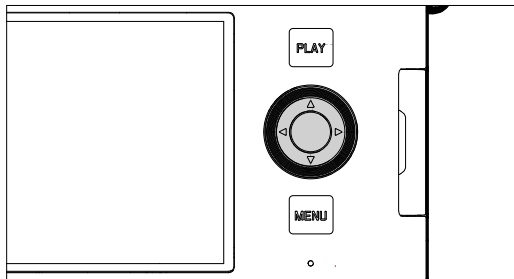

DIRECTIONAL PAD

- Menu navigation
- Setting selected menu items/functions
- Scrolling through the gallery
- Shifting the focus frame

CENTER BUTTON

- Accessing the information display
- Accessing the submenu
- Applying menu settings
- Displaying settings/data in shooting mode
- Displaying image data in review mode
- Playback of video recordings
- Confirming the prompts
- Direct access to menu functions

PLAY BUTTON/MENU BUTTON

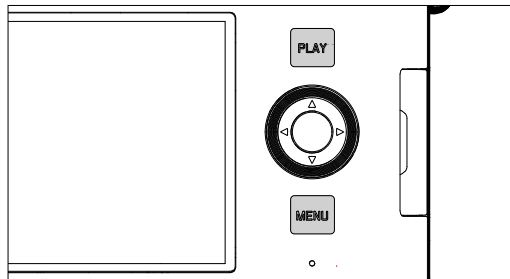

PLAY BUTTON

- Activation and deactivation of the (continuous) review mode
- Return to full-screen display

MENU BUTTON

- Accessing the menu (incl. status screen)
- Accessing the play menu
- Exiting the currently displayed (sub) menu
- Page by page scrolling in the main menu

LCD PANEL



- Displaying most important current settings
- Quick access to some menus
- Touch control

FUNCTION BUTTONS

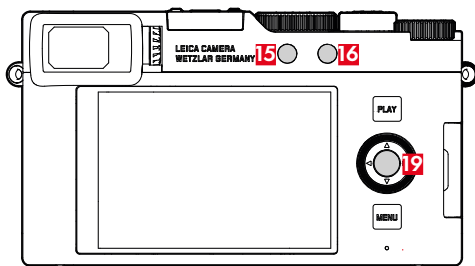
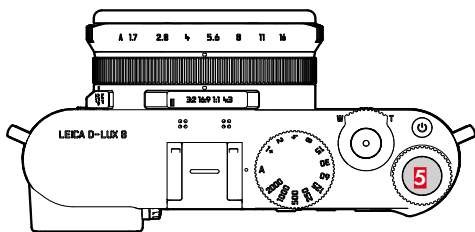







Direct access to various menus and functions. All function buttons can be custom configured (see p. 54).

FACTORY SETTINGS	
In shooting mode	In review mode
Function button 1 (15)	
EVF <> LCD	
Function button 2 (16)	
Mode change (photo/video)	Delete Single
Thumbwheel button (5)	
ISO settings	Marking the image ★
Center button (19)	
Toggle Info Levels (Photo)	Toggle Info Levels

(see p. 202)

LCD PANEL (TOUCH SCREEN)

TOUCH CONTROL*		In shooting mode	In review mode
	"tap"	Shifting the AF frame and focusing (while Touch AF is activated)	Selecting images
	"double tap"		Enlarging/reducing viewed images
	"swipe"	Shifting the AF frame in AF and MF mode	Scrolling through the gallery Shifts the enlarged image section
	"horizontal swipe" (full length)		Scrolling through the gallery
	"tap and hold"		
	"two-finger pinch" "two-finger spread"	Changing the size of the AF frame (in specific AF modes)	Enlarging/reducing viewed images
	"swipe and hold" "hold and swipe"	Shifting the AF frame	Continuous scrolling

* A light touch is enough, don't apply pressure.

MENU CONTROL

CONTROL ELEMENTS

The following elements are used for menu control.

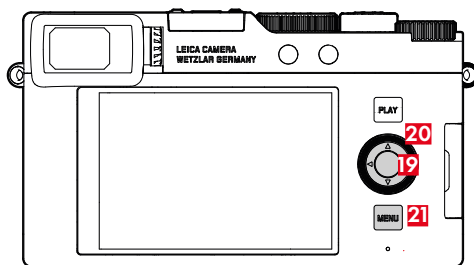
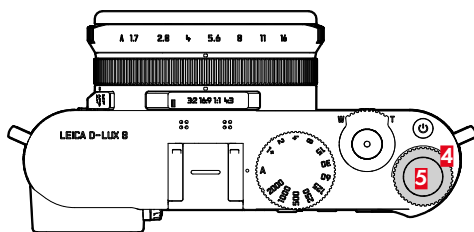

- 4** Thumbwheel
- 5** Thumbwheel button
- 19** Center button
- 20** Directional pad
- 21** MENU button

MENU SECTIONS

Two menu areas are available: Status screen and **Main Menu**.

Status screen:

- quick access to the most important settings

Main Menu:

- offers access to all menu items
- contains various submenus

The currently active operating mode (Photo or Video) is highlighted in color in all menu areas.

Section	PHOTO	VIDEO
Status screen	Dark background	Bright background
Main menu (top level)	Dark header line	Bright header line
Main menu (Submenus)		

STATUS SCREEN

Photo



Video

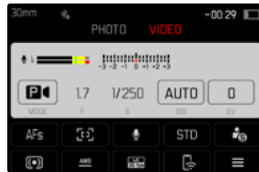

MAIN MENU

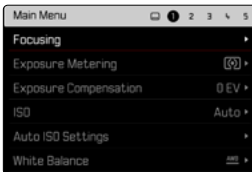
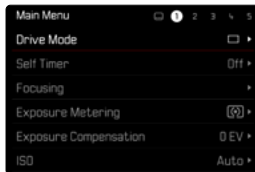

SETTINGS IN PHOTO AND VIDEO MODE

The available settings depend on the operating mode (Photo or Video) currently in use.

- Most of the menu items and submenu items listed in the main menu are operating mode specific. That means that any changes made here, will only apply for the operating mode currently in use. Any menu items of the same name in the other operating mode will be unaffected. That includes settings for focusing, exposure metering or white balance.

Settings and functions with global effect are:

- User Profile
- Capture Assistants
- Play Mode Setup
- Display Settings
- Leica FOTOS
- Format Card
- Camera Settings
- Camera Information
- Language
- Reset Camera

SWITCHING MENU SECTIONS

The status screen will always be displayed as the first menu section. The top level of the menu is organized into “pages”, which are displayed in the header: Status Screen and several sections of the Main Menu. You can switch between menu sections by scrolling through the pages. Alternatively, the Status screen offers access back to the Main Menu via the final menu item.

Scrolling forward

→ Press the **MENU** button

- The status screen will appear again after the last page of the main menu.

Scrolling backward

→ Press the directional pad left

- In reverse order, you can only browse back to the status screen.

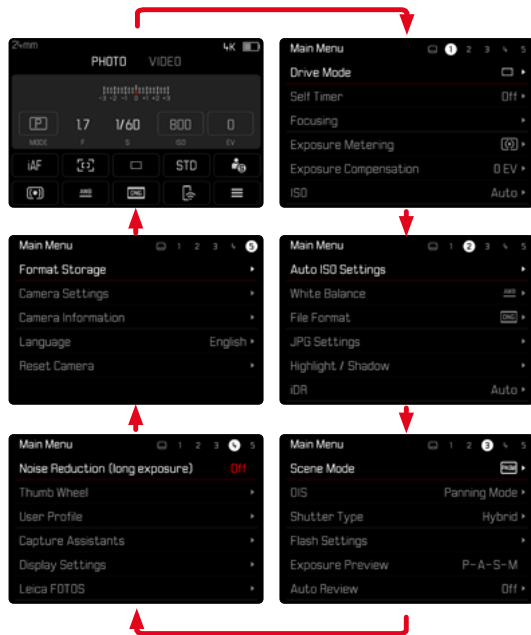

STATUS SCREEN

The status screen offers an overview of the most important information regarding the current camera status and active settings.

It furthermore allows direct access to important settings. The status screen is optimized for touch control.



- A** Mode: photo/video (see p.155)
- B** Exposure settings (see p. 97 and p. 168)
- C** Menu items
- D** Access to the main menu

Notes

- Where touch control is not possible or not desirable (e.g. in EVF mode), the status screen can alternatively be controlled via the directional pad, center button, thumbwheel and the thumbwheel button.
- The settings become effective immediately.
- The framed control panels can be selected. Unframed values are added in automatically (depending on the active exposure mode).
- The available menu items in photo and video mode differ (see p. 24 and p. 26).

SETTINGS

Settings can be selected in various ways from within the status screen. The setting types vary from menu to menu.

- Tap the desired control panel
 - The relevant menu appears.

DIRECT SETTINGS

A version of the menu bar appears in the lower area of the status screen (see p. 51).

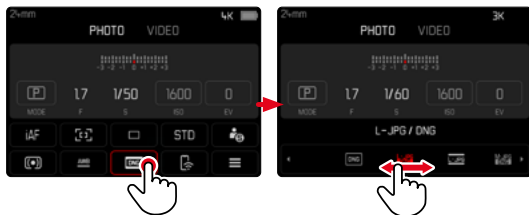

- Select the desired function directly or swipe

ACCESSING A STANDARD SUBMENU

These menus behave as if they were accessed from within the main menu (see p. 48). Touch control is therefore unavailable. From there, you return to the status screen and not to the next higher menu item.

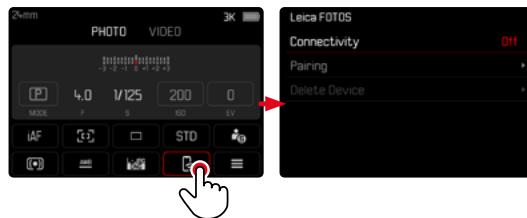

- Select the desired setting

MAIN MENU

The main menu offers access to all settings. Most of these are organized in submenus.

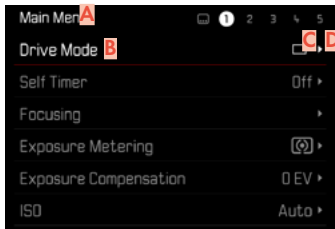

- A** Menu section: `Main Menu`
- B** Menu item name
- C** Menu item setting
- D** Submenu reference

SUBMENU

There are various types of submenus available. The following pages describe their operation.

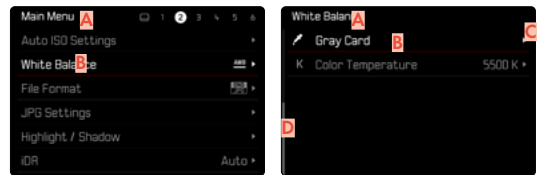

- A** Current menu item
- B** Submenu item
- C** References to other submenus
- D** Scrollbar

MENU NAVIGATION

SCREEN BY SCREEN NAVIGATION

Scrolling forward

- Press the **MENU** button (repeatedly if needed)
 - The status screen will appear again after the last page of the main menu.

Scrolling backward

- Press the directional pad left
 - In reverse order, you can only browse back to the status screen.

LINE BY LINE NAVIGATION

(Function/function option selection)

→ Press the directional pad up/down

or

- Turn the thumbwheel
(to the right = down, to the left = up)
 - Once the last menu item has been reached scrolling up or down, the display will automatically jump to the previous or next screen. The currently active menu section (Favorites, Main Menu) is not exited.

Note

- Some menu items can only be accessed under specific circumstances. The text in the relevant line is displayed in gray to signify the existence of a submenu.

SHOW SUBMENU

- Press the center button/thumbwheel button
- or
- Press the directional pad to the right

CONFIRM SELECTION

- Press the center button/thumbwheel button
 - The screen image changes back to the active menu item. The set function variant is shown on the right in the relevant menu line.

Note

- No confirmation is needed for the selection of **On** or **Off**. An automatic save is done.

GO BACK ONE STEP

(Return to the superordinate menu item)

- Press the directional pad left
 - This option is only available for list-type submenus.

GO BACK TO TOP MENU LEVEL

- Press the **MENU** button 
 - The top level of the currently selected menu section is displayed.

EXITING THE MENU

You can exit the menus and submenus at any time – with/without applying the settings selected there.

Go to shooting mode

- Tap the shutter button

Go to review mode

- Press the **PLAY** button

SUBMENU

KEYBOARD/NUMBER PAD

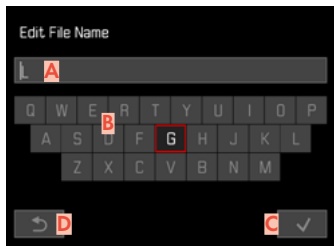

- A** Entry line
- B** Keyboard
- C** “Confirm” button
- E** Return to previous menu level

SELECTING A BUTTON (ICON/FUNCTION BUTTON)

Using button control

- Press the directional pad in the relevant direction
 - The currently active button will be highlighted.
- Press the center button/thumbwheel button

or

- Turn the thumbwheel
 - The currently active button will be highlighted.
 - There will be an automatic jump to the next/previous line when the end/beginning of the line is reached.
- Press the center button/thumbwheel button

Using touch control

- Press the button of your choice

SAVE

- Select button **C**

CANCEL

- Select button **D**

MENU BAR

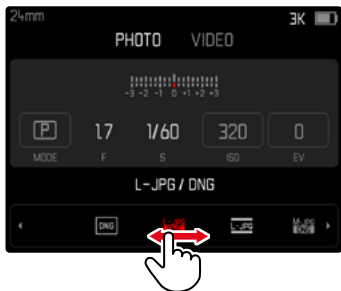

Using button control

- Press the directional pad left/right
- or
- Turn the thumbwheel

Using touch control

- Select the desired function directly or swipe

Notes

- The currently active setting displayed in the center is highlighted in red.
- The set value is displayed above the scale/below the menu bar.
- The following applies for direct access: The selected function requires no additional confirmation and will be active immediately.

SCALE MENU

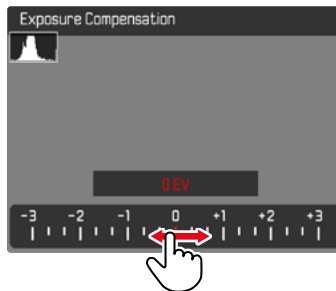

Using button control

- Press the directional pad left/right
- or
- Turn the thumbwheel

Using touch control

- Select the desired setting directly or swipe

Notes

- The currently active setting displayed in the center is highlighted in red.
- The set value is displayed above the scale/below the menu bar.

DATE/TIME MENU

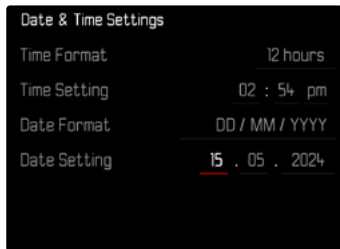

Moving to the next settings field

→ Press the directional pad left/right

Setting values

→ Press the directional pad up/down

or

→ Turn the thumbwheel

Saving and returning to superordinate menu item

→ Press the center button

COMBI MENU (IMAGE PROPERTIES)

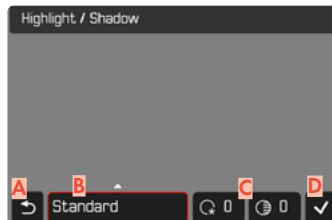

- A** "Back" button
(Exit without saving)
- B** "Parameter" button
- C** "Setting" button
- D** "Confirm" button
(Save and exit)

The operation is slightly different, depending on whether the settings are done via key control or touch control. The screen image will remain visible continuously while settings are being adjusted. The result of the setting can be observed directly.

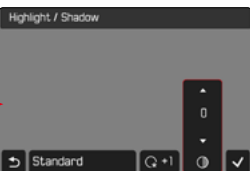
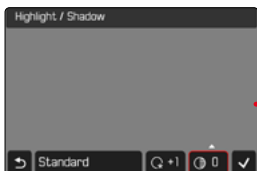
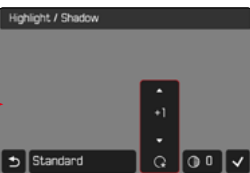
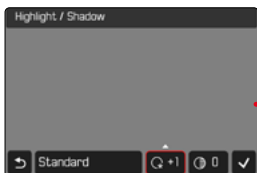
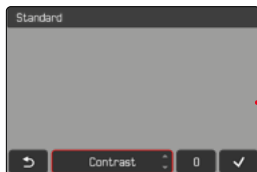

Using button control

Navigating between buttons

- Press the directional pad left/right
 - An active button is indicated by a red frame.

Applying setting

- Press the directional pad up/down
 - The button toggles directly between each of the options.

or

- Press the center button
 - All selectable options are displayed.
 - The “Parameter” button displays the currently set value for each of the parameter options.
- Press the directional pad up/down
 - An active button is indicated by a red frame.
- Press the center button
 - The options are no longer displayed.

Using touch control

- Tap the desired button
 - All available options are displayed for the buttons “Parameter” and “Setting”.
 - The “Parameter” button displays the currently set value for each of the parameter options.
- Tap the desired alternative

SAVE

- Select the “Confirm” button

CANCEL

- Select the “Back” button

USER-DEFINED OPERATION

DIRECT ACCESS TO MENU FUNCTIONS

You can assign specific menu functions to the following operating elements (function buttons) for extra quick direct access to menu items in shooting mode from a custom list.

- Function button 1 (15)
- Function button 2 (16)
- Center button (20)
- Thumbwheel button (3)

The assignments in photo and video mode are completely independent of each other. The available functions are shown in the list on p. 202. For factory settings see p. 40.

Notes

- The submenus accessed via direct access may look differently than when they are accessed via the main menu. Specifically, they often appear as menu bars to allow quick settings.
- The settings can be done via key control or using touch control on the LCD panel. The operating mode depends on the type of submenu.

CHANGING AN ASSIGNMENT

- Switch to the desired mode (photo or video)
- Press the function button longer
- Select the menu item you want by pressing the center button
 - You will not be prompted to acknowledge your selection. The change is applied immediately.

ACCESSING THE ASSIGNED MENU FUNCTION

- Press the function button briefly
 - The assigned function is accessed, or a submenu appears on screen (see p. 202).

THUMBWHEEL ASSIGNMENT

Factory setting: **Auto**

In factory settings, the thumbwheel function depends on the active exposure mode. However, the thumbwheel can also be assigned another function.

- Switch to the desired mode (photo or video)
- Select **Thumb Wheel** in the main menu
- Select the desired setting

The thumbwheel has varying functions depending on the exposure mode (see p. 97/p. 172) when it is set to **Auto**.

	Off	Auto	Exp. Comp.	ISO
P	–	Program shift	Exposure compensation	ISO
A	–	Exposure compensation	Exposure compensation	ISO
S	–	Exposure time	Exposure compensation	ISO
M	–	Exposure time	Exposure compensation	ISO

ACCESSING THE ASSIGNED MENU FUNCTION

- Turn the thumbwheel to the left/right

USER PROFILES

This camera allows the permanent storage of any menu settings, to e.g. access them quickly and easily for recurring conditions/image objects. The camera will also save the currently selected mode (Photo/Video).

Three memory slots are provided to store custom settings, plus the factory setting, which is always available and cannot be modified (**Default Profile**).

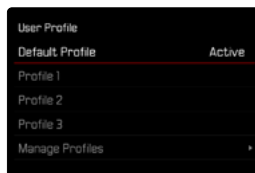

CREATING PROFILES

Saving settings/creating a profile.

- Create custom settings for the desired functions via menu control
- Select **User Profile** in the main menu
- Select **Manage Profiles**
- Select **Save as Profile**
- Select a memory slot

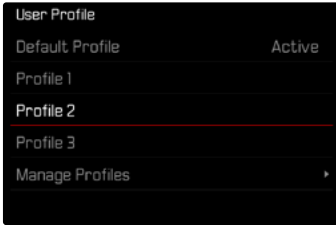

APPLYING/ACTIVATING PROFILES

Factory setting: **Default Profile**

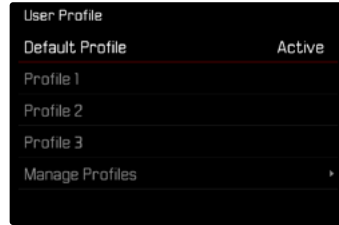

- Select **User Profile** in the main menu
 - A list of profile names is displayed.
- Select a profile
 - The selected profile is marked as **Active**.
 - Free memory slots appear in gray.

Note

- Existing profiles are overwritten with the latest settings.

CAMERA BASIC SETTINGS

The two menu items **Language** and **Date & Time** appear automatically when switching the camera on for the first time, after a reset to factory settings (see p.186), or after a firmware update.

MENU LANGUAGE

Factory setting: English

Available menu languages: German, French, Italian, Spanish, Portuguese, Russian, Japanese, Korean and Traditional or Simplified Chinese

- Select **Language** in the main menu
- Select your language
 - Aside from a few exceptions, the language will be changed for all information.

DATE/TIME

You can choose one of 3 options for the display sequence.

- Select **Camera Settings** in the main menu
- Select **Date & Time**
- Select **Date & Time Settings**
- Select the desired brightness
(**12 Hours**, **24 Hours**)
- Set the time
(Select **am** or **pm** for the 12-hour format)
- Select the desired date format
(**Day/Month/Year**, **Month/Day/Year**, **Year/Month/Day**)
- Set the date

TIME ZONE

- Select **Camera Settings** in the main menu
- Select **Date & Time**
- Select **Time Zone**
- Select your time zone/current location
 - The Greenwich Mean Time offset is shown on the left of the line
 - Major cities in the relevant time zones are shown on the right

DAYLIGHT SAVING TIME

- Select **Camera Settings** in the main menu
- Select **Date & Time**
- Select **Daylight Saving Time**
- Select **On/Off**

POWER SAVE MODE (STANDBY MODE)

The camera will switch to standby mode after a preset time to extend battery life if this function is activated.

The device has two power save levels.

- Activating the Auto power off function
- Automatic display deactivation

Factory setting: **2 min**

- Select **Camera Settings** in the main menu
- Select **Power Saving**
- Select **Auto Power Off**
- Select the desired setting
(**Off**, **1 min**, **2 min**, **5 min**, **10 min**)

Note

- The camera can be woken from standby mode at any time by pressing the shutter button or by switching the main switch off and on again.

LCD PANEL/VIEWFINDER SETTINGS

The camera comes equipped with a 3" liquid crystal color panel, which is protected by a glass cover made of extremely hard and scratch-resistant glass.

The following functions can be configured and used individually:

- Use of the LCD panel and EVF (electronic viewfinder)
- Eye sensor sensitivity
- Brightness
- Color rendering
- EVF Frame Rate
- Automatic LCD panel and EVF shutdown

LCD PANEL/EVF USE

You can preset the situations in which EVF and LCD panel should be used. The displays appearing on screen and in the electronic viewfinder are identical.

Factory setting: **Auto**

	EVF	LCD panel
Auto	The eye sensor in the viewfinder automatically toggles the camera between LCD panel and EVF. <ul style="list-style-type: none">• Shooting• Review• Menu control	
LCD		<ul style="list-style-type: none">• Shooting• Review• Menu control
EVF	<ul style="list-style-type: none">• Shooting• Review• Menu control	

→ Select **Display Settings** in the main menu

→ Select **EVF <> LCD**

→ Select the desired setting

Note

- Select **EVF** if you want to keep the LCD panel switched off (e.g. on dark environments).

EYE SENSOR SENSITIVITY

You can adjust the eye sensor sensitivity to ensure that the changeover functions reliably if you wear eyeglasses.

Factory setting: **High**

- Select **Display Settings** in the main menu
- Select **Eye Sensor Sensitivity**
- Select the desired setting

BRIGHTNESS

You can adjust brightness for best visibility in various lighting conditions. Selection occurs via key control or touch control.

LCD PANEL

- Select **Display Settings** in the main menu
- Select **LCD Brightness**
- Select the desired brightness or **Auto**
- Confirm selection

COLOR RENDERING

Color rendering can also be adjusted. Brightness is set individually for the LCD panel and the viewfinder. Selection occurs via key control or touch control.

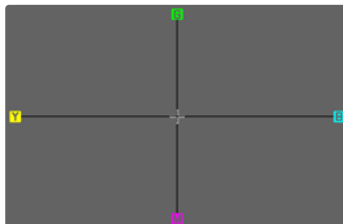

LCD PANEL

- Select **Display Settings** in the main menu
- Select **LCD Color Adjustment**
- Select the desired color setting
- Confirm selection

EVF

- Select **Display Settings** in the main menu
- Select **EVF Color Adjustment**
- Look through the viewfinder
- Select the desired color setting
- Confirm selection

LCD FRAME RATE

The image frequency for the LCD panel can be selected.

Factory setting: **30 fps**

- Select **Display Settings** in the main menu
- Select **LCD Frame Rate**
- Select the desired setting
(**30 fps**, **60 fps**)

EVF FRAME RATE

The image frequency of the EVF can be set.

Factory setting: **60 fps**

- Select **Display Settings** in the main menu
- Select **EVF Frame Rate**
- Select the desired setting
(**30 fps**, **60 fps**)

ACOUSTIC SIGNALS

Some functions can be acknowledged with acoustic signals. The following special functions can be configured separately:

- Electronic shutter sound
- AF confirmation

VOLUME

The volume of active signals can be set.

Factory setting: **Low**

- Select **Camera Settings** in the main menu
- Select **Acoustic Signal**
- Select **Volume**
- Select **Off/Low/High**

ELECTRONIC SHUTTER SOUND

Factory setting: **Off**

- Select **Camera Settings** in the main menu
- Select **Acoustic Signal**
- Select **Shutter Sound**
- Select **On**

STILL IMAGE SETTINGS

FILE FORMAT

Choose the JPG format **JPG** or the standardized raw data format **DNG** (= digital negative). Both can be used individually or simultaneously.

When creating JPGs, an initial processing occurs in the camera. Various parameters, including contrast, saturation, black level, or edge sharpness are set automatically. The result is then compressed and stored. The immediate result is an image that is optimized for various uses and a quick preview. For post-processing, on the other hand, DNG images are recommended.

DNG files contain all raw data as recorded by the camera sensor at the time the photo is taken. Special software (e.g. Adobe® Photoshop® Lightroom® or Capture One Pro®) will be needed to display DNG format files or to work with this format. Post-processing will allow exact adjustments of many parameters to your own expectations.

Factory setting: **DNG + JPG**

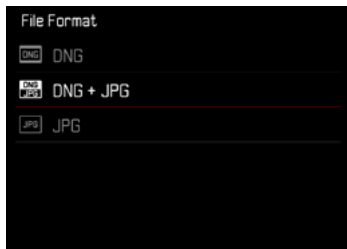

→ Select **File Format** in the main menu

→ Select a format

(**DNG**, **DNG + JPG**, **JPG**)

Notes

- The standardized DNG format is used for the storage of raw image data.
- The remaining number of shots shown in the LCD panel will not necessarily change after every shooting. That very much depends on the object; very fine image structures result in higher data quantities, while homogeneous surfaces mean less data.

RESOLUTION

JPG RESOLUTION

The **JPG** format setting offers 3 image resolution (number of pixels) options. The following file formats are available: **L-JPG**, **M-JPG** and **S-JPG**. This choice allows an alignment with the intended use and available memory card capacity.

Factory setting: **L-JPG**

- Select **JPG Settings** in the main menu
- Select **JPG Resolution**
- Select the desired resolution

IMAGE PROPERTIES

One of the many advantages of digital photography is that it is very easy to change essential image properties. The Leica D-Lux 8 offers a function for the adjustment of JPG format frames: The user-defined **Film Style** profile.



FILM STYLE

The image properties of JPG files can be changes slightly using several parameters. These are summarized in pre-configured **Film Style** profiles.

CONTRAST

The contrast setting, i.e. the difference between light and dark image sections, determines whether an image comes across as “flat” or “brilliant”. Increasing or decreasing this difference impacts on contrast, meaning that some image sections are rendered brighter or darker.

SHARPNESS

The impression of sharpness in a image is largely determined by edge sharpness, i.e. by how slight the transition area between light and dark is at edges in the image. Expanding or reducing these areas will therefore change the impression of sharpness.

COLOR SATURATION

The saturation factor in color shots determines, whether colors in the picture appear “pale” and pastel-like or “vivid” and bright. While lighting conditions and weather (e.g. foggy/clear) are a given in terms of shooting conditions, their rendering can be influenced.

HIGHLIGHT/SHADOW

Depending on the exposure selected and the dynamic scope of the object, some details in brighter or darker areas may no longer be clearly visible. The parameters **Highlight** and **Shadow** allow differentiated control over very brightly or less brightly lit areas. Where, for example, part of the object is in shadow, a higher setting for **Shadow** can help brighten these areas to make details more visible. Conversely, existing shadows or particularly bright areas might be additionally emphasized for reasons of image composition. Positive values will brighten the targeted areas, while negative values will darken them.

COLOR PROFILE

3 pre-configured color profiles are available:

Factory setting: **Standard**

– **STD** **Standard**

– **VIV** **Vivid**

– **NAT** **Natural**

→ Select **JPG Settings** in the main menu

→ Select **Film Style**

→ Select a profile



MONOCHROME PROFILE

Two pre-configured monochrome profiles are available:

– **BW** **Monochrome**

– **BW** **Monochrome High Contrast**

→ Select **JPG Settings** in the main menu

→ Select **Film Style**

→ Select a profile

CUSTOMIZING PHOTO PROFILES

These parameters can be adjusted for all available profiles (Saturation only for color profiles). See p. 52 for details on menu operation.

- Select **JPG Settings** in the main menu
- Select **Film Style**
- Select **Film Style Settings**
- Select a profile
- Select **Contrast/Highlight/Shadow/Sharpness/Saturation**
- Select the desired level
(-2, -1, 0, +1, +2)
- Confirm

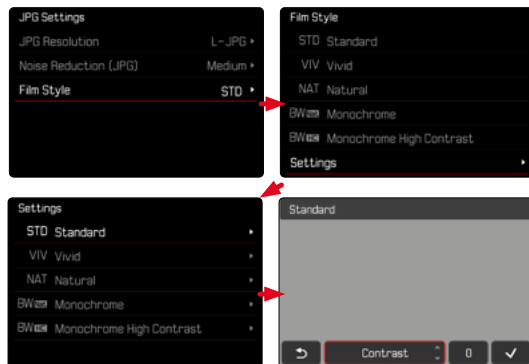

AUTOMATIC OPTIMIZATION

NOISE REDUCTION

NOISE REDUCTION FUNCTION FOR LONG-TERM EXPOSURE

In digital photography, the appearance of flawed pixels that can be white, red, blue or green is referred to as "noise". Image noise becomes more apparent when using higher sensitivities, particularly on uniform dark areas. Long exposure times may cause severe image noise. In order to reduce this annoying phenomenon, the camera will take a second "dark frame" (taken with the shutter closed) automatically after a shooting with slow shutter speed and high ISO value. The noise metered in this parallel shot will then be "subtracted" digitally from the data for the actual shot. In such cases the message **Noise reduction in progress...** will appear with a relevant time value.

This "exposure time" doubling must be taken into account in long-term exposures. The camera must not be switched off during that time. We recommend disabling Noise Reduction to allow shooting multiple frames in series and to apply noise reduction later during the post-editing stage. The images will have to be taken in raw data format.

Factory setting: **On**

- Select **Long exposure noise reduction** in the main menu
- Select **On/Off**

Under certain conditions, noise reduction will always be active as long as the function is enabled. That includes shots taken with the T function, as well as long-term exposure frames with shutter speeds of $\geq +8$ s.

In all other cases, noise reduction depends on a combination of factors (specifically ISO setting, exposure time, and sensor temperature). The following table contains a list of shutter speeds typical for a sensor temperature of 25°C, at which noise reduction would be applied.

ISO	Shutter speed longer than
100	7 s
200	6.4 s
400	5.9 s
800	5.4 s
1600	4.9 s
3200	4.5 s
6400	4.2 s
≥ 12500	3.8 s

NOISE REDUCTION IN JPG IMAGES

Except when high sensitivities are used, noise is luckily negligible. Nevertheless, noise reduction is a component of data processing when JPG files are generated. On the other hand, since it also has an effect on the focus review, you can optionally weaken or strengthen this noise reduction in comparison to the standard setting.

Factory setting: **Medium**

- Select **JPG Settings** in the main menu
- Select **Noise Reduction (JPG)**
- Select the desired setting
(**Low**, **Medium**, **High**)

Note

- This setting will only affect images in JPG format.

IMAGE STABILIZATION

The less favorable the lighting conditions during shooting, the slower will be the required shutter speeds for correct exposure. Visual image stabilization is a great tool for preventing out-of-focus images due to blurring.

Factory setting: **Panning Mode**



- Select **OIS** in the main menu
- Select the desired setting
(**On**, **Off**, **Panning Mode**)

DARK AREA OPTIMIZATION (IDR)

DYNAMIC RANGE

The contrast range of an object comprises all levels of brightness from the brightest to the darkest point in the image. All levels of brightness can be captured by the sensor, provided the contrast range of the object is lower than the dynamic range of the camera. In case of significant differences of brightness in the object (e.g. shootings of interior spaces with bright windows in the background, shootings with subject elements in shadow or directly lit by the sun, landscapes with dark areas and a very bright sky), the camera with its limited dynamic range will not be able to map the entire contrast range of the object. Information in 'edge areas' will be lost (under and overexposure).

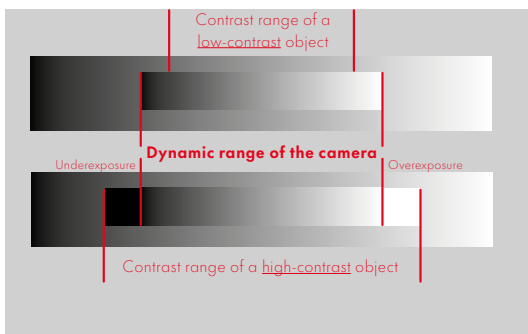

iDR FUNCTION

The **iDR** (Intelligent Dynamic Range) function allows an optimization of the darker areas. Object details become much clearer. This function will only affect images in JPG format.



You can specify beforehand if and to what extent you want to optimize darker areas (**High**, **Standard**, **Low**, **Off**). In the **Auto** setting, the camera will automatically select the right setting depending on the contrast range of the object. In addition to that setting, the effect also depends on the exposure settings. The function will have the strongest effect in combination with low ISO values and fast shutter speeds. The effect is less pronounced with higher ISO values and/or slower shutter speeds.

Factory setting: **Auto**

- Select **iDR** in the main menu
- Select the desired setting (**Auto**, **High**, **Standard**, **Low**, **Off**)

Notes

- The optimization of darker areas will slightly reduce differentiation in very bright areas.
- This function will only affect images in JPG format.

DATA MANAGEMENT

FORMATTING A MEMORY CARD

Memory cards that have already been in use with this camera will usually not require formatting. An unformatted memory card that is inserted into the camera for the first time must be formatted. We recommend formatting memory cards from time to time, because residual data traces (data pertaining to individual shots) may reduce the card's memory capacity.

- Select **Format Storage** in the main menu
- Confirm the selection
 - The status LED will flash during the process.

Notes

- Never switch off the camera while data transfer is in progress.
- All data stored on the memory card will be lost during formatting. Formatting will not be prevented by a deletion protection set for individual shots.
- All images should therefore be regularly transferred to a safe mass storage medium, e.g. the hard disk of a computer.
- A simple formatting process will initially not irretrievably destroy existing data on the card. Only the directory will be deleted, which means the data will no longer be directly accessible. Data access can be restored with appropriate software. Only data that is overwritten when new data is saved will actually be irretrievable.
- A memory card should be formatted again in the camera if it was formatted in another device, e.g. a computer.
- Contact your retailer or Leica Customer Care for assistance if the memory card cannot be formatted/overwritten (see p. 214).

DATA STRUCTURE

FOLDER STRUCTURE

The files (= photos) on the memory cards are saved in automatically generated folders. The first three characters signify the folder number (numerals), the last five the folder name (letters). The first folder is assigned the name "100LEICA", the second "101LEICA". A folder will always be created with the next available number; you can have max. 999 folders.

FILE STRUCTURE

The file names in these folders consist of eleven characters. In the factory settings, the first file is named "L1000001.XXX", the second "L1000002.XXX", etc. The first letter can be selected, the "L" from the factory settings denotes the camera brand. The first three characters signify the folder number (numerals). The next four digits denote the sequential file number. Once file number 9999 is reached, then a new folder will be automatically created, in which the file numbering begins at 0001 again. The last three places after the dot denote the file format (DNG or JPG).

Notes

- When using memory cards that were not formatted with this camera, the file numbering will begin with 0001 again. Should the memory card already contain a file with a higher number, then numbering will be continued from that number.
- A relevant message will be displayed on the LCD panel once folder number 999 and file number 9999 are reached, and all numbering must be reset.
- Format the memory card and reset the frame number right after to reset the folder number to 100.

EDIT FILE NAMES

- Select **Camera Settings** in the main menu
- Select **Edit File Name**
 - A keyboard submenu is displayed.
 - The input line contains the factory setting “L” as the first letter of the file name. Only this letter can be changed.
- Enter a letter of your choice (see p. 50)
- Confirm

Notes

- The change to a file name applies to all subsequent files or until a new change is made. The sequential number will not be affected; but it will be reset when a new folder is created.
- During a reset to factory settings, the first letter will always be reset to “L”.
- Lower case letters are unavailable.

LOGGING THE SHOOTING LOCATION (ONLY IN CONNECTION WITH THE LEICA FOTOS APP)

Location information can be sourced from a mobile device in connection with the Leica FOTOS app. Current location information will then be written to the Exif data of the images (geotagging).



- Activating GPS functions on a mobile device
- Activate Leica FOTOS and connect to the camera (see chapter “Leica FOTOS”)
- Activate geotagging for this camera in Leica FOTOS

Notes

- The use of GPS and associated technologies may be restricted in some countries or regions. Violations will be prosecuted by local authorities. You should therefore contact your travel agent or the embassy of your destination country for relevant information beforehand.
- It will take a few seconds for the Bluetooth connection to establish. The configured shutdown time should be considered when choosing a delay time if shutdown is enabled in the camera.
- All images with location information are marked with the geotagging icon in review mode.

GEOTAGGING STATUS

The status of existing location information is displayed on screen, provided the info bars are displayed and geotagging is enabled. The status screen will always show the current geotagging status.

	The location information is current (most recent geolocation max. 15 mins prior).
	The location information is not necessarily current anymore (most recent geolocation max. 12 h prior).
	The available location information is outdated (most recent geolocation more than 12 h in the past). No location data will be written to Exif data.
No icon	Geotagging is deactivated.

Location information will be continuously updated as long as the camera is connected to Leica FOTOS. The Bluetooth function of the camera and the mobile device must therefore remain enabled to ensure latest information. It is, however, not necessary for the app to be running in the foreground.

DATA TRANSFER

Data can be conveniently transferred to mobile devices via Leica FOTOS. Alternatively, a card reader can be used for the transfer.

PRACTICAL DEFAULT SETTINGS

TOUCH AF

Touch AF allows a direct placement of the AF frame.

Factory setting: **Touch AF**

- Select **Focusing** in the main menu
- Select **Touch AF**

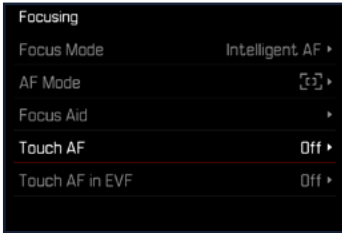

- Select **Touch AF**

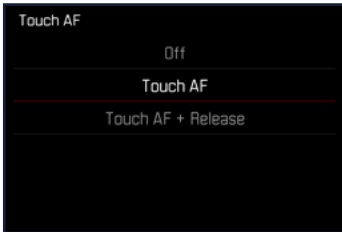

Positioning the AF frame

- Tap the LCD panel in the desired position

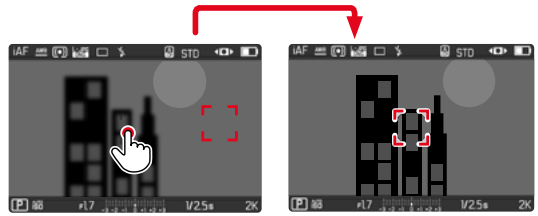

Notes

- This function is available with all AF metering methods except **Multi-Field**.
- If the metering method **Tracking** is selected, the focus frame will remain at the selected position and auto-focus commences when the shutter button is tapped. For all other AF metering methods, focusing occurs automatically.

TOUCH AF + SHUTTER BUTTON

The combination **Touch AF + Release** allows a direct placement of the AF frame for immediate recording.

- Select **Focusing** in the main menu
- Select **Touch AF**
- Select **Touch AF + Release**
- Tap the LCD panel in the desired position

TOUCH AF IN EVF MODE

Touch AF is deactivated by default when EVF is in use to prevent any inadvertent altering of the AF frame. AF Quick Setting (see p. 89) continues to be accessible. This function can also be disabled if that is not wanted (e.g. when focusing with the left eye).

Factory setting: **Off**

- Select **Focusing** in the main menu
- Select **Touch AF in EVF**
- Select the desired setting
(**On**, **Touchpad**, **Off**)
- **On**
 - Positioning the AF frame (tap)
 - Accessing the AF Quick Setting (tap and hold)
- **Touchpad**
 - Positioning the AF frame (tap) while the LCD panel is deactivated and EVF is activated.
- **Off**

AUXILIARY DISPLAYS

You can select a number of other displays in addition to the standard information contained in the header and footer to adapt the screen image to your needs. The following functions are available:

- Grid (only shooting mode, see p. 79)
- Focus Peaking (see p. 79)
- Clipping (see p. 81)
- Level Gauge (only shooting mode, see p. 80)
- Histogram (see p. 81)

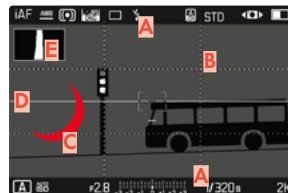

- A** Info Bars (= header and footer line)
- B** Grid
- C** Focus peaking
- D** Clipping
- E** Level gauge
- F** Histogram

- Select **Capture Assistants** in the main menu
- Select the desired function
- Select **On/Off**

INFO DISPLAYS IN SHOOTING MODE

Select one of the three available display options.

- Press the center button
 - The display cycles through the display options.



– No picture data



– Footer with exposure information, auxiliary displays



– Header with recording information, footer with exposure information, auxiliary displays

SHOW AVAILABLE

INFO BARS

The header and footer lines show the currently active settings and exposure values. See chapter “Displays” for a full list of the various displays (see p. 24).



Briefly showing/hiding information

- Tap and hold the shutter button
 - (Only) the exposure information and currently active auxiliary functions will be visible.

GRID

The grids divide the image frame into multiple fields. They facilitate pictorial composition and an exact camera orientation.



- Select **Capture Assistants** in the main menu
- Select **Grid**
- Select **On/Off**

FOCUS PEAKING

This assist function highlights the edges of in focus subject elements in color. The color can be user-specified. The sensitivity can be additionally adjusted.



HIGHLIGHT COLOR

Factory setting: **Red**

- Select **Focusing** in the main menu
- Select **Focus Aid**
- Select **Focus Peaking**
- Select the desired setting
(**Off**, **Red**, **Green**, **Blue**, **White**)

Note

- **Focus Peaking** is only available in MF mode.

LEVEL GAUGE

The integrated sensors of the camera show its orientation. These indicators ensure exact camera orientation along the longitudinal and transverse axes of critical objects, e.g. architecture.

Deviations in relation to the longitudinal axis (i.e. when the camera is tilted up or down in the direction of view) are indicated by a short line in the center of the image (1).

Deviations in relation to the transverse axis (when the camera is tilted to the left or right) are indicated by two long lines to the left and right of the image center (2).

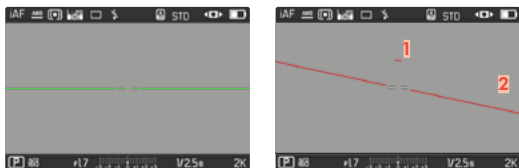

→ Select **Capture Assistants** in the main menu

→ Select **Level Gauge**

→ Select **On/Off**

Note

- The camera will switch the aspect of the level gauge autonomously for shoots in vertical format.

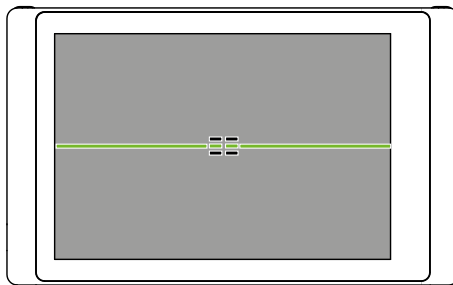

Correct alignment

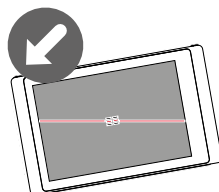

Tilted laterally to the left

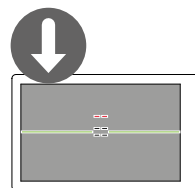

Tilted downward in the direction of view

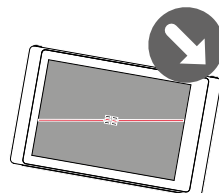

Tilted laterally to the right

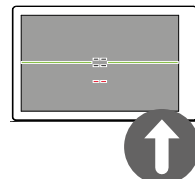

Tilted upward in the direction of view

CLIPPING

The Clipping display marks very bright image areas. This function is a very easy and exact tool for checking the correct exposure setting. Overexposed areas flash black.



- Select **Capture Assistants** in the main menu
 - Select **Clipping / Zebra**
 - Select **On/Off**
-
- Tap and hold the shutter button
 - The clipping display appears.

HISTOGRAM

Histogram represents the brightness distribution in the image. The horizontal axis shows the graduated values from black (left) through gray to white (right). The vertical axis corresponds to the number of pixels at each brightness level.

This type of rendering allows an additional quick and easy assessment of the exposure setting.

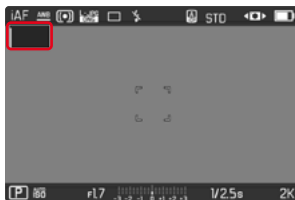

- Select **Capture Assistants** in the main menu
- Select **Histogram**
- Select **On/Off**

Notes

- The histogram is always based on the brightness displayed; depending on the settings used, it may not represent the final exposure.
- In shooting mode, the histogram should be regarded as a "trend indicator".
- The histogram during rendering may differ slightly from the one during exposure.
- The Histogram always refers to the currently displayed cropped section of the image.
- Double tap the LCD panel to change the screen position of the histogram.

TEMPORARY ACTIVATION/DEACTIVATION OF INDIVIDUAL FUNCTIONS

The following assist functions can be activated/deactivated temporarily:

- Focus peaking
- Clipping
- Assigning the desired assist function to a function button (see p. 54)
- Press the corresponding function button
 - The status of the assist function toggles On/Off.
 - A relevant indicator appears in the screen image.



The temporary setting is reset when the camera is switched off.

MF ASSIST FUNCTIONS

AF ASSIST LAMP

The integrated AF assist lamp allows operation of the AF system in unfavorable lighting conditions. This lamp comes on while metering is performed, provided the function is activated.

Factory setting: On

- Select **Focusing** in the main menu
- Select **Focus Aid**
- Select **AF Assist Lamp**
- Select On/ Off

Notes

- The AF assist lamp illuminates an area of up to approx. 5 m.
- The AF assist lamp switches off automatically, once focusing was successful (AF frame is green) or has failed (AF frame is red).

PHOTOGRAPHY

The settings described in this chapter only apply for photo mode. They are therefore part of the photo menu and must always be accessed and configured from within photo mode (see chapter "Camera operation" in the section "Menu Control"). Any menu items of the same name in the video menu are entirely independent of these.

DRIVE MODE

The functions and settings described in the following generally refer to the exposure of individual shots. In addition to single frame shooting, the Leica D-Lux 8 offers a number of other exposure modes. Please read the relevant sections for information about functionalities and setting options.

- Select **Drive Mode** in the main menu
- Select the desired function options

Mode	Setting options / Variants
Single frame shooting	Single
Continuous shooting (see p. 110)	Speed: <ul style="list-style-type: none">- Continuous Shooting - 2 fps, 12 bit, AF- Continuous Shooting - 7 fps, 10 bit- Continuous Shooting - 11 fps, 10 bit
Interval shooting (see p. 111)	Number of Frames Interval between the shootings (Interval) Delay time (Countdown)
Exposure bracketing (see p. 113)	Number of Frames (3, 5 or 7) EV Steps Automatic
Self-timer (see p. 114)	Delay time: <ul style="list-style-type: none">- Self-timer 2 s- Self-timer 12 s

ZOOM

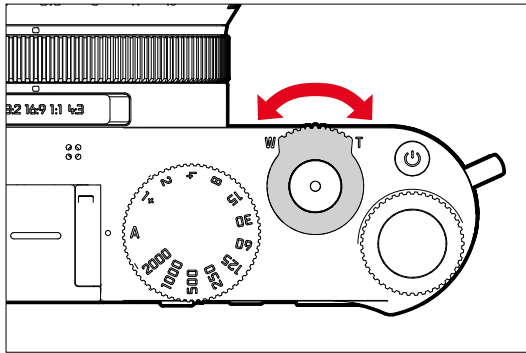

Several other zoom levels are available in addition to the Leica DC Vario-Summilux 10.9-34 f/1.7-2.8 ASPH. image section. These roughly correspond to (equivalent 35 mm 24–75 mm) 10.9/34 mm focal lengths. The image section visible in the final frame appears in the display. The magnification level is displayed as an equivalent focal length, i.e. the system displays the focal length corresponding to the image section shown.



FOCUSING

Your Leica D-Lux 8 allows automatic as well as manual focusing. There are 3 operating modes and 4 metering methods available for AF photography.

AF PHOTOGRAPHY

- Turn the focus mode setting dial to the **AF** position
- Position the AF frame as needed
- Tap and hold the shutter button
 - Focusing occurs one time (AFs) or continuously (AFc).
 - Metering was successful: The AF frame lights up green.
 - Metering was unsuccessful: The AF frame lights up red.
 - Alternatively, focus and/or exposure settings can be configured and saved via one of the function buttons ("Exposure lock", see p. 106).
- Shutter release

MF PHOTOGRAPHY

- Set the focus mode setting dial to the **MF** position
- Use the focus ring to manually focus on the object
- Shutter release

Please read the following chapters for more information.

AUTOFOCUS MODES

The following AF modes are available: **AFs**, **AFc** and **Intelligent AF**. The currently selected AF mode is shown in the header line.

Factory setting: **Intelligent AF**

- Select **Focusing** in the main menu
- Select **Focus Mode**
- Select the desired setting
(**Intelligent AF**, **AFs**, **AFc**)

INTELLIGENT AF

Suitable for all objects. The camera automatically selects between AFs and AFc.

AFs (single)

Suitable for objects with little or no movement. Focusing is done only once and the setting remains as long as the shutter button is held at the pressure point. That also applies if the AF frame is pointed at another object.

AFc (continuous)

Suitable for objects in motion. As long as the shutter button is held at the 1st pressure point, focusing is continuously adjusted to the object in the AF frame.

AUTOFOCUS METERING METHODS

The AF mode offers various metering methods for focusing. A successful focus setting is identified by a green frame, an unsuccessful one is shown in red.

Factory setting: **Multi-Field**

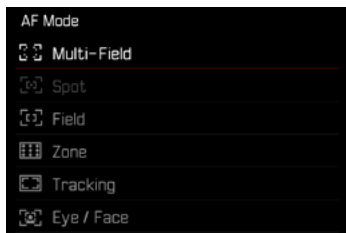

- Select **Focusing** in the main menu
- Select **AF Mode**
- Select the desired setting
(**Multi-Field**, **Spot**, **Field**, **Zone**, **Tracking**, **Eye / Face**)

Notes

- AF focusing can be unsuccessful:
 - if the distance to the object is too great (macro mode) or too small
 - if the object is not sufficiently illuminated
- Touch AF allows a direct placement of the AF frame. See p.76 for more information.

MULTI-FIELD METERING

Several focus areas are detected automatically. This function is particularly useful for snapshots.

SPOT/FIELD METERING

Both methods detect only those parts of the object that are within the relevant AF frames. The metering fields are indicated by a small frame (field metering) or a cross (spot metering). The very small measuring range for spot metering allows focusing on tiny details of the subject.

The slightly larger measuring range in field metering is less critical for focusing, but still permits selective metering.

These metering methods can also be used for serial exposures in which the part of the object you want to focus on will always be at the same off-center position in the image.

Simply move the AF frame to another position (see p.90).

ZONE

With this metering method, subject sections are recorded with a coherent group comprising 5 x 5 fields. This function combines some security for snapshots with the option of aiming at larger objects reliably.

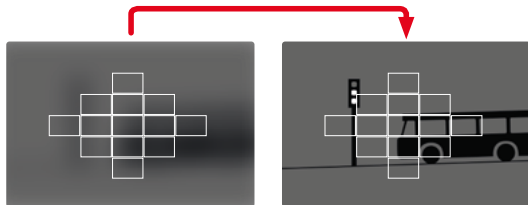

Once the setting has been made, the focus frames are displayed where object sections are displayed in focus.

TRACKING

This field metering variant helps in the capture of moving objects. The focus on the object in the focus frame is continuously adjusted, once it is detected.

- Aim the focus frame at the desired object (by panning the camera shifting the focus frame)
- Tap and hold the shutter button

or

- Press the function button (provided it was assigned the function **AF-L** or **AF-L + AE-L**, see p. 106)
 - The camera focuses on the object.
- Pan the camera to the desired cropped section
 - The focus frame “tracks” the saved object and focus is continuously adjusted.

Note

- This metering method focuses continuously, even if the AF mode **AFs** was set.

PERSON DETECTION (EYE/FACE DETECTION)

In this metering method, the camera automatically detects faces in the image field. The focus is set automatically on the faces closest to the camera. Field metering is used if no faces are detected.

When face detection detects an eye, the focus will be on that eye. Should more than one eye be detected, then the user can choose the eye to focus on. The currently selected eye will be highlighted.

Additionally, the desired face can be easily selected if there are several faces in the frame.



toggling between faces and/or eyes

→ Press the directional pad in the relevant direction

AF QUICK SETTING

The AF Quick Setting allows quick changes to the focus frame size in some AF metering methods.

The screen image will remain visible continuously while settings are being adjusted.

ACCESSING AF QUICK SETTING

→ Tap the LCD panel

- All auxiliary displays are hidden.
- Red triangles appear at two corners of the focus frame if the metering method **Field/Zone/Eye/Face/Body Detection/Eye/Face/Body + Animal Detection** is set.



ADJUSTING THE AF FRAME SIZE

(**Field/Zone/Eye/Face/Body Detection/Eye/Face/Body + Animal Detection** only)

→ Turn the thumbwheel

or

→ Two-finger pinch/spread

- The size of the AF frame is adjustable in 3 increments.

MF ASSIST FUNCTIONS

AF ASSIST LAMP

The integrated AF assist lamp allows operation of the AF system in unfavorable lighting conditions. This lamp comes on while metering is performed, provided the function is activated.

See p. 82 for settings.

ACOUSTIC AF CONFIRMATION

You can set an acoustic confirmation signal for successful focus metering in AF mode (see p. 63).

SHIFTING THE AF FRAME

All AF metering methods permit shifting the AF frame before focusing.

→ Press the directional pad in the relevant direction
or

→ Tap the LCD panel in the desired position
(While Touch AF is activated)

Notes

- The focus frame will remain at the most recently used position for this AF metering method even if the user changes the AF metering method or the camera is switched off.
- The metering fields are joined together when the exposure metering method **Spot** is combined with the AF metering methods **Spot**, **Field** and **Zone**. Exposure metering will then occur at the point specified by the AF frame, even if it is moved.

MANUAL FOCUSING (MF)

Focusing manually may in some situations be a better choice than autofocus.

- the same setting is used for several shoots
- it would take longer to use the metering memory lock function
- the setting is to be kept at infinity for landscape pictures
- poor, i.e. very dark lighting conditions prevent AF operation or would slow it down

→ Set the focus mode setting dial to the **MF** position

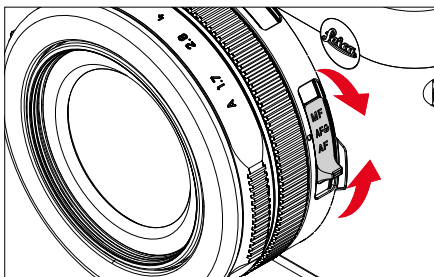

→ Turn the focus ring until the desired part of the object is in clear focus

MF ASSIST FUNCTIONS

The following assist functions are available in MF mode.

FOCUS PEAKING

This assist function highlights the edges of in focus subject elements in color. The color can be user-specified. The sensitivity can be additionally adjusted. See p. 79 for settings.

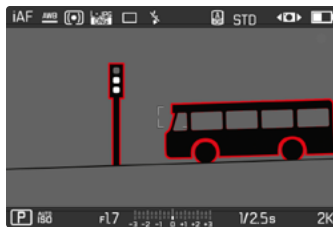

→ Select **Focusing** in the main menu

→ Select **Focus Aid**

→ Select **Focus Peaking**

→ Select the desired setting
(Off, Red, Green, Blue, White)

→ Select an image section

→ Turn the focus ring to mark the desired subject elements

Note

- Focus peaking is based on subject contrast, i.e. differences between light and dark. As a result, high contrast subject elements could be marked, even if they are not completely in focus.

ENLARGEMENT IN MF MODE

The larger the details of the object are shown, the better you can assess their sharpness and the more accurately you can focus.

This function can be automatically activated during manual focusing or can be accessed independently.

ACCESS VIA THE FOCUS RING

Turning the focus ring will automatically enlarge a image section.

- Select **Focusing** in the main menu
- Select **Focus Aid**
- Select **Auto Magnification**
- Select **On**
- Turn the focus ring
 - An enlarged image section appears. The position of the enlargement depends on the position of the AF frame.
 - The rectangle within the frame at the top right represents the current magnification, as well as its position in the displayed cropped section.

Adjusting the enlargement function

- Turn the thumbwheel
 - The image section toggles between magnification factors.

Changing the position of the enlarged section

- Press the directional pad in the relevant direction
- Use touch control for shifting

Exiting the enlargement function

- Tap the shutter button

Notes

- The enlargement will automatically return to normal viewing size about 5 s after the last movement of the focus ring.
- The most recently magnification function will still be active the next time the feature is accessed.

MACRO FUNCTION

The working range for the focus setting can be switched quickly and easily from the standard focus range (30 cm to infinity) to the macro range (17 cm to 30 cm) using the macro ring. AF and MF mode are available in both ranges.

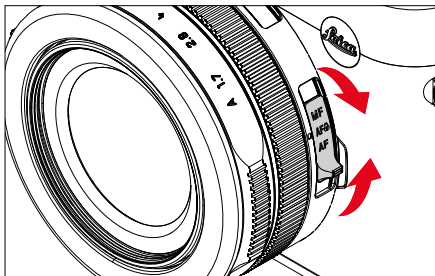

→ Turn the focus mode setting dial to the **AF** position

ISO SENSITIVITY

The ISO setting covers a range between ISO 100 and ISO 25000, allowing you to adapt to the relevant situation as required.

There is more leeway for the use of preferred shutter-speed/aperture combinations when choosing an automatic ISO setting. You can set priorities within the scope of the automatic setting, e.g. for reasons of pictorial composition.

Factory setting: **Auto ISO**

FIXED ISO VALUES

Values between ISO 100 and ISO 25,000 are available for selection. Manual ISO setting occurs initially in full EV steps.

- Select **ISO** in the main menu
- Select the desired value

Note

- When high ISO values are used or the image is edited later, image noise, as well as vertical and horizontal stripes may become visible, particularly in larger, evenly lit areas of the object.

AUTOMATIC SETTING

The camera automatically adjusts the sensitivity to ambient brightness and/or to the configured shutter-speed/aperture combination. In conjunction with aperture-priority mode, this function extends the range for automatic exposure control. The automatic setting of ISO sensitivity occurs in increments of 1/3 EV.

- Select **ISO** in the main menu
- Select **Auto ISO**

LIMITING SETTING RANGES

A max. ISO value can be set, which will then limit the automatic setting (**Maximum ISO**). A max. exposure time can also optionally be configured. There are automatic settings and fixed max. shutter speeds **1/2**s and **1/2000**s available for that purpose.

Separate settings are available for flash photography.

LIMITING ISO VALUES

All values from ISO 200 are available.

Factory setting: **6400**

- Select **Auto ISO Settings** in the main menu
- Select **Maximum ISO**
- Select the desired value

LIMITING SHUTTER SPEED RANGES

Factory setting: **Auto**

- Select **Auto ISO Settings** in the main menu
- Select **Shutter Speed Limit**
- Select the desired value
(**Auto**, **1/2000**, **1/1000**, **1/500**, **1/250**, **1/125**, **1/60**, **1/30**, **1/15**, **1/8**, **1/4**, **1/2**)

WHITE BALANCE

In digital photography, White Balance ensures neutral color rendering in any light. White Balance relies on the setting made in the camera, which light color is to be rendered as 'white'.

Four methods are available:



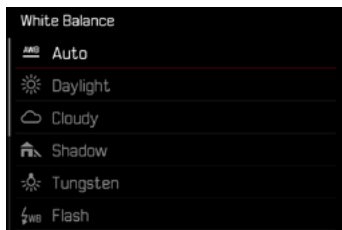

- automatic control
- fixed presets
- manual setting via metering
- direct setting of the color temperature

Factory setting: **Auto**



AUTOMATIC CONTROL/FIXED SETTINGS

- **Auto**: for automatic control, which delivers neutral results in most situations
- Various fixed presets for most frequently encountered light sources:

	Daylight	For outdoor shootings in sunlight
	Cloudy	For outdoor shootings in cloudy conditions
	Shadow	For outdoor shootings with the main subject in shadow
	Tungsten	For indoor shootings with (predominantly) incandescent lamp light
	Flash	For flash photography

- Select **White Balance** in the main menu
- Select the desired setting

MANUAL SETTING VIA METERING

Gray Card

This metering variant captures all color hues in the metering field and uses these to calculate a mean gray value.

- Select **White Balance** in the main menu
- Select  **Gray Card**
 - The following appears on the LCD panel:
 - the image based on automatic white balance
 - a frame in the center of the image

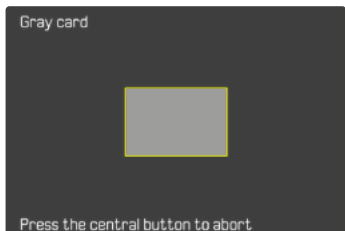

- Aim the metering field at a white or neutral gray area
 - The screen image changes dynamically in line with the reference area in the frame.

Performing measurement

- Shutter release
 - The measurement is taken.

Cancelling measurements

- Press the center button

Note

- A value configured using this method will remain unchanged (i.e. it will be used for all subsequent photographs) until new measurements are taken or one of the other white balance settings is selected.

DIRECT SETTING OF THE COLOR TEMPERATURE

Values between 2500 and 10000 K (Kelvin) can be set directly. That gives you a very wide range, which covers virtually all color temperatures occurring in real life and within which you can adapt color rendering to any light color and your personal preferences with incredible detail.

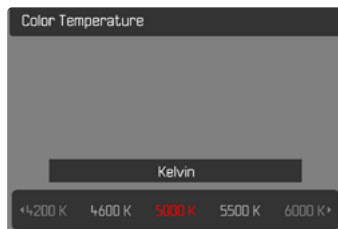

- Select **White Balance** in the main menu
- Select **Color Temperature**
- Select the desired value

EXPOSURE

SHUTTER TYPE

The Leica D-Lux 8 comes equipped with a mechanical shutter and a purely electronic shutter function. The electronic shutter expands the available shutter area and functions completely noiseless, which may be important in some work environments.

Factory setting: **Hybrid**

→ Select **Shutter Type** in the main menu

→ Select the desired setting
(**Mechanical**, **Electronic**, **Hybrid**)

Mechanical	Only the mechanical shutter is used. Working range: 120 s to 1/2000 s.
Electronic	Only the electronic shutter function is used. Working range: 1 s to 1/16000 s.
Hybrid	You can add the electronic shutter function if you need faster shutter speeds than can be achieved with the mechanical shutter. Working range: 120 s to 1/2000 s + 1/2500 s to 1/16000 s.

USE

The classic shutter sound of the mechanical shutter conveys an auditive feedback. It is well suited for long-term exposures, as well as for shots of moving objects.

The electronic shutter function allows photography with an open aperture in very bright due to very fast shutter speeds. The distinctive “rolling shutter” effect makes it less suitable for moving objects.

Notes

- The electronic shutter function does not allow flash photography.
- The electronic shutter function in combination with fast shutter speeds can result in stripe effects on the images when used with LED or fluorescent tube lighting.

EXPOSURE METERING METHODS

The following exposure metering methods are selectable.

Factory setting: **Multi-Field**

 Spot

 Center-weighted

 Multi-field

- Select **Exposure Metering** in the main menu
- Select the desired metering method (**Spot**, **Center-Weighted**, **Multi-Field**)
 - The selected metering method is displayed in the header line of the screen image.

Spot metering allows a shifting of the focus point:

- Press the directional pad in the relevant direction

Notes

- The exposure information (ISO value, aperture, shutter speed and light balance with exposure compensation scale) will help to determine the settings required for correct exposure.

SPOT

This metering method is concentrated exclusively on a small area in the center of the image. The metering fields are joined together when the exposure metering method **Spot** is combined with the AF metering methods **Spot** and **Field**. Exposure metering will then occur at the point specified by the AF frame, even if it is moved.

CENTER-WEIGHTED

This method considers the entire image field. The subject elements captured in the center will, however, impact on the calculation of the exposure value more so than areas around the edges.

MULTI-FIELD

This metering method is based on the detection of multiple values. These values are used in an algorithm to calculate an exposure value appropriate for a good rendering of the assumed main subject.

EXPOSURE MODES

There are four exposure modes available to adjust the rendering of the object or to create the desired pictorial composition:

- Program AE mode (**P**)
- Aperture-priority mode (**A**)
- Shutter-priority mode (**S**)
- Manual setting (**M**)

These four “classic” modes are accessed via a relevant setting of the shutter-speed dial and the aperture ring. A correct setting for the menu item **Scene Mode** (see p. 115) is prerequisite for the use of **P**, **A**, **S** and **M**. The menu item **P-A-S-M** must be selected. Should one of the 10 object and situational automatic program variants be selected instead, then that setting will take precedence over the settings of the physical control elements. The shutter-speed dial and the aperture ring will in that case have no assigned function.

SELECTING A MODE

The four operating modes are activated automatically via the following setting combinations:

	Setting via the shutter-speed dial	Setting via the aperture ring
P	A	A
A	A	manual setting (not A)
S	manual setting (not A)	A
M	manual setting (not A)	manual setting (not A)

- Select **Scene Mode** in the main menu
- Select **P-A-S-M**
- Set the shutter-speed dial to the relevant position
- Set the aperture ring to the relevant position

FULLY AUTOMATIC EXPOSURE SETTING – P

PROGRAM AE MODE – P

The program AE mode facilitates fast and fully automatic photography. The exposure is controlled by an automatic shutter speed and aperture setting.

- Select **Scene Mode** in the main menu
 - Select **P-A-S-M**
 - Turn the shutter-speed dial to the **A** position
 - Turn the aperture ring to the **A** position
 - Tap and hold the shutter button
 - Exposure information is displayed at the bottom of the screen. This contains the automatically set value pair of aperture setting and shutter speed.
 - All other visible displays of the info bars will be hidden.
 - Shutter release
- or
- Adjusting the automatically set value pair (Program shift)

CHANGING THE PRESET SHUTTER SPEED AND APERTURE COMBINATIONS (SHIFT)

Changing the preset values using the Shift function combines the reliability and speed of fully automatic exposure control with the opportunity to vary the speed/aperture combination selected by the camera at any time to fit in with your own ideas and intentions. The overall exposure, i.e. the brightness of the image, remains unchanged. Faster shutter speeds are a good choice for e.g. sports pictures, while longer speeds will offer more depth of field for e.g. landscape pictures.

- Turn the thumbwheel to the left/right (right = greater depth of field with slower shutter speeds, left = faster shutter speeds with lesser depth of field)
 - Shifted value pairs are marked with an asterisk next to the **1/1000**.

Note

- The adjustment range is limited to guarantee correct exposure.

SEMI-AUTOMATIC EXPOSURE SETTING – A/S

APERTURE-PRIORITY MODE- A

Aperture-priority mode sets the exposure automatically according to the manually selected aperture. This mode is suitable for shots in which the depth of field is a critical compositional element.

A correspondingly small aperture value will allow you to shrink the depth of field range. This can be helpful when e.g. offsetting the highly focused face in a portrait against an unimportant or distracting background. Conversely, you can use a higher aperture value to increase the depth of field range, so that everything from the foreground to the background will be in full focus in a landscape shot.

- Select **Scene Mode** in the main menu
- Select **P-A-S-M**
- Turn the shutter-speed dial to the **A** position
- Set the desired aperture value
- Tap and hold the shutter button
 - Exposure information is displayed at the bottom of the screen. This contains the automatically set value pair of aperture setting and shutter speed.
 - All other visible displays of the info bars will be hidden.
- Shutter release

SHUTTER-PRIORITY MODE – S

Shutter-priority mode will set exposure automatically according to the manually selected shutter speed. It is therefore particularly suitable for pictures of moving objects, where the sharpness of the movement depicted is a critical picture composition element.

An appropriately fast shutter speed can help to avoid e.g. unwanted motion blurring and will “freeze” the object. Conversely, an appropriately longer shutter speed can help create a better feeling of motion in the image with targeted “tracer effects”.

- Select **Scene Mode** in the main menu
 - Select **P-A-S-M**
 - Turn the aperture ring to the **A** position
 - Set the desired shutter speed
 - using the shutter-speed dial: in full increments
 - using the thumbwheel: fine tuning in 1/3 increments
 - Tap and hold the shutter button
 - Exposure information is displayed at the bottom of the screen. This contains the automatically set value pair of aperture setting and shutter speed.
 - All other visible displays of the info bars will be hidden.
 - Shutter release
- Note**
- Fine tuning can alternatively be done via the status screen. Depending on the thumbwheel assignment, this may be the only option (see p. 55).



MANUAL EXPOSURE SETTING – M

The following manual settings for shutter speed and aperture are a good choice:

- to create a special image mood that can only be achieved with a very specific type of exposure
- to ensure a perfectly identical exposure for multiple images with different cropped sections

- Select **Scene Mode** in the main menu
- Select **P-A-S-M**
- Set the desired exposure manually (using the shutter-speed dial and the aperture ring of the lens)
 - The exposure compensation is done using the scale of the light balance.
- Tap and hold the shutter button
 - Exposure information is displayed at the bottom of the screen.
 - All other visible displays of the info bars will be hidden.
- Shutter release

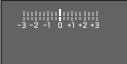
Displays on the light balance:

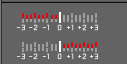
	Correct exposure
	Underexposure or overexposure by the displayed value
	Underexposure or overexposure by more than 3 EV (Exposure Value)

Notes

- The screen image will show an exposure preview if **P-A-S-M** is selected in the menu item **Exposure Preview** (after exposure metering, see p. 106).
- The shutter-speed dial must be clicked to one of the engraved exposure shutter speeds.

SETTING SHUTTER SPEEDS

The shutter speed is set in two steps.
using the shutter-speed dial: in full increments
using the thumbwheel: fine tuning in 1/3 increments

Shutter-speed dial	Thumbwheel
All settings from 2 to 1000	Fine tuning the shutter speed in 1/3 EV increments, max. $\pm 2/3$ EV
Set to 1+	Longer shutter speeds than 1s (0.6s to 60s in 1/3 EV increments)
Set to 2000	Shorter shutter speeds than 1/1000s (1/1250s to 1/16000s in 1/3 EV increments)

EXAMPLES FOR SHUTTER SPEED FINE TUNING SETTINGS

- set shutter speed 1/125s + move the thumbwheel one click to the left = 1/100s
- set shutter speed 1/500s + move the thumbwheel two clicks to the right = 1/800s

Note

- Fine tuning can alternatively be done via the status screen. Depending on the thumbwheel assignment, this may be the only option (see p. 55).

LONG-TERM EXPOSURE

FIXED SHUTTER SPEEDS

Your Leica D-Lux 8 allows shutter speeds up to 1 min in modes **S** and **M** (depending on the selected ISO setting). The remaining exposure time after shutter release is counted down in seconds on the display for shutter speeds greater than 1 s.

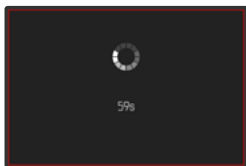
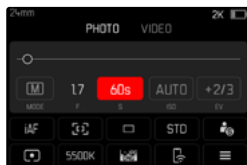

- Set the shutter-speed dial to **1+**
- Select the desired shutter speed
(Must be done via fine tuning of the shutter speed, see p.103)
- Shutter release

T FUNCTION

In this setting, the shutter remains open after shutter release until the shutter button is pressed again (ax. 1 min depending on ISO setting).

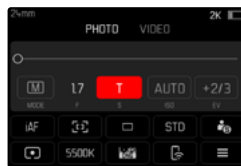

- Set the shutter-speed dial to **1+**
- Set the aperture ring to a fixed value
- Select **T** as the shutter speed
(Must be done via fine tuning of the shutter speed, see p.103)
- Shutter release

Notes

- The maximum selectable shutter speed depends, among other things, on the setting of the menu item **Shutter Type**, see p.97. The T function is available only if **Shutter Type** is set to **Mechanical** or **Hybrid**.
- The remaining exposure time after shutter release is counted down in seconds on the display for shutter speeds greater than 1 s.

NOISE REDUCTION

Image noise becomes more apparent when using higher sensitivities, particularly on uniform dark areas. Long exposure times may cause severe image noise. In order to reduce this annoying phenomenon, the camera will take a second “dark frame” (taken with the shutter closed) automatically after a shooting with slow shutter speed and high ISO value. The noise metered in this parallel shot will then be “subtracted” digitally from the data for the actual shot. In such cases the message **Noise reduction in progress...** will appear with a relevant time value.

This “exposure time” doubling must be taken into account in long-term exposures. The camera must not be switched off during that time. We recommend disabling Noise Reduction to allow shooting multiple frames in series and to apply noise reduction later during the post-editing stage. The images will have to be taken in raw data format.

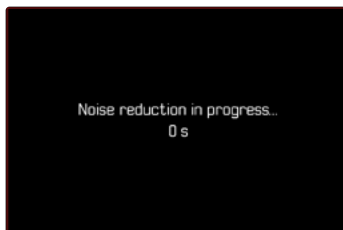

Under certain conditions, noise reduction will always be active as long as the function is enabled. That includes shots taken with the T function, as well as long-term exposure frames with shutter speeds of $\geq +8$ s.

In all other cases, noise reduction depends on a combination of factors (specifically ISO setting, exposure time, and sensor temperature). The following table contains a list of shutter speeds typical for a sensor temperature of 25°C, at which noise reduction would be applied.

ISO	Shutter speed longer than
100	7 s
200	6.4 s
400	5.9 s
800	5.4 s
1600	4.9 s
3200	4.5 s
6400	4.2 s
$\geq 12\,500$	3.8 s

Noise Reduction can be optionally deactivated (see p. 69).

EXPOSURE CONTROL

EXPOSURE PREVIEW

The brightness of the screen image mirrors the effects of the selected exposure settings when pressing and holding the shutter button on the first pressure point. That allows an assessment the effect of the relevant exposure setting on the image before taking the photo. This will apply as long as the subject brightness and the set exposure don't result in excessively low or high brightness values.

This function can be disabled for the manual exposure setting (**M**).

Factory setting: **P-A-S-M**

- Select **Exposure Preview** in the main menu
- Select **P-A-S** (only in program AE, aperture-priority AE and shutter-priority AE mode) or **P-A-S-M** (also for manual setting)

Notes

- Depending on ambient lighting conditions, the brightness of the screen image may differ from that of the actual images, despite the settings described above. The screen image will appear considerably darker than the – correctly exposed – picture. That is particularly the case in long-term exposures.
- The exposure preview will also be displayed if exposure metering is done via another control element (e.g. using the function button, provided it was assigned the **AE-L** function).

EXPOSURE LOCK

We often want to arrange important subject elements outside the center of the image for reasons of pictorial composition and these elements may sometimes be very bright or very dark. Center-weighted metering and spot metering, however, mainly capture an area in the center of the image and are calibrated to an average gray scale value.

In that case, the exposure lock initially allows a metering of the main subject, as well as storing of the relevant settings until the final image section is set. The same applies for focusing (AF-L) in any autofocus mode.

Usually both lock functions (focusing and exposure) are done at the same time with the shutter button. Additionally, you can divide the memory functions between the shutter button and the function button, or assign both to a function button.

The functions include settings and storage.

AE-L (AUTO EXPOSURE LOCK)

The camera stores the exposure value. The focus can therefore be set on another object, no matter which exposure value is selected.

AF-L (AUTO FOCUS LOCK)

The camera stores the focus setting. That makes it easier to change the image section when focusing is fixed.

AE-L/AF-L

With this option enabled, the camera stores the exposure value and the focus setting when the assigned button is pressed and held.

Notes

- An exposure lock doesn't make much sense in conjunction with multi-field metering, because a targeted capture of an individual object element will not be possible.
- Any previously set exposure lock will be removed by a manual setting of the aperture ring or the shutter-speed dial.

EXPOSURE LOCK IN AF MODE

The metering functions are distributed as follows while the function button is pressed and held:

Function button assignment	Function button	Shutter button
AF-L + AE-L	Exposure and focus	No function
AF-L	Sharpness	Exposure
AE-L	Exposure	Sharpness

The shutter button will retain both functions, provided no exposure lock is done via the function button.

Via the shutter button

- Aim at the key part of the object or at a similar detail
- Tap and hold the shutter button
 - The measurement is taken and saved.
- Pan the camera to capture the final image section while keeping the shutter button pressed
- Shutter release

Via a function button

- Assign the desired memory lock (AF-L + AE-L, AE-L, AF-L) to one of the function buttons
- Aim at the object
- Press the function button
 - The measurement is taken and saved.
 - A small padlock icon with the letters AE appear at the bottom left of the screen to signify that the exposure value was saved.
 - A green AF frame signifies that the focusing was saved.
- Store more measurements via the shutter button as needed
- Select the final image section
- Shutter release

EXPOSURE LOCK IN MF MODE

In MF mode, only the exposure can be locked via the shutter button. Similarly, the function button will only have that one function (with an assignment of AF-L + AE-L or AE-L).

EXPOSURE COMPENSATION

Exposure meters are calibrated for a medium gray scale value, which matches a standard, i.e. average image object. Should the measured image detail not fulfill that requirement, then the a relevant exposure compensation can be effected.

Specifically where several shots are taken in sequence, for example if for a series a slightly lesser or greater exposure is desired for a particular reason, then exposure compensation can be a very useful function: Unlike with exposure lock, the setting remains active until it is reset. Exposure compensation values can be set in the range ± 3 EV in $1/3$ EV increments (EV: Exposure Value).

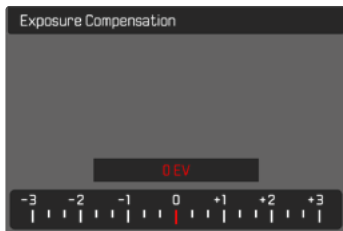

A Set compensation value (marks at 0 = Off)

Using thumbwheel control

- Select **Thumb Wheel** in the main menu
- Select **Exposure Compensation**
- Set the desired value using the thumbwheel

Using menu control

- Select **Exposure Compensation** in the main menu
 - A scale appears as a submenu item on the LCD panel.
- Set the value on the scale
 - The set value is displayed above the scale.

Notes

- While setting the value, you can see the effect on the screen image, which becomes darker or lighter.
- The following applies for set compensation values, no matter how they were initially set: They remain effective until they are manually reset to 0, even if the camera is switched off and on again in the meantime.
- The set exposure compensation is indicated by a mark on the exposure compensation scale in the footer line.

SHOOTING MODES

CONTINUOUS SHOOTING

The camera is set to single shots by default (Single). Series of shots can also be created to e.g. capture motion sequences at various stages.

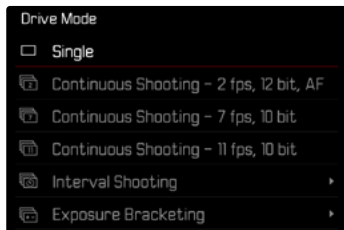

→ Select **Drive Mode** in the main menu

→ Select the desired setting

(**Continuous Shooting - 2 fps, 12 bit, AF**, **Continuous Shooting - 7 fps, 10 bit**, **Continuous Shooting - 11 fps, 10 bit**)

Once you have finalized your settings, the camera will do continuous shootings as long as you keep the shutter button pressed down fully (and you have sufficient space on your memory card).

Notes

- We recommend deactivating the preview mode (**Auto Review**) when using this function.
- Regardless of how many frames were taken in a series, the last image in the series or the last image saved on the memory card while the saving process is ongoing will be displayed first in both review modes.
- Continuous shooting is not possible if a flash is used. Only a single shot will be taken if the flash function is activated.
- Continuous shooting mode is not available in combination with the self-timer function.
- The buffer memory of the camera only allows a limited number of frames in series and in the selected exposure frequency. The exposure frequency is reduced, once the capacity limit of the camera's buffer memory is reached. This slow-down is due to the time required to transfer the data from the buffer memory to the card. The remaining number of exposures is displayed at the bottom right.
- The following applies for continuous shooting with 2 fps – 4 fps:
Automatic settings (exposure settings in operating modes **P/A/S**, automatic white balance and autofocus) are implemented individually for each frame.
- The following applies for continuous shooting with 7 fps – 15 fps:
Automatic settings (exposure settings in operating modes **P/A/S**, automatic white balance and autofocus) are implemented for the first frame, and are then applied for each subsequent frame in the same picture series.

INTERVAL SHOOTING

You can use the camera to automatically record motion sequences over longer periods of time as interval recordings. You determine the number of shots, the interval between the start times of the individual shots and the start of the series. Please note that the exposure and focus settings may change over the course of the recording. The minimum duration of an interval depends on the selected exposure time.

SPECIFYING THE NUMBER OF FRAMES

- Select **Drive Mode** in the main menu
- Select **Interval Shooting**
- Select **Number of Frames**
- Enter the desired value

SPECIFYING THE INTERVALS BETWEEN SHOTS

- Select **Drive Mode** in the main menu
- Select **Interval Shooting**
- Select **Interval**
- Enter the desired value

SETTING THE DELAY TIME

- Select **Drive Mode** in the main menu
- Select **Interval Shooting**
- Select **Start Time**
- Enter the desired value

Note:

Make sure that the recording interval is at least equal to the exposure time. Otherwise, time overlaps may occur, causing individual recordings to be omitted or skipped.

Getting started

- Press the shutter button
 - The LCD panel will switch off automatically between recordings. Tapping the shutter button reactivates the LCD panel.
 - The remaining time until the next shot and its sequential number is displayed at the bottom right.

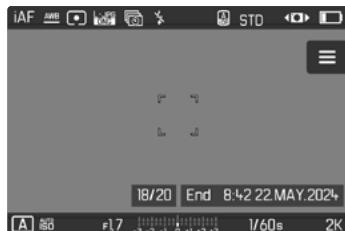

Cancelling a running series of shots

- Press the **PLAY** button
 - A small menu appears.
- Select **End**

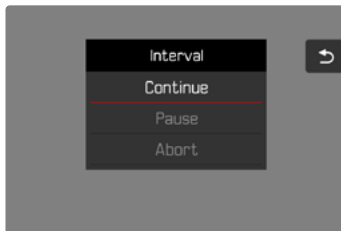

Notes

- The use of autofocus in interval shooting may result in not all exposures having their focus on the same object.
- The camera may switch off and on again if "Auto power off" is set and no other camera operation occurs between the individual shots.
- Interval shooting over an extended period of time in a cold location or in a place with high temperature and humidity may result in malfunctions.
- Interval shooting will be interrupted or canceled in the following situations:
 - if the battery is depleted
 - if the camera is switched off

Make sure to check the battery for sufficient charge.

- Interrupted or canceled interval shooting can be resumed by switching the camera off, replacing the battery or memory card as needed and then switching the camera back on. A prompt will be displayed on screen if the camera is switched off and on again while the **Interval Shooting** shooting function is active.
- The interval function remains active after the shoot, and also after the camera is switched off and on again, until another shooting mode (Drive Mode) is set.
- Availability of the interval function does not mean that the camera is suitable for use as a monitoring device.
- Regardless of how many frames were taken in a series, the last image in the series or the last image saved on the memory card while the saving process is ongoing will be displayed first in both review modes.
- The shots of an interval shooting are marked with  in review mode.

- The camera may under some circumstances be unable to take good pictures. That may happen if, for example, focusing was unsuccessful. In that case, the camera will not take a picture and the series will continue with the next interval. The message **Some Frames are dropped** appears on screen.

EXPOSURE BRACKETING

Many attractive objects are rich in contrast, which means they have very bright and very dark areas. The image effect can be dramatically different, depending on which of these areas you choose to align your exposure with. The automatic bracketing function in aperture-priority mode allows you to produce several alternatives with graduated exposure values and varying shutter speeds. You can then select the image you like best or use relevant photo editing software to calculate an image with a particularly broad contrast spectrum (HDR).

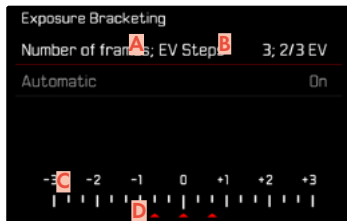

- A** Number of frames
- B** Exposure difference between shots
- C** Light value scale
- D** Exposure values of the images marked in red (The scale will be offset by the relevant value if exposure compensation is set concurrently.)

You can select the desired number of frames (3, 5 or 7). The exposure difference, which can be set via **EV Steps**, can be up to 3 EV.

- Select **Drive Mode** in the main menu
- Select **Exposure Bracketing**
- Select the desired number of frames under **Number of Frames** in the submenu
- Select the desired exposure offset under **EV Steps** in the submenu
- Select the desired **Exposure Compensation** value in the submenu
 - The marked exposure values change positions according to the settings selected. In the case of exposure compensation, the scale also shifts.
 - The selected exposure compensation value will be applied to the entire series of shots.
- Select the desired setting under **Automatic** in the submenu
 - With the factory setting in place (**On**), the entire exposure series will run after the shutter button is pressed once; when the setting is **Off**, each picture must be taken individually.
- Take one or several shots by pressing the shutter button

Notes

-  appears on the LCD panel if the bracketing function is activated. You can watch the effect of the function on screen during shooting (brighter or darker).
- Depending on the exposure mode, the exposure gradations are produced by changing the shutter speed and/or aperture value:
 - Shutter speed (**A/M**)
 - Aperture (**S**)
 - Shutter speed and aperture value (**P**)
- The sequence of shots: underexposure/correct exposure/overexposure.
- The working range for automatic bracketing may be limited depending on the available shutter speed/aperture combination.
- With automatic ISO sensitivity control enabled, the sensitivity calculated by the camera automatically for the raw files will also be applied to all other shots in the series, i.e. the ISO value will not change during bracketing. This may mean that the slowest shutter speed specified under **Shutter Speed Limit** is exceeded.
- The working range for automatic bracketing may be limited (depending on the originally set shutter speed). The specified numbers of frames will be taken regardless. Several shots in a series may consequently have the same exposure values.
- The function remains active until another function is selected from the **Drive Mode** submenu. If no other function is selected, another bracketing is taken each time the shutter button is pressed.

SELF-TIMER

The self-timer function allows shoot with a preset time delay. We recommend that the camera is placed on a tripod.

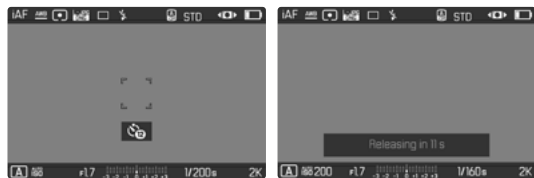

- Select **Self-timer** in the main menu
- Select **Self-timer 2 s**/**Self-timer 12 s**
- Shutter release
 - The remaining time until exposure is counted down on the LCD panel. The self-timer LED at the front of the camera counts down the delay time. It flashes slowly during the first 10 s, then fast for the last 2 s.
 - The self-timer delay time can be canceled at any time by tapping the shutter button; the relevant settings remain intact.

Notes

- Exposure metering is done first; in autofocus mode, focusing is first. Only then will the delay time commence.
- The self-timer function is available only for single frame shooting and for bracketing.
- The function remains active until another function is selected from the **Self-timer** submenu.

SPECIAL SHOOTING MODES

SCENE MODE

10 automatic program variants are available under the menu item **Scene Modes**. All 10 offer automatically controlled shutter speed and aperture for extra easy photography (as with the “normal” automatic program **AUTO**), as well as a number of other functions to suit the selected scene type. These may include the ISO setting or focusing.

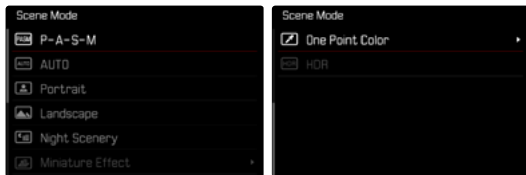

- Select **Scene Mode** in the main menu
- Select the desired setting

- **AUTO**: Automatic snapshot function for general use
- 6 scene modes, which are designed to accommodate the requirements of common object types:
 - **Portrait**, **Landscape**, **Night Scenery**, **Miniature Effect**, **One Point Color**, **HDR**

The following sections offer detailed information about these three functions.

Notes

- The selected program will remain active until a different program is selected (even after the camera is switched off).
- The menu item **Scene Mode** will reset to **P-A-S-M** if the shooting mode is changed (Photo/Video).
- The program shift function and some of the menu items are unavailable.
- The shutter-speed dial and the aperture ring are without function.
- Exposure preview (see p.106) is active in all programs.

FLASH PHOTOGRAPHY

The camera determines the necessary flash intensity by firing one or more pre-flashes before taking the actual photo. The main flash fires immediately after, i.e. during exposure. All factors influencing exposure (e.g. filters, aperture settings, distance to the main subject, reflective ceilings, etc.) are automatically considered.

COMPATIBLE FLASH UNITS

The full scope of functionalities described in this manual is available only in conjunction with Leica system flash units, e.g. SF-D or Panasonic/Olympus devices. TTL flash metering is available only in conjunction with the flash unit supplied. Other flash units, which only have a positive center contact, can be safely fired via the Leica D-Lux 8, but cannot be controlled via the camera. Correct function cannot be guaranteed when using any other flash unit.

Note

- When using flash units that are not specifically designed for the camera and can therefore not automatically switch over the white balance of the camera should be used in the **WB** flash setting.

Important

- The use of incompatible flash units with your Leica D-Lux 8 may result in irreparable damage to the camera and/or the flash unit.

Notes

- A flash unit that is not ready to flash may cause incorrect exposures or error messages.
- Studio flash systems may have a very long flash firing duration. It may therefore be advantageous to select a slower shutter speed than 1/200 s when using such a system. The same applies for RF-controlled flash firing for so-called "off-camera" flashes, as the transmission time may cause a delay.
- Continuous shooting and automatic bracketing with flash are not available.
- Use a tripod to prevent blurring at slow shutter speeds. Alternatively, you can select a higher sensitivity.

ATTACHING THE FLASH UNIT

- Switch off the camera and flash unit
- Pull off the accessory shoe cover and store it in a safe place
- Slide the foot of the flash unit all the way into the accessory shoe and use the clamping nut (where available) to secure it against accidental movement
 - Movement inside the accessory shoe can interrupt required contacts and therefore cause malfunctions.

DETACHING THE FLASH UNIT

- Switch off the camera and flash unit
- Release the lock as needed
- Detach the flash unit
- Replace the accessory shoe cover

Note

- Make sure that the accessory shoe cover is always in place when no accessory is attached (e.g. a flash unit).

FLASH EXPOSURE METERING (TTL METERING)

The camera-controlled, fully automatic flash mode is available in this camera in conjunction with system-compatible flash units (see p. 116), and in both exposure modes (Aperture-priority Mode and Manual).

In aperture-priority mode and with manual setting, the camera furthermore allows the use of other interesting flash techniques like flash synchronization and firing with slower shutter speeds than the max. sync time.

The camera additionally communicates the sensitivity setting to the flash unit. The flash unit can use this information to automatically adjust its range data, provided the device comes with these displays and the aperture setting selected on the lens is also entered manually on the flash unit. The ISO sensitivity setting cannot be altered via the flash unit on system-compatible units, because the information is received from the camera.

SETTINGS ON THE FLASH UNIT

Operating mode	
TTL	Automatic control by the camera
A	Supplied flash unit
M	The flash exposure must be set to an output level to match the aperture and shutter speed settings determined by the camera.

Notes

- Set the flash unit to **TTL** mode to allow automatic control of the unit by the camera.
- When set to **A**, objects with above or below average brightness may not be exposed correctly.
- Please read the relevant manual provided with third party flash units regarding their various operating modes.

FLASH MODES

Select one of the three available operating modes.

- Automatic
- On
- Long-term exposure

AUTOMATIC FLASH ACTIVATION*

That is the default flash mode. The flash unit will fire automatically if poor lighting conditions would mean slower shutter speeds, which could result in blurred images.

MANUAL FLASH ACTIVATION

This mode is suitable for backlit pictures in which the main subject does not fill the entire frame and is in shadow, or in situations where a fill-in flash will moderate sharp contrasts (e.g. in direct sunlight). The flash will fire each time a picture is taken, regardless of prevailing lighting conditions. The flash intensity depends on the metered ambient brightness: in poor light it is the same output as in automatic mode, with output decreasing with increasing brightness. The flash will then work as a fill-in light, e.g. to light up dark shadows in the foreground or backlit objects, and to create more balanced overall lighting.

* In combination with Aperture-priority mode (**A**).

AUTOMATIC FLASH ACTIVATION AT SLOWER SHUTTER SPEEDS (LONG-TERM SYNCHRONIZATION)

This mode ensures appropriately exposed, brighter dark backgrounds and bright foreground.

The shutter speed is not extended beyond 1/30s in the other flash modes to minimize the risk of blurring. This may mean, however, that pictures with flash exposure can end up with objects in the background not illuminated by the flash and therefore being underexposed. In this mode, slower shutter speeds (up to 30s) are permitted to avoid this effect.

- Select **Flash Settings** in the main menu
- Select **Flash Mode**
- Select the desired setting
 - The currently active mode is displayed on screen.

FLASH CONTROL

The settings and functions described in the following sections only apply to settings and functions available in this camera and in system-compatible flash units.

SYNC POINT

Flash exposures are lit by two light sources:

- existing light from the environment
- the additional flash

Any subject elements lit primarily by the flash will almost always be rendered in perfect focus by the short burst of light, provided the focus is set correctly. All other subject elements in the same frame lit by ambient light or lit from within will be rendered with varying degrees of sharpness. Whether or not these object elements will be rendered in sharp focus or blurred, as well as the degree of “blurriness” depends on two interdependent factors:

- the shutter speeds
- the speed of movement of the subject elements or camera during shooting

The longer the shutter speed and the faster the motion, the greater the difference between the two superimposed partial images.

A flash is usually fired at the start of exposure (**Start**). This may result in apparent contradictions, e.g. the image of a vehicle being overtaken by its own light trail. This camera alternatively allows synchronizing with the end of exposure (**End**). The sharp image will in this case be a rendering of the end of the captured motion. This flash technique creates a more natural impression of movement and dynamics in the image.

This function is available with all camera and flash unit settings.

Factory setting: **End**

- Select **Flash Settings** in the main menu
- Select **Flash Sync**
- Select the desired setting (**Start**, **End**)
 - The set sync point is shown in the header line.

Notes

- When using the flash with faster shutter speeds, a difference between the two flash firing points will be barely discernible or only noticeable for very fast movements.

FLASH EXPOSURE COMPENSATION

This function can be used to selectively reduce or enhance flash exposure regardless of ambient light, e.g. to brighten the face of a person in the foreground when taking a photo outdoors in the evening while retaining the same general lighting mood.

Factory setting: **0 EV**

- Select **Flash Settings** in the main menu
- Select **Flash Exp. Compensation**
 - The submenu displays a scale with a red setting mark. The function is deactivated if the value is set to **0**.
- Set the value on the scale
 - The set value is displayed above the scale.

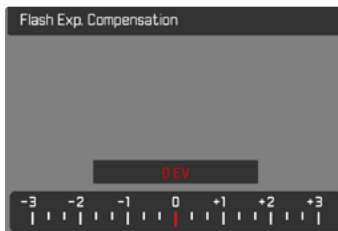

Notes

- The following applies for set compensation values, no matter how they were initially set: They remain effective until they are manually reset to 0, even if the camera is switched off and on again in the meantime.
- **Flash Exp. Compensation** is unavailable, if flash units with an own compensation function are used (e.g. Leica SF 58 or Leica SF 60). A compensation value set on the camera would in that case have no effect.
- A brighter flash illumination with Plus compensation will require a greater flash intensity. Flash exposure compensation will therefore impact on the flash range: A Plus correction will decrease it, a Minus correction will increase it.
- An exposure compensation set on the camera will only affect the measurement of ambient light. If a simultaneous TTL flash exposure metering compensation is desired in flash mode, then it must be additionally set on the flash unit.

FLASH PHOTOGRAPHY

- Switch on the flash unit
- Set the desired guide number control mode (e.g. TTL or GNC = Guide Number Control) on the flash unit
- Switch the camera on
- Select the desired exposure mode, shutter speed and/or aperture setting
 - It is imperative to take note of the shortest flash sync speed, as it determines whether a “normal” flash or an HSS flash is fired.
- Tap the shutter button before each flash exposure to activate exposure metering
 - The flash unit may not fire if this step is missed by pressing the shutter button down completely and skipping these settings.

Note

- It is recommended to use a different exposure metering method than **Spot** in flash photography.

REVIEW MODE

There are two completely independent review functions available:

- short-term rendering directly after shooting (Auto Review)
- normal review mode, in which the stored mages can be viewed and managed for any length of time

Notes

- Recorded images are not automatically rotated in review mode to utilize the full screen area.
- It may not be possible to render files with this camera that were not recorded with this device.
- In some cases, the screen image may not have the expected quality, or the LCD panel will remain blank and only display the file name.
- You can toggle back from review mode to shooting mode at any time by tapping the shutter button.

CONTROL ELEMENTS IN REVIEW MODE

CONTROL ELEMENTS ON THE CAMERA

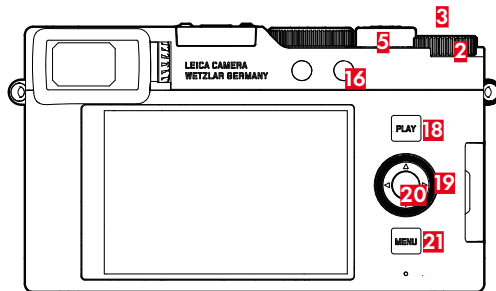

- | | | | |
|-----------|--------------------|-----------|--------------------|
| 2 | Thumbwheel | 20 | Center button |
| 3 | Thumbwheel button | 19 | Directional pad |
| 16 | Function button | 21 | MENU button |
| 18 | PLAY button | 5 | Zoom lever |

DIRECT ACCESS IN REVIEW MODE

The function buttons can have individual assignments in review mode as well.

In factory settings, the function buttons have the following assignments:

Button	Function
Thumbwheel button	Magnification
Function button 16	Delete Single
Thumbwheel button 3	Mark shots (Rate / Unrate)
Center button	Toggle Info Levels

The descriptions in the next few sections presume factory settings.

Notes

- The assigned function is independent of the current display mode; the delete functions overview can therefore be accessed directly in full screen display mode.
- The assigned function is unavailable if the function button addresses an on-screen control element (e.g. in the “Delete” screen).

CONTROL ELEMENTS ON THE LCD PANEL

On-screen control elements generally function by intuitively by touch. Many can also be selected by pressing one of the three buttons to the right of the LCD panel (**PLAY** button, center button, **MENU** button). A control element in the header is accompanied by an icon denoting the relevant button. A control element on the edge of the screen will be positioned directly next to the relevant button.

Example: The “Go back” icon  can be selected in one of two ways:

- tap on the “Go back” icon directly
- press the relevant button
(top button = **PLAY** button)

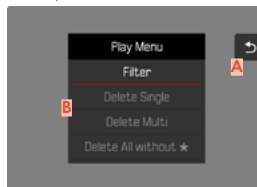

- A** Control element “Go back”
- B** Control element “Delete”

STARTING/EXITING REVIEW MODE

Shooting



Review

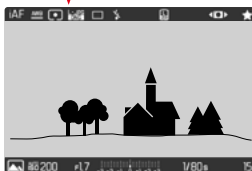

→ Press the **PLAY** button

- The last captured image appears on the screen.
- The following message appears if the inserted memory card does not contain any image data:
`No valid picture to play.`
- The **PLAY** button function differs, depending on the current camera setting

Initial situation	After pressing the PLAY button
Full screen display of an image	Shooting mode
Display of an enlarged cropped section/or several thumbnails	Full screen display of the image

SELECTING/SCROLLING THROUGH IMAGES

The images are visually arranged in a horizontal reel. The sorting will be strictly chronological. When the end of an image series is reached, the display automatically jumps back to the first image in the series. All images can therefore be reached by scrolling either right or left.

SINGLE

Using touch control

→ Swipe to the left or right

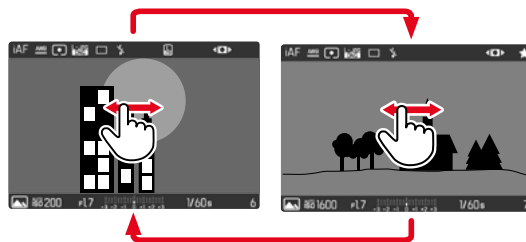

Using button control

→ Press the directional pad to the left or right, or turn the thumbwheel

CONTINUOUS

- Swipe to the left or right and hold the finger on the edge of the screen
 - The subsequent shots will move past continuously.

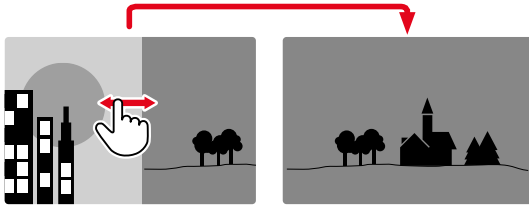

INFO DISPLAYS IN REVIEW MODE

In factory settings, images are displayed without header and footer information for unimpeded viewing.



- Press the center button
 - The info bars appear (header and footer line always appear/disappear together in review mode).

PICTURE SERIES REVIEW (INTERVAL SHOOTING)

Serial and interval shooting often produces a large number of individual images. It would be very difficult to find other pictures that are not part of a series if every image of all these series was displayed individually. Organizing the images in groups creates more clarity in review mode.



The representative image is shown with **PLAY ▶** in the center and **⏮** **📄** at the bottom left.

There are two options for viewing the images in a group: manual scrolling or automatic playback.

UNINTERRUPTED PLAYBACK OF THE PICTURE SERIES

The images in a group can be played back from start to finish without interruption. This may be very helpful to get a better idea of the processes or conditions rendered than if the images were scrolled manually.

→ Tap **PLAY ▶**

or

- Press the center button
 - Auto Review commences.

A prompt screen with additional functions can be accessed while playback is running.

- Press the center button
 - Playback stops, the current picture in the series is displayed.

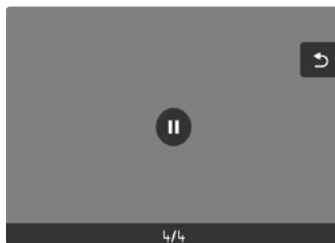

JUMPING TO A SPECIFIC PICTURE IN THE GROUP

→ Use the directional pad to select a specific image

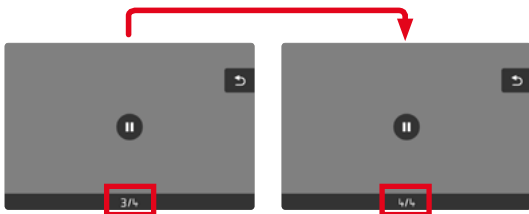

RESUMING PLAYBACK



While the control elements are visible:

→ Press the center button



SCROLLING THROUGH THE INDIVIDUAL PICTURES OF A SERIES

The images in a picture series can also be viewed individually. Switch to the manual scrolling function to do so.





- Press the directional pad up/down
 - The information displays disappear in full-screen mode.
 - When the information displays are activated,   will appear at the bottom left of the image.
- Press the directional pad left/right
- or
- Swipe to the left or right

Returning to standard review mode

- Press the directional pad up/down
 -   is displayed at the bottom left of the image.

Notes

- The review will be limited to the current picture series for as long as you are scrolling in that series, which also applies to the overview display of 12 or 30 thumbnails.
- The images of a series are marked with  in the header line, those of an **Interval Shooting** shoot by .

CROPPED SECTION ZOOM

You can zoom in to any section of an image for closer inspection. You have a five-step zoom factor available via the thumbwheel, while zooming is stepless if you use touch control.

Using touch control

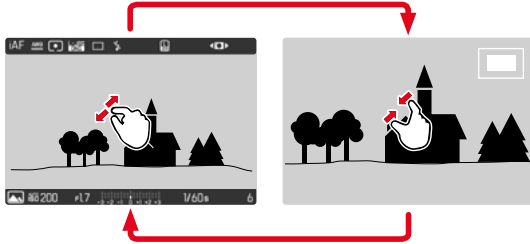

- Two-finger pinch/spread
 - The image will be zoomed in/zoomed out at the desired point.



- Move the position of an enlarged cropped section by swiping
 - The rectangle within the frame at the top right represents the current magnification, as well as its position in the displayed cropped section.

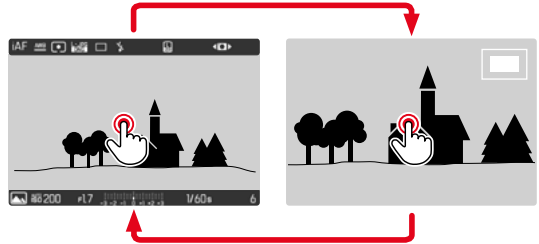

- Double tap
 - Toggles between the first zoom level at the tap position and standard full screen view.

Using button control

- Turn the zoom lever (to the right: increase magnification, to the left: decrease magnification)
- Press the directional pad to move the enlarged section anywhere in the image
 - The rectangle within the frame at the top right represents the current magnification, as well as its position in the displayed cropped section.

You can move directly from one image to the next in magnification mode, which will then also be displayed with the same magnification.

- Turn the thumbwheel

Notes

- It may not be possible to enlarge images taken with other camera types.
- Video recordings cannot be enlarged.

DISPLAYING MULTIPLE IMAGES AT ONCE

The camera offers an overview function in which several thumbnail images can be viewed on one screen, which makes it easier to find a specific image. You can choose 12 or 30 images per overview.

OVERVIEW

Using touch control

- Two-finger pinch
 - The display toggles from 12 to 30 thumbnails.

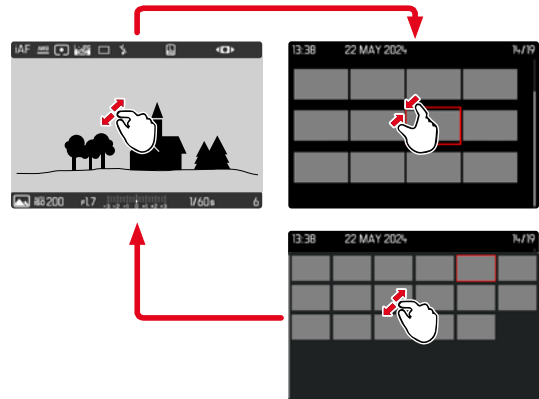

Using button control

- Turn the zoom lever to the left
 - The display toggles from 12 to 30 thumbnails.

Viewing other images

→ Swipe up or down

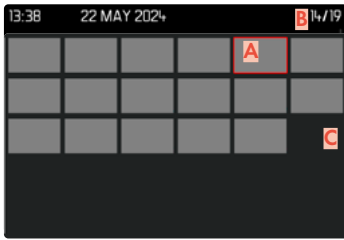
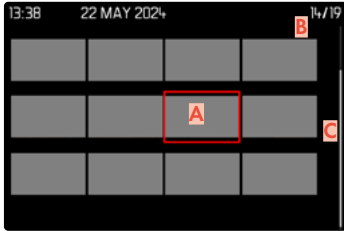

- A** Currently selected image
- B** Number of the currently selected images
- C** Scrollbar

The currently viewed image is framed in red and can be selected for a closer look.

Navigating between images

→ Press the directional pad in the relevant direction

Displaying the image in full size

Using touch control

→ Tap the desired image

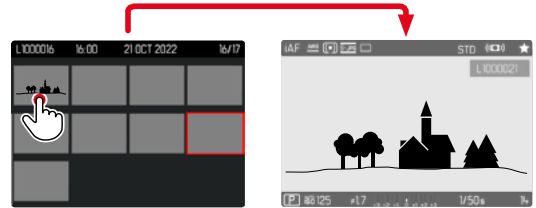

Using button control

→ Turn the zoom lever to the right

or

→ Press the center button

TAGGING/RATING OF IMAGES

Images can be marked as favorites to find them quicker or to simplify the later deletion of multiple images.

Tagging can be done in regular view mode or in the overviews.

Tagging a photos

- Press the thumbwheel button
 - The image is marked with .
 - The icon will appear in the header line on the far right when viewing images in full size, and in the top left corner of the thumbnail in overview mode.

Removing a tag

- Press the thumbwheel button
 - The marking disappears.

DELETING IMAGES

There are several methods available to delete images:

- deleting individual images
- deleting multiple images
- deleting all images without a icon/ranking

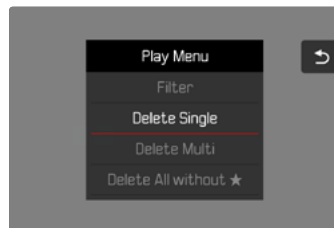

Important

- Once deleted, images are no longer retrievable.

DELETING INDIVIDUAL IMAGES

- Press the function button **(I6)**
 - The Delete screen appears.
- or

- Press the **MENU** button
- Select **Delete Single** in the play menu
 - The Delete screen appears.
 - The LED will flash during the delete process. The process may take a few seconds.
 - The next image will be displayed once deletion is complete. The following message appears if no other images are saved on the card: **No valid picture to play.**

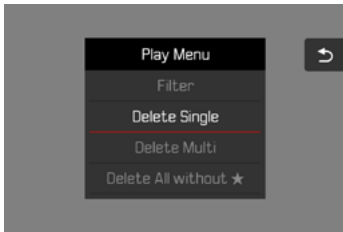

Cancelling a deletion and returning to normal review mode

- Select the “Go back” icon ↶
(tap the icon directly or press the **MENU** button)

Notes

- The Delete screen can be called up only by pressing the **MENU** button when in overview mode, because the menu function **Delete** of the “Play menu” is not available in this context.
- The “Scroll” and “Magnify” functions will always be available, even if the “Delete” screen is active.

DELETING MULTIPLE IMAGES

You can highlight multiple images in a Delete overview with nine thumbnails for simultaneous deletion.

This overview can be reached in two ways.

- Turn the zoom lever to the left
 - The overview screen appears.
- Press the **MENU** button
- Select **Delete Multi** in the play menu
 - The Delete overview appears.

or

- Press the **MENU** button
- Select **Delete** in the play menu
 - The Delete screen appears.

Any number of images can be selected in this view.

Selecting images for deletion

- Select an image
 - Press the center button
- or
- Tap the desired image
 - The images selected for deletion are marked with a red Delete icon .

Deleting the selected images

- Select the Delete icon 
(tap the icon directly or press the center button)
 - The prompt **Do you want to delete all marked files?** appears.
- Select **Yes**

Cancelling a deletion and returning to normal review mode

- Select the “Go back” icon 
(tap the icon directly or press the **PLAY** button)

DELETING UNRATED IMAGES

- Press the **MENU** button
- Select **Delete All without** in the play menu

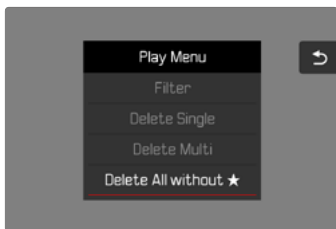

- The confirmation prompt **Do you really want to delete ALL files without ?** appears.
- Select **Yes**
 - The LED will flash during the deletion process. The process may take a few seconds. The next marked image appears once deletion is complete. The message **No valid picture to play** appears if no other images are saved on the card.

DELETING PICTURE SERIES

Optionally, individual shots from an image series can be deleted.

- Select the representative image
- Press the directional pad up/down
 - When the information displays are activated,  will appear at the bottom left of the image.
- Turn the zoom lever to the left



- Select the frames for deletion
- Press the **MENU** button
- Select **Delete Single** in the play menu
 - The prompt **Do you really want to delete this file?** appears.
- Select **Yes**

PREVIEW OF LATEST IMAGE

Photos can be displayed automatically directly after they are taken to e.g. check the success of the shots quickly and easily. A duration for the automatic display can be configured.

- Select **Auto Review** in the main menu
- Select the desired function or duration in the sub-menu
(Off, 1 s, 3 s, 5 s, **Permanent**)

Permanent: The most recent frame is displayed until automatic review is ended by pressing the **PLAY** button or by tapping the shutter button.

Notes

- Various control elements change back to regular review mode to execute their normal functions while automatic review is selected. The camera will remain in review mode until it is exited.
- Marking and deleting can only be done in regular review mode and not during automatic review.
- When shooting with the Continuous Shooting or Interval Shooting functions, then the last image in the series will be displayed or – if the save process is still incomplete – the last image in the series saved to the memory card.
- Where display times were configured (1 s, 3 s, 5 s) automatic review can be ended immediately by pressing the **PLAY** button or tapping the shutter button.

PREVIEW OF LATEST IMAGE

Recordings can be filtered by recording type for review (photo or video).

- Press the **MENU** button
- Select **Filter** in the play menu

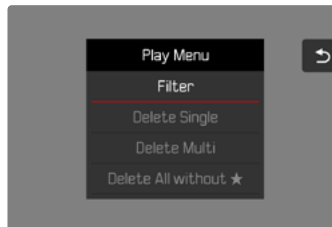

- A selection prompt for **All**, **Photo**, **Video** appears.

VIDEO SETTINGS

FILE FORMAT

Video can be recorded in the file formats MP4.

The user can configure a variety of resolution and frame rate combinations. This choice allows an alignment with the intended use and available memory card capacity.

VIDEO FORMAT

The following combinations of resolution and frame rate are available:

MP4

Frame rate	Resolution		
	4K	FHD	HD
60 fps		✓	
30 fps	✓	✓	✓
24 fps	✓		

AVAILABLE RESOLUTIONS

You can choose resolutions with the associated aspect ratios.

File Format	Available resolutions	
MP4	4K	3840 x 2160
MP4	FHD	1920 x 1080
MP4	HD	1280 x 720

AVAILABLE FRAME RATES

Up to 3 different frame rates between 24 fps and 60 fps are available depending on the selected resolution.

SETTING THE VIDEO FORMAT

Factory setting: file format MP4, resolution 4K, frame rate 30 fps

MP4

- Select **Format** in the main menu
- Select the desired resolution (**4K**, **FHD**, **HD**)
- Select the desired frame rate

Notes

- More details about available video formats can be found in the chapter “Technical Data” (see p. 208). There you will also find information regarding possible limitations for HDMI output.

IMAGE PROPERTIES

The Leica D-Lux 8 offers customizable **Video Style** profiles that allow the user to adapt video recordings to match personal requirements:



VIDEO STYLE

The image properties of video recordings can be changes slightly using several parameters. These are summarized in pre-configured **Video Style** profiles.

CONTRAST

The contrast setting, i.e. the difference between light and dark image sections, determines whether an image comes across as “flat” or “brilliant”. Increasing or decreasing this difference impacts on contrast, meaning that some image sections are rendered brighter or darker.

SHARPNESS

The impression of sharpness in a image is largely determined by edge sharpness, i.e. by how slight the transition area between light and dark is at edges in the image. Expanding or reducing these areas will therefore change the impression of sharpness.

COLOR SATURATION

The saturation factor in color shots determines, whether colors in the picture appear “pale” and pastel-like or “vivid” and bright. While lighting conditions and weather (e.g. foggy/clear) are a given in terms of shooting conditions, their rendering can be influenced.

HIGHLIGHT/SHADOW

Depending on the exposure selected and the dynamic scope of the object, some details in brighter or darker areas may no longer be clearly visible. The parameters **Highlight** and **Shadow** allow differentiated control over very brightly or less brightly lit areas. Where, for example, part of the object is in shadow, a higher setting for **Shadow** can help brighten these areas to make details more visible. Conversely, existing shadows or particularly bright areas might be additionally emphasized for reasons of image composition. Positive values will brighten the targeted areas, while negative values will darken them.

COLOR PROFILE

3 pre-configured color profiles are available:

- **STD** **Standard**
- **VIV** **Vivid**
- **NAT** **Natural**

- Select **Video Settings** in the main menu
- Select **Video Style**
- Select a profile

MONOCHROME PROFILE

There are two additional profiles available for monochrome video recordings:

- **BW** **Monochrome**
- **BW** **Monochrome High Contrast**

- Select **Video Style** in the main menu
- Select a profile

CUSTOMIZING VIDEO PROFILES

These parameters can be adjusted for all available profiles (Saturation only for color profiles). See p. 52 for details on menu operation.

- Select **Video Style** in the main menu
- Select **Settings**
- Select a profile
- Select **Contrast/Sharpness/Saturation**
- Select the desired level
(-2, -1, 0, +1, +2)

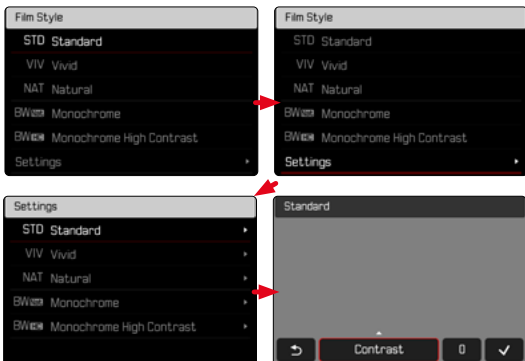

AUDIO SETTINGS

MICROPHONE

The sensitivity of the integrated microphone can be set. Factory setting: 0 dB

- Select **Video Settings** in the main menu
- Select **Microphone Gain**
- Select the desired level
(+6 dB, 0 dB, -6 dB, -12 dB)

Notes

- The Autofocus function and manual focusing adjustments generate noise that may be picked up in the recording.

WIND NOISE REDUCTION

Wind Noise Reduction can be activated or deactivated as needed.

Factory setting: **Standard**

- Select **Video Settings** in the main menu
- Select **Wind Noise Reduction**
- Select **High/Standard/Off**

AUTOMATIC OPTIMIZATION

VIDEO STABILIZATION

The stabilization function helps to reduce blurring for handheld recordings.

Factory setting: **On**

- Select **OS** in the main menu
- Select **On/Off**

DARK AREA OPTIMIZATION (IDR)

DYNAMIC RANGE

The contrast range of an object comprises all levels of brightness from the brightest to the darkest point in the image. All levels of brightness can be captured by the sensor, provided the contrast range of the object is lower than the dynamic range of the camera. In case of significant differences of brightness in the object (e.g. shootings of interior spaces with bright windows in the background, shootings with subject elements in shadow or directly lit by the sun, landscapes with dark areas and a very bright sky), the camera with its limited dynamic range will not be able to map the entire contrast range of the object. Information in 'edge areas' will be lost (under and overexposure).

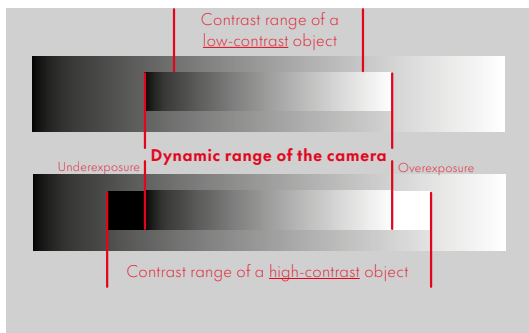

iDR FUNCTION

The **iDR** (Intelligent Dynamic Range) function allows an optimization of the darker areas. Object details become much clearer.

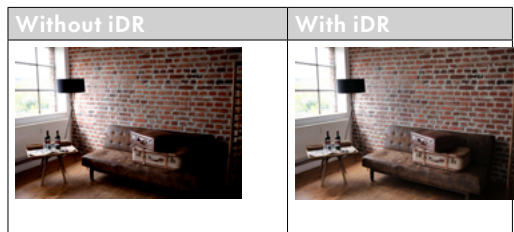

You can specify beforehand if and to what extent you want to optimize darker areas (**High**, **Standard**, **Low**, **Off**). In the **Auto** setting, the camera will automatically select the right setting depending on the contrast range of the object.

In addition to that setting, the effect also depends on the exposure settings. The function will have the strongest effect in combination with low ISO values and fast shutter speeds. The effect is less pronounced with higher ISO values and/or slower shutter speeds.

Factory setting: **Auto**

- Select **iDR** in the main menu
- Select the desired setting (**Auto**, **High**, **Standard**, **Low**, **Off**)

Note

- The optimization of darker areas will slightly reduce differentiation in very bright areas.

DATA MANAGEMENT

FORMATTING A MEMORY CARD

Memory cards that have already been in use with this camera will usually not require formatting. An unformatted memory card that is inserted into the camera for the first time must be formatted. We recommend formatting memory cards from time to time, because residual data traces (data pertaining to individual shots) may reduce the card's memory capacity.

- Select **Format Storage** in the main menu
- Confirm the selection
 - The lower status LED will flash during that process.

Notes

- Never switch off the camera while data transfer is in progress.
- All data stored on the memory card will be lost during formatting. Formatting will not be prevented by a deletion protection set for individual shots.
- All images should therefore be regularly transferred to a safe mass storage medium, e.g. the hard disk of a computer.
- A simple formatting process will initially not irretrievably destroy existing data on the card. Only the directory will be deleted, which means the data will no longer be directly accessible. Data access can be restored with appropriate software. Only data that is overwritten when new data is saved will actually be irretrievable.
- A memory card should be formatted again in the camera if it was formatted in another device, e.g. a computer.
- Contact your retailer or Leica Customer Care for assistance if the memory card cannot be formatted/overwritten (see p. 214).

DATA STRUCTURE

FOLDER STRUCTURE

The files (= shots) on the memory cards are saved in automatically generated folders. The first three characters signify the folder number (numerals), the last five the folder name (letters). The first folder is assigned the name "100LEICA", the second "101LEICA". A folder will always be created with the next available number; you can have max. 999 folders.

FILE STRUCTURE

The file names in these folders consist of eleven characters. In the factory settings, the first file is named "L1000001.XXX", the second "L1000002.XXX", etc. The first letter can be selected, the "L" from the factory settings denotes the camera brand. The first three characters signify the folder number (numerals). The next four digits denote the sequential file number. Once file number 9999 is reached, then a new folder will be automatically created, in which the file numbering begins at 0001 again. The last three places after the dot denote the file format (MOV or MP4).

Notes

- When using memory cards that were not formatted with this camera, the file numbering will begin with 0001 again. Should the memory card already contain a file with a higher number, then numbering will be continued from that number.
- A relevant message will be displayed on the LCD panel once folder number 999 and file number 9999 are reached, and all numbering must be reset.
- Format the memory card and reset the frame number right after to reset the folder number to 100.

EDIT FILE NAMES

- Select **Camera Settings** in the main menu
- Select **Edit File Name**
 - A keyboard submenu is displayed.
 - The input line contains the factory setting “L” as the first letter of the file name. Only this letter can be changed.
- Enter a letter of your choice (see p. 50)
- Confirm

Notes

- The change to a file name applies to all subsequent shots or until a new change is made. The sequential number will not be affected; but it will be reset when a new folder is created.
- During a reset to factory settings, the first letter will always be reset to “L”.
- Lower case letters are unavailable.

DATA TRANSFER

Data can be conveniently transferred to mobile devices via Leica FOTOS. Alternatively, a card reader or USB cable can be used for the transfer.

ABOUT LEICA FOTOS

- See chapter “Leica FOTOS” (p. 190)

Notes

- We recommend using a card reader for the transfer of large files.
- The USB connection must not be interrupted while data is being transferred, as the computer or the camera could otherwise “crash” and irreparable damage could occur on the memory card.
- The camera must not be turned off or automatically shut itself down due to a lack of battery power while data is being transferred, as this can cause the computer to crash. For the same reason, the battery must never be removed from the camera while the connection is active.

PRACTICAL DEFAULT SETTINGS

TOUCH AF

Touch AF allows a direct placement of the AF frame.

Factory setting: **Touch AF**

→ Select **Focusing** in the main menu

→ Select **Touch AF**

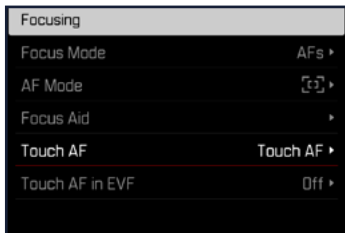

→ Select **Touch AF**



Positioning the AF frame

→ Tap the LCD panel in the desired position



Notes

- This function is available with all AF metering methods except **Multi-Field**.
- If the metering method **Tracking** is selected, the focus frame will remain at the selected position and auto-focus commences when the shutter button is tapped. For all other AF metering methods, focusing occurs automatically.

TOUCH AF IN EVF MODE

Touch AF is deactivated by default when EVF is in use to prevent any inadvertent altering of the AF frame. AF Quick Setting (see p.160) continues to be accessible. This function can also be disabled if that is not wanted (e.g. when focusing with the left eye).

Factory setting: Off

→ Select **Focusing** in the main menu

→ Select **Touch AF in EVF**

→ Select the desired setting
(On, **Touchpad**, Off)

– On

- Positioning the AF frame (tap)
- Accessing the AF Quick Setting (tap and hold)

– **Touchpad**

- Accessing the AF Quick Setting (tap and hold)

– Off

AUXILIARY DISPLAYS

You can select a number of other displays in addition to the standard information contained in the header and footer to adapt the screen image to your needs. The following functions are available:

- Grid (only shooting mode, see p.148)
- Focus Peaking (see p.149)
- Zebra (see p.149)
- Level Gauge (only shooting mode, see p.150)
- Histogram (see p.151)

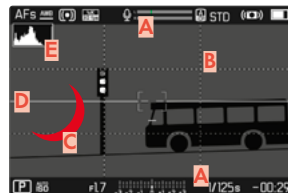

A Info Bars (= header and footer line)

B Grid

C Focus peaking

D Zebra

E Level gauge

F Histogram

→ Select **Capture Assistants** in the main menu

→ Select the desired function

→ Select On/ Off

Note

- All displays are visible at all times in video mode.

SHOW AVAILABLE

INFO BARS

The header and footer lines show the currently active settings and exposure values. See chapter “Displays” for a full list of the various displays (see p. 24).



GRID

The grids divide the image frame into multiple fields. They facilitate pictorial composition and an exact camera orientation.



- Select **Capture Assistants** in the main menu
- Select **Grid**
- Select **On/Off**

ZEBRA

The Zebra display marks very bright image areas. This function is a very easy and exact tool for checking the correct exposure setting. Overexposed areas will appear white with moving black stripes.

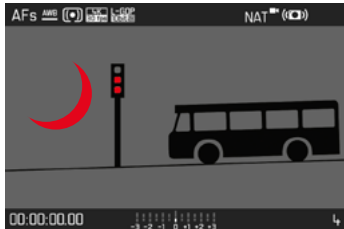

- Select **Capture Assistants** in the main menu
- Select **Clipping / Zebra**
- Select **On/Off**

FOCUS PEAKING

This assist function highlights the edges of in focus subject elements in color. The color can be user-specified. The sensitivity can be additionally adjusted.



HIGHLIGHT COLOR

Factory setting: **Red**

- Select **Focusing** in the main menu
- Select **Focus Aid**
- Select **Focus Peaking**
- Select the desired setting
(**Off**, **Red**, **Green**, **Blue**, **White**)

LEVEL GAUGE

The integrated sensors of the camera show its orientation. These indicators ensure exact camera orientation along the longitudinal and transverse axes of critical objects, e.g. architecture.

Deviations in relation to the longitudinal axis (i.e. when the camera is tilted up or down in the direction of view) are indicated by a short line in the center of the image (1).

Deviations in relation to the transverse axis (when the camera is tilted to the left or right) are indicated by two long lines to the left and right of the image center (2).

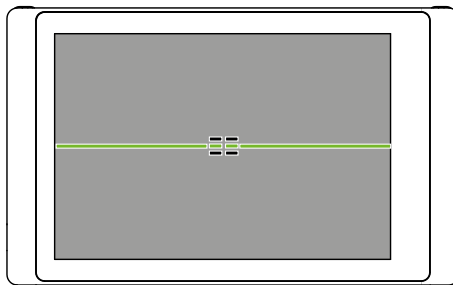

Correct alignment

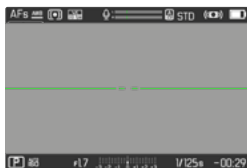

→ Select **Capture Assistants** in the main menu

→ Select **Level Gauge**

→ Select **On/Off**

Note

- The camera will switch the aspect of the level gauge autonomously for shoots in vertical format.

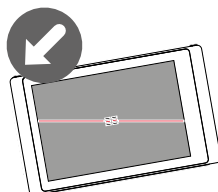

Tilted laterally to the left

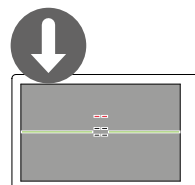

Tilted downward in the direction of view

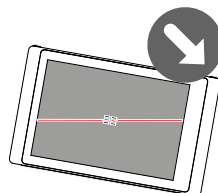

Tilted laterally to the right

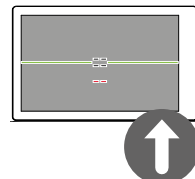

Tilted upward in the direction of view

HISTOGRAM

Histogram represents the brightness distribution in the image. The horizontal axis shows the graduated values from black (left) through gray to white (right). The vertical axis corresponds to the number of pixels at each brightness level.

This type of rendering allows an additional quick and easy assessment of the exposure setting.



- Select **Capture Assistants** in the main menu
- Select **Histogram**
- Select **On/Off**

Notes

- The histogram is always based on the brightness displayed; depending on the settings used, it may not represent the final exposure.
- In shooting mode, the histogram should be regarded as a “trend indicator”.

TEMPORARY ACTIVATION/DEACTIVATION OF INDIVIDUAL FUNCTIONS

The following assist functions can be activated/deactivated temporarily:

- Focus peaking
- Clipping
- Assigning the desired assist function to a function button (see p. 54)
- Press the corresponding function button
 - The status of the assist function toggles On/Off.
 - A relevant indicator appears in the screen image.

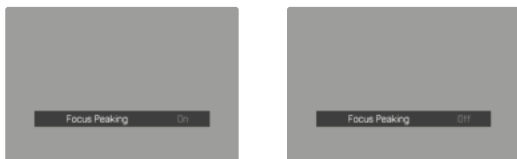

The temporary setting is reset when the camera is switched off.

MF ASSIST FUNCTIONS

ACOUSTIC AF CONFIRMATION

You can set an acoustic confirmation signal for successful focus metering in AF mode.

Factory setting: **Off**

- Select **Acoustic Signal** in the main menu
- Select **AF Confirmation**
- Select **On**
- Select **Volume**
- Select **Low/High**

Note

- The signal only appears during the focusing for a recording, not during recording.

RECORDING VIDEO

The settings described in this chapter only apply for video operations. They are therefore part of the video menu and must always be accessed and configured from within video mode (see chapter “Camera operation” in the section “Menu Control”). Any menu items of the same name in the photo menu are not affected.

Notes

- You can record up to 29 minutes of uninterrupted video.
- Some menu items are unavailable in Video mode. The text in the relevant line is displayed in gray to signify the existence of a submenu.
- As only part of the sensor area is used in video recordings, the relevantly effective focal length is increased, which slightly reduces the size of the image sections.
- The screen image of video recordings with the Leica D-Lux 8 appears with corresponding frame depending on the selected resolution and aspect ratio.
- The automatic LCD panel and EVF shutdown will also deactivate the AF system (see p. <?>). We therefore recommend the **Off** setting if autofocus is to be used in HDMI recordings.

START/EXIT VIDEO MODE

The camera will always be in Photo mode at initial activation or after a reset to factory settings. There are two methods for toggling between Photo and Video mode:

Using touch control

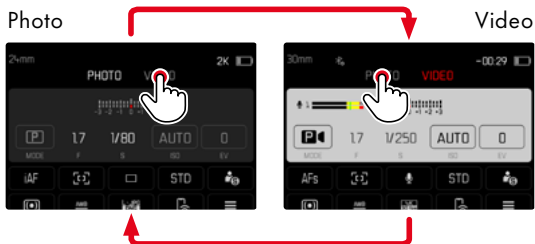

- The color of the status screen changes accordingly.

Using button control

- Press the function button with the function assignment **Photo - Video**
 - In factory settings, that will be function button 2 (16).

Note

- The camera switches to the most recently set photo or video mode.

START/END VIDEO RECORDING



- Press the shutter button
 - Video recording begins.
 - Framelines highlighted in red.
 - Recording time is running.
 - The Status LED flashes.
- Press the shutter button again
 - Video recording ends.
 - Framelines highlighted in gray.

Note

- Access to menu functions (including direct access) is limited during video recording.

FOCUSING

Your Leica D-Lux 8 allows automatic as well as manual focusing. There are 3 operating modes and 4 metering methods available for automatic focusing.

TAKING VIDEOS WITH AF

Focusing is done as needed when **AFs** is in use. The area in the AF frame will be focused continuously if **AFc** is in use.

- Turn the focus mode setting dial to the desired position
- Start video recording
- Controlling the autofocus (see p. 157)

TAKING VIDEOS WITH MF

Focusing is done manually via the focus ring.

- Turn the focus mode setting dial to the desired position
- Use the focus ring to manually focus on the object

AUTOFOCUS MODES

The following AF modes are available: **AFs**, **AFc** and **Intelligent AF**. The currently selected AF mode is shown in the header line.

Factory setting: **Intelligent AF**

- Select **Focusing** in the main menu
- Select **Focus Mode**
- Select the desired setting (**Intelligent AF**, **AFs**, **AFc**)

INTELLIGENT AF

Suitable for all objects. The camera automatically selects between AFs and AFc.

AFs (single)

A meaningful option if the focus setting should remain constant for an extended period of time. Allows greater control over focusing and helps to avoid incorrect focusing.

AFc (continuous)

Suitable for objects in motion. Focusing is continuously adjusted to the object in the AF frame.

Facilitates an intuitive focus control, specifically in conjunction with Touch AF.

CONTROLLING THE AUTOFOCUS

TOUCH AF

During video recordings, Touch AF facilitates a more intuitive focus control, even if the main object moves outside the center of the frame. See p. 146 for additional information.

- Tap the LCD panel in the desired position
 - Focusing is done after the touch.

CONTINUOUS FOCUSING

The area in the AF frame will be focused continuously if **AFc** and **iAF** are in use. That occurs automatically, without having to tap and hold the shutter button. This type of focusing is significantly smoother than focusing accessed via the shutter button, as jumps are avoided. Quick focusing can, however, be forced via the shutter button or Touch AF.

AF FOCUS METERING METHODS

The AF mode offers various metering methods for focusing. A successful focus setting is identified by a green frame, an unsuccessful one is shown in red.

Factory setting: **Multi-Field**

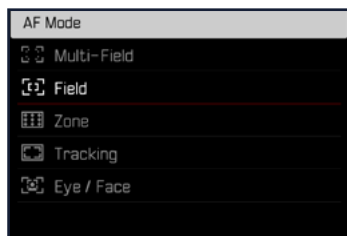

- Select **Focusing** in the main menu
- Select **AF Mode**
- Select the desired setting
(**Multi-Field**, **Field**, **Zone**, **Tracking**, **Eye / Face**)

Note

- AF focusing can be unsuccessful:
 - if the distance to the object is too great (macro mode) or too small
 - if the object is not sufficiently illuminated

MULTI-FIELD

Several focus areas are detected automatically.

FIELD

These methods will capture only the subject elements that are within the relevant AF frame. The focus area is denoted by a small frame (field metering). Simply move the AF frame to another position.

ZONE

With this metering method, subject sections are recorded with a coherent group comprising 5x5 fields.

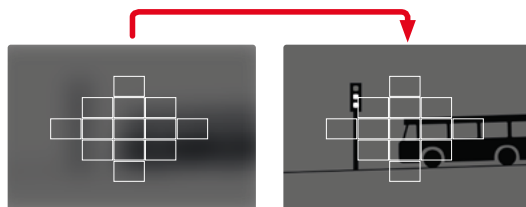

Once the setting has been made, the focus frames are displayed where object sections are displayed in focus.

TRACKING

This field metering variant helps in the capture of moving objects. The focus on the object in the focus frame is continuously adjusted, once it is detected.

- Aim the focus frame at the desired object (by panning the camera shifting the focus frame)
- Tap and hold the shutter button
 - The camera focuses on the object.
 - The focus frame “tracks” the saved object and focus is continuously adjusted.

Note

- This metering method focuses continuously, even if the AF mode **AFs** was set.

PERSON DETECTION (EYE/FACE DETECTION)

In this metering method, the camera automatically detects faces in the image field. The focus is set automatically on the faces closest to the camera. Field metering is used if no faces are detected.

When face detection detects an eye, the focus will be on that eye. Should more than one eye be detected, then the user can choose the eye to focus on. The currently selected eye will be highlighted.

Additionally, the desired face can be easily selected if there are several faces in the frame.

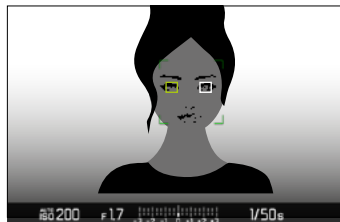

toggling between faces and/or eyes

- Press the directional pad in the relevant direction

AF QUICK SETTING

The AF Quick Setting allows quick changes to the focus frame size in some AF metering methods.

The screen image will remain visible continuously while settings are being adjusted.

ACCESSING AF QUICK SETTING

- Tap and hold the LCD panel
- All auxiliary displays are hidden.
- Red triangles appear at two corners of the focus frame if the metering method **Field/Zone/Eye/Face/Body Detection/Eye/Face/Body + Animal Detection** is set.



ADJUSTING THE AF FRAME SIZE

(**Field/Zone/Eye/Face/Body Detection/Eye/Face/Body + Animal Detection** only)

- Turn the thumbwheel
- or
- Two-finger pinch/spread
 - The size of the AF frame is adjustable in 3 increments.

AF ASSIST LAMP

The AF assist lamp is not active in video mode.

ACOUSTIC AF CONFIRMATION

You can set an acoustic confirmation signal for successful focus metering in AF mode (see p. 63).

Note

- This function is unavailable while recording.

SHIFTING THE AF FRAME

All AF metering methods permit shifting the AF frame before focusing. Continuous focusing during recording (with **AFc**) tracks the AF frame.

→ Press the directional pad in the relevant direction or

→ Tap the LCD panel in the desired position (While Touch AF is activated)

Notes

- The focus frame will remain at the most recently used position for this AF metering method even if the user changes the AF metering method or the camera is switched off.
- The metering fields are joined together when the exposure metering method **Spot** is combined with the AF metering methods **Spot**, **Field** and **Zone**. Exposure metering will then occur at the point specified by the AF frame, even if it is moved.

MANUAL FOCUSING (MF)

Focusing manually may in some situations be a better choice than autofocus.

- the same setting is used for several shoots
- it would take longer to use the metering memory lock function
- the setting is to be kept at infinity for landscape pictures
- poor, i.e. very dark lighting conditions prevent AF operation or would slow it down

→ Set the focus mode setting dial to the **MF** position

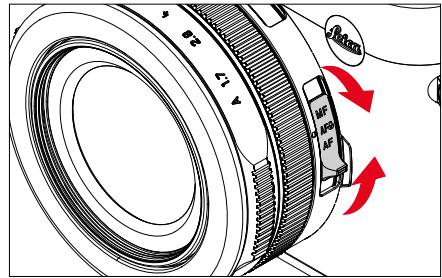

→ Turn the focus ring until the desired part of the object is in clear focus

MF ASSIST FUNCTIONS

The following assist functions are available in MF mode.

FOCUS PEAKING

This assist function highlights the edges of in focus subject elements in color. The color can be user-specified. The sensitivity can be additionally adjusted. See p. <?> for settings.



- Select **Focusing** in the main menu
- Select **Focus Aid**
- Select **Focus Peaking**
- Select the desired setting
(Off, Red, Green, Blue, White)
- Select an image section
- Turn the focus ring to mark the desired subject elements

Note

- Focus peaking is based on subject contrast, i.e. differences between light and dark. As a result, high contrast subject elements could be marked, even if they are not completely in focus.

ENLARGEMENT IN MF MODE

The larger the details of the object are shown, the better you can assess their sharpness and the more accurately you can focus.

This function can be automatically activated during manual focusing or can be accessed independently.

ACCESS VIA THE FOCUS RING

Turning the focus ring will automatically enlarge a image section.

- Select **Focusing** in the main menu
- Select **Focus Aid**
- Select **Auto Magnification**
- Select **On**
- Turn the focus ring
 - An enlarged image section appears. The position of the enlargement depends on the position of the AF frame.
 - The rectangle within the frame at the top right represents the current magnification, as well as its position in the displayed cropped section.

Adjusting the enlargement function

- Press the center button
 - The image section toggles between magnification factors.

Changing the position of the enlarged section

- Press the directional pad in the relevant direction

Exiting the enlargement function

- Tap the shutter button

Notes

- The magnification will automatically return to normal viewing size about 5 s after the last movement of the focus ring.
- The most recently magnification function will still be active the next time the feature is accessed.

MACRO FUNCTION

The working range for the focus setting can be switched quickly and easily from the standard focus range (30 cm to infinity) to the macro range (17 cm to 30 cm) using the macro ring. AF and MF mode are available in both ranges.

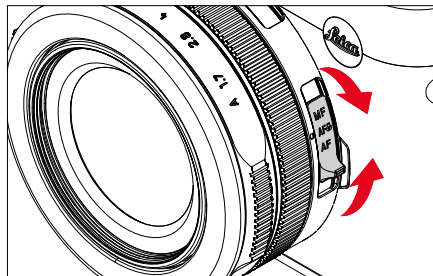

- Turn the focus mode setting dial to the **AF** position

ISO SENSITIVITY

The ISO setting covers a range between ISO 100 and ISO 25000, allowing you to adapt to the current situation.

There is more leeway for the use of preferred shutter-speed/aperture combinations when choosing an automatic ISO setting. You can set priorities within the scope of the automatic setting, e.g. for reasons of pictorial composition.

Factory setting: **Auto ISO**

FIXED ISO VALUES

Values between ISO 100 and ISO 25,000 are available for selection. Manual ISO setting occurs initially in full EV steps.

→ Select **ISO** in the main menu

→ Select the desired value

Note

- When high ISO values are used or the image is edited later, image noise, as well as vertical and horizontal stripes may become visible, particularly in larger, evenly lit areas of the object.

AUTOMATIC SETTING

The camera automatically adjusts the sensitivity to ambient brightness and/or to the configured shutter-speed/aperture combination. In conjunction with aperture-priority mode, this function extends the range for automatic exposure control. The automatic setting of ISO sensitivity occurs in increments of 1/3 EV.

→ Select **ISO** in the main menu

→ Select **Auto ISO**

LIMITING SETTING RANGES

A max. ISO value can be set, which will then limit the automatic setting (**Maximum ISO**).

A max. exposure time can also optionally be configured. There are automatic settings and fixed max. shutter speeds **1/30s** and **1/2000s** available for that purpose.

LIMITING ISO VALUES

All values from ISO 200 are available.

Factory setting: **6400**

→ Select **Auto ISO Settings** in the main menu

→ Select **Maximum ISO**

→ Select the desired value

WHITE BALANCE

In white balance ensures neutral color rendering in any light. White Balance relies on the setting made in the camera, which light color is to be rendered as 'white'.

Four methods are available:





- automatic control
- fixed presets
- manual setting via metering
- direct setting of the color temperature

Factory setting: **Auto**



AUTOMATIC CONTROL/FIXED SETTINGS

- **Auto**: for automatic control, which delivers neutral results in most situations
- Various fixed presets for most frequently encountered light sources:

	Daylight	For outdoor shootings in sunlight
	Cloudy	For outdoor shootings in cloudy conditions
	Shadow	For outdoor shootings with the main subject in shadow
	Tungsten	For indoor shootings with (predominantly) incandescent lamp light
	Flash	For shooting with flash

- Select **White Balance** in the main menu
- Select the desired setting

MANUAL SETTING VIA METERING

Gray card

This metering variant captures all color hues in the metering field and uses these to calculate a mean gray value.

- Select **White Balance** in the main menu
- Select  **Gray Card**
 - The following appears on the LCD panel:
 - the image based on automatic white balance
 - a frame in the center of the image

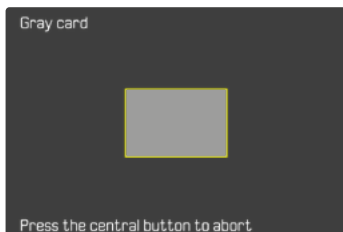

- Aim the metering field at a white or neutral gray area
 - The screen image changes dynamically in line with the reference area in the frame.

Performing measurement

- Shutter release
 - The measurement is taken.

Cancelling measurements

- Press the center button

Note

- A value configured using this method will remain unchanged (i.e. it will be used for all subsequent photographs) until new measurements are taken or one of the other white balance settings is selected.

DIRECT SETTING OF THE COLOR TEMPERATURE

Values between 2500 and 10000 K (Kelvin) can be set directly. That gives you a very wide range, which covers virtually all color temperatures occurring in real life and within which you can adapt color rendering to any light color and your personal preferences with incredible detail.





- Select **White Balance** in the main menu
- Select **Color Temperature**
- Select the desired value

EXPOSURE METERING METHODS

The following exposure metering methods are selectable.

Factory setting: **Multi-Field**

-  Spot
-  Center-weighted
-  Multi-field

- Select **Exposure Metering** in the main menu
- Select the desired metering method (**Spot**, **Center-Weighted**, **Multi-Field**)
 - The selected metering method is displayed in the header line of the screen image.

Spot metering allows a shifting of the focus point:

- Press the directional pad in the relevant direction

Note

- The exposure information (ISO value, aperture, shutter speed and light balance with exposure compensation scale) will help to determine the settings required for correct exposure.

SPOT

This metering method is concentrated exclusively on a small area in the center of the image. The metering fields are joined together when the exposure metering method **Spot** is combined with the AF metering methods **Spot** and **Field**. Exposure metering will then occur at the point specified by the AF frame, even if it is moved.

CENTER-WEIGHTED

This method considers the entire image field. The subject elements captured in the center will, however, impact on the calculation of the exposure value more so than areas around the edges.

MULTI-FIELD

This metering method is based on the detection of multiple values. These values are used in an algorithm to calculate an exposure value appropriate for a good rendering of the assumed main subject.

EXPOSURE MODES

You can choose one of four video shooting modes:

- Program AE mode (**P**)
- Aperture-priority mode (**A**)
- Shutter-priority mode (**S**)
- Manual setting (**M**)

These four “classic” modes are accessed via a relevant setting of the shutter-speed dial and the aperture ring. A correct setting for the menu item **Scene Mode** (see p. 169) is prerequisite for the use of **P**, **A**, **S** and **M**. The menu item **P-A-S-M** **must** be selected. Where the fully automated mode **AUTO** is selected instead, then that setting takes precedence over settings on the physical control elements. The shutter-speed dial and the aperture ring will in that case have no assigned function.

Note

- The following applies for all exposure modes: the available shutter speeds for custom settings or those available for automatic settings depend on the selected frame rate (**Video Format / Resolution**, see p. 136).

SELECTING A MODE

The four operating modes are activated automatically via the following setting combinations:

	Setting via the shutter-speed dial	Setting via the aperture ring
P	A	A
A	A	manual setting (not A)
S	manual setting (not A)	A
M	manual setting (not A)	manual setting (not A)

- Select **Scene Mode** in the main menu
- Select **P-A-S-M**
- Set the shutter-speed dial to the relevant position
- Set the aperture ring to the relevant position

FULLY AUTOMATIC EXPOSURE SETTING – P

PROGRAM AE MODE – P

The program AE mode facilitates fast and fully automatic photography. The exposure is controlled by an automatic shutter speed and aperture setting.

- Select **Scene Mode** in the main menu
 - Select **P-A-S-M**
 - Turn the shutter-speed dial to the **A** position
 - Turn the aperture ring to the **A** position
 - Tap and hold the shutter button
 - Exposure information is displayed at the bottom of the screen. This contains the automatically set value pair of aperture setting and shutter speed.
 - All other visible displays of the info bars will be hidden.
 - Shutter release
- or
- Adjusting the automatically set value pair (Program shift)

CHANGING THE PRESET SHUTTER SPEED AND APERTURE COMBINATIONS (SHIFT)

Changing the preset values using the Shift function combines the reliability and speed of fully automatic exposure control with the opportunity to vary the speed/aperture combination selected by the camera at any time to fit in with your own ideas and intentions. The overall exposure, i.e. the brightness of the image, remains unchanged. Faster shutter speeds are a good choice for e.g. sports pictures, while longer speeds will offer more depth of field for e.g. landscape pictures.

- Turn the thumbwheel to the left/right (right = greater depth of field with slower shutter speeds, left = faster shutter speeds with lesser depth of field)
- Shifted value pairs are marked with an asterisk next to the .

Note

- The adjustment range is limited to guarantee correct exposure.

SEMI-AUTOMATIC EXPOSURE SETTING – A/S

APERTURE-PRIORITY MODE- A

Aperture-priority mode sets the exposure automatically according to the manually selected aperture. It is therefore specifically suitable for video recordings in which the depth of field is a critical compositional element.

The range of the depth of field can be diminished with an accordingly small aperture value. This will set off the focused area against the unfocused background. Conversely, a greater aperture value will increase the range of the depth of field. Such a setting is advisable if the foreground and background should be rendered in sharp focus.

The selected aperture setting will be maintained for the duration of the recording.

- Select **Scene Mode** in the main menu
- Select **P-A-S-M**
- Turn the shutter-speed dial to the **A** position
- Set the desired aperture value
- Start video recording

SHUTTER-PRIORITY MODE – S

Shutter-priority mode will set exposure automatically according to the manually selected shutter speed. The selected shutter speed will be maintained for the duration of the recording.

- Select **Scene Mode** in the main menu
- Select **P-A-S-M**
- Turn the aperture ring to the **A** position
- Set the desired shutter speed
 - using the shutter-speed dial: in full increments
 - using the thumbwheel: fine tuning in 1/3 increments
- Start video recording

Note



- Fine tuning can alternatively be done via the status screen. Depending on the thumbwheel assignment, this may be the only option (see p. 55).

MANUAL EXPOSURE SETTING – M

The following manual settings for shutter speed and aperture are a good choice:

- to maintain constant exposure settings between multiple recordings
 - to maintain constant exposure settings while recording, specifically in conjunction with fixed ISO settings
- Select **Scene Mode** in the main menu
 - Select **P-A-S-M**
 - Set the desired exposure manually (using the shutter-speed dial and the aperture ring of the lens).
 - The exposure compensation is done using the scale of the light balance.
 - Start video recording

Displays on the light balance:

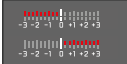
	Correct exposure
	Underexposure or overexposure by the displayed value
	Under or overexposure by more than 3 EV

Note

- The shutter-speed dial must be clicked to one of the engraved exposure shutter speeds.

SETTING SHUTTER SPEEDS

The shutter speed is set in two steps:

- using the shutter-speed dial: in full increments
- using the thumbwheel: fine tuning in 1/3 increments

EXAMPLES FOR SHUTTER SPEED FINE TUNING SETTINGS

- set shutter speed 1/125 s + move the thumbwheel one click to the left = 1/100 s
- set shutter speed 1/500 s + move the thumbwheel two clicks to the right = 1/640 s

Notes

- Fine tuning can alternatively be done via the status screen. Depending on the thumbwheel assignment, this may be the only option (see p. 55).
- The max. available shutter speed is limited by the set frame rate ([Video Resolution](#)).

EXPOSURE COMPENSATION

Exposure meters are calibrated for a medium gray scale value, which matches a standard, i.e. average image object. Should the measured image detail not fulfill that requirement, then the a relevant exposure compensation can be effected.

Specifically where several shots are taken in sequence, for example if for a series a slightly lesser or greater exposure is desired for a particular reason, then exposure compensation can be a very useful function: Unlike with exposure lock, the setting remains active until it is reset. Exposure compensation values can be set in the range ± 3 EV in 1/3 EV increments (EV: Exposure Value).

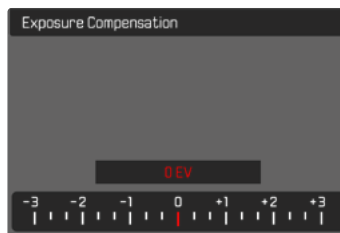

- A** Set compensation value (marks at 0 = Off)

Using thumbwheel control

- Select **Thumb Wheel** in the main menu
- Select **Exposure Compensation**
- Set the desired value using the thumbwheel

Using menu control

- Select **Exposure Compensation** in the main menu
 - A scale appears as a submenu item on the LCD panel.
- Set the value on the scale
 - The set value is displayed above the scale.

Notes

- While setting the value, you can see the effect on the screen image, which becomes darker or lighter.
- The following applies for set compensation values, no matter how they were initially set: They remain effective until they are manually reset to 0, even if the camera is switched off and on again in the meantime.
- The set exposure compensation is indicated by a mark on the exposure compensation scale in the footer line.

SPECIAL SHOOTING MODES

FULLY AUTOMATIC VIDEO RECORDING

In fully automated video mode, exposure is controlled by the camera just like for recordings in automatic program mode (P). Additionally, all other exposure-relevant factors like ISO values and exposure metering are controlled automatically.

- Select **Scene Mode** in the main menu
- Select **AUTO**

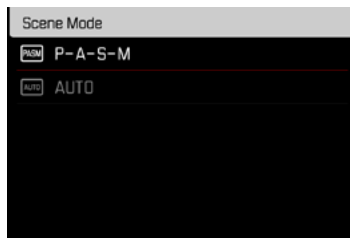

Notes

- The selected program will remain active until a different program is selected (even after the camera is switched off).
- The menu item Scene Mode will reset to **P-A-S-M** if the shooting mode is changed (Photo/Video).
- The program shift function and some of the menu items are unavailable.
- The shutter-speed dial and the aperture ring are without function.

PLAYBACK MODE

Playback mode is used to display and manage the stored recordings. The switchover between shooting and playback mode, as well as most other actions can be completed using gesture or key control. Please see p. 41 for more information about the available gestures.

Notes

- Recorded videos are not automatically rotated in playback mode to utilize the full screen area.
- It may not be possible to render files with this camera that were not recorded with this device.
- In some cases, the screen image may not have the expected quality, or the LCD panel will remain blank and only display the file name.
- You can toggle back from playback mode to shooting mode at any time by tapping the shutter button.
- Video recordings cannot be enlarged.

CONTROL ELEMENTS IN PLAYBACK MODE

CONTROL ELEMENTS ON THE CAMERA

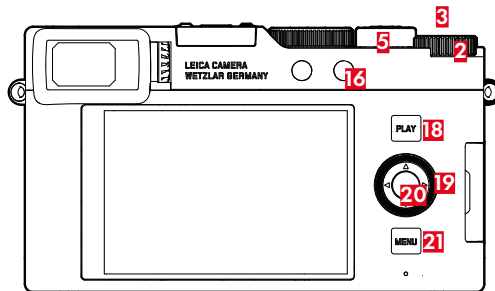

- | | | | |
|-----------|--------------------|-----------|--------------------|
| 2 | Thumbwheel | 20 | Center button |
| 3 | Thumbwheel button | 19 | Directional pad |
| 16 | Function button | 21 | MENU button |
| 18 | PLAY button | 5 | Zoom lever |

DIRECT ACCESS IN PLAYBACK MODE

The function buttons can have individual assignments in playback mode as well.

In factory settings, the function buttons have the following assignments:

Button	Function
Thumbwheel button	Magnification
Function button 16	Delete Single
Thumbwheel button 3	Mark shots (Rate / Unrate)
Center button	Toggle Info Levels

The descriptions in the next few sections presume factory settings.

Note

- The assigned function is independent of the current display mode; the delete functions overview can therefore be accessed directly in full screen display mode.
- The assigned function is unavailable if the function button addresses an on-screen control element (e.g. in the “Delete” screen).

CONTROL ELEMENTS ON THE LCD PANEL

On-screen control elements generally function by intuitively by touch. Many can also be selected by pressing one of the three buttons to the right of the LCD panel. A control element in the header is accompanied by an icon denoting the relevant button. A control element on the edge of the screen will be positioned directly next to the relevant button.

Example: The “Go back” icon ↶ can be selected in one of two ways:

- tap on the “Go back” icon directly
- press the relevant button (top button = **PLAY** button)

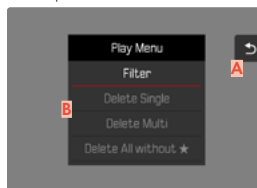

- A** Control element “Go back”
- B** Control element “Delete”

STARTING/EXITING PLAYBACK MODE

Using touch control

→ Swipe up or down

Shooting



Playback

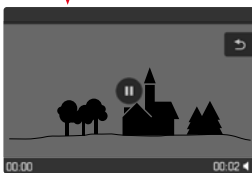

Using button control

→ Press the **PLAY** button

- The last shot taken appears on the screen.
- The following message appears if the inserted memory card does not contain any (image) files:
No valid picture to play.
- The **PLAY** button function differs, depending on the current camera setting

Initial situation	After pressing the PLAY button
Full screen display of a recording	Recording mode
Display of multiple small recordings	Full screen display of the recording

SELECTING/SCROLLING THROUGH IMAGES

The images are visually arranged in a horizontal reel. The sorting will be strictly chronological. When the end of an image series is reached, the display automatically jumps back to the first image in the series. All images can therefore be reached by scrolling either right or left.

SINGLE

Using touch control

→ Swipe to the left or right

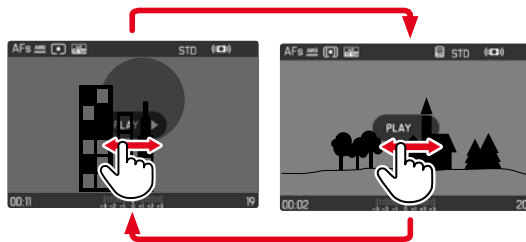

Using button control

→ Press the directional pad to the left or right, or turn the thumbwheel

CONTINUOUS

- Swipe to the left or right and hold the finger on the edge of the screen
 - The subsequent shots will move past continuously.

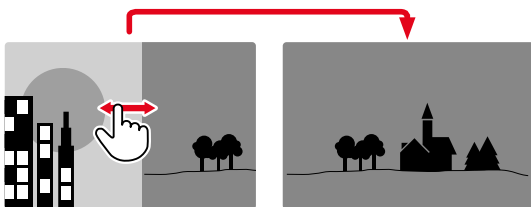

INFO DISPLAYS IN PLAYBACK MODE

Video recordings are always rendered with header and footer and with **PLAY ▶** on screen. No other auxiliary displays will appear.



All information is hidden during the playback of a video recording.

DISPLAYING MULTIPLE IMAGES AT ONCE

The camera offers an overview function in which several thumbnail images can be viewed on one screen, which makes it easier to find a specific image. You can choose 12 or 30 images per overview.

OVERVIEW

Using touch control

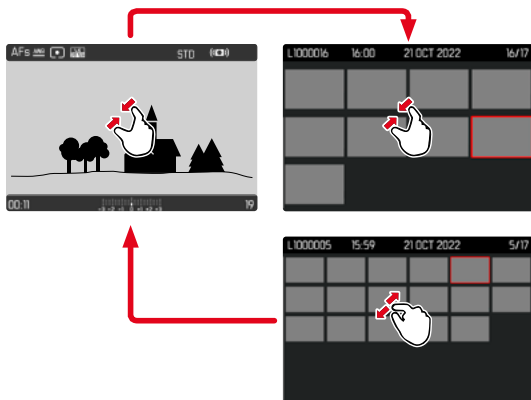

→ Two-finger pinch

- The display toggles from 12 to 30 thumbnails.

Viewing other images

→ Swipe up or down

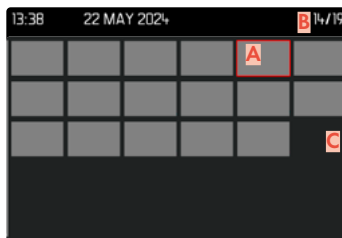
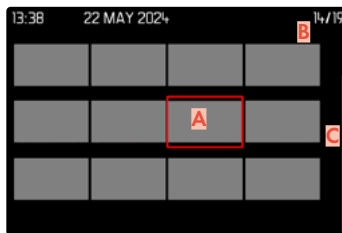

- A** Currently selected image
- B** Number of the currently selected images
- C** Scrollbar

The currently viewed image is framed in red and can be selected for a closer look.

Navigating between images

→ Press the directional pad in the relevant direction

Displaying the recording in full size

Using touch control

→ Tap the desired image

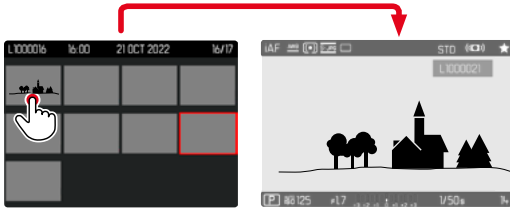

Using button control

→ Turn the zoom lever to the right

or

→ Press the center button

TAGGING/RATING OF RECORDINGS

Images can be marked as favorites to find them quicker or to simplify the later deletion of multiple images.

Tagging can be done in regular view mode or in the overviews.

Tagging a recording

→ Press the thumbwheel button

- The image is marked with .
- The icon will appear in the header line on the far right when viewing images in full size, and in the top left corner of the thumbnail in overview mode.

Removing a tag

→ Press the thumbwheel button

- The marking disappears.

DELETING RECORDINGS

There are several methods available to delete recordings:

- deleting individual recordings
- deleting multiple recordings
- deleting all recordings without a icon/ranking

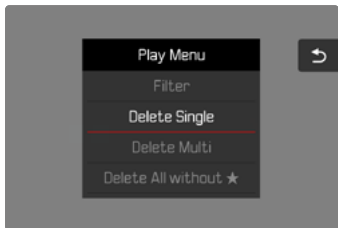

Important

- Once deleted, images are no longer retrievable.

DELETING INDIVIDUAL RECORDINGS

- Press the function button (16)
- The Delete screen appears.

or

- Press the **MENU** button
- Select **Delete Single** in the play menu
- The Delete screen appears.
- The LED will flash during the delete process. The process may take a few seconds.
- The next image will be displayed once deletion is complete. The following message appears if no other recordings are saved on the card: **No valid picture to play.**



Cancelling a deletion and returning to normal playback mode

- Select the “Go back” icon ↩
(tap the icon directly or press the **PLAY** button)

Notes

- The Delete screen can be called up only by pressing the **MENU** button when in overview mode, because the menu function **Delete** of the “Play menu” is not available in this context.
- The “Scroll” and “Magnify” functions will always be available, even if the “Delete” screen is active.

DELETING MULTIPLE RECORDINGS

Several recordings can be marked in a Delete overview with twelve thumbnails and can then be deleted all at once.

This overview can be reached in two ways.

- Turn the zoom lever to the left
 - The overview screen appears.
- Press the **MENU** button
- Select **Delete Multi** in the play menu
 - The Delete overview appears.

or

- Press the **MENU** button
- Select **Delete** in the play menu
 - The Delete screen appears.

Any number of recordings can be selected in this view.

Selecting recordings for deletion

- Select an image
- Press the center button

or

- Tap the desired image
 - The recordings selected for deletion are marked with a red Delete icon .

Deleting the selected recordings

- Select the Delete icon 
(tap the icon directly or press the center button)
 - The prompt **Do you want to delete all marked files?** appears.
- Select **Yes**

Cancelling a deletion and returning to normal playback mode

- Select the “Go back” icon 
(tap the icon directly or press the **PLAY** button)

DELETING UNRATED RECORDINGS

- Press the **MENU** button
- Select **Delete All without** in the play menu

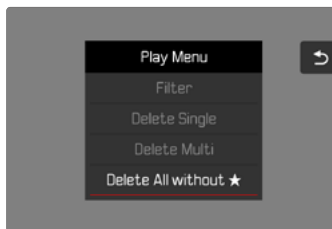

- The confirmation prompt **Do you really want to delete ALL files without ?** appears.
- Select **Yes**
 - The LED will flash during the deletion process. The process may take a few seconds. The next marked image appears once deletion is complete. The message **No valid picture to play** appears if no other images are saved on the card.

VIDEO PLAYBACK

PLAY ▶ appears on screen if you have selected a video file in playback mode.

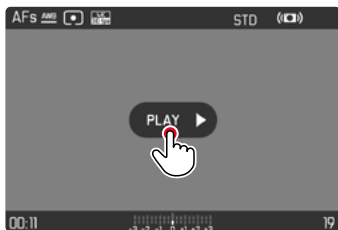

START PLAYBACK

→ Press the center button

or

→ Tap **PLAY ▶**

ACCESSING THE CONTROL ELEMENTS

The control elements are displayed when playback is stopped.

Using touch control

→ Tap anywhere on the LCD panel

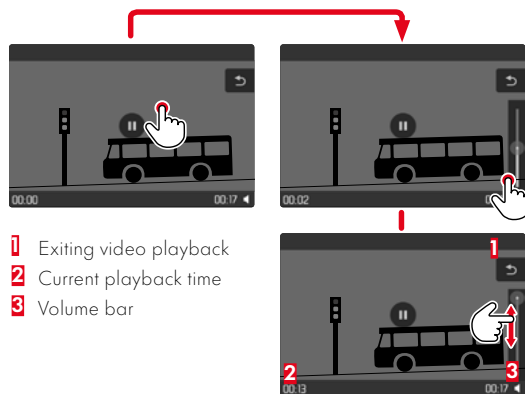

- 1 Exiting video playback
- 2 Current playback time
- 3 Volume bar

Using button control

→ Press the center button

Note

- The control elements disappear after about 3 s. Tapping the LCD panel again or pressing a button will make them reappear.

PAUSE PLAYBACK

- Tap anywhere on the LCD panel
- or
- Press the center button

RESUMING PLAYBACK

Using touch control

While the control elements are visible:

- Tap anywhere on the LCD panel

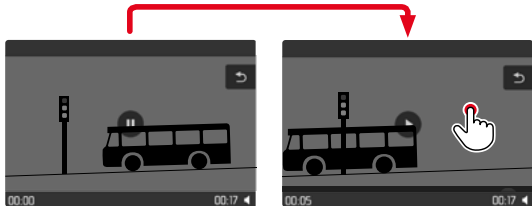

Using button control

While the control elements are visible:

- Press the center button

END PLAYBACK

Using touch control

While the control elements are visible:

- Tap the "Go back" icon ↶

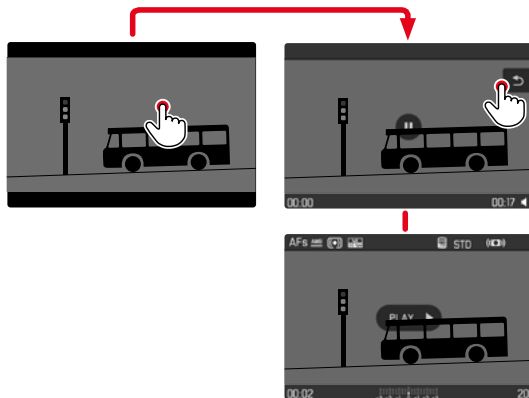

Using button control

- Press the **PLAY** button

SETTING THE VOLUME

Using touch control

While the control elements are visible:

- Tap the volume icon
- Tap the volume bar at the desired position

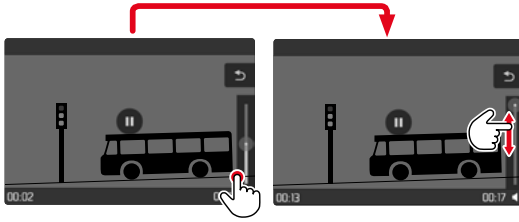

Using button control

- Press the directional pad up/down
 - The volume bar appears.
- Press the directional pad up (louder) or down (quieter)

Note

- Sound is switched off at the lowest part of the bar and the volume icon changes to .

OTHER FUNCTIONS

The settings described in this chapter apply for photo and video mode alike. They are therefore available in the picture and video menu (see chapter “Camera Operation” under “Menu Control”). A setting selected in one of the modes will also apply to the other.

RESETTING THE CAMERA TO FACTORY SETTINGS

This function allows you to reset all your custom menu settings back to the factory settings. You can optionally exclude the user profiles, Wi-Fi and Bluetooth settings, as well as the image numbering from the reset individually.

- Select **Reset Camera** in the main menu
 - The prompt **Do you want to reset the camera settings?** appears.
- Confirm **(Yes)** or reject **(No)** restoring the default settings
 - Selecting **No** will cancel the reset and the display will return to the main menu. Selecting **Yes** will trigger additional prompts regarding the settings you can opt to keep.
- Confirm or reject the reset of the Wi-Fi and Bluetooth settings **(Yes) / (No)**
- Confirm or reject the reset of the user profiles **(Yes) / (No)**
- Confirm or reject the reset of the image numbering **(Yes)/(No)**
 - The message **Please Restart the Camera** appears.
- Switch the camera off and on again

Notes

- Date & time, as well as the preferred language will have to be set up again after a reset. Relevant prompts will appear on screen.
- You reset the image numbering separately via the menu item **Reset Image Numbering** (see p. 186).

FIRMWARE UPDATES

Leica is continuously working on the further improvement and optimization of your camera. Since many camera functions are entirely controlled by software, some of these improvements and additions to the functional scope can be installed in retrospect. Leica offers firmware updates at irregular intervals, which you can download from our website.

Leica will notify you of any new updates, once you have registered your camera. Users of Leica FOTOS will also be automatically notified about firmware updates for their Leica cameras.

There are two options for installing firmware updates.

- conveniently via the Leica FOTOS app (see p. 190)
- directly via the camera menu

Finding the currently installed firmware version

- Select **Camera Information** in the main menu
 - The current firmware version is displayed in the **Firmware** menu item.

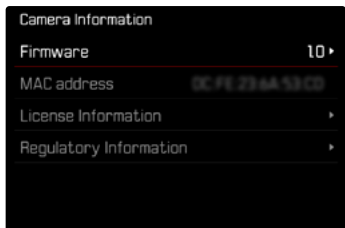

More information about registering, firmware updates and how to download them to your camera, as well as any amendments and additions to this manual can be found in the customer area of our website at:

<https://club.leica-camera.com>

EXECUTING A FIRMWARE UPDATE

Any interruption of a running firmware update may cause serious and irreparable damage to your equipment!

You will therefore have to take particular note of the following, when carrying out a firmware update:

- Do not switch off the camera!
- Do not remove the memory card!
- Do not remove the rechargeable battery!

Notes

- A warning message will appear if the battery is insufficiently charged. Recharge the battery and then repeat the process described above.
- You will find additional device and country-specific registration marks and numbers in the **Camera Information** submenu.

PREPARATION

- Fully charge and insert the rechargeable battery
- Any stored firmware files on the memory card must be removed
 - We recommend saving any images on the memory card and reformatting it before the update. (Caution: Loss of data! All data stored on the memory card will be lost during formatting.)
- Download the latest firmware version
- Save the download to the memory card
 - The firmware file must be stored in the main directory of the memory card (not in a sub-directory).
- Insert the memory card into the camera
- Switch the camera on

UPDATING THE CAMERA FIRMWARE

- Preparation
- Select **Camera Information** in the main menu
- Select **Firmware**
- Select **Firmware Update**
 - A prompt with information about the camera is displayed.
 - The prompt **Save profiles on SD Card?** appears.
- Select **Yes/No**
 - The update will start automatically.
 - The status LED will flash during this process.
 - Once the process has completed successfully, a relevant on-screen message and prompt to restart the device will appear on screen.
- Switch the camera off and on again

Notes

- Date & time, as well as the preferred language will have to be set up again after the restart. Relevant prompts will appear on screen.
- These settings will be applied automatically if the update is loaded via Leica FOTOS.

LEICA FOTOS

The camera can be controlled remotely using a smartphone/tablet PC. This will require an installation of the Leica FOTOS app on the mobile device. Leica FOTOS furthermore offers a variety of other useful functions:

- Geotagging for images (see p. 75)
- File transfer
- Downloading firmware updates
- Self-timer delay time selection via remote control, e.g. for group photographs

A list of available functions and instructions for their use can be found in the Leica FOTOS app. Please read the legal notes on page 7.

→ Scan the following QR code with the mobile device



or

→ The app is available from Apple App Store™/Google Play Store™

CONNECTIVITY (iPhone users)

FIRST-TIME CONNECTION TO A MOBILE DEVICE

A pairing of the camera and the mobile device is required for a first-time connection to a mobile device.

USING THE MENU TO

Where the connection wizard was not used or other mobile devices should be connected, the same settings are always accessible via the menu item **Leica FOTOS**.

IN THE CAMERA

- Select **Leica FOTOS** in the main menu
- Select **Pairing**

ON THE MOBILE DEVICE

- Launch the Leica FOTOS app
- Select "Add Camera"
- Select the camera model
- Select "Scan the QR code"
- Scan the QR code
 - Connection is being established. The process may take a few seconds.
 - Once successfully connected, the Status LED will light briefly, and the camera displays a relevant message.

Notes

- The pairing process may take a few minutes to complete.
- Each mobile device only needs to be paired with the camera once. The process adds the device to the list of known devices.

CONNECTING WITH PAIRED DEVICES

IN THE CAMERA

- Select **Leica FOTOS** in the main menu
- Select **Pairing**

ON THE MOBILE DEVICE

- Launch the Leica FOTOS app
- Select the camera model
- Confirm the prompt
 - The camera connects to the mobile device automatically.

CONNECTIVITY (Android users)

FIRST-TIME CONNECTION TO A MOBILE DEVICE

The connection is established via WLAN. A pairing of the camera and the mobile device is required for a first-time connection to a mobile device.

USING THE MENU TO

Where the connection wizard was not used or other mobile devices should be connected, the same settings are always accessible via the menu item **Leica FOTOS**.

IN THE CAMERA

- Select **Leica FOTOS** in the main menu
- Select **Pairing**
- Wait until the QR code appears on the LCD panel

ON THE MOBILE DEVICE

- Launch the Leica FOTOS app
- Select “Add Camera”
- Select the camera model
 - Connection is being established. The process may take a few seconds.
 - Once successfully connected, the Status LED will light briefly, and the camera displays a relevant message.

Notes

- The pairing process may take a few minutes to complete.
- Each mobile device only needs to be paired with the camera **once**. The process adds the device to the list of known devices.

CONNECTING WITH PAIRED DEVICES

IN THE CAMERA

- Select **Leica FOTOS** in the main menu
- Select **Pairing**

ON THE MOBILE DEVICE

- Launch the Leica FOTOS app
- Select the camera model
- Confirm the prompt
 - The camera connects to the mobile device automatically.

EXECUTING A FIRMWARE UPDATE

Any interruption of a running firmware update may cause serious and irreparable damage to your equipment!

You will therefore have to take particular note of the following, when carrying out a firmware update:

- Do not switch off the camera!
- Do not remove the memory card!
- Do not remove the rechargeable battery!
- Do not detach the lens!

Leica FOTOS will notify you when firmware updates are available for your Leica cameras.

- Follow the instructions provided by the Leica FOTOS app

Notes

- A warning message will appear if the battery is insufficiently charged. Recharge the battery and then repeat the process described above.
- Alternatively, firmware updates can also be installed via the camera menu (see p. 187).

CARE/STORAGE

We recommend the following if the camera will not be used for an extended period of time:

- Switch off the camera
- Remove the memory card
- Remove the battery (after approx. 2 months the set date and time will be lost)

CAMERA HOUSING

- Keep your equipment meticulously clean, as any kind of dirt residue presents a breeding ground for micro organisms.
- Only clean the camera with a soft, dry cloth. Stubborn dirt should first be moistened with a watered-down detergent and can then be wiped away with a dry cloth.
- Wet a soft cloth with tap water, wring it out thoroughly and use it to wipe down the camera. Then wipe it down thoroughly with a dry cloth.
- Wipe the camera with a clean, lint-free cloth to remove stains and fingerprints. Tougher dirt in hard to reach corners of the camera housing can be removed with a small brush. Take care not to touch the shutter blades.
- Store the camera in a closed and padded container to prevent friction damage and protect it against dust accumulation.
- Keep the camera in a dry, sufficiently ventilated place, where it will not be subjected to high temperatures and humidity. Make sure to remove all moisture from the camera if it was used in humid conditions.
- Do not store the camera in a leather case for extended periods of time to prevent fungal contamination.
- Empty your camera bag completely if it ever gets wet during use. Your equipment might otherwise be

subjected to moisture and tanning residue released by the moist leather.

- All mechanical bearings and sliding surfaces on your camera are lubricated. Remember to press the shutter button several times every three months to prevent the lubrication points hardening if the camera will not be used for an extended period of time. We also recommend repeated adjustment and use of all the other operating elements.
- When using your camera in tropical climates, make sure to expose the equipment to daylight and fresh air as much as possible to prevent fungal growth. Storage in airtight containers or cases is recommended only in conjunction with a desiccant like silica gel.

LENS

- A soft-bristle brush will usually suffice to remove dust from the outer lenses. Remove more severe soiling with a clean, soft cloth that is completely free of foreign matter. Wipe the lens in a circular motion from the center outward. We recommend using microfiber cloths that come in a protective container and are available from photography shops and other optical retailers. These cloths are machine-washable at 40°C. Do not use fabric softener and do not iron them. Never use spectacle lens cleaning cloths, as these are soaked in chemicals, which could damage the glass of the camera lenses.
- Attach a transparent UVA filter for optimal front lens protection in unfavorable conditions (e.g. sand, salt water spray). Please remember that the filter may create unwanted light reflections in some backlight situations and in case of high contrasts.
- Lens caps also protect the lens against accidental fingerprint smudges and rain.
- All mechanical bearings and sliding surfaces on your lens are lubricated. Make sure to periodically move the focus ring and the aperture ring to prevent

seizing if the lens will not be used for an extended period of time.

VIEWFINDER/LCD PANEL

- Switch off your camera and leave it to stand at room temperature for around 1 hour if condensation has formed on or in the camera. The condensation will disappear, once the camera temperature has reached room temperature.

RECHARGEABLE BATTERY

- Lithium-ion rechargeable batteries should only be stored partially charged, i.e. not fully depleted or fully charged. The camera LCD panel will show the current charge level of the battery. Charge the battery twice a year for around 15 minutes to avoid deep discharge in case of very long storage periods.

MEMORY CARDS

- Make sure to store memory cards in their anti-static container when not in use.
- Do not store memory cards where they will be exposed to high temperatures, direct sunlight, magnetic fields or static electricity. Always remove the memory card if the camera will not be used for an extended period of time.
- We recommend formatting memory cards from time to time, as fragmented residual data from deleted files may block some of the storage capacity.

Problem	Possible causes to check	Troubleshooting suggestions
Battery issues		
Battery is depleted too quickly	Battery too cold	Warm the battery (e.g. in pants pocket) and only insert directly before use
	Battery too hot	Allow battery to cool down
	LCD panel or EVF set too bright	Reduce brightness
	Power save mode deactivated	Activate Auto Power Off
	AF mode permanently activated	Select other mode
	Permanent WLAN connection	Deactivate WLAN when not in use
	Continuous use of LCD panel (e.g. in Live View mode)	Deactivate the function
	Battery has been recharged too many times	The battery has reached the end of its operating time Replace battery
	Tracking-AF with AFc activated	Use AFs or MF
Preview of the recorded images (Auto Review) activated	Deactivate the function	
Charging takes too long	Battery too hot or too cold	Charge the battery at room temperature
Charging pilot light is on, but battery isn't charging	The battery contacts are dirty	Clean the contacts with a soft, dry cloth
	Battery has been recharged too many times	The battery has reached the end of its operating time Replace battery
Camera problems		
The camera suddenly switches itself off	Battery is depleted	Charge or replace the battery
The camera won't switch on	Battery is depleted	Charge or replace the battery
	Battery too cold	Warming the battery (e.g. in pants pocket)
The camera switches off again immediately after it is switched on	Battery is depleted	Charge or replace the battery
Camera is heating up	Heat development due to high-res video recording (4K) or serial exposures with DNG	Not a fault; allow camera to cool down if it gets too hot
Camera does not recognize the memory card	The memory card is not compatible or defective	Replace the memory card
	Memory card is incorrectly formatted	Format the memory card in the camera (Caution: Loss of data!)
Menus and displays		
Electronic viewfinder is dark	EVF brightness is set too low	Set the EVF brightness

Display language is not English	-	Select English in the Language menu
Electronic viewfinder is dark	Switchover between EVF and LCD incorrectly set	Select a suitable setting
Viewfinder is out of focus		Check the diopter setting and adjust as needed
The LCD panel is too dark or too bright/not clear	The brightness setting is incorrect	Adjust the display brightness
	Viewing angle is too small	View the LCD panel at a perpendicular angle
	Brightness sensor is blocked	Make sure that the brightness sensor is not blocked
Live View stops suddenly or doesn't start	The camera is hot due to high ambient temperature, extended Live View operation, extended video shooting or continuous shooting	Allow camera to cool down
The brightness in Live View mode is not the same as in the images	The brightness settings for the LCD panel have no influence over the exposures	Adjust the brightness settings as needed
	Exposure preview is deactivated	Activate the function
The number of remaining shots does not count down after shooting	The image requires only very little memory space	This is not a fault; the number of remaining shots is calculated as approximations
Shooting		
Image noise appears on the LCD panel/in the viewfinder when the shutter button is pressed to the first pressure point	The gain is increased to aid image composition if the object is insufficiently lit with reduced lens aperture	Not a fault – image quality will not be impacted
LCD panel/viewfinder deactivates after a very short time	Power Save settings are activated	Change the settings as needed
The display switches off after shooting/the LCD panel goes dark after shooting	Flash loads after shooting, LCD panel deactivates during load time	Wait until the flash is charged
Flash won't fire	The flash cannot be used with the current settings	Refer to the list of flash function-compatible settings
	Battery is depleted	Charge or replace the battery
	Pressing the shutter button while flash is still loading	Wait until the flash is loaded
	Electronic shutter function is selected	Change the setting
The flash does not fully illuminate the object	Automatic bracketing or continuous shooting is activated	Change the setting
	Object is outside the flash range	Move object into flash range
	Flash is covered	Make sure the flash unit is not covered by your finger or some object

The camera won't release/shutter button is deactivated/shooting not possible	Memory card is full	Replace the memory card
	The memory card is not formatted	Reformat the memory card (Caution: Loss of data!)
	The memory card is write protected	Deactivate the write protection on the memory card (small lever on the side of the memory card)
	Dirt on the memory card contacts	Clean the contacts with a soft cotton or linen cloth
	The memory card is damaged	Replace the memory card
	The sensor is overheating	Allow camera to cool down
	The camera has switched off automatically (Auto Power Off)	Switch the camera back on Deactivate auto standby as needed
	Image data is being written to the memory card and the cache is full	Wait
	Noise reduction function is working (e.g. after night photography with long exposure times)	Wait or deactivate noise reduction
	Battery is depleted	Charge or replace the battery
	Camera is processing a image	Wait
Image numbering has reached its limit	See section "Data Management"	
Image does not sharpen automatically	AF is deactivated	Activate AF
No face detection/faces are not recognized	Face is covered (sunglasses, hat, long hair, etc.)	Remove distracting objects
	Face takes up to little space in the picture composition	Change image composition
	Face is tilted or horizontal	Keep face straight
	Camera not held straight	Hold camera straight
	Face is insufficiently lit	Use flash, improve illumination
Camera selects incorrect object	The incorrectly selected object is closer to the image center than the main object	Change the image section or take picture using the focus lock
	The incorrectly selected object is a face	Deactivate face detection
No continuous shooting available	The camera is overheated and the function was temporarily disabled to protect the camera	Allow camera to cool down
The image on the LCD panel displays lots of noise	Light enhancement function of the LCD panel in dark surroundings	Not a fault – image quality will not be impacted
Image storage takes a long time	Noise reduction is activated for long-term exposures	Deactivate the function
	The memory card inserted is slow	Use a suitable memory card
Manual white balance is unavailable	The image object is too bright or too dark	

Camera does not focus	Desired object part is too close to the camera	Select Macro mode
	Desired object part is very far away	Exit Macro mode
	Object not suitable for AF	Use Focus lock or select manual focus
AF frame is framed in red with activated AF; images out of focus	Focusing was unsuccessful	Try to focus again
No AF frame selectable	Focus ring not in AF position	Turn the focus ring to the AF position
	Automatic Metering Field Control or Face Detection in AF Mode is selected	Select other control mode
	One of the scene modes is currently active	Select the P-A-S-M setting under Scene Mode
	Image review is activated	Deactivate image review
	Camera is in Standby mode	Press the shutter button to the first pressure point
AF assist lamp does not light up	Camera is in video shooting mode	Change the mode
	Function is deactivated	Activate AF
Video recording		
No video is recorded	The camera is overheated and the function was temporarily disabled to protect the camera	Allow camera to cool down
Video shooting stops	Maximum length of individual video sequence was reached	
	The memory card's write speed is too low for the selected video resolution/compression	Insert another memory card or change the storage method
L-Log is not selectable in video mode	A 10 bit format was not selected as the video format	Switch to 10 bit format or MOV in video format
Review and photo management		
Selected images cannot be deleted	Some of the selected images are write protected	Remove write protection (using the device with which the file was originally set to write protected)
File numbering does not start at 1	The memory card contains previously stored images	See section "Data Management"
The time and date settings are incorrect or are not displayed	The camera has not been in use for an extended period of time (the battery was removed)	Insert a charged battery and configure the correct settings
The time and date stamp on images are incorrect	Time settings are incorrect	Set the time correctly Caution: Time settings will be lost if the camera is not used/remains in storage with a depleted battery over an extended period of time

The time and date stamp on images are unwanted	Setting was ignored	Cannot be removed in retrospect Deactivate the function as needed
Images are damaged or missing	The memory card was removed while the readiness indicator was flashing	Never remove the memory card while the readiness indicator is flashing. Charge the battery.
	The memory card formatting is faulty or the card is damaged	Reformat the memory card (Caution: Loss of data!)
The most recent image is not displayed on the LCD panel	Preview is deactivated	Activate Auto Review
Parts of my video scenes are not fully in the picture	Difference of aspect ratios between camera and playback medium	Set the correct aspect ratio on the camera
Image quality		
Image noise	Long exposure times (>1 s)	Activate the noise reduction function for long-term exposure
	ISO sensitivity set too high	Decrease ISO sensitivity
Unnatural colors	White balance not or incorrectly set	Adjust white balance to light source or adjust manually
Round white stains, similar to soap bubbles	Flash photography in a very dark environment: reflections of dust particles	Deactivate the flash
Images are out of focus	Lens is dirty	Clean the lens
	Lens is obstructed	Make sure that lens is unobstructed
	Camera moved during shooting	Use flash
		Mount the camera on a tripod Use faster shutter speeds
Macro Function	Select the appropriate mode	
Images are overexposed	Flash is activated in bright surroundings	Change the flash mode
	Strong light source in the image	Avoid strong light sources in the image
	(Half) backlight falling into the lens (also from light sources outside the image range)	Use the lens hood or change to another object
	Selected exposure time is too long	Select a shorter exposure time
Out of focus/picture stabilizer not functioning	Shooting at a dark location without flash	Use a tripod
The image is grainy or there is image noise	ISO sensitivity set too high	Decrease ISO sensitivity
Horizontal stripes	Picture was taken with electronic shutter under a light source like a fluorescent lamp	Try shorter shutter speeds
Unnatural colors and brightness	Shooting in artificial light or extreme brightness	Set white balance or select correct lighting presets

No images are displayed	No memory card inserted	Insert a memory card
	The photos were taken with another camera	Transfer the files to another device to view them
Images cannot be displayed	File name was changed on a PC	Use suitable software for file transfers from a PC to the camera
Video quality		
Video recordings show flickering/stripes	Light source interference in artificial lighting	Select a different frame rate (suitable for the local alternating current (AC) grid frequency) under Video Format / Resolution
Camera noise in video recording	The dials were used	Avoid using the dials during video shootings
No sound on video recording	Playback volume is set too low	Increase playback volume
	Microphone was covered during shooting	Make sure the microphone is not obstructed while shooting video
	Speakers are covered	Make sure that speakers are unobstructed during playback
	Microphone was deactivated while recording	Activate the microphone
Flickering or horizontal stripes in the video recording	CMOS sensors will display this phenomenon when light sources like LED lamps or fluorescent tubes are used	Quality may be improved by selecting a manual shutter speed (e.g. 1/100 s)
Smartphones/WLAN		
WLAN connection gets interrupted	Camera deactivates when it overheats (safety feature)	Allow camera to cool down
Cannot pair with a mobile device	The camera was already paired with the mobile device	Delete the camera registration from the Bluetooth settings in the mobile device and repeat pairing process
Mobile device connection/image transfer not working	The mobile device is too far away	Bring the devices closer to each other
	Interference from other devices in the vicinity, e.g. other smartphones or a microwave oven	Increase distance to interfering devices
	Interference from multiple mobile devices in the vicinity	Re-establish the connection/disconnect other mobile devices
	Mobile device is currently connected to another device	Check connection
Camera does not appear on the WLAN configuration screen of the mobile device	Mobile device does not recognize camera	Switch the WLAN function of the mobile device off and on again

MENU OVERVIEW

FUNCTION BUTTONS

The following control elements are available for direct access (see p. 54).

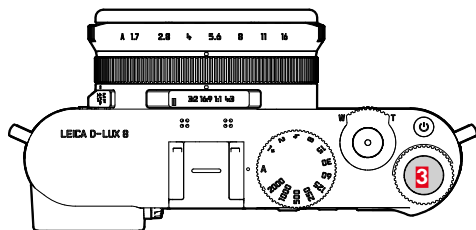

3 Thumbwheel button

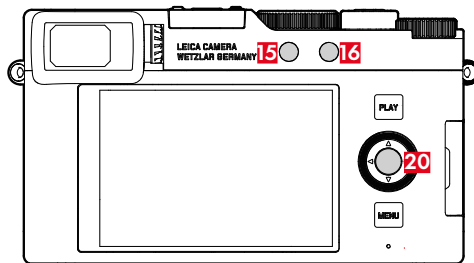

15 Function button 1

16 Function button 2

20 Center button

LEGEND

◆ = Accessible via the status screen

★ = Available for the favorites menu

● = Available for function buttons

● = Factory setting on the function buttons

DIRECT ACCESS

Function	PHOTO			VIDEO		
	Status screen	Function buttons		Status screen	Function buttons	
Photo - Video*	◆	●	● (16)	◆	●	● (16)
Toggle Info Levels		●	● (20)			
Exposure lock						
AF-L + AE-L		●				
AE-L		●				
AF-L		●				
Drive Mode	◆	●				
Interval Shooting		●				
Exposure Bracketing		●				
Self-timer						
Focusing		●			●	
Focus Mode	◆	●		◆	●	
AF Mode	◆	●		◆	●	
Focus Aid		●			●	
Auto Magnification		●			●	
Focus Peaking		●			●	
AF Assist Lamp		●			●	
Touch AF		●			●	
Touch AF in EVF		●			●	
Exposure Metering	◆	●		◆	●	
Exposure Compensation	◆	●		◆	●	

* Some function are available only via direct access. These are listed at the top of the table.

ISO	◆	●	● (3)	◆	●	● (3)
Auto ISO Settings		●			●	
White Balance	◆	●		◆	●	
Gray card		●			●	
Color Temperature		●			●	
Photo File Format	◆	●				
JPG Settings						
JPG Resolution	◆	●				
Noise Reduction (JPG)	◆	●				
Film Style		●			●	
Highlight / Shadow		●			●	
iDR		●			●	
Scene Mode	◆	●		◆	●	
OIS						
Shutter Type		●				
Flash Settings		●				
Flash Mode						
Exposure Preview		●				
Auto Review						
Noise Reduction (long exposure)		●				
Thumb Wheel						
User Profile	◆	●		◆	●	
Manage Profiles						
Capture Assistants						
Display Settings						
EVF <> LCD		●			●	

LCD Brightness						
LCD Color Adjustment						
EVF Color Adjustment						
Leica FOTOS	◆	●		◆	●	
Format Storage				◆	●	
Camera Settings						
Edit File Name						
Reset Image Numbering						
Power Saving				◆	●	
Acoustic Signal					●	
Volume						
Date & Time					●	
Camera Information				◆	●	
Firmware						
Firmware Update		●	● (15)		●	● (15)
License Information		●				
Regulatory Information		●			●	
Language						
Reset Camera		●				

DIRECT ACCESS IN REVIEW MODE

Function	Review (photo)/Playback (video)		
	Play Menu	Function buttons	
Toggle Info Levels		●	● 20
Rate / Unrate		●	● 3
EVF-LCD		●	● 15
Delete Single	●	●	● 16
Filter	●	●	
Delete Multi	●	●	
Delete All without ★	●	●	

TECHNICAL DATA

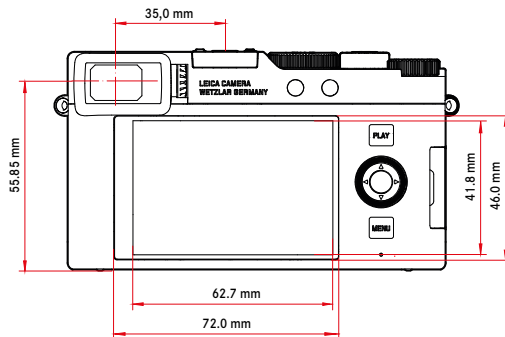
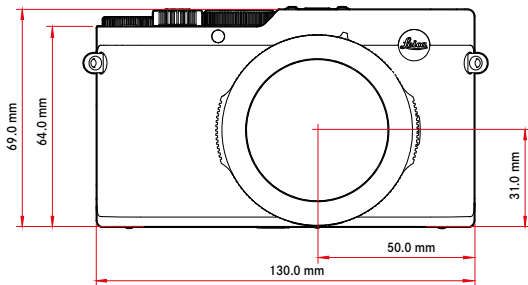
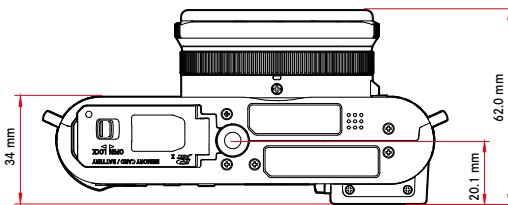
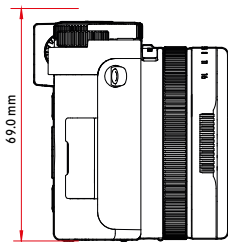

CAMERA

Designation

Leica D-Lux 8

Camera type

Digital compact camera

Type No.

3952A

Order No.

19191

Buffer memory

DNG™: 14 or higher*, JPG: 100 or higher*

	DNG	DNG + JPG	JPG
11 fps	12	12	100
7 fps	13	13	100
2 fps	23	14	100

*Based on CIPA standards and a memory card with high read/write speed. Capacity, depending on frame rate and picture format, estimated quantity (number of possible images in the buffer memory)

Storage medium

UHS-I/UHS Speed Class 3, SD-(≤2GB)/SDHC (≤32GB)-/SDXC (≤128GB) memory card

Material

Full metal housing: magnesium die-cast, leatherette covering

Operating conditions

0°C to +40°C

Interfaces

ISO accessory shoe with additional control contacts for Leica flash units, HDMI jack Type D, USB 3.1 Gen 1 Type C

Tripod thread

A 1/4 DIN 4503 (1/4") with stainless steel in the base

Weight

Approx. 397 g/357 g (with/without battery)

SENSOR

Sensor size

4/3" CMOS sensor, 21.77 MP/17 MP (total/effective)

Filter

RGB color filter, UV/IR filter

File formats

Photo: DNG™ (raw data), DNG + JPG, JPG (DCF 2.0, Exif 2.31)

Video: MP4, H.264, AAC stereo

Image resolution

	Aspect ratio	RESOLUTION
DNG™	16:9	5152 x 2904 (15 MP)
	3:2	4928 x 3288 (16.2 MP)
	4:3	4736 x 3552 (16.8 MP)
	1:1	3552 x 3552 (12.6 MP)
L-JPG	16:9	5152 x 2904 (15 MP)
	3:2	4928 x 3288 (16.2 MP)
	4:3	4736 x 3552 (16.8 MP)
	1:1	3552 x 3552 (12.6 MP)

	Aspect ratio	RESOLUTION
M-JPG	16:9	3840 x 2160 (8.3 MP)
	3:2	3504 x 2336 (8.2 MP)
	4:3	3360 x 2520 (8.5 MP)
	1:1	2528 x 2528 (6.4 MP)
S-JPG	16:9	1920 x 1080 (2.1 MP)
	3:2	2496 x 1664 (4.2 MP)
	4:3	2368 x 1776 (4.2 MP)
	1:1	1776 x 1776 (3.2 MP)

File size

DNG™: approx. 31 MB, depending on resolution and image content

JPG: depending on resolution and image content

Video: max. length: 29 min

Color depth

DNG™: 12 bit

JPG: 8 bit

Color space

Photo: sRGB

Video Resolution

	RESOLUTION
4K	3840 x 2160
Full HD	1920 x 1080
HD	1280 x 720

Video frame rate / bit rate

4K 30 p	29.97 fps	4K 4:2:0 / 8 bit	h.264	L-GOP	100 Mbps
4K 24 p	23.98 fps	4K 4:2:0 / 8 bit	h.264	L-GOP	100 Mbps
FHD 60 p	59.94 fps	FHD 4:2:0 / 8 Bit	h.264	L-GOP	28 Mbps
FHD 30 p	29.97 fps	FHD 4:2:0 / 8 Bit	h.264	L-GOP	20 Mbps
HD 30 p	29.97 fps	HD 4:2:0 / 8 Bit	h.264	L-GOP	10 Mbps

LENS

Designation

Leica DC Vario-Summilux 10.9–34 f/1.7-2.8 ASPH., 35 mm equivalent: 24–75 mm, aperture range: 1.7–16/2.8–16 (at 10.9/34 mm)

Lens filter thread

E43

Image stabilization

Visual compensation system for photos and video recordings

Aperture range

Depending on zoom level, F1.7 to F16 in 1/3 EV increments (wide angle) F1.7 to F16; (tele zoom) F2.8 to F16 in 1/3 EV increments

VIEWFINDER/LCD PANEL

Viewfinder (EVF)

OLED, Resolution: 2,360,000 dots, 60 fps, magnification: 0.74x, at aspect ratio: 4:3, exit pupil position: 20 mm, setting range -4/+4 dpt, with eye sensor for automatic switchover between viewfinder and LCD panel, time delay 0.005 s

LCD panel

3" TFT LCD, approx. 1,843,200 dots, 384 ppi, aspect ratio 3:2, touch panel

SHUTTER

Shutter type

Mechanical central shutter or optional electronic shutter

Shutter speeds

Mechanical shutter: 60 s to 1/4000 s

Electronic shutter function: 1 s to 1/16000 s

Shutter button

Two-stage

(1st stage: Activation of the camera electronics including autofocus and exposure metering, 2nd stage: Taking the picture)

Self-timer

Delay time: 2 s or 12 s

Drive mode

Single, Interval Shooting, Exposure Bracketing

Continuous shooting:

- Continuous Shooting - 2 fps, 12 bit, AF
- Continuous Shooting - 7 fps, 10 bit
- Continuous Shooting - 11 fps, 10 bit

FOCUSING

Focusing range

50 cm to ∞

With macro setting: from 3 cm (wide angle), from 30 cm (tele zoom)

Focus mode

Automatic, Automatic (macro), or Manual

Autofocus system

Contrast detection

Autofocus modes

Intelligent AF (autonomously selects AFs and AFc), AFs, AFc

Autofocus metering methods

Spot (can be shifted), Field (can be shifted and scaled), Multi-Field, Zone (can be shifted), Eye / Face, Tracking

Autofocus metering fields

49

EXPOSURE

Exposure metering

TTL (exposure metering through the lens), with working aperture

Metering principle

Exposure metering occurs via the image sensor for all exposure metering methods

Exposure metering methods

Spot, Center-Weighted, Multi-Field

Exposure modes

Program AE mode (P)

Aperture-priority mode (A): manual aperture setting

Shutter-priority mode (S): manual shutter-speed setting

Manual (M): manual setting for shutter speed and aperture

Various fully automatic variants (Scene Mode):

Auto, Portrait, Landscape, Night Scenery, Miniature Effect, One Point Color, HDR

Exposure compensation

±3 EV in 1/3 EV increments

Automatic bracketing

3, 5 or 7 frames, graduations between shoots up to 1 EV, in 1/3 EV increments

additional optional exposure compensation: up to ±3 EV

ISO sensitivity range

	Photo	Video
Auto ISO	ISO 200–25 000	ISO 200–6 400
Manual	ISO 100–25 000	ISO 100–6 400

White balance

Automatic (Auto), default (Daylight, Cloudy, Shadow, Tungsten, Flash), manual metering (Gray Card), manual color temperature settings (Color Temperature, 2500 K to 10000 K)

FLASH

Flash unit

Included in the delivery: Leica CFD

Flash angle

Aligned with the shortest focal length of the lens of 10.9 mm

Guide number

10/7 (at ISO 200/100)

Flash range

Approx. 0.6–14.1 m/0.3–8.5 m (at shortest/longest focal length)

Flash unit connector

Via the accessory shoe

Flash sync time

↔ : 1/4000 s, slower shutter speeds available

Flash exposure compensation

±3 EV in 1/3 EV increments

EQUIPMENT

Microphone

Stereo

Speaker

Mono

WLAN

WLAN function for connecting to the Leica FOTOS app.

The Leica app is available from the Apple App Store™ or the Google Play Store™.

IEEE802.11b/g/n Channel 1-11 (2412-2462 MHz), maximum output (e.i.r.p.): 5.9 dBm, encryption method: WLAN-compatible WPA™/WPA2™

Bluetooth

Bluetooth 5.0 LE: Channel 0-39 (2402-2480 MHz), maximum output (e.i.r.p.): 1.2 dBm

GPS

Not available everywhere due to country-specific legislation; can be added via the Leica FOTOS app. Data is written to Exif header of the picture files.

Menu languages

English, German, French, Italian, Spanish, Portuguese, Russian, Japanese, Traditional Chinese, Simplified Chinese, Korean

POWER SUPPLY

Rechargeable battery (Leica BP-DC15)

Lithium-ion rechargeable battery, rated voltage: 7.2V (DC), capacity: 1025 mAh (min.), manufacturer: Panasonic Energy (Wuxi) Co. Ltd., Made in China

Charging via USB

With camera switched off: 5V/1500 mA (2.5W or greater)

Rated values for input voltage/power

7.2V = 0.9 A (battery), 5V = 1.0 A (USB)

LEICA CUSTOMER CARE

Please contact the Customer Care department of Leica Camera AG for the maintenance of your Leica equipment and for help and advice regarding Leica products and how to order them. You can also contact the Customer Care department or the repair service provided by your regional Leica subsidiary for repairs or warranty claims.

LEICA GERMANY

Leica Camera AG

Leica Customer Care
Am Leitz-Park 5
35578 Wetzlar
Germany

Phone: +49(0)6441 2080-189

Fax: +49(0)6441 2080-339

Email: customer.care@leica-camera.com

<https://leica-camera.com>

LEICA AKADEMIE

Have a look at our full seminar program with many interesting workshops on the topic of photography at: <https://leica-camera.com/en-US/leica-akademie>

YOUR NATIONAL REPRESENTATIVE

You will find the Customer Care department responsible for your locality on our homepage:

<https://leica-camera.com/en-US/contact>

