

**OLYMPUS®**

# CAMEDIA

**INSTRUCTIONS**

**DIGITAL CAMERA**

# D-360L

**PREPARATIONS**

**TAKING PICTURES**

**DISPLAYING PICTURES  
ON THE LCD MONITOR**

**PRINTING PICTURES**

**USING A PERSONAL  
COMPUTER**

**MISCELLANEOUS**

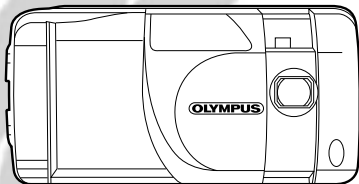

- Before using your camera, read this manual carefully to ensure correct use.
- We recommend that you take test shots to get accustomed to your camera before taking important photographs.

## IMPORTANT SAFETY INSTRUCTIONS

Thank you for purchasing the Olympus digital camera. Before you start to use your new camera, please read these instructions carefully to obtain optimum performance and a longer service life from the unit. Be sure to retain this manual for future reference.



**CAUTION**  
RISK OF ELECTRIC SHOCK  
DO NOT OPEN



**CAUTION:** TO REDUCE THE RISK OF ELECTRIC SHOCK, DO NOT REMOVE COVER (OR BACK). NO USER-SERVICEABLE PARTS INSIDE. REFER SERVICING TO QUALIFIED OLYMPUS SERVICE PERSONNEL.



The lightning flash with the arrowhead symbol, within an equilateral triangle, is intended to alert the user to the presence of uninsulated "dangerous voltage" within the product's enclosure that may be of sufficient magnitude to constitute a risk of electric shock to persons.



The exclamation point within an equilateral triangle is intended to alert the user to the presence of important operating and maintenance (servicing) instructions in the literature accompanying the product.

**WARNING:**  
TO REDUCE THE RISK OF FIRE OR SHOCK HAZARD, DO NOT EXPOSE THIS EQUIPMENT TO RAIN, ANY LIQUID OR MOISTURE.

1. **Read Instructions** — All the safety and operating instructions should be read before the product is operated.
2. **Retain Instructions** — The safety and operating instructions should be retained for future reference.
3. **Heed Warnings** — All warnings on the product and in the operating instructions should be adhered to.
4. **Follow Instructions** — All operating and use instructions should be followed.
5. **Cleaning** — Unplug this product from the wall outlet before cleaning. Do not use liquid cleaners or aerosol cleaners. Use a damp cloth for cleaning.
6. **Attachments** — Attachments not recommended by the product manufacturer may be hazardous and/or cause damage to the product. Do not use these attachments.
7. **Water and Moisture** — Do not use this product near water — for example, near a bath tub, kitchen sink, or laundry tub, in a wet basement, near a swimming pool or rain.
8. **Accessories** — Do not place this product on an unstable stand, tripod, bracket, table, or cart. The product may fall, causing serious injury to a child or adult, and serious damage to the product. Use only with a tripod, stand, or bracket. Any mounting of the product should follow the manufacturer's instructions, and should use a mounting accessory recommended by the manufacturer.
9. **Power Sources** — This product should be operated only from the type of power source indicated on the label. If you are not sure of the type of power supply to your home, consult your product dealer or local power company. For products intended to operate from battery power, or other sources, refer to the operating instructions.

10. **Grounding or Polarization** — This product, when used with an optional AC adapter, may be equipped with a polarized alternating-current line plug (a plug having one blade wider than the other). This plug will fit into the power outlet only one way. This is a safety feature. If you are unable to insert the plug fully into the outlet, try reversing the plug. If the plug should still fail to fit, contact your electrician to replace your obsolete outlet.
11. **Power-Cord Protection** — Power-supply cords should be routed so that they are not likely to be walked on or pinched by items placed upon or against them, paying particular attention to cords at plugs, convenience receptacles, and the point where they exit from the product.
12. **Lightning** — For added protection for this product when used with an optional AC adapter during a lightning storm, or when it is left unattended and unused for long periods of time, unplug it from the wall outlet and disconnect the antenna or cable system. This will prevent damage to the product due to lightning and power-line surges.
13. **Overloading** — Do not overload wall outlets, extension cords, or integral convenience receptacles as this can result in a risk of fire or electric shock.
14. **Object and Liquid Entry** — Never push objects of any kind into this product through openings as they may touch dangerous voltage points or short-out parts that could result in a fire or electric shock. Never spill liquid of any kind on the product.
15. **Servicing** — Do not attempt to service this product yourself as opening or removing covers may expose you to dangerous voltage or other hazards. Refer all servicing to qualified service personnel.

16. **Damage Requiring Service** — If using the optional AC adapter, unplug this product from the wall outlet and refer servicing to qualified service personnel under the following conditions:
  - a) If liquid has been spilled, or objects have fallen into the product.
  - b) If the product has been exposed to rain or water.
  - c) If the product does not operate normally by following the operating instructions. Adjust only those controls that are covered by the operating instructions as an improper adjustment of other controls may result in damage and will often require extensive work by a qualified technician to restore the product to its normal operation.
  - d) If the product has been dropped or damaged in any way.
  - e) When the product exhibits a distinct change in performance — this indicates a need for service.
17. **Replacement Parts** — When replacement parts are required, be sure the service technician has used replacement parts specified by the manufacturer or which have the same characteristics as the original part. Unauthorized substitutions may result in fire, electric shock, or other hazards.
18. **Safety Check** — Upon completion of any service or repairs to this product, ask the service technician to perform safety checks to determine that the product is in proper operating condition.
19. **Heat** — The product should be situated away from heat sources such as radiators, heat registers, stoves, or other products (including amplifiers) that produce heat.

## Radio and Television Interference

Change or modifications not expressly approved by the manufacturer may void the user's authority to operate this equipment. This equipment has been tested and found to comply with the limits for Class B digital device, pursuant to Part 15 of the FCC Rules. These limits are designed to provide reasonable protection against harmful interference in a residential installation. This equipment generates, uses, and can radiate radio frequency energy and, if not installed and used in accordance with the instructions, may cause harmful interference to radio communications.

However, there is no guarantee that interference will not occur in a particular installation. If this equipment does cause harmful interference to radio or television reception, which can be determined by turning the equipment off and on, the user is encouraged to try to correct the interference by one or more of the following measures:

- Reorient or relocate the receiving antenna.
- Increase the distance between the camera and receiver.
- Connect the equipment to an outlet on a circuit different from that to which the receiver is connected.

Only the included RS-232C serial cable should be used to connect the camera to a personal computer (PC).

### Declaration of Conformity

Model Number: D-360L

Trade Name: OLYMPUS

Responsible party: Olympus America Inc.

Address: 2 Corporate Center Drive, Melville, New York 11747-3157  
U.S.A.

Telephone number: 516-844-5000

This device complies with Part 15 of the FCC rules. Operation is subject to the following two conditions:

- (1) This device may not cause harmful interference, and
- (2) This device must accept any interference received, including interference that may cause undesired operation.

This Class B digital apparatus meets all requirements of the Canadian Interference-Causing Equipment Regulations.

**WARNING**

- Keep the batteries away from children.
- If a battery is swallowed, see a doctor immediately.
- Dispose of used lithium batteries promptly, in a safe manner that complies with all applicable laws.
- The lithium battery may present the risk of fire or chemical burn if mishandled.
- Do not recharge, disassemble, heat above 212°F (100°C) or dispose of in a fire.
- Before use, wipe the battery clean with a dry soft cloth to assure good contact.
- Never use metallic tweezers to hold the battery, and never short circuit the (+) and (-) sides of the battery.

Windows® is a registered trademark of Microsoft Corporation.  
Macintosh™ is a trademark of Apple Computer Inc.  
All other brand names and product names are registered.

**Legal and other notices**

- All contents of this publication are subject to change without notice.
- Although the contents of this publication have been carefully checked to avoid errors, some may still occur. If you are in doubt about any points or find mistakes or omissions, please contact us.
- No part of this publication may be reproduced or reprinted except for personal use without the prior permission of Olympus.
- Olympus makes no representations or warranties regarding any damages, or benefit expected by using this unit lawfully, or any request from a third person, which are caused by the inappropriate use of this unit.
- Olympus makes no representations or warranties regarding any damages or any benefit expected by using this unit lawfully which are caused by erasing the picture data.
- Olympus reserves all rights to this manual.

---

## FOR SAFE USE



**Danger:** Ignoring this Danger mark and operating this product incorrectly may lead to serious injury or death.



**Warning:** Ignoring this Warning mark and operating this product incorrectly may lead to serious injury or death.



**Caution:** Ignoring this Caution mark and operating this product incorrectly may lead to injury.

---

## BATTERY HANDLING

IGNORING THE WARNINGS BELOW MAY LEAD TO FLUID LEAK, BATTERY HEAT GENERATION, FIRE, EXPLOSION, ELECTRIC SHOCK OR BURNING.



### DANGER

1. WHEN USING NiMH BATTERIES, USE OLYMPUS BRAND NiMH BATTERIES AND CHARGER.
2. DO NOT LOAD OR USE BATTERIES WITH THEIR +/- TERMINALS UPSIDE DOWN. DO NOT LOAD BATTERIES FORCEFULLY.
3. DO NOT MODIFY OR DISASSEMBLE BATTERIES OR CONNECT THEM TO THE CAMERA USING SOLDER OR IN ANY OTHER WAY THAN INSTRUCTED IN THIS MANUAL. IT MAY DESTROY THE TERMINALS OR CAUSE BATTERY FLUID TO LEAK.
4. DO NOT CONNECT THE TERMINALS WITH METAL OR CARRY/STORE BATTERIES WITH METALLIC NECKLACES OR HAIRPINS.
5. DO NOT CONNECT THE CAMERA DIRECTLY TO A POWER OUTLET OR CIGARETTE LIGHTER IN A VEHICLE.
6. DO NOT THROW BATTERIES INTO FIRE OR HEAT THEM.
7. IF BATTERY FLUID GETS IN YOUR EYES, DO NOT RUB THEM. WASH THE FLUID OUT WITH CLEAN WATER AND CONTACT A PHYSICIAN IMMEDIATELY.

 **WARNING**

1. DO NOT ALLOW BATTERIES TO COME IN CONTACT WITH WATER OR SEA WATER.
2. DO NOT USE BATTERIES THAT ARE NOT DESIGNATED FOR USE WITH THIS CAMERA.
3. DO NOT THROW BATTERIES INTO FIRE, EXPOSE THEM TO HEAT, OR SHORT-CIRCUIT OR DISASSEMBLE THEM.
4. DO NOT USE OLD AND NEW OR CHARGED AND UNCHARGED BATTERIES, OR BATTERIES OF DIFFERENT CAPACITIES/KINDS/BRANDS MIXED TOGETHER.
5. DO NOT CHARGE UNCHARGEABLE ALKALINE OR LITHIUM BATTERIES.
6. DO NOT LOAD OR USE BATTERIES WITH THEIR +/- TERMINALS UPSIDE DOWN.
7. DO NOT USE BATTERIES IF THEIR BODY IS NOT COVERED BY THE INSULATING SHEET OR IF THE SHEET IS TORN AS IT MAY CAUSE FLUID LEAK, FIRE OR INJURY.
8. IF NiMH BATTERIES ARE NOT CHARGED WITHIN THE SPECIFIED TIME, STOP CHARGING.
9. DO NOT USE BATTERIES IF A FLUID LEAK, CHANGE OF COLOR/SHAPE OR OTHER ABNORMALITY IS FOUND.
10. STORE AND USE BATTERIES OUT OF CHILDREN'S REACH. IF A CHILD SWALLOWS BATTERIES, CONTACT A PHYSICIAN IMMEDIATELY.
11. IF BATTERY FLUID GETS ON SKIN OR CLOTHES, SOAK IT WITH CLEAN WATER AS IT MAY BURN THE SKIN.
12. DO NOT MODIFY THE BATTERY COMPARTMENT ON THE CAMERA OR INSERT FOREIGN OBJECTS IN IT.

## CAUTION

1. DO NOT APPLY PHYSICAL SHOCK TO BATTERIES.
2. DO NOT USE OLD AND NEW OR CHARGED AND UNCHARGED BATTERIES, OR BATTERIES OF DIFFERENT CAPACITIES/KINDS/BRANDS MIXED TOGETHER.
3. WHEN CHARGING NiMH BATTERIES, CHARGE ALL FOUR BATTERIES AT THE SAME TIME.
4. CHARGE NiMH BATTERIES BEFORE USING THEM FOR THE FIRST TIME OR AFTER NOT USING THEM FOR A LONG TIME.
5. KEEP BATTERIES UNLOADED WHEN NOT IN USE FOR A LONG TIME, AS IT MAY CAUSE FLUID LEAK OR HEAT GENERATION.
6. DO NOT USE BATTERIES IF A FLUID LEAK, CHANGE OF COLOR/SHAPE OR OTHER ABNORMALITY IS FOUND, AND TAKE THEM TO AN AUTHORIZED OLYMPUS SERVICE CENTER.
7. DO NOT USE OR STORE BATTERIES UNDER DIRECT SUNLIGHT OR IN HOT TEMPERATURES SUCH AS IN A HOT VEHICLE OR IN FRONT OF A HEATER.
8. DO NOT UNLOAD BATTERIES IMMEDIATELY AFTER USING THE CAMERA FOR A LONG TIME AS THEY GET HOT.

---

## HANDLING

### WARNING

1. NEVER TRY TO USE THE FLASH WHEN TAKING PICTURES OF PEOPLE (ESPECIALLY INFANTS) AT CLOSE RANGE. THE CAMERA'S FLASH MAY DAMAGE THE SUBJECT'S EYES AT CLOSE RANGE. DO NOT TAKE PICTURES OF CHILDREN FROM A DISTANCE OF LESS THAN THREE FEET.
2. DO NOT AIM YOUR CAMERA DIRECTLY AT THE SUN OR OTHER EXTREMELY BRIGHT OBJECTS. THIS MAY DAMAGE YOUR EYES.
3. DO NOT USE THIS CAMERA IN THE VICINITY OF FLAMMABLE OR EXPLOSIVE GAS.

4. DO NOT LEAVE THIS CAMERA WITHIN THE REACH OF INFANTS OR CHILDREN.
  - THE CHILD MIGHT PUT THE STRAP AROUND HIS OR HER NECK. THIS COULD CAUSE STRANGULATION OR CHOKING.
  - THE CHILD MIGHT SWALLOW BATTERIES OR SMALL ATTACHMENTS. IF THIS HAPPENS, CONTACT A PHYSICIAN IMMEDIATELY.
  - THE CHILD MIGHT ACTIVATE THE FLASH FROM TOO CLOSE AND CAUSE DAMAGE TO HIS OR HER EYES.
  - THE CHILD MAY BE INJURED.
5. BATTERY FLUID MAY LEAK, GENERATING HEAT AND POSSIBLY CAUSING A FIRE OR EXPLOSION.
  - DO NOT USE NON-RECOMMENDED BATTERIES.
  - DO NOT THROW BATTERIES INTO A FIRE, OR EXPOSE TO HEAT.
  - DO NOT DISASSEMBLE THE UNIT WITH BATTERIES INSIDE.
  - DO NOT USE NEW BATTERIES AND OLD BATTERIES TOGETHER. DO NOT MIX DIFFERENT TYPES OF BATTERIES OR DIFFERENT MANUFACTURERS' BATTERIES.
  - DO NOT CHARGE ALKALINE AND LITHIUM BATTERIES.
  - KEEP UNLOADED BATTERIES OUT OF THE REACH OF INFANTS AND CHILDREN. IF AN INFANT OR CHILD SWALLOWS THE BATTERIES, CONTACT A PHYSICIAN IMMEDIATELY.
  - DO NOT LOAD THE BATTERIES IN THE OPPOSITE DIRECTION TO THAT SHOWN IN THESE INSTRUCTIONS.
  - NEVER USE ANY BATTERY WHOSE BODY IS NOT COVERED BY THE INSULATING SHEET.
6. DO NOT STORE THE CAMERA IN HUMID OR DUSTY PLACES. THIS MAY CAUSE FIRE OR ELECTRIC SHOCK.
7. DO NOT COVER THE FLASH WITH YOUR HAND DURING OPERATION. DO NOT TOUCH THE FLASH AFTER FIRING IT CONTINUOUSLY. YOU MAY GET BURNED.
8. IF YOU DROP THE CAMERA IN WATER OR GET WATER INSIDE IT, UNLOAD THE BATTERIES IMMEDIATELY AND CONTACT YOUR NEAREST OLYMPUS SERVICE CENTER. LEAVING BATTERIES IN A WET CAMERA MAY CAUSE FIRE OR ELECTRIC SHOCK.

## CAUTION

1. IF YOU NOTICE AN UNUSUAL SMELL, NOISE, OR SMOKE EMITTING FROM THIS CAMERA, UNLOAD THE BATTERIES CAREFULLY TO AVOID BEING BURNED. (WHEN UNLOADING BATTERIES, DO IT OUTSIDE AWAY FROM FLAMMABLE OBJECTS, AND DO NOT TOUCH BATTERIES WITH YOUR BARE HANDS.) CONTACT YOUR NEAREST OLYMPUS SERVICE CENTER IMMEDIATELY.
2. NEVER ATTEMPT TO DISASSEMBLE THIS CAMERA. IT CONTAINS HIGH-VOLTAGE CIRCUITRY THAT MAY CAUSE ELECTRIC SHOCK AND INJURY.
3. DO NOT OPERATE THE CAMERA WITH WET HANDS AS YOU MAY GET AN ELECTRIC SHOCK.
4. DO NOT STORE THE CAMERA IN ANY PLACE EXPOSED TO EXCESSIVE HEAT. THIS MAY WEAKEN THE PARTS OR CAUSE A FIRE.

---

## CARE AND STORAGE

### HANDLING

- Do not use or store the camera in places exposed to direct sunlight (e.g. a beach in summer), excessive heat, humidity, extreme variations of temperature and humidity, sand or dust, excessive moisture, or vibrations (e.g. in a car).
- Do not use or store the camera near a heater, cooler, or humidifier, or near a fire, magnetic fields, or volatile materials.
- Do not shake the camera or subject it to shocks.
- Do not leave the camera with its lens pointing towards direct sunlight. This will damage the lens.
- Do not leave the camera unused for a long period of time. This may cause battery leakage and can lead to problems including the growth of mold in the camera. Before using, press the Shutter release button to check operation.
- Do not turn the camera when it is mounted on a tripod. Turn the tripod head instead.
- Do not touch any of the camera's internal parts.
- Do not use the flash for extended periods as this can cause the flash to become excessively hot. Do not touch the flash when it is hot.
- Do not improperly open or modify the camera, as it may result in a shock or injury.



## BATTERY HANDLING

- This camera uses four AA NiMH batteries, AA alkaline batteries, AA lithium batteries or AA NiCd batteries.
- Performance will be limited with alkaline batteries, especially in low temperatures. NiMH batteries are recommended.
- AA manganese batteries or a CR-V3 lithium battery pack cannot be used.
- Use the batteries correctly. Incorrect use can cause fluid leakage, heat generation, or other damage. When replacing batteries, be sure to load them correctly.
- The batteries may be temporarily disabled when exposed to cold temperatures. Try to keep the camera and batteries warm when using the camera in a cold environment. Batteries that are weak in cold temperatures will be restored under normal temperatures.
- Sweat, oil, etc. can prevent a battery's terminals from making electrical contact. To avoid this, wipe both terminals before loading the battery.
- Keep spare batteries on hand when going on a long trip. New batteries may be difficult or impossible to obtain abroad.
- When using NiMH batteries or NiCd batteries, make sure to charge them fully with the correct battery charger.
- Read instructions carefully before handling NiMH batteries or NiCd batteries.
- NEVER use any battery whose body is not covered by the insulating sheet, as it may cause a fire or injury.
- Recommended Temperature when Using NiMH Batteries  
Operation: 32 ~ 104°F, Charge: 32 ~ 104°F, Storage: -4 ~ 86°F  
(Usage outside this temperature range may limit battery performance or shorten battery life. Unload batteries from the camera when not in use.)

### Important

- "Note" indicates information you should be aware of.
- Actual product may differ slightly from that shown in illustrations.

# CONTENTS

Important safety instructions.....	2
For safe use.....	8
Battery handling.....	8
Handling .....	10
Care and storage.....	12
Battery handling.....	13
Main features.....	17
<b>1 PREPARATION.....</b>	<b>19</b>
Checking the contents.....	20
Names of parts .....	21
Attaching the strap.....	24
Loading the batteries .....	25
Using the AC adapter (optional) .....	27
Inserting SmartMedia .....	28
Adjusting the date and time.....	29
Learning the basics .....	31
Turning on the power.....	31
Checking the card.....	32
Checking the batteries.....	33
Checking the number of storable pictures .....	34
Holding the camera.....	35
Proper shutter release .....	36
Turning off the power.....	37
<b>2 TAKING PICTURES.....</b>	<b>39</b>
Taking pictures.....	40
Taking pictures using the optical viewfinder.....	40
Taking pictures using the LCD monitor .....	42
Quick view .....	44
Focus lock .....	45
Autofocus.....	46
Working range .....	48
Using the flash.....	49
Auto-flash .....	50
Red-Eye reducing flash .....	50

Off .....	51
Fill-In flash .....	51
Slow shutter synchronization flash .....	52
Red-Eye reducing flash + Slow shutter synchronization flash .....	52
Macro mode.....	53
Digital Tele mode .....	54
Selftimer .....	55
Record menu .....	56
Exposure compensation .....	57
Spot metering mode .....	58
Selecting the recording mode.....	59
White balance.....	61
ISO .....	62
Sequence mode .....	63
Panorama mode.....	65
Beep sound .....	67
File number.....	68
Setting reset .....	70

### **3** **DISPLAYING PICTURES ON THE LCD MONITOR .....**

Displaying recorded pictures .....	72
Index-display mode .....	74
Protection .....	75
One-frame erase .....	76
Connecting to a television .....	77
Display menu.....	78
Close-up display mode (3x inspection).....	79
Slide-show mode .....	80
File number display .....	81
Card setup.....	82
All-frame erase .....	82
Card format.....	84
LCD brightness.....	86

# CONTENTS (cont.)

<b>4</b>	<b>PRINTING PICTURES</b> .....	<b>87</b>
	Printing pictures.....	88
	Card print.....	89
	Card print menu.....	89
	Date-print (card).....	90
	Print-reserve (card).....	91
	Printing with the P-330N/P-330.....	93
<b>5</b>	<b>USING A PERSONAL COMPUTER</b> .....	<b>95</b>
	Computer system requirements.....	96
	Installing provided software.....	97
	Connecting to a personal computer.....	98
	Using a personal computer.....	99
	Transferring data from SmartMedia.....	100
	PC Card Adapter.....	100
	FlashPath Floppydisk Adapter.....	100
	Using CAMEDIA Master.....	101
	Processing images using CAMEDIA Master.....	103
<b>6</b>	<b>MISCELLANEOUS</b> .....	<b>109</b>
	Questions and answers.....	110
	Troubleshooting.....	112
	System chart.....	116
	Error codes.....	117
	Optional items.....	118
	Notes on display and backlight.....	118
	Compatibility of the picture data.....	119
	Specifications.....	120

# MAIN FEATURES

- The 1,310,000-pixel CCD delivers the highest picture quality in its class.
- Olympus high-recording mode lens equals those found on single lens reflex cameras.
- A removable SmartMedia (SSFDC) memory card (with Panorama function) is provided.
- With the provided Video output connector, pictures can be viewed on a TV. (P. 77)
- In addition to an optical viewfinder, a 1.8" (4.5 cm) LCD monitor is provided for more flexibility when composing shots and viewing images (can be enlarged 3 times). (P. 42)
- With the Digital Tele mode, the subject can be photographed (cropped to appear) twice as large.\* (P. 54)
- Direct printing available via an optional Olympus printer P-330N/P-330, allowing you to print out images whenever you need them in any quantity. (P. 93) Also, you can make prints at a lab. (P. 89)

\* Available only in the Standard Quality mode.



CAMERA

---

**1**

**PREPARATION**

---

**OLYMPUS DIGITAL CAMERA**

# CHECKING THE CONTENTS

Camera

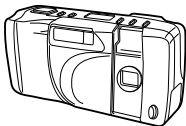

Strap

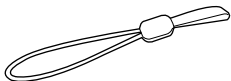

Video cable

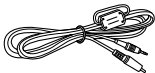

RS-232C PC serial cable

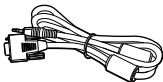

AA alkaline batteries  
(4 pieces)

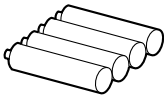

Software CD  
(containing software)



Instructions/Warranty card/  
Registration card



SmartMedia (SSFDC-8MB)

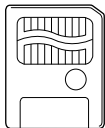

Static-free case

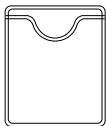

Instructions



Write-protect adhesive  
seals (4 pieces)



Index labels (2 pieces)



# NAMES OF PARTS

## CAMERA

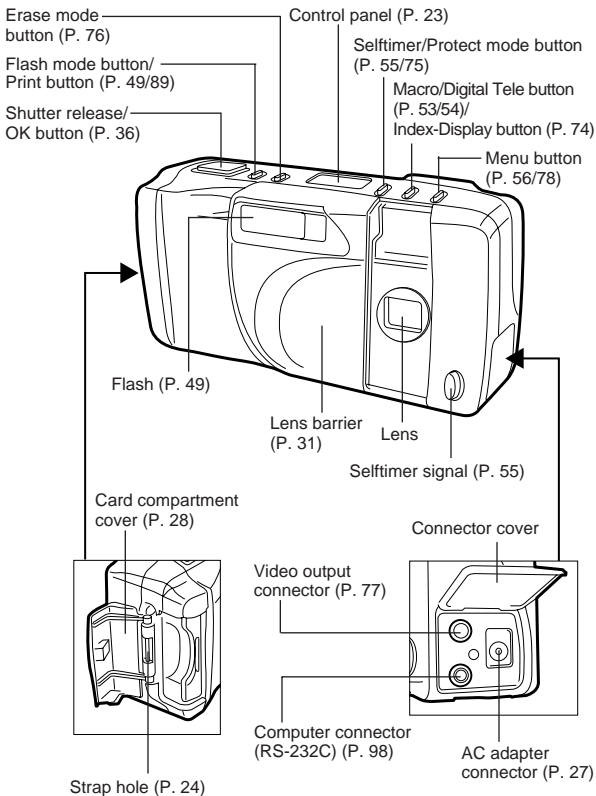

# NAMES OF PARTS (cont.)

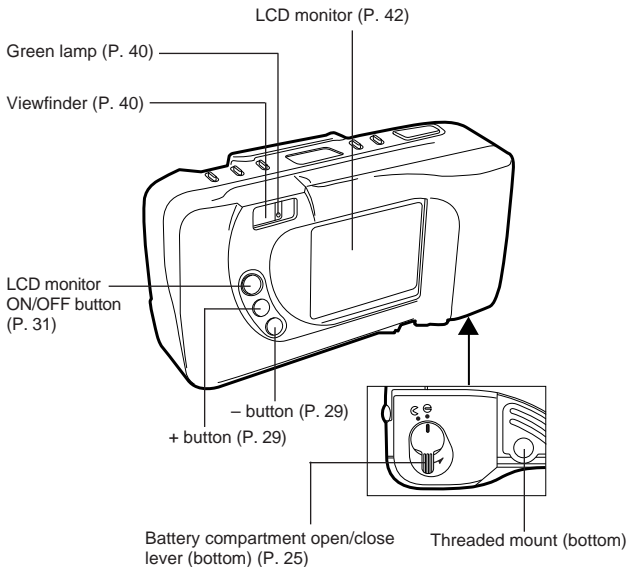

## VIEWFINDER DISPLAY

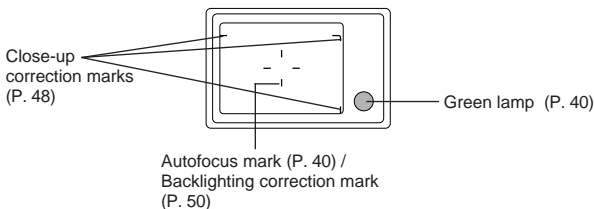

## CONTROL PANEL

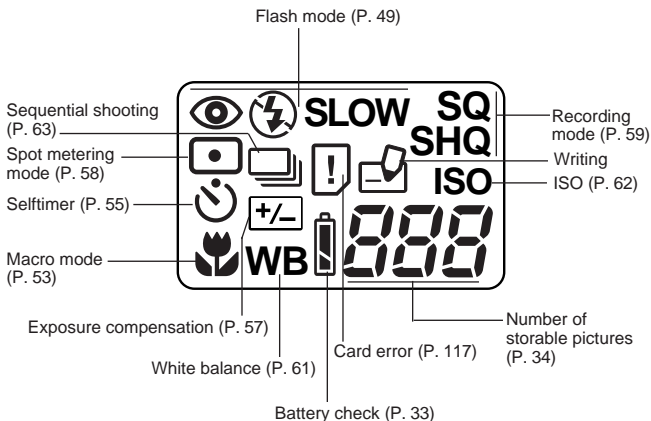

## LCD MONITOR

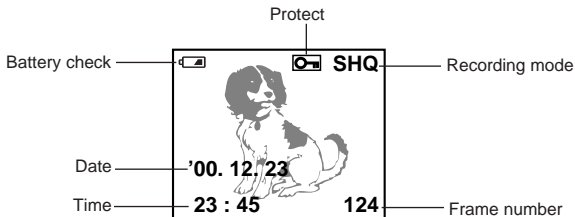

# ATTACHING THE STRAP

Attach the strap to the strap hole on the camera.

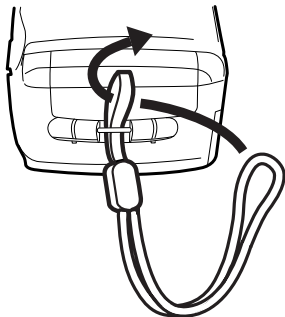

Caution:

- Attach the strap correctly as shown so that the camera does not fall off. If the strap is attached incorrectly and the camera comes loose and falls off, Olympus is not responsible for any damage.

# LOADING THE BATTERIES

This camera uses four AA nickel metal–hydride batteries, AA alkaline batteries, AA lithium batteries or AA NiCd batteries.

Performance will be limited with alkaline batteries, especially in low temperatures. NiMH batteries are recommended.

Do not use manganese batteries; they may overheat and destroy the camera.

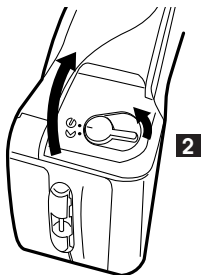

.....

**1** Make sure that the camera power is off.

**2** Set the battery compartment open/close lever to ☺ to open the cover.

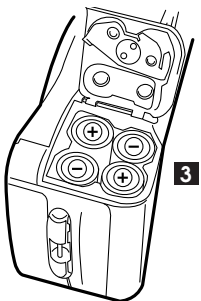

**3** Insert the new batteries correctly as shown and close the battery compartment cover tightly.

- Do not press the edge of the battery compartment cover.

# LOADING THE BATTERIES (cont.)

**Note:**

- Make sure that the power is off before loading the batteries.
- Do not touch the inside of the battery compartment.
- If the camera is left without batteries for approx. one hour, all the settings will reset to the default.
- Read "BATTERY HANDLING" on page 8/13.

 **These batteries cannot be used.**

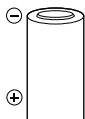

Batteries whose body is not covered by the insulating sheet at all.

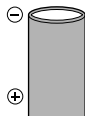

Batteries whose ⊖ terminal is flat and a part of the terminal is covered by the insulating sheet.

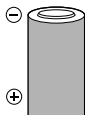

Batteries whose ⊖ terminal is raised but not covered by the insulating sheet.

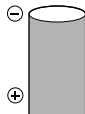

Batteries whose ⊖ terminal is flat and not covered by the insulating sheet.

## USING THE AC ADAPTER (Optional)

An optional Olympus AC adapter allows you to power your digital camera from a common AC wall outlet.

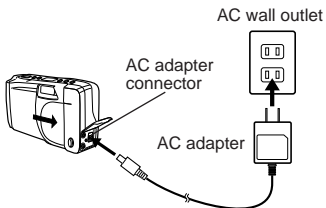

### Note:

- Olympus 3V adapter cannot be used.
- When in use for long periods, the AC adapter may get warm. This is normal.



### Warning:

Incorrect use may cause a fire or electric shock.

- Be sure to use an Olympus AC adapter. Olympus is not responsible for any damage caused by the use of other kinds of AC adapters.
- Use an AC 120V power source.
- NEVER connect or disconnect the AC adapter with wet hands.
- If the cord of the AC adapter is hot, smells like smoke or is emitting smoke, unplug it immediately and contact your nearest authorized Olympus service center.
- Make sure that the camera power is off before connecting or disconnecting the AC adapter.
- Make sure the AC adapter is properly plugged into the outlet.
- When disconnecting, hold the body, not the cord, of the AC adapter. Never pull, bend, twist or modify the cord.
- If there is any damage on the cord or if there is a contact failure, stop using it and contact your nearest authorized Olympus service center.
- Keep the AC adapter disconnected when the camera is not in use.

# INSERTING SmartMedia

Insert the SmartMedia card in the direction shown.

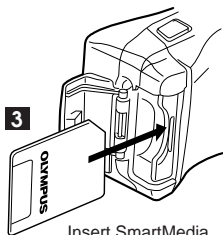

.....

**1** Make sure that the camera power is off.

**2** Open the Card compartment cover.

**3** Insert the SmartMedia card correctly as shown.

**4** Close the cover tightly.

## Note:

- Use **3V (3.3V) cards only**. 5V cards cannot be used.
- Olympus brand cards are recommended (already formatted). Non-Olympus brand cards must be formatted by the camera.
- When using a special function SmartMedia card (optional), insert it in the same way.



## Caution:

- **NEVER** open the card cover, eject the card, remove the batteries, or pull the plug while the camera is in operation. It may destroy the data in the card.
- The card is a precision instrument. Handle it carefully and do not subject it to physical shocks.
- Do not touch the contact area of the card.

# ADJUSTING THE DATE AND TIME

You can adjust the date and time.

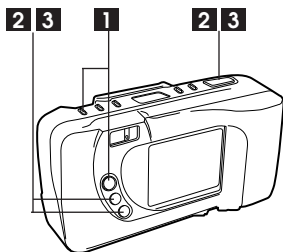

LCD monitor

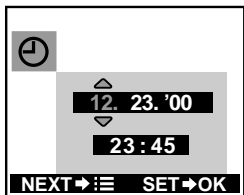
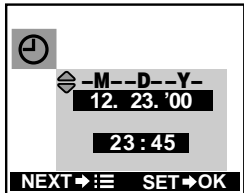

.....

- 1** Close the lens barrier, press the LCD monitor ON/OFF button, then press the Menu button several times to display the screen shown.

- 2** Select the date order using the +/- buttons, then press the OK button.

- 3** Press the +/- buttons to adjust the first setting, then press the OK button. Repeat until the last setting is adjusted, then press the OK button to save the setting.

- If the Menu button is pressed while the setting is being entered, it will be canceled and the next setting menu will appear.
- If the LCD monitor ON/OFF button is pressed while the setting is being entered, it will be canceled and the LCD monitor will be turned off.

# ADJUSTING THE DATE AND TIME (cont.)

- For accurate setting, press the OK button when the clock hits 00 seconds.



**Caution:**

- The adjusted date will be canceled when the camera is left without batteries for approx. one hour (based on our tests). In such a case, adjust the date again.

**Note:**

- We recommend that you check the date and time before taking important pictures.
- The setting will remain even after the power is turned off until it is readjusted.
- The clock will continue to operate correctly after the year 2000.

# LEARNING THE BASICS

## TURNING ON THE POWER

1

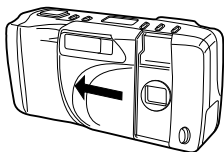

Control panel



2

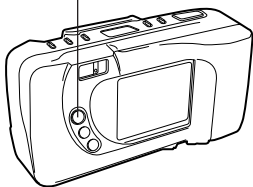

1

To turn on the camera in the Record mode (p. 39 ~ 70), slide open the lens barrier on the camera.

- The remaining battery power, number of storable pictures and selected recording mode will be displayed on the control panel.

2

To turn on the camera in the Display mode (p. 71 ~ 86), press the LCD monitor ON/OFF button with the lens barrier closed.

### Note:

- NEVER open the card cover, eject the card, remove the batteries, or pull the plug while the camera is in operation. It may destroy the data in the card.
- If you do not operate the camera for three minutes, the camera will be set to the stand-by mode. After four hours in the stand-by mode, the power turns off automatically. (Time varies depending on the type of batteries used.)

# LEARNING THE BASICS (cont.)

## CHECKING THE CARD

When the power is turned on in the Record mode, the camera checks the SmartMedia card.

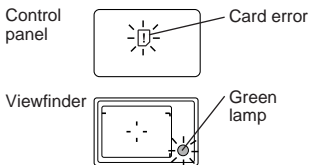

**When there is no SmartMedia card in the camera / the card is protected:**  
The Card error indicator on the control panel and the Green lamp blink.

Control panel



LCD monitor

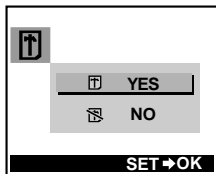

**When the card needs to be formatted:**  
The Card error indicator on the control panel lights, and the camera enters the Card format mode. (p. 84)

## CHECKING THE BATTERIES

When the power is turned on in the Record mode, the remaining battery power will be displayed on the control panel.



**lights and turns off automatically.**

Batteries are OK. You can shoot.



**blinks and other indicators on the control panel are displayed normally.**

Battery power is low and batteries should be replaced.



**blinks and other indicators on the control panel go out.**

Batteries are dead and should be replaced immediately.

### Note:

- When taking pictures on a special occasion, on a trip, or in cold temperatures, keep spare batteries handy.
- When the camera is being operated on batteries that are running low, the camera may emit several short beeps and blink the number of storable pictures on the control panel after you take a shot or when you turn on the power. If this happens, the picture you have just taken will not turn out properly. Replace the batteries and take the picture again.

# LEARNING THE BASICS (cont.)

## CHECKING THE NUMBER OF STORABLE PICTURES

When the power is turned on in the Record mode, the number of storable pictures will appear on the control panel.

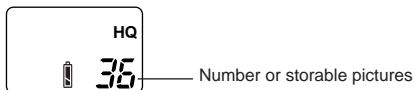

- The Green lamp blinks and CARD FULL appears on the LCD monitor when the number reaches 0. (p. 117)
- The number of storable pictures varies depending on the selected recording mode. See page 59 for selecting the recording mode.

### Approx. Number of Storable Pictures

Recording mode	SQ		HQ	SHQ	
	640x480			1600x1200	
Number of pixels	Normal	High	HQ	SHQ	SHQ-TIFF
Memory capacity					
2MB	30	8	9	4	0
4MB	50	16	18	9	1
8MB	122	32	36	18	2
16MB	244	65	73	36	4
32MB	489	130	146	73	8
64MB	978	260	292	148	16

#### Note:

- Because the amount of data used varies depending on the subject, more/fewer pictures than the number shown may be photographed.
- The number of storable pictures may not be reduced every time a picture is taken, or increased when a picture is erased.

## HOLDING THE CAMERA

Hold the camera firmly with both hands while keeping your elbows at your sides to prevent the camera from moving.

Proper



Proper



Improper

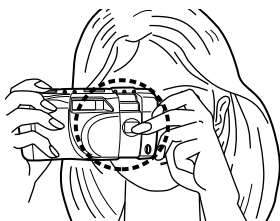

**Note:**

- Do not subject the lens to physical shocks.
- Keep your fingers and the strap away from the lens and flash.

# LEARNING THE BASICS (cont.)

## PROPER SHUTTER RELEASE

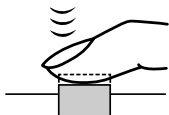
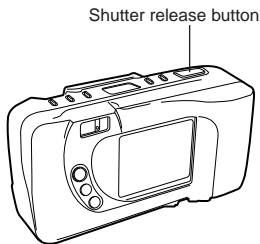

**Press the Shutter release button halfway to lock the focus and exposure.**

- The Green lamp next to the viewfinder lights.
- If the Green lamp blinks, the focus or exposure is not locked. Check the working distance. (p. 48)

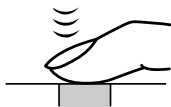

**Press the Shutter release button fully to release the shutter and take the picture.**

- The camera emits a beep sound when the shutter is released.
- The Green lamp blinks while the picture is being recorded.

**Note:**

- Press the Shutter release button gently using the ball of your finger.
- Avoid moving the camera when pressing the Shutter release button to prevent blurry pictures.

## TURNING OFF THE POWER

1

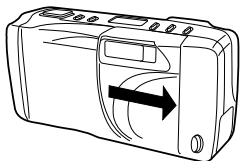

1

In the Record mode, slide the lens barrier closed.

- The displays on the control panel will go out.

2

In the Display mode, press the LCD monitor ON/OFF button to turn it off.

2

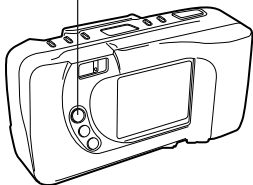

**Note:**

- The recorded images will remain in the card even after the power is turned off or the batteries are replaced.



CAMEDIA

---

# 2

**TAKING PICTURES**

OLYMPUS DIGITAL CAMERA

# TAKING PICTURES

## TAKING PICTURES USING THE OPTICAL VIEWFINDER

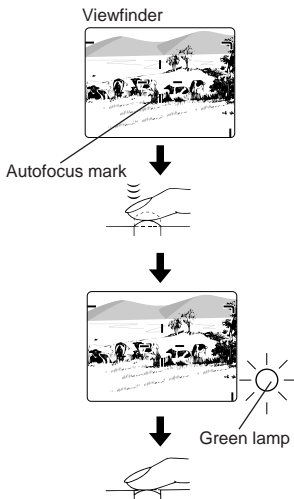
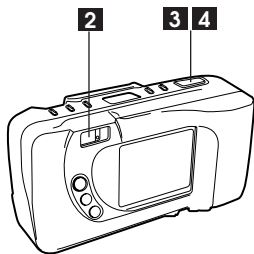

- 1 Slide open the lens barrier.
- 2 Compose the picture by placing the subject within the autofocus marks in the viewfinder or using the focus lock. (p. 45)
- 3 Press the Shutter release button halfway to lock the focus and exposure.
  - The Green lamp next to the viewfinder lights.
  - If the Green lamp blinks, the focus or exposure is not locked. Check the working distance. (p. 48)
- 4 Press the Shutter release button fully to take the picture.
- 5 When the Green lamp stops blinking (after about 2 ~ 40 seconds), the camera is ready to take the next picture.
  - The Shutter will not release while the Green lamp is blinking.



**Caution:**

- NEVER open the card cover, eject the card, remove the batteries, or pull the plug while the camera is in operation. It may destroy the data in the card.

**Note:**

- Printed images will be slightly larger compared with what you see in the viewfinder or on the LCD monitor.

# TAKING PICTURES (cont.)

## TAKING PICTURES USING THE LCD MONITOR

1

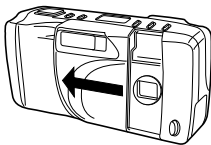

1

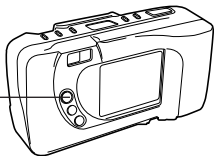

2

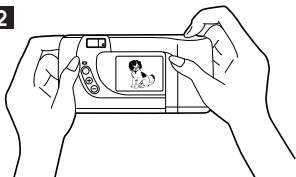

1 Open the lens barrier. Press the LCD monitor ON/OFF button to turn on the LCD monitor.

- Press the button again to turn off the monitor.

2 Aim the camera by looking at the subject through the LCD monitor.

- Take the picture in the same way as you would when using the optical viewfinder. (p. 40)

**Note:**

- Do not push the LCD monitor forcibly.
- Pictures that appear on the LCD monitor are for composition purposes only.
- It is recommended to use the optical viewfinder for less camera movement and battery consumption.
- It will take longer to record when the LCD monitor is used.
- When the subject is viewed diagonally in the camera, the edges may appear zigzagged on the LCD monitor. This is not a malfunction; it will be less noticeable in Display mode.
- A strip of light may appear on the top/bottom of the LCD monitor, but this is not a malfunction.
- When a picture is taken in a lighted area, such as in sunlight, vertical lines may appear on the LCD monitor. This is not a malfunction.
- Printed images will be slightly larger compared with what you see in the viewfinder or on the LCD monitor.

# TAKING PICTURES (cont.)

## QUICK VIEW

You can immediately shift from the Record mode to the Display mode, and check the picture you have just taken.

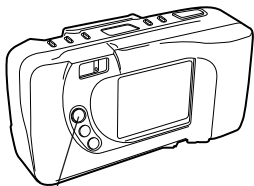

**1 2**

**1** When the lens barrier is open, quickly press the LCD monitor ON/OFF button twice.

- The LCD monitor will display the last picture taken. (p. 72)

**2** To return to the Record mode, press the LCD monitor ON/OFF button or press the Shutter release button halfway.

# FOCUS LOCK

If your main subject is not within the autofocus marks, follow the procedure below to obtain focus. This is called focus lock.

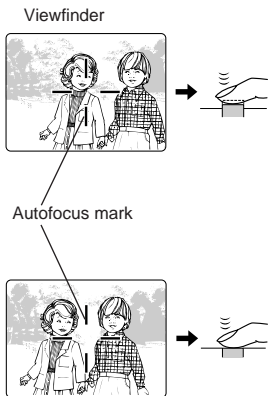

- .....
- 1** Position your subject within the autofocus marks, and press the Shutter release button halfway.

- The Green lamp next to the viewfinder lights.

- 2** Recompose the picture while keeping the Shutter release button pressed halfway.

- 3** Press the Shutter release button fully to take the picture.

**Note:**

- If the Green lamp blinks, the focus or exposure is not locked. Check the working distance. (p. 48)

## AUTOFOCUS

There are certain conditions where the autofocus may not work properly even when the Green lamp blinks when the Shutter release button is pressed halfway. When this happens, try the procedure below.

### ① Subjects with low contrast

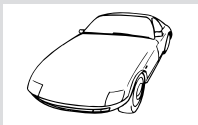

Lock the focus on an object that is at the same distance from the camera as the subject, then aim at the subject to take the picture. (p. 45)

### ② Subjects with no vertical lines

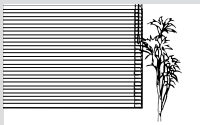

Lock the focus on the subject by holding the camera vertically, then change it to the horizontal position to take the picture. (p. 45)

### 3 Subjects in excessively bright light



Lock the focus on an object that is at the same distance from the camera as the subject, then aim at the subject to take the picture. (p. 45)

### 4 Subjects at different distances

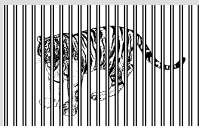

Lock the focus on an object that is at the same distance from the camera as the subject, then aim at the subject to take the picture. (p. 45)

### 5 Fast-moving subjects at close distances

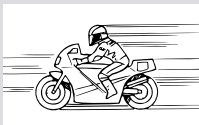

Lock the focus on an object that is at the same distance from the camera as the subject, then aim at the subject to take the picture. (p. 45)

# WORKING RANGE

## Close-up Correction

The viewfinder's picture frame shows the area that can be shot for subjects at  $\infty$ . However, the picture area will move lower in the viewfinder as you get closer to the subject. At 8" (0.2 m), the shaded area is the actual available image area. In this case, the subject should be positioned below the close-up correction marks.

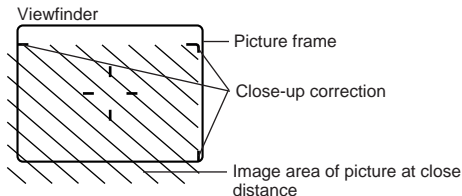

## Take pictures at a distance between 4" ~ $\infty$ (0.1 m ~ $\infty$ ).

- Subjects closer than 4" (0.1 m) may turn out to be out of focus and incorrectly exposed.
- Using the LCD monitor as a viewfinder makes it easy to take close-up pictures (turns on automatically in the Macro mode).
- Power consumption increases when the LCD monitor is used.

## Working range

Macro mode (p.53)	4" ~ 20" (0.1 m ~ 0.5 m)
Standard mode	20" ~ $\infty$ (0.5 m ~ $\infty$ )

# USING THE FLASH

Select the flash mode according to the shooting conditions.

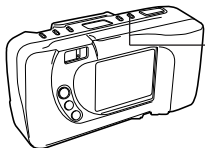

Flash mode button

Control panel

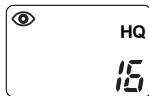

You can select the following flash modes with each press of the Flash mode button.

Flash mode	Use
Auto-Flash (p. 50) ↓	Automatically fires in low-light and backlight conditions.
Red-Eye Reducing Flash (p. 50) ↓	Significantly reduces the phenomenon of "red-eye" (subject's eyes appearing red).
Flash Off (p. 51) ↓	Never fires.
Fill-In Flash (p. 51) ↓	Fires regardless of available light.
Slow Shutter Synchronization Flash (p. 52) ↓	For taking photographs of night views.
Red-Eye Reducing Flash + Slow Shutter Synchronization Flash (p. 52) ↓	For taking photographs of people at night.

**Flash working range:** Approx. 8"~9.8 ft

**Note:**

- The flash is being charged while the Green lamp is blinking. Wait until the Green lamp goes off to take the picture.
- When using the flash in the Macro mode, the flash may not have the proper effect. Confirm the result using the LCD monitor.
- The flash cannot be used in the Sequence mode or in the Panorama mode. (p. 63/65)
- The setting will remain if HOLD is selected in Setting Reset. (p. 70)

# USING THE FLASH (cont.)

## AUTO-FLASH

In the Auto-Flash mode, the flash will fire automatically in low-light and backlight conditions.

Viewfinder



Backlighting correction mark

When you take a picture that is backlit, position the subject within the backlighting correction marks to fire the flash.

## RED-EYE REDUCING FLASH



This mode significantly reduces the phenomenon of "red-eye".



Control panel

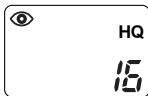

### Note:

- The camera emits pre-flashes before the regular flash.
- It takes about a second before the Shutter is released.
- Performance may be limited when the subject is not looking at the pre-flashes from right in front of the camera, or due to medication/alcohol intake or individual characteristics.

## OFF (FLASH OVERRIDE)



In the Off mode, the flash does not fire even in low-light conditions. Use this mode in situations where flash photography is not desired or is prohibited, or in twilight/night scenes.



Control panel

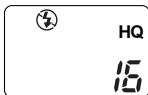

### Note:

- Since a slow shutter speed is automatically selected in low-light situations when in the Off mode, the use of a tripod is recommended to prevent blurred pictures caused by camera movement.

## FILL-IN FLASH (FORCED ACTIVATION)



In the Fill-In Flash mode, the flash fires regardless of available light. For example, this mode can be used to brighten up the subject's shaded face. Another use of this mode is to correct the color shift produced by artificial lights (eg. fluorescent light).



Control panel

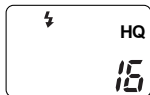

### Note:

- Use this mode within the flash working range. (p. 49)
- It may not have the desired effect under excessively bright light.

# USING THE FLASH (cont.)

## SLOW SHUTTER SYNCHRONIZATION FLASH

⚡ SLOW

The flash will fire automatically during the first half of a slow shutter speed's release duration. It is especially great for taking photographs of night views.

Control panel

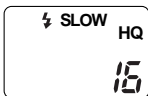

**Note:**

- Since the shutter speed is slow, the use of a tripod is recommended to prevent blurred pictures. Moving subjects will appear blurry when photographed.

## RED-EYE REDUCING FLASH + SLOW SHUTTER SYNCHRONIZATION FLASH

👁️ ⚡ SLOW

The flash will fire automatically during the first half of a slow shutter speed's release duration. It is especially great for taking photographs of people at night.

Control panel

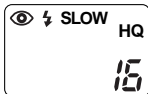

**Note:**

- Since the shutter speed is slow, the use of a tripod is recommended to prevent blurred pictures. Moving subjects will appear blurry when photographed.

# MACRO MODE

You can get as close as 4" to your subject. An approx. 3" x 4.7" subject can be photographed fully within the frame.

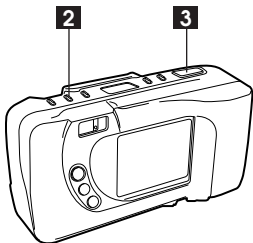

LCD monitor

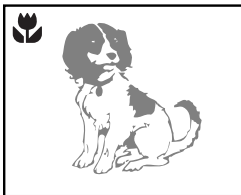

Control panel



.....

**1** Open the lens barrier.

**2** Press the Macro/Digital Tele button to turn on the LCD monitor in the Macro mode.

-  appears on the control panel.

**3** Take a picture.

Shooting Range: Approx. 4" ~ 20"

**Note:**

- When using the flash in the Macro mode, the flash may not have the proper effect. Confirm the result using the LCD monitor. Do not use the flash when the subject is closer than 8".
- Using the LCD monitor as a viewfinder makes it easy to take close-up pictures.
- The Macro mode will be canceled when the power is turned off.

# DIGITAL TELE MODE

The subject can be photographed (cropped to appear) twice as large.

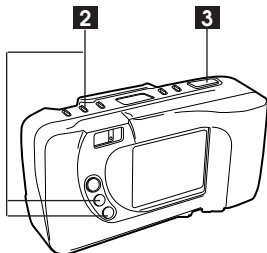

LCD monitor

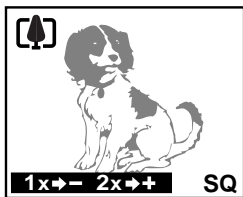

.....  
**1** Open the lens barrier.

**2** Press the Macro/Digital Tele button twice to turn on the LCD monitor in the Digital Tele mode.

- Press the + button for 2X magnification.
- Press the – button to return to 1X.

**3** Take a picture.

**Note:**

- This mode can only be used in the SQ mode (automatically set).
- The Digital Tele mode will be canceled when the LCD monitor is turned off.

# SELFTIMER

Use a tripod to hold the camera securely.

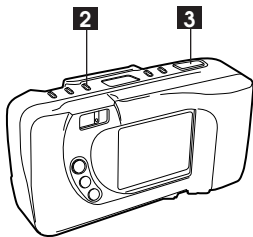

Control panel

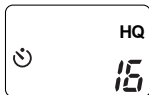

- 1** Open the lens barrier.
- 2** Press the Selftimer button.
  -  appears on the control panel.
- 3** Aim at your subject, and press the Shutter release button.
  - The shutter will be released about 12 seconds after the Shutter release button is pressed. (The Selftimer signal lights for 10 sec. and blinks for 2 sec.)

**Note:**

- The Selftimer is disengaged when the shutter is released.
- To cancel the Selftimer after it has been activated, press the Selftimer button again.

# RECORD MENU

You can select the following modes with each press of the Menu button in the Record mode (lens barrier open).

Mode	Use
→ Standard mode ↓	For taking standard pictures.
Exposure compensation ↓	For setting +/-2 compensation. (p. 57)
Spot metering mode ↓	For obtaining the right exposure. (p. 58)
Recording mode selection ↓	For selecting the recording mode. (p. 59)
White balance ↓	For presetting the white balance. (p. 61)
ISO ↓	For setting the sensitivity. (p. 62)
Drive ↓	For using the Sequence mode. (p. 63)
Card function ↓	For taking panorama pictures or using optional special function cards. (p. 65)
Beep sound ↓	For setting on/off. (p. 67)
File number ↓	For selecting the file numbering system. (p. 68)
Setting reset ↩	For keeping changed settings even after the power is turned off. (p. 70)

# EXPOSURE COMPENSATION

In addition to automatic exposure, you can also adjust it manually by +/- 2 (approx. 0.5 steps). Adjust + when the subject is mostly bright. Adjust - when the subject is mostly dark.

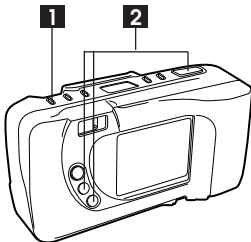

LCD monitor

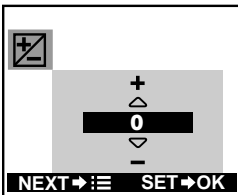

.....

**1** Open the lens barrier and press the Menu button to display the screen shown.

**2** Make an adjustment using the +/- buttons, then press the OK button to save the setting.

- If the Menu button is pressed while the setting is being entered, it will be canceled and the next setting menu will appear.
-  appears on the control panel.

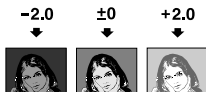

## Note:

- The setting will remain if HOLD is selected in Setting Reset, but will be canceled when the batteries are taken out. (p. 70)
- Although the brightness of the LCD monitor can be changed with the exposure compensation, it may not appear to change when the subject is mostly dark. In such a case, display the recorded picture on the LCD monitor to check its brightness.
- The exposure compensation may not work properly when shooting with the flash.

# SPOT METERING MODE

The Spot metering mode is used to obtain the right exposure regardless of the backlight. Place the subject in the center of the autofocus marks.

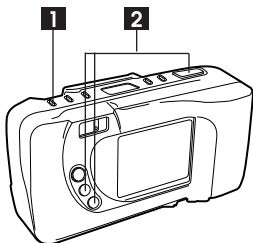

LCD monitor

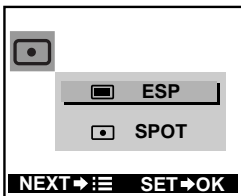

Control panel

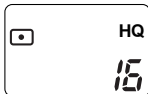

.....

**1** Open the lens barrier and press the Menu button several times to display the screen shown.

**2** Select SPOT using the +/- buttons, then press the OK button to save the setting.

- appears on the control panel.
- If the Menu button is pressed while the setting is being entered, it will be canceled and the next setting menu will appear.

**3** Take a picture.

**Note:**

- The setting will remain if HOLD is selected in Setting Reset, but will be canceled when the batteries are taken out. (p. 70)

# SELECTING THE RECORDING MODE

There are 5 recording modes.

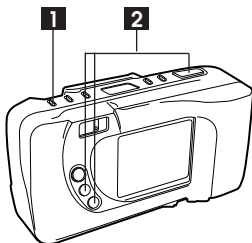

LCD monitor

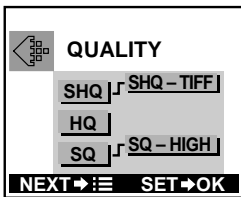

Control panel

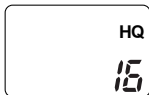

**1** Open the lens barrier and press the Menu button several times to display the screen shown.

**2** Select the recording mode using the +/- buttons, then press the OK button to save the setting.

- If the Menu button is pressed while the setting is being entered, it will be canceled and the next setting menu will appear.
- To select SHQ-TIFF or SQ-HIGH, press the + button for a couple of seconds at SHQ or SQ, respectively.
- The selected recording mode appears on the control panel. (With SHQ-TIFF or SQ-HIGH, SHQ or SQ blinks.)

## SELECTING THE RECORDING MODE (cont.)

Mode	Resolution	Compression
SQ	640 x 480	Standard
HQ	1280 x 960	Standard
SHQ	1280 x 960	Minimal (JPEG) No (TIFF – larger file size)

**Note:**

- The number of storable pictures varies according to the recording mode. TIFF requires more room in the card than other modes. (p. 34)
- While HQ and SHQ images have the same number of pixels, SHQ uses lower compression allowing for better image quality when enlarged. It may take a little longer to record or display images in the SHQ mode.
- The setting will remain even after the power is turned off until it is readjusted.

# WHITE BALANCE

You can match the white balance to the light source by selecting Auto, ☀ (Daylight), ☁ (Overcast), ⚡ (Tungsten light) or ⚡ (Fluorescent light).

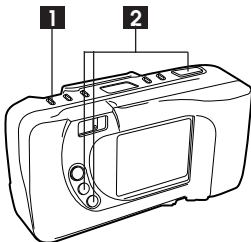

LCD monitor

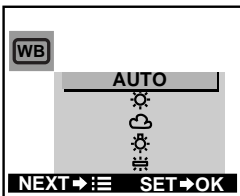

Control panel

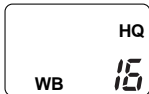

**1** Open the lens barrier and press the Menu button several times to display the screen shown.

**2** Select the white balance using the +/- buttons, then press the OK button to save the setting.

- If the Menu button is pressed while the setting is being entered, it will be canceled and the next setting menu will appear.
- WB appears on the control panel when a setting other than AUTO is selected.

**Note:**

- Select AUTO in normal situations.
- The Preset white balance may not work under special lighting.
- The setting will remain if HOLD is selected in Setting Reset, but will be canceled when the batteries are taken out. (p. 70)
- Confirm results in the Display mode.