

SONY®



Table of
contents

Operation
Search

MENU/Settings
Search

Index

Cyber-shot

Cyber-shot Handbook

DSC-TX7/TX7C

How to use this handbook

Click on a button at upper right to jump to the corresponding page.
This is convenient when searching for a function you want to view.



← Search for information by function.

← Search for information by operation.

← Search for information in a listing of MENU/Settings items.

← Search for information by keyword.

Table of contents

Operation Search

MENU/Settings Search

Index

Marks and notations used in this handbook

Red Eye Reduction

The flash strobos two or more times before shooting to reduce the red-eye phenomenon when using the flash.

1 MENU → (Settings) → (Shooting Settings) → [Red Eye Reduction] → desired mode

<input checked="" type="checkbox"/>	Auto	When the Face Detection function is activated, the flash strobos
<input type="checkbox"/>	On	The flash always strobos to reduce the red-eye phenomenon.
<input type="checkbox"/>	Off	Does not use Red Eye Reduction.

Notes

- To avoid blurring of images, hold the camera firmly until the shutter is released. It usually takes a second until the shutter is released, and also be sure not to allow the subject to move during this period.
- Red Eye Reduction may not produce the desired effects. It depends on individual differences and conditions, such as distance to the subject, or if the subject looked away from the pre-strobe.
- If you do not use the Face Detection function, Red Eye Reduction does not work, even when you select [Auto].
- [Red Eye Reduction] is set to [Off] in the following situations:
 - In Anti Motion Blur mode
 - In Hand-held Twilight mode
 - When Scene Selection is set to (High Sensitivity) mode
 - When the Smile Shutter function is activated

What causes the red-eye phenomenon?

Pupils become dilated in dark environments. Flash light is reflected off the blood vessels at the back of the eye (retina), causing the "red-eye" phenomenon.

Other ways to reduce red-eye

- Select (High Sensitivity) mode in Scene Selection. (The flash is automatically turned to [Off].)
- When the eyes of the subject turn out red, correct the image with [Retouch] → [Red Eye Correction] on the viewing menu or with the supplied software "PMB".

In this handbook, the sequence of operations is shown by arrows (→). You should touch the items on the screen in the order indicated. Marks are shown as they appear in the camera's default setting.

← The default setting is indicated by ✓.

← Indicates cautions and limitations relevant to the correct operation of the camera.

💡 Indicates information that is useful to know.

Notes on using the camera

Notes on the types of memory cards that you can use (sold separately)

The following memory cards are compatible with this camera: “Memory Stick PRO Duo” media, “Memory Stick PRO-HG Duo” media, “Memory Stick Duo” media, SD memory card, SDHC memory card and SDXC memory card.

MultiMediaCard cannot be used.

In this manual, the term “Memory Stick Duo” media is used to refer to “Memory Stick PRO Duo” media, “Memory Stick PRO-HG Duo” media and “Memory Stick Duo” media, and the term “SD card” is used to refer to SD memory card, SDHC memory card and SDXC memory card.

- “Memory Stick Duo” media with a capacity up to 32 GB, and SD card up to 64 GB, have been confirmed to operate properly with the camera.
- When recording movies, it is recommended that you use the following memory cards:
 - MEMORY STICK PRO DUO (Mark2) (“Memory Stick PRO Duo” (Mark2) media)
 - MEMORY STICK PRO-HG DUO (“Memory Stick PRO-HG Duo” media)
 - SD memory card, SDHC memory card or SDXC memory card (Class 4 or faster)
- For details on “Memory Stick Duo” media, see page 158.

When using a “Memory Stick Duo” media with standard sized “Memory Stick” media slot

You can use the “Memory Stick Duo” media by inserting it into the “Memory Stick Duo” media Adaptor (sold separately).



“Memory Stick Duo”
media Adaptor

Functions built into this camera

- This manual describes each of the functions of TransferJet-compatible/incompatible devices, 1080 60i-compatible devices and 1080 50i-compatible devices.

To check if your camera supports the TransferJet function, and whether it is a 1080 60i-compatible device or 1080 50i-compatible device, check for the following marks on the bottom of the camera.

TransferJet-compatible device:  (TransferJet)

1080 60i-compatible device: 60i

1080 50i-compatible device: 50i

- DSC-TX7C digital still camera is not compatible with the TransferJet function.

Notes on the battery pack

- Charge the battery pack (supplied) before using the camera for the first time.
- You can charge the battery pack even if it is not completely discharged. In addition, even if the battery pack is not fully charged, you can use the partially charged capacity of the battery pack as is.
- If you do not intend to use the battery pack for a long time, use up the existing charge and remove it from the camera, then store it in a cool, dry place. This is to maintain the battery pack functions.
- For details on the usable battery pack, see page 160.

Carl Zeiss lens

The camera is equipped with a Carl Zeiss lens which is capable of reproducing sharp images with excellent contrast. The lens for the camera has been produced under a quality assurance system certified by Carl Zeiss in accordance with the quality standards of Carl Zeiss in Germany.

Notes on the LCD screen and lens

- The LCD screen is manufactured using extremely high-precision technology so over 99.99% of the pixels are operational for effective use. However, some tiny black and/or bright dots (white, red, blue or green) may appear on the LCD screen. These dots are a normal result of the manufacturing process and do not affect the recording.

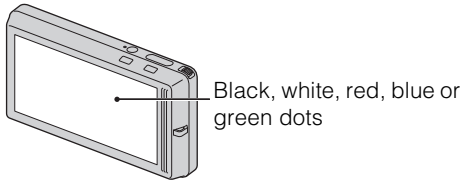

- If water droplets or other liquids splash on the LCD screen and make it wet, immediately wipe off the screen with a soft cloth. Leaving liquids on the LCD screen surface can harm the quality and cause a malfunction.
- Exposing the LCD screen or the lens to direct sunlight for long periods may cause malfunctions. Be careful when placing the camera near a window or outdoors.
- Do not press against the LCD screen. The screen may be discolored and that may cause a malfunction.
- Images may trail across on the LCD screen in a cold location. This is not a malfunction.
- Be careful not to bump the lens, and be careful not to apply force to it.

On moisture condensation

- If the camera is brought directly from a cold to a warm location, moisture may condense inside or outside the camera. This moisture condensation may cause a malfunction of the camera.
- If moisture condensation occurs, turn off the camera and wait about an hour for the moisture to evaporate. Note that if you attempt to shoot with moisture remaining inside the lens, you will be unable to record clear images.

The images used in this Handbook

The images used as examples in this Handbook are reproduced images, and are not actual images shot using this camera.

Note when playing movies on other devices

This camera uses MPEG-4 AVC/H.264 High Profile for AVCHD format recording.

Movies recorded in AVCHD format with this camera cannot be played by the following devices.

- Other devices compatible with AVCHD format that do not support High Profile
- Devices incompatible with the AVCHD format

This camera also uses MPEG-4 AVC/H.264 Main Profile for MP4 format recording.

For this reason, movies recorded in MP4 format with this camera cannot be played on devices other than those that support MPEG-4 AVC/H.264.

Table of contents

Notes on using the camera

How to use this handbook	2
Notes on using the camera	3
Operation Search	8
MENU/Settings Search	11
Names of parts	16
List of icons displayed on the screen	18
Using the touch panel	20
Customizing the MENU items	22
Using the Still/Movie mode button	23
Using the internal memory	24

Shooting

REC Mode	25
Intelligent Auto Adjustment	26
Program Auto	27
Intelligent Sweep Panorama	28
Movie Mode	30
Anti Motion Blur	31
Hand-held Twilight	32
Backlight Correction HDR	33
Scene Selection	34
Zoom	36

Viewing

Viewing still images	37
Playback Zoom	38
Wide Zoom	39
Temporarily Rotated Display	40
Viewing movies	41

MENU (Shooting)

MENU items (Shooting)	11
-----------------------------	----

MENU (Viewing)

MENU items (Viewing)	13
----------------------------	----

Settings

Setting items	14
---------------------	----

TV

Viewing an image on a Standard Definition (SD) TV	125
Viewing an image on a High Definition (HD) TV	126

Computer

Using with your computer	130
Using the software	131
Connecting the camera to a computer	133
Uploading images to a media service	135
Creating a disc of movies	137

Printing

Printing still images	140
-----------------------------	-----

Troubleshooting

Troubleshooting	143
Warning indicators and messages	152

Others

Using the camera abroad	157
“Memory Stick Duo” media	158
Battery pack	160
Battery charger	161
Intelligent Pantiler	162
AVCHD format	163
TransferJet standard	164

Index

Index	165
-------------	-----

Operation Search

Table of contents

Operation Search

MENU/Settings Search

Index

Leaving the settings to the camera	Intelligent Auto Adjustment.....	26
	Scene Selection.....	34
	Scene Recognition.....	65
Shooting movies	Movie Mode.....	30
	Movie button	43
	Movie format	93
Shooting portraits	Soft Snap	34
	Twilight Portrait	34
	Smile Shutter	45
	Scene Recognition.....	65
	Face Detection.....	67
	Anti Blink.....	69
Red Eye Reduction.....	99	
Shooting panoramic images	Intelligent Sweep Panorama	28
Shooting best shots of your pet	Pet.....	34
Shooting close to objects	Macro	56
	Close Focus	56
Shooting moving objects	Hi-Speed Shutter.....	35
	Movie Mode.....	30
	Burst.....	55

Shooting without blur	High Sensitivity.....	34
	Hi-Speed Shutter.....	35
	Anti Motion Blur.....	31
	Hand-held Twilight	32
	2-second delay self-timer.....	49
	ISO.....	58
Shooting with backlight	Forced Flash.....	47
	Scene Recognition.....	65
	Backlight Correction HDR.....	33
Shooting in dark places	High Sensitivity.....	34
	Anti Motion Blur.....	31
	Slow Synchro.....	47
	ISO.....	58
Adjusting exposure	EV	57
Changing focus position	Using the touch panel	20
	Focus	62
	Face Detection.....	67
Changing image size/quality	Image Size/Quality.....	52
Deleting images	Delete.....	77
	Format	117
Displaying enlarged images	Playback Zoom	38
	Trimming (Resize).....	82
Displaying full-screen images	Wide Zoom	39
	Temporarily Rotated Display.....	40
	Image Size/Quality.....	52

Editing images	Retouch	82
	Paint	81
Playing back a series of images in order	Slideshow	74
Using with easy-to-see indicators	Easy Mode.....	42, 71
Printing images with the date	“PMB (Picture Motion Browser)”	131
Changing date and time settings	Area Setting	123
	Date & Time Setting.....	124
Initializing settings	Initialize.....	105
Printing images	Print	140
Viewing on TVs	Viewing an image on a Standard Definition (SD) TV.....	125
	Viewing an image on a High Definition (HD) TV	126
Creating AVCHD format movie disc	Creating a disc of movies.....	137
Information about optional accessories	Intelligent Pantilter.....	162

MENU/Settings Search

MENU items (Shooting)

You can easily select the various shooting functions from **MENU**.



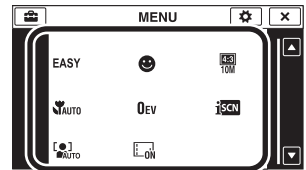







- 1 Lower the lens cover to switch to shooting mode.
- 2 Touch **MENU** to display the MENU screen.
The four menu items displayed below **MENU** do not appear in the MENU screen.
- 3 Touch the menu item → desired mode.



In the table below, ✓ indicates settings that can be changed, while – indicates settings that cannot be changed. A setting may be fixed or restricted depending on the shooting mode. For details, see the page for each item.

The icons below **SCN** indicate the available modes.

Still/Movie mode button	📷							🎞️		
	REC Mode	📷	P	📷	👤	🌙	📷+	SCN	🎞️ AUTO	📹
Easy Mode	✓	✓	✓	✓	✓	✓	✓	✓	–	–
Movie button	✓	✓	✓	✓	✓	✓	✓	✓	✓	✓
Movie shooting scene	–	–	–	–	–	–	–	–	✓	✓
Smile Shutter	✓	✓	–	–	–	–		–	–	
Flash	✓	✓	–	–	–	✓		–	–	
Self-Timer	✓	✓	–	✓	✓	✓	✓	✓	✓	
Shooting Direction	–	–	✓	–	–	–	–	–	–	
Image Size/Quality	✓	✓	✓	✓	✓	✓	✓	✓	✓	
Burst	✓	✓	–	–	–	–		–	–	
Macro	✓	✓	–	–	–	✓		–	–	
EV	✓	✓	✓	✓	✓	–	✓	✓	✓	
ISO	–	✓	–	–	–	–		–	–	
White Balance	–	✓	✓	✓	✓	✓		✓	–	
Underwater White Balance	–	–	–	–	–	–		–	✓	
Focus	–	✓	✓	–	–	✓	–	–	–	

Still/Movie mode button									
	REC Mode		P					SCN	
Metering Mode	—	✓	✓	✓	✓	—	—	✓	✓
Scene Recognition	✓	—	—	—	—	—	—	—	—
Face Detection	✓	✓	—	✓	✓	✓		—	—
Anti Blink	—	—	—	—	—	—		—	—
Display Settings	✓	✓	✓	✓	✓	✓	✓	✓	✓

Notes

- [Quality] is displayed only when [Movie format] is set to [AVCHD].
- Only the items that are available for each mode are displayed on the screen.
- The four menu items displayed below **MENU** differ according to each mode.

MENU items (Viewing)

You can easily select the various viewing functions from **MENU**.

1 Press the  (Playback) button to switch to playback mode.







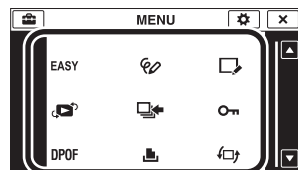













2 Touch **MENU** to display the MENU screen.

The four menu items displayed below **MENU** do not appear in the MENU screen.

3 Touch the menu item → desired mode.



In the table below, ✓ indicates settings that can be changed, while – indicates settings that cannot be changed.

View Mode Menu items	Memory card				Internal Memory
	 Date View	 Folder view (Still)	 Folder view (MP4)	 AVCHD view	Folder View
EASY (Easy Mode)	✓	✓	✓	✓	✓
 (Calendar)	✓	—	—	—	—
 (Image Index)	✓	✓	✓	✓	✓
 (Slideshow)	✓	✓	✓	✓	✓
 (Delete)	✓	✓	✓	✓	✓
 (Send by TransferJet)	✓	✓	—	—	—
 (Paint)	✓	✓	—	—	✓
 (Retouch)	✓	✓	—	—	✓
 (View Mode)	✓	✓	✓	✓	—
 (Display Burst Group)	✓	—	—	—	—
 (Protect)	✓	✓	✓	✓	✓
DPOF	✓	✓	—	—	—
 (Print)	✓	✓	—	—	✓
 (Rotate)	✓	✓	—	—	✓
 (Volume Settings)	✓	—	✓	✓	✓
 (Display Settings)	✓	✓	✓	✓	✓
 (Exposure data)	✓	✓	✓	✓	✓
 (Image index settings)	✓	✓	✓	✓	✓
 (Select Folder)	—	✓	✓	—	—

Notes

- Only the items that are available for each mode are displayed on the screen.
- The four menu items displayed below **MENU** differ according to each mode.

Setting items



You can change the settings on the  (Settings) screen.



1 Touch **MENU** to display the MENU screen.

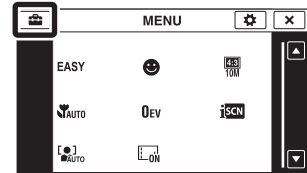

2 Touch  (Settings) → desired category → desired item → desired setting.



Categories	Items
 Shooting Settings	Movie format
	AF Illuminator
	Grid Line
	Digital Zoom
	Auto Orientation
	Scene Recog. Guide
	Red Eye Reduction
	Blink Alert
 Main Settings	Beep
	LCD Brightness
	Language Setting
	Demo Mode
	Initialize
	HDMI Resolution
	CTRL FOR HDMI
	COMPONENT
	Housing
	USB Connect
	LUN Settings
	Download Music
	Format Music
	Power Save
	TransferJet
	Calibration

Categories	Items
 Memory Card Tool	Format
	Create REC.Folder
	Change REC.Folder
	Delete REC.Folder
	Copy
	File Number
 Internal Memory Tool	Format
	File Number
 Clock Settings	Area Setting
	Date & Time Setting

Notes

- [Shooting Settings] appears only when settings have been entered from shooting mode.
- [Memory Card Tool] appears only when a memory card is inserted in the camera, while [Internal Memory Tool] appears only when a memory card is not inserted.

Names of parts

Camera

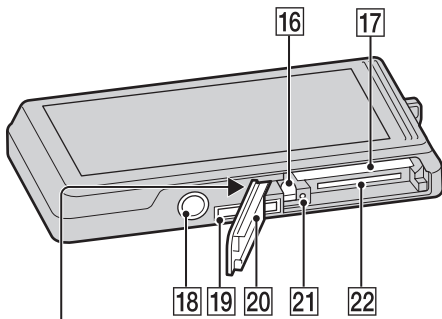
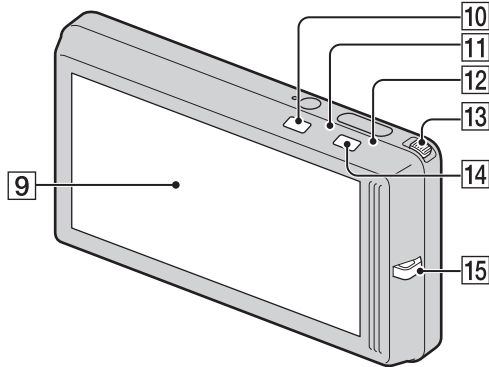
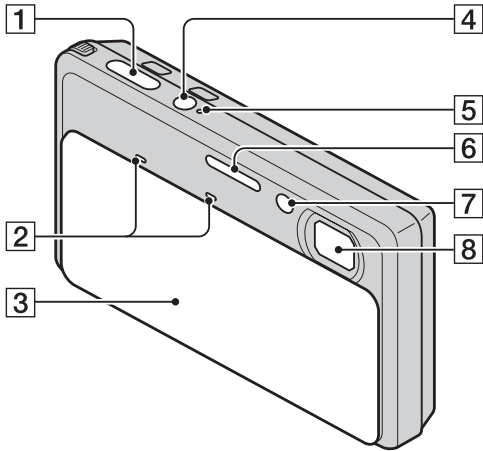

Cover panel

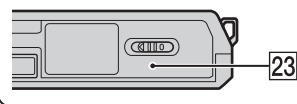

- 1 Shutter button
- 2 Microphone
- 3 Lens cover
- 4 ON/OFF (Power) button
- 5 ON/OFF (Power) lamp
- 6 Flash
- 7 Self-timer lamp/Smile Shutter lamp/AF illuminator
- 8 Lens
- 9 LCD screen/Touch panel
- 10 (Playback) button (37)
- 11 (Still) mode lamp
- 12 (Movie) mode lamp
- 13 Zoom (W/T) lever (36, 38)
- 14 (Still)/(Movie) mode button
- 15 Hook for wrist strap*
- 16 Battery eject lever
- 17 Battery insertion slot
- 18 Tripod receptacle
- 19 Multi-connector
- 20 Battery/Memory card cover
- 21 Access lamp
- 22 Memory card slot
- 23 (TransferJet™) mark (79, 115)

* Using the wrist strap

The wrist strap is already attached to the camera at the factory. Place your hand through the loop to prevent the camera from damage by being dropped.

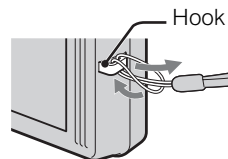

* Using the paint pen

The paint pen is used when operating the touch panel. It attaches to the wrist strap. Do not carry the camera by holding the paint pen. The camera may fall off.

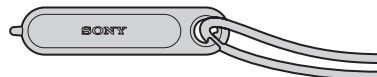

Multi-output stand

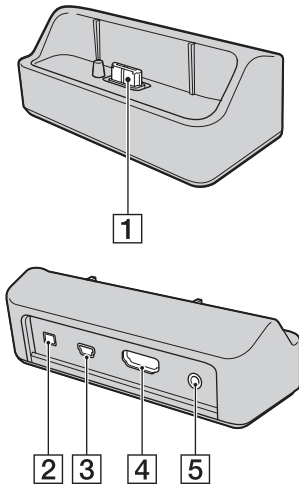

Use the multi-output stand for attaching the camera in the following cases.

- Connecting a USB Cable to a computer
- Connecting an AV or HDMI Cable to a TV
- PictBridge connection to a printer

- 1** Camera connector terminal
- 2** DC IN jack
- 3** USB jack
- 4** HDMI jack
- 5** A/V OUT (STEREO) jack

Using AC Adaptor AC-LS5 (sold separately)

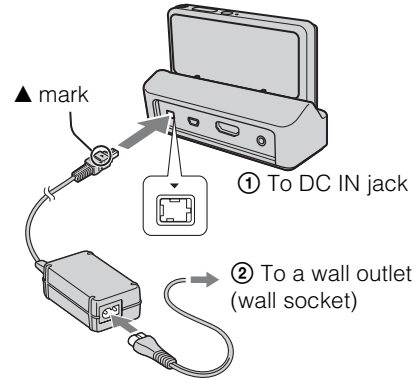

- Connecting the camera to AC Adaptor AC-LS5 (sold separately) will not charge the battery. Use a battery charger for charging the battery.

List of icons displayed on the screen

Icons are displayed on the screen to indicate the camera status. The displayed icon positions may differ according to the shooting mode.

When shooting still images

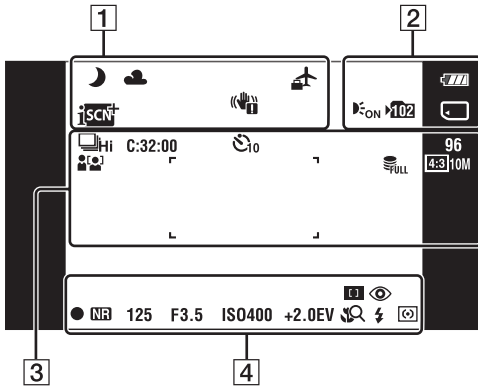

When shooting movies

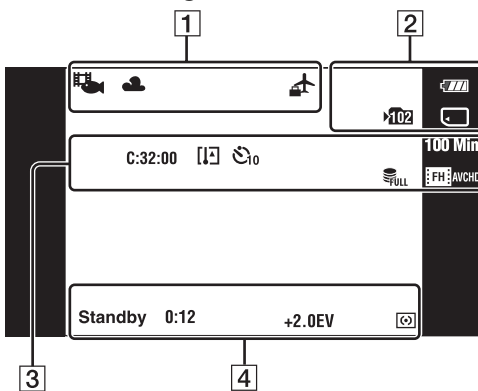

When playing back

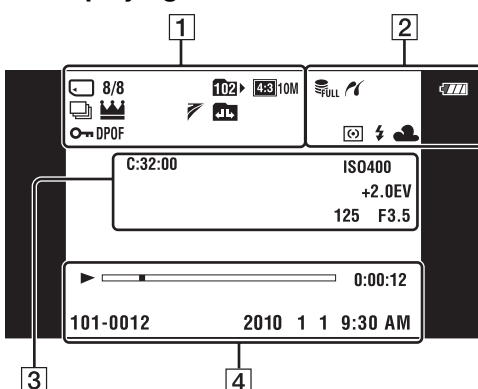

1

Display	Indication
	Scene Recognition icon
	White balance
	Destination
	Scene Recognition
	Vibration warning
	Movie shooting scene
	Playback zoom
	Recording/Playback Media (Memory card, internal memory)
	Image number/Number of images recorded in selected date/folder
	Recording folder
	Playback folder
	Image size/Quality
	Burst shooting images
	Main image in the burst group
	TransferJet settings
	Changing folder
	Protect
	Print order (DPOF) mark

2

Display	Indication
	Battery remaining
	Low battery warning
	AF illuminator
	Recording folder
	Recording/Playback Media (Memory card, internal memory)
	Zoom scaling
	Database file full/Database file error warning
	PictBridge connecting
	Metering mode
	Flash
	White balance

3

Display	Indication
	Burst mode
C:32:00	Self-diagnosis display
	Temperature increase warning
	Self-timer
96	Number of recordable images
100 Min	Recordable time
	Face Detection
	Database file full/Database file error warning
	Image size/Quality
	AF range finder frame
+	Spot metering cross-hairs
ISO400	ISO number
+2.0EV	Exposure Value

Display	Indication
125	Shutter speed
F3.5	Aperture value

4

Display	Indication
	Focus
	Red-eye reduction
	AE/AF lock
NR	NR slow shutter
125	Shutter speed
F3.5	Aperture value
ISO400	ISO number
+2.0EV	Exposure Value
	Close focus
	Flash mode
	Flash charging
	Metering mode
REC Standby	Recording a movie/Standby a movie
0:12	Recording time (m:s)
	Playback
	Playback bar
	Azimuth direction
	GPS information
35° 37' 32" N 139° 44' 31" E	Latitude and Longitude display
0:00:12	Counter
101-0012	Folder-file number
2010 1 1 9:30 AM	Recorded date/time of the playback image

Table of contents

Operation Search

MENU/Settings Search

Index

Using the touch panel

The camera allows you to perform operations and make settings by touching the buttons or dragging the LCD screen with your finger.

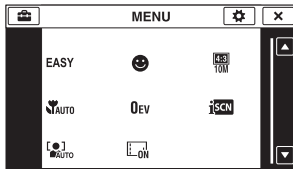

	Displays the hidden items so that the items you want to set are shown on the screen.
	Returns to the previous screen.
	Describes the shooting functions when the shooting menu, shooting mode or Scene Selection mode is displayed. Touch → the items whose description you want to view.

Notes

- To operate the touch panel, press it lightly with your finger or the supplied paint pen. Pressing hard or using a pointed object other than the supplied paint pen could damage the touch panel.
- If you touch the top right of the screen during shooting, the buttons and icons will momentarily disappear. The buttons and icons will reappear when you take your finger off the screen.

Operating by dragging the LCD screen

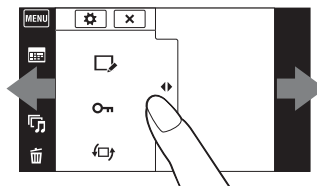
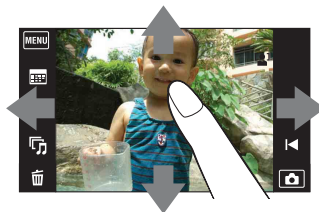

Displays/hides the MENU screen

	Action	Operation method
During shooting/ playback	Displays the MENU screen	Touch the left side of the LCD screen and drag right
	Hides the MENU screen	Touch the right side of the LCD screen and drag left
	Hides the operation buttons	Touch the left side of the LCD screen and drag left
	Displays the operation buttons	Touch the left side of the LCD screen and drag right
During playback	Displays the next/previous image	Drag right or left
	Continuously changes the image (next/previous image)	Drag right or left, and continue pressing
	Displays the image index screen during playback	Drag up
	Displays the next/previous page in index mode	Drag down or up
	Displays the calendar during playback in Date View mode	Drag down





Touching the screen to set the focus

Touching the subject on the touch panel displays a frame, and then pressing the shutter button halfway down brings the frame into focus. If there is a face in the frame, in addition to the focus, the brightness and hue are also automatically optimized.



Button/Operation method	Action
Touch the subject	Adjusts the focus.
	Cancels the function.

Note

- In the following situations, you cannot bring the frame into focus by touching the screen:
 - In Intelligent Sweep Panorama mode
 - In Movie Mode
 - In Easy Mode
 - When the Smile Shutter function is activated
 - When  (Landscape),  (Twilight),  (Gourmet),  (Fireworks) or  (Underwater) is selected in the Scene Selection
 - When [Self-Timer] is set to [Self-portrait One Person] or [Self-portrait Two People]
 - When you use [Digital Zoom]

Customizing the MENU items

During shooting/playback, the four MENU items appear below **MENU** on the LCD screen. You can customize these four buttons to the desired MENU items and layout, letting you conveniently locate frequently used buttons.

These buttons can be customized and the settings saved for each recording mode during shooting, and for internal memory and the memory card during playback.

1 Touch **MENU** to display the MENU screen.



2  (Customize) → [OK]

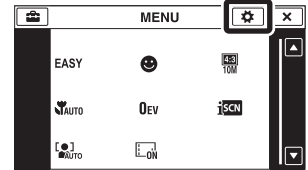

3 Select a MENU icon and drag it to the desired position on the left side of the LCD screen.

The MENU icon in the customization area is replaced.

4 To cancel, touch .

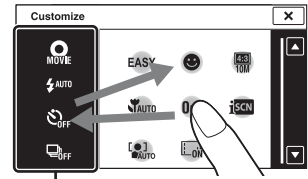

Customization area

Note

- You cannot customize the MENU icon in Easy Mode.

Taking advantage of customization

Not only can you swap MENU icons, but you can also swap MENU icons inside the customization area and reduce the number of MENU icons.

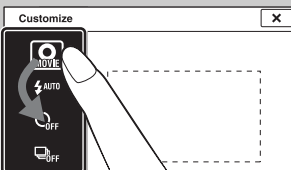

Swapping MENU icons inside the customization area

While touching a MENU icon inside the customization area, move it to the desired location.

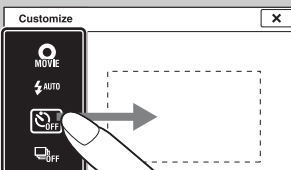

Reducing the number of icons in the customization area

While touching a MENU icon inside the customization area, move it to the area on the right.

Using the Still/Movie mode button

You can select the shooting mode according to the mode you want to shoot in.

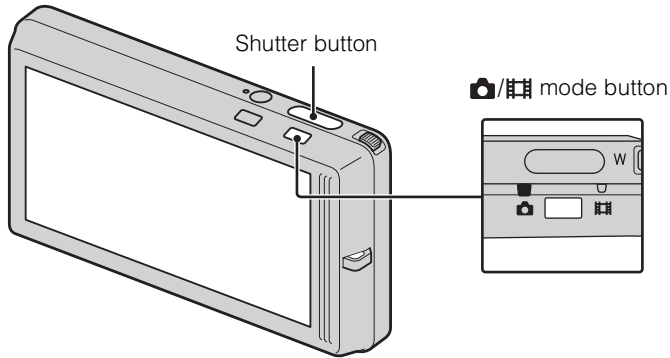

- 1 Press / mode button to switch (Still) or (Movie) shooting mode.

(Still)	Allows you to shoot still images. Switches to the still image recording mode set using (REC Mode) (page 25).
(Movie)	Allows you to record movies. Switches to the movie shooting scene set using MENU → [Movie shooting scene] (page 44).

Using the internal memory

The camera has approximately 45 MB of internal memory. This memory is not removable. Even when there is no memory card inserted in the camera, you can record images using this internal memory.

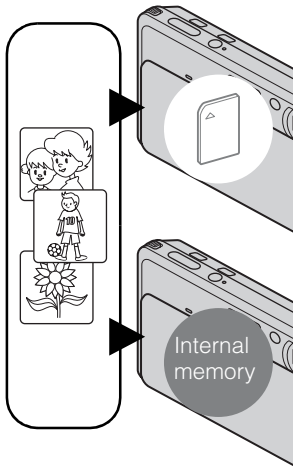

When a memory card is inserted

[Recording]: Images are recorded on the memory card.

[Playback]: Images on the memory card are played back.

[Menu, Settings, etc.]: Various functions can be performed on images on the memory card.

When there is no memory card inserted

[Recording]: Images are recorded using the internal memory.

[Playback]: Images stored in the internal memory are played back.

[Menu, Settings, etc.]: Various functions can be performed on images in the internal memory.

On image data stored in the internal memory

We recommend that you copy (back up) data without error using one of the following methods.

To copy (back up) data on a hard disk of your computer

Perform the procedure on page 133 without a memory card inserted in the camera.

To copy (back up) data on a memory card

Prepare a memory card with sufficient free capacity, then perform the procedure explained in [Copy] (page 121).

Notes







- You cannot import image data on a memory card to the internal memory.
- By making a USB connection between the camera and a computer with a cable, you can import data stored in the internal memory to a computer. However you cannot export data on a computer to the internal memory.

REC Mode

You can select the shooting mode based on condition and objective.



- 1 Lower the lens cover to switch to shooting mode.
- 2 Touch  (REC Mode) → desired mode.



 (Intelligent Auto Adjustment)	Allows you to shoot still images with the setting adjusted automatically.
P (Program Auto)	Allows you to shoot with the exposure adjusted automatically (both the shutter speed and the aperture value). Also you can select various settings using the menu.
 (iSweep Panorama)	Allows you to shoot a panoramic image after composing images.
 (Movie Mode)	Allows you to record movies.
 (Anti Motion Blur)	Allows you to shoot with reduced blur without using the flash when composing burst shots taken in high-speed.
 (Hand-held Twilight)	Allows you to shoot with reduced blur in low light scenes without tripod when composing burst shots taken in high-speed.
 (Backlight Correction HDR)	Allows you to shoot a greater range of gradation by superimposing two images having different exposures.
SCN (Scene Selection)	Allows you to shoot with preset settings according to the scene.

Intelligent Auto Adjustment

Allows you to shoot still images with the setting adjusted automatically.

- 1 Lower the lens cover to switch to shooting mode.
- 2  (REC Mode) →  (Intelligent Auto Adjustment)
- 3 Press the shutter button fully down.









Note

- Flash mode is set to [Auto] or [Off].

On Scene Recognition

Scene Recognition operates in Intelligent Auto Adjustment mode. This function lets the camera automatically recognize the shooting conditions and shoot the image.



- The camera recognizes  (Twilight),  (Twilight Portrait),  (Twilight using a tripod),  (Backlight),  (Backlight Portrait),  (Landscape),  (Macro), (Close Focus) or (Portrait), and displays the corresponding icon and guide on the screen when the scene is recognized.

For details, see page 65.

If you shoot a still image of a subject that is difficult to focus on

- The shortest shooting distance is approximately 8 cm (3 1/4 inches) (1 cm (13/32 inches) in Intelligent Auto Adjustment or Easy Mode) (W), 50 cm (1 ft 7 3/4 inches) (T) (from the lens). Shoot in the Close focus mode when you shoot a subject closer than the shooting distance.
- When the camera cannot focus on the subject automatically, the AE/AF lock indicator changes to flash slowly and the beep does not sound. Either recompose the shot or change the focus setting (page 62).
- Focusing may be difficult in the following situations:
 - It is dark and the subject is distant.
 - The contrast between the subject and the background is poor.
 - The subject is seen through glass.
 - The subject is moving quickly.
 - There is reflective light or shiny surfaces.
 - The subject is backlit or there is a flashing light.

Program Auto

Allows you to shoot with the exposure adjusted automatically (both the shutter speed and the aperture value). Also you can select various settings using the menu.

- 1 Lower the lens cover to switch to shooting mode.
- 2 **i** (REC Mode) → **P** (Program Auto)
- 3 Press the shutter button fully down.



Table of contents

Operation Search

MENU/Settings Search

Index

Intelligent Sweep Panorama

Allows you to create a panoramic image from composed images. The camera also automatically detects people's faces or moving subjects.



1 Lower the lens cover to switch to shooting mode.

2  (REC Mode) →  (iSweep Panorama)

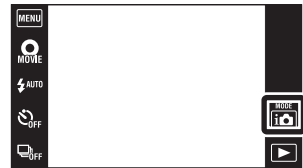

3 Align the camera with the end of the subject to be shot and press the shutter button fully down.

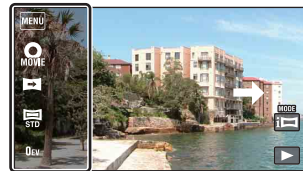

This part will not be taken

4 Pan the camera to the end of the guide, following the indication on the LCD screen.

Guidance bar



Notes

- If you cannot pan the camera across the entire subject within the given time, a gray area occurs in the composed image. If this happens, move the camera faster to record a full panoramic image.
- Since several images are stitched together, the stitched part will not be recorded smoothly.
- Under low light conditions, panoramic images may be blurred or the shooting may not be successful.
- Under lights that flicker such as fluorescent light, the brightness or color of the combined image is not always the same.
- When the whole angle of panoramic shooting and the AE/AF locked angle are very different in brightness, color and focus, the shooting will not be successful. If this happens, change AE/AF locked angle and shoot again.
- Intelligent Sweep Panorama is not suitable for the following situations:
 - Objects are too close to the camera
 - Image with little contrast such as sky, sandy beach, or lawn
 - Image with constant change such as waves or waterfalls
- You cannot create panoramic images in the following situations:
 - You pan the camera too fast or too slow
 - There is too much camera shake

💡 Changing the shooting direction or image size of a panoramic image

Shooting Direction:  (Shooting Direction) → [Right], [Left], [Up] or [Down]

Image Size:  (Image Size) → [Standard] or [Wide]

💡 Tips for shooting a panoramic image

Pan the camera in an arc at a constant velocity in the direction indicated on the LCD screen. Subjects at rest are more suited for panorama shots than moving subjects.

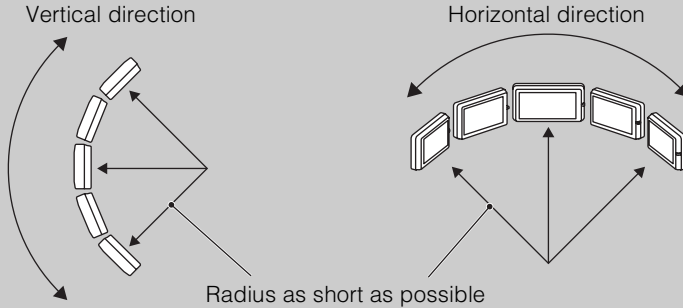





- Determine the scene and press the shutter button halfway, so that you can lock the exposure and white balance.
- Adjust the frame composition so that a portion with greatly varied scenery is in the center of the image.

💡 Scrolling the panoramic images for display

Scroll panoramic images by touching  while panoramic images are being displayed. Touch the LCD screen during playback to display the operation buttons.





Shows the displayed area of the whole panoramic image

Operation button/ Operation method	Action
Touch  or the LCD screen	Plays scrolling images/pauses
Touch  /  /  /  or drag up/down/right/left	Scrolls images

- Panoramic images can also be played back using the supplied software “PMB” (page 131).
- Panoramic images recorded using another camera may not scroll correctly when played.

Movie Mode

Allows you to record movies.

- 1 Lower the lens cover to switch to shooting mode.
- 2  (REC Mode) →  (Movie Mode)
- 3 Press the shutter button fully down.
You can also record movies by touching .
- 4 To stop shooting, press the shutter button fully down again.



Changing the Movie Format, Image Quality or Image Size



Movie format:  →  (Settings) →  (Shooting Settings) → [Movie format] → [AVCHD] or [MP4]

Quality (AVCHD):  (Quality) → [AVC HD 17M FH] or [AVC HD 9M HQ]

Image Size (MP4):  (Image Size) → [MP4 12M], [MP4 6M] or [MP4 3M]

Anti Motion Blur

This is suitable for indoor shots without using the flash to reduce the subject blur.

- 1 Lower the lens cover to switch to shooting mode.
- 2  (REC Mode) →  (Anti Motion Blur)
- 3 Press the shutter button fully down.

A burst of shots are taken, and image processing is applied to reduce subject blur and noise.





Notes

- The shutter beeps 6 times, however just one image is recorded.
- Noise is not effectively reduced in the following situations:
 - Image with large-scale movement
 - Image with a main subject too close to the camera
 - Image with little contrast such as sky, sandy beach, or lawn
 - Image with constant change such as waves or water falls
- Smile Shutter cannot be used.
- When using a light source that flickers, such as fluorescent lighting, block noise may occur. In such cases, set Scene Selection to  (High Sensitivity).

Hand-held Twilight

Although night scenes tend to blur by camera shake, this mode allows you to shoot night scenes with less noise without using a tripod.

- 1 Lower the lens cover to switch to shooting mode.
- 2  (REC Mode) →  (Hand-held Twilight)
- 3 Press the shutter button fully down.

A burst of shots are taken, and image processing is applied to reduce subject blur and noise.





Notes

- The shutter beeps 6 times, however just one image is recorded.
- Noise is not effectively reduced in the following situations:
 - Image with large-scale movement
 - Image with a main subject too close to the camera
 - Image with little contrast such as sky, sandy beach, or lawn
 - Image with constant change such as waves or water falls
- Smile Shutter cannot be used.
- When using a light source that flickers, such as fluorescent lighting, block noise may occur. In these cases, set Scene Selection to  (High Sensitivity).

Backlight Correction HDR

You can shoot two images having different exposures to create a single image with a greater range of gradation by combining the dark parts of an image taken with a bright exposure setting and the bright parts of an image taken with a dark exposure setting.

- 1 Lower the lens cover to switch to shooting mode.
- 2  (REC Mode) → + (Backlight Correction HDR)
- 3 Press the shutter button fully down.

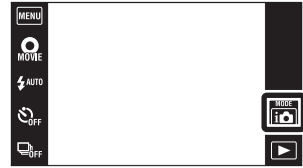

Notes



- Although the shutter sound beeps twice, only one image is recorded.
- [Backlight Correction HDR] may not produce the effects in the following situations:
 - When using the flash
 - Image with large-scale movement
 - There is too much camera shake
 - Image whose surrounding light condition is extremely bright or dark
 - Image with constant change such as waves or waterfalls
- Smile Shutter function is not available in [Backlight Correction HDR].







Scene Selection

Allows you to shoot with preset settings according to the scene.



- 1 Lower the lens cover to switch to shooting mode.
- 2  (REC Mode) → **SCN** (Scene Selection) → desired mode



 (High Sensitivity)	Allows you to shoot images without a flash under low light conditions, reducing blur.	
 (Soft Snap)	Allows you to shoot images with a softer atmosphere for portraits and flowers, etc.	
 (Landscape)	Allows easy shooting of distant scenes by focusing in the distance. Shoots the clear sky and trees and flowers in vivid colors.	
 (Twilight Portrait)	Allows you to shoot sharp images of people with the night view in the background without compromising the atmosphere.	
 (Twilight)	Allows you to shoot night scenes at far distance without losing the dark atmosphere of the surroundings.	
 (Gourmet)	Selects Macro mode, allowing you to shoot food arrangements in delicious and bright colors.	
 (Pet)	Allows you to shoot images of your pet with the best settings.	
 (Beach)	Allows you to shoot the blue of the water clearly when shooting seaside or lakeside scenes.	
 (Snow)	Allows you to record clear images preventing sunken colors in snowy scenes or other places where the whole screen appears white.	

 (Fireworks)	Allows you to record fireworks in all their splendor.	
 (Underwater)	Allows you to shoot underwater in natural colors in housing (such as Marine Pack).	
 (Hi-Speed Shutter)	Allows you to capture fast moving subjects outdoors or in other bright places. <ul style="list-style-type: none"> The shutter speed becomes faster, so images shot in dark places become darker. 	











































Note

- When you shoot images using  (Twilight Portrait),  (Twilight) or  (Fireworks) mode, the shutter speed is slower and the images tend to blur. To prevent blurring, the use of a tripod is recommended.

Functions you can use in Scene Selection

For shooting an image appropriately according to the scene condition, a combination of functions is determined by the camera. ✓ indicates settings that can be changed, while – indicates settings that cannot be changed.

The icons indicated under “Flash” and “Self-Timer” indicate modes that are available. Some functions are not available, depending on the Scene Selection mode.

	Close Focus	Flash	Face Detection/ Smile Shutter	Self-Timer	Burst	White Balance	Anti Blink
 ISO	—		✓	✓	—	✓* ¹	—
 Portrait	—	✓	✓* ²	✓	✓	—	✓
 Landscape	—	 	—	 	✓	—	—
 Portrait	—	 SL	✓	✓	—	—	—
 Twilight	—		—	 	—	—	—
 Dining	✓	 	—	 	—	✓	—
 Cat	✓	 	—	 	—	✓	—
 Beach	—	 	✓	✓	✓	—	—
 Baby	—	 	✓	✓	✓	—	—
 Fireworks	—		—	 	—	—	—
 Underwater	✓	 	—	 	✓	✓* ³	—
 Hi-Speed Shutter	—	 	✓	✓	✓	—	—

*¹ [Flash] for [White Balance] cannot be selected.

*² [When touched] for [Face Detection] cannot be selected.

*³ You can use [Underwater White Balance] instead of [White Balance].

Zoom

You can enlarge the image when shooting. The camera's optical zoom function can enlarge images up to 4x.

- 1 Lower the lens cover to switch to shooting mode.
- 2 Move the zoom (W/T) lever.

Move the zoom (W/T) lever to the T side to zoom in and move to the W side to zoom out.

- When the zoom scale exceeds 4x, see page 96.

T side





W side



Notes

- The camera zooms slowly while shooting a movie.
- Zoom is locked to the W side when shooting in Intelligent Sweep Panorama mode.

Viewing still images

- 1 Press the  (Playback) button to switch to playback mode.
- 2 Select an image with .



Tips for dragging operations

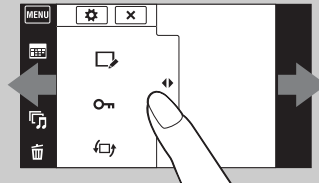
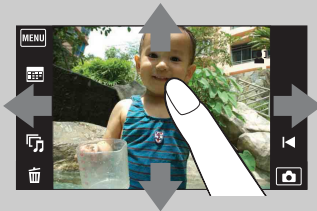

Displays/hides the MENU screen

Action	Operation method
Displays the MENU screen	Touch the left side of the LCD screen and drag right
Hides the MENU screen	Touch the right side of the LCD screen and drag left
Hides the operation buttons	Touch the left side of the LCD screen and drag left
Displays the operation buttons	Touch the left side of the LCD screen and drag right
Displays the next/previous image	Drag right or left
Continuously changes the image (next/previous image)	Drag right or left, and continue pressing
Displays the image index screen during playback	Drag up
Displays the next/previous page in index mode	Drag down or up
Displays the calendar during playback in Date View mode	Drag down

Viewing images taken with a different camera

This camera creates an Image Database File on the memory card for recording and playing images. If the camera detects images not registered in the Image Database File on the memory card, a registration screen with the message “Files found which were not recognized Import files” will be displayed. To view unregistered images, register them by selecting [OK].

- Use a sufficiently charged battery to register images. If a battery with a low charge is used to register unregistered images, it may not be possible to transfer data or data may be corrupted if the battery charge runs out.

Playback Zoom

Plays back the enlarged image.

1 Press the  (Playback) button to switch to playback mode.

2 Touch the area you want to enlarge.



The image is enlarged to twice the previous size, with the area you touched at the center. You can also enlarge the image by moving the zoom (W/T) lever to the T side.

3 Adjust the zoom scale and position.

The image is further enlarged each time you touch the screen.



Shows the displayed area of the whole image

Button/Operation method	Action
Drag up/down/right/left	Changes the zoom position.
	Changes the zoom scale.
	Cancels playback zoom.



To save enlarged images

You can save an enlarged image by using the Trimming function (**MENU** → [Retouch] → [Trimming (Resize)]).

Wide Zoom

In single-image mode, still images at a 4:3 aspect ratio are played over the entire LCD screen. In this case, the top and bottom of the image will be slightly cropped.



- 1 Press the  (Playback) button to switch to playback mode.
- 2 Touch  (Wide Zoom).
- 3 To cancel Wide Zoom, touch  (Wide Zoom) again.





Note

- Wide Zoom is not available for the following image files:
 - Movies
 - Panoramic images
 - Images displayed in a burst group
 - 16:9 images

Temporarily Rotated Display

This is used in the single-image mode to temporarily rotate an image and enlarge it on the screen.





- 1 Press the  (Playback) button to switch to playback mode.
- 2 Select the vertical orientation image → touch  (Temporarily Rotated Display).
- 3 To cancel the display, touch  (Temporarily Rotated Display) again.



Notes







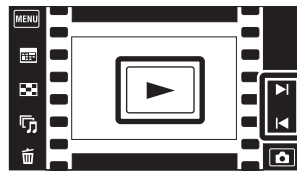

- Temporarily Rotated Display is not available for the following images:
 - Movies
 - Panoramic images
 - Horizontal orientation images
- Touching  cancels Temporarily Rotated Display.

Viewing movies

- 1 Press the  (Playback) button to switch to playback mode.
- 2 Select a movie with .
- 3 Touch  on the LCD screen.

When you touch the LCD screen during playback, operation buttons are displayed.



Button/Operation method	Action
	Volume control Adjusts the volume with  /  .
	Jumps to the start of the movie
	Fast rewind
Touch  or the LCD screen	Normal playback/Pause
	Slow playback
	Fast forward

Note

- You may not be able to play back some images shot using other cameras.

Easy Mode

Allows you to shoot still images using the minimum necessary functions. The text size increases and indicators become easier to see.

- 1 Lower the lens cover to switch to shooting mode.
- 2 Set the mode button to (Still).
- 3 **MENU** → **EASY** (Easy Mode) → [OK]

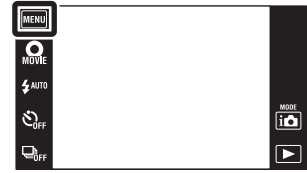

Notes

- The battery power may decrease faster because the screen brightness increases automatically.
- The playback mode also changes to [Easy Mode].

Functions available in Easy Mode (Shooting)



Smile Shutter: Touch (Smile).

Image Size: **MENU** → [Image Size] → Select [Large] or [Small]

Flash: **MENU** → [Flash] → Select [Auto] or [Off]

Self-Timer: **MENU** → [Self-Timer] → Select [Off] or [On]

Exit Easy Mode: **MENU** → [Exit Easy Mode] → [OK]

On Scene Recognition

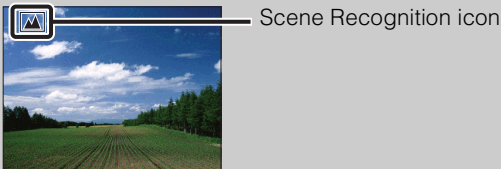

Scene Recognition operates in Easy Mode. This function lets the camera automatically recognize the shooting conditions and shoot the image.



- The camera recognizes (Twilight), (Twilight Portrait), (Twilight using a tripod), (Backlight), (Backlight Portrait), (Landscape), (Macro), (Close Focus) or (Portrait), and displays an icon on the LCD screen when the scene is recognized. For details, see page 65.

Movie button

You can quickly start shooting movies from all REC modes.

- 1 Lower the lens cover to switch to shooting mode.
- 2 Touch .
- 3 To end recording the movie, touch .

You can also exit movie recording by pressing the shutter button fully down.



Note

- Movie button is not available in the following situations:
 - When the Smile Shutter function is activated
 - In Easy Mode
 - When using Self-timer



Changing the Movie Format, Image Quality or Image Size

Movie format:  (Settings) →  (Shooting Settings) → [Movie format] → [AVCHD] or [MP4]









Quality (AVCHD):  (REC Mode) →  (Movie Mode) →  (Quality) → [AVC HD 17M FH] or [AVC HD 9M HQ]



Image Size (MP4):  (REC Mode) →  (Movie Mode) →  (Image Size) → [MP4 12M], [MP4 6M] or [MP4 3M]

Movie shooting scene

Allows you to shoot with preset settings according to the scene when the camera is in Movie Mode.

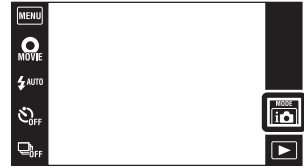
- 1 Lower the lens cover to switch to shooting mode.
- 2  (REC Mode) →  (Movie Mode)
- 3 **MENU** →  (Movie shooting scene) → desired mode
- 4 Press the shutter button fully down.
- 5 To end recording the movie, press the shutter button fully down again.



✓	 (Auto)	Adjusts the setting automatically.
	 (Underwater)	Allows you to shoot a movie underwater in natural colors using the housing (such as Marine Pack).

Smile Shutter

When the camera detects a smile, the shutter is released automatically.

1 Lower the lens cover to switch to shooting mode.

2 **MENU** → 😊 (Smile Shutter)

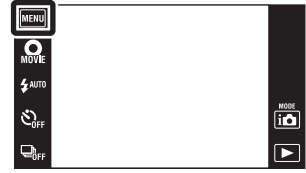

3 Wait detecting a smile.

When the smile level exceeds the ▼ point on the indicator, the camera records images automatically.

If you press the shutter button during Smile Shutter, the camera shoots the image, and then returns to Smile Shutter mode.

4 To end the Smile Shutter, touch **MENU** → 😊 (Smile Shutter).

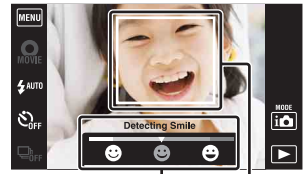

Notes

- Shooting using the Smile Shutter ends automatically when either the memory card or internal memory becomes full.
- Smiles may not be detected correctly depending on the conditions.
- You cannot use the Digital Zoom function.
- The Smile Shutter function is not available in the following situations:
 - In Intelligent Sweep Panorama mode
 - In Movie Mode
 - In Anti Motion Blur mode
 - In Hand-held Twilight mode
 - In Backlight Correction HDR mode

Setting the Smile Detection Sensitivity

In Smile Shutter mode, a button that sets the Smile Detection Sensitivity is displayed.



- 😊 : Detects a big smile.
- 😊 : Detects a normal smile.
- 😊 : Detects even a slight smile.

- The Smile Detection Sensitivity is fixed to [Normal Smile] in Easy Mode.
- When [Display Settings] is set to [Off], the Smile Detection Sensitivity is not displayed.

💡 Hints for better capturing of smiles

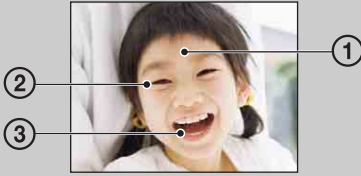

- ① Do not cover the eyes with the bangs.
Do not obscure the face by hat, masks, sunglasses, etc.
- ② Try to orient the face in front of the camera and be as level as possible. Keep the eyes narrowed.
- ③ Give a clear smile with an open mouth. The smile is easier to detect when the teeth are showing.

- The shutter operates when any person whose face is being detected smiles.
- You can select or register the selected subject for face detection with [Face Detection]. When the selected face is registered in the camera memory, Smile Detection is performed only for that face. To perform smile detection for a different face, touch that face (page 67).
- If the camera does not detect a smile, set the Smile Detection Sensitivity.





Flash

1 Lower the lens cover to switch to shooting mode.

2  AUTO (Flash) → desired mode

When the buttons are not displayed on the left side of the LCD screen, touch **MENU**.



✓	 AUTO (Auto)	Flashes when shooting in low light or backlight conditions.
	 (On)	Flash always operates.
	 SL (Slow Synchro)	Flash always operates. The shutter speed is slow in a dark place to clearly shoot the background that is out of flash light.
	 (Off)	Flash does not operate.

Notes

- The flash strobes twice. The first flash adjusts the light quantity.
- While charging the flash,  is displayed.
- You cannot use the flash during burst shooting.
- [On] or [Slow Synchro] is not available when the camera is in Intelligent Auto Adjustment mode.
- [Auto] or [Slow Synchro] is not available when the camera is in Backlight Correction HDR mode.
- [Flash] is set to [Off] in the following situations:
 - In Intelligent Sweep Panorama mode
 - In Anti Motion Blur mode
 - In Hand-held Twilight mode

When the “White circular spots” appears in flash photos

This is caused by particles (dust, pollen, etc.) floating close to the lens. When they are accentuated by the camera’s flash, they appear as white circular spots.

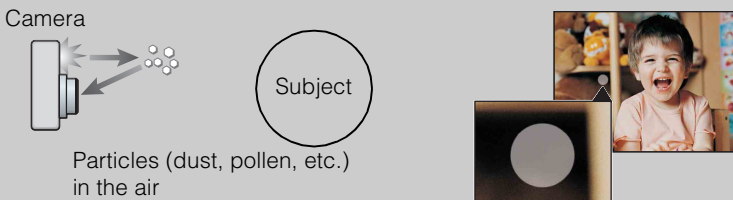

How can the “White circular spots” be reduced?

- Light the room and shoot the subject without a flash.
- Select  (High Sensitivity) mode in Scene Selection. (The flash is set to [Off].)

Flash

In Easy Mode, select the Flash setting from **MENU**.

- 1 Lower the lens cover to switch to shooting mode.
- 2 **MENU** → EASY (Easy Mode) → [OK]
- 3 **MENU** → [Flash] → desired mode

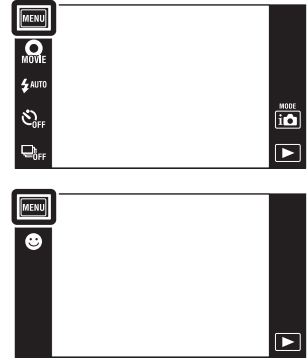

✓	Auto	Flashes when shooting in low light or backlight conditions.
	Off	Flash does not operate.







Self-Timer

1 Lower the lens cover to switch to shooting mode.

2  OFF (Self-Timer) → desired mode

When the buttons are not displayed on the left side of the LCD screen, touch **MENU**.



✓	 OFF (Off)	Does not use the self-timer.
	 10 (10sec)	Sets the self-timer to a 10-second delay. When you press the shutter button, the self-timer lamp flashes and a beep sounds until the shutter operates. To cancel, touch  .
	 2 (2sec)	Sets the self-timer to a 2-second delay.
	 (Self-portrait One Person)	Sets the self-timer to Self-portrait timer. When the camera detects the specified number of faces, a beep sounds, and the shutter operates 2 seconds later. Do not move the camera during this while.
	 (Self-portrait Two People)	

Notes

- In Movie Mode, [Self-portrait One Person] or [Self-portrait Two People] is not available.
- The self-timer is not valid when shooting in Intelligent Sweep Panorama mode.



Automatic shooting with Self-portrait timer

Point the lens at yourself so your face is reflected in the LCD screen. The camera detects the subjects, and then the shutter operates. The camera determines the optimal composition and prevents faces from being cut out of the LCD screen.



- You can also shoot a image by pressing the shutter button during this operation.

Hints for preventing blur

If your hands or body moves while holding the camera and pressing the shutter button, “Camera shake” occurs. Camera shake occurs frequently under low-light or slow shutter speed conditions, such as those encountered in  (Twilight Portrait) or  (Twilight) mode. In such a case, shoot with the below tips in mind.

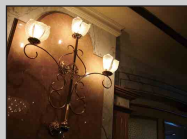
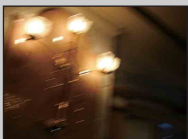



- Shoot with a 2-second delay self-timer and stabilize the camera by holding your arms firmly at your side after pressing the shutter button.
- Use a tripod or place the camera on a flat surface to hold the camera steady.

Self-Timer

In Easy Mode, select the Self-Timer setting from **MENU**.

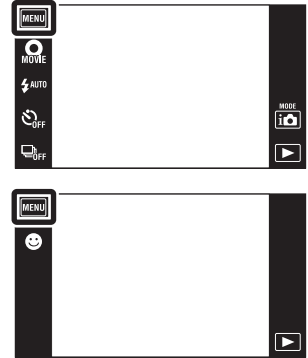
- 1 Lower the lens cover to switch to shooting mode.
- 2 **MENU** → EASY (Easy Mode) → [OK]
- 3 **MENU** → [Self-Timer] → desired mode



✓	Off	Does not use the self-timer.
	On	Sets the self-timer to a 10-second delay. When you press the shutter button, the self-timer lamp flashes and a beep sounds until the shutter operates. To cancel, touch  .

Shooting Direction

Set the direction to pan the camera when you shoot Intelligent Sweep Panorama images.

1 Lower the lens cover to switch to shooting mode.

2  (REC Mode) →  (iSweep Panorama)



3  (Shooting Direction) → desired direction









✓	 (Right)	Pan from left to right.
	 (Left)	Pan from right to left.
	 (Up)	Pan from down to up.
	 (Down)	Pan from up to down.

Image Size/Quality





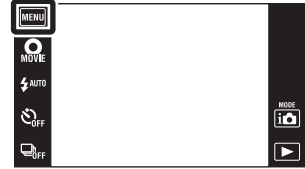

The image size determines the size of the image file that is recorded when you take a image. The larger the image size, the more detail will be reproduced when the image is printed on large-format paper. The smaller the image size, the more images can be recorded.

- 1 Lower the lens cover to switch to shooting mode.
- 2 **MENU** →  (Image Size) or  (Quality) → desired size

Depending on the REC mode, this is set using buttons displayed on the left side of the screen.



When shooting still images

	Image size	Usage guidelines	LCD screen
✓	 (3648×2736)	For prints up to A3+ size	 Images are displayed in 4:3 aspect ratio.
	 (2592×1944)	For prints up to L/2L/A4 size	
	 (640×480)	For e-mail attachments	
	 (3648×2056)	For viewing on a high-definition TV and printing up to A4 size	 Images will fill the entire screen.
	 (1920×1080)	For viewing on a high-definition TV	



Note

- When you print still images recorded with 16:9 aspect ratio, both edges may be cut off.

In Easy Mode

✓	Large	Shoots images in [10M] size.
	Small	Shoots images in [5M] size.

When shooting Intelligent Sweep Panorama images

✓	 (Standard) <small>STD</small> (Horizontal: 4912×1080) (Vertical: 3424×1920)	Shoots the images using standard size.
	 (Wide) <small>WIDE</small> (Horizontal: 7152×1080) (Vertical: 4912×1920)	Shoots the images using wide size.



When shooting movies

The larger the size of the movie image, the higher the image quality. The higher the amount of data used per second (average bit-rate), the smoother the playback image.

Select a movie recording format by touching **MENU** →  (Settings) →  (Shooting Settings) → [Movie format] in shooting mode (page 93).



Movie recording format (AVCHD)

Movies shot with this camera are recorded in AVCHD format, at approximately 60 fields/sec (for 1080 60i-compatible devices) or 50 fields/sec (for 1080 50i-compatible devices), in interlaced mode, with Dolby Digital audio, AVCHD format.

	Movie quality	Average bit-rate	Description
	 AVC HD 17M FH	17 Mbps	Shoots at a maximum picture quality of 1920×1080 size
✓	 AVC HD 9M HQ	9 Mbps	Shoots at a high picture quality of 1440×1080 size

Movie recording format (MP4)

Movies shot with this camera are recorded in MPEG-4 format, at approximately 30 frames/sec (for 1080 60i-compatible devices) or approximately 25 frames/sec (for 1080 50i-compatible devices), in progressive mode, with AAC audio, mp4 format.

	Movie image size	Average bit-rate	Description
✓	 MP4 12M	12 Mbps	Shoots at 1440×1080 size
	 MP4 6M	6 Mbps	Shoots at 1280×720 size
	 MP4 3M	3 Mbps	Shoots at VGA size

Note

- A telephoto image is produced when the [MP4 3M] image size is selected.

💡 On “image quality” and “image size”

A digital image is made up of a collection of small dots called pixels. If it contains a large number of pixels, the image becomes large, it takes up more memory, and the image is displayed in fine detail. “Image size” is shown by the number of pixels. Although you cannot see the differences on the screen of the camera, the fine detail and data processing time differ when the image is printed or displayed on a computer screen.

Description of the pixels and the image size

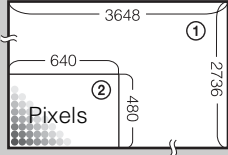

- ① Image size: 10M
 $3648 \text{ pixels} \times 2736 \text{ pixels} = 9,980,928 \text{ pixels}$
- ② Image size: VGA
 $640 \text{ pixels} \times 480 \text{ pixels} = 307,200 \text{ pixels}$

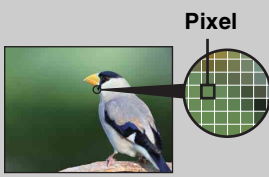

Many pixels
(Fine image quality and large file size)



Few pixels
(Rough image quality but small file size)

Burst





The camera shoots up to 10 continuous frames in one burst when you hold down the shutter button.

1 Lower the lens cover to switch to shooting mode.

2  OFF (Burst) → desired mode

When the buttons are not displayed on the left side of the LCD screen, touch **MENU**.



✓	 OFF (Off)	Records a single image.
	 Hi (High)	Shoots up to 10 images per second in succession.
	 Mid (Mid)	Shoots up to 5 images per second in succession.
	 Lo (Low)	Shoots up to 2 images per second in succession.

Notes

- Burst mode is not available in the following situations:
 - In Intelligent Sweep Panorama mode
 - In Movie Mode
 - In Anti Motion Blur mode
 - In Hand-held Twilight mode
 - In Backlight Correction HDR mode
 - When the Smile Shutter function is activated
 - In Easy Mode
- The flash is set to [Off].
- When recording with the self-timer, a series of a maximum of five images is recorded.
- The recording interval becomes longer, depending on the setting for the image size.
- [Focus], [White Balance], and [EV] are adjusted for the first image, and these settings are also used for the other images.
- [VGA] image size will be set while recording on internal memory.
- When the battery level is low, or when the internal memory or a memory card is full, the burst stops.
- In slow shutter speed conditions, the burst of shots per second may be decreased.

About the recording of burst shooting images

After shooting burst images, the shot images are displayed in frames on the LCD screen. When all the images are fitted in the frames, recording is completed. You can stop the recording by touching [Cancel recording] → [OK]. When stopped, the image displayed in index and images in the image processing are recorded.

Macro



Use this setting to capture beautiful close-up images of small subjects such as insects or flowers.

1 Lower the lens cover to switch to shooting mode.

2 **MENU** →  **AUTO (Macro)** → desired mode

Depending on the REC mode, this is set using buttons displayed on the left side of the screen.



✓	 AUTO (Auto)	The camera adjusts the focus automatically from distant subjects to close-up.
	 (Close Focus)	Use this mode to shoot at close distances. Locked to the W side: Approximately 1 cm to 20 cm (13/32 inches to 7 7/8 inches)

Notes

- [Macro] is set to [Auto] in the following situations:
 - In Intelligent Sweep Panorama mode
 - In Movie Mode
 - In Anti Motion Blur mode
 - In Hand-held Twilight mode
 - When the Smile Shutter function is activated
 - In Easy Mode
 - When [Self-Timer] is set to [Self-portrait One Person] or [Self-portrait Two People]
- Note the following points when using the Close focus mode.
 - You cannot use the Scene Recognition or Face Detection functions.
 - This mode is cancelled if you turn off the power or switch the shooting mode to another one.
 - The flash mode settings you can use in this mode are [On] or [Off] only.
 - The focus speed becomes slower.

EV

You can adjust the exposure manually in 1/3 EV steps in a range of -2.0 EV to +2.0 EV.

1 Lower the lens cover to switch to shooting mode.

2 **MENU** → 0EV (EV)

Depending on the REC mode, this is set using buttons displayed on the left side of the screen.

3 Touch **+**/**-** to adjust exposure → [OK].

You can also adjust the exposure by touching ● of the adjustment bar and dragging to the right or left.

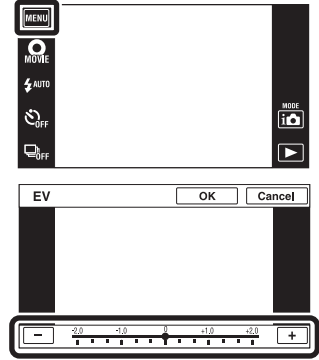

Notes

- [EV] is not available in Backlight Correction HDR mode or in Easy Mode.
- If you shoot a subject in extremely bright or dark conditions, or when you use the flash, the exposure adjustment may not be effective.

Adjusting the exposure for better looking images



Overexposure = too much light
Whitish image



Lower EV setting -



Correct exposure



Higher EV setting +



Underexposure = too little light
Darker image

ISO

Sets the luminous sensitivity when the camera is in Program Auto mode or when Scene Selection is set to  (Underwater).

- 1 Lower the lens cover to switch to shooting mode.
- 2 **MENU** → **ISO AUTO** (ISO) → desired number

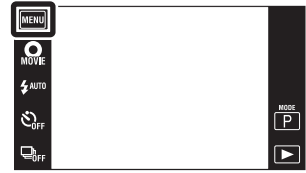

✓	ISO AUTO (Auto)	Sets the ISO sensitivity automatically.
	ISO / ISO / ISO / 125 / 200 / 400 / ISO / ISO / ISO 800 / 1600 / 3200	You can reduce image blurring in dark locations or moving subjects by increasing ISO sensitivity (select a larger number).

Note

- You can select only from [ISO AUTO], [ISO 125] to [ISO 800] when the shooting mode is set to burst mode.

Adjusting ISO Sensitivity (Recommended Exposure Index)

ISO sensitivity is a speed rating for recording media that incorporates an image sensor that receives light. Even when the exposure is the same, images differ depending on the ISO sensitivity.



High ISO sensitivity

Records a bright image even in dark locations while increasing shutter speed to reduce blur. However, the image tends to become noisy.



Low ISO sensitivity

Records a smoother image. However, when the exposure is insufficient, the image may become darker.

Hints for preventing blur

Even though the camera is steady, the subject moves during the exposure and is captured blurred when the shutter button is pressed. Camera shake is reduced automatically, however, the function does not effectively reduce subject blur.

Subject blur occurs frequently under low-light or slow shutter speed conditions. In such a case, shoot with the below tips in mind.



- Select a higher ISO sensitivity to make the shutter speed faster, and press the shutter button before the subject moves.
- Select **iSo** (High Sensitivity) mode in Scene Selection.

White Balance

Adjusts color tones according to the surrounding light conditions. Use this function if image color appears unnatural.

- 1 Lower the lens cover to switch to shooting mode.
- 2 **MENU** → **WB AUTO** (White Balance)

- 3 Touch the desired mode → [OK]

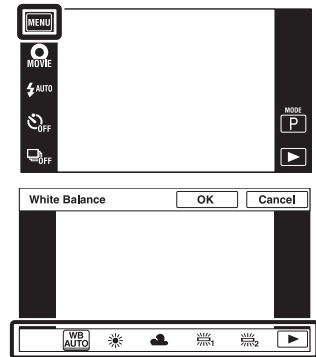

✓	WB AUTO (Auto)	Adjusts the white balance automatically so that the colors appear natural.
	☀ (Daylight)	Adjusts for outdoors conditions on a fine day, evening views, night scenes, neon signs, fireworks, etc.
	☁ (Cloudy)	Adjusts for a cloudy sky or a shady location.
	☀₁ (Fluorescent White Balance 1) ☀₂ (Fluorescent White Balance 2) ☀₃ (Fluorescent White Balance 3)	[Fluorescent White Balance 1]: Adjusts for white fluorescent lighting. [Fluorescent White Balance 2]: Adjusts for natural white fluorescent lighting. [Fluorescent White Balance 3]: Adjusts for day white fluorescent lighting.
	💡 (Incandescent)	Adjusts for places under incandescent lamp, or under bright lighting, such as in a photo studio.
	⚡WB (Flash)	Adjusts for the flash conditions.
	📷 (One Push)	Adjusts the white balance depending on the light source. The white color memorized in [One Push Set] mode becomes the basic white color. Use this mode when [Auto] or other modes cannot be set the color properly.
	📷^{SET} (One Push Set)	Memorizes the basic white color which will be used in [One Push] mode.

Notes

- [White Balance] is not available in the following situations:
 - In Intelligent Auto Adjustment mode
 - In Easy Mode
- When [Flash] is set to [On] in Backlight Correction HDR mode, [White Balance] is not available.
- [Flash] in [White Balance] is not available in the following situations:
 - In Intelligent Sweep Panorama mode
 - In Movie Mode
 - In Anti Motion Blur mode
 - In Hand-held Twilight mode
 - When Scene Selection is set to **iso** (High Sensitivity) mode
- Under fluorescent lights that flicker, the white balance function may not work correctly even though you select [Fluorescent White Balance 1], [Fluorescent White Balance 2] or [Fluorescent White Balance 3].
- When shooting with a flash in other than [Flash] mode, [White Balance] is set to [Auto].
- When flash is [On] or [Slow Synchro], the white balance can only be adjusted to [Auto], [Flash], [One Push], or [One Push Set].
- [One Push Set] cannot be selected while charging the flash.

To capture the basic white color in [One Push Set] mode

- 1 Frame a white object such as a piece of paper filling the screen under the same lighting conditions as you will shoot the subject.
- 2 **MENU** → $\frac{WB}{AUTO}$ (White Balance) → [One Push Set] → [Capture]
The screen momentarily turns black, and when the white balance has been adjusted and stored in the memory, the recording screen is displayed again.





Notes

- If the  indicator flashes while shooting, the white balance is either not set or cannot be set. Use automatic white balance.
- Do not shake or strike the camera while [One Push Set] is in progress.
- When flash mode is set to [On] or [Slow Synchro], the white balance is adjusted to the condition with the flash emitting.
- The white references loaded using [White Balance] and [Underwater White Balance] are stored separately.



Effects of lighting conditions

The apparent color of the subject is affected by the lighting conditions.

The color tones are adjusted automatically, but you can adjust color tones manually using the White Balance function.

Weather/lighting	Daylight	Cloudy	Fluorescent	Incandescent
Characteristics of light	White (standard) 	Bluish 	Green-tinged 	Reddish 





Underwater White Balance

Adjusts the color tone when the camera is set to  (Underwater) mode in Scene Selection or  (Underwater) mode in [Movie shooting scene].

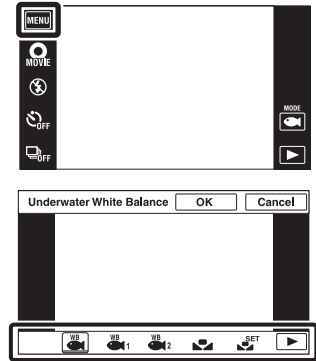
- 1 Lower the lens cover to switch to shooting mode.
- 2 **MENU** →  (Underwater White Balance)

- 3 Desired mode → [OK]



✓	 (Auto)	Automatically adjusts the color tones for underwater conditions to make the colors appear natural.
	 (Underwater 1)	Adjusts for underwater conditions where blue is strong.
	 (Underwater 2)	Adjusts for underwater conditions where green is strong.
	 (One Push)	Adjusts the white balance depending on the light source. The white color memorized in [One Push Set] mode becomes the basic white color. Use this mode when [Auto] or other modes cannot be set the color properly.
	 (One Push Set)	Memorizes the basic white color which will be used in [One Push] mode (page 60).

Notes

- Depending on the color of the water, the Underwater White Balance may not work correctly even though you select [Underwater 1] or [Underwater 2].
- When flash is [On], the underwater white balance can only be adjusted to [Auto], [One Push], or [One Push Set].
- [One Push Set] is unable to be selected while charging the flash.
- The white references loaded using [White Balance] and [Underwater White Balance] are stored separately.

Focus





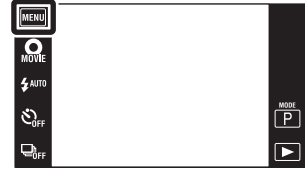

You can change the focus method. Use the menu when it is difficult to get the proper focus in auto focus mode.

AF stands for “Auto Focus,” a function that adjusts the focus automatically.

1 Lower the lens cover to switch to shooting mode.

2 **MENU** →  (Focus) → desired mode



✓	 (Multi AF)	<p>Focuses on a subject in all ranges of the finder frame automatically.</p> <p>When you press the shutter button halfway down in still image shooting mode, a green frame is displayed round the area that is in focus.</p> <ul style="list-style-type: none"> • When the Face Detection function is active, AF operates with priority on faces. • When Scene Selection is set to  (Underwater), focus operation is adjusted to underwater shooting. When focus is achieved by half-pressing the shutter button, a large frame is displayed in green. 	 <p>AF range finder frame</p>
	 (Center AF)	<p>Focuses on a subject in the center of the finder frame automatically. Using the AF lock function together, you can compose the image the way you want.</p>	 <p>AF range finder frame</p>
	 (Spot AF)	<p>Focuses on an extremely small subject or a narrow area automatically. Using the AF lock function together, you can compose the image the way you want. Hold the camera steady so as not to misalign the subject and the AF range finder frame.</p>	 <p>AF range finder frame</p>

Notes

- When you use [Digital Zoom] or [AF Illuminator], the AF range finder frame setting is disabled and AF range finder frame is displayed as a dotted line instead. In this case, the camera works to focus on the subjects at the center of the screen.
- If you set the focus mode to other than [Multi AF], [Face Detection] is fixed to [When touched].
- [Focus] is set to [Multi AF] in the following situations:
 - In Intelligent Auto Adjustment mode
 - In Movie Mode
 - In Anti Motion Blur mode
 - In Hand-held Twilight mode
 - When the Smile Shutter function is activated
 - In Easy Mode
 - When [Self-Timer] is set to [Self-portrait One Person] or [Self-portrait Two People]
 - When you adjust focus by touching the LCD screen

💡 Quickly choosing the priority subject

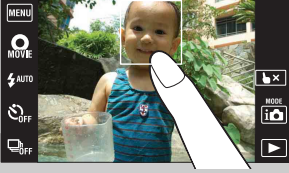

Touching the screen displays a frame, and then pressing the shutter button halfway down brings the frame into focus.

Table of contents

Operation Search

MENU/Settings Search





Index

Metering Mode

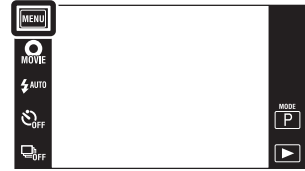
Selects the metering mode that sets which part of the subject to measure to determine the exposure.

- 1 Lower the lens cover to switch to shooting mode.
- 2 **MENU** →  (Metering Mode) → desired mode



✓	 (Multi)	Divides into multiple regions and measures each region. The camera determines a well-balanced exposure (Multi-pattern metering).
	 (Center)	Measures the center of the image, and determines the exposure based on the brightness of the subject there (Center-weighted metering).
	 (Spot)	Measures only a part of the subject (Spot metering). This function is useful when the subject is backlit or when there is strong contrast between the subject and the background. <div style="text-align: right; margin-top: 10px;">  <p>Spot metering cross-hairs Positions on the subject</p> </div>

Notes

- In Movie Mode, [Spot] cannot be selected.
- [Metering Mode] is set to [Multi] in the following situations:
 - In Intelligent Auto Adjustment mode
 - In Backlight Correction HDR mode
 - When the Smile Shutter function is activated
 - In Easy Mode
 - When [Self-Timer] is set to [Self-portrait One Person] or [Self-portrait Two People]
 - When you touch the LCD screen to adjust focus
- If you set Metering mode to other than [Multi], [Face Detection] is fixed to [When touched].

Scene Recognition

The camera automatically detects shooting conditions, and then takes the shot.

When a motion is detected, the ISO sensitivity is increased according to the movement to reduce subject blur (Motion Detection).



Example of an image when (Backlight) is activated.

Scene Recognition icon and guide

The camera recognizes the following types of scenes. When the camera determines the optimal scene, it displays the corresponding icon and the guide.

- (Twilight), (Twilight Portrait),
- (Twilight using a tripod), (Backlight),
- (Backlight Portrait), (Landscape),
- (Macro), (Close Focus), (Portrait)

1 Lower the lens cover to switch to shooting mode.

2 (REC Mode) → (Intelligent Auto Adjustment)

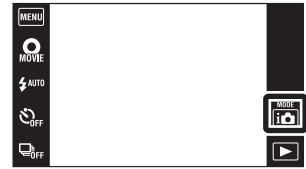

3 **MENU** → (Scene Recognition) → desired mode



✓	(Auto)	When the camera recognizes the scene, it switches to the optimal settings and shoots the image.
	(Advanced)	<p>When the camera recognizes the scene, it switches to the optimal settings. When the camera recognizes (Twilight), (Twilight Portrait), (Twilight using a tripod), (Backlight) or (Backlight Portrait), it automatically changes the settings and shoots another image.</p> <ul style="list-style-type: none"> • When you shoot two images consecutively, the + mark on the icon will turn green. • When two frames are shot, the two images are displayed side by side immediately after shooting. • When [Anti Blink] is displayed, 2 images are taken automatically and the image with the eyes open is selected automatically. For details on the Anti Blink function, see “What is the Anti Blink function?”.

Notes

- The Scene Recognition function does not operate when you shoot images using Digital Zoom.
- [Scene Recognition] is set to [Auto] in the following situations:
 - During burst shooting
 - When the Smile Shutter function is activated
 - When [Self-Timer] is set to [Self-portrait One Person] or [Self-portrait Two People]
- The available flash settings are [Auto] and [Off].
- 🌙 (Twilight using a tripod) scenes sometimes cannot be recognized in an environment where vibrations are transferred to the camera even though it is fixed on a tripod.
- Sometimes a slow shutter results when a scene is recognized as a 🌙 (Twilight using a tripod). Keep the camera still during shooting.
- The Scene Recognition icon appears regardless of the [Display Settings].
- These scenes may not be recognized depending on the situation.

🔦 Shooting two images with different settings and selecting the one you like (Advanced mode)

In [Advanced] mode, the camera shoots two images consecutively with the settings differing as follows when it recognizes 🌙 (Twilight), 🌙 (Twilight Portrait), 🌙 (Twilight using a tripod), 📷 (Backlight) or 📷 (Backlight Portrait) scenes, which tends to blur. You can select the desired image from the two images shot.

	First Image*	Second Image
🌙	Shoots in Slow Synchro	Shoots with sensitivity increased and shake reduced
🌙	Shoots in Slow Synchro with the face which the flash strobes on as guide	Shoots with sensitivity increased with the face as guide and shake reduced
🌙	Shoots in Slow Synchro	Shoots with even slower shutter speed without increasing sensitivity
📷	Shoots with the flash	Shoots with the brightness and contrast of the background adjusted
📷	Shoots with the face which the flash strobes on as guide	Shoots with the brightness and contrast of the face and the background adjusted

* When flash is set to [Auto].

🔦 What is the Anti Blink function?

When set to [Advanced], the camera automatically shoots two images consecutively* when it recognizes 🧑 (Portrait). The camera will select, display, and record the image which the eyes are not blinked automatically. If the eyes are closed in both images, the message “Blinked eye detected” is displayed.

* except when the flash strobes/when the shutter speed is slow

Face Detection

Detects the faces of your subjects and adjusts the focus, flash, exposure, white balance and red-eye reduction settings automatically.



Face Detection frame (Orange)

When the camera detects more than one subject, the camera will judge which is the main subject and set focus by priority. The Face Detection frame for the main subject will turn orange. The frame for which the focus is set will turn green when the shutter button is pressed halfway down.

Face Detection frame (White)

- 1 Lower the lens cover to switch to shooting mode.
- 2 **MENU** → (Face Detection) → desired mode



	(When touched)	Detects the face when an area with a face is touched on the screen.
✓	(Auto)	Selects the face the camera is to automatically focus on.
	(Child Priority)	Detects and shoots with priority on child's face.
	(Adult Priority)	Detects and shoots with priority on adult's face.



Notes

- [Face Detection] is not available in the following situations:
 - In Intelligent Sweep Panorama mode
 - In Movie Mode
 - In Easy Mode
- [When touched] is not available when [Self-Timer] is set to [Self-portrait One Person] or [Self-portrait Two People].
- You can select [Face Detection] only when the Focus mode is set to [Multi AF] or the Metering Mode is set to [Multi].
- The Face Detection function does not work when using the Digital Zoom.
- Up to 8 faces of your subjects can be detected.
- Adults and children may not be recognized correctly depending on the conditions.
- During Smile Shutter shooting, [Face Detection] is automatically set to [Auto] even if it is set to [When touched].

💡 Registering the priority face (Selected-face Memory)



Normally the camera automatically selects the face to focus on according to the [Face Detection] setting, but you can also select and register a face to be given priority.





- ① Touch a face you want to register as the priority face during Face Detection.
The selected face is registered as the priority face, and the frame changes to an orange-colored .
 - ② Each time you touch a different face, that face is registered as the priority face.
 - ③ To cancel face registration, touch .
- When you remove the battery from the camera, the face registration is reset.
 - When the registered face disappears from the LCD screen, the camera returns to the setting selected by [Face Detection]. When the registered face is shown on the LCD screen again, the camera focuses on the registered face.
 - It may not be possible to detect the registered face correctly depending on the surrounding brightness, the subject's hairstyle, etc. In this case, register the face again under the conditions where the image will be shot.
 - When the Smile Shutter function is used with the Face Detection frame registered, Smile Detection is performed only on the registered face.
 - In Easy Mode or when [Self-Timer] is set to [Self-portrait One Person] or [Self-portrait Two People], the priority face cannot be registered.

Anti Blink

When Scene Selection is set to  (Soft Snap) while you are shooting an image, the camera automatically shoots two images consecutively. The camera will select, display and record the image which the eyes are not blinked automatically.

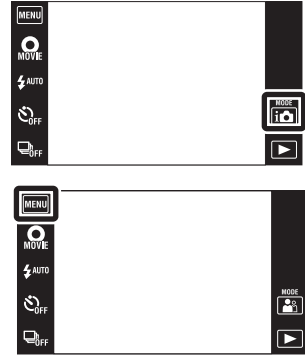
- 1 Lower the lens cover to switch to shooting mode.
- 2  (REC Mode) → **SCN** (Scene Selection) →  (Soft Snap)
- 3 **MENU** →  (Anti Blink) → desired mode



✓	 (Auto) AUTO	When Face Detection is active, the Anti Blink function operates so that images with the subject's eyes open are recorded.
	 (Off) OFF	Does not use the Anti Blink function.

Notes



- Anti Blink does not function in the following situations.
 - When using the flash
 - During burst shooting
 - When the Face Detection function does not work
 - When the Smile Shutter function is activated
- Sometimes Anti Blink function does not work depending on the situation.
- When the Anti Blink function is set to [Auto] but only images with the subject's eyes closed are recorded, the message "Blinked eye detected" is displayed on the LCD screen. Shoot again as necessary.

Display Settings

Sets whether to display the operation buttons on the LCD screen in shooting mode.

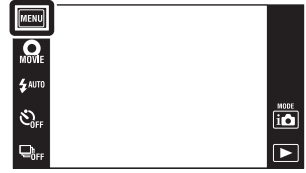
- 1 Lower the lens cover to switch to shooting mode.
- 2 **MENU** →  (Display Settings) → desired mode



✓	 (On)	Displays the operation buttons.	
	 (Off)	Does not display the operation buttons.	

 To display the operation buttons when [Display Settings] is set to [Off]

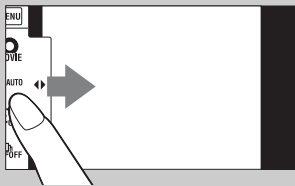

Touch the left side of the LCD screen and drag right to display the operation buttons.

Easy Mode

When viewing still images in Easy Mode, the playback screen text becomes larger, indicators become easier to see, and fewer functions can be used.

- 1 Press the  (Playback) button to switch to playback mode.
- 2 **MENU** → **EASY** (Easy Mode) → [OK]

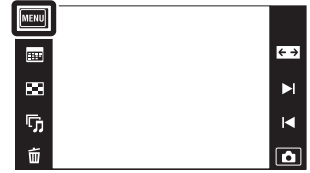









Notes

- The battery charge is used up more quickly because the screen brightness increases automatically.
- The shooting mode also changes to [Easy Mode].

Functions available in Easy Mode (Viewing)



-  (Delete) : Deletes the currently displayed image.
-  (Zoom) : Enlarges the displayed image.
- Drag up, down, right or left, or touch  to change the zoom position. Touch  to change the zoom magnification.



MENU :

- Touch [Delete Single Image] to delete the currently displayed image.
- Touch [Delete All Images] to delete all images in that date range or folder.
- Touch [Exit Easy Mode] to exit Easy Mode.

- When a memory card is inserted in the camera, [View Mode] is set to [Date View].



Calendar

This feature selects the date to be played back on the calendar when using Date View. Step 2 is unnecessary when [Date View] is already set.

- 1 Press the  (Playback) button to switch to playback mode.
- 2 **MENU** →  (View Mode) →  (Date View)

- 3 Touch  (Calendar).

When the buttons are not displayed on the left side of the LCD screen, touch **MENU**.

- 4 Select the month you want to display with /, then touch the desired date.

Drag the thumbnails of images for the selected date up or down to change the page. Touch an image to return to the single-image screen for that image.

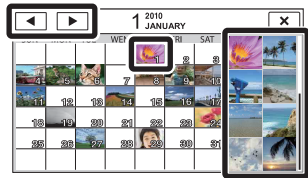
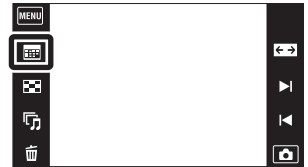
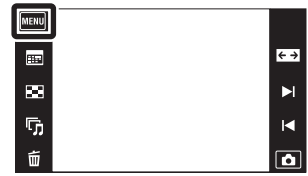

Images for the selected date

Note

- This item is not displayed when the internal memory is used to record images.

Image Index

Displays multiple images at the same time.



- 1 Press the  (Playback) button to switch to playback mode.
- 2 Touch  (Image Index).
When the buttons are not displayed on the left side of the LCD screen, touch **MENU**.
- 3 Touch the screen and drag up or down to change the page.
Touch an image on the index screen to return to the single-image screen for that image.



Table of contents



Operation Search

MENU/Settings Search



Index

Slideshow

Images are automatically played back in succession.

- 1 Press the  (Playback) button to switch to playback mode.
- 2 Touch  (Slideshow) → desired mode.
When the buttons are not displayed on the left side of the LCD screen, touch **MENU**.



 (Continuous Playback)	Plays back all the images in succession.
 (Slideshow with music)	Plays back still images in succession along with effects and music.

Continuous Playback

- 1 Select the image to start playback.
- 2 Touch  (Slideshow) → [Continuous Playback].
- 3 To end continuous playback, touch the LCD screen, and then touch [Exit Continuous Playback].
 - Touch \leftarrow/\rightarrow on the LCD screen to adjust the movie volume.

Note

- When [Display Burst Group] is [Display Main Image Only], only the main image is displayed.



Viewing panoramic images during continuous playback

The whole panoramic image is displayed for 3 seconds.
You can scroll a panoramic image by touching .

Slideshow with music

- 1 Touch  (Slideshow) → [Slideshow with music].
- 2 Touch desired mode → [Start].
- 3 To exit slideshow, touch the screen, then select from [Exit Slideshow].

Note

- [Slideshow with music] is not available for the following images or in the following situations:
 - Panoramic images
 - When [View Mode] is set to [Folder view (MP4)] or [AVCHD view]



Image		
Selects the group of images to be shown. This setting is fixed to [Folder] when the internal memory is used to record images.		
✓	All	Plays a slideshow of all the images in order.
	This Date	Plays a slideshow of images with the currently selected date range when View Mode is  (Date View).
	Folder	Plays a slideshow of images in the currently selected folder in Folder View.

Effects		
Selects the playback speed and mood for slideshows. If the playback time of a movie is long, an image is taken from it and displayed.		
✓	Simple	A simple slideshow switching images at a preset interval. The playback interval is adjustable in [Interval] and you can thoroughly enjoy your images.
	Nostalgic	A moody slideshow reproducing the atmosphere of a movie scene.
	Stylish	A stylish slideshow proceeding at a middle tempo.
	Active	A high-tempo slideshow suitable for active scenes.

Note

- When [Display Burst Group] is set to [Display Main Image Only], the burst images are displayed as follows.
 - When [Effects] is set to [Simple], only the main image is displayed.
 - When [Effects] is set to other than [Simple] and there are two or fewer burst images, only the main image is displayed.
 - When [Effects] is set to other than [Simple] and there are three or more burst images, three images including the main image are displayed.

Music

Specifies the music to be played during slideshows. You can select more than one background music track. Touch  to listen to each BGM. Touch / to adjust the BGM volume.

✓	Music1	The default setting for a [Simple] slideshow.
	Music2	The default setting for a [Nostalgic] slideshow.
	Music3	The default setting for a [Stylish] slideshow.
	Music4	The default setting for a [Active] slideshow.
	Mute	Does not use BGM.

Note

- The movies are played back without their audio.

Interval

Sets the screen switching interval. The setting is fixed to [Auto] when [Simple] is not selected as the [Effects].

	1 sec	Sets the display interval of images for a [Simple] slideshow.
✓	3 sec	
	5 sec	
	10 sec	
	Auto	The interval is set to suit the selected [Effects] item.

Note

- The interval setting is invalid for movie playback.

Repeat

Turns slideshow repeat on or off.

✓	On	Plays back images in a continuous loop.
	Off	After all the images have been played back, the slideshow ends.



Selecting background music

You can transfer a desired music file from your CDs or MP3 files to the camera to play back during slideshow. To transfer music, install the “Music Transfer” software (supplied) to your computer. For details, see pages 131 and 132.







- You can record up to four pieces of music on the camera (The 4 preset pieces (Music1 – Music4) can be replaced with the ones you transferred).
- The maximum length of each music file for music playback of the camera is about 5 minutes.
- If you cannot play back a music file due to damage or other malfunctions of the file, execute [Format Music] (page 113) and transfer the music again.

Delete

Allows you to select unwanted images for deletion.

- 1 Press the  (Playback) button to switch to playback mode.
- 2  (Delete) → desired mode



 (All but this image)	Deletes burst group images other than the selected image in Display Burst Group mode. After step 2, touch [OK].
 (All In This Group)	Deletes all images in the selected burst group at once. After step 2, touch [OK].
 (This Image)	Deletes the currently displayed image in single-image mode.
 (Multiple Images)	Allows you to select and delete multiple images. Do as the following after step 2. ① Touch the image you want to delete. Repeat the above steps until there are no more images to be deleted. Touch an image with a ✓ mark again to release the ✓ mark. ② Touch [OK] → [OK].
 (All in Date Range)  (All in This Folder)  (All AVCHD files)	Deletes all images in the selected date range or folder, or all AVCHD movies at once. After step 2, touch [OK].

Note



- When using internal memory, a Folder View is used with still images and movies displayed in the same folder.

In Easy Mode

Delete Single Image	Deletes the currently displayed image.
Delete All Images	Deletes all images in that date range or folder.

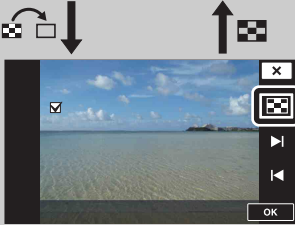
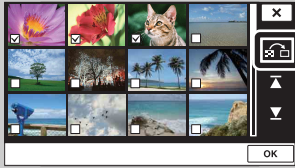
 You can switch between index and single-image mode when selecting images



Touch  to return to the single-image screen, and touch  on the single-image screen to return to the index screen.

- You can also switch between index and single-image mode in [Protect], [DPOF] or [Print].

Send by TransferJet

TransferJet is a close-up, wireless transfer technology that allows data to be transferred by closely aligning two products that you want to communicate with each other.

To find out whether your camera is equipped with the TransferJet function, check for the  (TransferJet) mark on the bottom of the camera.

Using a Memory Stick with TransferJet (sold separately) allows images to be transferred between TransferJet-compatible devices.

For more details on TransferJet, see the operating instructions supplied with Memory Stick with TransferJet.

1 Insert a Memory Stick with TransferJet into the camera and press the  (Playback) button.



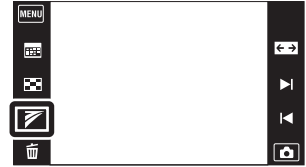

2  (Send by TransferJet) → desired mode

When the buttons are not displayed on the left side of the LCD screen, touch **MENU**.







3 Transfer images by closely aligning the  (TransferJet) marks on the camera and other device.



A notification sound is emitted when connection is made.

 (This Image)	Sends the currently displayed image in single-image mode.
 (Multiple Images)	<p>You can select and send multiple images. After step 2, perform the following.</p> <p>① Select an image to be sent, then touch it. Repeat the above steps until there are no more images to be sent. Touch an image with a  mark again to release the  mark.</p> <p>② Touch [OK] → [OK].</p>

Notes

- Only still images can be transferred.
- Up to 10 images can be transferred at once.
- First, set [TransferJet] to [On] by selecting **MENU** →  (Settings) →  (Main Settings) (page 115).
- While aboard an airplane, set [TransferJet] to [Off] by selecting **MENU** →  (Settings) →  (Main Settings) (page 115). In other cases, always follow all regulations governing the location in which the camera is being used.
- The connection is cut if transfer cannot be made within about 30 seconds. If this happens, select [Yes] and realign the two  (TransferJet) marks on the camera and another device.
- Memory Stick with TransferJet and camera models with TransferJet are not sold in some countries and regions due to local laws and regulations.
- Set the [TransferJet] function to [Off] in countries and regions other than where you purchased your camera. Depending on the country or region, if you use the TransferJet function, you may be liable due to local restrictions on transmission of electromagnetic waves.

Receiving images using TransferJet

- 1 Press the  (Playback) button to turn on the camera.
- 2 Closely align the  (TransferJet) marks on the camera and sending device to receive images.

A notification sound is emitted when connection is made.



Notes

- Only images that can be displayed on the camera can be played.
- If an Image Database File error occurs during saving, a Recover Image Database File screen will appear.
- Play images that cannot be registered in the Image Database File using [Folder view (Still)].

Tips for sending and receiving data successfully

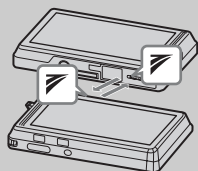
Closely align the  (TransferJet) mark on the camera and other device.





- The transfer rate and range differ depending on the angle at which the  (TransferJet) marks are aligned.
- Sending and receiving data is easier if the  (TransferJet) marks are aligned with both cameras parallel to each other as shown in the figure.

Using separately sold TransferJet-compatible devices

Using separately sold TransferJet-compatible devices allows you to transfer images to a PC and can broaden your enjoyment of transferring data.

For details, see the operating instructions supplied with your TransferJet-compatible device.

- Note the following points when using TransferJet-compatible devices.
 - Before use, set the camera to playback mode.
 - If an image does not display, select **MENU** →  (Settings) →  (Main Settings) and then set [LUN Settings] to [Single].
 - While connected, data cannot be written to or deleted from the camera.
 - Do not disconnect while importing images to “PMB”.

Paint

Paints or adds stamps to a still image and saves it as a new file.



- 1 Press the (Playback) button to switch to playback mode.
- 2 **MENU** → (Paint)
When using the internal memory, touch (Paint) on the left side of the LCD screen.
- 3 Draw on the image using the paint pen (supplied).
- 4 Touch the / button → select the saved image size.

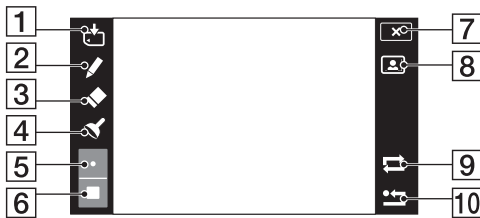
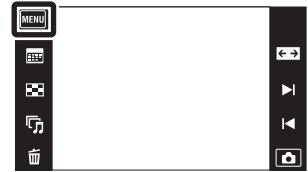



	Button	Action
1		Save Saves the image in VGA or 5M format in the internal memory or on a memory card.
2		Pen Paint characters or graphics.
3		Eraser Make corrections.
4		Stamp Apply a stamp to the image.
5		Thickness/Stamps Select the pen or eraser thickness, or the stamp.
6		Color Select the color.
7		Exit Exit paint mode.
8		Frame Add a frame. Select the desired frame with / .
9		Revert Undo the last action.
10		Clear all Erase all painting.

Note











- You cannot paint or put stamps on panoramic images, images displayed in a burst group and movies.

Retouch

Retouches a recorded image and records it as a new file.
The original image is retained.

- 1 Press the  (Playback) button to switch to playback mode.
- 2 **MENU** →  (Retouch) → desired mode
- 3 Perform retouching according to the operation method in each mode.





<p> (Trimming (Resize))</p>	<p>Records the zoomed playback image. Touch / → set the point with / // → NEXT → select an image size to save with / → NEXT → [OK]</p> <ul style="list-style-type: none"> • The quality of trimmed images may deteriorate. • The image size that you can trim may vary depending on the image.
<p> (Red Eye Correction)</p>	<p>Corrects the red-eye phenomenon caused by flash. After red eye correction is completed, touch [OK].</p> <ul style="list-style-type: none"> • You may not be able to correct the red-eye phenomenon depending on the image.
<p> (Unsharp masking)</p>	<p>Sharpens the image within a chosen frame. Touch the area (frame) of the desired image to retouch → NEXT → [OK]</p> <ul style="list-style-type: none"> • Depending on the image, sufficient correction may not be applied and the image quality may deteriorate.

Note





- You cannot retouch panoramic images, images displayed in a burst group, and movies.

View Mode

Allows you to select the display format for viewing images.

- 1 Press the  (Playback) button to switch to playback mode.
- 2 **MENU** →  (View Mode) → desired mode



✓	 (Date View)	Displays images by the date.
	 (Folder view (Still))	Displays still images.
	 (Folder view (MP4))	Displays movies in MP4 format.
	 (AVCHD view)	Displays movies in AVCHD format.

Notes

- When using internal memory, a Folder View is used with still images and movies displayed in the same folder.
- Event View is not available on this camera.





Viewing images taken with a different camera

This camera creates an Image Database File on the memory card for recording and playing images. If the camera detects images not registered in the Image Database File on the memory card, a registration screen with the message “Files found which were not recognized Import files” will be displayed. To view unregistered images, register them by selecting [OK].



- Use a sufficiently charged battery to register images. If a battery with a low charge is used to register unregistered images, it may not be possible to transfer data or data may be corrupted if the battery charge runs out.

Display Burst Group

You can select to display burst images in groups or display all images during playback.

- 1 Press the  (Playback) button to switch to playback mode.
- 2 **MENU** →  (View Mode) →  (Date View)
- 3 **MENU** →  (Display Burst Group) → desired mode



✓	 (Display Main Image Only)	Groups burst images, then plays back the main images only. <ul style="list-style-type: none"> • When Face Detection is performed in burst mode, the camera determines and displays the optimum image as the main image. When Face Detection is not performed, the first image in the burst group is displayed as the main image.
	 (Display All)	Plays back all burst images one at a time.

Displaying grouped burst images side by side

Only main images are displayed if [Display Main Image Only] has been set. You can display a line-up of images by following the procedure below.

Main image





Thumbnail image display

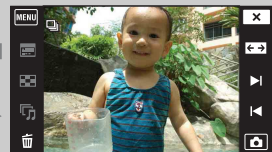

Single image display





The image being displayed above







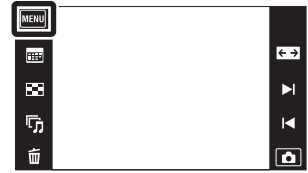

- ① Display the main image in playback mode, then touch it.
The images are displayed in the index.
- ② Touch /|/| to display the desired image.
 - You can also display the image by touching the thumbnail image at the bottom of the LCD screen.
- ③ The display switches between single image display and thumbnail image display each time you touch the screen.
- ④ To cancel the display, touch .

Protect

Protects recorded images against accidental erasure.
The  mark is displayed for registered images.

- 1 Press the  (Playback) button to switch to playback mode.
- 2 **MENU** →  (Protect) → desired mode



 (This Image)	Protects the currently displayed image in single-image mode.
 (Multiple Images)	You can select and protect multiple images. After step 2, perform the following. ① Select an image to be protected, then touch it. Repeat the above steps until there are no more images to be protected. Touch an image with a ✓ mark again to release the ✓ mark. ② Touch [OK] → [OK].
 (Set All in Date Range)	Protects all images in the date range or folder, or all AVCHD movies. Touch [OK] after step 2.
 (Set All in This Folder)	
 (Set All AVCHD files)	
 (Remove All in Date Range)	Unlocks all images in the date range or folder, or all AVCHD movies. Touch [OK] after step 2.
 (Remove All in This Folder)	
 (Remove All AVCHD files)	

Note

- When using internal memory, a Folder View is used with still images and movies displayed in the same folder.







DPOF

DPOF (Digital Print Order Format) is a function that allows you to specify the images of the memory card that you want to print out later.

The **DPOF** (Print order) mark is displayed for registered images.

- 1 Press the  (Playback) button to switch to playback mode.
- 2 **MENU** → **DPOF** → desired mode



DPOF  (This Image)	Orders printing the currently displayed image in single-image mode.
DPOF  (Multiple Images)	You can select and order printing multiple images. After step 2, perform the following. ① Select an image to be printed, then touch it. Repeat the above steps until there are no more images to be printed. Touch an image with a ✓ mark again to release the ✓ mark. ② Touch [OK] → [OK].
DPOF  (Set All in Date Range)	Sets print order for all images in the date range or folder. Touch [OK] after step 2.
DPOF  (Set All in This Folder)	
DPOF  (Remove All in Date Range)	Cancels print order for all images in the date range or folder. Touch [OK] after step 2.
DPOF  (Remove All in This Folder)	



Notes

- The **DPOF** (Print order) mark cannot be added to movies or to images in the internal memory.
- You can add a **DPOF** (Print order) mark to a maximum 999 images.

Rotate

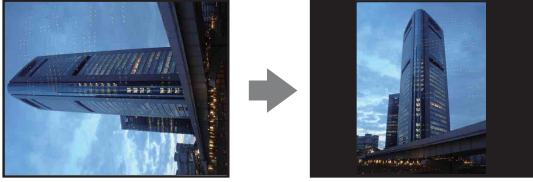
Rotates a still image. Use this function to display a horizontal orientation image in vertical orientation.



- 1 Press the  (Playback) button to switch to playback mode.
- 2 **MENU** →  (Rotate)
- 3  → [OK]









Notes

- You cannot rotate movies, images displayed in a burst group, and protected still images.
- You may not be able to rotate images shot with other cameras.
- When viewing images on a computer, the image rotation information may not be reflected depending on the software.



Volume Settings

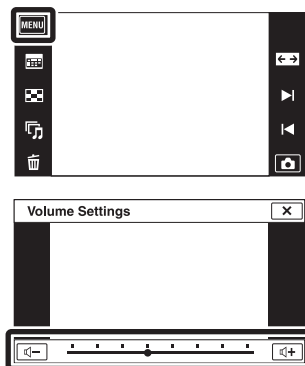

Adjusts the volume for slideshow and movie playback.

- 1 Press the  (Playback) button to switch to playback mode.
- 2 **MENU** →  (Volume Settings)
- 3 Adjust the volume by touching  /  → 
You can also adjust the volume by touching  in the volume adjustment bar and dragging to the right or left.





Adjusting the volume during playback of a movie or slideshow

Movie playback: Touch the LCD screen to display the operation buttons, then touch  and then  /  to adjust the volume.





Slideshow: Touch the screen to display the volume control screen, then touch the  /  buttons to adjust the volume.

Display Settings

Sets whether to display the operation buttons on the LCD screen in viewing mode.

- 1 Press the  (Playback) button to switch to playback mode.
- 2 **MENU** →  (Display Settings) → desired mode



✓	 (On)	Displays the operation buttons.	
	 (Off)	Does not display the operation buttons.	

 To display the operation buttons when [Display Settings] is set to [Off]

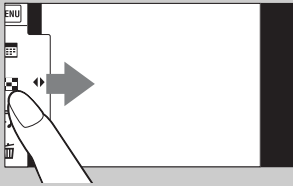



Touch the left side of the LCD screen and drag right to display the operation buttons.

Exposure data

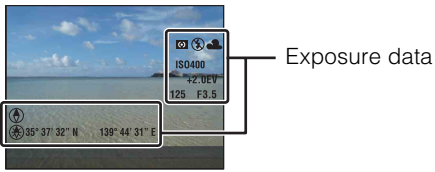
This sets whether or not to display the shooting data of the currently displayed file.



- 1 Press the  (Playback) button to switch to playback mode.
- 2 **MENU** →  (Exposure data) → desired mode

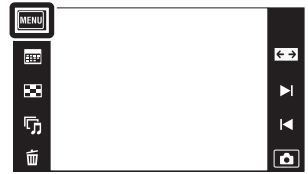







 (On)	Displays the shooting data on the LCD screen.
 (Off)	Does not display the shooting data.

Image index settings

Sets the number of images displayed in the index screen.

- 1 Press the  (Playback) button to switch to playback mode.
- 2 **MENU** →  (Image index settings) → desired mode







	 (12-up)	Displays 12-up images.
✓	 (28-up)	Displays 28-up images.

Select Folder

When multiple folders are created in a memory card, this function selects the folder containing the image you want to play back.

Step 2 is unnecessary when [Folder View] is already set.

- 1 Press the  (Playback) button to switch to playback mode.
- 2 **MENU** →  (View Mode) → [Folder view (Still)] or [Folder view (MP4)]
- 3 **MENU** →  (Select Folder) → select the folder with / → [OK]





Note

- This item is not displayed when the internal memory is used to record images.



Viewing images across multiple folders

When multiple folders are created and the first or last image in the folder is displayed, the following indicators appear.

- : Moves to the previous folder
- : Moves to the next folder
- : Moves to either the previous or next folders

Movie format

You can set the recording method used to record movies.

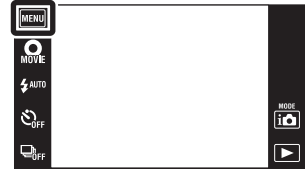

- 1 **MENU** →  (Settings) →  (Shooting Settings) → [Movie format] → desired mode



✓	AVCHD	This recording method is suitable for viewing smooth video images on a high-definition television. AVCHD movies are recorded.
	MP4	This recording method is suitable for WEB uploads and e-mail attachments. mp4 (AVC) movies are recorded.

AF Illuminator



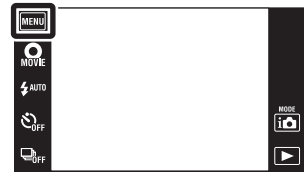

The AF illuminator supplies fill light to focus more easily on a subject in dark surroundings. The AF illuminator emits red light allowing the camera to focus easily when the shutter button is pressed halfway, until the focus is locked. The **AF-ON** indicator appears at this time.

- 1 **MENU** →  (Settings) →  (Shooting Settings) → [AF Illuminator] → desired mode





✓	Auto	Uses the AF illuminator.
	Off	Does not use AF illuminator.

Notes

- Focus is achieved as long as the AF illuminator light reaches the subject, regardless of whether light fails to reach the center of the subject.
- You cannot use the AF illuminator when:
 - Shooting in Intelligent Sweep Panorama mode
 -  (Landscape),  (Twilight),  (Pet),  (Fireworks) or  (Hi-Speed Shutter) mode is selected in Scene Selection.
 - [Housing] is set to [On].
 - [Self-Timer] is set to [Self-portrait One Person] or [Self-portrait Two People].
- When you use AF illuminator, the normal AF range finder frame is disabled and a new AF range finder frame is displayed by a dotted line. AF operates with priority on subjects located near the center of the frame.
- The AF illuminator emits very bright light. Although there is no health hazard, do not look directly into the AF illuminator emitter at close range.

Grid Line

With reference to the grid lines, you can easily set a subject in a horizontal/vertical position.



- 1 **MENU** →  (Settings) →  (Shooting Settings) → [Grid Line] → desired mode



	On	Displays the grid lines. The grid lines are not recorded.
✓	Off	Does not display the grid lines.

Digital Zoom

Selects the Digital Zoom mode. The camera enlarges the image using optical zoom (up to 4×). When the zoom scale is exceeded, the camera uses either smart or precision Digital Zoom.

- 1 **MENU** →  (Settings) →  (Shooting Settings) → [Digital Zoom] → desired mode



✓	Smart (sQ)	Enlarges the image digitally within the range where the image will not be distorted, according to the image size. (Smart zoom)
	Precision (PQ)	Enlarges all image sizes by the total zoom scale of approximately 8×, including the optical zoom 4×. However, note that the image quality deteriorates when the optical zoom scale is exceeded. (Precision digital zoom)
	Off	Does not use the Digital Zoom.

Notes

- The Digital Zoom function does not operate in the following situations:
 - In Intelligent Sweep Panorama mode
 - In Movie Mode
 - In Backlight Correction HDR mode
 - When the Smile Shutter function is activated
 - When [Self-Timer] is set to [Self-portrait One Person] or [Self-portrait Two People]
- The smart zoom is not available when the image size is set to [10M] or [16:9(7M)].
- The Face Detection function does not work when using the Digital Zoom.



Total zoom scale when using Smart zoom (including optical zoom 4×)

The supported zoom ratio differs depending on the image size.

Size	Total zoom scale
5M	Approx. 5.6×
VGA	Approx. 22×
16:9(2M)	Approx. 7.6×

Auto Orientation

When the camera is rotated to shoot a portrait (vertical) image, the camera records its position change and displays the image in the portrait position.

- 1 **MENU** →  (Settings) →  (Shooting Settings) → [Auto Orientation] → desired mode



✓	On	Records the image with the correct orientation.
	Off	Does not use Auto Orientation.

Notes

- Black is displayed to the left and right of vertical orientation images.
- Depending on the shooting angle of the camera, the orientation of the image may not be recorded correctly.
- You cannot use [Auto Orientation] when  (Underwater) is selected in the Scene Selection or when shooting movies.

Rotating images after recording



If the orientation of an image is incorrect, you can use the [Rotate] on the MENU screen to display the image in portrait position.

Scene Recog. Guide

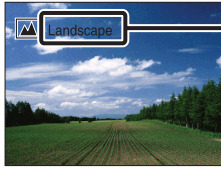
You can select whether or not the guide is displayed next to the Scene Recognition icon when Scene Recognition is activated.



Scene Recognition Guide

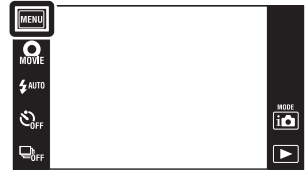

- 1 **MENU** →  (Settings) →  (Shooting Settings) → [Scene Recog. Guide] → desired mode



✓	On	Displays the Scene Recognition Guide.
	Off	Does not display the Scene Recognition Guide.

Red Eye Reduction

The flash strobescs two or more times before shooting to reduce the red-eye phenomenon when using the flash.

- 1 **MENU** →  (Settings) →  (Shooting Settings) → [Red Eye Reduction] → desired mode



✓	Auto	When the Face Detection function is activated, the flash strobescs automatically to reduce the red-eye phenomenon.
	On	The flash always strobescs to reduce the red-eye phenomenon.
	Off	Does not use Red Eye Reduction.

Notes

- To avoid blurring of images, hold the camera firmly until the shutter is released. It usually takes a second until the shutter is released, and also be sure not to allow the subject to move during this period.
- Red Eye Reduction may not produce the desired effects. It depends on individual differences and conditions, such as distance to the subject, or if the subject looked away from the pre-strobe.
- If you do not use the Face Detection function, Red Eye Reduction does not work, even when you select [Auto].
- [Red Eye Reduction] is set to [Off] in the following situations:
 - In Anti Motion Blur mode
 - In Hand-held Twilight mode
 - When Scene Selection is set to  (High Sensitivity) mode
 - When the Smile Shutter function is activated

What causes the red-eye phenomenon?

Pupils become dilated in dark environments. Flash light is reflected off the blood vessels at the back of the eye (retina), causing the “red-eye” phenomenon.

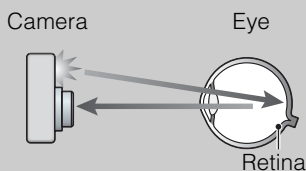



Other ways to reduce red-eye

- Select  (High Sensitivity) mode in Scene Selection. (The flash is automatically turned to [Off].)
- When the eyes of the subject turn out red, correct the image with [Retouch] → [Red Eye Correction] on the viewing menu or with the supplied software “PMB”.

Blink Alert

When an image with the subject's eyes closed is recorded while Face Detection is activated, the message "Blinked eye detected" is displayed on the LCD screen.



- 1 **MENU** →  (Settings) →  (Shooting Settings) → [Blink Alert] → desired mode



✓	Auto	Displays the "Blinked eye detected" message.
	Off	Does not display the message.

Beep

Selects or turns off the sound produced when you operate the camera.



- 1 **MENU** →  (Settings) →  (Main Settings) → [Beep] → desired mode



	Shutter	Turns on the shutter sound when you press the shutter button.
✓	High	Turns on the beep/shutter sound when you operate the touch panel/press the shutter button.
	Low	If you want to lower the volume, select [Low].
	Off	Turns off the beep/shutter sound.

LCD Brightness

This sets the brightness of the LCD screen.

- 1 **MENU** →  (Settings) →  (Main Settings) → [LCD Brightness] → desired mode

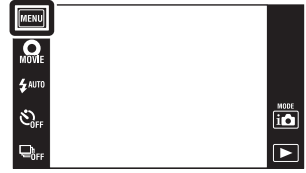



✓	Normal	Sets the LCD screen to normal brightness.
	Bright	Sets the LCD screen to high brightness. <ul style="list-style-type: none">• This function is useful when viewing images in bright outside light.

Notes

- In [Bright] mode, the battery power may decrease faster.
- If you do not operate the camera for a certain period of time while the power is on, the LCD screen becomes dark.
- In Movie Mode, [LCD Brightness] is set to [Normal].

Language Setting

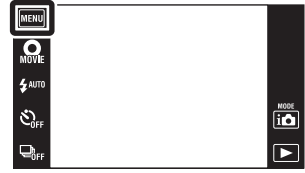

Selects the language to be used in the menu items, warnings and messages.

- 1 **MENU** →  (Settings) →  (Main Settings) → [Language Setting] → desired mode





Demo Mode

You can set whether to use a demonstration of the Scene Recognition and Smile Shutter. When there is no need to view a demonstration, set to [Off].

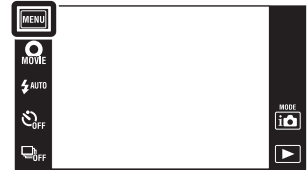
- 1 **MENU** →  (Settings) →  (Main Settings) → [Demo Mode] → desired mode



- 2  (REC Mode) →  (Intelligent Auto Adjustment)



	Demo Mode1	Demonstrates Scene Recognition mode.
	Demo Mode2	Automatically starts the Smile Shutter demonstration when no operation is performed for 15 seconds.
	Demo Mode3	If no operation is performed for a set period of time while the camera is connected to an HD TV with an HDMI Cable (sold separately), a demonstration of AVCHD movie playback will automatically be performed.
✓	Off	Does not perform a demonstration.



Note

- Pressing the shutter button during the Smile Shutter demonstration operates the shutter, but no image is recorded.

Initialize

Initializes the setting to the default setting.

Even if you execute this function, the images are retained.

- 1 **MENU** →  (Settings) →  (Main Settings) → [Initialize] → [OK]

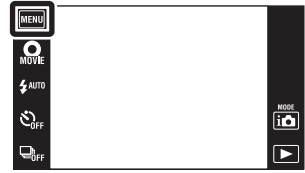



Note

- Be sure not to turn off the camera while initializing.

HDMI Resolution

Sets the resolution to be output to a TV from the HDMI terminal when you view images by connecting the multi-output stand (supplied) of this camera to the HDMI terminal of a High Definition TV using the HDMI Cable (sold separately).

- 1 **MENU** →  (Settings) →  (Main Settings) → [HDMI Resolution] → desired mode

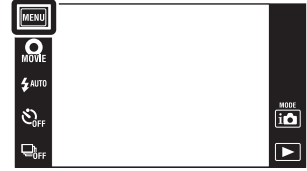



✓	Auto	The camera automatically recognizes an HD TV and sets the output resolution.
	1080i	Outputs signals in HD picture quality (1080i).
	480p/576p	Outputs signals in SD picture quality (480p/576p). <ul style="list-style-type: none">• If the camera is 1080 60i-compatible, signals are output using 480p, whereas if it is 1080 50i-compatible, signals are output using 576p.

Notes

- If you cannot display the screen properly with the [Auto] setting, select either [1080i] or [480p/576p] depending on the TV to be connected.
- When you shoot movies in the condition where the camera and a TV are connected using an HDMI Cable (sold separately), the image being shot is not displayed at the TV side.

CTRL FOR HDMI

This setting allows (TV) remote control of a camera that is connected to a “BRAVIA” Sync TV using the HDMI Cable (sold separately). For details on “BRAVIA” Sync, see page 128.

- 1 **MENU** →  (Settings) →  (Main Settings) → [CTRL FOR HDMI] → desired mode

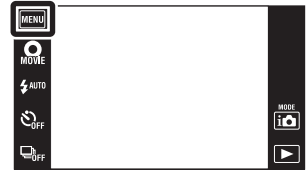



<input checked="" type="checkbox"/>	On	Enables remote-controlled operation.
<input type="checkbox"/>	Off	Disables remote-controlled operation.

Note

- You can perform the operation of the camera with the remote controller of your TV by connecting your camera to a “BRAVIA” Sync compatible TV.

COMPONENT

Selects the video signal output type from either SD or HD (1080i) in accordance with the type of TV you connect to the camera using an HD Output Adaptor Cable (sold separately). Use a Type2c-compliant HD Output Adaptor Cable (sold separately).

- 1 **MENU** →  (Settings) →  (Main Settings) → [COMPONENT] → desired mode





✓	HD(1080i)	Select this item to connect the camera to a 1080i-capable High Definition TV.
	SD	Select this item to connect the camera to a TV that is not compatible with an HD(1080i) signal.

Note

- When you shoot movies in the condition where the camera and a TV are connected using an HD Output Adaptor Cable (sold separately), the image being shot is not displayed at the TV side.

Housing

Displays the dedicated operation buttons when the camera is installed in the Housing (Marine Pack). Refer also to the operating instructions supplied with the Housing.

- 1 **MENU** →  (Settings) →  (Main Settings) → [Housing] → desired mode

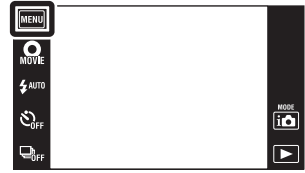



	On	Changes the function of the buttons.
✓	Off	Does not change any functions.

Notes

- Objects cannot be brought into focus by touching the screen.
- Some functions are limited, and the icon positions on the LCD screen change.

USB Connect

Sets the mode when the camera is connected to a computer or a PictBridge-compliant printer using the USB cable.

- 1 **MENU** →  (Settings) →  (Main Settings) → [USB Connect] → desired mode





✓	Auto	The camera recognizes automatically and sets up communication with a computer or PictBridge-compliant printer.
	PictBridge	Connects the camera to a PictBridge-compliant printer.
	PTP/MTP	When you connect the camera to a computer, the AutoPlay Wizard appears, and the still images in the recording folder on the camera are imported to the computer (with Windows 7/Vista/XP, Mac OS X).
	Mass Storage	Establishes a Mass Storage connection between the camera and a computer or other USB device.

Notes

- If you cannot connect the camera to a PictBridge-compliant printer with the [Auto] setting, select [PictBridge].
- If you cannot connect the camera to a computer or a USB device with the [Auto] setting, select [Mass Storage].
- You cannot import movies when [PTP/MTP] is selected. To import movies to the computer, select [Auto] or [Mass Storage].

LUN Settings

Sets the display method for the recording media displayed on a computer screen or other monitor when the camera is connected with a computer or AV component using a USB connection.

- 1 **MENU** →  (Settings) →  (Main Settings) → [LUN Settings] → desired mode





✓	Multi	The images both on the memory card and in the internal memory are displayed. Select this setting when you connect the camera to a computer.
	Single	When the memory card is inserted into the camera, the images on the memory card are displayed; when it is not inserted, the images in the internal memory are displayed. Select this setting in cases where the images of both the memory card and the internal memory are not displayed when the camera is connected to a device other than a computer.

Note

- Set [LUN Settings] to [Multi] when uploading images to a media service using “PMB Portable”.

Download Music

You can use “Music Transfer” in the CD-ROM (supplied) to change background music tracks.

- 1 **MENU** →  (Settings) →  (Main Settings) → [Download Music]



The message “Change slideshow music Connect to PC” is displayed.

- 2 Make a USB connection between the camera and a computer, then start “Music Transfer”.
- 3 Follow the instructions on the screen to change music files.



Format Music

You can delete all the background music files stored in the camera. It can be used in cases such as when the background music files are damaged and cannot be played.

- 1 **MENU** →  (Settings) →  (Main Settings) → [Format Music] → [OK]





Restoring the music preset at the factory to the camera

You can use “Music Transfer” in the CD-ROM (supplied) to reset music files to the preset ones.

- ① Execute [Download Music], then make a USB connection between the camera and a computer.
- ② Start “Music Transfer”, then restore the default music.
 - For details on using “Music Transfer”, see the help in “Music Transfer”.

Power Save

Sets the length of time until the LCD screen goes dark and the time until the camera turns off. If you do not operate the camera for a certain period of time while the power is on using the battery pack, the screen goes dark and the camera later turns off automatically to prevent wearing down the battery pack (Auto power-off function).

- 1 **MENU** →  (Settings) →  (Main Settings) → [Power Save] → desired mode





	Stamina	The LCD screen automatically goes dark if the camera is not operated for about 30 seconds, and the power turns off if the camera is not operated for about 30 seconds more.
✓	Standard	The LCD screen automatically goes dark if the camera is not operated for about 1 minute, and the power turns off if the camera is not operated for about 1 minute more.
	Off	The LCD screen does not darken and the camera does not turn off automatically.

TransferJet

You can select TransferJet communication settings. TransferJet is a close-up, wireless transfer technology that allows data to be transferred by closely aligning two products that you want to communicate with each other. To find out whether your camera is equipped with the TransferJet function, check for the  (TransferJet) mark on the bottom of the camera.

Using a Memory Stick with TransferJet (sold separately) allows images to be transferred between TransferJet-compatible devices.

For more details on TransferJet, see the Operating Instructions supplied with Memory Stick with TransferJet.

- 1 **MENU** →  (Settings) →  (Main Settings) → [TransferJet] → desired mode





<input checked="" type="checkbox"/>	On	Communicates using TransferJet.
<input type="checkbox"/>	Off	Does not communicate using TransferJet.

Notes

- [TransferJet] is always set to [Off] during Easy Mode.
- While aboard an airplane, set [TransferJet] to [Off]. In other cases, always follow all regulations governing the location in which the camera is being used.
- The connection is cut if transfer cannot be made within about 30 seconds. If this happens, select [Yes] and again align two  (TransferJet) marks on the camera and another device.
- Memory Stick with TransferJet and camera models with TransferJet are not sold in some countries and regions due to local laws and regulations.
- Set the [TransferJet] function to [Off] in countries and regions other than where you purchased your camera. Depending on the country or region, if you use the TransferJet function, you may be liable due to local restrictions on transmission of electromagnetic waves.

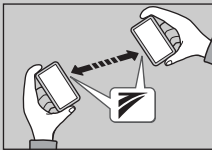
What is TransferJet?





TransferJet allows you to share images by sending and receiving image data. Insert a Memory Stick with TransferJet in your camera and align two  (TransferJet) marks of the camera and another device that supports this function.

For details on image transfer, see page 79.

Calibration

Enables you to perform calibration when the touch panel buttons do not react at the appropriate points where you touch.

- 1 **MENU** →  (Settings) →  (Main Settings) → [Calibration]

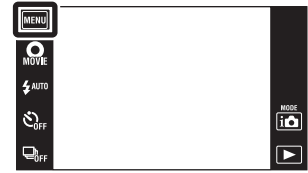

- 2 Using the paint pen, touch the center of the × mark displayed on the screen in order.

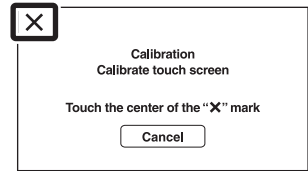



Notes

- To stop the calibration process mid-way, touch [Cancel]. The adjustments made up to that point are not effected.
- If you fail to touch the right spot, the calibration is not performed. Touch the center of the × mark again.

Format

Formats the memory card or the internal memory. To ensure stable operations of the memory card, we recommend that you use this camera to format any memory card being used with this camera for the first time. Note that formatting will erase all data recorded on the memory card. This data cannot be restored. Be sure to back-up any important data to a PC or other storage location.

- 1 **MENU** →  (Settings) →  (Memory Card Tool) or  (Internal Memory Tool) → [Format] → [OK]





Note

- Note that formatting permanently erases all data including even protected images.

Create REC.Folder

Creates a folder in a memory card to store recorded images.

Images are recorded in the newly created folder until you create another folder or select another recording folder.

- 1 **MENU** →  (Settings) →  (Memory Card Tool) → [Create REC.Folder] → [OK]



Notes

- This item is not displayed when the internal memory is used to record images.
- When you insert a memory card that was used with other equipment into the camera and shoot images, a new folder may be automatically created.
- Up to 4,000 images can be stored in one folder. When the folder capacity is exceeded, a new folder is automatically created.





On the folders



- After a new folder is created, you can change the storage destination folder (page 119) and select the folder for viewing images (page 92).

Change REC.Folder

Changes the folder in the memory card that is currently used to store recorded images.

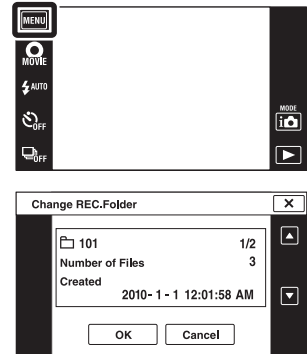
1 **MENU** →  (Settings) →  (Memory Card Tool) → [Change REC.Folder]





2 Select the folder in which you want to store images using / → [OK].

Notes



- This item is not displayed when the internal memory is used to record images.
- You cannot select the following folder as a recording folder.
 - “100” folder
 - A folder with a number that has either “□□□MSDCF” or “□□□ANV01” only.
- You cannot move recorded images to another folder.

Delete REC.Folder

Deletes the folder in a memory card that is used to store recorded images.

1 **MENU** →  (Settings) →  (Memory Card Tool) → [Delete REC.Folder]



2 Select the folder you want to delete using / → [OK].

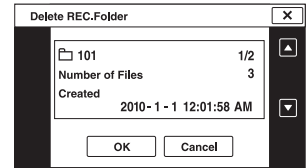



Notes

- This item is not displayed when the internal memory is used to record images.
- If you delete the folder set as the recording folder using [Delete REC.Folder], the folder that has the largest folder number is selected as the next recording folder.
- You can delete only empty folders. If a folder contains images, or even files that cannot be played back by the camera, first delete these images and files, and then delete the folder.

Copy

Copies all images in the internal memory to a memory card.

- 1 Insert a memory card with sufficient free capacity into the camera.
- 2 **MENU** →  (Settings) →  (Memory Card Tool) → [Copy] → [OK]

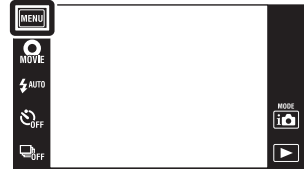



Notes

- Use a fully charged battery pack. If you attempt to copy image files using a battery pack with little remaining charge, the battery pack may run out, causing copying to fail or possibly corrupting the data.
- You cannot copy images individually.
- The original images in the internal memory are retained even after copying. To delete the contents of the internal memory, remove the memory card after copying, then format the internal memory ([Format] in [Internal Memory Tool]).
- A new folder is created on the memory card and all the data will be copied to it. You cannot choose a specific folder and copy images to it.

File Number

Selects the method used to assign file numbers to images.

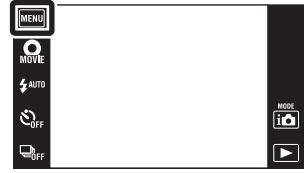

- 1 **MENU** →  (Settings) →  (Memory Card Tool) or  (Internal Memory Tool) → [File Number] → desired mode



✓	Series	Assigns numbers to files in sequence even if the recording folder or the memory card is changed. (When the replaced memory card contains a file with a number higher than the last assigned number, a number one higher than the largest number is assigned.)
	Reset	Starts from 0001 each time the folder is changed. (When the recording folder contains a file, a number one higher than the largest number is assigned.)

Area Setting

Adjusts the time to the local time of a selected area.

- 1 **MENU** →  (Settings) →  (Clock Settings) → [Area Setting] → desired mode





✓	Home	You use the camera in your area. When the currently set area differs from your home area, you must make the Area Setting.
	Destination	You use the camera set to the time at your destination. Set the destination area.

Changing Area Setting

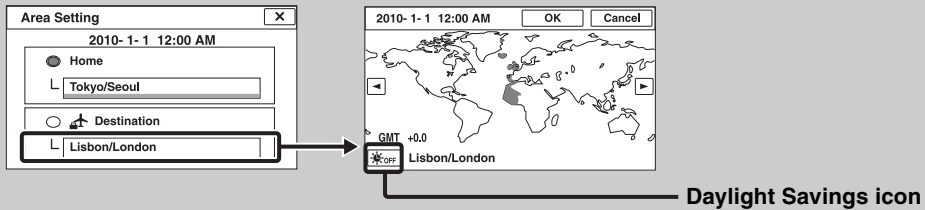

Setting a frequently visited destination lets you easily adjust the time when you visit that destination.



- ① Touch the “Destination” area.
- ② Select the area using  / .
- ③ Touch Daylight Savings icon, then select Daylight Savings On/Off.
- ④ Touch [OK].

Date & Time Setting

Sets the date and time again.

- 1 **MENU** →  (Settings) →  (Clock Settings)
→ [Date & Time Setting] → desired mode



Date & Time Format	You can select the date and time display format.
Daylight Savings	You can select Daylight Savings [On]/[Off].
Date & Time	You can set the date and time.

Note

- The camera does not have a feature for superimposing dates on images. By using “PMB” in the CD-ROM (supplied), you can print or save images with the date.

Viewing an image on a Standard Definition (SD) TV

You can view images recorded on the camera in standard picture quality by connecting the camera to a Standard Definition (SD) TV. Refer also to the operating instructions supplied with the TV.

- 1 Turn off both the camera and the TV.
- 2 Attach the camera to the multi-output stand (supplied).
- 3 Connect the multi-output stand to the TV using the AV Cable (supplied).

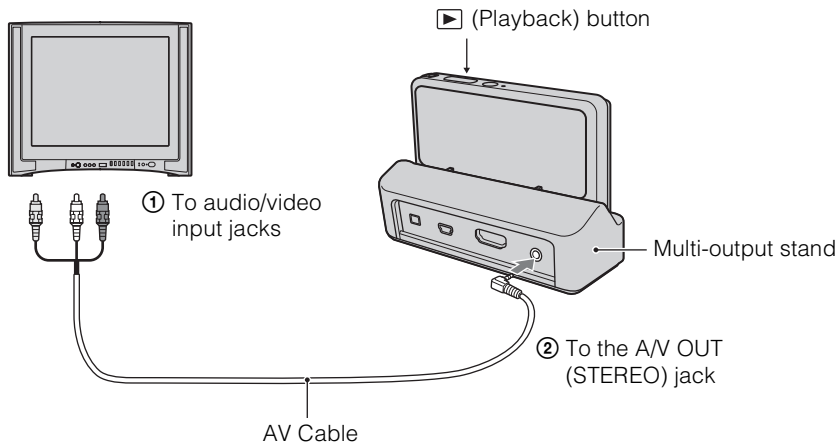

- 4 Turn on the TV and set the input.
- 5 Press **▶** (Playback) button to turn on the camera.

Images shot with the camera appear on the TV. Touch **▶/◀** displayed on the LCD screen of this camera to select the desired image.

Notes

- When you play back a single image, no icons are displayed on the TV.
- You cannot play back images in [Easy Mode] during TV output.
- When you shoot movies while the camera and a TV are connected, the image being shot is not displayed on the TV.

Viewing an image on a High Definition (HD) TV

You can view images recorded on the camera in high picture quality by connecting the camera to a High Definition (HD) TV using the HDMI Cable (sold separately) or HD Output Adaptor Cable (sold separately). Use a Type2c-compliant HD Output Adaptor Cable. Refer also to the operating instructions supplied with the TV.

- 1 Turn off both the camera and the HD TV.
- 2 Connect the camera to the TV using the HDMI Cable (sold separately) or HD Output Adaptor Cable (sold separately).

Notes

- When you play back a single image, no icons are displayed on the TV.
- You cannot play back images in [Easy Mode] during TV output.
- Images shot in [VGA] image size cannot be played back in the HD format.
- When you shoot movies while the camera and a TV are connected using an HDMI Cable (sold separately), or HD Output Adaptor Cable (sold separately) the image being shot is not displayed on the TV.



“PhotoTV HD”

This camera is compatible with the “PhotoTV HD” standard.

By connecting a Sony TV compatible with “PhotoTV HD” using an HDMI Cable (sold separately) or HD Output Adaptor Cable (sold separately), a whole new world of photos can be comfortably enjoyed in breathtaking Full HD quality.

- PhotoTV HD allows for a highly-detailed, photo-like expression of subtle textures and colors.
- When the camera is connected to a Sony TV compatible with Video A mode using an HDMI Cable, your TV is automatically set to the picture quality suitable for still images. When the setting of the TV is set to Video, the picture quality is set to that suitable for movies.
- For details, see the operating instructions of the TV.

Viewing an image by connecting the camera to an HD TV using the HDMI Cable (sold separately)

Connect the camera to the HDMI terminal of an HD TV using the HDMI Cable (sold separately).

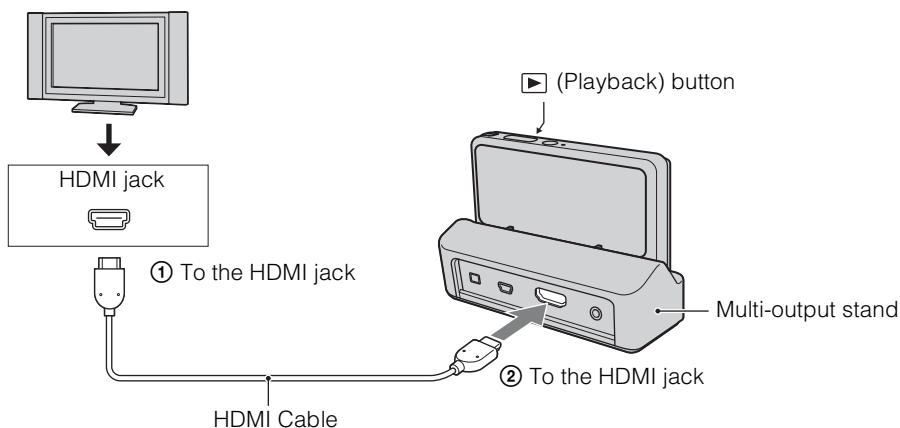

- 1 Attach the camera to the multi-output stand (supplied).
- 2 Connect the multi-output stand to the TV using the HDMI Cable (sold separately).



- 3 Turn on the TV and set the input.
- 4 Press  (Playback) button to turn on the camera.



Images shot with the camera appear on the TV. Touch /|/| displayed on the LCD screen of this camera to select the desired image.

Notes

- Touch **MENU** →  (Settings) →  (Main Settings) to select [Auto] or [1080i] for [HDMI Resolution].
- The beep sound is fixed to [Shutter].
- Do not connect the camera and equipment to be connected using output terminals. When the camera and TV are connected using output terminals, no video and sound are produced. Such a connection can also cause trouble of the camera and/or connected equipment.
- This function may not work properly with some HD TVs. For example, you may not be able to view a video on your HD TV or hear sound from the HD TV.
- Use an HDMI Cable with the HDMI logo.
- Recording may automatically stop to protect the camera after a period of time when you shoot movies in the condition where the camera and TV are connected by an HDMI Cable (sold separately).



Using “BRAVIA” Sync

When you use a TV that has “BRAVIA” Sync (compatible with SYNC MENU) support, you can operate the playback functions of the camera using the remote controller supplied with the TV by connecting the camera to the TV using the HDMI Cable (sold separately).

- 1 Attach the camera to the multi-output stand (supplied).
- 2 Connect the multi-output stand to the TV using an HDMI Cable (sold separately).
- 3 Turn on the TV and set the input.
- 4 Press the  (playback) button of the camera to turn on the camera.
- 5 **MENU** →  (Settings) →  (Main Settings) → [CTRL FOR HDMI] → [On]
- 6 Press the SYNC MENU button of the TV’s remote controller to select the desired mode.

Menu	Function
Slideshow with music	Automatically plays back images with sound effects or background music in a continuous loop.
Single Image	Plays back a single image at a time.
Image Index	Displays multiple images at the same time.
Wide Zoom	Plays back 4:3 aspect ratio still images in 16:9 aspect ratio when you view a single image. In that case, the top and bottom of the image will be slightly cropped.
Delete	Deletes recorded images.
Playback Zoom	Plays back enlarged images.
Rotate	Rotates a still image.
View Mode	Selects the display format for viewing multiple images.

Notes

- When the camera is connected to a TV set using an HDMI Cable, the functions that you can operate are limited.
- When you touch the LCD screen of the camera while you operate the remote controller, the remote controller operation is temporarily interrupted.
- You can perform the operation of the camera with the remote controller of your TV by connecting your camera to a “BRAVIA” Sync compatible TV. For details, see the operating instructions of the TV.
- If the camera functions in an undesired manner when controlling with the TV’s remote controller, such as when connected via HDMI to another manufacturer’s TV, touch **MENU** →  (Settings) →  (Main Settings) → [CTRL FOR HDMI] → [Off].

Viewing an image by connecting the camera to an HD TV using the HD Output Adaptor Cable (sold separately)



Connect the camera to an HD (High Definition) TV using the HD Output Adaptor Cable (sold separately).

Use a Type2c-compliant HD Output Adaptor Cable.

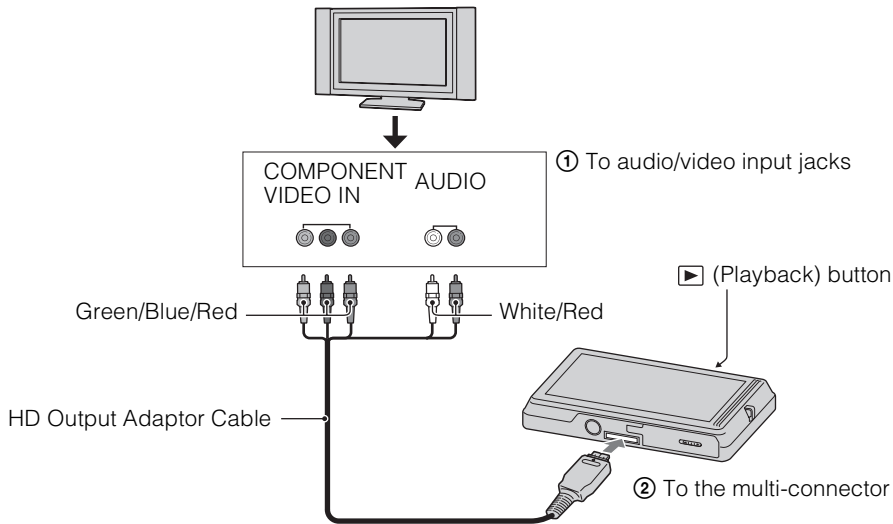

- 1 Connect the camera to the TV using a HD Output Adaptor Cable (sold separately).



- 2 Turn on the TV and set the input.
- 3 Press  (Playback) button to turn on the camera.

Images shot with the camera appear on the TV. Touch /  on the LCD screen of the camera to select the desired image.

Note

- Before you use this function, select **MENU** →  (Settings) →  (Main Settings) to select [HD(1080i)] for [COMPONENT].

Using with your computer

“PMB” and other applications are contained on the CD-ROM (supplied) to allow more versatile use of images shot with your Cyber-shot camera.

Recommended computer environment (Windows)

The following computer environment is recommended when using the supplied software “PMB”, “Music Transfer” and “PMB Portable” or importing images via a USB connection.

OS (pre-installed)	Microsoft Windows XP* ¹ SP3/Windows Vista* ² SP2/ Windows 7
Others	CPU: Intel Pentium III 800 MHz or faster (For playing/ editing the High Definition movies: Intel Core Duo 1.66 GHz or faster/ Intel Core 2 Duo 1.66 GHz or faster) Memory: 512 MB or more (For playing/editing the High Definition movies: 1 GB or more) Hard Disk: Disk space required for installation— approximately 500 MB Display: Screen resolution: 1,024 × 768 dots or more

*¹ 64-bit editions and Starter (Edition) are not supported.

Windows Image Mastering API (IMAPI) Ver.2.0 or later is required to use the function for creating discs.

*² Starter (Edition) is not supported.

Recommended computer environment (Macintosh)

The following computer environment is recommended when using the supplied software “Music Transfer” and “PMB Portable” or importing images via a USB connection.

OS (pre-installed)	USB Connection: Mac OS X (v10.3 to v10.6) Music Transfer/PMB Portable: Mac OS X (v10.4 to v10.6)
---------------------------	---

Notes

- Operation is not assured in an environment based on an upgrade of the operating systems described above or in a multi-boot environment.
- If you connect two or more USB devices to a single computer at the same time, some devices, including the camera, may not operate, depending on the types of USB devices you are using.
- Connecting the camera using a USB interface that is compatible with Hi-Speed USB (USB 2.0 compliant) allows advanced transfer (high speed transfer), as the camera is compatible with Hi-Speed USB (USB 2.0 compliant).
- When your computer resumes activity from suspend or sleep mode, communication between the camera and your computer may not recover at the same time.

Using the software

Installing “PMB (Picture Motion Browser)” and “Music Transfer” (Windows)

1 Turn on your computer and insert the CD-ROM (supplied) into the CD-ROM drive.

The installation menu screen appears.

- If it does not appear, double-click [Computer] (in Windows XP, [My Computer]) →  (SONYPMB).
- If the AutoPlay screen appears, select “Run Install.exe” and follow the instructions that appear on the screen to proceed with the installation.

2 Click [Install].

The “Choose Setup Language” screen appears.

3 Select the desired language, then proceed to the following screen.

The “License Agreement” screen appears.





4 Carefully read the agreement, click the radio button (○ → ●) to accept the terms of the agreement, and then click [Next].

5 Follow the instructions on the screen to complete the installation.

- To install, connect the camera and PC in the middle of installation (page 133).
- When the restarting confirmation message appears, restart the computer following the instructions on the screen.
- DirectX may be installed depending on the system environment of your computer.

6 Remove the CD-ROM after the installation is complete.

7 Start up the software.

- To start up “PMB,” click  (PMB) on the desktop. For the detailed operation method, see PMB support page (<http://www.sony.co.jp/pmb-se/>) (English only) or  (PMB Help).
- To start up “PMB” from the Start menu, select [Start] → [All Programs] →  (PMB).
- If “PMB” was installed on your computer and if you re-install “PMB” using the supplied CD-ROM, you can start up all the applications from “PMB Launcher.” To start up “PMB Launcher,” double-click  (PMB Launcher) on the desktop.

Notes

- Log on as Administrator.
- When “PMB” is started up for the first time, the confirmation message of the Information tool appears on the screen. Select [Start].

Installing “Music Transfer” (Macintosh)

- 1 Turn on your Macintosh computer, and insert the CD-ROM (supplied) into the CD-ROM drive.
- 2 Double-click  (SONYPMB).
- 3 Double-click the [MusicTransfer.pkg] file in the [Mac] folder.
The installation of the software starts.

Notes



- “PMB” is not compatible with Macintosh computers.
- Shut down all other application software before you install “Music Transfer”.
- For installation, you need to log on as Administrator.

Introduction to “PMB”

- “PMB” allows you to import images shot with the camera to a computer for display. Make a USB connection between the camera and your computer, and click [Import].
- Images on a computer can be exported to a memory card, and displayed on the camera. Make a USB connection between the camera and your computer, click [Export] → [Easy Export (PC Sync)] in the [Manipulate] menu, and click [Export].
- You can save and print images with the date.
- You can display images stored on a computer by shooting date in a calendar display.
- You can correct (Red Eye Reduction, etc.) still images, and change the shooting date and time.
- You can create discs with CD or DVD disc-writing drive.
- Blu-ray discs, AVCHD discs and DVD-Video discs can be created from AVCHD movies imported to a PC. (An environment that provides Internet connectivity is required when creating a Blu-ray disc or DVD-Video disc for the first time.)
- You can upload images to a network service. (An internet connection environment is required.)
- For other details, see  (PMB Help).

Introduction to “Music Transfer”

“Music Transfer” allows you to replace the Music files provided in the camera at the factory with your favorite tracks, and to delete and add Music files.
You can also restore the tracks stored at the factory to your camera.

- The following track types can be imported using “Music Transfer”.
 - MP3 files stored on the hard disk of your computer
 - Music CD tracks
 - Preset-music saved on the camera
- Before starting up “Music Transfer,” perform **MENU** →  (Settings) →  (Main Settings) → [Download Music], and connect the camera to the computer.

For other details, see the help in “Music Transfer”.

Connecting the camera to a computer

- 1 Insert a sufficiently charged battery pack into the camera, or connect an AC-LS5 AC Adaptor (sold separately) to the multi-output stand (supplied) and a wall outlet (wall socket), and attach the camera to the multi-output stand.
- 2 Turn on the computer, then press  (Playback) button.
- 3 Connect the camera to your computer.
 - When a USB connection is established for the first time, your computer automatically runs a program to recognize the camera. Wait for a while.

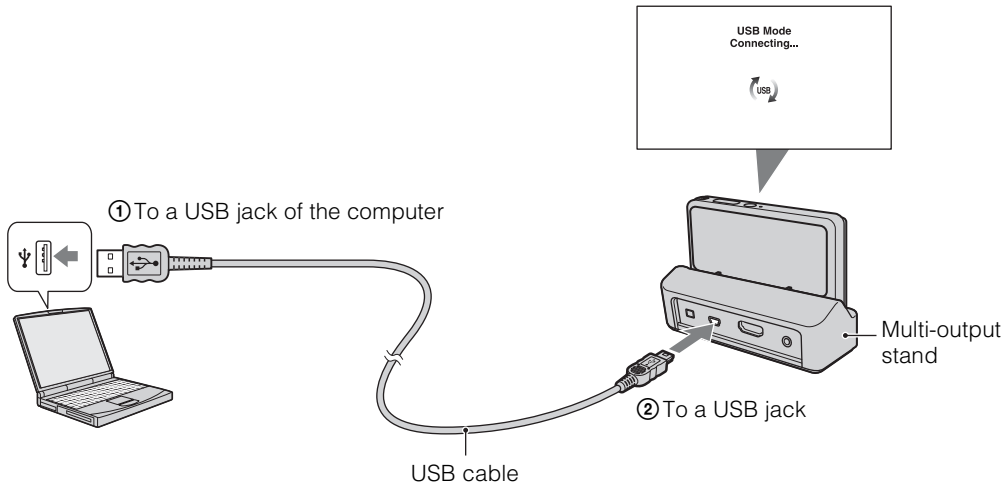

Importing images to a computer (Windows)

“PMB” allows you to easily import images.
For details on “PMB” functions, see the “PMB Help”.

Importing images to a computer without using “PMB”

When the AutoPlay Wizard appears after making a USB connection between the camera and a computer, click [Open folder to view files] → [OK] → [DCIM] or [MP_ROOT] → copy the desired images to the computer.

Notes

- Use “PMB” for operations such as when importing AVCHD movies to a computer.
- If operations are performed on an AVCHD movie file or folder on the camera from a PC while the camera is connected to a PC, it may destroy the image file or playback may become impossible. Do not delete or copy AVCHD movies on the camera’s memory card from a PC. Sony bears no responsibility for the result of operations of this type.

Importing images to a computer (Macintosh)

- 1 Connect the camera to your Macintosh computer first. Double-click the newly recognized icon on the desktop → the folder where the images you want to import are stored.
- 2 Drag and drop the image files to the hard disk icon.
The image files are copied to the hard disk.
- 3 Double-click the hard disk icon → the desired image file in the folder containing the copied files.
The image is displayed.

Deleting the USB connection

Perform the procedures from step 1 to 3 below before:

- Disconnecting the USB cable.
- Removing a memory card.
- Inserting a memory card into the camera after copying images from the internal memory.
- Turning off the camera.

- 1 Double-click the disconnect icon on the tasktray.
- 2 Click  (USB Mass Storage Device) → [Stop].
- 3 Confirm the device on the confirmation window, then click [OK].

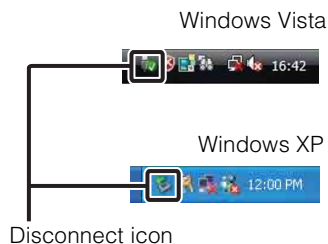

Note

- Drag and drop the icon of the memory card or the drive icon to the “Trash” icon beforehand when you use a Macintosh computer, and the camera is disconnected from the computer.

Uploading images to a media service

This camera has a built-in application “PMB Portable”.

You can use this application to do the following:

- You can easily upload images to a blog or other media service.
- You can upload images from a computer connected to the Internet even when you are away from home or the office.
- You can easily register the media services (such as blogs) you use frequently.

For details on “PMB Portable”, see the “PMB Portable” help.

Starting up PMB Portable (Windows)

When using “PMB Portable” for the first time, you must select the language. Follow the procedure below to make the selection. Once the language selection has been made, steps 3 to 5 are unnecessary the next time you use “PMB Portable”.

1 Make a USB connection between the camera and a computer.

When you connect the camera and your computer, AutoPlay Wizard appears.

Click [×] to close the AutoPlay Wizard for any unnecessary drives.

- If the desired AutoPlay Wizard does not appear, click [Computer] (in Windows XP, [My Computer]) → [PMBPORTABLE], then double-click “PMBP_Win.exe”.

2 Click “PMB Portable”.

(In Windows XP, click “PMB Portable” → [OK].)

- If “PMB Portable” is not displayed within the AutoPlay Wizard, click [Computer] → [PMBPORTABLE], then double-click “PMBP_Win.exe”.

The Language Selection screen appears.

3 Select the desired language, then click [OK].

The Region Selection screen appears.

4 Select the appropriate [Region] and [Country/Area], and then click [OK].

The User Agreement screen appears.

5 Read the agreement carefully. If you accept the terms of the agreement, click [I Agree].

“PMB Portable” starts up.

Starting up PMB Portable (Macintosh)

- 1 Make a USB connection between the camera and a computer.
When you connect the camera and your computer, [PMBPORTABLE] appears on the desktop. Click [×] for any unnecessary drives.
- 2 Click [PMBP_Mac] in the [PMBPORTABLE] folder.
The Region Selection screen appears.
- 3 Select the appropriate [Region] and [Country/Area], and then click [OK].
The User Agreement screen appears.
- 4 Read the agreement carefully. If you accept the terms of the agreement, click [I Agree].
“PMB Portable” starts up.

Notes

- “PMB Portable” is not supported for AVCHD movies.
- Set [LUN Settings] in [Main Settings] to [Multi].
- Always connect to a network when using “PMB Portable”.
- When uploading images over the Internet, the cache may remain in the computer being used depending on the service provider. This is also true when this camera is used for this purpose.
- When a bug occurs in “PMB Portable” or you delete “PMB Portable” by mistake, you can repair “PMB Portable” by downloading the PMB Portable installer from the web site.

Notes on “PMB Portable”

“PMB Portable” makes it possible to download the URLs of a number of websites from the server administered by Sony (the “Sony server”).

In order to use “PMB Portable” to enjoy the benefits of the image uploading service or other services (the “services”) provided by these and other websites, you must consent to the following.

- Some websites require registration procedures and/or fees to use their services. In using such services, you must comply with the terms and conditions established by the websites concerned.
- Services may be terminated or changed in accordance with the convenience of the website operators. Sony will not be held responsible for any trouble occurring between the users and third parties or any inconvenience caused to users relating to the utilization of the services inclusive of the termination of or changes to such services.
- To view a website, you will be redirected to it by the Sony server. There may be times when you cannot access the website because of server maintenance or for other reasons.
- If the operation of the Sony server is to be terminated, you will be notified of the termination ahead of time on Sony website, etc.
- The URLs to which you are redirected by the Sony server and other information may be recorded for the purposes of improving Sony future products and services. However, no personal data will be recorded on such occasions.

Creating a disc of movies



You can create a disc from AVCHD movies that have been recorded with this camera.

Selecting the method for creating a disc of movies

Select the method that suits your disc player.

For details on the method for creating a disc using “PMB”, see “PMB Help.”

To import movies into a PC, see page 133.

Player	Creation method	Disc type
Blu-ray disc playback devices (Blu-ray disc player, PlayStation®3, etc.)	Importing movies to a computer using “PMB” and creating a Blu-ray disc	
AVCHD format playback devices (Sony Blu-ray disc player, PlayStation®3, etc.)	Importing movies to a computer using “PMB” and creating an AVCHD format disc	
	Creating an AVCHD format disc using a DVD Writer/Recorder other than DVDirect Express	
Ordinary DVD playback devices (DVD player, computer that can play DVDs, etc.)	Importing movies to a computer using “PMB” and creating a standard definition image quality (SD) disc	

Notes

- If you create a disc using Sony DVDirect (DVD Writer), use the memory card slot of the DVD Writer or connect the DVD Writer via USB connection to transfer the data.
- If you use Sony DVDirect (DVD Writer), check that the firmware is updated to the newest version. For details, see the following URL:
<http://sony.storagesupport.com/>

Characteristics of each type of disc



Using a Blu-ray disc enables you to record high-definition image quality (HD) movies of a longer duration than DVD discs.



High-definition image quality (HD) movies can be recorded on DVD media, such as DVD-R discs, and a high-definition image quality (HD) disc is created.

- You can play a high-definition image quality (HD) disc on AVCHD format playback devices, such as a Sony Blu-ray disc player and a PlayStation®3. You cannot play the disc on ordinary DVD players.



Standard definition image quality (SD) movies converted from high-definition image quality (HD) movies can be recorded on DVD media, such as DVD-R discs, and a standard definition image quality (SD) disc is created.

Types of discs that can be used with “PMB”

The following 12-cm discs can be used with “PMB”. For information on Blu-ray discs, see page 138.

Disc type	Characteristics
DVD-R/ DVD+R/ DVD+R DL	Cannot be re-written.
DVD-RW/ DVD+RW	Can be re-written and used again.

- Always update to the latest available version of PlayStation®3 system software.
- The PlayStation®3 may not be available in some countries/regions.

Creating AVCHD discs

An AVCHD disc with HD picture quality can be created from AVCHD movies imported to a PC using supplied “PMB” software.

- 1 Turn on the power of the PC and insert an unused disc in the DVD drive.
- 2 Start “PMB”.
- 3 Select the AVCHD movie to be written to the disc.
- 4 Click  , then select [Create AVCHD Format Discs (HD)].
- 5 Create the disc by following the on-screen instructions.

Notes

- Be sure that “PMB” has been installed ahead of time (page 131).
- Still images and MP4 movies cannot be recorded on an AVCHD disc.
- Disc creation may take time.

Playing an AVCHD disc on a PC

AVCHD discs can be played on a PC using “Player for AVCHD” installed along with “PMB”. To start the software, click on [Start] → [All Programs] → [PMB] → [PMB Launcher] → [View] → [Player for AVCHD].

For detailed operations, see the Help for “Player for AVCHD”.

- Images may not play back smoothly depending on the PC environment.

Creating Blu-ray discs

You can create Blu-ray discs from AVCHD movies imported to a PC.

The PC in question must be capable of creating Blu-ray discs. BD-R (not re-writable) or BD-RE (re-writable) discs can be used. Multi-session recordings cannot be made.

To create Blu-ray discs, be sure to install [BD add-on software] on the “PMB” installation screen. To install, your PC must be connected to the Internet.

For detailed operations, see “PMB Help”.

Creating standard definition image quality (SD) discs

DVD discs with standard definition image quality (SD) can be created using supplied “PMB” software and selecting an AVCHD movie imported to the PC.

- 1 Turn on the power of the PC and insert an unused disc in the DVD drive.
 - If software other than “PMB” starts automatically, exit that software.
- 2 Start “PMB”.
- 3 Select the AVCHD movie to be written to the disc.
- 4 Click , then select [Create DVD-Video Format Discs (STD)].
- 5 Create the disc by following the on-screen instructions.

Notes

- Be sure that “PMB” has been installed ahead of time (page 131).
- Discs cannot be created for MP4 movies.
- Disc creation may take time due to converting the AVCHD movie to standard definition image quality (SD).
- The PC must be connected to the Internet the first time a DVD-Video disc is created.

Printing still images

You can print still images using the following methods.

- Printing directly using a PictBridge-compliant printer
- Printing directly using a memory card-compliant printer
For details, see the operating instructions supplied with the printer.
- Printing using a computer
You can import images to a computer using the supplied “PMB” software and print the images. You can insert the date on the image and print it.
For details, see the “PMB Help”.
- Printing at a shop (page 142)

Notes

- When you print images shot in 16:9 mode, both edges may be cut off.
- You cannot print panoramic images depending on the printer.

Printing images directly using a PictBridge-compliant printer

Even if you do not have a computer, you can print images shot using the camera by connecting the camera directly to a PictBridge-compliant printer.

PictBridge “PictBridge” is based on the CIPA standard. (CIPA: Camera & Imaging Products Association)

- 1 Insert a sufficiently charged battery pack into the camera.
- 2 Connect the camera to the printer.

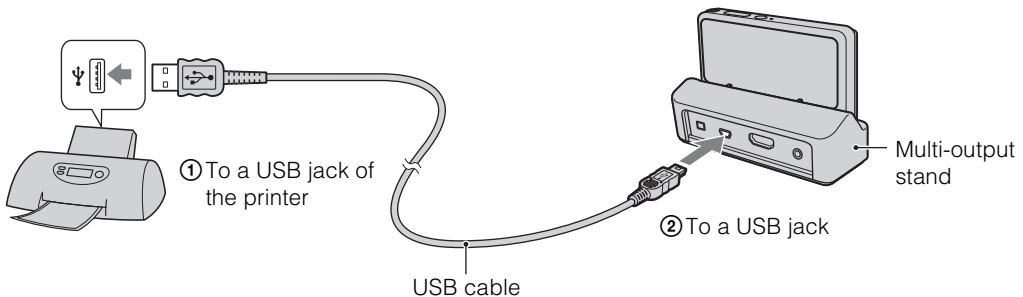

- 3 Turn on the camera and the printer.

After the connection is made, the  indicator appears on the screen.

If the  indicator flashes on the screen of the camera (error notification), check the connected printer.

4 **MENU** →  (Print) → desired mode

This Image	Prints the currently displayed image in single-image mode.
Multiple Images	<p>You can select and print multiple images. After step 4, perform the following.</p> <p>① Touch the image to be printed. Repeat the above steps until there are no more images to be printed. Touch an image with a ✓ mark again to release the ✓ mark.</p> <p>② Touch [OK] → [OK].</p>
All in Date Range All in This Folder	<p>Prints all images in the selected date range and folder at once. Touch [OK] after step 4.</p>

5 Desired setting item → [Start]

Quantity	<p>Selects the number of copies of the specified image to be printed.</p> <ul style="list-style-type: none"> The designated number of images may not all fit onto a single sheet depending on the quantity of images.
Layout	Selects the number of images you want to print side by side on a sheet.
Size	Selects the size of the printing sheet.
Date	<p>Selects [Date] or [Day&Time] to insert the date and time on images.</p> <ul style="list-style-type: none"> When you choose [Date], the date will be inserted in the order you select using [Date & Time Setting] on the camera. This function may not be available depending on the printer.

Notes

- Movies cannot be printed.
- If the camera could not be connected to the printer, be sure to set [USB Connect] under [Main Settings] to [PictBridge].
- Do not disconnect the USB cable while the  (PictBridge Connecting) indicator appears on the screen.

Printing at a shop

You can take a memory card containing images shot with the camera to a photo printing service shop. As long as the shop supports photo printing services conforming to DPOF, you can make a **DPOF** (Print order) mark on images in advance on the viewing menu so that you do not have to reselect them when you print them out at the shop.

Notes

- You cannot print images stored in the internal memory at a print shop directly from the camera. Copy the images to a memory card (page 121), then take the memory card to the print shop.
- Consult your photo printing service shop as to what types of memory card they can process.
- A memory card adaptor (sold separately) may be necessary. Consult your photo printing service shop.
- Before you take image data to a shop, always copy (back up) your data to a disk.
- You cannot set the number of prints.
- If you want to superimpose dates on images, consult your photo printing service shop.

Troubleshooting

If you experience trouble with the camera, try the following solutions.

❶ Check the items on pages 143 to 151.

If a code such as “C/E:□□:□□” appears on the screen, see page 152.

❷ Remove the battery pack, wait for about one minute, re-insert the battery pack, then turn on the power.

❸ Initialize the settings (page 105).

❹ Consult your Sony dealer or local authorized Sony service facility.

Be aware that by sending the camera for repair, you give consent that the contents of the internal memory, music files may be checked.

Additional information on this product and answers to frequently asked questions can be found at our Customer Support Website.
<http://www.sony.net/>

Battery pack and power

Cannot insert the battery pack.

- Make sure the direction of the battery is correct, and insert it until the battery eject lever is locked.

Cannot turn on the camera.

- After inserting the battery pack into the camera, it may take a few moments for the camera to power up.
- Insert the battery pack correctly.
- The battery pack is discharged. Insert a charged battery pack.
- The battery pack terminals are dirty. Gently wipe away any dirt with a soft cloth.
- Use a recommended battery pack.

The power turns off suddenly.

- Depending on the camera and battery temperature, the power may turn off automatically to protect the camera. In this case, a message is displayed on the LCD screen before the power turns off.
- If you do not operate the camera for a certain period of time while the power is on and [Power Save] is set to [Standard] or [Stamina], the camera turns off automatically to prevent wearing down the battery pack. Turn on the camera again.

The remaining charge indicator is incorrect.

- This is caused when you use the camera in an extremely hot or cold location.
- A discrepancy arose between the remaining charge indicator and the actual remaining battery charge. Fully discharge the battery pack once, then charge it to correct the indication. Depending on conditions of use, the display may remain incorrect.
- The battery pack is dead (page 160). Replace it with a new one.

Cannot charge the battery pack.



- You cannot charge the battery pack using the AC Adaptor (sold separately). Use the battery charger to charge the battery.

The CHARGE lamp flashes while charging the battery.

- Remove and reinsert the battery pack, making sure it is installed correctly.
- The temperature may be inappropriate for charging. Try charging the battery pack again within the proper charging temperature range (10°C to 30°C (50°F to 86°F)).
- For details, see page 160.

Shooting still images/movies

Cannot record images.

- When images cannot be recorded into a memory card but are recorded into the internal memory, even though a memory card has been inserted into the camera, make sure that the memory card has been fully inserted.
- Check the free capacity of the internal memory or the memory card. If it is full, do one of the following:
 - Delete unnecessary images (page 77).
 - Change the memory card.
- You cannot record images while charging the flash.
- Switch the  (Still)/ (Movie) mode button.
- When recording movies, it is recommended that you use the following memory cards:
 - “Memory Stick PRO Duo” (Mark2) media, “Memory Stick PRO-HG Duo” media
 - SD memory card, SDHC memory card or SDXC memory card (Class 4 or faster)
- Set [Demo Mode] to [Off] (page 104).

Smile Shutter function does not work.

- No image is shot if a smiling face is not detected.
- Set [Demo Mode] to [Off] (page 104).



Anti-blur function does not work.

- The anti-blur function may not work properly when shooting night scenes.
- Shoot after pressing the shutter button halfway down.

Recording takes a long time.

- When the shutter speed becomes slower than a certain speed, for example, when you shoot images in dark locations, the camera automatically reduces the image noise. This function is called NR (noise reduction) slow shutter and the shooting time takes longer.
- The Anti Blink function is working. When [Anti Blink] is set to [Auto], reset to [Off] (page 69).

The image is out of focus.

- The subject is too close. When shooting, make sure to position the lens farther away from the subject than the shortest shooting distance (approximately 1 cm (13/32 inches) (W)/50 cm (1 ft 7 3/4 inches) (T) from the lens in Intelligent Auto Adjustment and Easy Mode, or approximately 8 cm (3 1/4 inches) (W)/50 cm (1 ft 7 3/4 inches) (T) from the lens in other recording modes). Or set to Close focus mode and shoot about 1 cm to 20 cm (13/32 inches to 7 7/8 inches) from the W side distance.
-  (Landscape) mode or  (Twilight) mode or  (Fireworks) mode is selected in the Scene Selection when shooting still images.











Zoom does not work.

- You cannot use the zoom during Intelligent Sweep Panorama shooting.
- You cannot use the Smart zoom depending on the image size (page 96).
- You cannot use the Digital Zoom in the following situations:
 - In Movie Mode
 - In Backlight Correction HDR mode
 - When the Smile Shutter function is activated.

Cannot select the Face Detection function.

- You can select Face Detection only when the focus mode is set to [Multi AF] and the Metering Mode is set to [Multi].
- You cannot select Face Detection when the Close focus mode is activated.



The flash does not work.

- You cannot use the flash in the following situations:
 - Shooting burst images (page 55).
 - When  (High Sensitivity) mode,  (Twilight) mode or  (Fireworks) mode is selected in the Scene Selection.
 - In Intelligent Sweep Panorama mode
 - In Movie Mode
 - In Anti Motion Blur mode
 - In Hand-held Twilight mode
- Set the flash to [On] (page 47) in Close focus mode or when the Scene Selection mode is set to  (Landscape),  (Gourmet),  (Pet),  (Beach),  (Snow),  (Underwater) or  (Hi-Speed Shutter).

Fuzzy white circular spots appear in images shot using the flash.

- Particles (dust, pollen, etc.) in the air reflected the flash light and appeared in the image. This is not a malfunction.

The close-up shoot function (Macro/Focus On) does not work.

-  (Landscape) mode,  (Twilight) mode or  (Fireworks) mode is selected in the Scene Selection.
- When Close focus mode is selected, the shooting distance is approximately 1 cm to 20 cm (13/32 inches to 7 7/8 inches).
- [Macro] is set to [Auto] in the following situations:
 - In Intelligent Sweep Panorama mode
 - In Movie Mode
 - In Anti Motion Blur mode
 - In Hand-held Twilight mode
 - When the Smile Shutter function is activated.
 - In Easy Mode
 - When [Self-Timer] is set to [Self-portrait One Person] or [Self-portrait Two People].

Macro shooting cannot be turned off.

- There is no function for forcibly turning off macro shooting. In [Auto] mode, you can even shoot a distant subject.

The date and time are not displayed on the LCD screen.

- While shooting, the date and time are not displayed. They are displayed only during playback.

Cannot insert dates on images.

- This camera does not have a feature for superimposing dates on images. By using “PMB”, you can print or save images with the date (page 131).

The F value and shutter speed flash when you press and hold the shutter button halfway down.

- The exposure is incorrect. Correct the exposure (page 57).

The image colors are not correct.

- Adjust the [White Balance] (page 59).

Noise appears in the image when you view the screen in a dark place.

- The camera is attempting to increase the visibility of the screen by temporarily brightening the image under conditions of low illumination. There is no effect on the recorded image.

The eyes of the subject come out red.

- Set [Red Eye Reduction] to [Auto] or [On] (page 99).
- Shoot the subject at a distance closer than the flash range using the flash.
- Light the room and shoot the subject.
- Retouch the image using [Retouch] → [Red Eye Correction] on the viewing menu, or correct using “PMB”.

Dots appear and remain on the screen.

- This is not a malfunction. These dots are not recorded.

Cannot shoot images in succession.

- You cannot shoot images in succession while the Smile Shutter function is activated.
- The internal memory or the memory card is full. Delete unnecessary images (page 77).
- The battery level is low. Insert charged battery pack.

The same image is shot several times.

- Set [Burst] to [Off] (page 55).
- [Scene Recognition] is set to [Advanced] (page 65).

Viewing images

Cannot play back images.

- Make sure that the memory card is fully inserted into the camera.
- The folder/file name has been changed on your computer.
- No guarantees are made for playing back, on this camera, files containing images which were processed on a computer or images which were shot using other cameras.
- The camera is in USB mode. Delete the USB connection (page 134).
- Use “PMB” to play images stored on a PC with this camera.

The date and time are not displayed.

- [Display Settings] is set to [Off].

Left and right sides of the screen are shown in black.

- [Auto Orientation] is set to [On] (page 97).

The buttons and icons no longer appear.

- If you touch the top right of the screen during shooting, the buttons and icons will momentarily disappear. The buttons and icons will reappear when you take your finger off the screen.
- [Display Settings] in shooting or viewing menu is set to [Off]. Touch the left side of the LCD screen and drag to the right.

Cannot hear music during slideshow.

- Transfer music files to the camera with “Music Transfer” (pages 131, 132).
- Confirm that the volume setting and slideshow setting are correct (pages 75, 88).
- Slideshow is played back with [Continuous Playback]. Select [Slideshow with music] and play back.

The image does not appear on the TV.

- The camera and television must use the same color television system (page 157).
- Check whether the connection is correct (pages 125, 126).
- If the USB cable is connected to the USB terminal, disconnect the cable (page 134).
- When you shoot movies where the camera and a TV are connected, the image being shot is not displayed on the TV.

Deleting

Cannot delete an image.

- Cancel the protection (page 85).

A “Memory Stick PRO Duo” media is not recognized by a computer with a “Memory Stick” media slot.

- Check that the computer and the “Memory Stick” media Reader/Writer support a “Memory Stick PRO Duo” media. Users of computers and the “Memory Stick” media Readers/Writers made by manufacturers other than Sony should contact those manufacturers.
- If a “Memory Stick PRO Duo” media is not supported, connect the camera to the computer (page 133). The computer recognizes the “Memory Stick PRO Duo” media.

Your computer does not recognize the camera.

- When the battery level is low, insert the charged battery pack or use the AC adaptor (sold separately).
- Set [USB Connect] to [Auto] or [Mass Storage] (page 110).
- Use the USB cable for connection between the computer and the camera.
- Disconnect the USB cable from both the computer and the camera, and firmly connect it again.
- Disconnect all equipment other than the camera, the keyboard and the mouse from the USB connectors of your computer.
- Connect the camera directly to your computer without passing through a USB hub or other device.

Cannot import images.

- Connect the camera and your computer correctly making a USB connection (page 133).
- When you shoot images with a memory card formatted by a computer, you may not be able to import the images to a computer. Shoot using a memory card formatted by the camera (page 117).

After making a USB connection, “PMB” does not start automatically.

- Make the USB connection after the computer is turned on.

After making a USB connection, “PMB Portable” does not start.

- Set [LUN Settings] to [Multi].
- Set [USB Connect] to [Auto] or [Mass Storage].
- Connect the computer to the network.

Cannot play back images on your computer.

- If you are using “PMB”, refer to “PMB Help” (page 131).
- Consult the computer or software manufacturer.

The image and sound are interrupted by noise when you view a movie on a computer.

- You are playing back the movie directly from the internal memory or the memory card. Use “PMB” and import the movie to your computer, then play back the movie (page 131).

Images once exported to a computer cannot be viewed on the camera.

- Use “PMB” to play images stored on a PC with this camera.
- Register the image in the Image Database File and play in [Date View] (page 83).
- Event View is not available on this camera.

Memory card

Cannot insert a memory card.

- Insert it in the correct direction.

You have formatted a memory card by mistake.

- All the data on the memory card is deleted by formatting. You cannot restore it.

Data is being recorded to internal memory even though you inserted a memory card.

- Check that the memory card has been securely inserted as far as it will go.

Internal memory

Cannot playback or record images using the internal memory.

- There is a memory card inserted in the camera. Remove it.

Cannot copy the data stored in the internal memory to a memory card.

- The memory card is full. Copy to a memory card with sufficient capacity.

Cannot copy the data on the memory card or the computer to the internal memory.

- This feature is not available.

Printing

See “PictBridge-compliant printer” together with the following items.

Cannot print an image.

- Refer to the operation manual of the printer.

Images are printed with both edges cut off.

- Depending on your printer, all the edges of the image may be cut off. Especially when you print an image shot with the image size set to [16:9], the lateral end of the image may be cut off.
- When printing images using your printer, cancel the trimming or borderless settings. Consult the printer manufacturer as to whether the printer provides these functions or not.
- When having images printed at a digital print shop, ask the shop whether they can print the images without cutting off both edges.

Cannot print images with the date.

- Using “PMB”, you can print images with date (page 131).
- The camera does not have a feature for superimposing dates on images. However, because the images shot with the camera include information on the recording date, you can print images with the date superimposed if the printer or the software can recognize Exif information. For compatibility with Exif information, consult the manufacturer of the printer or the software.
- If you use a photo printing service, ask them to superimpose the dates on images.

PictBridge-compliant printer

A connection cannot be established.

- The camera cannot be connected directly to a printer that is not compliant with the PictBridge standard. Consult the printer manufacturer as to whether the printer is compliant with PictBridge or not.
- Check that the printer is turned on and can be connected to the camera.
- Set [USB Connect] to [PictBridge] (page 110).
- Disconnect the USB cable and connect it again. If an error message is indicated on the printer, refer to the operating instructions supplied with the printer.

Cannot print images.

- Check that the camera and the printer are properly connected using the USB cable.
- Turn on the printer. For details, refer to the operating instructions supplied with the printer.
- If you select [Exit] during printing, images may not be printed. Disconnect the USB cable and connect it again. If you still cannot print your images, disconnect the USB cable once more, turn the printer off and then turn it on, and connect the cable again.
- Movies cannot be printed.
- Images shot using other cameras, or images modified with a computer may not be printed.
- Panoramic images may not be printed or may be printed with both edges cut off depending on the printer.

Printing is canceled.

- Do not disconnect the USB cable before the  (PictBridge Connecting) indicator turned off.

Cannot insert the date or print images in the index mode.

- The printer does not provide these functions. Consult the printer manufacturer as to whether the printer provides these functions or not.
- The date may not be inserted in the index mode depending on the printer. Consult the printer manufacturer.

“---- -- --” is printed on the date-inserted part of the image.

- The image does not have the recording data so the date cannot be inserted. Set [Date] to [Off] and print the image again (page 140).

Cannot print the image at the size selected.

- When you replace the printer paper with paper of a different size after connecting the printer to the camera, disconnect the USB cable connected to the printer and then reconnect the printer.
- The print setting of the camera differs from that of the printer. Change the setting of either the camera (page 140) or the printer.
- Consult the printer manufacturer as to whether the printer can provide the desired size.

Cannot operate the camera after canceling printing.

- Wait for a while as the printer is carrying out the cancellation. It may take some time depending on the printer.

Touch panel

Cannot operate the touch panel buttons correctly or fully.

- Perform [Calibration] (page 116).
- [Housing] is set to [On] (page 109).

The paint pen operation reacts at inappropriate points.

- Perform [Calibration] (page 116).

Others

The lens gets fogged.

- Moisture condensation has occurred. Turn off the camera and leave it for about an hour before using it.



The camera becomes warm when you use it for a long time.

- This is not a malfunction.

The Clock Set screen appears when you turn on the camera.

- Set the date and time again (page 124).
- The internal rechargeable backup battery has discharged. Insert a charged battery, and set aside for 24 hours or more with the power left off.

The date or time is incorrect.

- The Area Setting is set to a different location than your current location. Change the setting by **MENU** →  (Settings) →  (Clock Settings) → [Area Setting].

Warning indicators and messages

Self-diagnosis display

If a code starting with a letter of the alphabet appears, the self-diagnosis function on the camera is working. The last two digits (indicated by □□) will differ depending on the state of the camera.

If you cannot solve the problem even after trying the following corrective actions a few times, the camera may need repair. Contact your Sony dealer or local authorized Sony service facility.

C:32:□□

- There is trouble with the camera's hardware. Turn the power off and on again.

C:13:□□

- The camera cannot read or write data on the memory card. Try turning off and on the camera again, or taking out and inserting the memory card several times.
- The internal memory has experienced a format error, or an unformatted memory card is inserted. Format the internal memory or the memory card (page 117).
- The inserted memory card cannot be used with the camera, or the data is damaged. Insert a new memory card.

E:61:□□

E:62:□□

E:91:□□

- A camera malfunction has occurred. Initialize the camera (page 105), then turn the power on again.

E:94:□□

- There is a malfunction when writing or deleting data. Repair is required. Contact your Sony dealer or local authorized Sony service facility. Be prepared to give all numbers in the error code beginning from the E.

Messages

If the following messages appear, follow the instructions.



- The battery level is low. Charge the battery pack immediately. Depending on the conditions of use or the type of battery pack, the indicator may flash even though there are still 5 to 10 minutes of remaining battery time left.

For use with compatible battery only

- The battery inserted is not an NP-BN1 (supplied) battery pack.

System error

- Turn the power off and then on again.

Camera overheating

Allow it to cool

- The camera temperature has risen. The power may turn off automatically, or you may be unable to record movies. Leave the camera in a cool location until the temperature goes down.

Internal memory error

- Turn the power off and then on again.

Reinsert the memory card

- The inserted memory card cannot be used in the camera (page 3).
- The terminal section of the memory card is dirty.
- The memory card is damaged.

Memory card type error

- The inserted memory card cannot be used in the camera (page 3).

This memory card may not record or play

- The inserted memory card cannot be used in the camera (page 3).

Error formatting internal memory

Error formatting memory card

- Format the media again (page 117).

Memory card locked

- You are using the memory card with the write-protect switch, and the switch is set to the LOCK position. Set the switch to the recording position.

Read only memory card

- The camera cannot record or delete images on this memory card.

Writing to the memory card was not completed correctly

Recover data

- Reinsert the memory card, and follow the instructions on the screen.

No images

- No images that can be played back have been recorded in the internal memory.
- No images that can be played back have been recorded in the memory card.

No still images

- The selected folder or date does not contain a file that can be played back in a slideshow.

File found which was not recognized

- You tried to delete a folder containing a file that cannot be played on this camera. Delete the file on a computer and then delete the folder.

Folder error

- A folder with the same first three digit number already exists on the memory card (for example: 123MSDCF and 123ABCDE). Select another folder, or create a new folder (pages 118, 119).

Cannot create more folders

- The folder with a name beginning with “999” exists on the memory card. You cannot create any folders if this is the case.

Empty folder contents

- You tried to delete a folder containing one or more files. Delete all of the files and then delete the folder.

Folder protected

- You tried to delete a folder that is protected as read only on a computer.

File error

- An error occurred while the image was playing back.
No guarantees are made for playing back, on this camera, files containing images which were processed on a computer or images which were shot using other cameras.

Read only folder

- You have selected a folder that cannot be set as a recording folder on the camera. Select another folder (page 119).

File protected

- Release the protection (page 85).

Image size over limit

- You are playing back an image with size that cannot be played back on the camera.

Unable to detect face for retouch

- You may not be able to retouch the image depending on the image.

(Vibration warning indicator)

- Camera shake may occur due to insufficient light. Use the flash, or mount the camera on a tripod to secure the camera.

MP4 12M is not supported with this memory card

MP4 6M is not supported with this memory card

- We recommend the use of a memory card with at least 1 GB of memory.

Recording is unavailable in this movie format

- Set [Movie format] to [MP4] (page 93).

Maximum number of images already selected

- Up to 100 files can be selected when using [Multiple Images].
- Up to 999 files can be selected when using [All in Date Range] or [All in This Folder] for DPOF, Protect or Print.
- You can add **DPOF** (Print order) marks to up to 999 files. Cancel the selection.



- The data transmission to the printer may not be completed yet. Do not disconnect the USB cable.

Processing...

- The printer is canceling the current print job. You cannot print until it is finished. This may take time, depending on the printer.

Error Playing Music

- Delete the Music file, or replace it with a normal Music file.
- Execute [Format Music], then download a new Music file.

Error Formatting Music

- Execute [Format Music].

Operation cannot be executed in unsupported files

- Processing and other editing functions of the camera cannot be performed on image files that have been processed using a computer or images that were recorded with other cameras.

Preparing Image Database File

- The camera restores the date information, etc., in cases where images have been deleted on a PC, etc.
- The necessary Image Database File is created after the memory card is formatted.



- The number of images exceeds that for which date management in a database file by the camera is possible. To register additional images in the Image Database File, delete images in [Date View].

Inconsistencies found in Image Database File. Recover data

- AVCHD movies cannot be recorded or played because the Image Database File is corrupt. Follow the on-screen instructions to recover the Image Database File.



- It is not possible to record to the camera's Image Database File or play back using [Date View]. Use "PMB" to back up all images to a PC and use it to restore a memory card or internal memory.

Image Database File error Cannot recover

- Import all of the images to the computer with "PMB", and format the memory card or the internal memory (page 117).
When you cannot import all of the images to the computer with "PMB", import the images to the computer without using "PMB" (page 133).
To view the images again with the camera, export the imported images to the camera with "PMB".

Recording function unavailable due to high internal temperature

- The camera temperature has risen. You cannot record images until the temperature has gone down.

Recording has stopped due to increased camera temperature

- Recording has stopped due to a rise in temperature while recording a movie. Please wait until the temperature goes down.



- When you record movies for a long time, the camera temperature rises. In this case, stop recording movies.

Connection failed

- Check the TransferJet reception port and transfer data correctly (page 16).

Some files were not sent Some files were not received

- Either communication was cut off during image transfer, or transfer was cut off because device memory is full. Check the available memory capacity and try transferring data using TransferJet again.

Using the camera abroad

You can use the battery charger (supplied), and the AC-LS5 AC Adaptor (sold separately) in any country or region where the power supply is within 100 V to 240 V AC, 50/60 Hz.

Note

- Do not use an electronic transformer (travel converter), as this may cause a malfunction.

On TV color systems

To view movies shot using this camera on a television, the camera and television must use the same color television system.

NTSC system (1080 60i)

Bahama Islands, Bolivia, Canada, Central America, Chile, Colombia, Ecuador, Jamaica, Japan, Korea, Mexico, Peru, Surinam, Taiwan, the Philippines, the U.S.A., Venezuela, etc.

PAL system (1080 50i)

Australia, Austria, Belgium, China, Croatia, Czech Republic, Denmark, Finland, Germany, Holland, Hong Kong, Hungary, Indonesia, Italy, Kuwait, Malaysia, New Zealand, Norway, Poland, Portugal, Romania, Singapore, Slovak Republic, Spain, Sweden, Switzerland, Thailand, Turkey, United Kingdom, Viet Nam, etc.

PAL-M system (1080 50i)

Brazil

PAL-N system (1080 50i)

Argentina, Paraguay, Uruguay

SECAM system (1080 50i)

Bulgaria, France, Greece, Guiana, Iran, Iraq, Monaco, Russia, Ukraine, etc.

“Memory Stick Duo” media

A “Memory Stick Duo” media is a compact, portable IC recording medium. The types of “Memory Stick Duo” media that can be used with the camera are listed in the table below. However, proper operation cannot be guaranteed for all “Memory Stick Duo” media functions.

“Memory Stick” media type	Recording/Playback
Memory Stick Duo (without MagicGate)	○*1
Memory Stick Duo (with MagicGate)	○*2
MagicGate Memory Stick Duo	○*1*2
Memory Stick PRO Duo	○*2*3
Memory Stick PRO-HG Duo	○*2*3*4

*1 High-speed data transfer using a parallel interface is not supported.

*2 “Memory Stick Duo” media, “MagicGate Memory Stick Duo” media, “Memory Stick PRO Duo” media and “Memory Stick PRO-HG Duo” media are equipped with MagicGate functions. MagicGate is copyright protection technology that uses encryption technology. Data recording/playback that requires MagicGate functions cannot be performed with the camera.

*3 [AVC HD 17M FH], [AVC HD 9M HQ], [MP4 12M] or [MP4 6M] movies cannot be recorded to internal memory or a Memory Stick other than a “Memory Stick PRO Duo” media.

*4 This camera does not support 8-bit parallel data transfer. It performs the same 4-bit parallel data transfer as the “Memory Stick PRO Duo” media.

Notes

- This product is compatible with “Memory Stick Micro” media (“M2”). “M2” is an abbreviation for “Memory Stick Micro” media.
- A “Memory Stick Duo” media formatted with a computer is not guaranteed to operate with the camera.
- Data read/write speeds differ depending on the combination of the “Memory Stick Duo” media and the equipment used.
- Do not remove the “Memory Stick Duo” media while reading or writing data.
- Data may be corrupted in the following cases:
 - When the “Memory Stick Duo” media is removed or the camera is turned off during a read or write operation
 - When the “Memory Stick Duo” media is used in locations subject to static electricity or electrical noise
- We recommend backing up important data.
- Do not attach a label on the “Memory Stick Duo” media itself nor on a “Memory Stick Duo” media Adaptor.
- Do not touch the terminal section of the “Memory Stick Duo” media with your hand or a metal object.
- Do not strike, bend or drop the “Memory Stick Duo” media.
- Do not disassemble or modify the “Memory Stick Duo” media.
- Do not expose the “Memory Stick Duo” media to water.
- Do not leave the “Memory Stick Duo” media within the reach of small children. They might accidentally swallow it.
- Do not insert anything other than a “Memory Stick Duo” media into the “Memory Stick Duo” media slot. Doing so will cause a malfunction.
- Do not use or store the “Memory Stick Duo” media under the following conditions:
 - High temperature locations such as the hot interior of a car parked in direct sunlight
 - Locations exposed to direct sunlight
 - Humid locations or locations with corrosive substances present

Notes on using the “Memory Stick Duo” media Adaptor (sold separately)

- To use a “Memory Stick Duo” media with a “Memory Stick” media compliant device, be sure to insert the “Memory Stick Duo” media into a “Memory Stick Duo” media Adaptor. If you insert a “Memory Stick Duo” media into a “Memory Stick” media compliant device without a “Memory Stick Duo” media Adaptor, you might not be able to remove it from the device.
- When inserting a “Memory Stick Duo” media into a “Memory Stick Duo” media Adaptor, make sure the “Memory Stick Duo” media is inserted facing in the correct direction, then insert it all the way in. Incorrect insertion may result in a malfunction.
- When using a “Memory Stick Duo” media inserted into a “Memory Stick Duo” media Adaptor with a “Memory Stick” media compliant device, make sure that the “Memory Stick Duo” media Adaptor is inserted facing the correct direction. Note that improper use may damage the equipment.
- Do not insert a “Memory Stick Duo” media Adaptor into a “Memory Stick” media compliant device without a “Memory Stick Duo” media attached. Doing so may result in malfunction of the unit.

Notes on using a “Memory Stick Micro” media (sold separately)

- To use a “Memory Stick Micro” media with the camera, be sure to insert the “Memory Stick Micro” media into an “M2” Adaptor as large as of Duo size. If you insert a “Memory Stick Micro” media into the camera without an “M2” Adaptor as large as of Duo size, you might not be able to remove it from the camera.
- Do not leave the “Memory Stick Micro” media within the reach of small children. They might accidentally swallow it.

Battery pack

On charging the battery pack

- We recommend charging the battery pack in an ambient temperature of between 10°C to 30°C (50°F to 86°F). The battery pack may not be fully charged in temperatures outside this range.

Effective use of the battery pack

- Battery performance decreases in low temperature surroundings. So in cold places, the operational time of the battery pack is shorter. We recommend the following to ensure longer battery pack use:
 - Put the battery pack in a pocket close to your body to warm it up, and insert it in the camera immediately before you start shooting.
- The battery pack will run out quickly if you use the flash or zoom frequently.
- We recommend having spare battery packs handy for two or three times the expected shooting time, and making trial shots before taking the actual shots.
- Do not expose the battery pack to water. The battery pack is not water-resistant.
- Do not leave the battery pack in extremely hot places, such as in a car or under direct sunlight.
- When the battery pack terminals become dirty, the camera may not turn on, the battery pack may not charge, or other symptoms may occur. In these cases, gently wipe away any dirt with a soft cloth.

How to store the battery pack

- Fully discharge the battery pack before storing and store it in a cool, dry place. To maintain the battery pack's function, fully charge the battery pack and then fully discharge it on the camera at least once a year while storing.
- To use the battery pack up, leave the camera in slideshow (page 74) playback mode until the power goes off.
- To keep clean battery pack terminal and prevent short-circuiting, place the battery pack in a plastic bag, etc. when carrying and storing to isolate it from other metal objects, etc.

On battery life

- The battery life is limited. Battery capacity decreases over time and through repeated use. If decreased usage time between charges becomes significant, it is probably time to replace it with a new one.
- The battery life varies according to how it is stored and the operating conditions and environment in which each battery pack is used.

Compatible battery pack

- The NP-BN1 battery pack (supplied) can be used only in N type compatible Cyber-shot models.

Battery charger

- Only NP-BN-type battery packs (and no others) can be charged in the battery charger (supplied). Batteries other than the specified kind may leak, overheat, or explode if you attempt to charge them, posing a risk of injury from electrocution and burns.
- The CHARGE lamp on the supplied battery charger has the following two flash patterns.
 - Fast flash: The lamp repeatedly flashes on and off at approximately 0.15-second intervals.
 - Slow flash: The lamp repeatedly flashes on and off at approximately 1.5-second intervals.
- Remove the charged battery pack from the battery charger. If you leave the charged battery pack in the charger, battery life may be shortened.
- When the CHARGE lamp flashes, remove the battery pack being charged, and then insert the same battery pack into the battery charger again until it clicks. When the CHARGE lamp flashes again, this may indicate a battery error or that a battery pack other than the specified type has been inserted. Check that the battery pack is the specified type. If the battery pack is the specified type, remove the battery pack, replace it with new one or another one and check if the battery charger operates correctly. If the battery charger operates correctly, a battery error may have occurred.
- If the CHARGE lamp is flashing slowly, it is in standby mode and charging has temporarily stopped. Charging stops temporarily and standby mode results when the temperature is outside the range suitable for charging. Charging resumes and the CHARGE lamp lights when the temperature returns to the range suitable for charging. We recommend charging the battery pack in an ambient temperature of between 10°C to 30°C (50°F to 86°F).

Intelligent Pantilter

Intelligent Pantilter (sold separately) allows you to take pictures, by having the camera detect people's faces.

For details, see the operating instructions supplied with Intelligent Pantilter.

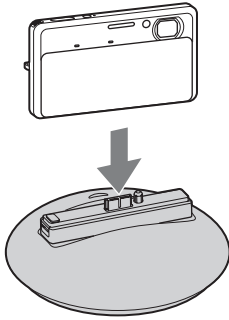

Table of contents

Operation Search

MENU/Settings Search

Index

AVCHD format

The AVCHD format has been developed for high-definition digital video cameras when recording an HD (High-Definition) signal at the 1080i^{*1} or 720p^{*2} specification using high-efficiency compression coding technology. The MPEG-4 AVC/H.264 format is adopted to compress video data, and the Dolby Digital or Linear PCM system is used to compress audio data.

The MPEG-4 AVC/H.264 format is capable of compressing images at higher efficiency than that of the conventional image compressing format. The MPEG-4 AVC/H.264 format enables a high definition video signal shot on a digital video camera recorder to be recorded on 8 cm DVD discs, hard disk drive, flash memory, memory card, etc.

Recording and playback on the camera

Based on the AVCHD format, your camera records with the high definition image quality (HD) mentioned below.

Video signal^{*3}: **1080 60i-compatible device**
MPEG-4 AVC/H.264 1920×1080/60i, 1440×1080/60i
1080 50i-compatible device
MPEG-4 AVC/H.264 1920×1080/50i, 1440×1080/50i
Audio signal: Dolby Digital 2ch
Recording media: Memory card

*¹ 1080i specification

A high definition specification which utilizes 1,080 effective scanning lines and the interlace system.

*² 720p specification

A high definition specification which utilizes 720 effective scanning lines and the progressive system.

*³ Data recorded in AVCHD format other than the above mentioned cannot be played on your camera.

TransferJet standard

TransferJet communications conform to the standard given below.

TransferJet standard:

Conforms to PCL Spec. Rev. 1.0

Protocol Class Name (communication type):

SCSI Block Device Target

OBEX Push Server

OBEX Push Client

- Use the “SCSI” communication protocol above when connecting to a TransferJet-compatible device (sold separately). Or, use the “OBEX” communication protocol when sharing data between cameras.

Table of
contents

Operation
Search

MENU/Settings
Search

Index

Index

Table of
contents

Operation
Search

MENU/Settings
Search

Index

A

A/V OUT (STEREO) jack.....	125
AF Illuminator.....	94
AF range finder frame.....	62
Anti Blink.....	69
Anti Motion Blur.....	31
Area Setting.....	123
Auto Orientation.....	97
AVCHD format.....	163

B

Backlight Correction HDR.....	33
Battery charger.....	161
Battery pack.....	160
Beach.....	34
Beep.....	101
Blink Alert.....	100
Burst.....	55

C

Calendar.....	72
Calibration.....	116
Center AF.....	62
Center-weighted metering.....	64
Change REC.Folder.....	119
Clock Settings.....	124
Close Focus.....	56
COMPONENT.....	108
Computer	
Importing images.....	133, 134
Macintosh computer.....	130
Recommended environment.....	130
Windows computer.....	130
Connecting	
Computer.....	133
Printer.....	140
TV.....	125
Copy.....	121
Create REC.Folder.....	118
CTRL FOR HDMI.....	107
Customize.....	22

D

Date.....	141
Date & Time Setting.....	124
Delete.....	77
Delete REC.Folder.....	120
Demo Mode.....	104
Digital Zoom.....	96
Display Burst Group.....	84
Display Settings	
Shooting.....	70
Viewing.....	89
Download Music.....	112
DPOF.....	86

E

Easy Mode	
Shooting.....	42
Viewing.....	71
EV.....	57
Exposure.....	57
Exposure data.....	90

F

Face Detection.....	67
File Number.....	122
Fireworks.....	35
Flash.....	47, 48
Focus.....	62
Folder	
Changing.....	119
Creating.....	118
Deleting.....	120
Selecting.....	92
Format Music.....	113
Format.....	117

G

Gourmet.....	34
Grid Line.....	95

H

Hand-held Twilight.....	32
HD(1080i).....	108
HDMI Resolution.....	106
High Sensitivity.....	34
Hi-Speed Shutter.....	35
Housing.....	109

I

Image Index.....	73
Image index settings.....	91
Image Size.....	52
Initialize.....	105
Intelligent Auto Adjustment.....	26
Intelligent Pantiler.....	162
Intelligent Sweep Panorama.....	28
Internal memory.....	24
ISO.....	58

L

Landscape.....	34
Language Setting.....	103
LCD Brightness.....	102
LUN Settings.....	111

M

Macintosh computer.....	130
Macro.....	56
Mass Storage.....	110
Memory card.....	3
“Memory Stick Duo” media.....	158
MENU screen.....	11, 13
Metering Mode.....	64
Movie button.....	43
Movie format.....	93
Movie Mode	
Shooting.....	30
Viewing.....	41
Movie shooting scene.....	44
MTP.....	110
Multi AF.....	62
Multi-connector.....	129
Multi-pattern metering.....	64
Music Transfer.....	131

N

Names of parts.....	16
---------------------	----

O

Optical zoom.....	36, 96
OS.....	130

P

Paint.....	81
PC.....	130
Pet.....	34
PictBridge.....	110, 140
Pixel.....	54
Playback	
Movies.....	41
Still images.....	37
Playback Zoom.....	38
PMB.....	131
PMB Portable.....	135
Power Save.....	114
Precision digital zoom.....	96
Print.....	86, 140
Print order mark.....	142
Program Auto.....	27
Protect.....	85
PTP.....	110

Q

Quality.....	52
--------------	----

R

REC Mode.....	25
Red Eye Correction.....	82
Red Eye Reduction.....	99
Retouch.....	82
Rotate.....	87

S

Scene Recog. Guide.....	98
Scene Recognition.....	65
Scene Selection.....	34
SD.....	108
Select Folder.....	92
Selected-face Memory.....	68
Self-diagnosis display.....	152
Self-portrait.....	49

Self-Timer.....	49, 50
Send by TransferJet.....	79
Settings.....	14
Shooting	
Movies.....	30
Still images.....	26
Shooting Direction.....	51
Slideshow.....	74
Slow Synchro.....	47
Smart zoom.....	96
Smile Shutter.....	45
Snow.....	34
Soft Snap.....	34
Software.....	131
Spot AF.....	62
Spot metering.....	64
Still/Movie mode button.....	23

T

Temporarily Rotated Display.....	40
Touch panel.....	20
TransferJet.....	115
TransferJet standard.....	164
Trimming (Resize).....	82
Troubleshooting.....	143
TV.....	125, 126
Twilight.....	34
Twilight Portrait.....	34

U

Underwater.....	35
Underwater White Balance.....	61
Unsharp masking.....	82
USB Connect.....	110
USB jack.....	133, 140
Using the camera abroad.....	157

V

VGA.....	52
View Mode.....	83
Volume Settings.....	88

W

Warning indicators and messages.....	152
White Balance.....	59
Wide Zoom.....	39
Windows computer.....	130

Z

Zoom.....	36
-----------	----

Notes on the License

“C Library”, “Expat”, “zlib”, “dtoa”, “pcre” and “libjpeg” software are provided in the camera. We provide this software based on license agreements with their owners of copyright. Based on requests by the owners of copyright of these software applications, we have an obligation to inform you of the following. Please read the following sections.

Read “license1.pdf” in the “License” folder on the CD-ROM. You will find licenses (in English) of “C Library”, “Expat”, “zlib”, “dtoa”, “pcre” and “libjpeg” software.

THIS PRODUCT IS LICENSED UNDER THE AVC PATENT PORTFOLIO LICENSE FOR THE PERSONAL AND NON-COMMERCIAL USE OF A CONSUMER TO

(i) ENCODE VIDEO IN COMPLIANCE WITH THE AVC STANDARD (“AVC VIDEO”) AND/OR

(ii) DECODE AVC VIDEO THAT WAS ENCODED BY A CONSUMER ENGAGED IN A PERSONAL AND NON-COMMERCIAL ACTIVITY AND/OR WAS OBTAINED FROM A VIDEO PROVIDER LICENSED TO PROVIDE AVC VIDEO.

NO LICENSE IS GRANTED OR SHALL BE IMPLIED FOR ANY OTHER USE.

ADDITIONAL INFORMATION MAY BE OBTAINED FROM MPEG LA, L.L.C. SEE [HTTP://WWW.MPEGLA.COM](http://www.mpegla.com)

On GNU GPL/LGPL applied software

The software that is eligible for the following GNU General Public License (hereinafter referred to as “GPL”) or GNU Lesser General Public License (hereinafter referred to as “LGPL”) are included in the camera.

This informs you that you have a right to have access to, modify, and redistribute source code for these software programs under the conditions of the supplied GPL/LGPL.

Source code is provided on the web. Use the following URL to download it.

<http://www.sony.net/Products/Linux/>

We would prefer you do not contact us about the contents of source code.

Read “license2.pdf” in the “License” folder on the CD-ROM. You will find licenses (in English) of “GPL”, and “LGPL” software.

To view the PDF, Adobe Reader is needed. If it is not installed on your computer, you can download it from the Adobe Systems web page:

<http://www.adobe.com/>

On the license of “Music Transfer” in the CD-ROM (supplied)

MPEG Layer-3 audio coding technology and patents licensed from Fraunhofer IIS and Thomson.