



Use this manual if you encounter any problems, or have any questions about your product.

How to change the shooting mode

You can set the shooting mode according to the images you want to shoot, such as still images, movies, or high-frame-rate (super-slow-motion) movies, and the functions you want to use.

How to turn the camera on/off remotely

You can turn the camera on or off from a smartphone connected to the camera via the Bluetooth function.



DSC-RX0 Accessories compatibility information

This website provides the accessories compatibility information. (Another window will open.)

How to Use

Before Use

[Checking the camera and the supplied items](#)

[Identifying parts](#)

[List of icons on the screen](#)

Preparing the camera

Charging the battery pack

- [Inserting the battery pack into the camera](#)

- [Charging the battery pack while it is inserted in the camera](#)

- [Charging by connecting to a computer](#)

- [Battery life and the number of images that can be recorded using a battery pack](#)

- [Supplying power from a wall outlet \(wall socket\)](#)

- [Removing the battery pack](#)

Inserting a memory card (sold separately)

- [Inserting a memory card](#)

- [Removing the memory card](#)

- [Usable memory cards](#)

[Setting language, date and time](#)

Confirming the operation method

[Using the up/down/left/right buttons and the Enter button](#)

[Using MENU items](#)

[Using the Fn \(Function\) button](#)

Shooting

[Shooting still images](#)

[Shooting movies](#)

[Selecting a shooting mode](#)

[Intelligent Auto \(still image\)](#)

[Superior Auto \(still image\)](#)

[About Scene Recognition](#)

[The advantages of automatic shooting](#)

[Program Auto \(still image/movie\)](#)

[Manual Exposure \(still image/movie\)](#)

[Memory recall \(Camera Settings1/Camera Settings2\)](#)

[Intelligent Auto \(movie\)](#)

[Shooting super-slow-motion movies \(High Frame Rate\)](#)

[Shooting images underwater](#)

Using shooting functions

[Switching the screen display_\(Shooting\)](#)

Selecting still image size/image quality

[Image Size \(still image\)](#)

[Aspect Ratio \(still image\)](#)

[Quality \(still image\)](#)

Adjusting the focus

[Focus Mode](#)

[Focus Area](#)

[Lock-on AF](#)

[AF Area Auto Clear](#)

[Focus-lock](#)

[Preset Focus](#)

[NEAR Mode in PF](#)

[Manual Focus](#)

[MF Assist](#)

[Focus Magnif. Time](#)

[Peaking Level](#)

[Peaking Color](#)

[AF/MF control](#)

[Eye AF](#)

Using the zoom

[Zoom](#)

[About zoom scale](#)

Adjusting the exposure

[Shutter Speed](#)

[Exposure Comp.](#)

[Metering Mode](#)

[AE lock](#)

[AEL w/ shutter \(still image\)](#)

[Zebra](#)

Selecting a drive mode (Continuous shooting/Self-timer)

[Drive Mode](#)

[Cont. Shooting](#)

[Spd Priority Cont.](#)

[Self-timer](#)

[Self-timer\(Cont\)](#)

[Cont. Bracket](#)

[Single Bracket](#)

[WB bracket](#)

[DRO Bracket](#)

[Settings for bracket shooting](#)

[Indicator during bracket shooting](#)

Selecting the ISO sensitivity

[ISO](#)

[ISO AUTO Min. SS](#)

[Multi Frame NR](#)

Correcting the brightness or contrast

[D-Range Opt. \(DRO\)](#)

[Auto HDR](#)

Adjusting color tones

[White Balance](#)

[Capturing a basic white color in \[Custom Setup\] mode](#)

Selecting an effect mode

[Picture Effect](#)

[Creative Style](#)

Settings for movies

- [Movie recording formats](#)
- [File Format \(movie\)](#)
- [Record Setting \(movie\)](#)
- [Dual Video REC](#)
- [Marker Display \(movie\)](#)
- [Marker Settings \(movie\)](#)
- [Mon. Off dur REC \(movie\)](#)
- [REC Lamp](#)
- [Audio Recording](#)
- [Audio Rec Level](#)
- [Audio Level Display](#)
- [Wind Noise Reduct.](#)
- [Auto Slow Shut. \(movie\)](#)
- [MOVIE Button](#)
- [Picture Profile](#)
- [Adjusting the settings for super-slow-motion shooting \(HFR Settings\)](#)
- [Selecting the exposure mode for super-slow-motion shooting \(Exposure Mode\)](#)

Customizing the shooting functions for convenient use

- [Memory \(Camera Settings1/Camera Settings2\)](#)
- [Function Menu Set](#)
- [Custom Key \(Shoot.\)](#)
- [Function of the Enter button](#)
- [Function of the Left button](#)

Setting the other functions of this product

- [Face Detection](#)
- [Face Registration \(New Registration\)](#)
- [Face Registration \(Order Exchanging\)](#)
- [Face Registration \(Delete\)](#)
- [High ISO NR \(still image\)](#)

[Audio signals](#)

[Write Date \(still image\)](#)

[Color Space \(still image\)](#)

[Grid Line](#)

[Auto Review](#)

[Live View Display](#)

[Release w/o Card](#)

Viewing

Viewing still images

[Playing back images](#)

[Playback zoom](#)

[Image Index](#)

[Switching the screen display \(during playback\)](#)

Playing back movies

[Playing back movies](#)

[Delete](#)

[Specify Printing](#)

Using viewing functions

[View Mode](#)

[Slide Show](#)

[Rotate](#)

[Enlarge Initial Pos.](#)

[Protect](#)

[4K Still Image PB](#)

Viewing images on a TV

[Viewing images on an HD TV](#)

[Viewing images on a "BRAVIA" Sync-compatible TV](#)

Changing settings

[Monitor Brightness](#)

[Gamma Disp. Assist](#)

[Volume Settings](#)

[Tile Menu](#)

[Pwr Save Start Time](#)

[Auto Pwr OFF Temp.](#)

[Flip](#)

[NTSC/PAL Selector](#)

[Demo Mode](#)

[TC/UB Settings](#)

[HDMI Settings: HDMI Resolution](#)

[HDMI Settings: 24p/60p Output \(movie\)_\(Only for 1080 60i compatible models\)](#)

[HDMI Settings: HDMI Info. Display](#)

[HDMI Settings: TC Output \(movie\)](#)

[HDMI Settings: REC Control \(movie\)](#)

[HDMI Settings: CTRL FOR HDMI](#)

[HDMI 4K Output \(movie\)](#)

[USB Connection](#)

[USB LUN Setting](#)

[USB Power Supply](#)

[PC Remote Settings: Still Img. Save Dest.](#)

[PC Remote Settings: RAW+J PC Save Img](#)

[Language](#)

[Date/Time Setup](#)

[Area Setting](#)

[Copyright Info](#)

[Format](#)

[File Number](#)

[Set File Name](#)

[Select REC Folder](#)

[New Folder](#)

[Folder Name](#)

[Recover Image DB](#)

[Display Media Info.](#)

[Version](#)

[Setting_Reset](#)

Using Wi-Fi/Bluetooth functions

[PlayMemories Mobile](#)

Controlling this product using a Smartphone

- └ [Controlling the camera from a smartphone via Wi-Fi \(Single connection\)_\(Android\)](#)
 - └ [Controlling the camera from a smartphone via Wi-Fi \(Single connection\)_\(iPhone/iPad\)](#)
 - └ [Controlling multiple cameras from a smartphone via Wi-Fi \(Multiple connections\)](#)
 - └ [Controlling multiple cameras from a smartphone via Wi-Fi using an access point \(Multiple connections\)](#)
-

Turning the camera on/off using a smartphone

- └ [Turning the camera on/off from a smartphone using the Bluetooth function](#)
-

Transferring images to a Smartphone

- └ [Send to Smartphone](#)
-

Transferring images to a computer

- └ [Send to Computer](#)
-

Transferring images to a TV

- └ [View on TV](#)
-

Changing the settings for Wi-Fi/Bluetooth functions

- └ [Ctrl w/ Smartphone](#)
- └ [Airplane Mode](#)
- └ [Wi-Fi Settings: WPS Push](#)
- └ [Wi-Fi Settings: Access Point Set.](#)
- └ [Wi-Fi Settings: Disp MAC Address](#)
- └ [Wi-Fi Settings: SSID/PW Reset](#)
- └ [Bluetooth Settings](#)
- └ [Remote Power Set.](#)
- └ [Edit Device Name](#)
- └ [Reset Network Set.](#)

Using a computer

[Recommended computer environment](#)

Using the software

- [PlayMemories Home](#)
 - [Installing PlayMemories Home](#)
 - [Software for Mac computers](#)
 - [Imaging Edge](#)
-

Connecting this product and a computer

- [Connecting the product to a computer](#)
 - [Importing images to the computer](#)
 - [Disconnecting the product from the computer](#)
-

Creating a movie disc

- [Selecting a disc to be created](#)
 - [Creating Blu-ray Discs from high-definition image quality movies](#)
 - [Creating DVD discs \(AVCHD recording discs\) from high-definition image quality movies](#)
 - [Creating DVD discs from standard image quality movies](#)
-

[Camera control boxes](#)

Precautions/This product

[Precautions](#)

[On the internal rechargeable battery.](#)

[Notes on the battery pack](#)

[Charging the battery pack](#)

[Notes on memory card](#)

[On cleaning](#)

Number of recordable still images and recordable time of movies

- [Number of still images](#)
 - [Recordable time of movies](#)
-

Using this product abroad

- [Using the AC Adaptor/battery charger abroad](#)
- [On TV color systems](#)

Other information

[ZEISS lens](#)

[AVCHD format](#)

[License](#)

[Trademarks](#)

Troubleshooting

If you have problems

[Troubleshooting](#)

Messages

[Self-diagnosis display](#)

[Warning messages](#)

Checking the camera and the supplied items

The number in parentheses indicates the number of pieces.

- Camera (1)
- NP-BJ1 Rechargeable battery pack (1)
- Micro USB Cable (1)

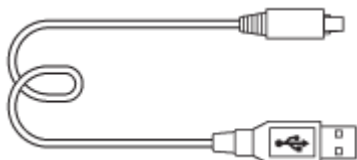

- AC Adaptor (1)
- Power cord (mains lead) (1)* (supplied in some countries/regions)

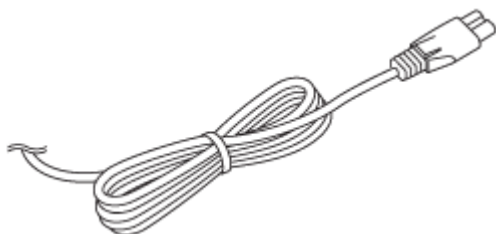

* Multiple power cords may be supplied with your camera. Use the appropriate one that matches your country/region.

- Wrist Strap (1)



- Memory card protector (1)

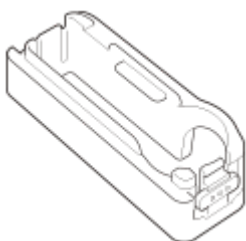

- Instruction Manual (1)

Identifying parts

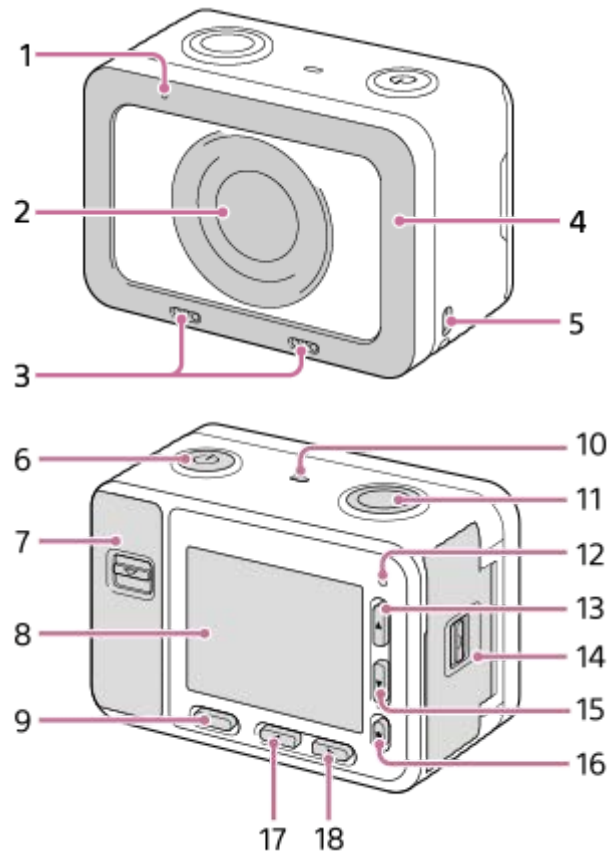

When the covers are open

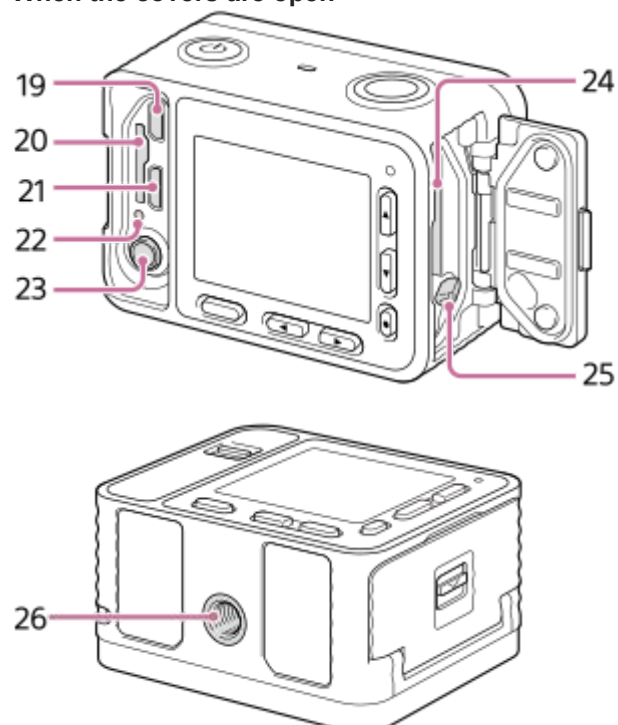

- 1. Recording lamp
- 2. Lens
- 3. Internal microphones

- Do not cover this part during movie recording. Doing so may cause noise or lower the volume.



4. Lens protector

- You can replace this part with an optional accessory (sold separately).

5. Hook for strap

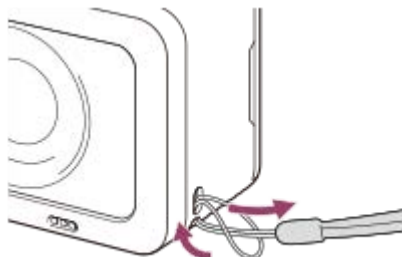
- To avoid dropping the camera, attach the wrist strap and place your hand through the strap when performing hand-held shooting.



6.  (On/Standby) button
7. Memory card/connector cover
8. Monitor
9. MENU button
10. Speaker
11. SHUTTER/MOVIE button
12. Recording lamp
13. Up button/DISP (Display switching) button
14. Battery cover
15. Down button/  (Playback) button
16.  (Enter) button/Custom key
17. Left button/Custom key
18. Right button/Fn (Function) button
19. HDMI micro jack
20. Memory card slot
21. Multi/Micro USB Terminal

- For details on compatible accessories for the Multi/Micro USB Terminal, visit the Sony website, or consult your Sony dealer or local authorized Sony service facility.

22. Access lamp/charge lamp

23. Microphone jack

- When an external microphone is connected, the internal microphone is turned off automatically. When the external microphone is a plug-in-power type, the power of the microphone is supplied by the camera.

24. Battery insertion slot

25. Battery lock lever

26. Tripod socket hole

- Use a tripod with a screw 5.5 mm (7/32 inches) or shorter in length.

To use the camera with the memory card/connector cover detached

You can detach the memory card/connector cover. When you use the camera with cables connected, detach the memory card/connector cover.

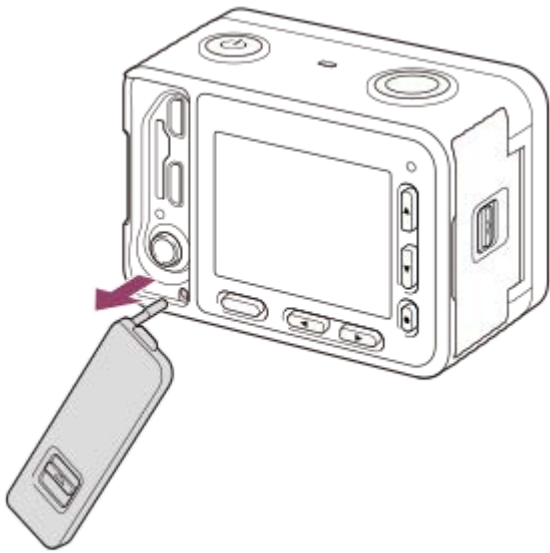

To reattach the memory card/connector cover, insert it into the camera.

Memory card protector

Attach the memory card protector when you use the camera with an HDMI cable, micro USB cable, or external microphone connected. The memory card protector prevents memory card access errors when the memory card is accidentally loosened due to vibration or shock, etc.



To remove the memory card protector, pull it out while pressing the holding parts on the top and the bottom of the protector.

RAW RAW+J X.FINE FINE STD

Image quality of still images

120p 100p 60p 50p 60i 50i 30p 25p 24p

Frame rate of movies

50 FX FH PS 1080 720

Record setting of movies



Remaining battery



Remaining battery warning



USB power supply



Bluetooth connection



Connected to smartphone to control the camera/Not connected to smartphone (Single/Multi (Group Owner)/Multi (Client))



Airplane Mode



Overlay icon



No audio recording of movies



Wind Noise Reduct.



Setting Effect OFF



Database file full/Database file error



Overheating warning



Smart Zoom/ Clear Image Zoom/Digital Zoom



Spot metering area

C:32:00

Self-diagnosis display



Audio Level Display



View Mode

100-0003

Folder-File number

XAVC S HD AVCHD MP4

File format of movies



Protect

DPOF

DPOF set



PC Remote



Copyright information writing on

240fps 250fps 480fps 500fps 960fps 1000fps

Frame rate for HFR shooting



Recording timing



Gamma Disp. Assist



Writing data/Number of images left to write

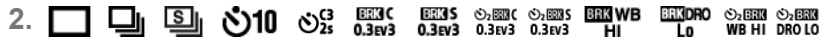

Drive Mode



Metering Mode



Focus Mode

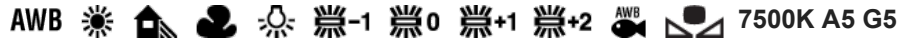

White Balance



Focus Area



DRO/Auto HDR



Creative Style /Contrast, Saturation, Sharpness



Picture Effect



Picture Profile



Zebra

3. ● Lock-on AF

● Lock-on AF Cancel

Guide display for Lock-on AF

● Select Focus Point On/Off

Guide display for setting [Focus Area]

● Set to NEAR

● Cancel NEAR mode

Guide display for setting [Preset Focus]

● Set Focus

Guide display for setting [Manual Focus]

● Shooting Standby

● Shooting Setting

Guide display for HFR shooting



NEAR mode



Bracket indicator

STBY

Movie recording standby

REC

0:12

Recording time of the movie (m:s)

1/250

Shutter speed

F4.0

Aperture Value (The aperture value of this camera is fixed at F4.0.)

 **±0.0**

Metered Manual

 **±0.0**

Exposure compensation

ISO400

ISO sensitivity



AE lock

0.5 0.7 3 ∞
 m

Focus index



Histogram



Picture Effect error



Auto HDR image warning

2017-1-1

10:37AM

Date of recording

3/7

File number/Number of images in the view mode



Copyright information exists for image



REC Control

Inserting the battery pack into the camera

Explains how to insert the battery pack into the camera.

1 Open the battery cover.

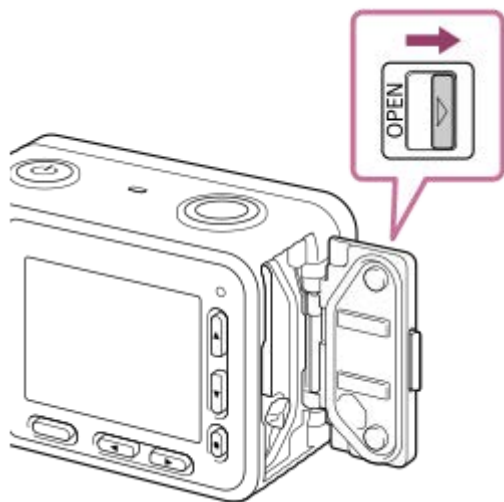

2 Insert the battery pack while pressing the battery lock lever (A) with the tip of the battery until the battery locks into place.

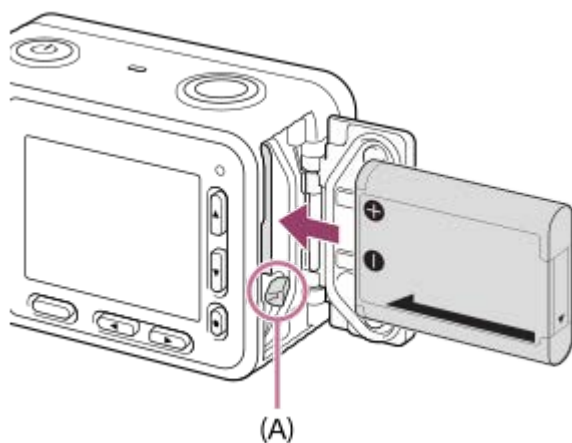

3 Close the cover.

Note

- When closing the cover, make sure that the yellow mark under the slide lock is hidden and the cover is tightly closed. If foreign matter such as grains of sand is caught inside the cover, it may damage the sealing gasket and cause water penetration.

Charging the battery pack while it is inserted in the camera

When using the camera for the first time, be sure to charge the battery pack. The charged battery pack will discharge little by little, even if you do not use it. To avoid missing a shooting opportunity, charge the battery pack before shooting.

- 1 Turn the power off.
- 2 Connect the camera with the battery pack inserted to the AC Adaptor (supplied) using the micro USB cable (supplied), and connect the AC Adaptor to the wall outlet (wall socket).

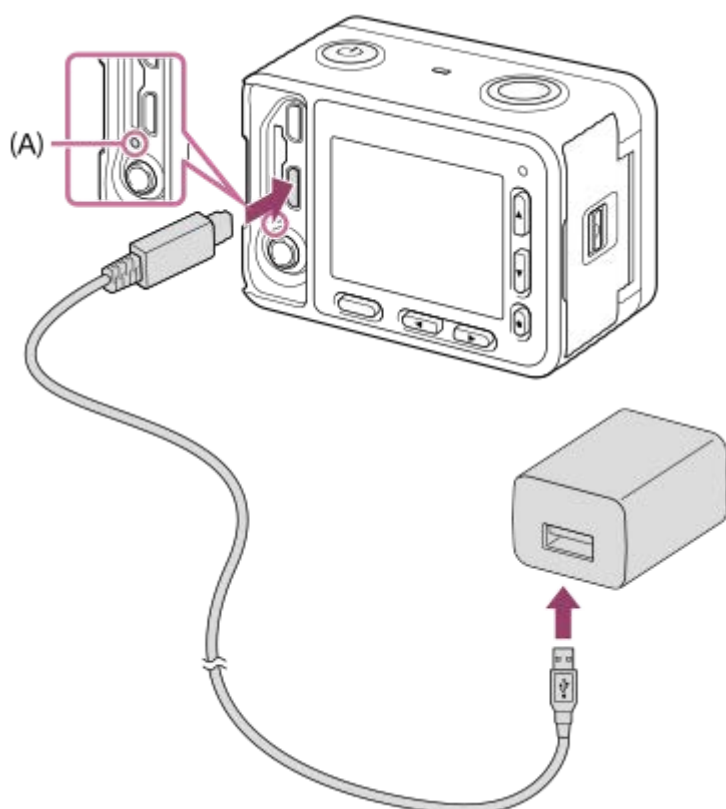

A: Charge lamp

Lit (orange): Charging

Off: Charging finished

Flashing (orange): Charging error or charging paused temporarily because the camera is not within the proper temperature range

- If the charge lamp lights up once and then immediately turns off, the battery pack is fully charged.

Charging time (Full charge)

The charging time is approximately 135 min. using the AC Adaptor (supplied).

- The charging time may differ depending on the remaining capacity of the battery pack or the charging conditions.
- The battery pack can be charged even when it is not fully depleted.
- The above charging time applies when charging a fully depleted battery pack (supplied) at a temperature of 25°C (77°F). Charging may take longer depending on the conditions of use and the environment.

Note

- If the charge lamp flashes when the battery pack is not fully charged, remove the battery pack or disconnect the USB cable from the camera and then re-insert it to recharge.
- If the charge lamp on the camera flashes when the AC Adaptor is connected to the wall outlet (wall socket), this indicates that charging is temporarily stopped because the temperature is outside the recommended range. When the temperature gets back within the appropriate range, the charging resumes. We recommend charging the battery pack at an ambient temperature of between 10°C to 30°C (50°F to 86°F).
- Use a nearby wall outlet (wall socket) when using the AC Adaptor/Battery Charger. If any malfunction occurs, disconnect the plug from the wall outlet (wall socket) immediately to disconnect from the power source. If you use the product with a charge lamp, note that the product is not disconnected from the power source even when the lamp turns off.
- When you use a completely new battery pack or a battery pack that has not been used for a long time, the charge lamp may flash quickly when the battery is charged. If this happens, remove the battery pack or disconnect the USB cable from the camera and then re-insert it to recharge.
- Do not continuously or repeatedly charge the battery pack without using it if it is already fully charged or close to fully charged. Doing so may cause a deterioration in battery performance.
- When charging is finished, disconnect the AC Adaptor from the wall outlet (wall socket).
- Be sure to use only genuine Sony brand battery packs, micro USB cables (supplied) and AC Adaptors (supplied).

Related Topic

- [Notes on the battery pack](#)
- [Charging the battery pack](#)
- [Using the AC Adaptor/battery charger abroad](#)

Charging by connecting to a computer

The battery pack can be charged by connecting the camera to a computer using a micro USB cable.

- 1 Turn off the product, and connect to the USB terminal of the computer.

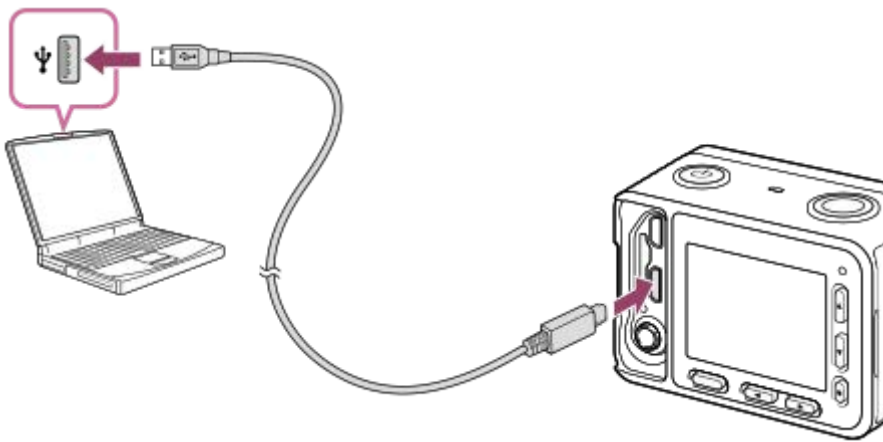

Note

- Note the following points when charging via a computer:
 - If the product is connected to a laptop computer that is not connected to a power source, the laptop battery level decreases. Do not leave the product connected to a laptop computer for an extended period of time.
 - Do not turn on/off or restart the computer, or wake the computer from sleep mode when a USB connection has been established between the computer and the camera. Doing so may cause a malfunction. Before turning on/off or restarting the computer, or waking the computer from sleep mode, disconnect the camera from the computer.
 - Proper operation cannot be guaranteed on all types of computers.
 - Charging cannot be guaranteed with a custom-built computer, modified computer, or a computer connected through a USB hub.
 - The camera may not operate correctly when other USB devices are used at the same time.

Related Topic

- [Notes on the battery pack](#)
- [Charging the battery pack](#)

Battery life and the number of images that can be recorded using a battery pack

	Battery life	Number of images
Shooting (still images)	—	Approx. 240
Actual shooting (movies)	Approx. 35 min.	—
Continuous shooting (movies)	Approx. 60 min.	—

Note

- The above battery life and number of images applies when the battery pack has been fully charged. The battery life and number of images may decrease depending on the conditions of use.
- The battery life and number of images that can be recorded is for shooting under the following conditions:
 - The battery pack is used at an ambient temperature of 25°C (77°F).
 - Using Sony microSDXC memory card (sold separately)
- The number for “Shooting (still images)” is based on the CIPA standard, and is for shooting under the following conditions (CIPA: Camera & Imaging Products Association):
 - One picture is taken every 30 seconds.
 - The power is turned on and off once every ten times.
- The number of minutes for movie shooting is based on the CIPA standard, and is for shooting under the following conditions:
 - The image quality is set to XAVC S HD 60p 50M/50p 50M.
 - [Auto Pwr OFF Temp.]: [High]
 - Actual shooting (movies): Battery life based on repeated shooting, shooting stand-by, turning on/off, etc.
- If the remaining battery is not displayed, press the DISP (Display Setting).



Digital Still Camera
DSC-RX0

Supplying power from a wall outlet (wall socket)

By using the supplied AC adaptor, you can shoot and playback images while the power is supplied from a wall outlet (wall socket).

- 1 **Connect the camera to the wall outlet (wall socket) with a micro USB cable (supplied) and an AC adaptor (supplied).**

Note

- Before you shoot or play back images with power supplied from a wall outlet (wall socket), insert a charged battery pack into the camera.
- If you use the camera while power is being supplied from a wall outlet (wall socket), make sure that the icon that indicates power is being supplied via USB ( / ) is displayed on the monitor.
- Do not remove the battery pack or the micro USB cable while the access lamp is lit. The data in the memory card may be damaged.
- As long as the power is on, the battery pack will not be charged even if the camera is connected to the AC Adaptor.
- Depending on the camera and battery temperature, the continuous recording time may be shortened while power is supplied from a wall outlet (wall socket).
- When using a mobile charger as a power source, confirm that it is fully charged before use. Also, be careful of the remaining power on the mobile charger during use.

Removing the battery pack

Explains how to remove the battery pack.

- 1** Make sure that the access lamp is not lit, and turn off the camera.
- 2** Open the battery cover.
- 3** Slide the battery lock lever (A) and remove the battery pack.

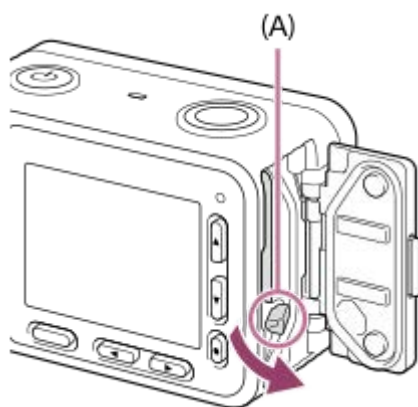

- Be careful not to drop the battery pack.

Digital Still Camera
DSC-RX0

Inserting a memory card

Explains how to insert a memory card.

1 Open the memory card/connector cover.



2 Insert the memory card.

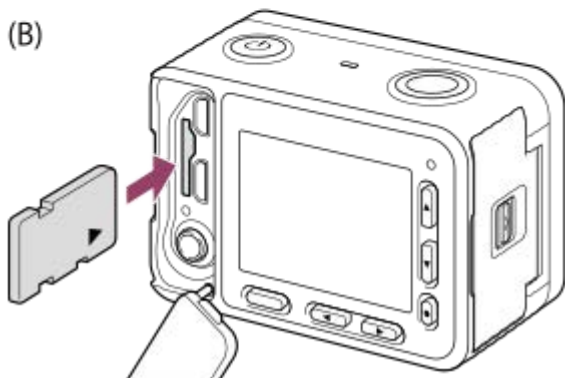
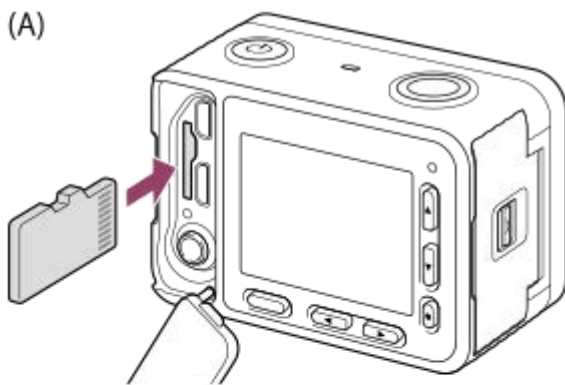

- For microSD/microSDHC/microSDXC cards: Insert a memory card with the card facing as illustrated in Figure (A).
- For Memory Stick Micro media: Insert a memory card with the card facing as illustrated in Figure (B).

3 Close the cover.

Hint

- When you use a memory card with this product for the first time, it is recommended that you format the card using the product for stable performance of the memory card.

Note

- When closing the cover, make sure that the yellow mark under the slide lock is hidden and the cover is tightly closed. If foreign matter such as grains of sand is caught inside the cover, it may damage the sealing gasket and cause water penetration.

Related Topic

- [Notes on memory card](#)
- [Format](#)

Digital Still Camera
DSC-RX0

Removing the memory card

Explains how to remove the memory card.

- 1 Open the memory card/connector cover.
- 2 Make sure that the access lamp (A) is not lit.

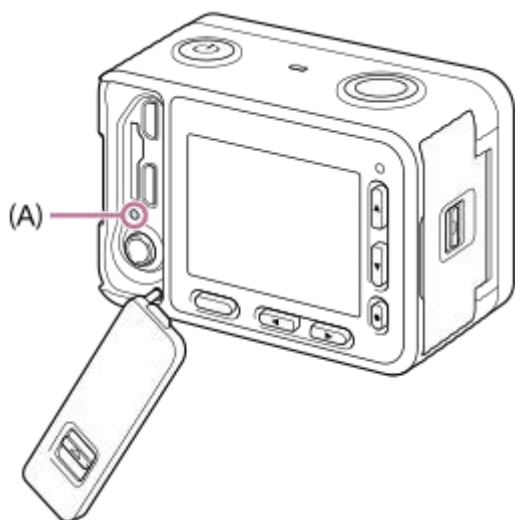

- 3 Push in on the memory card once to remove it.



Related Topic

- [Notes on memory card](#)

Usable memory cards

You can use the following types of memory cards with this camera. The ✓ mark indicates that these memory cards can be used for shooting still images or movies.

Memory card	For still images	For movies		
		MP4	AVCHD	XAVC S
Memory Stick Micro (M2)	✓	✓ (Mark2 only)	✓ (Mark2 only)	—
microSD memory card	✓	✓ *1	✓ *1	—
microSDHC memory card	✓	✓ *1	✓ *1	✓ *2
microSDXC memory card	✓	✓ *1	✓ *1	✓ *2

*1 SD Speed Class 4 (CLASS 4) or faster, or UHS Speed Class U1 (U1) or faster

*2 SD Speed Class 10 (CLASS 10), or UHS Speed Class U1 (U1) or faster

Note

- When a microSDHC memory card is used to record XAVC S or MP4 movies over extended periods of time, the recorded movies will be divided into files of 4 GB. The divided files can be integrated into a single file using PlayMemories Home.
- Not all memory cards are guaranteed to operate correctly.
- When you use a memory card with the camera for the first time, it is recommended that you format the card on the camera before use for more stable performance of the memory card.
Note that formatting erases all data on the memory card permanently, and is irreversible. Save valuable data on a computer, etc.
- Images recorded on a microSDXC memory card cannot be imported to or played on computers or AV devices that are not compatible with exFAT when connected using a micro USB cable. Make sure that the device is compatible with exFAT before connecting it to the camera. If you connect your camera to an incompatible device, you may be prompted to format the card. Never format the card in response to this prompt, as doing so will erase all data on the card. (exFAT is the file system used on microSDXC memory cards.)







Related Topic

- [Notes on memory card](#)

Setting language, date and time

When you turn on the camera for the first time or after you have initialized the functions, the setting screen for language, date and time will appear.

- 1 Turn on the camera.**

The language setting screen will appear and then setting screen for date and time will appear.
- 2 Select your language, and then press the  (Enter) button.**
- 3 When the message [Set Area/Date/Time.] is displayed, select [Enter] and press the  (Enter) button.**
- 4 Select your desired geographic location, and then press the  (Enter) button.**
- 5 Select a setting item using the up/down button, and then press the  (Enter) button.**
- 6 Set [Daylight Savings], [Date/Time], and [Date Format] using the up/down button, and then press the  (Enter) button.**
 - Midnight is indicated as 12:00 AM, and noon as 12:00 PM.
- 7 Repeat steps 5 and 6 to set other items, then select [Enter] and press the  (Enter) button.**

Note

- If the date and time setting is cancelled halfway, the setting screen for the date and time appears every time you turn on the camera.

Related Topic



- [Date/Time Setup](#)
- [Area Setting](#)

Using the up/down/left/right buttons and the Enter button

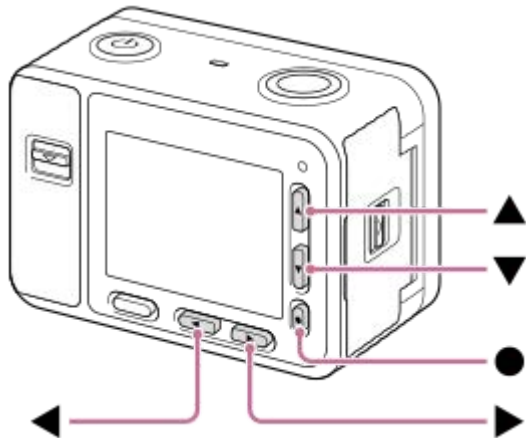
You can select setting items by pressing the up/down/left/right buttons. Your selection is determined when you press the ● (Enter) button.



- ▲ : Up button
- ▼ : Down button
- ◀ : Left button
- ▶ : Right button
- : Enter button

- DISP (Display Setting) is assigned to the up button. Each time you press the DISP button, the displayed content changes.
-  (Playback) is assigned to the down button in shooting mode. Pressing the  (Playback) button switches the camera from shooting mode to playback mode.
- Fn (Function) is assigned to the right button in shooting mode.
- You can assign the desired functions to the left button and the ● (Enter) button in shooting mode.
- You can display the previous/next image by pressing the left/right button during playback.

Related Topic

- [Function of the Enter button](#)
- [Function of the Left button](#)

Using MENU items

In this section, you learn how to change settings related to all camera operations and execute camera functions including shooting, playback, and operation methods.

- 1 Press MENU button to display the MENU items.

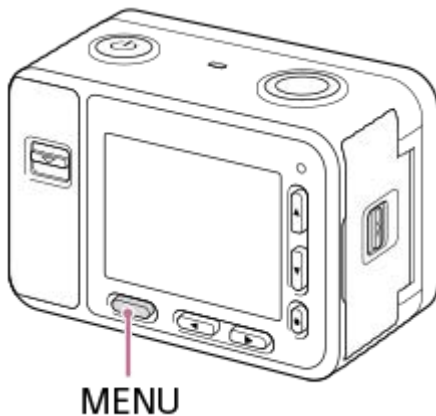

- 2 Select the desired MENU item using the up/down/left/right buttons, and then press the ● (Enter) button.
 - The display may move directly from step 1 to step 3 depending on the [Tile Menu] setting.

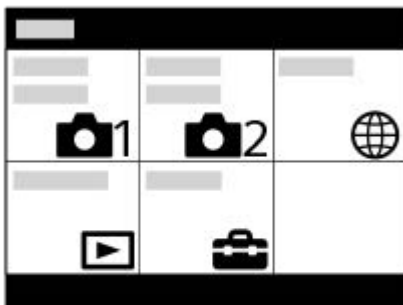

- 3 Select the setting you want to adjust using the up/down/left/right buttons, and then press the ● (Enter) button.
 - You can move to another MENU item by selecting one of the icons at the top of the screen (A) and pressing the left/right button.
 - You can go back to the previous screen by pressing the MENU button (B).

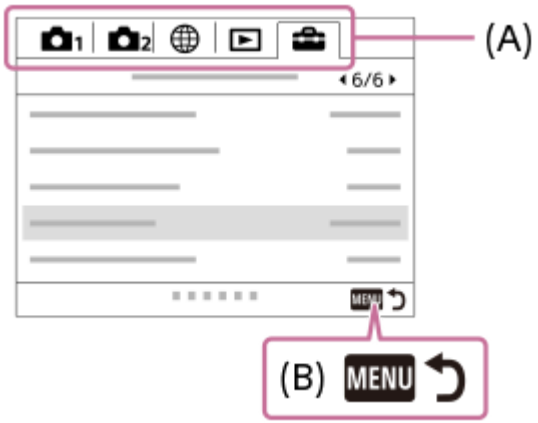

- 4 Select the desired setting value, and press the ● (Enter) button to confirm.

Related Topic

- [Tile Menu](#)



Digital Still Camera
DSC-RX0

Using the Fn (Function) button

You can register frequently used functions to the Fn (Function) button and recall them while shooting. Up to 12 frequently used functions can be registered to the Fn (Function) button.

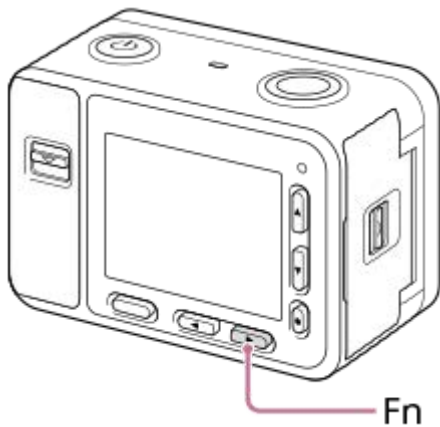
- 1 Press the Fn (Function) button in shooting mode.



- 2 Select a function to register by pressing the up/down/left/right buttons, and then press the  (Enter) button.
- 3 Select the desired setting by following the operating guide (A) , and then press the  (Enter) button.

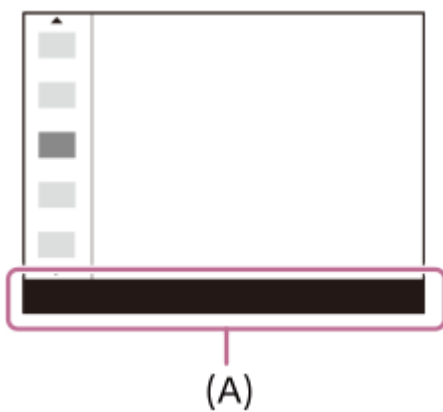

Related Topic

- [Function Menu Set.](#)

Shooting still images

Shoots still images.

- 1 **MENU** →  1 (Camera Settings1) → [Shoot Mode] → [Intelligent Auto].

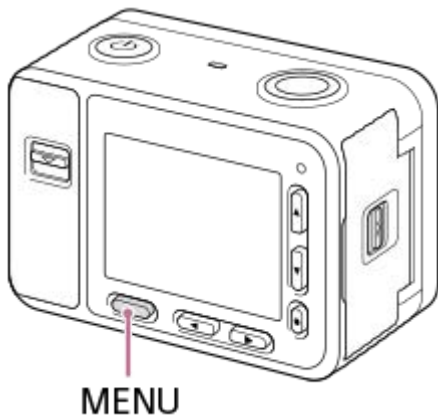

- 2 Point the camera to the subject.

- 3 Press the **SHUTTER/MOVIE** button halfway down to focus.

- When the image is in focus, a beep sounds and the focus indicator (●) lights up.

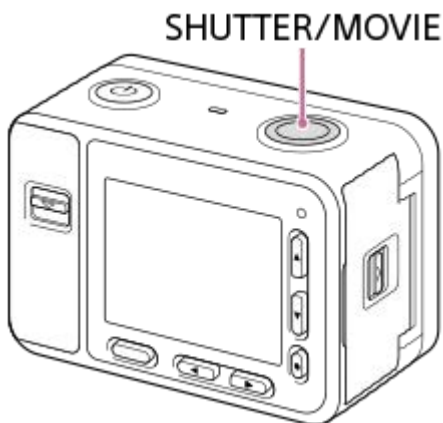

- The shortest shooting distance is approximately 50 cm (1.7 ft) (from the lens).

- 4 Press the **SHUTTER/MOVIE** button fully down.

Focus indicator

- lights:
Image is in the focus.
- flashes:
The focusing has failed.



- When the product cannot focus automatically, the focus indicator flashes and the beep does not sound. Either recompose the shot or change the focus setting.
- Focusing may be difficult in the following situations:
 - It is dark and the subject is distant.
 - The contrast of the subject is poor.
 - The subject is seen through glass.
 - The subject is moving quickly.
 - There is reflective light or shiny surfaces.
 - There is a flashing light.
 - The subject is backlit.
 - The subjects in the focus area have different focal distances.

Related Topic

- [The advantages of automatic shooting](#)
- [About Scene Recognition](#)
- [Playing back images](#)

Shooting movies

Shoots movies.

- 1 **MENU** →  (Camera Settings1) → [Shoot Mode] →  (Intelligent Auto).

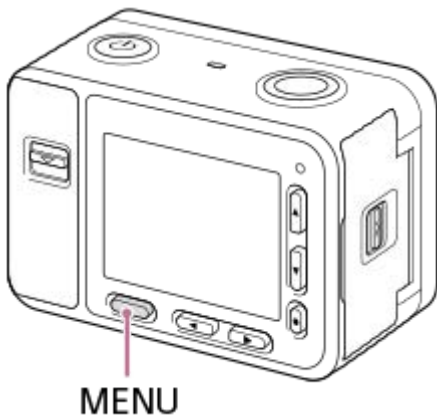

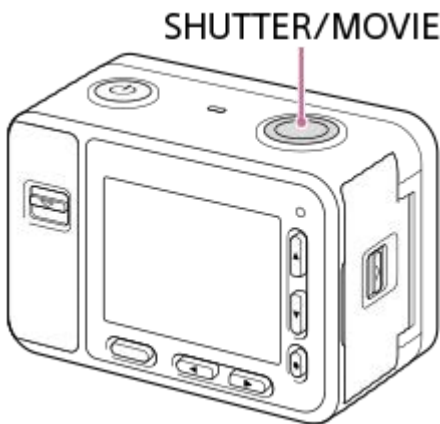

- 2 Press the **SHUTTER/MOVIE** button to start recording.

- You can set the focus method for shooting movies to either [Preset Focus] or [Manual Focus].







- 3 Press the **SHUTTER/MOVIE** button again to stop recording.

Hint

- You can assign the start/stop movie recording function to a preferred key. Select **MENU** →  (Camera Settings2) → [Custom Key(Shoot.)] → set [MOVIE] to the preferred key.
- You can adjust the shutter speed as desired. Select **MENU** →  (Camera Settings1) → set [Shoot Mode] to [ Manual Exposure].

Note

- The monitor turns off after approximately one minute without any operations by the user during movie recording (default setting). To turn on the monitor again, press either the MENU button, any of the up/down/left/right buttons, or the  (Enter) button. If you set **MENU** →  (Camera Settings2) → [ Mon. Off dur REC] to [Off], the monitor will not turn off during movie recording.

- Sound from camera operations is recorded during movie recording. The sound of the SHUTTER/MOVIE button operating may be recorded when movie recording is finished.
- Recording may stop to protect the camera depending on the ambient temperature.
- Sound will not be recorded if you select MENU →  2 (Camera Settings2) → [Audio Recording] → [Off].

Related Topic

- [Intelligent Auto \(movie\)](#)
- [Preset Focus](#)
- [Manual Focus](#)
- [File Format \(movie\)](#)
- [MOVIE Button](#)
- [Recordable time of movies](#)
- [Custom Key\(Shoot.\)](#)

Selecting a shooting mode

Set the shooting mode according to the subject you want to shoot and the functions you want to use.

1 MENU →  (Camera Settings1) → [Shoot Mode] → desired mode.

- You can also change the shooting mode by pressing the left button in the default settings.

Menu item details

(Intelligent Auto):

Shoots with automatic scene recognition.

+ (Superior Auto):

Shoots with automatic scene recognition. This mode takes clear images of dark or backlit scenes.

P (Program Auto):

Shoots with the exposure (shutter speed) adjusted automatically. Various functions can be set with Fn (Function) and MENU.

M (Manual Exposure):

Shoots with the shutter speed adjusted manually.

MR (Memory recall):

Shoots an image after recalling frequently used modes or camera settings registered in advance.

(Intelligent Auto):

Shoots movies with automatic settings of the camera.

P (Program Auto):

Shoots movies with the exposure (shutter speed) automatically set by the camera. Various functions can be set with Fn (Function) and MENU.

M (Manual Exposure):

Shoots movies with the shutter speed adjusted manually.

HFR (High Frame Rate):

Records smooth super-slow-motion movies by shooting with a higher frame rate than the recording format.

Related Topic

- [Intelligent Auto \(still image\)](#)
- [Superior Auto \(still image\)](#)
- [Program Auto \(still image/movie\)](#)
- [Manual Exposure \(still image/movie\)](#)
- [Memory recall \(Camera Settings1/Camera Settings2\)](#)
- [Intelligent Auto \(movie\)](#)
- [Shooting super-slow-motion movies \(High Frame Rate\)](#)

Intelligent Auto (still image)

The camera shoots with automatic scene recognition.

1 MENU →  1 (Camera Settings1) → [Shoot Mode] → [Intelligent Auto].

2 Point the camera to the subject.

When the camera recognized the scene, the icon for the recognized scene appears on the screen.



3 Press the SHUTTER/MOVIE button halfway down to focus, and then press the SHUTTER/MOVIE button fully down to take the picture.

Related Topic

- [The advantages of automatic shooting](#)
- [About Scene Recognition](#)

Digital Still Camera
DSC-RX0

Superior Auto (still image)

The camera shoots with automatic scene recognition. This mode takes clear images of dark or backlit scenes.

For low-lit or backlit scenes, if necessary the camera may shoot multiple images and create a composite image, etc., to record higher quality images than in Intelligent Auto mode.

1 MENU →  1 (Camera Settings1) → [Shoot Mode] → [Superior Auto].

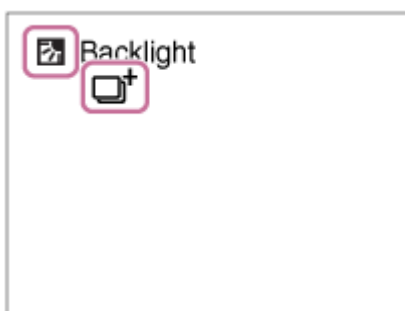

2 Point the camera to the subject.

When the camera recognizes a scene, the scene recognition icon appears on the screen. If necessary,  (overlay icon) may appear.



3 Press the SHUTTER/MOVIE button halfway down to focus, and then press the SHUTTER/MOVIE button fully down to take the picture.

Note

- When the product is used to create composite images, the recording process takes longer than usual.
- When the  (overlay icon) is displayed, be sure not to move the camera before the multiple shots are recorded.
- The product may not properly recognize a scene under some shooting conditions.
- When [ Quality] is set to [RAW] or [RAW & JPEG], the product cannot create a composite image.

Related Topic

- [The advantages of automatic shooting](#)
- [About Scene Recognition](#)

Digital Still Camera
DSC-RX0









About Scene Recognition

Scene Recognition operates in [Intelligent Auto] mode and [Superior Auto] mode.

This function allows the product to automatically recognize the shooting conditions and shoot the image.

Scene Recognition

When the product recognizes certain scenes, the following icons and guides are displayed on the first line:

-  (Portrait)
-  (Infant)
-  (Night Portrait)
-  (Night Scene)
-  (Backlight Portrait)
-  (Backlight)
-  (Landscape)
-  (Spotlight)
-  (Low Light)

Note

- When [Face Detection] is set to [Off], the [Portrait], [Backlight Portrait], [Night Portrait] and [Infant] scenes are not recognized.

Related Topic

- [Intelligent Auto \(still image\)](#)
- [Superior Auto \(still image\)](#)

Digital Still Camera
DSC-RX0

The advantages of automatic shooting

This camera is equipped with the following three automatic shooting modes: [Intelligent Auto], [Superior Auto], and [Program Auto].

i  **(Intelligent Auto):**

Allows you to shoot with automatic scene recognition.



i  **(Superior Auto):**

Allows you to shoot with automatic scene recognition. This mode takes clear images of dark or backlit scenes.

P (Program Auto):

Allows you to adjust various shooting settings such as white balance or ISO value, etc. The shutter speed is automatically set by the camera.

Note

- In [Superior Auto] mode, the recording process takes longer, since the product creates a composite image. In this case, the  (overlay icon) is displayed and the shutter sound is heard multiple times, but only one image is recorded.
- In [Superior Auto] mode and when the  (overlay icon) is displayed, be sure not to move the camera before the multiple shots are recorded.
- For [Intelligent Auto] and [Superior Auto] mode, most of the functions are set automatically, and you cannot adjust the settings on your own.

Related Topic



- [Intelligent Auto \(still image\)](#)
- [Superior Auto \(still image\)](#)
- [Program Auto \(still image/movie\)](#)

Digital Still Camera
DSC-RX0

Program Auto (still image/movie)

Allows you to shoot with the exposure (shutter speed) adjusted automatically.

You can set shooting functions such as [ISO].

- 1 MENU →  1 (Camera Settings1) → [Shoot Mode] → [Program Auto] or [ Program Auto].
- 2 Set the shooting functions to your desired settings.
- 3 Press the SHUTTER/MOVIE button to shoot the image.
 - Press the SHUTTER/MOVIE button again to stop recording during movie shooting.

Related Topic

- [The advantages of automatic shooting](#)

Manual Exposure (still image/movie)

You can shoot with the desired exposure setting by adjusting the shutter speed. The shutter speed can be changed while recording movies.

1 MENU → 1 (Camera Settings1) → [Shoot Mode] → [Manual Exposure] or [Manual Exposure].

2 MENU → 1 (Camera Settings1) → [Shutter Speed].

3 Use the left/right buttons to select the setting value and press the (Enter) button.

When [ISO] is set to other than [ISO AUTO], use MM (Metered Manual) to check the exposure value.

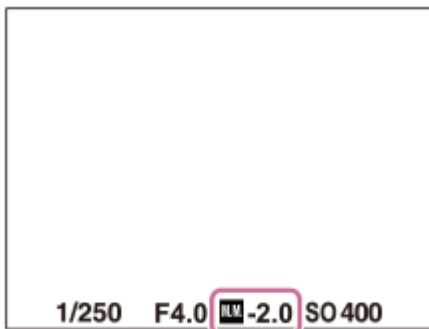

Toward +: Images become brighter.

Toward -: Images become darker.

0: Appropriate exposure analyzed by the product.

4 Press the **SHUTTER/MOVIE** button to shoot the image.

- Press the SHUTTER/MOVIE button again to stop recording during movie shooting.

Note

- The aperture value of this camera is fixed at F4.0.
- When [ISO] is set to [ISO AUTO], the ISO value automatically changes to achieve the appropriate exposure using the shutter speed you have set. If the shutter speed you have set are not suitable for appropriate exposure, the ISO value indicator will blink.
- The Metered Manual indicator does not appear when [ISO] is set to [ISO AUTO].
- When the amount of ambient light exceeds the metering range of the Metered Manual, the Metered Manual indicator flashes.
- The brightness of the image on the monitor may differ from the actual image being shot.



Related Topic





- [Shutter Speed](#)





Digital Still Camera
DSC-RX0

Memory recall (Camera Settings1/Camera Settings2)

Allows you to shoot an image after recalling frequently used modes or camera settings registered to [1/2 Memory] in advance.

- 1 MENU →  (Camera Settings1) → [Shoot Mode] → [Memory recall].
- 2 Press the left/right buttons to select the desired number, and then press the  (Enter) button.
 - You can also recall registered modes by selecting MENU →  (Camera Settings1) → [1/2 Recall].

Note

- If you set [1/2 Recall] after completing the shooting settings, the registered settings are given priority and the original settings may become invalid. Check the indicators on the screen before shooting.



Related Topic

- [Memory \(Camera Settings1/Camera Settings2\)](#)

Digital Still Camera
DSC-RX0

Intelligent Auto (movie)

You can shoot movies with automatic camera settings.

- 1 **MENU** →  1 (Camera Settings1) → [Shoot Mode] →  (Intelligent Auto).
 - 2 Press the **SHUTTER/MOVIE** button to start recording.
 - 3 Press the **SHUTTER/MOVIE** button again to stop recording.
-

Related Topic

- [Shooting movies](#)

Shooting super-slow-motion movies (High Frame Rate)

By shooting with a higher frame rate than the recording format, you can record a smooth super-slow-motion movie.

- 1 MENU →  1 (Camera Settings1) → [Shoot Mode] → [High Frame Rate] → desired exposure mode.

The shooting setting screen will be displayed.

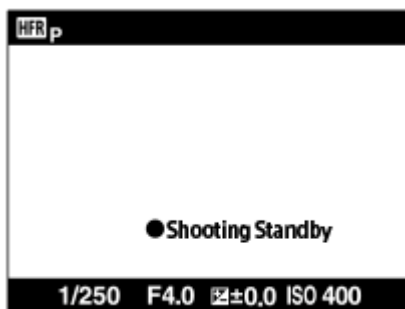

- 2 MENU →  2 (Camera Settings2) → [HFR HFR Settings] → Select the desired settings for [HFR Record Setting], [HFR Frame Rate], [HFR Priority Setting] and [HFR REC Timing].

- 3 Point the camera at the subject and adjust settings such as the focus.
 - You can also change other settings, such as focus mode, ISO sensitivity, etc.

- 4 Press the  (Enter) button.

The shooting standby screen will be displayed.

- [STBY] will be displayed in the bottom left of the screen during shooting standby. While [STBY] is displayed, you cannot adjust the exposure or focus settings including manual focus. To change these settings, press the  (Enter) button again to return to the shooting setting screen.

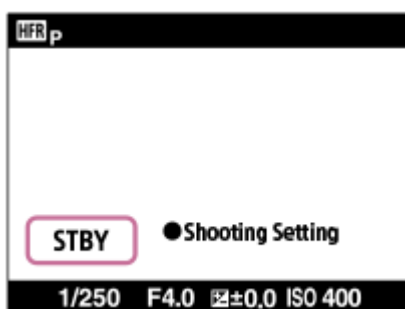

- 5 Press the SHUTTER/MOVIE button.

When [HFR REC Timing] is set to [Start Trigger]:

Movie capturing (shooting) starts. When the SHUTTER/MOVIE button is pressed again, or when the recordable duration of time has elapsed, movie capturing ends and the camera starts to record the captured movie to the memory card.

When [HFR REC Timing] is set to [End Trigger]:

Movie capturing ends and the camera starts to record the captured movie to the memory card.

Note

- Sound will not be recorded.
- The movie will be recorded in XAVC S HD format.
- It may take time for recording to finish after you press the SHUTTER/MOVIE button. Wait until the display switches to the shooting standby screen to start shooting again.

Related Topic

- [Usable memory cards](#)
- [Adjusting the settings for super-slow-motion shooting \(HFR Settings\)](#)
- [Selecting the exposure mode for super-slow-motion shooting \(Exposure Mode\)](#)

Digital Still Camera
DSC-RX0

Shooting images underwater

You can also use this camera underwater. In underwater shooting, the brightness and the white balance are different from what they would be under ordinary shooting conditions. It is recommended that you shoot images with the settings below when you shoot images underwater using this camera alone or with the housing (sold separately).

Set a faster shutter speed (for still images)

In underwater shooting, the subject becomes darker than under ordinary shooting conditions, even if you are shooting outdoors. Set a faster shutter speed because the camera or subject tends to shake in underwater shooting.

- If [Shoot Mode] is set to [Program Auto], set [ISO AUTO Min. SS] to [Faster] or set [ISO] to a higher value to make the shutter speed faster.
- If [Shoot Mode] is set to [Manual Exposure], set a faster [Shutter Speed].

The shutter speed will be slower if the ISO sensitivity is low.

- In [ISO AUTO] mode, set [ISO AUTO Maximum] to a higher value to make the shutter speed faster.

Change the [White Balance] setting (for still images/movies)

In underwater shooting, the appropriate white balance is different from the white balance under ordinary shooting conditions.

- Set [White Balance] to [Underwater Auto].

Note

- The optical specifications in this manual were measured in air. Underwater, the minimum shooting distance at which the camera can focus is approximately 1.3 times that in air, and the angle of view is approximately 0.7 times that in air.
- You cannot use wireless functions underwater.

Related Topic

- [ISO](#)
- [ISO AUTO Min. SS](#)
- [Shutter Speed](#)
- [White Balance](#)

Switching the screen display (Shooting)

You can change the display contents on the screen.

1 Press the DISP (Display Setting) button.

Each time you press the DISP button, the screen display changes.
Display All Info.

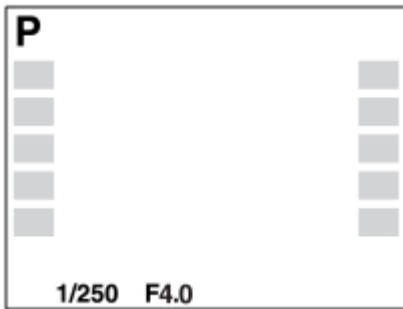

No Disp. Info.

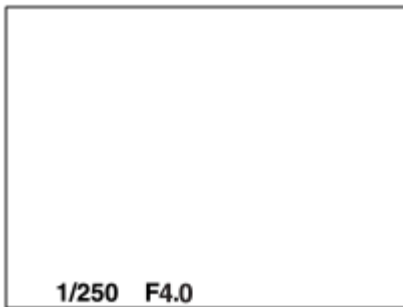

Histogram

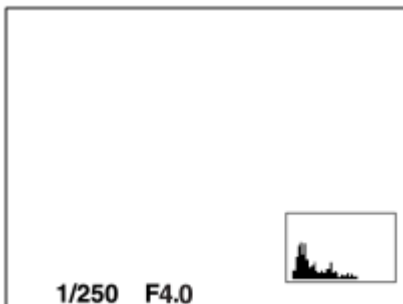

Hint

- To hide the grid lines displayed during shooting, select MENU →  2 (Camera Settings2) → [Grid Line] → [Off].
- To hide the marker displayed during movie recording, select MENU →  2 (Camera Settings2) → [ Marker Display] → [Off].



- [Grid Line](#)
- [Marker Display \(movie\)](#)

4-698-613-13(1) Copyright 2017 Sony Corporation

Digital Still Camera
DSC-RX0

Image Size (still image)

The larger the image size, the more detail will be reproduced when the image is printed on large-format paper. The smaller the image size, the more images can be recorded.

1 MENU →  (Camera Settings1) → [ Image Size] → desired setting.

Menu item details

When [ Aspect Ratio] is set to [3:2]

L: 15M: 4800×3200 pixels

M: 7.7M: 3408×2272 pixels

S: 3.8M: 2400×1600 pixels

When [ Aspect Ratio] is set to [4:3]

L: 14M: 4272×3200 pixels

M: 6.9M: 3024×2272 pixels

S: 3.4M: 2128×1600 pixels

VGA: 640×480 pixels

When [ Aspect Ratio] is set to [16:9]

L: 13M: 4800×2704 pixels

M: 6.5M: 3408×1920 pixels

S: 3.2M: 2400×1352 pixels



When [ Aspect Ratio] is set to [1:1]

L: 10M: 3200×3200 pixels

M: 5.2M: 2272×2272 pixels

S: 2.6M: 1600×1600 pixels

Note

- When [ Quality] is set to [RAW] or [RAW & JPEG], the image size for RAW images corresponds to [L].
- When you print an image shot with [ Aspect Ratio] set to [16:9], the lateral end of the image may be cut off.



Related Topic

- [Aspect Ratio \(still image\)](#)

Digital Still Camera
DSC-RX0

Aspect Ratio (still image)

Sets the aspect ratio of still images.

1 MENU →  1 (Camera Settings1) → [ Aspect Ratio] → desired setting.

Menu item details

3:2:

Suitable for standard prints.

4:3:

For shooting in a size suitable for viewing on a computer.

16:9:

For viewing on a high-definition TV.

1:1:

For shooting in composition as a medium format camera.

Digital Still Camera
DSC-RX0

Quality (still image)

Selects the compression format of still images.

1 MENU →  1 (Camera Settings1) → [ Quality] → desired setting.

Menu item details

RAW:

File format: RAW (records in the compressed RAW format)

Digital processing is not performed on this file format. Select this format to process images on a computer for professional purposes. The image size is fixed to the maximum size. The image size is not displayed on the screen.

RAW & JPEG:

File format: RAW (records in the compressed RAW format) + JPEG

A RAW image and a JPEG image are created at the same time. This is suitable when you need 2 image files, a JPEG for viewing, and a RAW for editing. The JPEG image quality is set to [Fine].

Extra fine:

File format: JPEG

The image is compressed in the JPEG format and recorded using a higher quality than with [Fine].

Fine:

File format: JPEG

The image is compressed in the JPEG format when recorded.

Standard:

File format: JPEG

The image is compressed in the JPEG format when recorded. Since the compression rate of [Standard] is higher than that of [Fine], the file size of [Standard] is smaller than that of [Fine]. This will allow more files to be recorded on 1 memory card, but the image quality will be lower.

About RAW images

- To open a RAW image file recorded with this camera, the software Imaging Edge is needed. With Imaging Edge, you can open a RAW image file, then convert it into a popular image format such as JPEG or TIFF, or readjust the white balance, saturation or contrast of the image.
- You cannot apply [Auto HDR] or [Picture Effect] functions with RAW images.

Note

- If you do not intend to edit the images on your computer, we recommend that you record in JPEG format.
- You cannot add DPOF (print order) registration marks to RAW images.

Digital Still Camera
DSC-RX0

Focus Mode

Selects the method to suit your purpose (still images or movies).

1 MENU →  1 (Camera Settings1) → [Focus Mode] → desired setting.

Menu item details

AF-S (Single-shot AF):

Press the SHUTTER/MOVIE button halfway down to focus automatically. While the SHUTTER/MOVIE button is pressed halfway down, the focus is locked. This focus mode is available only during still image shooting.

PF (Preset Focus):

The focus is locked so that a satisfying resolution can be achieved in a wide front-to-back range. You can shoot movies without additional focusing operations. When the camera and the subject are close, use the NEAR mode. This focus mode is available only during movie shooting.

MF (Manual Focus):

Adjusts the focus manually.

Note

- If the subject is too close, the image may show any dust or fingerprints on the lens. Wipe the lens with a soft cloth, etc.
- When shooting still images, [Preset Focus] is not available. When shooting movies, [Single-shot AF] is not available.

Related Topic

- [Preset Focus](#)
- [Manual Focus](#)

Focus Area

Selects the focusing area. Use this function when it is difficult to get the proper focus in auto focus mode.

1 MENU →  1 (Camera Settings1) → [Focus Area] → desired setting.

Menu item details

Wide:

Focuses automatically on a subject in all ranges of the image.

When you press the SHUTTER/MOVIE button halfway down, a green frame is displayed around the area that is in focus.

Center:

Focuses automatically on a subject in the center of the image. When used together with the focus lock function, you can compose the image you want.



Flexible Spot:

Allows you to move the focusing frame to the desired point on the screen and focus on an extremely small subject in a narrow area.

Expand Flexible Spot:

If the product fails to focus on the single selected point, it uses the focus points around the flexible spot as the second priority area to achieve focus.

Hint

- When [Focus Area] is set to [Flexible Spot] or [Expand Flexible Spot], pressing the  (Enter) button to which [Focus Standard] has been assigned allows you to shoot images while adjusting the position of the focusing frame by pressing the up/down/left/right buttons. When you want to change the shooting settings using the up/down/left/right buttons, press the  (Enter) button.
- If you cannot focus on the subject by setting [Focus Area] to [Wide], change the setting to [Center] and position the subject within the focusing frame. Press the SHUTTER/MOVIE button halfway down to lock the focus, and return to the original composition to shoot images with the focus locked (Focus Lock).

Note

- Functions assigned to the up/down/left/right buttons cannot be executed while the focusing frame is being moved.

Digital Still Camera
DSC-RX0

Lock-on AF

When you press the **●** (Enter) button, the camera detects the subject positioned in the center of the screen and continues to track the subject.

1 MENU →  (Camera Settings1) → [**●** button Lock-on AF] → [On].

2 Align the target frame (A) over the subject and press the **●** (Enter) button.
Press the **●** (Enter) button again to stop tracking.

- If the camera loses track of the subject, it can detect when the subject reappears on the monitor and resume tracking.

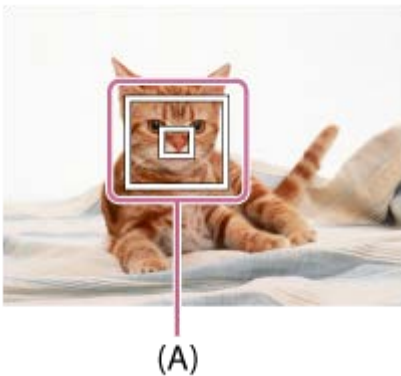

3 Press the SHUTTER/MOVIE button fully down to shoot the image.

Note

- [**●** button Lock-on AF] may not function very well in the following situations:
 - The subject is moving too quickly.
 - The subject is too small, or too large.
 - The contrast between the subject and the background is poor.
 - It is dark.
 - The ambient light changes.
- Lock-on AF does not work in the following situations:
 - When shooting in Manual Focus mode
 - During movie shooting
- The camera may not be able to resume tracking for a while after it loses the track of the subject.

Digital Still Camera
DSC-RX0

AF Area Auto Clear

Sets whether the focus area should be displayed all the time or should disappear automatically shortly after focus is achieved.

1 MENU →  (Camera Settings1) → [AF Area Auto Clear] → **desired setting.**

Menu item details

On:

The focus area disappears automatically shortly after focus is achieved.

Off:

The focus area is displayed all the time.

Focus-lock

Shoots images with the focus locked on the desired subject in auto focus mode.

- 1 MENU →  1 (Camera Settings1) → [Focus Mode] → [Single-shot AF].**
- 2 Place the subject within the AF area and press the SHUTTER/MOVIE button halfway down.**
The focus is locked.
- 3 Keep pressing the SHUTTER/MOVIE button halfway down, and place the subject back in the original position to re-compose the shot.**
- 4 Press the SHUTTER/MOVIE button down fully to take the picture.**

Preset Focus

The focus is locked so that a satisfying resolution can be achieved in a wide front-to-back range. You can shoot movies without additional focusing operations.

1 MENU →  1 (Camera Settings1) → [Focus Mode] → [Preset Focus].

The camera will focus on subjects approximately 1 m (3.3 ft.) or more away from the camera.

- When shooting subjects at close distances of approximately 50 cm to 1 m (1.7 ft. to 3.3 ft.) from the camera, set [NEAR Mode in PF] to [On].

Note

- [Preset Focus] is available only during movie shooting.

Related Topic

- [NEAR Mode in PF](#)

Digital Still Camera
DSC-RX0

NEAR Mode in PF

Sets the NEAR mode when [Focus Mode] is set to [Preset Focus].

1 MENU →  (Camera Settings1) → [NEAR Mode in PF] → desired setting.

Menu item details



Off:

Use this mode to shoot subjects approximately 1 m (3.3 ft.) or more away from the camera. This mode is suitable for regular movie shooting.

On:

Use this mode to shoot subjects approximately 50 cm to 1 m (1.7 ft. to 3.3 ft.) away from the camera. This mode is suitable for close-up shooting.

Hint

- When [Focus Standard] is assigned to the  (Enter) button using [Custom Key(Shoot.)], you can switch between [On] and [Off] by pressing the  (Enter) button in [Preset Focus] mode.

Related Topic

- [Preset Focus](#)

Manual Focus



If you are shooting still images and it is difficult to get the proper focus in autofocus mode, you can adjust the focus manually.

When shooting movies, use this mode in situations such as recording movies while outputting 4K images to an external device, etc. You can make fine adjustments to the focus while monitoring the subject on an external monitor.

1 MENU →  1 (Camera Settings1) → [Focus Mode] → [Manual Focus].

2 MENU →  1 (Camera Settings1) → [Set Focus].

The screen for manual focusing operations will appear.

- When [Focus Standard] is assigned to the  (Enter) button using [Custom Key(Shoot.)], the manual focusing screen can be displayed by pressing the  (Enter) button.

3 Press the up/down/left/right buttons to adjust the focus.

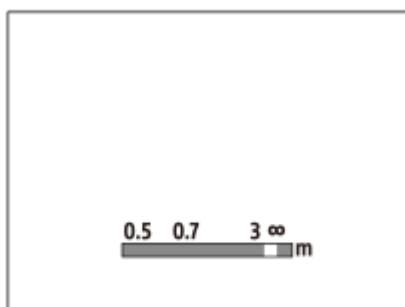

The focusing distance jumps at a fixed interval when you press the up/down buttons in the order of “0.5m ↔ 0.7m ↔ 3m ↔ ∞.”

To perform micro adjustments, press the left/right buttons.

- To enable fine adjustments to the focus under various conditions, the focusing indicator can be moved beyond infinity. When you want to focus at infinity, do not move the indicator to the end of the bar. Instead, adjust the focus while viewing the monitor, etc. and use the ∞ mark where the focusing indicator stops when you press the up button as a guide.
- To return to the shooting screen, press the  (Enter) button.

Note

- Manually set focus distances are cancelled when the [Focus Mode] is reselected.

Hint

- Using [MF Assist] allows you to perform manual focusing more easily because the image is automatically enlarged during the manual focus adjustments.
- When you use [Peaking Level], the outlines of in-focus ranges are enhanced using a specific color. This function allows you to check the focus easily.

Related Topic

- [MF Assist](#)
- [Peaking Level](#)

4-698-613-13(1) Copyright 2017 Sony Corporation

MF Assist

Enlarges the image on the screen automatically to make manual focusing easier. This works in Manual Focus shooting.

- 1 MENU →  1 (Camera Settings1) → [MF Assist] → [On].
- 2 Select MENU →  1 (Camera Settings1) → [Set Focus] and then adjust the focus using the up/down/left/right buttons.

Hint

- You can set how long the image is to be shown magnified by selecting MENU →  1 (Camera Settings1) → [Focus Magnif. Time].

Note

- You cannot change the magnification scale.

Related Topic

- [Manual Focus](#)
- [Focus Magnif. Time](#)

Digital Still Camera
DSC-RX0

Focus Magnif. Time

Set the duration for which an image is to be magnified using the [MF Assist].

1 MENU →  1 (Camera Settings1) → [Focus Magnif. Time] → desired setting.

Menu item details

2 Sec:

Magnifies the images for 2 seconds.

5 Sec:

Magnifies the images for 5 seconds.

No Limit:

Magnifies the images until you press the SHUTTER/MOVIE button.

Related Topic

- [Manual Focus](#)
- [MF Assist](#)

Digital Still Camera
DSC-RX0

Peaking Level

Enhances the outline of in-focus ranges using a specific color in Manual Focus shooting. This function allows you to confirm the focus easily. The setting applies to both still images and movies.

1 MENU →  1 (Camera Settings1) → [Peaking Level] → desired setting.

Menu item details

High:

Sets the peaking level to high.

Mid:

Sets the peaking level to middle.

Low:

Sets the peaking level to low.

Off:

Does not use the peaking function.

Hint

- It is recommended that you use the peaking function in combination with the [MF Assist] function.

Note

- Since the product determines that sharp areas are in focus, the effect of peaking differs, depending on the subject and shooting conditions.
- The outline of in-focus ranges is not enhanced when the product is connected using an HDMI cable.

Related Topic

- [Manual Focus](#)
- [Peaking Color](#)

Digital Still Camera
DSC-RX0

Peaking Color

Sets the color used for the peaking function in Manual Focus shooting. The setting applies to both still images and movies.

1 MENU →  1 (Camera Settings1) → [Peaking Color] → desired setting.

Menu item details

Red:

Enhances outlines in red.

Yellow:

Enhances outlines in yellow.

White:

Enhances outlines in white.

Related Topic

- [Manual Focus](#)
- [Peaking Level](#)

Digital Still Camera
DSC-RX0

AF/MF control

You can easily switch the focusing mode from auto to manual or vice versa while shooting still images.

1 MENU →  2 (Camera Settings2) → [Custom Key(Shoot.)] → button to be assigned → [AF/MF Control Hold] or [AF/MF Ctrl Toggle].

2 Press the button to which the [AF/MF Control Hold] or [AF/MF Ctrl Toggle] function has been assigned while shooting still images.

The focusing mode will temporarily switch from auto to manual or vice versa.

Menu item details

AF/MF Control Hold:

Switches the focusing mode while the button is held down.

AF/MF Ctrl Toggle:





Switches the focusing mode until the button is pressed again.

Note

- The function is not available when shooting movies.
- You cannot set the [AF/MF Control Hold] function to [Left Button].

Eye AF



The camera focuses on the subject's eyes while you keep the button pressed.

- 1 MENU →  2 (Camera Settings2) → [Custom Key(Shoot.)] → [ Button] → assign the [Eye AF] function.
- 2 Point the camera at a person's face, and press the  (Enter) button.
- 3 Press the SHUTTER/MOVIE button fully down to shoot an image while holding down the  (Enter) button.

Hint

- When the camera focuses on the eyes, a detection frame is displayed over the eyes. The detection frame over the eyes turns into the face detection frame after a certain period of time. However, [Eye AF] remains active. The camera continues tracking the eyes unless the distance of the subject changes.

Note

- Depending on the circumstances, the camera may not be able to focus on the eyes. In such cases, the camera detects a face and focuses on the face.
- If the camera cannot detect a person's face, you cannot use [Eye AF].
- Depending on the circumstances, you cannot use [Eye AF], such as when [Focus Mode] is set to [Manual Focus], etc.
- [Eye AF] may not function in the following situations:
 - When the person is wearing sunglasses.
 - When the front hair covers the person's eyes.
 - In low-light or back-lit conditions.
 - When the eyes are closed.
 - When the person is in the shade.
 - When the person is out of focus.
 - When the person is moving too much.
- If the person is moving too much, the detection frame may not display correctly over their eyes.
- When [Shoot Mode] is set to one of the following, or during movie shooting, you cannot use [Eye AF].
 - [ Intelligent Auto]
 - [ Program Auto]
 - [ Manual Exposure]
 - [High Frame Rate]



Related Topic

- [Custom Key\(Shoot.\)](#)
- [Face Detection](#)

Zoom

You can shoot zoomed-in images.

This function can be used when the camera's system software (firmware) is Ver. 3.00 or later.

- 1 **MENU** →  **2 (Camera Settings2)** → **[Zoom Setting]** → **desired setting.**
- 2 **MENU** →  **2 (Camera Settings2)** → **[Zoom]**.
 - If you have assigned the [Zoom] function to a key using [Custom Key(Shoot.)], you can display the zooming operation screen by pressing the assigned key.
- 3 **Press the right/left button or the up/down button to select the desired zoom magnification, and then press the  (Enter) button.**
 - The zoom magnification changes smoothly when you press the right/left button, and jumps at a fixed angle of view when you press the up/down button.
 - To cancel the zoom function, press the MENU button.
- 4 **Shoot images.**

Menu item details

Smart zoom only:

The product magnifies the image without causing the original quality to deteriorate by partially cropping the image. You can use the Smart Zoom function if you set [ Image Size] to [M], [S] or [VGA].

On:ClearImage Zoom:

Select this setting to apply the Clear Image Zoom function. Even if the zoom range of the smart zoom is exceeded, the product magnifies images within the range in which image quality does not deteriorate significantly.

On:Digital Zoom:

When the zoom range of the [ Clear Image Zoom] is exceeded, the product magnifies images to the largest scale. However, the image quality will deteriorate.

The zoom features available with this product

The zoom feature of the product provides a higher magnification zoom by combining various zoom features. The icon displayed on the screen changes, according to the selected zoom feature.

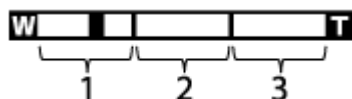

1. Smart Zoom range ()

Zoom images without causing the original quality to deteriorate by partially cropping an image (only when the image size is [M], [S] or [VGA]).

2. Clear Image Zoom range ()

Zoom images using an image process with less deterioration. Set [Zoom Setting] to [On:ClearImage Zoom] or [On:Digital Zoom] first.



3. Digital Zoom range ()

You can magnify images using an image process. When you select [On:Digital Zoom] for [Zoom Setting], you can use this zoom function.

Hint

- You can perform zooming operations by pressing the zoom buttons on the VCT-SGR1 Shooting Grip (sold separately).

Note

- Zoom functions are not available when shooting in the following situations:
 - [ Quality] is set to [RAW] or [RAW & JPEG].
 - [ Record Setting] is set to [120p]/[100p].
- Select [Smart zoom only] if you only want to use the zoom function within the range where image quality does not deteriorate.

Related Topic

- [About zoom scale](#)
- [Custom Key\(Shoot.\)](#)
- [Version](#)

Digital Still Camera
DSC-RX0

About zoom scale

The zoom scale changes according to the selected image size.

When [ Aspect Ratio] is [3:2]

 Image Size	Zoom Setting		
	Smart zoom only	On:ClearImage Zoom	On:Digital Zoom
L: 15M	-	Approx. 2×	Approx. 4×
M: 7.7M	Approx. 1.4×	Approx. 2.8×	Approx. 5.6×
S: 3.8M	Approx. 2×	Approx. 4×	Approx. 8×

Related Topic

- [Zoom](#)
- [Image Size \(still image\)](#)

Digital Still Camera
DSC-RX0

Shutter Speed

Sets the shutter speed in the manual exposure mode.

1 MENU →  1 (Camera Settings1) → [Shutter Speed] → desired setting.

Menu item details

1/4 - 1/32000

- The shutter speed can be set within a range of 1/4 second to 1/12800 second when shooting movies.
-

Related Topic

- [Manual Exposure \(still image/movie\)](#)

Exposure Comp.

Based on the exposure value set by auto exposure, you can make the entire image brighter or darker if you adjust [Exposure Comp.] to the plus side or minus side, respectively (exposure compensation). Normally, exposure is set automatically (auto exposure).

1 MENU →  1 (Camera Settings1) → [Exposure Comp.] → desired setting.

- You can adjust the exposure compensation value within the range of -3.0 EV to +3.0 EV.

Note

- You can adjust the exposure compensation value within the range of -2.0 EV to +2.0 EV for movies.
- If you shoot a subject in extremely bright or dark conditions, you may not be able to get a satisfactory effect.
- When you use [Manual Exposure], you can compensate for the exposure only when [ISO] is set to [ISO AUTO].

Digital Still Camera
DSC-RX0

Metering Mode

Selects the metering mode that sets which part of the screen to measure for determining the exposure.

1 MENU →  1 (Camera Settings1) → [Metering Mode] → desired setting.

Menu item details

Multi:

Measures light on each area after dividing the total area into multiple areas and determines the proper exposure of the entire screen (Multi-pattern metering).

Center:

Measures the average brightness of the entire screen, while emphasizing the central area of the screen (Center-weighted metering).

Spot:



Measures only the central area (Spot metering). This function is useful when the subject is backlit or when there is strong contrast between the subject and the background.

Note



- The setting is fixed to [Multi] in the following shooting modes:
 - [Intelligent Auto]
 - [Superior Auto]

AE lock

When the contrast between the subject and background is high, such as when shooting a backlit subject or a subject near a window, meter the light at a spot where the subject appears to have the appropriate brightness and lock the exposure before shooting. To reduce the brightness of the subject, meter the light at a spot brighter than the subject and lock the exposure of the entire screen. To make the subject brighter, meter the light at a spot darker than the subject and lock the exposure of the entire screen.

- 1 MENU →  (Camera Settings2) → [Custom Key(Shoot.)], then assign the [AEL toggle] to the desired key.**
- 2 Adjust the focus on the spot at which the exposure is adjusted.**
- 3 Press the button to which the [AEL toggle] function is assigned.**
The exposure is locked, and  (AE lock) is displayed.
- 4 Focus on the subject again and shoot an image.**
 - To cancel the exposure lock, press the button to which the [AEL toggle] function is assigned.

Hint

- If you assign [AEL hold] to the  (Enter) button using  (Camera Settings2) → [Custom Key(Shoot.)], you can keep the exposure locked as long as you are holding down the  (Enter) button.



Note

- You cannot assign the [AEL hold] function to [Left Button].

Digital Still Camera
DSC-RX0

AEL w/ shutter (still image)

Sets whether to fix the exposure when you press the SHUTTER/MOVIE button halfway down. This function is useful when you want to adjust focus and exposure separately.

1 MENU →  (Camera Settings1) → [ AEL w/ shutter] → desired setting.

Menu item details

Auto:

Fixes the exposure after adjusting the focus automatically when you press the SHUTTER/MOVIE button halfway down when [Focus Mode] is set to [Single-shot AF].

On:

Fixes the exposure when you press the SHUTTER/MOVIE button halfway down.

Off:

Does not fix the exposure when you press the SHUTTER/MOVIE button halfway down. Use this mode when you want to adjust focus and exposure separately.

The product keeps adjusting the exposure while shooting in [Cont. Shooting] or [Spd Priority Cont.] mode.

Note

- When [AEL toggle] is assigned to any key using [Custom Key(Shoot.)], operation using the key will be given priority over the [ AEL w/ shutter] settings.

Digital Still Camera
DSC-RX0

Zebra

The zebra pattern will appear over part of an image if the brightness level of that part meets the IRE level that you set. Use this zebra pattern as a guide to adjust the brightness.

1 MENU →  2 (Camera Settings2) → [Zebra] → desired setting.

Menu item details

Off:

Does not display the zebra pattern.

70/75/80/85/90/95/100/100+/Custom1/Custom2:

Adjusts the brightness level.

Hint

- You can register values to check the correct exposure or overexposure as well as the brightness level for [Zebra]. The settings for correct exposure confirmation and overexposure confirmation are registered to [Custom1] and [Custom2] respectively in the default settings.
- To check the correct exposure, set a standard value and the range for the brightness level. The zebra pattern will appear on areas that fall within the range you set.
- To check the overexposure, set a minimum value for the brightness level. The zebra pattern will appear over areas with a brightness level equal to or higher than the value you set.

Note

- The zebra pattern is not displayed during HDMI connection.

Digital Still Camera
DSC-RX0

Drive Mode

You can set the drive mode, such as continuous or self-timer shooting.

1 MENU →  1 (Camera Settings1) → [Drive Mode] → desired setting.

Menu item details

Single Shooting:

Shoots one still image. Normal shooting mode.

Cont. Shooting:

Shoots images continuously while you press and hold down the SHUTTER/MOVIE button.

Spd Priority Cont.:

Shoots images continuously at high speed while you press and hold down the SHUTTER/MOVIE button.

Self-timer:

Shoots an image using the self-timer after a designated number of seconds have elapsed since the SHUTTER/MOVIE button was pressed.

Self-timer(Cont):

Shoots a designated number of images using the self-timer after a designated number of seconds have elapsed since the SHUTTER/MOVIE button was pressed.

BRK C Cont. Bracket:

Shoots images while holding the SHUTTER/MOVIE button down, each with different degrees of exposure.

BRK S Single Bracket:

Shoots a specified number of images, one by one, each with a different degree of exposure.

BRK WB WB bracket:

Shoots a total of three images, each with different color tones according to the selected settings for white balance, color temperature and color filter.

BRK DRO DRO Bracket:

Shoots a total of three images, each at a different degree of D-Range Optimizer.

Note

- Continuous shooting and bracket shooting are unavailable in the following situations:
 - [Picture Effect] is set to [Soft Focus], [HDR Painting], [Rich-tone Mono.], [Miniature], [Watercolor], or [Illustration].
 - [DRO/Auto HDR] is set to [Auto HDR].
 - [ISO] is set to [Multi Frame NR].

Related Topic

- [Cont. Shooting](#)
- [Spd Priority Cont.](#)
- [Self-timer](#)
- [Self-timer\(Cont\)](#)
- [Cont. Bracket](#)
- [Single Bracket](#)
- [WB bracket](#)
- [DRO Bracket](#)

Digital Still Camera
DSC-RX0

Cont. Shooting

Shoots images continuously while you press and hold down the SHUTTER/MOVIE button.

1 MENU →  1 (Camera Settings1) → [Drive Mode] → [Cont. Shooting].

Note

- Continuous shooting is unavailable in the following situations:
 - [Picture Effect] is set to [Soft Focus], [HDR Painting], [Rich-tone Mono.], [Miniature], [Watercolor], or [Illustration].
 - [DRO/Auto HDR] is set to [Auto HDR].
 - [ISO] is set to [Multi Frame NR].

Spd Priority Cont.

The product continues to shoot as long as the SHUTTER/MOVIE button is pressed. You can continuously shoot at a rate faster than that of [Cont. Shooting].

1 MENU →  1 (Camera Settings1) → [Drive Mode] → [Spd Priority Cont.].

Note

- Between continuous shooting frames, an image of each frame is immediately displayed.
- Continuous shooting is unavailable in the following situations:
 - [Picture Effect] is set to [Soft Focus], [HDR Painting], [Rich-tone Mono.], [Miniature], [Watercolor], or [Illustration].
 - [DRO/Auto HDR] is set to [Auto HDR].
 - [ISO] is set to [Multi Frame NR].

Hint

- The exposure is fixed for the first shot.

Digital Still Camera
DSC-RX0

Self-timer

Shoots an image using the self-timer after a designated number of seconds have elapsed since the SHUTTER/MOVIE button was pressed.

- 1 MENU →  1 (Camera Settings1) → [Drive Mode] → [Self-timer].
- 2 Select the desired mode using the right/left button.

Menu item details

10 Self-timer: 10 Sec:

Sets the 10-second delay self-timer.

When you press the SHUTTER/MOVIE button, a beep sounds and the shutter operates after 10 seconds. To cancel the self-timer, press the SHUTTER/MOVIE button again.

5 Self-timer: 5 Sec:



Sets the 5-second delay self-timer.

When you press the SHUTTER/MOVIE button, a beep sounds and the shutter operates after 5 seconds. To cancel the self-timer, press the SHUTTER/MOVIE button again.

2 Self-timer: 2 Sec:

Sets the 2-second delay self-timer. This reduces the camera-shake caused by pressing the SHUTTER/MOVIE button.

Hint

- To exit the self-timer mode, select MENU →  1 (Camera Settings1) → [Drive Mode] → [Single Shooting].
- To use the self-timer in bracket mode, select bracket mode under drive mode, then select MENU →  1 (Camera Settings1) → [Bracket Settings] → [Selftimer during Brkt].

Digital Still Camera
DSC-RX0

Self-timer(Cont)

Shoots a designated number of images using the self-timer after a designated number of seconds have elapsed since the SHUTTER/MOVIE button was pressed. You can choose the best from multiple shots.

- 1 MENU →  1 (Camera Settings1) → [Drive Mode] → [Self-timer(Cont)].
- 2 Select the desired mode using the right/left button.

Menu item details

Self-timer(Cont.): 10 Sec. 3 Img.:

Shoots three frames in succession 10 seconds after you press the SHUTTER/MOVIE button.
When you press the SHUTTER/MOVIE button, a beep sounds and the shutter operates after 10 seconds.

Self-timer(Cont.): 10 Sec. 5 Img.:

Shoots five frames in succession 10 seconds after you press the SHUTTER/MOVIE button.
When you press the SHUTTER/MOVIE button, a beep sounds and the shutter operates after 10 seconds.

Self-timer(Cont.): 5 Sec. 3 Img.:

Shoots three frames in succession 5 seconds after you press the SHUTTER/MOVIE button.
When you press the SHUTTER/MOVIE button, a beep sounds and the shutter operates after 5 seconds.

Self-timer(Cont.): 5 Sec. 5 Img.:

Shoots five frames in succession 5 seconds after you press the SHUTTER/MOVIE button.
When you press the SHUTTER/MOVIE button, a beep sounds and the shutter operates after 5 seconds.

Self-timer(Cont.): 2 Sec. 3 Img.:

Shoots three frames in succession 2 seconds after you press the SHUTTER/MOVIE button.
When you press the SHUTTER/MOVIE button, a beep sounds and the shutter operates after 2 seconds.

Self-timer(Cont.): 2 Sec. 5 Img.:

Shoots five frames in succession 2 seconds after you press the SHUTTER/MOVIE button.
When you press the SHUTTER/MOVIE button, a beep sounds and the shutter operates after 2 seconds.

Hint

- To exit the self-timer mode, select MENU →  1 (Camera Settings1) → [Drive Mode] → [Single Shooting].

Digital Still Camera
DSC-RX0

Cont. Bracket

Shoots multiple images while automatically shifting the exposure from base to darker and then to lighter. Press and hold down the SHUTTER/MOVIE button until the bracket recording is completed.
You can select an image that suits your intention, after recording.

1 MENU →  1 (Camera Settings1) → [Drive Mode] → [Cont. Bracket].

2 Select the desired mode using the right/left button.

Menu item details

 **Cont. Bracket: 0.3EV 3 Image:**

This setting shoots three images continuously with an exposure value shifted by plus or minus 0.3 EV.

 **Cont. Bracket: 0.3EV 5 Image:**

This setting shoots five images continuously with an exposure value shifted by plus or minus 0.3 EV.

 **Cont. Bracket: 0.3EV 9 Image:**

This setting shoots nine images continuously with an exposure value shifted by plus or minus 0.3 EV.

 **Cont. Bracket: 0.7EV 3 Image:**

This setting shoots three images continuously with an exposure value shifted by plus or minus 0.7 EV.

 **Cont. Bracket: 0.7EV 5 Image:**

This setting shoots five images continuously with an exposure value shifted by plus or minus 0.7 EV.

 **Cont. Bracket: 0.7EV 9 Image:**

This setting shoots nine images continuously with an exposure value shifted by plus or minus 0.7 EV.

 **Cont. Bracket: 1.0EV 3 Image:**

This setting shoots three images continuously with an exposure value shifted by plus or minus 1.0 EV.

 **Cont. Bracket: 1.0EV 5 Image:**

This setting shoots five images continuously with an exposure value shifted by plus or minus 1.0 EV.

 **Cont. Bracket: 1.0EV 9 Image:**

This setting shoots nine images continuously with an exposure value shifted by plus or minus 1.0 EV.

 **Cont. Bracket: 2.0EV 3 Image:**

This setting shoots three images continuously with an exposure value shifted by plus or minus 2.0 EV.

 **Cont. Bracket: 2.0EV 5 Image:**

This setting shoots five images continuously with an exposure value shifted by plus or minus 2.0 EV.

 **Cont. Bracket: 3.0EV 3 Image:**

This setting shoots three images continuously with an exposure value shifted by plus or minus 3.0 EV.

 **Cont. Bracket: 3.0EV 5 Image:**

This setting shoots five images continuously with an exposure value shifted by plus or minus 3.0 EV.

Note

- The last shot is shown on the Auto Review.
- When [ISO AUTO] is selected in [Manual Exposure] mode, the exposure is changed by adjusting the ISO value. If a setting other than [ISO AUTO] is selected, the exposure is changed by adjusting the shutter speed.
- When the exposure is compensated, the exposure is shifted based on the compensated value.
- Bracket shooting is unavailable in the following situations:
 - The shooting mode is set to [Intelligent Auto] or [Superior Auto].

Related Topic

- [Settings for bracket shooting](#)
- [Indicator during bracket shooting](#)

4-698-613-13(1) Copyright 2017 Sony Corporation

Digital Still Camera
DSC-RX0

Single Bracket

Shoots multiple images while automatically shifting the exposure from base to darker and then to lighter. Press the SHUTTER/MOVIE button for each image. You can select an image that suits your purpose after recording.

- 1 MENU →  1 (Camera Settings1) → [Drive Mode] → [Single Bracket].
- 2 Select the desired mode using the right/left button.

Menu item details

Single Bracket: 0.3EV 3 Image:

This setting shoots a total of three images in a row with an exposure value shifted by plus or minus 0.3 EV.

Single Bracket: 0.3EV 5 Image:

This setting shoots a total of five images in a row with an exposure value shifted by plus or minus 0.3 EV.

Single Bracket: 0.3EV 9 Image:

This setting shoots a total of nine images in a row with an exposure value shifted by plus or minus 0.3 EV.

Single Bracket: 0.7EV 3 Image:

This setting shoots a total of three images in a row with an exposure value shifted by plus or minus 0.7 EV.

Single Bracket: 0.7EV 5 Image:

This setting shoots a total of five images in a row with an exposure value shifted by plus or minus 0.7 EV.

Single Bracket: 0.7EV 9 Image:

This setting shoots a total of nine images in a row with an exposure value shifted by plus or minus 0.7 EV.

Single Bracket: 1.0EV 3 Image:

This setting shoots a total of three images in a row with an exposure value shifted by plus or minus 1.0 EV.

Single Bracket: 1.0EV 5 Image:

This setting shoots a total of five images in a row with an exposure value shifted by plus or minus 1.0 EV.

Single Bracket: 1.0EV 9 Image:

This setting shoots a total of nine images in a row with an exposure value shifted by plus or minus 1.0 EV.

Single Bracket: 2.0EV 3 Image:

This setting shoots a total of three images in a row with an exposure value shifted by plus or minus 2.0 EV.

Single Bracket: 2.0EV 5 Image:

This setting shoots a total of five images in a row with an exposure value shifted by plus or minus 2.0 EV.

Single Bracket: 3.0EV 3 Image:

This setting shoots a total of three images in a row with an exposure value shifted by plus or minus 3.0 EV.

Single Bracket: 3.0EV 5 Image:

This setting shoots a total of five images in a row with an exposure value shifted by plus or minus 3.0 EV.

Note

- When [ISO AUTO] is selected in [Manual Exposure] mode, the exposure is changed by adjusting the ISO value. If a setting other than [ISO AUTO] is selected, the exposure is changed by adjusting the shutter speed.
- When the exposure is compensated, the exposure is shifted based on the compensated value.
- Bracket shooting is unavailable in the following situations:
 - The shooting mode is set to [Intelligent Auto] or [Superior Auto].

Related Topic

- [Settings for bracket shooting](#)
- [Indicator during bracket shooting](#)

4-698-613-13(1) Copyright 2017 Sony Corporation

Digital Still Camera
DSC-RX0

WB bracket

Shoots three images, each with different color tones according to the selected settings of white balance, color temperature and color filter.

- 1 MENU →  1 (Camera Settings1) → [Drive Mode] → [WB bracket].
- 2 Select the desired mode using the right/left button.

Menu item details

White Balance Bracket: Lo:

Records a series of three images with small changes in the white balance.

White Balance Bracket: Hi:

Records a series of three images with large changes in the white balance.

Note

- The last shot is shown on the Auto Review.

Related Topic

- [Settings for bracket shooting](#)

DRO Bracket

You can record a total of three images, each at a different degree of D-Range Optimizer value.

1 MENU →  1 (Camera Settings1) → [Drive Mode] → [DRO Bracket].

2 Select the desired mode using the right/left button.

Menu item details

 **DRO Bracket: Lo:**

Records a series of three images with small changes in the D-Range Optimizer value.

 **DRO Bracket: Hi:**

Records a series of three images with large changes in the D-Range Optimizer value.

Note

- The last shot is shown on the Auto Review.

Related Topic

- [Settings for bracket shooting](#)

Digital Still Camera
DSC-RX0

Settings for bracket shooting

You can set the self-timer in bracket shooting mode, and the shooting order for exposure bracketing and white balance bracketing.

1 MENU →  1 (Camera Settings1) → [Drive Mode] → select bracket shooting mode.

2 MENU →  1 (Camera Settings1) → [Bracket Settings] → desired setting.

Menu item details

Selftimer during Brkt:

Sets whether to use the self-timer during bracket shooting. Also sets the number of seconds until the shutter is released if using the self-timer.

(OFF/2 Sec/5 Sec/10 Sec)

Bracket order:

Sets the order of exposure bracketing and white balance bracketing.

(0→→+/-→0→+)

Related Topic

- [Cont. Bracket](#)
- [Single Bracket](#)
- [WB bracket](#)
- [DRO Bracket](#)

Digital Still Camera
DSC-RX0

Indicator during bracket shooting

A bracket indicator is displayed on the monitor during bracket shooting.

Examples of the bracket indicator

The bracket indicator is displayed as follows in ambient light* bracketing with the bracket range set to 0.3 EV and the number of shots set to 3.

* Ambient light: A generic term for non-flash light including natural light, electric bulb and fluorescent lighting. Whereas the flash light blinks for a moment, ambient light is constant, so this kind of light is called "ambient light."

When the exposure compensation value is set to ± 0.0 EV



When MM (Metered Manual) indicates -1.0 EV



- During bracket shooting, guides for each shot are displayed on the bracket indicator.
- When you start bracket shooting, the guides will disappear one by one as the camera shoots images.

Note

- MM (Metered Manual) is displayed only when the shooting mode is set to M (Manual Exposure) mode and [ISO] is not set to [ISO AUTO].

Digital Still Camera
DSC-RX0

ISO

Sensitivity to light is expressed by the ISO number (recommended exposure index). The larger the number, the higher the sensitivity.

1 MENU →  (Camera Settings1) → [ISO] → desired setting.

Menu item details

Multi Frame NR:

Combines continuous shots to create an image with less noise. Select the desired ISO number from [ISO AUTO] or ISO 200 – 25600.

ISO AUTO:

Sets the ISO sensitivity automatically.

ISO 80 – ISO 12800:

Sets the ISO sensitivity manually. Selecting a larger number increases the ISO sensitivity.

Note

- [ISO AUTO] is selected when using the following functions:
 - [Intelligent Auto]
 - [Superior Auto]
- When [ISO] is set to a value lower than ISO 125, the range for recordable subject brightness (dynamic range) may decrease.
- The higher the ISO value, the more noise will appear on the images.
- The available ISO settings will differ depending on whether you are shooting still images, shooting movies, or using HFR.
- When shooting movies, ISO values between ISO 125 and ISO 12800 are available. If the ISO value is set to a value smaller than ISO 125, the setting is automatically switched to ISO 125. When you finish recording the movie, the ISO value returns to the original setting.
- When you use [Multi Frame NR], it takes some time for the product to perform the overlay processing of images.

Hint

- You can change the automatically set ISO sensitivity range for the [ISO AUTO] mode. Select [ISO AUTO] and press the right button, and set the desired values for [ISO AUTO Maximum] and [ISO AUTO Minimum]. The values for [ISO AUTO Maximum] and [ISO AUTO Minimum] are also applied when shooting in [ISO AUTO] mode under [Multi Frame NR].

Related Topic

- [Multi Frame NR](#)
- [ISO AUTO Min. SS](#)

Digital Still Camera
DSC-RX0

ISO AUTO Min. SS

If you select [ISO AUTO] or [ISO AUTO] under [Multi Frame NR] when the shooting mode is P (Program Auto), you can set the shutter speed at which the ISO sensitivity starts changing.

This function is effective for shooting moving subjects. You can minimize subject blurring while also preventing camera shake.

1 MENU →  1 (Camera Settings1) → [ISO AUTO Min. SS] → desired setting.

Menu item details

FASTER (Faster)/FAST (Fast):

The ISO sensitivity will start to change at shutter speeds faster than [Standard], so you can prevent camera shake and subject blurring.

STD (Standard):

The camera automatically sets the shutter speed.

SLOW (Slow)/SLOWER (Slower):

The ISO sensitivity will start to change at shutter speeds slower than [Standard], so you can shoot images with less noise.

1/32000—1/4:

The ISO sensitivity starts to change at the shutter speed you have set.

Hint

- The difference in shutter speed at which ISO sensitivity starts to change between [Faster], [Fast], [Standard], [Slow], and [Slower] is 1 EV.

Note

- If the exposure is insufficient even when the ISO sensitivity is set to [ISO AUTO Maximum] in [ISO AUTO], in order to shoot with an appropriate exposure, the shutter speed will be slower than the speed set in [ISO AUTO Min. SS].

Related Topic

- [Program Auto \(still image/movie\)](#)
- [ISO](#)
- [Multi Frame NR](#)

Multi Frame NR

The product automatically shoots multiple images continuously, combines them, reduces the noise, and records them as one image. The image recorded is one combined image.

- 1 MENU →  1 (Camera Settings1) → [ISO] → [Multi Frame NR].
- 2 Press the right button to display the setting screen, then select a desired value using the up/down button.

Note

- When [ Quality] is set to [RAW] or [RAW & JPEG], this function cannot be used.
- [D-Range Opt.], and [Auto HDR] cannot be used.
- When [Picture Profile] is set to something other than [Off], you cannot set [Multi Frame NR].
- When [Picture Effect] is set to something other than [Off], you cannot set [Multi Frame NR].

Hint

- You can change the automatically set range of ISO sensitivity in the [ISO AUTO] mode under [Multi Frame NR]. Select [ISO AUTO] under [ISO] and press the right button, and set the desired values for [ISO AUTO Maximum] and [ISO AUTO Minimum]. The values for [ISO AUTO Maximum] and [ISO AUTO Minimum] are also applied when shooting in [ISO AUTO] mode under [Multi Frame NR].

Digital Still Camera
DSC-RX0

D-Range Opt. (DRO)

By dividing the image into small areas, the product analyzes the contrast of light and shadow between the subject and the background, and creates an image with the optimal brightness and gradation.

1 MENU →  1 (Camera Settings1) → [DRO/Auto HDR] → [D-Range Opt.].

2 Select the desired setting using the left/right button.

Menu item details

D-Range Optimizer: Auto:

Corrects the brightness automatically.

D-Range Optimizer: Lv1 — D-Range Optimizer: Lv5:

Optimizes the gradation of a recorded image for each divided area. Select the optimization level from Lv1 (weak) to Lv5 (strong).

Note

- [DRO/Auto HDR] is locked to [Off] when [Multi Frame NR] is used, or [Picture Effect] is not set to [Off].
- [DRO/Auto HDR] is fixed to [Off] when [Picture Profile] is set to something other than [Off].
- When shooting with [D-Range Opt.], the image may be noisy. Select the proper level by checking the recorded image, especially when you enhance the effect.

Digital Still Camera
DSC-RX0

Auto HDR

Widens the range (gradation) so that you can record from bright parts to dark parts with correct brightness (HDR: High Dynamic Range). One image with proper exposure and one overlaid image are recorded.

1 MENU →  1 (Camera Settings1) → [DRO/Auto HDR] → [Auto HDR].

2 Select the desired setting using the left/right button.

Menu item details

 **Auto HDR: Exposure Diff. Auto:**



Sets the exposure difference automatically.

 **Auto HDR: Exposure Diff. 1.0EV — Auto HDR: Exposure Diff. 6.0EV:**

Sets the exposure difference, based on the contrast of the subject. Select the optimal level between 1.0 EV (weak) and 6.0 EV (strong).

For example, if you set the exposure value to 2.0 EV, three images will be composed with the following exposure levels: -1.0 EV, correct exposure and +1.0 EV.

Note

- [Auto HDR] is not available when the [ Quality] is [RAW] or [RAW & JPEG].
- [Auto HDR] is not available in the following shooting modes.
 - [Intelligent Auto]
 - [Superior Auto]
- When [Multi Frame NR] is selected, you cannot select [Auto HDR].
- When [Picture Effect] is set to something other than [Off], you cannot select [Auto HDR].
- When [Picture Profile] is set to something other than [Off], you cannot set [Auto HDR].
- You cannot start the next shot until the image processing is completed after you shoot.
- You may not obtain the desired effect depending on the luminance difference of a subject and the shooting conditions.
- When the contrast of the scene is low or when product shake or subject blur occurs, you may not obtain good HDR images.  will be displayed over the recorded image to inform you when the camera detects image blurring. Change the composition or re-shoot the image carefully to avoid image blur, as needed.

Digital Still Camera
DSC-RX0

White Balance

Adjusts the color tones according to the ambient light conditions. Use this feature when the color tones of the image did not come out as you expected, or when you want to change the color tones on purpose for photographic expression.

1 MENU →  1 (Camera Settings1) → [White Balance] → desired setting.

Menu item details

AWB Auto:

The product automatically detects the light source and adjusts the color tones.

Daylight:

The color tones are adjusted for the daylight.

Shade:

The color tones are adjusted for shadiness.

Cloudy:

The color temperature is adjusted for a cloudy sky.

Incandescent:

The color temperature is adjusted for places under an incandescent lamp, or under bright lighting, such as in a photo studio.

-1 **Fluor.: Warm White:**

The color temperature is adjusted for warm white fluorescent lighting.

0 **Fluor.: Cool White:**

The color temperature is adjusted for white fluorescent lighting.

+1 **Fluor.: Day White:**

The color temperature is adjusted for neutral white fluorescent lighting.

+2 **Fluor.: Daylight:**

The color temperature is adjusted for daylight fluorescent lighting.

Underwater Auto:

The color temperature is adjusted for underwater shooting.

C.Temp./Filter:

Adjusts the color tones depending on the light source. Achieves the effect of CC (Color Compensation) filters for photography.

Custom 1/Custom 2/Custom 3:

Uses the white balance setting saved in [Custom Setup].

SET Custom Setup:

Memorizes the basic white color under the light conditions for the shooting environment.
Select a memorized custom white balance number.

Hint

- You can use the right button to display the fine adjustment screen and perform fine adjustments of the color tones as required.
- In [C.Temp./Filter], you can use the right button to display the color temperature setting screen and perform a setting. When you press the right button again, the fine adjustment screen appears to allow you perform fine adjustments as required.

Note

- [White Balance] is fixed to [Auto] in the following situations:
 - [Intelligent Auto]
 - [Superior Auto]



Related Topic

- [Capturing a basic white color in \[Custom Setup\] mode](#)

4-698-613-13(1) Copyright 2017 Sony Corporation

Capturing a basic white color in [Custom Setup] mode

In a scene where the ambient light consists of multiple types of light sources, it is recommended to use the custom white balance in order to accurately reproduce the whiteness.

- 1 MENU** →  **1** (Camera Settings1) → **[White Balance]** → **[Custom Setup]**.
- 2 Hold the product so that the white area fully covers the circle located in the center of the screen, and then press the  (Enter) button.**
The calibrated values (Color Temperature and Color Filter) are displayed.
- 3 Select a registration number using the right/left button, and then press the  (Enter) button.**
The monitor returns to the recording information display while retaining the memorized custom white balance setting.

Note

- The message [Custom WB Error] indicates that the value is in the unexpected range, for example when the subject is too vivid. If you register this value, the  indicator turns orange on the recording information display. You can shoot at this point, but it is recommended that you set the white balance again to get a more accurate white balance value.

Digital Still Camera
DSC-RX0

Picture Effect

Select the desired effect filter to achieve more impressive and artistic images.

1 MENU →  (Camera Settings1) → [Picture Effect] → desired setting.

Menu item details

 **Off:**

Disables the [Picture Effect] function.

 **Pop Color:**

Creates a vivid look by emphasizing color tones.

 **Posterization:**

Creates a high contrast, abstract look by heavily emphasizing primary colors, or in black and white.

 **Retro Photo:**

Creates the look of an aged photo with sepia color tones and faded contrast.

 **Soft High-key:**

Creates an image with the indicated atmosphere: bright, transparent, ethereal, tender, soft.

 **Partial Color:**

Creates an image which retains a specific color, but converts others to black and white.

 **High Contrast Mono.:**

Creates a high-contrast image in black and white.

 **Soft Focus:**

Creates an image filled with a soft lighting effect.

 **HDR Painting:**

Creates the look of a painting, enhancing the colors and details.

 **Rich-tone Mono.:**

Creates an image in black and white with rich gradation and reproduction of details.

 **Miniature:**

Creates an image which enhances the subject vividly, with the background defocused considerably. This effect may often be found in pictures of miniature models.

 **Watercolor:**

Creates an image with ink bleed and blurring effects as if painted using watercolors.

 **Illustration:**

Creates an illustration-like image by emphasizing the outlines.

Hint



- You can perform detailed settings for the following [Picture Effect] modes using the left/right button.
 - [Posterization]
 - [Partial Color]
 - [Soft Focus]
 - [HDR Painting]
 - [Miniature]
 - [Illustration]

Note

- When [Partial Color] is selected, images may not retain the selected color, depending on the subject or shooting conditions.
- You cannot check the following effects on the shooting screen, because the product processes the image after the shot. Also, you cannot shoot another image until image processing is finished. You cannot use these effects with movies.

- [Soft Focus]
- [HDR Painting]
- [Rich-tone Mono.]
- [Miniature]
- [Watercolor]
- [Illustration]

- In the case of [HDR Painting] and [Rich-tone Mono.], the shutter is released three times for one shot. Be careful about the following:
 - Use this function when the subject is motionless or does not flash light.
 - Do not change the composition during shooting.

When the contrast of the scene is low or when significant camera-shake or subject blur has occurred, you may not be able to obtain good HDR images. If the product detects such a situation,  /  appear on the recorded image to inform you of this situation. If necessary, change the composition or otherwise adjust the settings, be careful of blurring, and shoot again.

- [Picture Effect] cannot be set when the shooting mode is set to [Intelligent Auto] or [Superior Auto].
- [Picture Effect] cannot be set when  Quality is set to [RAW] or [RAW & JPEG].

Digital Still Camera
DSC-RX0

Creative Style

Allows you to select the desired image processing. You can adjust the exposure (shutter speed) as desired with [Creative Style].

1 MENU → 1 (Camera Settings1) → [Creative Style] → desired setting.

Menu item details

Standard:

For shooting various scenes with rich gradation and beautiful colors.

Vivid:

The saturation and contrast are heightened for shooting striking images of colorful scenes and subjects such as flowers, spring greenery, blue sky, or ocean views.

Neutral:

The saturation and sharpness are lowered for shooting images in subdued tones. This is also suitable for capturing image material to be modified with a computer.

Clear:

For shooting images in clear tones with limpid colors in highlight, suitable for capturing radiant light.

Deep:

For shooting images with deep and dense colors, suitable for capturing the solid presence of the subject.

Light:

For shooting images with bright and simple colors, suitable for capturing a refreshingly light ambience.

Portrait:

For capturing skin in a soft tone, ideally suited for shooting portraits.

Landscape:

The saturation, contrast, and sharpness are heightened for shooting vivid and crisp scenery. Distant landscapes also stand out more.

Sunset:

For shooting the beautiful red of the setting sun.

Night Scene:

The contrast is lowered for reproducing night scenes.

Autumn leaves:

For shooting autumn scenes, vividly highlighting the reds and yellows of changing leaves.

Black & White:

For shooting images in black and white monotone.

Sepia:

For shooting images in sepia monotone.

Registering preferred settings (Style Box):

Select the six style box (the boxes with numbers on the left side ()) to register preferred settings. Then select the desired settings using the right button.

You can call up the same style with slightly different settings.

To set [Contrast], [Saturation] and [Sharpness]

[Contrast], [Saturation], and [Sharpness] can be adjusted for each image style preset such as [Standard] and [Landscape], and for each [Style Box] to which you can register preferred settings.

Select an item to be set by pressing the right/left button, then set the value using the up/down button.

Contrast:

The higher the value selected, the more the difference of light and shadow is accentuated, and the bigger the effect on the image.

 **Saturation:**

The higher the value selected, the more vivid the color. When a lower value is selected, the color of the image is restrained and subdued.

 **Sharpness:**

Adjusts the sharpness. The higher the value selected, the more the contours are accentuated, and the lower the value selected, the more the contours are softened.

Note

- [Standard] is selected when using the following functions:
 - [Intelligent Auto]
 - [Superior Auto]
 - [Picture Effect] is set to other than [Off].
 - [Picture Profile] is set to other than [Off].
- When [Creative Style] is set to [Black & White] or [Sepia], [Saturation] cannot be adjusted.

Digital Still Camera
DSC-RX0

Movie recording formats

The following movie recording formats are available with this camera.

What is XAVC S?

Records high-definition movies by converting them to MP4 movies using the MPEG-4 AVC/H.264 codec. MPEG-4 AVC/H.264 is capable of compressing images at higher efficiency. You can record high-quality images while reducing the amount of data.

XAVC S/AVCHD recording format

XAVC S HD:

Bit-rate: Approx. 50 Mbps

Records a more vivid movie compared to AVCHD with increased amounts of information.

AVCHD:

Bit-rate: Approx. 28 Mbps (Maximum), Approx. 24 Mbps (Maximum) or Approx. 17 Mbps (Average)

The AVCHD format has a high degree of compatibility with storage devices other than computers.

- Bit rate is the amount of the data processed within a given length of time.



Related Topic

- [File Format \(movie\)](#)
- [Record Setting \(movie\)](#)
- [AVCHD format](#)

Digital Still Camera
DSC-RX0

File Format (movie)

Selects the movie file format.

1 MENU →  2 (Camera Settings2) →  File Format] → desired setting.

Menu item details

XAVC S HD:

Records high-definition movies in XAVC S HD. This format supports a higher bit rate.

Audio: LPCM

- In order to record movies with [ File Format] set to [XAVC S HD], the following kind of memory card is needed:
 - microSDHC memory card (SD Speed Class10, or UHS Speed Class U1 or faster)
 - microSDXC memory card (SD Speed Class10, or UHS Speed Class U1 or faster)

AVCHD:

Records HD movies in AVCHD format. This file format is suitable for high-definition TV.

Audio: Dolby Digital

MP4:

Records mp4 (AVC) movies. This format is suitable for playback on smartphones or tablets, web uploads, email attachments, etc.

Audio: AAC



Hint

- You can save images to a computer or copy them to a disc compatible with your playback device using the software PlayMemories Home.

Digital Still Camera
DSC-RX0

Record Setting (movie)

Selects the image size, frame rate, and image quality for movie recording. The higher the bit-rate, the higher the image quality.

1 MENU →  2 (Camera Settings2) → [ Record Setting] → desired setting.

Menu item details

When [File Format] is set to [XAVC S HD]

Records high-definition movies by converting them into the MP4 file format using the MPEG-4 AVC/H.264 codec.

60p 50M/50p 50M:

Records the movies in 1920 × 1080 (60p/50p).

Bit-rate: Approx. 50 Mbps

30p 50M/25p 50M:

Records the movies in 1920 × 1080 (30p/25p).

Bit-rate: Approx. 50 Mbps

24p 50M*:

Records the movies in 1920 × 1080 (24p). This produces a cinema-like atmosphere.

Bit-rate: Approx. 50 Mbps

120p 50M/100p 50M:

Records 1280 × 720 (120p/100p) size movies at a high speed. Movies can be recorded at 120 fps/100 fps.

You can create smoother slow-motion images using compatible editing equipment.

Bit-rate: Approx. 50 Mbps

* Only when [NTSC/PAL Selector] is set to NTSC

When [File Format] is set to [AVCHD]

60i/50i: Movies are recorded at approximately 60 fields/sec (for 1080 60i-compatible devices) or 50 fields/sec (for 1080 50i-compatible devices), in interlaced mode with Dolby Digital audio and in the AVCHD format.

24p/25p: Movies are recorded at approximately 24 frames/sec (for 1080 60i-compatible devices) or 25 frames/sec (for 1080 50i-compatible devices), in progressive mode with Dolby Digital audio and in the AVCHD format.

60p/50p: Movies are recorded at approximately 60 frames/sec (for 1080 60i-compatible devices) or 50 frames/sec (for 1080 50i-compatible devices), in progressive mode with Dolby Digital audio and in the AVCHD format.

60i 24M(FX):

50i 24M(FX):

Records the movies in 1920 × 1080 (60i/50i).

Bit-rate: 24 Mbps (Max.)

60i 17M(FH):

50i 17M(FH):

Records the movies in 1920 × 1080 (60i/50i).

Bit-rate: Approx. 17 Mbps (Avg.)

60p 28M(PS):

50p 28M(PS):

Records the movies in 1920 × 1080 (60p/50p).

Bit-rate: 28 Mbps (Max.)

24p 24M(FX):

25p 24M(FX):

Records the movies in 1920 × 1080 (24p/25p). This produces a cinema-like atmosphere.
Bit-rate: 24 Mbps (Max.)

24p 17M(FH):

25p 17M(FH)

Records the movies in 1920 × 1080 (24p/25p). This produces a cinema-like atmosphere.
Bit-rate: Approx. 17 Mbps (Avg.)

When [ File Format] is set to [MP4]

Movies are recorded in the MPEG-4 format, at approximately 60 frames/sec (for 1080 60i-compatible devices), approximately 50 frames/sec (for 1080 50i-compatible devices), approximately 30 frames/sec (for 1080 60i-compatible devices), or approximately 25 frames/sec (for 1080 50i-compatible devices), in progressive mode with AAC audio and in the MP4 format.

1920x1080 60p 28M/1920x1080 50p 28M:

Records the movies in 1920×1080 (60p/50p).
Bit-rate: Approx. 28 Mbps (Avg.)

1920x1080 30p 16M/1920x1080 25p 16M:

Records the movies in 1920×1080 (30p/25p).
Bit-rate: Approx. 16 Mbps (Avg.)

1280x720 30p 6M/1280x720 25p 6M:

Records small file size movies in 1280×720 (30p/25p).
Bit-rate: Approx. 6 Mbps (Avg.)

Note

- 60p/50p movies can be played back only on compatible devices.
- Movies recorded with the [60p 28M(PS)]/[50p 28M(PS)]/[60i 24M(FX)]/[50i 24M(FX)]/[24p 24M(FX)]/[25p 24M(FX)] setting in [ Record Setting] are converted by PlayMemories Home in order to create an AVCHD recording disc. This conversion can take a long time. Also, you cannot create a disc in the original image quality. If you want to keep the original image quality, store your movies on a Blu-ray Disc.
- To play back 60p/50p/24p/25p movies on a TV, the TV must be compatible with the 60p/50p/24p/25p formats. If the TV is not compatible with the 60p/50p/24p/25p format, 60p/50p/24p/25p movies will be output as 60i/50i movies.
- [120p]/[100p] cannot be selected for the following settings.
 - [Intelligent Auto]
 - [Superior Auto]

Related Topic

- [Adjusting the settings for super-slow-motion shooting \(HFR Settings\)](#)

Dual Video REC

Allows you to simultaneously record an XAVC S movie and an MP4 movie, or an AVCHD movie and an MP4 movie.

1 MENU →  2 (Camera Settings2) → [Dual Video REC] → desired setting.

Menu item details



On:

An XAVC S movie and an MP4 movie, or an AVCHD movie and an MP4 movie, are recorded simultaneously.

Off:

The [Dual Video REC] function is not used.

Note

- When [ Record Setting] for an XAVC S movie is set to [60p]/[50p] or [120p]/[100p], [ Record Setting] for an AVCHD movie is set to [60p]/[50p], or [ File Format] is set to [MP4], the [Dual Video REC] function is set to [Off].
- If you select [Date View] in [View Mode] when playing back movies, XAVC S movies and MP4 movies, or AVCHD movies and MP4 movies are displayed side-by-side.



Related Topic

- [Record Setting \(movie\)](#)
- [View Mode](#)

Digital Still Camera
DSC-RX0

Marker Display (movie)

Sets whether or not to display markers set using [ Marker Settings] on the monitor while shooting movies.

1 MENU →  2 (Camera Settings2) → [ Marker Display] → desired setting.

Menu item details

On:

Markers are displayed. The markers are not recorded.

Off:

No marker is displayed.

Note

- The markers are displayed when in movie mode or when shooting movies.
- The markers are displayed on the monitor. (You cannot output the markers.)



Related Topic

- [Marker Settings \(movie\)](#)

Digital Still Camera
DSC-RX0

Marker Settings (movie)

Sets the markers to be displayed while shooting movies.

1 MENU →  2 (Camera Settings2) → [ Marker Settings] → desired setting.

Menu item details

Center:

Sets whether or not to display the center marker in the center of the shooting screen.

Off / On

Aspect:

Sets the aspect marker display.

Off / 4:3 / 13:9 / 14:9 / 15:9 / 1.66:1 / 1.85:1 / 2.35:1

Safety Zone:

Sets the safety zone display. This becomes the standard range that can be received by a general household TV.

Off / 80% / 90%

Guideframe:

Sets whether or not to display the guide frame. You can verify whether the subject is level or perpendicular to the ground.

Off / On

Hint

- You can display several markers at the same time.
- Place the subject on the cross point of the [Guideframe] to make a balanced composition.



Related Topic

- [Marker Display \(movie\)](#)

Digital Still Camera
DSC-RX0

Mon. Off dur REC (movie)

Sets whether to turn off the monitor automatically after approximately one minute without any operations by the user when recording movies.

1 MENU →  2 (Camera Settings2) → [ Mon. Off dur REC] → desired setting.

Menu item details

On:

The monitor turns off automatically.

Off:

The monitor does not turn off automatically. To keep the monitor turned on, select [Off].

Hint

- To turn on the monitor again, press either the MENU button, any of the up/down/left/right buttons, or the  (Enter) button.

Digital Still Camera
DSC-RX0

REC Lamp

You can turn off the recording lamp when recording movies so that light from the lamp will not be reflected on the subject.

1 MENU →  2 (Camera Settings2) → [REC Lamp] → desired setting.

Menu item details

All On:

Both of the recording lamps on the front side and the rear side turn on.

Only Rear Lamp On:

Only the recording lamp on the rear side turns on.

All Off:

Neither of the recording lamps turn on.

Hint

- Change the recording lamp settings when there is an object that reflects light, such as glass, in the direction of shooting.

Digital Still Camera
DSC-RX0

Audio Recording

Sets whether to record sounds when shooting movies.

1 MENU →  2 (Camera Settings2) → [Audio Recording] → desired setting.

Menu item details

On:

Records sound (stereo).

Off:

Does not record sound.

Note

- Sounds from camera operations during shooting will also be recorded when [On] is selected.

Digital Still Camera
DSC-RX0

Audio Rec Level

You can adjust the audio recording level while checking the level meter.

1 MENU →  2 (Camera Settings2) → [Audio Rec Level] → desired setting.

Menu item details

+:

Turns up the audio recording level.

-:

Turns down the audio recording level.

Reset:

Resets the audio recording level to the default setting.

Hint

- When you record audio movies with loud volumes, set [Audio Rec Level] to a lower sound level. Doing so enables you to record more realistic audio. When you record audio movies with lower volumes, set [Audio Rec Level] to a greater sound level to make the sound easier to hear.

Note

- Regardless of the [Audio Rec Level] settings, the limiter always operates.
- [Audio Rec Level] is available only when the shooting mode is set to Movie.
- The [Audio Rec Level] settings are applied for both the internal microphone and the  (Microphone) terminal input.

Digital Still Camera
DSC-RX0

Audio Level Display

Sets whether to display the audio level on the screen.

1 MENU →  **2** (Camera Settings2) → [Audio Level Display] → desired setting.

Menu item details

On:

Displays the audio level.

Off:

Does not display the audio level.

Note

- The audio level is not displayed in the following situations:
 - When [Audio Recording] is set to [Off].
 - When DISP (Display Setting) is set to [No Disp. Info].
- You can also see the audio level before recording, but only in movie recording mode.

Digital Still Camera
DSC-RX0

Wind Noise Reduct.

Sets whether or not to reduce wind noise by cutting the low-range sound of the input audio from the built-in microphone.

1 MENU →  2 (Camera Settings2) → [Wind Noise Reduct.] → desired setting.

Menu item details

On:

Reduces wind noise.

Off:

Does not reduce wind noise.



Note

- Setting this item to [On] where wind is not blowing sufficiently hard may cause normal sound to be recorded with too low volume.
- When an external microphone (sold separately) is used, [Wind Noise Reduct.] does not function.

Digital Still Camera
DSC-RX0

Auto Slow Shut. (movie)

Sets whether or not to adjust the shutter speed automatically when recording movies if the subject is dark.

1 MENU →  2 (Camera Settings2) →  Auto Slow Shut.] → desired setting.

Menu item details



On:

Uses  Auto Slow Shut.]. The shutter speed automatically slows when recording in dark locations. You can reduce noise in the movie by using a slow shutter speed when recording in dark locations.

Off:

Does not use  Auto Slow Shut.]. The recorded movie will be darker than when [On] is selected, but you can record movies with smoother motion and less object blur.

Note

-  Auto Slow Shut.] does not function in the following situations:
 -  Manual Exposure]
 - When [ISO] is set to other than [ISO AUTO].

Digital Still Camera
DSC-RX0

MOVIE Button

Sets whether to activate the [MOVIE] function whenever the  (Enter) button is pressed, or whenever the left button is pressed after [MOVIE] has been assigned to it using [Custom Key(Shoot.)].

1 MENU →  **2** (Camera Settings2) → [MOVIE Button] → **desired setting.**

Menu item details

Always:

Starts movie recording when you press the button in any mode.

Movie Mode Only:

Only starts movie recording when you press the button in movie mode.

Related Topic

- [Custom Key\(Shoot.\)](#)

Digital Still Camera
DSC-RX0



Picture Profile

Allows you to change the settings for the color, gradation, etc.

For details on "Picture Profile," refer to <http://helpguide.sony.net/di/pp/v1/en/index.html>.

Customizing the picture profile

You can customize the picture quality by adjusting picture profile items such as [Gamma] and [Detail]. When setting these parameters, connect the camera to a TV or monitor, and adjust them while observing the picture on the screen.

- 1 MENU →  1 (Camera Settings1) → [Picture Profile] → the profile you want to change.
- 2 Move to the item index screen by pressing the right button.
- 3 Select the item to change using the up/down button.
- 4 Select the desired value using the up/down buttons, and then press the  (Enter) button.

Using the preset of the picture profile

The default settings [PP1] through [PP7] for movies have been set in advance in the camera based on various shooting conditions.

MENU →  1 (Camera Settings1) → [Picture Profile] → desired setting.

PP1:

Example setting using [Movie] gamma

PP2:

Example setting using [Still] gamma

PP3:

Example setting of natural color tone using the [ITU709] gamma

PP4:

Example setting of a color tone faithful to the ITU709 standard

PP5:

Example setting using [Cine1] gamma

PP6:

Example setting using [Cine2] gamma

PP7:

Example setting using [S-Log2] gamma

Items of the picture profile

Black Level

Sets the black level. (–15 to +15)

Gamma

Selects a gamma curve.

Movie: Standard gamma curve for movies

Still: Standard gamma curve for still images

Cine1: Softens the contrast in dark parts and emphasizes gradation in bright parts to produce a relaxed color movie. (equivalent to HG4609G33)

Cine2: Similar to [Cine1] but optimized for editing with up to 100% video signal. (equivalent to HG4600G30)

ITU709: Gamma curve that corresponds to ITU709.

ITU709(800%): Gamma curve for confirming scenes on the assumption of shooting using [S-Log2].

S-Log2: Gamma curve for [S-Log2]. This setting is based on the assumption that the picture will be processed after shooting.

Black Gamma

Corrects gamma in low intensity areas.

Range: Selects the correcting range. (Wide / Middle / Narrow)

Level: Sets the correcting level. (-7 (maximum black compression) to +7 (maximum black stretch))

Knee

Sets knee point and slope for video signal compression to prevent over-exposure by limiting signals in high intensity areas of the subject to the dynamic range of your camera.

When selecting [Still], [Cine1], [Cine2], [ITU709(800%)], [S-Log2] in [Gamma], [Knee] is set to [Off] if [Mode] is set to [Auto]. To use functions in [Knee], set [Mode] to [Manual].

Mode: Selects auto/manual settings.

- Auto: The knee point and slope are set automatically.
- Manual: The knee point and slope are set manually.

Auto Set: Settings when [Auto] is selected for [Mode].

- Max Point: Sets the maximum point of the knee point. (90% to 100%)
- Sensitivity: Sets the sensitivity. (High/Mid/Low)

Manual Set: Settings when [Manual] is selected for [Mode].

- Point: Sets the knee point. (75% to 105%)
- Slope: Sets the knee slope. (-5 (gentle) to +5 (steep))

Color Mode

Sets type and level of colors.

Movie: Suitable colors when [Gamma] is set to [Movie].

Still: Suitable colors when [Gamma] is set to [Still].

Cinema: Suitable colors when [Gamma] is set to [Cine1] or [Cine2].

Pro: Similar color tones to the standard image quality of Sony professional cameras (when combined with ITU709 gamma)

ITU709 Matrix: Colors corresponding to ITU709 standard (when combined with ITU709 gamma)

Black & White: Sets the saturation to zero for shooting in black and white.

S-Gamut: Setting based on the assumption that the pictures will be processed after shooting. Used when [Gamma] is set to [S-Log2].

Saturation

Sets the color saturation. (-32 to +32)

Color Phase

Sets the color phase. (-7 to +7)

Color Depth

Sets the color depth for each color phase. This function is more effective for chromatic colors and less effective for achromatic colors. The color looks deeper as you increase the setting value towards the positive side, and lighter as you decrease the value towards the negative side. This function is effective even if you set [Color Mode] to [Black & White].

[R] -7 (light red) to +7 (deep red)

[G] -7 (light green) to +7 (deep green)

[B] -7 (light blue) to +7 (deep blue)

[C] -7 (light cyan) to +7 (deep cyan)

[M] -7 (light magenta) to +7 (deep magenta)

[Y] -7 (light yellow) to +7 (deep yellow)

Detail

Sets items for [Detail].

Level: Sets the [Detail] level. (-7 to +7)

Adjust: The following parameters can be selected manually.

- Mode: Selects auto/manual setting. (Auto (automatic optimization) / Manual (The details are set manually.))
- V/H Balance: Sets the vertical (V) and horizontal (H) balance of DETAIL. (-2 (off to the vertical (V) side) to +2 (off to the horizontal (H) side))
- B/W Balance: Selects the balance of the lower DETAIL (B) and the upper DETAIL (W). (Type1 (off to the lower DETAIL (B) side) to Type5 (off to the upper DETAIL (W) side))
- Limit: Sets the limit level of [Detail]. (0 (Low limit level: likely to be limited) to 7 (High limit level: unlikely to be limited))
- Crisping: Sets the crisping level. (0 (shallow crisping level) to 7 (deep crisping level))
- Hi-Light Detail: Sets the [Detail] level in the high intensity areas. (0 to 4)

Copy

Copies the settings of the picture profile to another picture profile number.

MENU →  1 (Camera Settings1) → [Picture Profile] → [Copy]

Reset

Resets the picture profile to the default setting. You cannot reset all picture profile settings at once.

MENU →  1 (Camera Settings1) → [Picture Profile] → [Reset]

Note

- Since the parameters are shared for movie and still images, adjust the value when you change the shooting mode.
- If you develop RAW images with shooting settings, the following settings are not reflected.
 - Black Level
 - Black Gamma
 - Knee
 - Color Depth
- If you change [Gamma], the available ISO value range changes.
- When using S-Log2 gamma, the noise becomes more noticeable compared to when using other gammas. If the noise still is significant even after processing pictures, it may be improved by shooting with a brighter setting. However, the dynamic range becomes narrower accordingly when you shoot with a brighter setting. We recommend checking the picture in advance by test shooting when using S-Log2.
- Setting [ITU709(800%)] or [S-Log2] may cause an error in the white balance custom setup. In this case, perform custom setup with a gamma other than [ITU709(800%)] or [S-Log2] first, and then reselect [ITU709(800%)] or [S-Log2] gamma.
- Setting [ITU709(800%)] or [S-Log2] disables the [Black Level] setting.
- If you set [Slope] to +5 in [Manual Set], [Knee] is set to [Off].
- S-Gamut is a color space unique to Sony that provides a wide color space equivalent to film cameras. However, S-Gamut setting of this camera does not support the whole color space of S-Gamut; it is a setting to realize a color reproduction equivalent to S-Gamut.

Related Topic

- [Gamma Disp. Assist](#)

Digital Still Camera
DSC-RX0

Adjusting the settings for super-slow-motion shooting (HFR Settings)

Sets the High Frame Rate shooting settings.

1 MENU →  2 (Camera Settings2) → [**HFR** HFR Settings] → desired setting.

Menu item details

HFR Record Setting:

Selects the frame rate of the movie from [60p 50M]/[50p 50M], [30p 50M]/[25p 50M], and [24p 50M]*.

* Only when [NTSC/PAL Selector] is set to NTSC.

HFR Frame Rate:

Selects the shooting frame rate from [240fps]/[250fps], [480fps]/[500fps], and [960fps]/[1000fps].

- This setting determines the minimum shutter speed per frame.

HFR Priority Setting:

Select [Quality Priority] or [Shoot Time Priority]. If you select [Shoot Time Priority], the recordable duration is longer than in [Quality Priority] mode.

HFR REC Timing:

Selects whether to record a set amount of time after pressing the SHUTTER/MOVIE button ([Start Trigger]), or to record for a set amount of time until you press the SHUTTER/MOVIE button ([End Trigger]).

Frame rate

In super-slow-motion movie shooting, the camera shoots at a faster shutter speed than the number of shooting frames per second. For example, when [**HFR** Frame Rate] is set to [960fps], the shutter speed per frame will be faster than approx. 1/1000 second in order to shoot 960 frames per second. To maintain this shutter speed, sufficient ambient light is necessary during shooting. If the ambient light is insufficient, the ISO sensitivity will become higher, resulting in more noise.

Timing of recording

Depending on the [**HFR** REC Timing] setting, the relationship between when you press the SHUTTER/MOVIE button and the recorded section of the movie is as shown below.

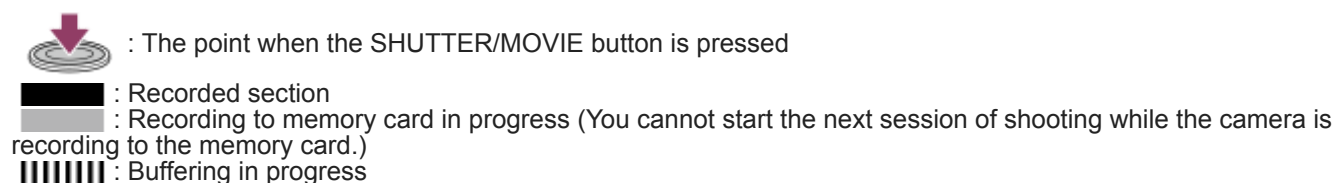

[Start Trigger]

Movie capturing (shooting) starts when the SHUTTER/MOVIE button is pressed. When the SHUTTER/MOVIE button is pressed again, or when the recordable duration of time has elapsed, movie capturing ends and the camera starts to record the captured movie to the memory card.



[End Trigger]

Buffering (temporarily capturing a movie on the camera) starts once the shooting standby screen is displayed. When the captured data fills the buffering capacity, old data is overwritten sequentially. When you press the SHUTTER/MOVIE button, the camera starts to record a movie of the maximum recordable duration calculated retroactively from that point on the memory card.

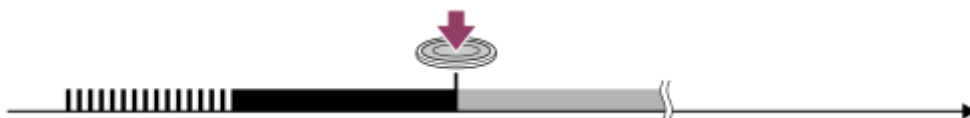

To redo shooting

You can cancel recording by selecting [Cancel] on the screen. However, the movie recorded up to the point you cancelled will be saved.

Playback speed

The playback speed will vary as below depending on the assigned [**HFR** Frame Rate] and [**HFR** Record Setting].

HFR Frame Rate	HFR Record Setting		
	24p 50M*	30p 50M/25p 50M	60p 50M/50p 50M
240fps/250fps	10 times slower	8 times slower/10 times slower	4 times slower/5 times slower
480fps/500fps	20 times slower	16 times slower/20 times slower	8 times slower/10 times slower
960fps/1000fps	40 times slower	32 times slower/40 times slower	16 times slower/20 times slower

* Only when [NTSC/PAL Selector] is set to NTSC.

[**HFR** Priority Setting] and recordable duration

HFR Priority Setting	HFR Frame Rate	Effective pixel number read out from image sensor	Recordable duration
Quality Priority	240fps/250fps	1676×942	Approx. 2 seconds
	480fps/500fps	1676×566	
	960fps/1000fps	1136×384	
Shoot Time Priority	240fps/250fps	1676×566	Approx. 4 seconds
	480fps/500fps	1136×384	
	960fps/1000fps	800×270	

Playback time

For example, if you shoot for approx. 4 seconds with [**HFR** Record Setting] set to [24p 50M]*, [**HFR** Frame Rate] set to [960fps], and [**HFR** Priority Setting] set to [Shoot Time Priority], the playback speed will be 40 times slower and the playback time will be approx. 160 seconds (approx. 2 minutes and 40 seconds).

* Only when [NTSC/PAL Selector] is set to NTSC.



Related Topic

- [Shooting super-slow-motion movies \(High Frame Rate\)](#)
- [Movie recording formats](#)
- [Usable memory cards](#)
- [Selecting the exposure mode for super-slow-motion shooting \(Exposure Mode\)](#)

Digital Still Camera
DSC-RX0

Selecting the exposure mode for super-slow-motion shooting (Exposure Mode)

You can select the exposure mode for HFR shooting based on the subject and effect you want.

1 MENU →  2 (Camera Settings2) → [ Exposure Mode] → desired settings.

Menu item details



 Program Auto/  Manual Exposure

Related Topic

- [Shooting super-slow-motion movies \(High Frame Rate\)](#)
- [Adjusting the settings for super-slow-motion shooting \(HFR Settings\)](#)

Memory (Camera Settings1/Camera Settings2)

Allows you to register up to 3 often-used modes or product settings to the product and up to 4 (M1 through M4) to the memory card. You can recall the settings by selecting [Memory recall] in [Shoot Mode].

- 1 Set the product to the setting you want to register.
- 2 MENU →  (Camera Settings1) → [/ Memory] → desired number.

Items that can be registered

- You can register various shooting settings. These items can be confirmed in Step 2.
- Manual focus settings cannot be registered.

To change registered settings

Change the setting to the desired one and re-register the setting to the same mode number.

Note

- M1 through M4 can be selected only when a memory card is inserted into the product.

Related Topic

- [Memory recall \(Camera Settings1/Camera Settings2\)](#)

Digital Still Camera
DSC-RX0

Function Menu Set.

You can assign the functions to be called up when you press the Fn (Function) button.

- 1 **MENU** →  **2 (Camera Settings2)** → **[Function Menu Set.]** → **set a function to the desired location.**



The functions that can be assigned are displayed on the setup item selection screen.

Related Topic











- [Using the Fn \(Function\) button](#)

Custom Key(Shoot.)

Assigning functions to the various keys speeds up operations by allowing you to execute the assigned functions simply by pressing the appropriate key when the shooting screen is displayed.

- 1 MENU →   (Camera Settings2) → [Custom Key(Shoot.)] → set a function to the desired key.
 - The functions that can be assigned vary for each button.

Functions that can be assigned using [Custom Key(Shoot.)]

 Quality	 Image Size	 Aspect Ratio
Shoot Mode	Drive Mode	Selftimer during Brkt
 1/  2 Memory	Focus Mode	AF/MF Control Hold *1
AF/MF Ctrl Toggle	Focus Standard *1 *2	Focus Area
 button Lock-on AF	Eye AF *1	NEAR Mode in PF
Set Focus	Shutter Speed	Exposure Comp.
ISO	ISO AUTO Min. SS	Metering Mode
AEL hold *1	AEL toggle	 AEL hold *1
 AEL toggle	White Balance	DRO/Auto HDR
Creative Style	Picture Effect	Picture Profile
Peaking Level	Peaking Color	Face Detection
MOVIE	 Frame Rate	Audio Rec Level
Audio Level Display	 Marker Disp. Sel.	Zoom
Zebra	Grid Line	Live View Display
Audio signals	Send to Smartphone	Monitor Brightness
Gamma Disp. Assist	Not set	

*1 This function cannot be assigned to the left button.

*2 Depending on settings such as [Focus Mode] and [Focus Area], the functionality varies as follows:

When [Focus Mode] is set to [Single-shot AF] (only during still image shooting):

When [Focus Area] is set to [Flexible Spot]/[Expand Flexible Spot], you can change the position of the focusing frame by pressing the button. You can shoot still images while changing the position of the focusing frame.

When [Focus Area] is set to [Wide] or [Center] and [ button Lock-on AF] is set to [On], [ button Lock-on AF] is activated.

When [Focus Mode] is set to [Preset Focus] (only during movie shooting):

By pressing the button, you can switch between [On]/[Off] for [NEAR Mode in PF].

When [Focus Mode] is set to [Manual Focus]:

The manual focusing screen is displayed when you press the button.



Related Topic

- [Function of the Enter button](#)
- [Function of the Left button](#)

4-698-613-13(1) Copyright 2017 Sony Corporation

Digital Still Camera
DSC-RX0

Function of the Enter button

Once you have assigned a function to the  (Enter) button, you can execute that function by simply pressing the  (Enter) button when the shooting screen is displayed.

1 MENU →  **2** (Camera Settings2) → [Custom Key(Shoot.)] → [ Button] → **desired setting.**

The functions that can be assigned are displayed on the setup item selection screen.

Related Topic

- [Custom Key\(Shoot.\)](#)

Digital Still Camera
DSC-RX0

Function of the Left button

Once you have assigned a function to the left button, you can execute that function by simply pressing the left button when the shooting screen is displayed.

1 MENU →  **2** (Camera Settings2) → [Custom Key(Shoot.)] → [Left Button] → **desired setting.**

The functions that can be assigned are displayed on the setup item selection screen.

Related Topic

- [Custom Key\(Shoot.\)](#)

Digital Still Camera
DSC-RX0

Face Detection

Detects the faces of your subjects and adjusts the focus, exposure settings and performs image processing automatically.

1 MENU →  (Camera Settings1) → [Face Detection] → desired setting.

Menu item details

 Off:

Does not use the Face Detection function.

 On (Regist. Faces):

Detects the registered face with higher priority using [Face Registration].

 On:

Detects a face without giving higher priority to the registered face.

Face Detection frame

- When the product detects a face, the gray face detection frame appears. When the product determines that autofocus is enabled, the face detection frame turns white. When you press the shutter button halfway down, the frame turns green.
- In case you have registered the priority order for each face using [Face Registration], the product automatically selects the first prioritized face and the face detection frame over that face turns white. The face detection frames of other registered faces turn reddish-purple.



Note

- You cannot use the Face Detection function with the following functions:
 - [Picture Effect] is set to [Posterization].
 - [ Record Setting] is set to [120p]/[100p].
- Up to eight faces of your subjects can be detected.
- The product may not detect faces at all or may accidentally detect other objects as faces in some conditions.

Face Registration (New Registration)

If you register faces in advance, the product can detect the registered face as a priority when [Face Detection] is set to [On (Regist. Faces)].

- 1 MENU →  1 (Camera Settings1) → [Face Registration] → [New Registration].
- 2 Align the guide frame with the face to be registered, and press the SHUTTER/MOVIE button.
- 3 When a confirmation message appears, select [Enter].

Note

- Up to eight faces can be registered.
- Shoot the face from the front in a brightly lit place. The face may not be registered correctly if it is obscured by a hat, a mask, sunglasses, etc.

Digital Still Camera
DSC-RX0

Face Registration (Order Exchanging)

When multiple faces are registered to be given priority, the face registered first will be given priority. You can change the priority order.

- 1 MENU →  1 (Camera Settings1) → [Face Registration] → [Order Exchanging].
- 2 Select a face to change the order of priority.
- 3 Select the destination.

Digital Still Camera
DSC-RX0

Face Registration (Delete)

Deletes a registered face.

1 MENU →  (Camera Settings1) → [Face Registration] → [Delete].

If you select [Delete All], you can delete all registered faces.



Note

- Even if you execute [Delete], the data for registered face will remain in the product. To delete the data for registered faces from the product, select [Delete All].

Digital Still Camera
DSC-RX0

High ISO NR (still image)

When shooting with high ISO sensitivity, the product reduces noise that becomes more noticeable when the product sensitivity is high. A message may be displayed during noise reduction processing and you cannot shoot another image until the message disappears.

1 MENU →  1 (Camera Settings1) → [ High ISO NR] → desired setting.

Menu item details

Normal:

Activates high ISO noise reduction normally.





Low:

Activates high ISO noise reduction moderately.

Off:

Does not activate high ISO noise reduction. Select this to prioritize the timing of shooting.

Note

- [ High ISO NR] is not available in the following situations:
 - When the shooting mode is set to [Intelligent Auto] or [Superior Auto].
- [ High ISO NR] is not available when [ Quality] is [RAW].
- [ High ISO NR] does not work for RAW images when the [ Quality] is [RAW & JPEG].

Digital Still Camera
DSC-RX0

Audio signals

Selects whether the product produces a sound or not.

1 MENU →  **2** (Camera Settings2) → [Audio signals] → desired setting.

Menu item details



On:
Sounds are produced for example when the focus is achieved by pressing the SHUTTER/MOVIE button halfway down.

Shutter:
Only the shutter sound is produced.

Off:
No operational signaling or shutter sounds are produced.

Write Date (still image)

Sets whether to record a shooting date on the still image.

1 MENU →  2 (Camera Settings2) → [ Write Date] → desired setting.

Menu item details

On:

Records a shooting date.

Off:

Does not record a shooting date.



Note

- If you shoot images with the date once, you cannot delete the date from the images later.
- The dates are doubly printed if you set the PCs or printers to print dates when printing the images.
- The recorded time of the image cannot be superimposed on the image.
- [ Write Date] is not available for RAW images.

Digital Still Camera
DSC-RX0

Color Space (still image)

The way colors are represented using combinations of numbers or the range of color reproduction is called “color space.” You can change the color space depending on the purpose of the image.

1 MENU →  1 (Camera Settings1) → [ Color Space] → desired setting.

Menu item details

sRGB:

This is the standard color space of the digital camera. Use [sRGB] in normal shooting, such as when you intend to print out the images without any modification.

AdobeRGB:

This color space has a wide range of color reproduction. When a large part of the subject is vivid green or red, Adobe RGB is effective. The file name of the recorded image starts with “_.”

Note

- [AdobeRGB] is for applications or printers that support color management and DCF2.0 option color space. Images may not be printed or viewed in the correct colors if you use applications or printers that do not support Adobe RGB.
- When displaying images that were recorded with [AdobeRGB] on non-Adobe RGB-compliant devices, the images will be displayed with low saturation.

Digital Still Camera
DSC-RX0

Grid Line

Sets whether the grid line is displayed or not. The grid line will help you to adjust the composition of images.

1 MENU →  2 (Camera Settings2) → [Grid Line] → desired setting.

Menu item details

Rule of 3rds Grid:

Place main subjects close to one of the grid lines that divide the image into thirds for a well-balanced composition.

Square Grid:

Square grids make it easier to confirm the horizontal level of your composition. This is suitable to determine the quality of the composition when shooting landscape, close-up, or duplicated images.

Diag. + Square Grid:

Place a subject on the diagonal line to express an uplifting and powerful feeling.

Off:

Does not display the grid line.

Digital Still Camera
DSC-RX0

Auto Review

You can check the recorded image on the screen right after the shooting. You can also set the display time for Auto Review.

1 MENU →  2 (Camera Settings2) → [Auto Review] → desired setting.

Menu item details

10 Sec/5 Sec/2 Sec:

Displays the recorded image on the screen right after shooting for the selected duration of time. If you press the  (Enter) button during Auto Review, you can check the image on a magnified scale.

Off:

Does not display the Auto Review.

Note

- When you use a function that performs image processing, the image before processing may be displayed temporarily, followed by the image after processing.
- The DISP (Display Setting) settings are applied for the Auto Review display.

Related Topic

- [Switching the screen display \(during playback\)](#)
- [Playback zoom](#)

Digital Still Camera
DSC-RX0

Live View Display

Sets whether or not to show images altered with effects of the exposure compensation, white balance, [Creative Style], or [Picture Effect] on the screen.

1 MENU →  2 (Camera Settings2) → [Live View Display] → desired setting.

Menu item details

Setting Effect ON:

Displays Live View in conditions close to what your picture will look like as a result of applying all your settings. This setting is useful when you want to shoot pictures while checking the results of the shot on the Live View screen.



Setting Effect OFF:

Displays Live View without the effects of exposure compensation, white balance, [Creative Style], or [Picture Effect]. When this setting is used, you can easily check the image composition.

Live View is always displayed with the appropriate brightness even in [Manual Exposure] mode.

When [Setting Effect OFF] is selected, the **VIEW** icon is displayed on the Live View screen.

Note

- When the shooting mode is set to [Intelligent Auto], [Superior Auto], [ Intelligent Auto], [ Program Auto], [ Manual Exposure] or [High Frame Rate], [Live View Display] cannot be set to [Setting Effect OFF].
- When [Live View Display] is set to [Setting Effect OFF], the brightness of the shot image will not be the same as that of the displayed Live View.

Digital Still Camera
DSC-RX0

Release w/o Card

Sets whether the shutter can be released when no memory card has been inserted.

1 MENU →  2 (Camera Settings2) → [Release w/o Card] → desired setting.

Menu item details

Enable:

Releases the shutter even if no memory card has been inserted.

Disable:

Does not release the shutter when no memory card has been inserted.

Note

- When no memory card has been inserted, the images shot will not be saved.
- The default setting is [Enable]. It is recommended that you select [Disable] prior to actual shooting.

Digital Still Camera
DSC-RX0

Playing back images

Plays back the recorded images.

- 1 Press the  (Playback) button to switch to the playback mode.
- 2 Select the image with the left/right button.

To return to shooting images

Select MENU →  (Playback) → [Shoot./PB Selector] to return to the shooting mode.

- You can also go back to the shooting mode by pressing the SHUTTER/MOVIE button halfway down.

Hint

- The product creates an image database file on a memory card to record and play back images. An image that is not registered in the image database file may not be played back correctly. To play back images shot using other devices, register those images to the image database file using MENU →  (Setup) → [Recover Image DB].

Note





- If you play back the images right after continuous shooting, the monitor may display an icon indicating that data is being written/the number of images left to write. During writing, some functions are not available.

Related Topic



- [Recover Image DB](#)

Playback zoom

Enlarges the image being played back.

- 1 Press the  (Playback) button to switch to the playback mode.
- 2 Display the image you want to enlarge, and select MENU →  (Playback) → [ Enlarge Image].
 - On the single-image playback screen, you can enlarge the image by pressing the  (Enter) button.
- 3 Select the portion you want to enlarge by pressing the up/down/left/right buttons.
- 4 Press the MENU button or the  (Enter) button to end playback zooming.

Hint

- You can change the initial position of enlarged images by selecting MENU →  (Playback) → [ Enlarge Initial Pos.].

Note

- You cannot enlarge movies.
- You cannot change the magnification scale.

Related Topic

- [Enlarge Initial Pos.](#)

Digital Still Camera
DSC-RX0

Image Index

You can display multiple images at the same time in playback mode.

1 Press the  (Playback) button to switch to the playback mode.

2 MENU →  (Playback) → [Image Index] → desired setting.

Menu item details

9 Images /25 Images

To return to single-image playback

Select the desired image and press the  (Enter) button.

To display a desired image quickly

Select the bar on the left of the image index screen, and then press the up/down button. While the bar is being selected, you can display the calendar screen or folder selection screen by pressing the  (Enter) button. In addition, you can switch View Mode by selecting an icon.

Related Topic

- [View Mode](#)

Switching the screen display (during playback)

Switches the screen display.

- 1 Press the  (Playback) button to switch to the playback mode.
- 2 Press the DISP (Display Setting) button.
 - The screen display switches in the order “Display Info. → Histogram → No Disp. Info. → Display Info.” each time you press the DISP button.
 - The DISP (Display Setting) settings are applied for the Auto Review display.



Note

- The histogram is not displayed in the following situations:
 - During movie playback
 - During slideshows
 - During Folder View (MP4)
 - During AVCHD View
 - During XAVC S HD View

Digital Still Camera
DSC-RX0

Playing back movies

Plays back the recorded movies.

- 1 Press the  (playback) button to switch to playback mode.
- 2 Select a movie to play back using the left/right buttons.
- 3 To play back movies, press the  (Enter) button.













To return to shooting images

Select MENU →  (Playback) → [Shoot./PB Selector] to return to the shooting mode.

- You can also go back to the shooting mode by pressing the SHUTTER/MOVIE button halfway down.

Available operations during movie playback

You can perform slow playback and sound volume adjustment, etc. by pressing the down button.

-  : Playback
-  : Pause
-  : Fast-forward
-  : Fast-rewind
-  : Forward slow playback
-  : Reverse slow playback
-  : Next movie file
-  : Previous movie file
-  : Displays the next frame
-  : Displays the previous frame
-  : Sound volume adjustment
-  : Closes the operation panel

Hint

- “Forward slow playback,” “Reverse slow playback,” “Displays the next frame” and “Displays the previous frame” are available during pause.



Related Topic

- [View Mode](#)

Digital Still Camera
DSC-RX0

Delete





You can delete multiple selected images.

- 1 Press the  (Playback) button to switch to the playback mode.
- 2 MENU →  (Playback) → [Delete] → desired setting.

Menu item details

Multiple Img.:

Deletes the selected images.

(1) Select the images to be deleted, then press the  (Enter) button. The  mark is displayed in the check box. To cancel the selection, press the  (Enter) button again to remove the  mark.

(2) To delete other images, repeat step (1).

(3) MENU → [OK] → Press the  (Enter) button.

All in this Folder:

Deletes all images in the selected folder.

All with this date:

Deletes all images in the selected date range.

Hint

- Perform [Format] to delete all images, including protected images.

Note

- The menu items that can be selected differ depending on the [View Mode] setting.



Related Topic

- [Format](#)

Digital Still Camera
DSC-RX0

Specify Printing





You can specify in advance on the memory card which still images you want to print out later. The **DPOF** (print order) icon will appear on the specified images. DPOF refers to “Digital Print Order Format.”

- 1 Press the  (Playback) button to switch to the playback mode.
- 2 MENU →  (Playback) → [Specify Printing] → desired setting.

Menu item details

Multiple Img.:

Selects images to order printing.

- (1) Select an image and press the  (Enter) button. The  mark is displayed in the check box. To cancel the selection, press the  (Enter) button and delete the  mark.
- (2) Repeat step (1) to print other images.
- (3) MENU → [OK] → Press the  (Enter) button.

Cancel All:

Clears all DPOF marks.

Print Setting:

Sets whether to print the date on images registered with DPOF marks.



Note

- You cannot add the DPOF mark to the following files:
 - Movies
 - RAW images

Digital Still Camera
DSC-RX0

View Mode

Sets the View Mode (image display method).

- 1 Press the  (Playback) button to switch to the playback mode.
- 2 MENU →  (Playback) → [View Mode] → desired setting.

Menu item details

 **Date View:**

Displays the images by date.

 **Folder View(Still):**

Displays only still images.

 **Folder View(MP4):**

Displays only MP4-format movies.

 **AVCHD View:**



Displays only AVCHD-format movies.

 **XAVC S HD View:**

Displays only XAVC S HD-format movies.

Slide Show

Automatically plays back images continuously.

- 1 Press the  (Playback) button to switch to the playback mode.
- 2 MENU →  (Playback) → [Slide Show] → desired setting.
- 3 Select [Enter].

Menu item details

Repeat:

Select [On], in which images are played back in a continuous loop, or [Off], in which the product exits the slideshow when all the images are played back once.

Interval:

Select the display interval for images from among [1 Sec], [3 Sec], [5 Sec], [10 Sec] or [30 Sec].

To quit the slideshow in the middle of playback

Press the MENU button to quit the slideshow. You cannot pause the slideshow.

Hint

- You can activate a slideshow only when [View Mode] is set to [Date View] or [Folder View(Still)].

Rotate

Rotates a recorded still image.

1 Press the  (Playback) button to switch to the playback mode.

2 MENU →  (Playback) → [Rotate].

3 Press the  (Enter) button.

The image is rotated counter-clockwise. The image rotates as you press the  (Enter) button.
If you rotate the image once, the image remains rotated even after the product is turned off.

Note

- Images shot vertically using this camera are recorded as horizontally shot images.
- You cannot rotate the movies.
- You may not be able to rotate images shot using other products.
- When viewing rotated images on a computer, the images may be displayed in their original orientation depending on the software.

Digital Still Camera
DSC-RX0

Enlarge Initial Pos.

Sets the initial position when enlarging an image in playback.

1 MENU →  (Playback) → [ Enlarge Initial Pos.] → desired setting.

Menu item details

Focused Position:

Enlarges the image from the point of focus during shooting.

Center:

Enlarges the image from the center of the screen.

Related Topic

- [Playback zoom](#)

Digital Still Camera
DSC-RX0

Protect





Protects recorded images against accidental erasure. The  mark is displayed on protected images.

- 1 Press the  (Playback) button to switch to the playback mode.
- 2 MENU →  (Playback) → [Protect] → desired setting.

Menu item details

Multiple Img.:

Applies or cancels the protection of the selected multiple images.

- (1) Select the image to be protected, then press the  (Enter) button. The  mark is displayed in the check box. To cancel the selection, press the  (Enter) button again to remove the  mark.
- (2) To protect other images, repeat step (1).
- (3) MENU → [OK] → Press the  (Enter) button.

All in this Folder:

Protects all images in the selected folder.

All with this date:

Protects all images in the selected date range.

Cancel All in this Folder:

Cancels the protection of all images in the selected folder.

Cancel All with this date:

Cancels the protection of all images in the selected date range.

Note

- The menu items that can be selected differ depending on the [View Mode] setting.

Digital Still Camera
DSC-RX0

4K Still Image PB

Outputs still images in 4K resolution to an HDMI-connected TV that supports 4K.

- 1 Turn off this product and the TV.
- 2 Connect the HDMI micro terminal of this product to the HDMI jack of the TV using an HDMI cable (sold separately).

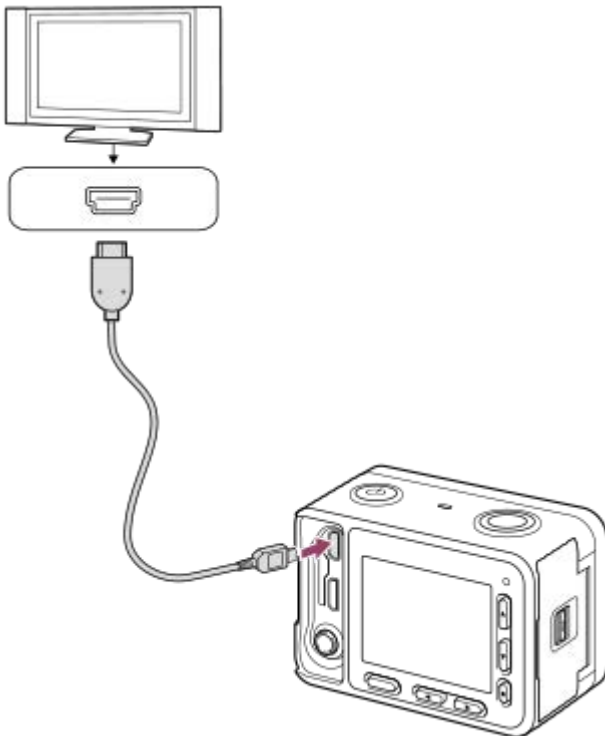

- 3 Turn on the TV and switch the input.
- 4 Turn on this product.
- 5 MENU →  (Playback) → [4K Still Image PB] → [OK].

Note

- This menu is only available with 4K-compatible TVs. For details, refer to the operating instructions of the TV.

Viewing images on an HD TV

To view images stored on this product using a TV, an HDMI cable (sold separately) and an HD TV equipped with an HDMI jack are required.

- 1 Turn off both this product and the TV.**
- 2 Connect the HDMI micro terminal of this product to the HDMI jack of the TV using an HDMI cable (sold separately).**

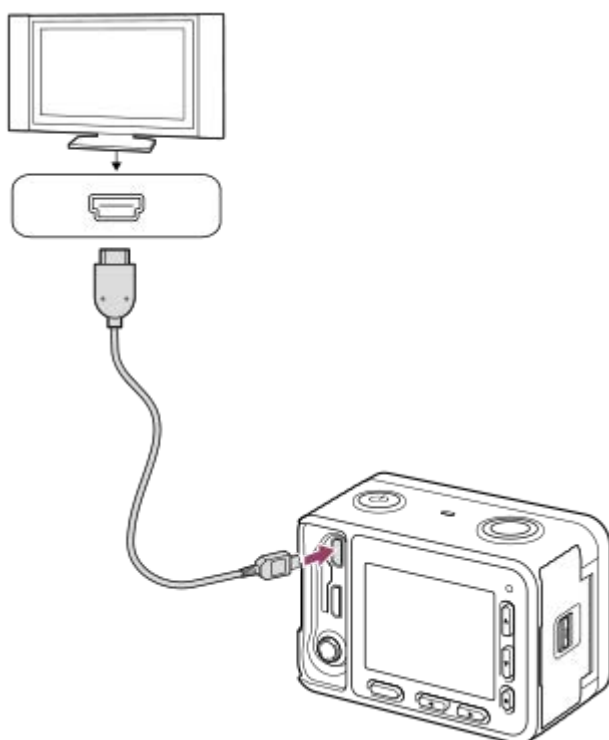



- 3 Turn on the TV and switch the input.**
- 4 Turn on this product.**
Images shot with the product appear on the TV screen.

Hint

- This product is compatible with the PhotoTV HD standard. If you connect Sony PhotoTV HD-compatible devices using an HDMI cable (sold separately), the TV is set to the image quality suitable for viewing still images, and a whole new world of photos can be enjoyed in breathtaking high quality.
- You can connect this product to Sony PhotoTV HD-compatible devices with a USB terminal using the supplied micro USB cable.
- The PhotoTV HD allows for a highly-detailed, photo-like expression of subtle textures and colors.
- For details, refer to the operating instructions supplied with the compatible TV.

Note

- Do not connect this product and another device using the output terminals of both. Doing so may cause a malfunction.
- Some devices may not work properly when connected to this product. For example, they may not output video or audio.
- Use an HDMI cable with the HDMI logo or a genuine Sony cable.
- Use an HDMI cable that is compatible with the HDMI micro terminal of the product and the HDMI jack of the TV.
- When [ TC Output] is set to [On], the image may not be output properly to the TV or recording device. In such cases, set [ TC Output] to [Off].
- If images do not appear on the TV screen properly, select [1080i] or [1080p] using  (Setup) → [HDMI Settings] → [HDMI Resolution] according to the TV to be connected.

Digital Still Camera
DSC-RX0

Viewing images on a “BRAVIA” Sync-compatible TV

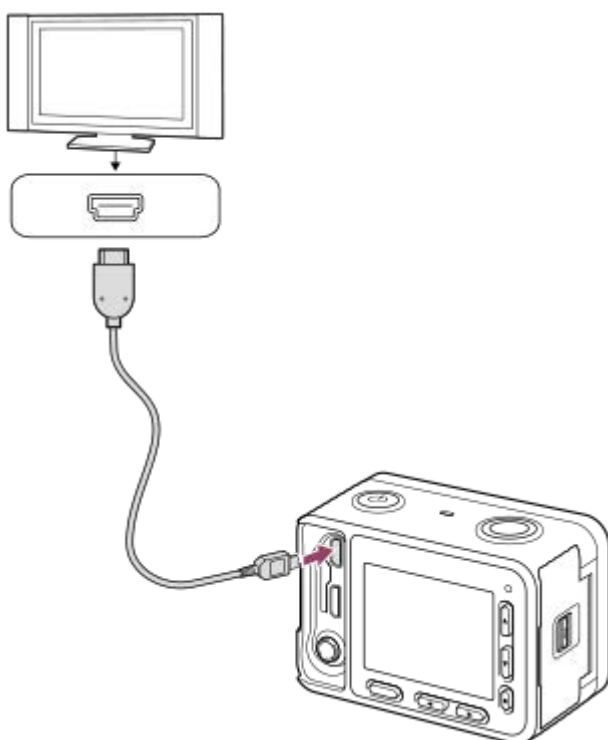

By connecting this product to a TV that supports “BRAVIA” Sync using an HDMI cable (sold separately), you can operate this product’s playback functions with the TV remote control.

- 1 Turn off both this product and the TV.
- 2 Connect the HDMI micro terminal of the product to the HDMI jack of the TV using an HDMI cable (sold separately).



- 3 Turn on the TV and switch the input.
- 4 Turn on this product.
- 5 MENU →  (Setup) → [HDMI Settings] → [CTRL FOR HDMI] → [On].
- 6 Press the SYNC MENU button on the TV remote control, and select the desired mode.

Note

- If the product is not in playback mode, press the  (Playback) button.
- Only TVs that support “BRAVIA” Sync can provide SYNC MENU operations. For details, refer to the operating instructions supplied with the TV.
- If the product performs unwanted operations in response to the TV remote control when the product is connected to another manufacturer’s TV using an HDMI connection, select MENU →  (Setup) → [HDMI Settings] → [CTRL FOR HDMI] → [Off].

Monitor Brightness

You can adjust the brightness of the screen.

1 MENU →  (Setup) → [Monitor Brightness] → desired setting.

Menu item details

Manual:

Adjusts the brightness within the range of -2 to +2.

Sunny Weather:

Sets the brightness appropriately for shooting outdoors.

Note

- The [Sunny Weather] setting is too bright for shooting indoors. Set [Monitor Brightness] to [Manual] for indoor shooting.
- The monitor brightness cannot be adjusted in the following situations. The maximum brightness will be [±0].
 - When [ HDMI 4K Output] is not set to [Off]
- The monitor brightness is locked at [-2] when using Wi-Fi functions.

Digital Still Camera
DSC-RX0

Gamma Disp. Assist

Movies with S-Log gamma are assumed to be processed after shooting in order to make use of the wide dynamic range. They are therefore displayed in low contrast during shooting and may be difficult to monitor. However, using [Gamma Disp. Assist], contrast equivalent to that of normal gamma can be reproduced. In addition, [Gamma Disp. Assist] can also be applied when playing back movies on the camera's monitor.

1 MENU →  (Setup) → [Gamma Disp. Assist] → desired setting.

Menu item details

 **Off:**

Does not apply [Gamma Disp. Assist].

 **Auto:**

Displays movies with an [S-Log2→709(800%)] effect when the gamma set in [Picture Profile] is [S-Log2]. [Gamma Disp. Assist] is not applied when the gamma is set to other than [S-Log2].

 **S-Log2→709(800%):**

Displays movies with an S-Log2 gamma reproducing contrast equivalent to ITU709(800%).

Note

- When [Gamma Disp. Assist] is set to [Auto] during playback, the picture is displayed based on the current gamma setting in [Picture Profile] instead of auto-detecting the gamma value of the movie.
- [Gamma Disp. Assist] is not applied to movies when displayed on a TV or monitor connected to the camera.

Related Topic

- [Picture Profile](#)

Digital Still Camera
DSC-RX0

Volume Settings

Sets the sound volume for movie playback.

1 MENU →  (Setup) → [Volume Settings] → desired setting.

Adjusting the volume during playback

Press the down button while playing back movies to display the operation panel, then adjust the volume. You can adjust the volume while listening to the actual sound.

Digital Still Camera
DSC-RX0

Tile Menu

Selects whether to always display the first screen of the menu when you press the MENU button.

1 MENU →  (Setup) → [Tile Menu] → desired setting.

Menu item details

On:

Always displays the first screen of the menu (Tile Menu).

Off:

Deactivates the Tile Menu display.

Digital Still Camera
DSC-RX0

Pwr Save Start Time

You can set the time by which the power goes off automatically.

1 MENU →  (Setup) → [Pwr Save Start Time] → desired setting.

Menu item details

30 Min/5 Min/2 Min/1 Min

Note

- The power save function is not activated when power is being supplied via USB, when playing back slideshows, when recording movies, or when connected to a computer or TV.

Digital Still Camera
DSC-RX0

Auto Pwr OFF Temp.

Sets the temperature of the camera at which the camera turns off automatically during shooting. When it is set to [High], you can continue shooting even when the temperature of the camera gets hotter than normal.

1 MENU →  (Setup) → [Auto Pwr OFF Temp.] → desired setting.

Menu item details

Standard:

Sets the standard temperature for the camera to turn off.

High:

Sets the temperature at which the camera turns off to higher than [Standard].

Notes when [Auto Pwr OFF Temp.] is set to [High]

- Do not shoot while holding the camera in your hand. Use a tripod.
- Using the camera while holding it in your hand for a long period of time may cause low-temperature burns.

Continuous recording time for movies when [Auto Pwr OFF Temp.] is set to [High]

The duration of time available for continuous movie recording is as follows when the camera starts recording with the default settings after the power has been turned off for a while. The following values indicate the continuous time from when the camera starts recording until the camera stops recording.

Ambient temperature	Continuous recording time for movies
20°C (68°F)	Approx. 60 minutes
30°C (86°F)	Approx. 60 minutes
40°C (104°F)	Approx. 25 minutes

When recording in XAVC S HD (60p 50M/50p 50M)

Note

- Even if [Auto Pwr OFF Temp.] is set to [High], depending on the conditions or the temperature of the camera, the recordable time for movies may not change.

Related Topic

- [Recordable time of movies](#)

Flip

Sets whether or not to record images upside down. Use the flip function when the camera is placed upside down.

1 MENU →  (Setup) → [Flip] → desired setting.

Menu item details

On:

Records images upside down. Audio is also recorded with the left and right sides reversed.

Off:

Does not record images upside down. Records images and sound as usual.

Note

- If you set [Flip] to [On], the functions of the up/down buttons and the left/right buttons of the camera will also be reversed. Example: the DISP (Display Setting) function is assigned to the up button, however, if you set [Flip] to [On], the DISP function will switch to the down button.
- Audio is also recorded with the left and right sides reversed when using an external microphone.

Related Topic

- [Using the up/down/left/right buttons and the Enter button](#)

NTSC/PAL Selector

Plays back movies recorded with the product on a NTSC/PAL system TV.

1 MENU →  (Setup) → [NTSC/PAL Selector] → [Enter]

Note

- If you insert a memory card that has previously been formatted with a different video system, a message telling you that you must reformat the card will appear.
If you want to record using another system, re-format the memory card or use another memory card.
- When you perform [NTSC/PAL Selector], and the setting is changed from the default one, a message "Running on NTSC." or "Running on PAL." will appear on the start-up screen.

Demo Mode

The [Demo Mode] function displays the movies recorded on the memory card automatically (demonstration), when the camera has not been operated for a certain time. Normally select [Off].

1 MENU →  (Setup) → [Demo Mode] → desired setting.

Menu item details

On:

The movie playback demonstration starts automatically if the product is not operated for about one minute. Only protected AVCHD movies are played back.

Set the view mode to [AVCHD View], and protect the movie file with the oldest recorded date and time.

Off:

Does not show the demonstration.

Note

- You can set this item only when the product is powered by the AC Adaptor (supplied).
- When there are no protected AVCHD movies on the memory card, the demonstration will not start even if [On] is selected.

TC/UB Settings

The time code (TC) and the user bit (UB) information can be recorded as data attached to movies.

1 MENU →  (Setup) → [TC/UB Settings] → setting value you want to change.

Menu item details

TC Preset:

Sets the time code.

TC Reset:

Resets the time code.

UB Preset:

Sets the user bit.

UB Reset:

Resets the user bit.

TC Format:

Sets the recording method for the time code. (Only when [NTSC/PAL Selector] is set to NTSC.)

TC Run:

Sets the count up format for the time code.

TC Make:

Sets the recording format for the time code on the recording medium.

UB Time Rec:

Sets whether or not to record the time as a user bit.

How to set the time code (TC Preset)

1. MENU →  (Setup) → [TC/UB Settings] → [TC Preset], then press the ● (Enter) button.
2. Press the up/down buttons and select the first two digits.

- The time code can be set between the following range.

When [60i] is selected: 00:00:00:00 to 23:59:59:29

* When [24p] is selected, you can select the last two digits of the time code in multiples of four from 0 to 23 frames.

When [50i] is selected: 00:00:00:00 to 23:59:59:24

3. Set the other digits following the same procedure as in step 2, then press the ● (Enter) button.

How to reset the time code

1. MENU →  (Setup) → [TC/UB Settings] → [TC Reset], then press the ● (Enter) button.
You can also reset the time code (00:00:00:00) using the RMT-VP1K remote commander (sold separately).

How to set the user bit (UB Preset)

1. MENU →  (Setup) → [TC/UB Settings] → [UB Preset], then press the ● (Enter) button.
2. Press the up/down buttons and select the first two digits.
3. Set the other digits following the same procedure as in step 2, then press the ● (Enter) button.

How to reset the user bit

1. MENU →  (Setup) → [TC/UB Settings] → [UB Reset], then press the ● (Enter) button.

How to select the recording method for the time code (TC Format ^{*1})

1. MENU →  (Setup) → [TC/UB Settings] → [TC Format], then press the ● (Enter) button.

DF:

Records the time code in Drop Frame^{*2} format.

NDF:



Records the time code in Non-Drop Frame format.

*1 Only when [NTSC/PAL Selector] is set to NTSC.

*2 The time code is based on 30 frames per second. However, a gap between the actual time and the time code will occur during extended periods of recording as the frame frequency of the NTSC image signal is approximately 29.97 frames per second. Drop frame corrects this gap to make the time code and actual time equal. In drop frame, the first 2 frame numbers are removed every minute except for every tenth minute. The time code without this correction is called non-drop frame.

- The setting is locked to [NDF] when recording in 1080/24p or when [ HDMI 4K Output] is set to [24p] .

How to select the count up format for the time code (TC Run)

1. MENU →  (Setup) → [TC/UB Settings] → [TC Run], then press the  (Enter) button.

Rec Run:



Sets the stepping mode for the time code to advance only while recording. The time code is recorded sequentially from the last time code of the previous recording.

Free Run:

Sets the stepping mode for the time code to advance anytime, regardless of the camera operation.

- The time code may not be recorded sequentially in the following situations even when the time code advances in [Rec Run] mode.
 - When the recording format is changed.
 - When the recording medium is removed.

How to select how the time code is recorded (TC Make)

1. MENU →  (Setup) → [TC/UB Settings] → [TC Make], then press the  (Enter) button.

Preset:

Records the newly set time code on the recording medium.

Regenerate:

Reads the last time code for the previous recording from the recording medium and records the new time code consecutively from the last time code. The time code advances in [Rec Run] mode regardless of the [TC Run] setting.

Note

- The time code and the user bit are not displayed on the camera's monitor. You can check the time code and the user bit on an external recording/playback device.

Digital Still Camera
DSC-RX0

HDMI Settings: HDMI Resolution

When you connect the product to a High Definition (HD) TV with HDMI terminals using an HDMI cable (sold separately), you can select HDMI Resolution to output images to the TV.

1 MENU →  (Setup) → [HDMI Settings] → [HDMI Resolution] → desired setting.

Menu item details

Auto:

The product automatically recognizes an HD TV and sets the output resolution.

1080p:

Outputs signals in HD picture quality (1080p).

1080i:



Outputs signals in HD picture quality (1080i).



Note

- If the images are not displayed properly using the [Auto] setting, select either [1080i] or [1080p], based on which TV is to be connected.

Digital Still Camera
DSC-RX0

HDMI Settings: 24p/60p Output (movie) (Only for 1080 60i compatible models)

Set 1080/24p or 1080/60p as the HDMI output format when [ Record Setting] is set to [24p 24M(FX)], [24p 17M(FH)], or [24p 50M], or when [ HFR Record Setting] is set to [24p 50M] under [ HFR HFR Settings].

- 1 MENU →  (Setup) → [HDMI Settings] → [HDMI Resolution] → [1080p].
- 2 MENU →  (Setup) → [HDMI Settings] → [ 24p/60p Output] → desired setting.

Menu item details

60p:

Movies are output as 60p.

24p:

Movies are output as 24p.

Note

- Steps 1 and 2 can be set in either order.
- When [ Record Setting] is set to other than [24p 24M(FX)], [24p 17M(FH)], or [24p 50M], this setting is canceled, and HDMI video is output according to the [HDMI Resolution] settings.

Related Topic

- [Record Setting \(movie\)](#)

Digital Still Camera
DSC-RX0

HDMI Settings: HDMI Info. Display

Selects whether to display the shooting information when this product and the TV are connected using an HDMI cable (sold separately).

1 MENU →  (Setup) → [HDMI Settings] → [HDMI Info. Display] → **desired setting.**

Menu item details

On:

Displays the shooting information on the TV. The recorded image and the shooting information are displayed on the TV, while nothing is displayed on the camera's monitor.

Off:

Does not display the shooting information on the TV. Only the recorded image is displayed on the TV, while the recorded image and the shooting information are displayed on the camera's monitor.

Digital Still Camera
DSC-RX0

HDMI Settings: TC Output (movie)

Sets whether or not to layer the TC (time code) information on the output signal via the HDMI terminal when outputting the signal to other professional-use devices.

This function layers the time code information on the HDMI output signal. The product sends the time code information as digital data, not as an image displayed on the screen. The connected device can then refer to the digital data to recognize the time data.

1 MENU →  (Setup) → [HDMI Settings] → [ TC Output] → desired setting.

Menu item details



On:

Time code is output to other devices.

Off:

Time code is not output to other devices.

Note

- When [ TC Output] is set to [On], the image may not be output properly to the TV or recording device. In such cases, set [ TC Output] to [Off].

Digital Still Camera
DSC-RX0

HDMI Settings: REC Control (movie)

If you connect the camera to an external recorder/player, you can remotely command the recorder/player to start/stop recording using the camera.

1 MENU →  (Setup) → [HDMI Settings] → [ REC Control] → desired setting.

Menu item details

On:





 STBY The camera can send a recording command to an external recorder/player.

 REC The camera is sending a recording command to an external recorder/player.

Off:

The camera is not able to send a command to an external recorder/player to start/stop recording.

Note

- Available for external recorders/players compatible with [ REC Control].
- When [ TC Output] is [Off], [ REC Control] is set to [Off].
- Even when  REC is displayed, the external recorder/player may not work properly depending on the settings or status of the recorder/player. Check if the external recorder/player works properly before use.

Digital Still Camera
DSC-RX0

HDMI Settings: CTRL FOR HDMI

When connecting this product to a “BRAVIA” Sync-compatible TV using an HDMI cable (sold separately), you can operate this product by aiming the TV remote control at the TV.

1 MENU →  (Setup) → [HDMI Settings] → [CTRL FOR HDMI] → **desired setting.**

Menu item details

On:

You can operate this product with a TV's remote control.

Off:



You cannot operate this product with a TV's remote control.

Note

- [CTRL FOR HDMI] is available only with a “BRAVIA” Sync-compatible TV.

HDMI 4K Output (movie)

Sets the HDMI output when connecting to recorders that support 4K.

- 1 **MENU** →  (Camera Settings1) → [Shoot Mode] → desired movie recording mode.
- 2 Connect the camera and the device to be connected via an HDMI cable.
- 3 **MENU** →  (Setup) → [ HDMI 4K Output] → desired setting.
- 4 Record the movie output from the camera using the external recording/playback device.

Menu item details

Off:

4K video is not output.

30p/25p:

4K video is output in 30p/25p format.

24p (Only for 1080 60i compatible models):

4K video is output in 24p format.

Note

- You cannot save a 4K movie on a memory card inserted into the camera.
- While 4K video is output, the live-view image does not appear on the camera's monitor. Only icons are displayed.
- This function is only available when the product is connected to a recorder that supports 4K.
- This function is only available in movie recording mode.

Related Topic

- [HDMI Settings: REC Control \(movie\)](#)

Digital Still Camera
DSC-RX0

USB Connection

Selects the appropriate USB connection method for each computer or USB device connected to this product.

1 MENU →  (Setup) → [USB Connection] → desired setting.

Menu item details

Auto:

Establishes a Mass Storage or MTP connection automatically, depending on the computer or other USB devices to be connected. Windows 7, Windows 8.1 or Windows 10 computers are connected in MTP, and their unique functions are enabled for use.

Mass Storage:

Establishes a Mass Storage connection between this product, a computer, and other USB devices.

MTP:

Establishes an MTP connection between this product, a computer, and other USB devices. Windows 7, Windows 8.1 or Windows 10 computers are connected in MTP, and their unique functions are enabled for use.

PC Remote:

Uses “Imaging Edge” to control this product from the computer, including such functions as shooting and storing images on the computer.

Note

- It may take some time to make the connection between this product and a computer when [USB Connection] is set to [Auto].

Related Topic

- [PC Remote Settings: Still Img. Save Dest.](#)
- [PC Remote Settings: RAW+J PC Save Img](#)

Digital Still Camera
DSC-RX0

USB LUN Setting

Enhances compatibility by limiting of USB connection functions.

1 MENU →  (Setup) → [USB LUN Setting] → desired setting.

Menu item details

Multi:

Normally, use [Multi].

Single:

Set [USB LUN Setting] to [Single] only if you cannot make a connection.

Digital Still Camera
DSC-RX0

USB Power Supply

Sets whether to supply power via the micro USB cable when the product is connected to a computer or an USB device.

1 MENU →  (Setup) → [USB Power Supply] → desired setting.

Menu item details

On:

Power is supplied to the product via a micro USB cable when the product is connected to a computer, etc.

Off:

Power is not supplied to the product via a micro USB cable when the product is connected to a computer, etc. If you use the supplied AC Adaptor, power will be supplied even when [Off] is selected.

Digital Still Camera
DSC-RX0

PC Remote Settings: Still Img. Save Dest.

Sets whether to save still images stored in both the camera and the computer during PC Remote shooting. This setting is useful when you want to check recorded images on the camera without leaving the camera.

* PC Remote: Uses "Imaging Edge" to control this product from the computer, including such functions as shooting and storing images on the computer.

1 MENU →  (Setup) → [PC Remote Settings] → [Still Img. Save Dest.] → desired setting.

Menu item details

PC Only:

Saves still images only on the computer.

PC+Camera:

Saves still images on the computer and the camera.

Note

- During PC Remote shooting, you cannot change settings for [Still Img. Save Dest.]. Adjust the settings before you start shooting.
- If you insert a memory card that is not recordable, you cannot shoot still images even if you select [PC+Camera].
- If you select [PC+Camera] and you have not inserted a memory card into the camera, you cannot release the shutter even if [Release w/o Card] is set to [Enable].
- While you are playing back still images on the camera, you cannot shoot using PC Remote.

Related Topic

- [USB Connection](#)
- [Release w/o Card](#)
- [PC Remote Settings: RAW+J PC Save Img](#)

Digital Still Camera
DSC-RX0

PC Remote Settings: RAW+J PC Save Img

Selects the file type for images to be transferred to the computer in PC Remote shooting.

When shooting still images using PC Remote, the application on the computer does not display the image until the image has been completely transferred. When performing RAW+JPEG shooting, you can accelerate the display processing speed by transferring only JPEG images instead of transferring both RAW and JPEG images.

* PC Remote: Uses "Imaging Edge" to control this product from the computer, including such functions as shooting and storing images on the computer.

1 MENU →  (Setup) → [PC Remote Settings] → [RAW+J PC Save Img] → desired setting.

Menu item details

RAW & JPEG:

Transfers both RAW and JPEG files to the computer.

JPEG Only:

Transfers only JPEG files to the computer.

RAW Only:

Transfers only RAW files to the computer.

Note

- [RAW+J PC Save Img] can be set only when [ Quality] is set to [RAW & JPEG].

Related Topic

- [USB Connection](#)
- [Quality \(still image\)](#)
- [PC Remote Settings: Still Img. Save Dest.](#)

Digital Still Camera
DSC-RX0

Language

Selects the language to be used in the menu items, warnings and messages.

1 MENU →  (Setup) → [ Language] → **desired language.**

Digital Still Camera
DSC-RX0

Date/Time Setup

Sets the date and time again.

1 MENU →  (Setup) → [Date/Time Setup] → desired setting.

Menu item details

Daylight Savings:

Selects Daylight Savings [On]/[Off].

Date/Time:

Sets the date and time.

Date Format:

Selects the date and time display format.

Digital Still Camera
DSC-RX0

Area Setting

Sets the area where you are using the product.

1 MENU →  (Setup) → [Area Setting] → desired area.

Copyright Info

You can write copyright information onto the still images.

- 1 **MENU** →  (Setup) → **[Copyright Info]** → desired setting.
- 2 When you select **[Set Photographer]** or **[Set Copyright]**, a keyboard appears on the screen. Enter your desired name.

Menu item details

Write Copyright Info:

Sets whether to write copyright information. ([On]/[Off])

- If you select [On], an  icon will appear on the shooting screen.

Set Photographer:

Sets the photographer name.

Set Copyright:

Sets the copyright holder name.

Disp. Copyright Info:

Displays the current copyright information.

How to use the keyboard

When manual character entry is required, a keyboard is displayed on the screen.



1. Input box

The characters you entered are displayed.





2. Switch character types

Each time you press the  (Enter) button, the character type will switch between alphabet letters, numerals and symbols.

3. Keyboard

Each time you press the  (Enter) button, the characters corresponding to that key will be displayed one-by-one in order.

For example: If you want to enter "abd"

Select the key for "abc" and press the  (Enter) button once to display "a" → select "" ((5) Move cursor) and press the  (Enter) button → select the key for "abc" and press the  (Enter) button twice to display "b" → select the key for "def" and press the  (Enter) button once to display "d".

4. Finalize

Finalizes the entered characters.

5. Move cursor

Moves the cursor in the input box to the right or left.

6. Delete

Deletes the character preceding the cursor.

7. ↑

Switches the next character to a capital or lowercase letter.

8. ␣

Enters a space.

- To cancel input, select [Cancel].

Note

- You can only enter alphanumeric characters and symbols for [Set Photographer] and [Set Copyright]. You can enter up to 46 letters.
- A © icon appears during the playback of images with copyright information.
- In order to prevent unauthorized use of [Copyright Info], be sure to clear the [Set Photographer] and [Set Copyright] columns before lending out or handing over your camera.

Digital Still Camera
DSC-RX0

Format

Formats (initializes) the memory card. When you use a memory card with this product for the first time, it is recommended that you format the card using the product for stable performance of the memory card. Note that formatting permanently erases all data on the memory card, and is unrecoverable. Save valuable data on a computer, etc.

① MENU →  (Setup) → [Format].

Note

- Formatting permanently erases all data including protected images and registered settings (from M1 to M4).

Digital Still Camera
DSC-RX0

File Number

Selects how to assign file numbers to recorded still images and MP4 movies recorded with [ File Format] set to [MP4].

1 MENU →  (Setup) → [File Number] → desired setting.

Menu item details

Series:

The product will assign numbers to files sequentially up to “9000” without resetting.

Reset:

The product resets numbers when a file is recorded in a new folder and assigns numbers to files starting with “0001.” (When the recording folder contains a file, a number one higher than the largest number is assigned.)

Digital Still Camera
DSC-RX0

Set File Name

You can specify the first three characters of the file name for images you shoot.

- 1 MENU →  (Setup) → [Set File Name].
- 2 Select the entry field for the file name to display a keyboard on the screen, and then enter three characters of your choice.

Note

- Only capital letters, numbers, and underscores can be entered. However, an underscore cannot be used as the first character.
- The three characters of the file name you specify using [Set File Name] will only be applied to images you shoot after changing the setting.

Digital Still Camera
DSC-RX0

Select REC Folder

You can change the folder on the memory card where still images and MP4 movies recorded with [ File Format] set to [MP4] are to be recorded.

1 MENU →  (Setup) → [Select REC Folder] → desired folder.

Note

- You cannot select the folder when [Folder Name] is set to [Date Form].

Digital Still Camera
DSC-RX0

New Folder

Creates a new folder on the memory card for recording still images and MP4 movies recorded with [ File Format] set to [MP4]. A new folder is created with a folder number one greater than the largest folder number currently used. Images are recorded in the newly created folder. A folder for still images and a folder for MP4 movies that have the same number are created at the same time.

1 MENU →  (Setup) → [New Folder].

Note

- When you insert a memory card that was used with other equipment into this product and shoot images, a new folder may be automatically created.
- Up to 3,000 images in total can be stored in one folder. When the folder capacity is exceeded, a new folder may be automatically created.

Folder Name

Still images are recorded in a folder that is automatically created inside the DCIM folder on the memory card. You can change the way folder names are assigned.

1 MENU →  (Setup) → [Folder Name] → desired setting.

Menu item details

Standard Form:

The folder name form is as follows: folder number + MSDCF.

Example: 100MSDCF

Date Form:

The folder name form is as follows: folder number + Y (the last digit)/MM/DD.

Example: 10070405 (Folder number: 100, date: 04/05/2017)

Note

- You cannot change the [Folder Name] settings for movies.

Digital Still Camera
DSC-RX0

Recover Image DB

If image files were processed on a computer, problems may occur in the image database file. In such cases, the images on the memory card will not be played back on this product. If these problems happen, repair the file using [Recover Image DB].

1 MENU →  (Setup) → [Recover Image DB] → [Enter].

Note

- Use a sufficiently charged battery pack. Low battery power during repairing can cause damage to data.

Digital Still Camera
DSC-RX0

Display Media Info.

Displays the recordable time of movies and the number of recordable still images for the inserted memory card.

1 MENU →  (Setup) → [Display Media Info.].

Digital Still Camera
DSC-RX0

Version

Displays the version of this product's software.

1 MENU →  (Setup) → [Version].

Digital Still Camera
DSC-RX0

Setting Reset

Resets the product to the default settings. Even if you perform [Setting Reset], the recorded images are retained.

1 MENU →  (Setup) → [Setting Reset] → desired setting.

Menu item details

Camera Settings Reset:

Initializes the main shooting settings to the default settings.

Initialize:

Initializes all the settings to the default settings.

Note

- Be sure not to eject the battery pack while resetting.

Digital Still Camera
DSC-RX0

PlayMemories Mobile

Using the smartphone application PlayMemories Mobile, you can shoot an image while controlling the camera using a smartphone or transfer the images recorded on the camera to the smartphone. Download and install the application PlayMemories Mobile from your smartphone's application store. If PlayMemories Mobile is already installed on your smartphone, be sure to update it to the latest version.

For details on PlayMemories Mobile, refer to the support page (<http://www.sony.net/pmm/>).

Note

- Depending on future version upgrades, the operational procedures or screen displays are subject to change without notice.

Controlling the camera from a smartphone via Wi-Fi (Single connection) (Android)

By connecting a smartphone with the camera via Wi-Fi, you can shoot images while checking the composition or settings on the screen of the smartphone.



1 Install PlayMemories Mobile to your smartphone.

- If PlayMemories Mobile has already been installed, update it to the latest version.

2 MENU →  (Network) → [Ctrl w/ Smartphone] and set as follows.

- [Ctrl w/ Smartphone]: [On]
- [ Connection Type]: [Single]

3 Select [ Connection Info.] under [Ctrl w/ Smartphone].

The QR Code and SSID for a single connection will be displayed.

4 Launch PlayMemories Mobile on your smartphone and select [Scan QR Code of the Camera].



5 Select [OK] on the smartphone screen.

- When a message is displayed, select [OK] again.



6 Scan the QR Code on the monitor of the camera using the smartphone.

Once the QR Code has been scanned, the message [Connect with the camera?] will be displayed on the smartphone screen.

7 Select [OK] on the smartphone screen.

The smartphone will connect to the product.

8 Check the composition of the image on the smartphone's screen, and then press the shutter button (A) on the smartphone to shoot image.

- You can set [Self-Timer] or configure the settings to save images to the smartphone (B).



If you cannot establish a connection using the QR Code

Connect the camera and the smartphone using the SSID and password.

1. Perform Step 1 through Step 3 of the procedure above, and then press the up button on the camera. The camera's SSID and password are displayed on the monitor of the camera.
2. Launch PlayMemories Mobile on your smartphone.
3. Select the model name of the camera (DIRECT-xxxx: xxxx).



4. Input the password that is displayed on the camera.



The smartphone is connected to the camera.

Hint

- Once the QR Code has been read, the camera's SSID (DIRECT-xxxx) and password are registered to the smartphone. This enables you to easily connect the smartphone to the product via Wi-Fi at a later date by selecting the SSID.

Note

- This product shares the connection information for [Ctrl w/ Smartphone] with a device that has permission to connect. If you want to change the device that is permitted to connect to the product, reset the connection information by following these steps. MENU → (Network) → [Wi-Fi Settings] → [SSID/PW Reset]. After resetting the connection information, you must register the smartphone again.
- If you have performed [SSID/PW Reset] or [Edit Device Name] on the camera, you will be unable to establish a Wi-Fi connection by scanning a previously scanned QR Code. In this case, display a new QR Code by selecting [Connection Info.] and rescan it.
- When [Airplane Mode] is set to [On], you cannot connect this product and the smartphone. Set [Airplane Mode] to [Off].
- Live view images may not be displayed smoothly on the screen of the smartphone depending on the surrounding radio wave condition or smartphone performance.
- Depending on future version upgrades, the operational procedures or screen displays are subject to change without notice.

Related Topic



- [PlayMemories Mobile](#)
- [Controlling multiple cameras from a smartphone via Wi-Fi \(Multiple connections\)](#)
- [Controlling multiple cameras from a smartphone via Wi-Fi using an access point \(Multiple connections\)](#)

Controlling the camera from a smartphone via Wi-Fi (Single connection) (iPhone/iPad)

By connecting an iPhone or iPad with the camera via Wi-Fi, you can shoot images while checking the composition or settings on the screen of the iPhone or iPad.



- 1 Install PlayMemories Mobile to your iPhone or iPad.**
 - If PlayMemories Mobile has already been installed, update it to the latest version.

- 2 MENU →  (Network) → [Ctrl w/ Smartphone] and set as follows.**
 - [Ctrl w/ Smartphone]: [On]
 - [ Connection Type]: [Single]

- 3 Select [ Connection Info.] under [Ctrl w/ Smartphone].**

The QR Code and SSID for a single connection will be displayed.

- 4 Launch PlayMemories Mobile on your iPhone or iPad and select [Scan QR Code of the Camera].**



- 5 Select [OK] on the iPhone or iPad screen.**
 - When a message is displayed, select [OK] again.



6 Scan the QR Code on the monitor of the camera using the iPhone or iPad.

7 Install the profile (setting information) by following the instructions shown on the iPhone or iPad screen and select [OK].

The profile will be installed to the iPhone or iPad.

- If you have activated the passcode lock function for your iPhone or iPad, you will need to enter the passcode. Enter the passcode that you set for your iPhone or iPad.



8 Check the SSID displayed on the monitor of the camera.

9 Select [Settings] on the “Home” screen → [Wi-Fi] → the SSID for the camera that was displayed on the iPhone or iPad in Step 8.

The iPhone or iPad will connect to the product.



10 Set the camera to shooting mode.

- 11 Return to the “Home” screen of the iPhone or iPad and launch PlayMemories Mobile.

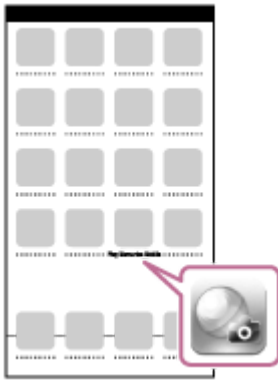

- 12 Check the composition of the image on the iPhone or iPad screen, and then press the shutter button (A) on the iPhone or iPad to shoot an image.

- You can set [Self-Timer] or configure the settings to save images to the iPhone or iPad (B).

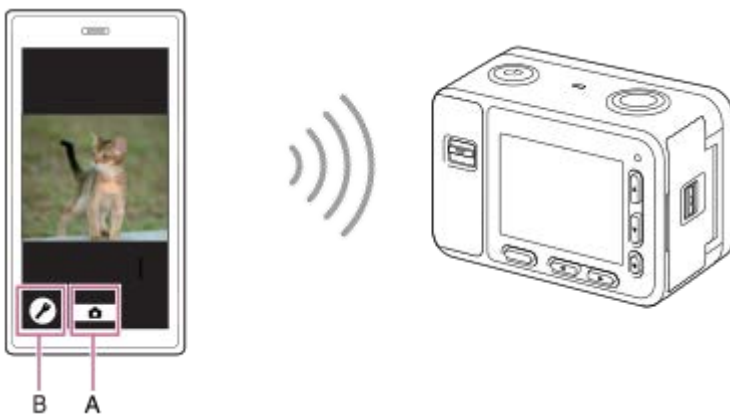

If you cannot establish a connection using the QR Code

Connect the camera and the iPhone or iPad using the SSID and password.

1. Perform Step 1 through Step 3 of the procedure above, and then press the up button on the camera. The camera's SSID and password are displayed on the monitor of the camera.
2. Select the model name of the camera (DIRECT-xxxx: xxxx) on the Wi-Fi setting screen of your iPhone or iPad.



3. Input the password that is displayed on the camera.



The iPhone or iPad is connected to the camera.

4. Confirm that your iPhone or iPad was connected to the “SSID” shown on the camera.



5. Set the camera to shooting mode.

6. Return to the “Home” screen of the iPhone or iPad and launch PlayMemories Mobile.

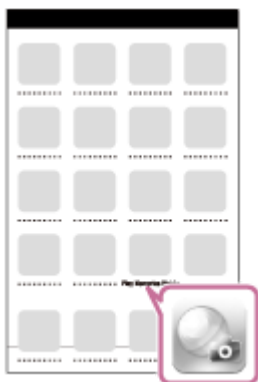

Hint

- Once the QR Code has been read, the camera’s SSID (DIRECT-xxxx) and password are registered to the iPhone or iPad. This enables you to easily connect the iPhone or iPad to the product via Wi-Fi at a later date by selecting the SSID.

Note

- This product shares the connection information for [Ctrl w/ Smartphone] with a device that has permission to connect. If you want to change the device that is permitted to connect to the product, reset the connection information by following these steps. MENU → (Network) → [Wi-Fi Settings] → [SSID/PW Reset]. After resetting the connection information, you must register the iPhone or iPad again.
- If you have performed [SSID/PW Reset] or [Edit Device Name] on the camera, you will be unable to establish a Wi-Fi connection by scanning a previously scanned QR Code. In this case, display a new QR Code by selecting [Connection Info.] and rescan it.
- When [Airplane Mode] is set to [On], you cannot connect this product and the iPhone or iPad. Set [Airplane Mode] to [Off].
- Live-view images may not be displayed smoothly on the screen of the smartphone depending on the surrounding radio-wave conditions and the performance of the iPhone or iPad.

- Depending on future version upgrades, the operational procedures or screen displays are subject to change without notice.

Related Topic

- [PlayMemories Mobile](#)
- [Controlling multiple cameras from a smartphone via Wi-Fi \(Multiple connections\)](#)
- [Controlling multiple cameras from a smartphone via Wi-Fi using an access point \(Multiple connections\)](#)

4-698-613-13(1) Copyright 2017 Sony Corporation

Controlling multiple cameras from a smartphone via Wi-Fi (Multiple connections)

With PlayMemories Mobile, you can use a smartphone to control multiple cameras. You can control up to five cameras simultaneously.

With multiple connections, one of the cameras is set as the “group owner” and connected to the smartphone via Wi-Fi. Each of the other cameras is set as a “client” and connected to the group owner via Wi-Fi. Clients communicate with the smartphone through the group owner.

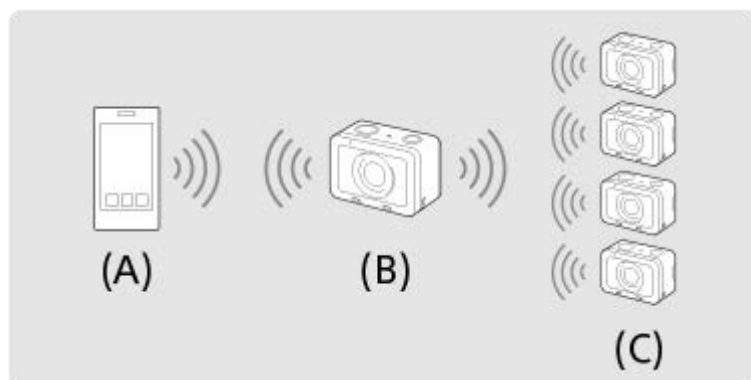

(A): Smartphone
(B): Group owner
(C): Clients

- Only the DSC-RX0 can be connected as the group owner or client.

1 On the camera that you want to connect as the group owner, select **MENU** →  (**Network**) → **[Ctrl w/ Smartphone]** and set as follows.

- **[Ctrl w/ Smartphone]:** [On]
- **[ Connection Type]:** [Multi (Group Owner)]

2 Connect the smartphone and the group owner.

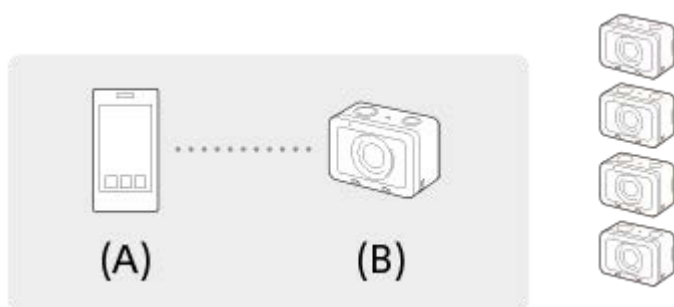

(A): Smartphone
(B): Group owner

Connect the group owner to the smartphone by performing the following procedure.

- 1. On the group owner, select [ Connection Info.] under [Ctrl w/ Smartphone].**
The QR Code and SSID for multiple connections will be displayed.
- 2. Scan the QR Code on the monitor of the group owner with PlayMemories Mobile (installed on your smartphone) to connect.**
Scan the QR Code using the same method as the procedure for a single connection.

- Once the camera is connected as the group owner,  is displayed in white on the shooting screen of the camera.

3 On a camera that you want to connect as a client, select MENU →  (Network) → [Ctrl w/ Smartphone] and set as follows.

- [Ctrl w/ Smartphone]: [On]
- [ Connection Type]: [Multi (Client)]

If the camera has been connected as a client before, the camera will connect to the previous group owner automatically.

If you are connecting the camera as a client for the first time, or if the camera cannot be connected to the previous group owner, you need to set the access point.

Perform the following procedure.

4 Connect the group owner and the client (only for the first time).

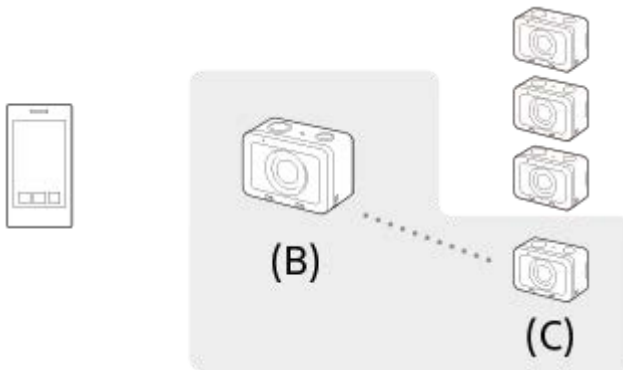



(B): Group owner

(C): Client

Connect the client to the group owner by performing the following procedure.

1. On the client, execute [ WPS Push] from the [Access Point(Client)] screen.

- You can also execute [ WPS Push] on the client by selecting MENU →  (Network) → [Ctrl w/ Smartphone] → [Access Point(Client)] → [OK].

2. On the group owner, select MENU →  (Network) → [Ctrl w/ Smartphone] → [ WPS Push].

- While the MENU screen is displayed, the smartphone and the group owner or client will be disconnected temporarily. The connection will be reestablished automatically when you return to the shooting screen.

3. When the client detects the SSID of the group owner, select [OK].

- Once the camera is connected as a client,  is displayed in white on the shooting screen of the camera.
- If you want to add more clients, repeat steps **3** and **4**.
- When you have finished connecting all the clients, return the group owner to the shooting screen.

Hint

- When establishing multiple connections for the second time or later, you can establish connections with the same settings as the last time by setting the same camera as the group owner. If you want to change the group owner camera, you need to reconnect the smartphone with the group owner and the group owner with the clients.
- By selecting MENU →  (Network) → [Ctrl w/ Smartphone] → [Access Point(Client)] on a client, you can check and change the group owner for multiple connections.
- To control six or more cameras from a smartphone, establish multiple connections using an access point.

Note

- The communication distance depends on the communication environment and devices to be connected.
- Wi-Fi connections are not available under water.
- Live view images may not be displayed smoothly on the screen of the smartphone depending on the surrounding radio wave condition or smartphone performance.
- When [Ctrl w/ Smartphone] is set to [On], the camera's battery is drained more quickly. Set it to [Off] when you are not using the [Ctrl w/ Smartphone] function.
- If you have performed [SSID/PW Reset] or [Edit Device Name] on the group owner, you will be unable to establish a Wi-Fi connection between the group owner and a smartphone or clients that you previously connected with multiple connections. In this case, follow the steps ② to ④ again to reestablish the connections between the smartphone and the group owner, and between the group owner and the clients.
- While you are operating MENU, the Wi-Fi function is temporarily deactivated. Thus, if you operate MENU on the group owner, all of the clients and the smartphone will be disconnected. The connection will be reestablished if you exit MENU within a certain period of time.
- When you set the cameras in place, position them so that the distance between the group owner and the farthest client is as short as possible.

Related Topic

- [PlayMemories Mobile](#)
- [Controlling the camera from a smartphone via Wi-Fi \(Single connection\) \(Android\)](#)
- [Controlling the camera from a smartphone via Wi-Fi \(Single connection\) \(iPhone/iPad\)](#)
- [Controlling multiple cameras from a smartphone via Wi-Fi using an access point \(Multiple connections\)](#)

Digital Still Camera
DSC-RX0

Controlling multiple cameras from a smartphone via Wi-Fi using an access point (Multiple connections)

With PlayMemories Mobile, you can use a smartphone to control multiple cameras. This lets you control even six or more cameras simultaneously. You can control up to 50 cameras.

With multiple connections using an access point, all the cameras are set as “clients” and connected to the access point via Wi-Fi. The cameras communicate with the smartphone through the access point, to which the smartphone is also connected via Wi-Fi.

This function can be used when the camera's system software (firmware) is Ver.2.00 or later.

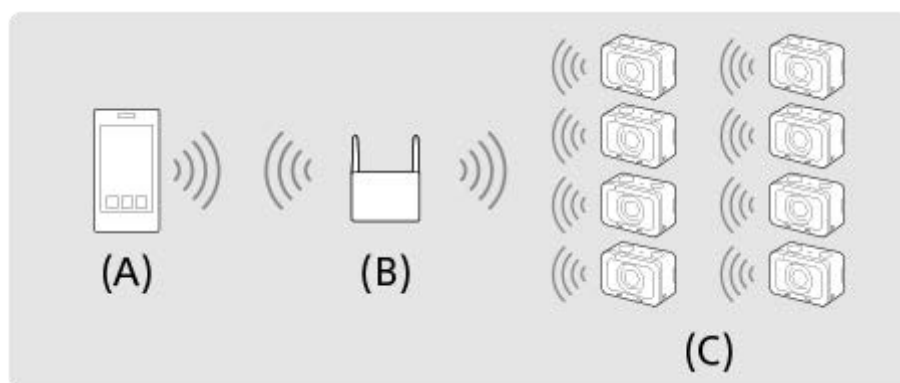

(A): Smartphone

(B): Access point

(C): Cameras (clients)

- Only the DSC-RX0 can be connected as a client.

1 On each camera that you want to connect, select MENU → (Network) → [Ctrl w/ Smartphone] and set as follows.

- [Ctrl w/ Smartphone]: [On]
- [ Connection Type]: [Multi (Client)]

If the camera has been connected to an access point as a client before, the camera will connect to the previous access point automatically.

If you are connecting the camera as a client for the first time, or if the camera cannot be connected to the previous access point, you will need to set the access point.

Perform the following procedure.

2 Connect the camera to the access point (only for the first time).

- You need to set an access point for the smartphone control function separately from the access point for [Send to Computer] or [View on TV].

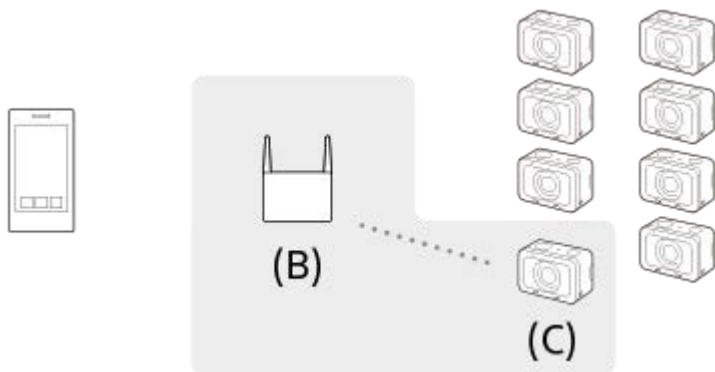



(B): Access point

(C): Camera (client)

Connect the client to the access point by performing the following procedure.

If the access point has a Wi-Fi Protected Setup (WPS) button:



1. On the camera, execute [ WPS Push] from the [Access Point(Client)] screen.

- You can also execute [ WPS Push] by selecting MENU →  (Network) → [Ctrl w/ Smartphone] → [Access Point(Client)] → [OK].

2. Press the WPS button on the access point.

If the access point does not have a Wi-Fi Protected Setup (WPS) button:

1. On the camera, execute [ Access Point Set.] from the [Access Point(Client)] screen.

- You can also execute [ Access Point Set.] by selecting MENU →  (Network) → [Ctrl w/ Smartphone] → [Access Point(Client)] → [OK].

2. Select an access point to connect.

- If the desired access point is not displayed on the screen, select [Manual Setting] and input the SSID of the access point. Then, select the security method.

3. Input the password, and select [OK].



- Access points without the  mark do not require a password.

4. Select [Auto] or [Manual] for [IP Address Setting], and select [OK].

- If you select [Manual], input [IP Address]/[Subnet Mask]/[Default Gateway] according to the network environment.



3 Connect the smartphone to the access point, and launch PlayMemories Mobile on the smartphone.

Hint

- By selecting MENU →  (Network) → [Ctrl w/ Smartphone] → [Access Point(Client)], you can check or change the access point to connect.
- By selecting MENU →  (Network) → [Edit Device Name], you can change the name of the camera displayed on the smartphone. Use this function when you want to distinguish between different cameras.

Note

- The communication distance and the number of the products that can be connected depend on the communication environment and devices to be connected.
- Wi-Fi connections are not available under water.
- Live view images may not be displayed smoothly on the screen of the smartphone depending on the surrounding radio wave condition or smartphone performance.

- When [Ctrl w/ Smartphone] is set to [On], the camera's battery is drained more quickly. Set it to [Off] when you are not using the [Ctrl w/ Smartphone] function.
- [ WPS Push] works only if the security setting of your access point is set to WPA or WPA2 and your access point supports the Wi-Fi Protected Setup (WPS) button method. If the security setting is set to WEP or your access point does not support the Wi-Fi Protected Setup (WPS) button method, perform [ Access Point Set].
- For details about the available functions and settings of your access point, see the access point operating instructions or contact the administrator of the access point.
- A connection may not be possible or the communication distance may be shorter depending on the surrounding conditions, such as the type of wall material and the presence of obstructions or radio waves between the product and access point. In this case, change the location of the product or move the product closer to the access point.

Related Topic

- [PlayMemories Mobile](#)
- [Controlling the camera from a smartphone via Wi-Fi \(Single connection\) \(Android\)](#)
- [Controlling the camera from a smartphone via Wi-Fi \(Single connection\) \(iPhone/iPad\)](#)
- [Controlling multiple cameras from a smartphone via Wi-Fi \(Multiple connections\)](#)
- [Edit Device Name](#)
- [Version](#)

Digital Still Camera
DSC-RX0

Turning the camera on/off from a smartphone using the Bluetooth function

You can turn the camera on or off by operating a smartphone connected to the camera via the Bluetooth function. You can connect multiple cameras to a smartphone simultaneously. Unlike with multiple connections via Wi-Fi, multiple cameras are connected to the smartphone directly.

Supported smartphones

- Android smartphones: Android 5.0 or later and compatible with Bluetooth 4.0 or later*
- iPhone/iPad: iPhone 4S or later/iPad 3rd generation or later

* As of September 2017. For the latest information, refer to the support site.

* For the Bluetooth version, refer to the website for your smartphone.



Preparation in advance

Perform the following steps in advance.

1. Install PlayMemories Mobile on your smartphone.
2. Add the [Camera Remote Power ON/OFF] function to PlayMemories Mobile.
Connect the smartphone and the camera via Wi-Fi.
Once you have connected the camera via Wi-Fi, the [Camera Remote Power ON/OFF] function is added to PlayMemories Mobile. You do not need to connect via Wi-Fi after the first time.

Bluetooth connection (Pairing)

The camera and the smartphone need to be connected via Bluetooth communication (pairing). This procedure is only required once.

1. Make sure that the camera's Bluetooth function is turned on.
 - You do not need to perform the pairing operation with the Bluetooth function at this point.
2. On the camera, select MENU →  (Network) → [Bluetooth Settings] → [Bluetooth Function] → [On].
 - Also make sure that [ Remote Power Set.] is set to [On] on the camera.
3. On the camera, select MENU →  (Network) → [Bluetooth Settings] → [Pairing].
 - The device name of the camera "DSC-RX0" will be displayed on the monitor of the camera.
 - When a Bluetooth connection has already been established, the model name of the connected smartphone will be displayed.
4. Launch PlayMemories Mobile on your smartphone and select [Camera Remote Power ON/OFF].
 - The message [Scanning...] and a list of devices that can be connected will appear.
 - Perform the procedure under "Preparation in advance" if [Camera Remote Power ON/OFF] does not appear.
5. Select [Pairing] to the right of "DSC-RX0" in the list on the smartphone.
6. Select [OK] on the pairing confirmation screen on the camera.
7. Select [Pairing] on the pairing confirmation screen on the smartphone.

8. Select [OK] on the Bluetooth connection completion screen on the camera.



- The camera will return to [Bluetooth Settings] screen.

Turning the camera on/off from a smartphone

Once Step 8 under “Bluetooth connection (Pairing)” is complete, you can turn the camera on or off from the smartphone by following the steps below.

1. Launch PlayMemories Mobile on your smartphone and select [Camera Remote Power ON/OFF].

2. Select the  (power) mark to the right of “DSC-RX0” in the list on the smartphone.

- If the camera is off, it will turn on and the  (power) mark will turn green.
- If the camera is on, it will turn off and the  (power) mark will turn white.

Hint

- The number of device names displayed on the smartphone corresponds to the number of cameras connected using the Bluetooth function. Select the device name of the camera that you want to turn on/off.

Note

- When you initialize the camera, the pairing information is also deleted. To perform pairing again, delete the pairing information from the smartphone, and then perform the procedure under “Bluetooth connection (Pairing).”
- If the Bluetooth connection is unstable, remove any obstacles, such as people or metal objects from between the camera and the paired smartphone.
- The Bluetooth function is not available under water.
- When [Bluetooth Function] is set to [On], the camera’s battery will drain gradually even if the camera is turned off. Set [Bluetooth Function] to [Off] when you are not using the Bluetooth function.
- Depending on the environment of use, the communication distances for the Bluetooth function and the Wi-Fi function may vary.

Related Topic

- [PlayMemories Mobile](#)
- [Bluetooth Settings](#)
- [Remote Power Set.](#)
- [Edit Device Name](#)

Digital Still Camera
DSC-RX0

Send to Smartphone

You can transfer still images/movies to a smartphone and view them. The application PlayMemories Mobile must be installed on your smartphone.

1 MENU →  (Network) → [Send to Smartphone] → desired setting.

2 Connect the smartphone to the camera using the SSID and password displayed on the monitor of the camera.

- The setting method for connecting the smartphone and the product varies depending on the smartphone.



The images will be transferred to the smartphone and saved to Gallery/Albums on an Android, or Albums on an iPhone or iPad.

Menu item details

Select on This Device:

Selects an image on the product to be transferred to the smartphone.

(1) Select from among [This Image], [All Images on This Date] or [Multiple Images].

- The options displayed may differ depending on the View Mode selected on the camera.

(2) If you select [Multiple Images], select the desired images using  (Enter) button, then press MENU → [Enter].

Select on Smartphone:

Displays all images recorded on the product's memory card on the smartphone.

Note

- You can only transfer images that are saved on the camera's memory card.
- You can select an image size to be sent to the smartphone from [Original], [2M] or [VGA]. To change the image size, refer to the following steps.
 - For Android smartphone
Start PlayMemories Mobile, and change the image size by [Settings] → [Copy Image Size].
 - For iPhone/iPad
Select PlayMemories Mobile in the setting menu, and change the image size by [Copy Image Size].
- Some images may not be displayed on the smartphone depending on the recording format.
- RAW images are converted to JPEG format when they are sent.
- You cannot send XAVC S or AVCHD format movies.
- This product shares the connection information for [Send to Smartphone] with a device that has permission to connect. If you want to change the device that is permitted to connect to the product, reset the connection information by following these steps.

MENU →  (Network) → [SSID/PW Reset]. After resetting the connection information, you must register the smartphone again.

- When [Airplane Mode] is set to [On], you cannot connect this product and the smartphone. Set [Airplane Mode] to [Off].

Related Topic

- [PlayMemories Mobile](#)
- [Airplane Mode](#)

4-698-613-13(1) Copyright 2017 Sony Corporation

Digital Still Camera
DSC-RX0

Send to Computer

You can transfer images stored in the product to a computer connected to a wireless access point or wireless broadband router and easily make backup copies using this operation. Before starting this operation, install PlayMemories Home on your computer and register the access point on the product.

1 Start your computer.

2 MENU →  **(Network)** → **[Send to Computer]**.

Note

- Depending on the application settings of your computer, the product will turn off after saving the images to your computer.
- You can transfer images from the product to only one computer at a time.
- If you want to transfer images to another computer, connect the product and the computer via a USB connection and follow the instructions in PlayMemories Home.

Related Topic

- [Installing PlayMemories Home](#)
- [Wi-Fi Settings: WPS Push](#)
- [Wi-Fi Settings: Access Point Set.](#)

View on TV

You can view images on a network-enabled TV by transferring them from the product without connecting the product and TV with a cable. For some TVs, you may need to perform operations on the TV. For details, refer to the operating instructions supplied with the TV.

- 1 **MENU** →  (**Wireless**) → **[View on TV]** → **desired device to be connected.**
- 2 **When you want to play back images using slideshow, press  (Enter) button.**

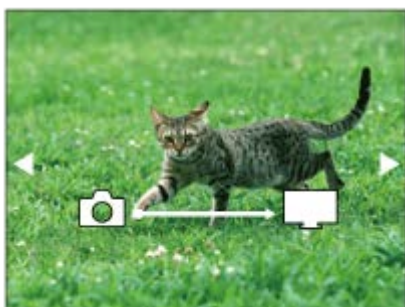

- To display the next/previous image manually, press the right/left button.
- To change the device to be connected, press the down button, then select [Device list].

Slideshow settings

You can change the slideshow settings by pressing the down button.

Playback Selection:

Selects the group of images to be shown.

Folder View(Still):

Selects from [All] and [All in Folder].

Date View:

Selects from [All] and [All in Date Rng.].

Interval:

Selects from [Short] and [Long].

Effects*:

Select from [On] and [Off].

Playback Image Size:

Select from [HD] and [4K].

* The settings are effective only for BRAVIA TV which is compatible with the functions.

Note

- You can use this function on a TV that supports DLNA renderer.
- You can view images on a Wi-Fi Direct-enabled TV or network-enabled TV (including wired network-enabled TVs).
- If you connect TV and this product and do not use Wi-Fi Direct, you need to register your access point first.
- Displaying the images on the TV may take time.
- Movies cannot be shown on a TV via Wi-Fi. Use an HDMI cable (sold separately).

Related Topic

- [Wi-Fi Settings: WPS Push](#)
- [Wi-Fi Settings: Access Point Set.](#)

4-698-613-13(1) Copyright 2017 Sony Corporation

Digital Still Camera
DSC-RX0

Ctrl w/ Smartphone

By connecting the camera to a smartphone using Wi-Fi, you can control the camera and shoot images using the smartphone, and you can transfer images shot with the camera to the smartphone.

1 MENU →  (Network) → [Ctrl w/ Smartphone] → desired setting.

Menu item details

Ctrl w/ Smartphone:

Sets whether to connect the camera and a smartphone using Wi-Fi. ([On]/[Off])

Connection Type:

Sets the connection method for Wi-Fi connections between the camera and a smartphone. ([Single]/[Multi (Group Owner)]/[Multi (Client)])

Connection Info.:

Displays the SSID and the password used to connect the camera to a smartphone.

WPS Push:

Enables the camera to connect with a client when the camera is set as the group owner for multiple connections.

Access Point(Client):

Displays and changes the group owner or the access point when the camera is set as a client for multiple connections.

Related Topic

- [Controlling the camera from a smartphone via Wi-Fi \(Single connection\) \(Android\)](#)
- [Controlling the camera from a smartphone via Wi-Fi \(Single connection\) \(iPhone/iPad\)](#)
- [Controlling multiple cameras from a smartphone via Wi-Fi \(Multiple connections\)](#)
- [Controlling multiple cameras from a smartphone via Wi-Fi using an access point \(Multiple connections\)](#)
- [Send to Smartphone](#)

Digital Still Camera
DSC-RX0

Airplane Mode

When you board an airplane, etc., you can temporarily disable all the wireless-related functions including Wi-Fi.

1 MENU →  (Network) → [Airplane Mode] → **desired setting.**

If you set [Airplane Mode] to [On], an airplane mark will be displayed on the screen.

Wi-Fi Settings: WPS Push

If your access point has the Wi-Fi Protected Setup (WPS) button, you can register the access point to this product easily by pushing the Wi-Fi Protected Setup (WPS) button.

- 1 MENU →  (Network) → [Wi-Fi Settings] → [WPS Push].
- 2 Press the WPS button on the access point you want to register.

Note

- [WPS Push] works only if the security setting of your access point is set to WPA or WPA2 and your access point supports the Wi-Fi Protected Setup (WPS) button method. If the security setting is set to WEP or your access point does not support the Wi-Fi Protected Setup (WPS) button method, perform [Access Point Set].
- For details about the available functions and settings of your access point, see the access point operating instructions or contact the administrator of the access point.
- A connection may not be possible or the communication distance may be shorter depending on the surrounding conditions, such as the type of wall material and the presence of obstructions or radio waves between the product and access point. In this case, change the location of the product or move the product closer to the access point.
- Select MENU →  (Network) → [Ctrl w/ Smartphone] → [Access Point(Client)] to set an access point for multiple connections in which cameras are controlled from a smartphone.

Related Topic

- [Wi-Fi Settings: Access Point Set.](#)
- [Controlling multiple cameras from a smartphone via Wi-Fi using an access point \(Multiple connections\)](#)

Wi-Fi Settings: Access Point Set.

You can register your access point manually. Before starting the procedure, check the SSID name of the access point, security system, and password. The password may be preset in some devices. For details, see the access point operating instructions, or consult the access point administrator.

1 MENU →  (Network) → [Wi-Fi Settings] → [Access Point Set.].

2 Select the access point you want to register.

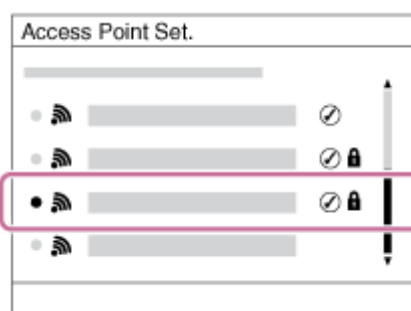

When the desired access point is displayed on the screen: Select the desired access point.

When the desired access point is not displayed on the screen: Select [Manual Setting] and set the access point.

* For the input method, refer to "How to use the keyboard."

- If you select [Manual Setting], input the SSID name of the access point, then select the security system.

3 Input the password, and select [OK].

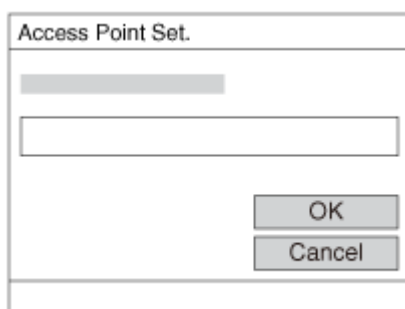

- Access points without the  mark do not require a password.

4 Select [OK].

How to use the keyboard

When manual character entry is required, a keyboard is displayed on the screen.



1. Input box

The characters you entered are displayed.





2. Switch character types

Each time you press  (Enter) button, the character type will switch between alphabet letters, numerals and symbols.

3. Keyboard

Each time you press  (Enter) button, the characters corresponding to that key will be displayed one-by-one in order.

For example: If you want to enter “abd”

Select the key for “abc” and press  (Enter) button once to display “a” → select “”((5) Move cursor) and press  (Enter) button → select the key for “abc” and press  (Enter) button twice to display “b” → select the key for “def” and press  (Enter) button once to display “d”.

4. Finalize

Finalizes the entered characters.

5. Move cursor

Moves the cursor in the input box to the right or left.

6. Delete

Deletes the character preceding the cursor.

7.

Switches the next character to a capital or lowercase letter.

8.

Enters a space.

- To cancel input, select [Cancel].

Other setting items

Depending on the status or the setting method of your access point, you may want to set more items.

WPS PIN:

Displays the PIN code you enter into the connected device.

Priority Connection:

Select [On] or [Off].

IP Address Setting:

Select [Auto] or [Manual].

IP Address:

If you are entering the IP address manually, enter the set address.

Subnet Mask/Default Gateway:

If you have set [IP Address Setting] to [Manual], enter each address according to your network environment.

Note

- To give the registered access point priority, set [Priority Connection] to [On].
- Select MENU →  (Network) → [Ctrl w/ Smartphone] → [Access Point(Client)] to set an access point for multiple connections in which cameras are controlled from a smartphone.

Related Topic

- [Wi-Fi Settings: WPS Push](#)
- [Controlling multiple cameras from a smartphone via Wi-Fi using an access point \(Multiple connections\)](#)

4-698-613-13(1) Copyright 2017 Sony Corporation

Digital Still Camera
DSC-RX0

Wi-Fi Settings: Disp MAC Address

Displays the MAC address of this product.

1 MENU →  (Network) → [Wi-Fi Settings] → [Disp MAC Address].

Digital Still Camera
DSC-RX0

Wi-Fi Settings: SSID/PW Reset

This product shares the connection information for [Send to Smartphone] and [Ctrl w/ Smartphone] with a device that has permission to connect. If you want to change the device that is permitted to connect, reset the connection information.

1 MENU →  (Network) → [Wi-Fi Settings] → [SSID/PW Reset] → [OK].

Note

- If you connect this product to the smartphone after resetting the connection information, you must register the smartphone again.

Related Topic

- [Send to Smartphone](#)
- [Ctrl w/ Smartphone](#)

Digital Still Camera
DSC-RX0

Bluetooth Settings

Controls the settings for connecting the camera to a smartphone via a Bluetooth connection. You need to pair the camera and smartphone before using the function to turn the camera on/off from a smartphone.

For details on the pairing procedure, refer to “Turning the camera on/off from a smartphone using the Bluetooth function.”

① MENU →  (Network) → [Bluetooth Settings] → desired setting.

Menu item details

Bluetooth Function (On/Off):

Sets whether to activate or not the Bluetooth function of the camera.

Pairing:

Displays the screen for pairing the camera and smartphone using PlayMemories Mobile.

Disp Device Address:

Displays the BD address of the camera.

Related Topic

- [Turning the camera on/off from a smartphone using the Bluetooth function](#)
- [Remote Power Set.](#)

Digital Still Camera
DSC-RX0

Remote Power Set.

Sets the function to turn the camera on/off from a smartphone connected via the Bluetooth function.

1 MENU →  (Network) → [ Remote Power Set.] → desired setting.

Menu item details

Off:

Deactivates the function to turn the camera on/off from a smartphone via the Bluetooth function.

On:

Activates the function to turn the camera on/off from a smartphone via the Bluetooth function.

Related Topic

- [Turning the camera on/off from a smartphone using the Bluetooth function](#)
- [Bluetooth Settings](#)

Digital Still Camera
DSC-RX0

Edit Device Name

You can change the device name under Wi-Fi Direct.

- 1 **MENU** →  **(Network)** → **[Edit Device Name]**.
- 2 **Select the input box, then input the device name** → **[OK]**.
 - For input method, refer to [“How to use the keyboard.”](#)

Related Topic

- [Wi-Fi Settings: WPS Push](#)
- [Wi-Fi Settings: Access Point Set.](#)

Digital Still Camera
DSC-RX0

Reset Network Set.

Resets all the network settings to default settings.

1 MENU →  (Network) → [Reset Network Set.] → [Enter].

Digital Still Camera
DSC-RX0

Recommended computer environment

You can confirm the operating computer environment of the software from the following URL:

<http://www.sony.net/pcenv/>

Digital Still Camera
DSC-RX0

PlayMemories Home

With PlayMemories Home, you can do the following:

- You can import images shot with this product to your computer.
- You can play back the images imported to your computer.
- You can share your images using PlayMemories Online.
- You can edit movies such as by cutting or merging.
- You can add various effects such as BGM and subtitles to movies.
- You can change the playback speed of movies and slow-motion movies.

Also for Windows, you can do the following:

- You can organize images on the computer on a calendar by shooting date to view them.
- You can edit and correct images, such as by trimming and resizing.
- You can create a disc from movies imported to a computer. Blu-ray discs or AVCHD discs can be created from XAVC S-format movies.
- You can upload images to a network service. (An internet connection is required.)
- For other details, please refer to the Help of PlayMemories Home.

Installing PlayMemories Home

- 1 Using your computer's Internet browser, go to the URL below and download PlayMemories Home by following the on-screen instructions.

<http://www.sony.net/pm/>

- An internet connection is required.
- For detailed instructions, visit the PlayMemories Home support page.

<http://www.sony.co.jp/pmh-se/>

- 2 Connect the product to your computer using the micro USB cable (supplied), then turn the product on.

- New functions may be added to PlayMemories Home. Even if PlayMemories Home has already been installed on your computer, connect this product and your computer again.
- Do not remove the micro USB cable (supplied) from the camera while the camera is in operation or the access screen is displayed. Doing so may damage the data.

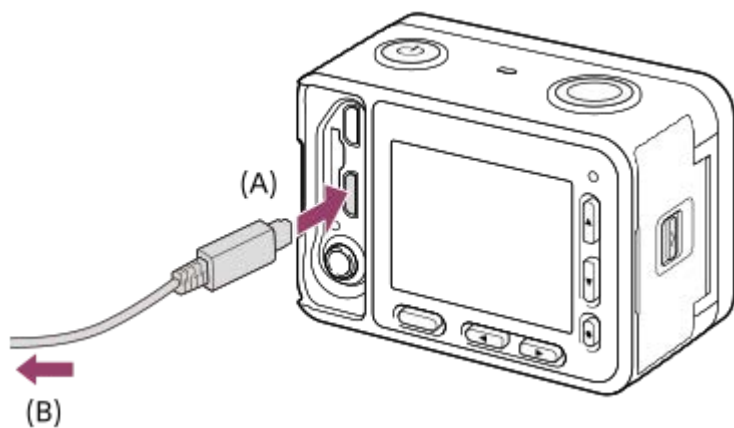

A: To the Multi/Micro USB Terminal

B: To the USB jack of the computer

Note

- Log on as Administrator.
- It may be necessary to restart your computer. When the restart confirmation message appears, restart the computer following the instructions on the screen.
- DirectX may be installed depending on your computer's system environment.

Hint

- For details on PlayMemories Home, refer to the Help of PlayMemories Home or the PlayMemories Home support page (<http://www.sony.co.jp/pmh-se/>) (English only).

Digital Still Camera
DSC-RX0

Software for Mac computers

For details on software for Mac computers, access the following URL:

<http://www.sony.co.jp/imsoft/Mac/>

Note

- The software that can be used varies depending on the region.

Related Topic

- [Send to Computer](#)

Digital Still Camera
DSC-RX0

Imaging Edge

Imaging Edge is a software suite that includes functions such as remote shooting from a computer, and adjusting or developing RAW images recorded with the camera.

Viewer:

You can display and search images.

Edit:

You can edit images with various corrections such as tone curve and sharpness, and develop images recorded in RAW format.

Remote:

You can adjust the camera settings or shoot images from a computer connected to the camera with a USB cable. To control the camera using a computer, select MENU →  (Setup) → [USB Connection] → [PC Remote] before connecting the camera to the computer with a USB cable.

For details on how to use Imaging Edge, refer to the support page.

<http://www.sony.net/disoft/help/>

Installing Imaging Edge on your computer

Download and install the software by accessing the following URL:

<http://www.sony.net/disoft/d/>

Related Topic

- [USB Connection](#)

Connecting the product to a computer

- 1 Insert a sufficiently charged battery pack into the product.
- 2 Turn on the product and the computer.
- 3 Check that [USB Connection] under  (Setup) is set to [Mass Storage].
- 4 Connect the product and your computer using the micro USB cable (supplied) (A) .

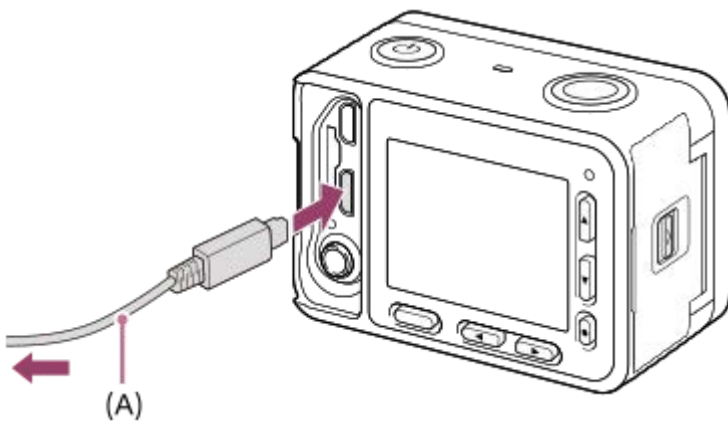

- If you connect the product to your computer using the micro USB cable when [USB Power Supply] is set to [On], power is supplied from your computer. (Default setting: [On])

Related Topic

- [USB Connection](#)
- [USB LUN Setting](#)

Importing images to the computer

PlayMemories Home allows you to easily import images. For details on PlayMemories Home functions, see the Help of PlayMemories Home.

Importing images to the computer without using PlayMemories Home (For Windows)

When the AutoPlay Wizard appears after making a USB connection between this product and a computer, click [Open folder to view files] → [OK] → [DCIM] or [MP_ROOT]. Then copy the desired images to the computer.

Importing images to the computer without using PlayMemories Home (For Mac)

Connect the product to your Mac computer. Double-click the newly recognized icon on the desktop → the folder in which the image you want to import is stored. Then drag and drop the image file on to the hard disk icon.

Note

- For operations such as importing XAVC S movies or AVCHD movies to the computer, use PlayMemories Home.
- Do not edit or otherwise process AVCHD movie files/folders from the connected computer. Movie files may be damaged or become unplayable. Do not delete or copy AVCHD movies on the memory card from the computer. Sony is not held liable for consequences resulting from such operations via the computer.

Digital Still Camera
DSC-RX0

Disconnecting the product from the computer

Disconnects the USB connection between this product and the computer.

Perform the procedures from step 1 to 2 below before performing the following operations:

- Disconnecting the USB cable.
- Removing a memory card.
- Turning off the product.

1 Click  (Safely remove USB Mass Storage Device) on the taskbar.

2 Click the displayed message.

Note

- For Mac computers, drag and drop the icon of the memory card or the drive icon in the “Trash” icon. The product is disconnected from the computer.
- For Windows 7/Windows 8 computers, the disconnect icon may not appear. In that case, you can skip steps 1 and 2 above.
- Do not remove a micro USB cable from this product while the access lamp is illuminated. The data may be damaged.

Digital Still Camera
DSC-RX0

Selecting a disc to be created

You can create a disc that can be played back on other devices from a movie recorded on this camera. What devices can play back the disc depends on the disc type. Select a disc type suitable for the playback devices you will be using.

Depending on the movie type, the movie format may be converted when creating a disc.



High-definition image quality (HD) (Blu-ray Disc)

High-definition image quality (HD) movies can be recorded on a Blu-ray Disc, creating a high-definition image quality (HD) disc. A Blu-ray Disc enables you to record longer-duration high-definition image quality (HD) movies than DVD discs.

Writable movie formats: XAVC S, AVCHD, MP4 (AVC)

Players: Blu-ray Disc playback devices (Sony Blu-ray Disc players, PlayStation 3, etc.)



High-definition image quality (HD) (AVCHD recording disc)

High-definition image quality (HD) movies can be recorded on DVD media such as DVD-R discs, creating a high-definition image quality (HD) disc.

Writable movie formats: XAVC S, AVCHD, MP4 (AVC)

Players: AVCHD format playback devices (Sony Blu-ray Disc players, PlayStation 3, etc.)

You cannot play these kinds of discs on ordinary DVD players.



Standard definition image quality (STD)

Standard definition image quality (STD) movies converted from high-definition image quality (HD) movies can be recorded on DVD media such as DVD-R discs, creating a standard image quality (STD) disc.

Writable movie format: AVCHD

Players: Ordinary DVD playback devices (DVD players, computers that can play back DVD discs, etc.)

Hint

- You can use the following types of 12 cm discs with PlayMemories Home.
BD-R/DVD-R/DVD+R/DVD+R DL: Non-rewritable
BD-RE/DVD-RW/DVD+RW: Rewritable
Additional recording is not possible.
- Always maintain your "PlayStation 3" to use the latest version of the "PlayStation 3" system software.

Related Topic

- [Creating Blu-ray Discs from high-definition image quality movies](#)
- [Creating DVD discs \(AVCHD recording discs\) from high-definition image quality movies](#)
- [Creating DVD discs from standard image quality movies](#)



Digital Still Camera
DSC-RX0

Creating Blu-ray Discs from high-definition image quality movies

You can create Blu-ray Discs that can be played back on Blu-ray Disc playback devices (such as Sony Blu-ray Disc players or the PlayStation 3, etc.).

A. How to create using a computer

With a Windows computer, you can copy movies imported to the computer and create Blu-ray Discs using PlayMemories Home.

Your computer must be able to create Blu-ray Discs.

When you create a Blu-ray Disc for the first time, connect your camera to the computer using a USB cable. The necessary software is automatically added to your computer. (An internet connection is needed.)

For details on how to create a disc using PlayMemories Home, refer to the Help guide for PlayMemories Home.

B. How to create using a device other than a computer

You can also create Blu-ray Discs using a Blu-ray recorder, etc.

For details, refer to the device's operating instructions.

Note

- When creating Blu-ray discs using PlayMemories Home from movies recorded in the XAVC S or MP4 movie formats, the image quality is converted to 1920×1080 (60i/50i) and it is not possible to create discs with the original image quality. To record movies with the original image quality, copy movies to a computer or an external medium.
- To create a Blu-ray Disc from movies recorded in the AVCHD movie format with [ Record Setting] set to [60p 28M(PS)]/[50p 28M(PS)], you need to use a device that is compliant with AVCHD format Ver. 2.0. The created Blu-ray Disc can be played back only on a device that is compliant with AVCHD format Ver. 2.0.

Related Topic

- [Selecting a disc to be created](#)
- [Creating DVD discs \(AVCHD recording discs\) from high-definition image quality movies](#)
- [Creating DVD discs from standard image quality movies](#)

Digital Still Camera
DSC-RX0

Creating DVD discs (AVCHD recording discs) from high-definition image quality movies

You can create DVD discs (AVCHD recording discs) that can be played back on AVCHD-compatible playback devices (such as Sony Blu-ray Disc players or the PlayStation 3, etc.).

A. How to create using a computer

With a Windows computer, you can copy movies imported to the computer and create DVD discs (AVCHD recording discs) using PlayMemories Home.

Your computer must be able to create DVD discs (AVCHD recording discs).

When you create a DVD disc for the first time, connect your camera to the computer using a USB cable. The necessary software is automatically added to your computer. (An internet connection is needed.)

For details on how to create a disc using PlayMemories Home, refer to the Help guide for PlayMemories Home.

B. How to create using a device other than a computer

You can also create DVD discs (AVCHD recording discs) using a Blu-ray recorder, etc.

For details, refer to the device's operating instructions.

Note

- When creating DVD discs (AVCHD recording discs) using PlayMemories Home from movies recorded in the XAVC S or MP4 movie formats, the image quality is converted to 1920×1080 (60i/50i) and it is not possible to create discs with the original image quality. To record movies with the original image quality, copy movies to a computer or an external medium.
- When creating AVCHD recording discs using PlayMemories Home from movies recorded in the AVCHD movie format with [Record Setting] set to [60p 28M(PS)]/[50p 28M(PS)], [60i 24M(FX)]/[50i 24M(FX)] or [24p 24M(FX)]/[25p 24M(FX)], the image quality is converted and it is not possible to create discs with the original image quality. Converting the image quality takes time. To record movies with the original image quality, use a Blu-ray Disc.

Related Topic

- [Selecting a disc to be created](#)
- [Creating Blu-ray Discs from high-definition image quality movies](#)
- [Creating DVD discs from standard image quality movies](#)

Digital Still Camera
DSC-RX0

Creating DVD discs from standard image quality movies

You can create DVD discs that can be played back on ordinary DVD playback devices (DVD players, computers that can play back DVD discs, etc.).

A. How to create using a computer

With a Windows computer, you can copy movies imported to the computer and create DVD disc using PlayMemories Home.

Your computer must be able to create DVD discs.

When you create a DVD disc for the first time, connect your camera to the computer using a USB cable. Install the dedicated add-on software following the on-screen instructions. (An internet connection is needed.)

For details on how to create a disc using PlayMemories Home, refer to the Help for PlayMemories Home.

B. How to create using a device other than a computer

You can also create DVD discs using a Blu-ray recorder, HDD recorder, etc. For details, refer to the device's operating instructions.

Related Topic

- [Selecting a disc to be created](#)
- [Creating Blu-ray Discs from high-definition image quality movies](#)
- [Creating DVD discs \(AVCHD recording discs\) from high-definition image quality movies](#)

Digital Still Camera
DSC-RX0

Camera control boxes

Using CCB-WD1 camera control boxes (sold separately) allows you to perform the following operations from a web browser on the computer.

- Shooting images simultaneously with multiple cameras
- Applying camera settings to multiple cameras at once

For details on shooting with camera control boxes, refer to the instruction manual for the camera control box. This function can be used when the camera's system software (firmware) is Ver.2.00 or later.

Hint

- It is recommended that you set MENU →  (Setup) → [Auto Pwr OFF Temp.] to [High] if you will be using cameras mounted in place for a long period of time when shooting with camera control boxes.

Note

- Set MENU →  (Setup) → [USB Connection] to [PC Remote] when using camera control boxes.

Related Topic

- [Version](#)

Digital Still Camera
DSC-RX0

Precautions

Backing up memory cards

Data may be corrupted in the following cases. Be sure to back up the data for protection.

- When the memory card is removed, the USB cable is disconnected, or the product is turned off in the middle of a read or write operation.
- When the memory card is used in locations subject to static electricity or electrical noise.

Creating an image database file

If you insert a memory card that does not contain an image database file into the product and turn on the power, the product automatically creates an image database file using some of the memory card's capacity. The process may take a long time and you cannot operate the product until the process is completed.

If a database file error occurs, export all images to your computer using PlayMemories Home, and then format the memory card using this product.

Do not use/store the product in the following places

- In an extremely hot, cold or humid place
In places such as in a car parked in the sun, the camera body may become deformed and this may cause a malfunction.
- Storing under direct sunlight or near a heater
The camera body may become discolored or deformed, and this may cause a malfunction.
- In a location subject to rocking vibration
- Near strong magnetic place

On carrying

Do not sit down in a chair or other place with the product in the back pocket of your trousers or skirt, as this may cause a malfunction or damage the product.

Precaution on carrying

Do not carry the camera with the tripod attached. This may cause the tripod socket hole to break.

On operating temperatures

Your product is designed for use under the temperatures between 0°C and 40 °C (32 °F and 104 °F). Shooting in extremely cold or hot places that exceed this range is not recommended.

Notes on recording for long periods of time

- Depending on the camera and battery temperature, you may be unable to record movies or the power may turn off automatically to protect the camera. A message will be displayed on the screen before the power turns off or you can no longer record movies. In this case, leave the power off and wait until the camera and battery temperature goes down. If you turn on the power without letting the camera and battery cool enough, the power may turn off again or you may be unable to record movies.
- Under high ambient temperatures, the temperature of the camera rises quickly.
- When the temperature of the camera rises, the image quality may deteriorate. It is recommended that you wait until the temperature of the camera drops before continuing to shoot.
- The surface of the camera may get warm. This is not a malfunction.

- If the same part of your skin touches the camera for a long period of time while using the camera, even if the camera does not feel hot to you, it may cause symptoms of a low-temperature burn such as redness or blistering. Pay special attention in the following situations and use a tripod, etc.
 - When using the camera in a high-temperature environment
 - When someone with poor circulation or impaired skin sensation uses the camera
 - When using the camera with the [Auto Pwr OFF Temp.] set to [High]

On moisture condensation

- If the product is brought directly from a cold to a warm location, moisture may condense inside or outside the product. This moisture condensation may cause a malfunction of the product.
- To prevent moisture condensation when you bring the product directly from a cold to a warm location, first put it in a plastic bag and seal it to prevent air from entering. Wait for about an hour until the temperature of the product has reached the ambient temperature.
- If moisture condensation occurs, turn off the product and wait about an hour for the moisture to evaporate. Note that if you attempt to shoot with moisture remaining inside the lens, you will be unable to record clear images.

On the functions available with the product

- This camera is compatible with 1080 60p or 1080 50p-format movies. Unlike traditional standard recording modes, which record using an interlacing method, this product records movies using a progressive method. This increases the resolution, and provides a smoother, more realistic image.

Notes for when on board an airplane

- In an airplane, set [Airplane Mode] to [On].

On image data compatibility

This product conforms with DCF (Design rule for Camera File system) universal standard established by JEITA (Japan Electronics and Information Technology Industries Association).

- Playback of images recorded with your product on other equipment and playback of images recorded or edited with other equipment on your product are not guaranteed.

Notes on playing movies on other devices

- Movies recorded by your camera may not be playable properly on other devices. Also, movies recorded by devices other than your camera may not be able to playback on your camera.
- Discs of AVCHD movies recorded by your camera can only be played back on devices supporting AVCHD format. DVD players and DVD recorders do not support AVCHD format, so they cannot playback AVCHD movie discs. Also, if a high definition image quality (HD) disc recorded with AVCHD format is inserted in either of DVD players or DVD recorders, the disc may be unable to eject from the device.
- Movies recorded in 1080 60p/1080 50p format can be played back only on 1080 60p/1080 50p supported devices.
- XAVC S movies can be played back only on XAVC S-supported devices.

On the monitor and lens

- The monitor is manufactured using extremely high-precision technology so over 99.99 % of the pixels are operational for effective use. However, there may be some tiny black points and/or bright points (white, red, blue or green in color) that constantly appear on the monitor. These points are normal in the manufacturing process and do not affect the images in any way.
- Exposing the monitor or lens to direct sunlight for long periods may cause a malfunction. Exercise caution when placing the product near a window or outdoors.
- Do not directly expose the lens to beams such as laser beams. That may damage the image sensor and cause the camera to malfunction.
- Do not press against the monitor. The monitor may be discolored and that may cause a malfunction.
- Images may trail across on the monitor in a cold location. This is not a malfunction.
- Do not expose the camera to sunlight or shoot sunward for a long time. The internal mechanism may be damaged.

- Do not use the camera in areas where strong radio waves or radiation is being emitted. Recording and playback may not function correctly.

Notes on discarding or transferring this product to others

When discarding or transferring this product to others, make sure to perform the following operation to protect private information.

- Perform [Setting Reset] to reset all the settings.

Notes on discarding or transferring a memory card to others

Executing [Format] or [Delete] on the camera or a computer may not completely delete the data on the memory card. When transferring a memory card to others, we recommend that you delete the data completely using data deletion software. When discarding a memory card, we recommend that you physically destroy it.

Notes when using the Wi-Fi function

Please note that any connection to unsecured Wi-Fi access points increases the risk of unauthorized interception. Only secured Wi-Fi connections should be utilized with this product.

Services and software provided by other companies

Network services, content, and the [operating system and] software of this Product may be subject to individual terms and conditions and charged, interrupted or discontinued at any time and may require fees, registration and credit card information.

Digital Still Camera
DSC-RX0

On the internal rechargeable battery

This camera has an internal rechargeable battery for maintaining the date and time and other settings regardless of whether the power is on or off, or whether the battery pack is charged or discharged. This rechargeable battery is continually charged as long as you are using the product. However, if you use the product for only short periods, it gradually discharges. If you do not use the product at all for about 1 month(s) it becomes completely discharged. In this case, be sure to charge this rechargeable battery before using the product. However, even if this rechargeable battery is not charged, you can still use the product as long as you do not record the date and time.

Charging method of the internal rechargeable battery

Insert a charged battery pack into the product, or connect the product to a wall outlet (wall socket) using the AC Adaptor (supplied), and leave the product for 24 hours or more with the power off.

Notes on the battery pack

Charging the battery pack

- Charge the battery pack (supplied) before using the product for the first time.
- The charged battery pack will discharge little by little even if you do not use it. Charge the battery pack each time before you use the product so that you do not miss any opportunities to shoot images.
- You can charge the battery pack even if it is not completely discharged. You can use a partially charged battery pack.
- If the charge lamp flashes when the battery pack is not fully charged, remove the battery pack or disconnect the USB cable from the camera and then reinsert it to recharge.
- We recommend charging the battery pack at an ambient temperature between 10°C and 30°C (50°F and 86°F). The battery pack may not charge normally at temperatures outside this range.
- When you connect this product and a laptop computer that is not connected to a power source, the laptop's battery charge may decrease. Do not charge this product using the laptop computer for too long.
- Do not turn on/restart a computer, wake a computer from sleep mode, or turn off a computer while this product is connected to the computer via USB cable. Doing so may cause a malfunction of this product. Disconnect the product and the computer before performing the above operations.
- We do not guarantee charging if you are using a self-built or modified computer.

Charging time (Full charge)

The charging time is approximately 135 minutes using the AC adaptor (supplied).

The above charging time applies when charging a fully depleted battery pack at a temperature of 25 °C (77 °F). Charging may take longer depending on conditions of use and circumstances.

Effective use of the battery pack

- Battery performance decreases in low temperature environments. So in cold places, the operational time of the battery pack is shorter. To ensure longer battery pack use, we recommend putting the battery pack in your pocket close to your body to warm it up, and insert it in the product immediately before you start shooting. If there are any metal objects such as keys in your pocket, be careful of causing a short-circuit.
- The battery pack will become depleted more quickly if you use the continuous shooting function frequently, turn the power on/off frequently, or set the monitor to be very bright.
- We recommend preparing spare battery packs and taking trial shots before taking the actual shots.
- Do not expose the battery pack to water. The battery pack is not water-resistant.
- Do not leave the battery pack in extremely hot places, such as in a car or under direct sunlight.
- If the battery terminal is dirty, you may not be able to turn on the product or the battery pack may not be properly charged. In that case, clean the battery by lightly wiping off any dust using a soft cloth or a cotton swab.

Remaining battery indicator

- The remaining battery indicator appears on the screen.



A: Battery level high
B: Battery exhausted

- It takes about one minute for the correct remaining battery indicator to appear.

- The correct remaining battery indicator may not be displayed under some operating or environmental conditions.
- If you do not operate the product for a certain period of time while the power is on, the product turns off automatically (Auto power-off function).
- If the remaining battery time does not appear on the screen, press the DISP (Display Setting) button to display it.

How to store the battery pack

- To maintain the battery pack's function, charge the battery pack and then fully discharge it in the product at least once a year before storing it. Remove the battery pack from the camera and store the battery in a cool, dry place.
- To use the battery pack up, leave the product in slide show playback mode until the power goes off.
- To prevent staining the terminal, short-circuiting, etc., be sure to use a plastic bag to keep away from metal materials when carrying or storing the battery pack.

On battery life

- The battery life is limited. If you use the same battery repeatedly, or use the same battery for a long period, the battery capacity decreases gradually. If the available time of the battery is shortened significantly, it is probably time to replace the battery pack with a new one.
- The battery life varies according to how the battery pack is stored and the operating conditions and environment in which each battery pack is used.

Charging the battery pack

- The supplied AC Adaptor is dedicated to this product. Do not connect with other electronic devices. Doing so may cause a malfunction.
- Make sure to use a genuine Sony AC Adaptor.
- If the product's charge lamp flashes while charging, remove the battery pack being charged, and then insert the same battery pack firmly back into the product. If the charge lamp flashes again, this may indicate a faulty battery or that a battery pack other than the specified type has been inserted. Check that the battery pack is the specified type. If the battery pack is the specified type, remove the battery pack, replace it with a new or different one and check that the newly inserted battery is charging correctly. If the newly inserted battery is charging correctly, the previously inserted battery may be faulty.
- If the charge lamp flashes even if the AC Adaptor is connected to the product and the wall outlet (wall socket), this indicates that charging has stopped temporarily and is on standby. Charging stops and enters standby status automatically when the temperature is outside of the recommended operating temperature. When the temperature returns to the appropriate range, charging resumes and the charge lamp lights up again. We recommend charging the battery pack in an ambient temperature of between 10°C to 30°C (50°F to 86°F).
- If you turn on the camera while charging the battery pack, power will be supplied from the wall outlet (wall socket). You can shoot or play back images while power is being supplied, but the battery pack will not charge.

Notes on memory card

- If you repeatedly shoot and delete images for a long time, fragmentation of data in a file in the memory card may occur, and movie recording may be interrupted in the middle of shooting. If this happens, save your images to a computer or other storage location, then execute [Format].
- Memory card formatted with a computer is not guaranteed to operate with the product.
- Data read/write speeds differ depending on the combination of the memory card and the equipment used.
- We recommend backing up important data, such as to a hard disk of a computer.
- Do not attach a label on the memory card itself nor on a memory card adaptor.
- Do not touch the terminal section of the memory card with your hand or a metal object.
- Do not strike, bend or drop the memory card.
- Do not disassemble or modify the memory card.
- Do not expose the memory card to water.
- Do not leave the memory card within the reach of small children. They might accidentally swallow it.
- The memory card may be hot just after it has been used for a long time. Be careful when you handle it.
- Do not remove the battery pack or the memory card or turn the camera off while the access lamp is illuminated. This may cause the data on the memory card to become damaged.
- If the memory card is used near areas with strong magnetization, or used in locations subject to static electricity or electrical noise, the data on the memory card may become damaged.
- Do not insert a memory card that does not fit the memory card slot. Doing so will cause a malfunction.
- Do not use or store the memory card under the following conditions:
 - High temperature locations such as in a car parked under the sun
 - Locations exposed to direct sunlight
 - Humid locations or locations with corrosive substances present

Notes on the memory card/connector cover

Do not leave the detached memory card/connector cover within the reach of small children. It may be swallowed accidentally.

On cleaning

Cleaning the glass cover of the lens

Wipe the glass cover of the lens with a soft cloth to remove fingerprints, dust, etc.

Cleaning the product surface

Clean the product surface with a soft cloth slightly moistened with water, then wipe the surface with a dry cloth. To prevent damage to the finish or casing:

- Do not expose the product to chemical products such as thinner, benzine, alcohol, disposable cloths, insect repellent, sunscreen or insecticide.
- Do not touch the product with any of the above on your hand.
- Do not leave the product in contact with rubber or vinyl for a long time.

Cleaning the monitor

- If oil from your hand or hand cream, etc., remain on the monitor, the original coating may become easily removable. Wipe oil or hand cream off as soon as possible.
- If you wipe the monitor firmly using tissue paper, etc., the coating may be scratched.
- If the monitor becomes dirty with fingerprints or dust, gently remove the dust from the surface, and then clean the monitor using soft cloth, etc.

Digital Still Camera
DSC-RX0



Number of still images

The table below shows the approximate number of images that can be recorded on a memory card formatted with this camera. The number of still images may vary depending on the shooting conditions and the memory card.

[ Image Size]: [L: 15M]

When [ Aspect Ratio] is set to [3:2]*

 Quality	8 GB	32 GB	128 GB
Standard	1450 images	6000 images	24000 images
Fine	880 images	3550 images	14000 images
Extra fine	660 images	2650 images	10500 images
RAW & JPEG	300 images	1200 images	4900 images
RAW	460 images	1850 images	7400 images

* When the [ Aspect Ratio] is set to other than [3:2], you can record more pictures than shown above. (Except when [ Quality] is set to [RAW].)

Note

- Even if the number of remaining shootable images is greater than 9,999, the “9999” indicator appears.
- When an image shot with other products is played back on this product, the image may not appear in the actual image size.
- The values are defined using Sony standard memory cards for testing.

Recordable time of movies

The table below shows the approximate maximum recording times which can be recorded on the memory card that is formatted with this product. These numbers are the total times of all movie files on the memory card. The recordable time may vary depending on the shooting conditions and the memory card. The values when [File Format] is set to [XAVC S HD] and [AVCHD] are based on shooting with [Dual Video REC] set to [Off].

(h (hour), m (minute))

	8 GB	32 GB	128 GB
XAVC S HD 120p 50M/100p 50M	15 m	1 h 15 m	5 h 10 m
XAVC S HD 60p 50M/50p 50M	15 m	1 h 15 m	5 h 10 m
XAVC S HD 30p 50M/25p 50M	15 m	1 h 15 m	5 h 10 m
XAVC S HD 24p 50M*	15 m	1 h 15 m	5 h 10 m
AVCHD 60i 24M(FX)/50i 24M(FX)	40 m	3 h	12 h 5 m
AVCHD 60i 17M(FH)/50i 17M(FH)	55 m	4 h 5 m	16 h 35 m
AVCHD 60p 28M(PS)/50p 28M(PS)	35 m	2 h 30 m	10 h 15 m
AVCHD 24p 24M(FX)/25p 24M(FX)	40 m	3 h	12 h 5 m
AVCHD 24p 17M(FH)/25p 17M(FH)	55 m	4 h 5 m	16 h 35 m
MP4 1920x1080 60p 28M/1920x1080 50p 28M	35 m	2 h 35 m	10 h 40 m
MP4 1920x1080 30p 16M/1920x1080 25p 16M	1 h	4 h 10 m	16 h 55 m
MP4 1280x720 30p 6M/1280x720 25p 6M	2 h 35 m	10 h 55 m	44 h 10 m

* Only when [NTSC/PAL Selector] is set to NTSC.

Note

- The continuous recordable time for movies is approximately 13 hours at maximum.
- The recordable time of movies varies because the product is equipped with VBR (Variable Bit-Rate), which automatically adjusts image quality depending on the shooting scene.
When you record a fast-moving subject, the image is clearer but the recordable time is shorter because more memory is required for recording.
The recordable time also varies depending on the shooting conditions, the subject or the image quality/size settings.
- The values are defined using Sony standard memory cards for testing.

Notes on continuous movie recording

- It requires a lot of power to perform high quality movie recording or continuous shooting. Therefore, if you continue to shoot, the temperature inside the camera will rise, especially that of the image sensor. In such cases, the camera will turn off automatically because the surface of the camera is heated to a high temperature or the high temperature affects the quality of the images or the internal mechanism of the camera.
- The duration of time available for continuous movie recording is as follows when the camera starts recording after the power of the camera has been turned off for a while. The following values indicate the continuous time from when the

camera starts recording until the camera stops recording.

XAVC S HD (60p 50M/50p 50M)

[Auto Pwr OFF Temp.]: [Standard]

Ambient temperature	[Ctrl w/ Smartphone]: [Off]	[Ctrl w/ Smartphone]: [On]
20°C (68°F)	Approx. 45 min.	Approx. 20 min.
30°C (86°F)	Approx. 25 min.	Approx. 15 min.
40°C (104°F)	Approx. 25 min.	Approx. 15 min.

XAVC S HD (60p 50M/50p 50M)

[Auto Pwr OFF Temp.]: [High]

Ambient temperature	[Ctrl w/ Smartphone]: [Off]	[Ctrl w/ Smartphone]: [On]
20°C (68°F)	Approx. 60 min.	Approx. 50 min.
30°C (86°F)	Approx. 60 min.	Approx. 50 min.
40°C (104°F)	Approx. 25 min.	Approx. 20 min.

- The duration of time available for movie recording varies with the temperature, file format/record setting for movies, Wi-Fi network environment, or condition of the camera before you start recording. If you frequently recompose or shoot images after the power is turned on, the temperature inside the camera will rise and the recording time available will be shorter.
- If the  icon appears, the temperature of the camera has risen.
- If the camera stops recording due to the temperature, leave it for some time with the power turned off. Start recording after the temperature inside the camera drops fully.
- If you observe the following points, you will be able to record movies for longer periods of time.
 - Keep the camera out of direct sunlight.
 - Turn the camera off when it is not being used.

Digital Still Camera
DSC-RX0

Using the AC Adaptor/battery charger abroad

You can use the battery charger (sold separately) and the AC Adaptor (supplied) in any country or region where the power supply is within 100 V to 240 V AC and 50 Hz/60 Hz.

Depending on the country/region, a converting plug adaptor may be needed to connect to a wall outlet (wall socket).

Note

- Do not use an electronic voltage transformer as doing so may cause a malfunction.

Digital Still Camera
DSC-RX0

On TV color systems

To view movies shot using this product on a television, the product and television must use the same color television system. Check the TV color system for the country or region where you are using the product.

- **NTSC system:**

Bahama Islands, Bolivia, Canada, Central America, Chile, Colombia, Ecuador, Jamaica, Japan, Korea, Mexico, Peru, Surinam, Taiwan, the Philippines, the U.S.A., Venezuela, etc.

- **PAL system:**

Australia, Austria, Belgium, China, Croatia, Czech Republic, Denmark, Finland, Germany, Holland, Hong Kong, Hungary, Indonesia, Italy, Kuwait, Malaysia, New Zealand, Norway, Poland, Portugal, Rumania, Singapore, Slovak Republic, Spain, Sweden, Switzerland, Thailand, Turkey, United Kingdom, Viet Nam, etc.

- **PAL-M system:**

Brazil

- **PAL-N system:**

Argentina, Paraguay, Uruguay

- **SECAM system:**

Bulgaria, France, Greece, Guiana, Iran, Iraq, Monaco, Russia, Ukraine, etc.

Digital Still Camera
DSC-RX0

ZEISS lens

The camera is equipped with a ZEISS lens which is capable of reproducing sharp images with excellent contrast. The lens for the camera has been produced under a quality assurance system certified by ZEISS in accordance with the quality standards of ZEISS in Germany.

4-698-613-13(1) Copyright 2017 Sony Corporation

Digital Still Camera
DSC-RX0

AVCHD format

The AVCHD format was developed for high-definition digital video cameras when recording an HD (High-Definition) signal using high-efficiency compression coding technology. The MPEG-4 AVC/H.264 format is used to compress video data, and the Dolby Digital or Linear PCM system is used to compress audio data.

The MPEG-4 AVC/H.264 format is capable of compressing images at higher efficiency than that of the conventional image compressing format.

- As the AVCHD format uses compression coding technology, the picture may be unstable in scenes where the screen, angle of view, or brightness, etc. change drastically, but this is not a malfunction.

Digital Still Camera
DSC-RX0

License

Notes on the License

This product comes with software that are used based on licensing agreements with the owners of that software. Based on requests by the owners of copyright of these software applications, we have an obligation to inform you of the following. Please read the following sections. Licenses (in English) are recorded in the internal memory of your product. Establish a Mass Storage connection between the product and a computer to read licenses in the “PMHOME” - “LICENSE” folder.

THIS PRODUCT IS LICENSED UNDER THE AVC PATENT PORTFOLIO LICENSE FOR THE PERSONAL USE OF A CONSUMER OR OTHER USES IN WHICH IT DOES NOT RECEIVE REMUNERATION TO

- (i) ENCODE VIDEO IN COMPLIANCE WITH THE AVC STANDARD (“AVC VIDEO”)

AND/OR

- (ii) DECODE AVC VIDEO THAT WAS ENCODED BY A CONSUMER ENGAGED IN A PERSONAL ACTIVITY AND/OR WAS OBTAINED FROM A VIDEO PROVIDER LICENSED TO PROVIDE AVC VIDEO.

NO LICENSE IS GRANTED OR SHALL BE IMPLIED FOR ANY OTHER USE. ADDITIONAL INFORMATION MAY BE OBTAINED FROM MPEG LA, L.L.C. SEE [HTTP://WWW.MPEGLA.COM](http://www.mpegla.com)

On GNU GPL/LGPL applied software

The software that is eligible for the following GNU General Public License (hereinafter referred to as “GPL”) or GNU Lesser General Public License (hereinafter referred to as “LGPL”) are included in the product.



This informs you that you have a right to have access to, modify, and redistribute source code for these software programs under the conditions of the supplied GPL/LGPL.

Source code is provided on the web. Use the following URL to download it.

<http://oss.sony.net/Products/Linux/>

We would prefer you do not contact us about the contents of source code.

Trademarks

- Memory Stick and  are trademarks or registered trademarks of Sony Corporation.
- XAVC S and  are registered trademarks of Sony Corporation.
- Blu-ray Disc™ and Blu-ray™ are trademarks of the Blu-ray Disc Association.
- AVCHD Progressive and AVCHD Progressive logotype are trademarks of Panasonic Corporation and Sony Corporation.
- Dolby, Dolby Audio and double-D symbol are trademarks of Dolby Laboratories.
- The terms HDMI and HDMI High-Definition Multimedia Interface, and the HDMI Logo are trademarks or registered trademarks of HDMI Licensing Administrator, Inc. in the United States and other countries.
- Microsoft and Windows are registered trademarks or trademarks of Microsoft Corporation in the United States and/or other countries.
- Mac is a trademark of Apple Inc., registered in the United States and other countries.
- IOS is a registered trademark or trademark of Cisco Systems Inc.
- iPhone and iPad are trademarks of Apple Inc., registered in the U.S. and other countries.
- microSDXC logo is a trademark of SD-3C, LLC.
- Android and Google Play are trademarks or registered trademarks of Google Inc.
- Wi-Fi, the Wi-Fi logo, Wi-Fi Protected Setup are registered trademarks or trademarks of the Wi-Fi Alliance.
- DLNA and DLNA CERTIFIED are trademarks of Digital Living Network Alliance.
- Facebook and the “f” logo are trademarks or registered trademarks of Facebook, Inc.
- YouTube and the YouTube logo are trademarks or registered trademarks of Google Inc.
- The Bluetooth® word mark and logos are registered trademarks owned by the Bluetooth SIG, Inc. and any use of such marks by Sony Corporation is under license.
- QR Code is a registered trademark of Denso Wave Inc.
- In addition, system and product names used in this manual are, in general, trademarks or registered trademarks of their respective developers or manufacturers. However, the ™ or ® marks may not be specified in all cases in this manual.

Troubleshooting

If you experience trouble with the product, try the following solutions.

- 1 Remove the battery pack, wait for about one minute, re-insert the battery pack, then turn on the power.**
If a message such as “C/E:□□:□□” appears on the screen, refer to the self-diagnosis display.
- 2 Initialize the settings.**
- 3 Consult your dealer or local authorized service facility. Additional information on this product and answers to frequently asked questions can be found at our Customer Support Website.**
<http://www.sony.net/>

Related Topic

- [Self-diagnosis display](#)
- [Setting Reset](#)

Digital Still Camera
DSC-RX0

Self-diagnosis display

If a code starting with a letter of the alphabet appears, the self-diagnosis function on this product is working. The last two digits (indicated by □□) will differ depending on the state of this product.

If you cannot solve the problem even after trying the following corrective actions a few times, this product may need repair. Contact your Sony dealer or local authorized Sony service facility.

C:32:□□

- There is trouble with the product's hardware. Turn the power off and on again.

C:13:□□

- This product cannot read or write data on the memory card. Try turning off and on this product again, or taking out and inserting the memory card several times.
- An unformatted memory card is inserted. Format the memory card.
- The inserted memory card cannot be used with this product, or the data is damaged. Insert a new memory card.

E:61:□□

E:62:□□

E:91:□□

- A product malfunction has occurred. Initialize this product, then turn the power on again.

E:94:□□

- There is a malfunction when writing or deleting data. Repair is required. Contact your Sony dealer or local authorized Sony service facility. Be prepared to give all numbers in the error code beginning from the E.

Related Topic

- [Format](#)
- [Setting Reset](#)

Digital Still Camera
DSC-RX0

Warning messages

Set Area/Date/Time.

- Set the area, date and time. If you have not used the product for a long time, charge the internal rechargeable backup battery.

Unable to use memory card. Format?

- The memory card was formatted on a computer and the file format was modified. Select [Enter], and then format the memory card. You can use the memory card again, however, all previous data in the memory card is erased. It may take some time to complete the format. If the message still appears, change the memory card.

Memory Card Error

- An incompatible memory card is inserted.
- Formatting has failed. Format the memory card again.

Unable to read memory card. Reinsert memory card.

- An incompatible memory card is inserted.
- The memory card is damaged.
- The terminal section of the memory card is dirty.
- The memory card is not inserted in the appropriate direction. Check the direction of the memory card.

Cannot open the shutter since the memory card is not inserted.

- No memory card has been inserted.
- To release the shutter without inserting a memory card into the camera, set [Release w/o Card] to [Enable]. In this case, images will not be saved.

This memory card may not be capable of recording and playing normally.

- An incompatible memory card is inserted.

Processing...

- When performing noise reduction, the reduction process takes place. You cannot do any further shooting during this reduction process.

Unable to display.

- Images recorded with other products or images modified with a computer may not be displayed.
- Processing on the computer such as deletion of the image files may cause inconsistencies in the image database files. Repair the image database files.

Unable to print.

- You tried to mark RAW images with a DPOF mark.

Internal temp. high. Allow it to cool.

- The product has become hot because you have been shooting continuously. Turn the power off. Cool the product and wait until the product is ready to shoot again.



- You have been recording images for a long time, the product temperature has risen.

Recording is unavailable in this movie format.

- Set [ File Format] to [MP4].



- The number of images exceeds that for which date management in a database file by the product is possible.



- Unable to register to the database file. Import all the images to a computer and recover the memory card.

Image DataBase File error

- There is something wrong in the Image Database File. Select [Setup] → [Recover Image DB].

System Error

Camera Error. Turn power off then on.

- Remove the battery pack, and then re-insert it. If the message appears frequently, consult your Sony dealer or local authorized Sony service facility.

Unable to magnify.

Unable to rotate image.

- Images recorded with other products may not be enlarged or rotated.

Cannot create more folders.

- A folder in the memory card has the first three digits “999.” You cannot create any more folders on this camera.

Related Topic

- [On the internal rechargeable battery](#)
- [Notes on memory card](#)
- [Format](#)