

Congratulations, you have purchased the finest exhaust system available for your motorcycle. Your Vance & Hines exhaust is designed and crafted for performance, quality, and style. Please follow the instructions below, check exhaust system for missing or damaged parts and if you need any assistance please contact our technical support line (562) 921-7461.

### PARTS LIST

ITEM NO.	DESCRIPTION	QTY.
1	MUFFLER CAN	1
2	2.25" - 2.56" H.D. TORCA CLAMP	1

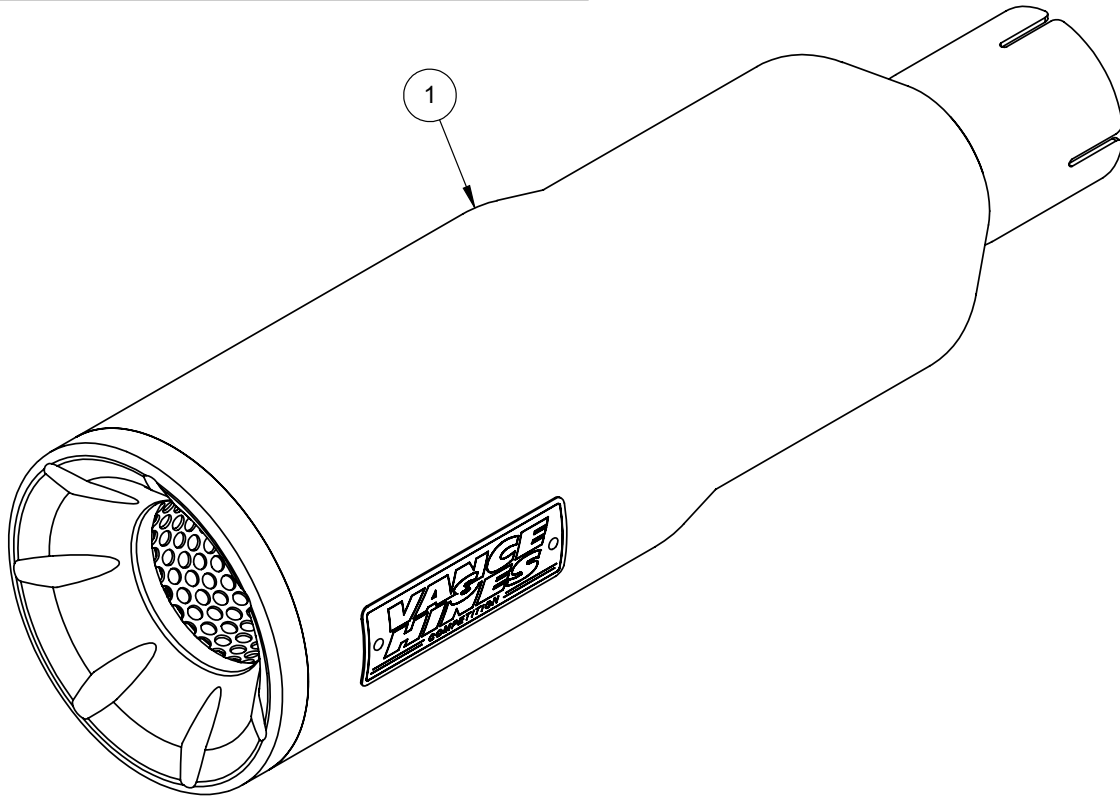

### HARDWARE

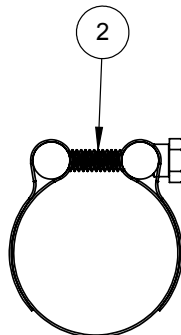

\*NOT ACTUAL SIZE

## TOOLS REQUIRED

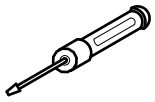

FLAT BLADE  
SCREWDRIVER

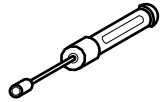

5/16 NUT DRIVER

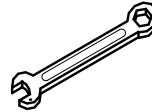

10 MM 13MM  
WRENCH

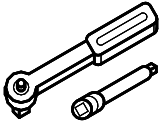

RATCHET: 3/8" DRIVE  
SOCKETS: 13MM, 14MM  
3" EXTENSION

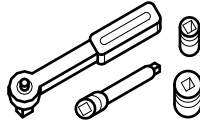

RATCHET: 1/4" DRIVE  
SOCKET: 13MM  
3" EXTENSION

## STOCK EXHAUST SYSTEM REMOVAL

1. Using a 13mm wrench/socket loosen the hardware that attaches the stock muffler to the stock mounting bracket. **(Figure 1)**
2. Using a 14 mm socket loosen the Torca Clamp holding the muffler onto the catalytic converter. **(Figure 2)**
3. Using a 5/16" nutdriver or flat head screwdriver loosen all heat shield hose clamps.
4. Using a 1/4" drive ratchet with a 13mm socket loosen the front and rear header flanges. **(Figure 2)**
5. Remove the stock muffler by completely removing the hardware in step 1.
6. Remove the stock catalytic converter heatshield.

## VANCE & HINES EXHAUST INSTALLATION

1. Carefully remove the muffler from protective packaging.
2. It's recommended to apply a strip of masking tape over the muffler cone area.
3. Slip the provided torca clamp onto the inlet of muffler assembly, keeping the original orientation. **(Figure 2)**.
4. Use the stock muffler hardware to attach the new V&H muffler. Do not tighten at this time.
5. Loosely install the stock heatshield onto the catalytic converter.
6. Now tighten down the muffler to the stock bracket and the Torca Clamp.
7. Position the muffler heat shield to achieve the proper alignment. You may need to adjust the header a bit to achieve the correct alignment. **(Figure 4)**
8. Once the heat shield to the muffler alignment is done, remove the masking tape and tighten the heatshield hose clamps.
9. Now tighten the front header flange. Tighten the rear header flange, and front and rear heat shields as well. Reference your owners manual for the correct torque the on header flanges.

## EXHAUST CARE

1. When installing a new set of stainless steel pipes, make sure your hands are clean and free of oil. After installation, thoroughly clean pipes with a soft cloth and cleaning solvent that will leave no residue ( chrome wax/polish, glass cleaner, alcohol, ammonia, etc.) before starting the motorcycle.
2. Avoid long periods of idling as this can cause discoloration.
3. Intake leaks can cause the engine to run lean and overheat, this could lead to discoloration.

**FIGURE 1**

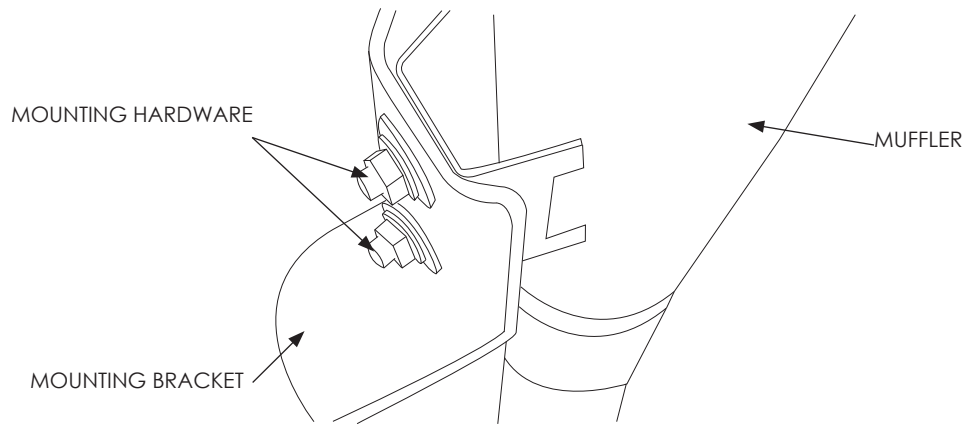

**FIGURE 2**

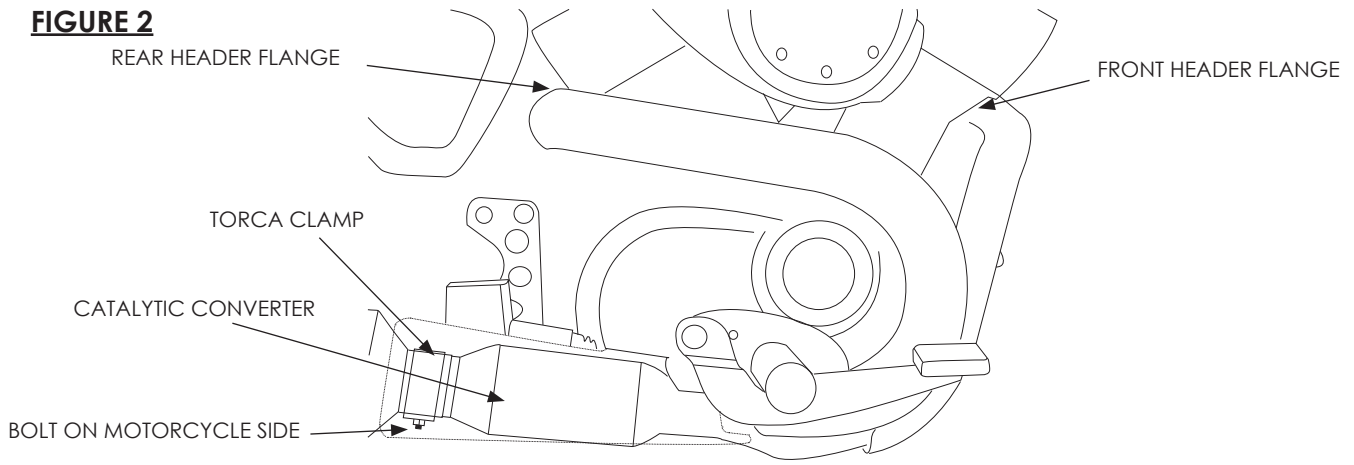

**FIGURE 3**

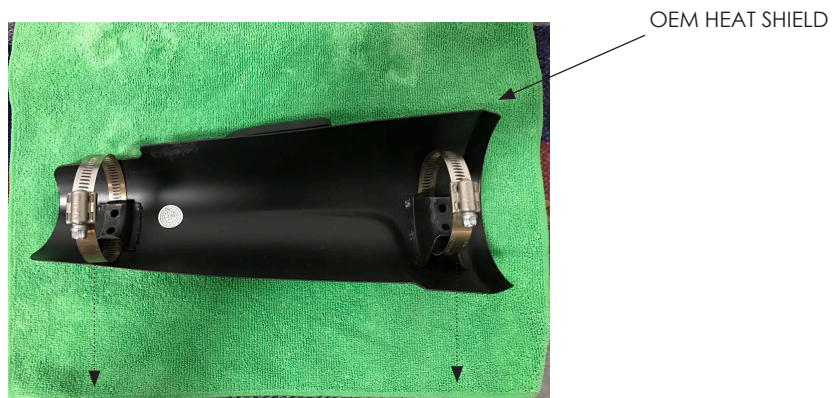

**FIGURE 4**



Emissions Notice:

In California, in order to meet Air Resources Board emissions requirements, certain aftermarket part applications have been identified as replacements, and others have received ARB Executive Orders. All other emissions related aftermarket parts are for competition use only. A list of replacement parts and EO parts, and corresponding fitment is provided at [vanceandhines.com/california](http://vanceandhines.com/california).

Warranty:

All Vance & Hines products are warranted against defects in material and workmanship for a period of 90 days. This warranty does not cover discoloration or rust. This warranty shall be limited to the repair or replacement of the product, which may be proven defective under normal use. Vance & Hines will not warranty any system that has been abused, misused, improperly installed or modified.

Dealers or distributors are not authorized to make dispositions binding upon Vance & Hines. Vance & Hines will not be responsible for any labor charges incurred in removing or replacing any system under warranty. A return authorization number and a copy of the original purchase invoice must accompany all returns. Parts returned without a return authorization may be refused.

13861 ROSECRANS AVENUE / SANTA FE SPRINGS, CA 90670

SALES: (562) 921-5388

TECHNICAL: (562) 926-5291

FAX: (562) 802-0110