



HYPERPRO SPRING MOUNTING MANUAL



HYPERPRO Spring Mounting Manual Content

Front Fork Springs

Telelever front suspension is disassembled as a mono shock (rear suspension)

	Fork type		Page
F1	Right side up		1
F2	Right side up	With internal damper rod* (cartridge)	4
F3	Upside down	With internal damper rod* (cartridge)	7
F4	Upside down	With internal separate damper	11

* Special tools are used

Rear Suspension Mounting

	Description	Page
M1	Mono shock	14
M2	Twin shock	15
M3	Link system	16

Rear Shock Springs

The shocks with and without damping adjustment are disassembled similarly. Note that shock absorbers can not be opened, as this depressurizes the damper.

	Preload adjustment type	Page
S1	Cam collar adjustment	18
S2	Threaded ring adjustment	20
S3	Hydraulic adjustment	22
S4	Pull shock	24

Motorcycle Setup

Setup		Page
1	Maintenance, things to check first	26
2	Static Sag measurement and adjustment	27
3	Damping adjustment	28
4	Handling troubleshooting chart	32
5	Standard torque settings for bolts	33

Note the pictures in this manual are used to indicate the working procedure. Your situation may look different from the pictures shown.

Front fork 1: Right side up

- 1 Measure the distance from the top of the **tubes** to the top fork clamp (1)
Loosen the top fork clamp bolts. Loosen but not remove the fork screwcaps (4)
Tip: Use a piece of paper to help protect the caps from damaging.

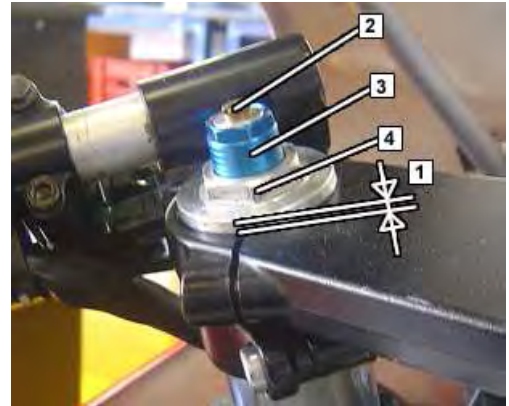

If this is not possible in the normal position, move the forks down in the clamps (the wheel has to be removed for this), retain the tubes in the bottom clamp, at about 30 mm distance. Loosen the caps.

Removing the fork first and later unscrew the caps is difficult, it is virtually impossible to counterhold the fork. Always use the fork clamp to hold the fork; never place the fork in a vice as this causes damage to the tubes. It is possible to counter hold the fork by hand when a compressed air wrench is used.

- 2 Place the bike stable with the front wheel off the ground. Remove the front fork from the bike. View the bike manual for details.
- 3 Remove the screwcaps (4) from the fork.
Note: The caps are under tension from the preload on the spring, be careful when removing.
- 4 Remove the parts from the fork: preload bush (5), ring(s) and spring. Note how the parts fit, sometimes there is a tapered end on one side of the spring.
Pour the old oil into a tank. Hold the fork upside down and compress and decompress the fork to pump all the oil out off the fork (± 10 to 20 times, until there is no damping felt)



Old oil is harmful for the environment, dispose of it properly.

- 5 Inspect the parts for their condition. Broken parts and/or leaking seals should be replaced. If an oil seal is replaced, be sure to also check the inner tube for damage.
Clean all the parts before reassembly.
- 6 Fully compress the fork and fill it with HYPERPRO fork oil of the right viscosity (see frontpage: **HYPERPRO OIL**) until about 200 mm under the edge.

Pump all the air out of the fork by compressing and decompressing the fork (± 10 to 20 times)



- 7** Measure the oil level (air chamber): Compress the fork fully, with the loose parts (ring(s), preload bush and spring) removed. Make sure the fork is compressed in the **hydraulic lock**; when the compressing becomes heavier, push further until steel to steel contact is felt. The oil level is the distance between the top of the tube and the oil inside. Hold the fork straight up. Use a tape measure; slide it in until it just lightly touches the oil in the fork. Hold it against the upper edge of the tube. Add or remove oil until the setting on the frontpage is reached (see: **OIL LEVEL**) Make sure there is no air in the fork (see step 6)

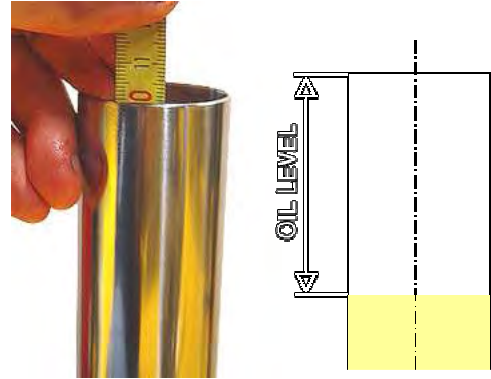

- 8** Mount the HYPERPRO spring in the fork. View the frontpage for the mounting direction, usually the progressive side (circle) is mounted up. Sometimes there is a sticker marking which side up. Fit the spring without the sticker. Fit the ring(s) and the preload bush if present. The mounting order of the parts is the same as original.



Unless there is a remark on the frontpage

- 9** Mount the screwcaps (4) in the fork. Hold the inner tube and compress the spring using the cap. Screw it in the inner tube; make sure the cap is screwed a few turns in before releasing the pressure as the spring preload pushes the cap out, it could jump out when released.

For screwcaps with rebound adjustment rod:
Make sure the adjustment rod fits correctly in the cartridge. The adjustment rod should fit in the middle of the cartridge; it falls over an adjustment mechanism inside the fork and usually fits one way because of the flat side on the adjustment rod. The rod slides smoothly over the adjuster inside, don't push on the cap as this damages the adjustment rod. If there is a gap between the preload bush or spring and the cap, the adjustment rod is not fitted in the cartridge correctly, take it out and fit it again until it is placed correctly.



Screwcap with rebound adjustment rod

When the cap is placed correctly, the bottom of the cap **lies on the preload bush or spring**, with (almost) no room in between. Push on the cap, **directly compressing the spring** so the cap can be screwed in the fork.

Be careful when mounting, the spring preload pushes the cap out. Be sure the cap is a few turns in before the pressure is released; else the cap could jump out.

- 10** Set the spring preload (3, if available) as specified on the frontpage (see: **SPRING PRELOAD**) Less rings showing indicates more preload, the preload can be adjusted to set the static sag, view setup chapter 2.

The forks with reversed preload (check the **frontpage** for a **remark**) have a bush (11) which slides up and down in the cap (4) using screw (3) More rings (10) showing indicates more preload; normally more rings indicate less preload. The turning direction is the same; clockwise for more preload.

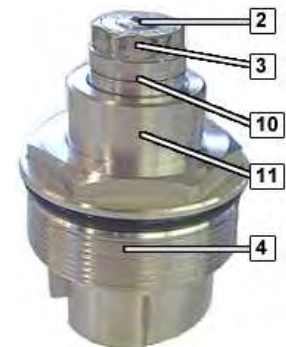

Fork cap with reversed preload

Set the rebound damping (2, if available) as specified on the frontpage (view **REBOUND**) The rebound adjustment screw is located on the top of the fork. The positions are counted from the longer click outwards. Turn counter clockwise until one click feels longer; that is position one. Start counting the clicks from there.

- 11** HYPERPRO fork lubricant reduces the friction of the front fork. Carefully prise off the dust seals from the outer tube of the fork with a small flat screwdriver. Put the grease on the inner tube of the fork. Move the fork in and out. Repeat this. Put some grease on the dust seals to make them slide in more easily. Refit the dust seals and remove the excess grease.



- 12** Mount everything on the bike. Fit the fork at the distance as measured at step 1; **Unless there is a remark on the frontpage** Make sure everything is tightened to the correct torque setting.

- 13** Loosen the clamping bolt(s) of the front axle.

Push the front fork a few times as deep as possible to let the fork settle itself in the position with the least friction.

Tighten the front axle bolt(s)



Front fork 2: Right side up, with cartridge

- 1 Measure the distance from the top of the **tubes** to the top fork clamp (1)
Loosen the top fork clamp bolts. Loosen but not remove the fork screwcaps (4)
Tip: Use a piece of paper to help protect the caps from damaging.

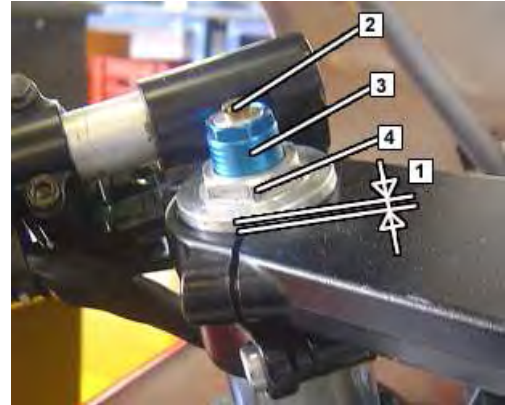

If this is not possible in the normal position, move the forks down in the clamps (the wheel has to be removed for this), retain the tubes in the bottom clamp, at about 30 mm distance. Loosen the caps.

Removing the fork first and later unscrew the caps is difficult, it is virtually impossible to counterhold the fork. Always use the fork clamp to hold the fork; never place the fork in a vice as this causes damage to the tubes. It is possible to counter hold the fork by hand when a compressed air wrench is used.

- 2 Place the bike stable with the front wheel off the ground. Remove the front fork from the bike. View the bike manual for details.
- 3 Turn the rebound screw (2, if available) clockwise, until the damping is fully closed; else the adjustment mechanism will be upset when disassembling the fork. The position of the compression adjustment (if available) is not important.

Unscrew the fork screwcaps (4) from the fork.
Move the inner tube down.

- 4 Place tool A through the holes in the preload bush (5) Press the bush and spring down using tool A. If there are no holes in the bush, clamp the bush between the bolts in tool A, not too tight as this can cause damage.

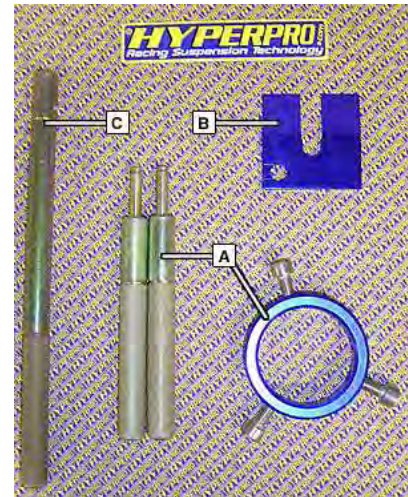

Special tool kit

Let a second person pull the damper rod out with the screwcap (4) and place plate B between the nut (6) and the bush (5)

For front forks with reversed preload adjustment (look on the **frontpage** for a **remark**) the preload has to be set to the minimum (1 ring showing) before this can be done.

- 5 Counterhold the nut (6) and remove the cap (4) Remove the rebound adjustment rod; sometimes it's attached to the screwcap. Note how the adjustment rod fits the fork.
- 6 Place tool C on the damper rod. Press down on tool A, let the second person pull out the damper rod and remove plate B.
- 7 Remove tool A, then remove all the internal parts from the fork: the preload bush, ring(s) and the spring.
Note how the parts fit. There is sometimes a tapered end on one side of the spring.

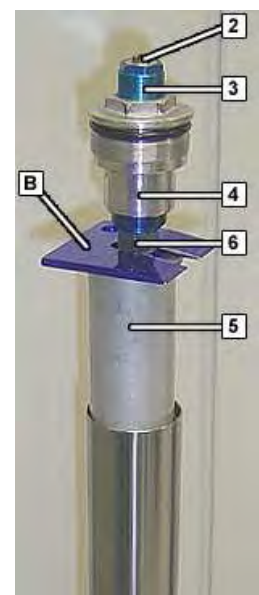

8 Pour the old oil into a tank. Pump the fork: move the damper rod and inner tube up and down slowly a few times to pump all the oil out of the damping cartridge. Hold the fork upside down and pour the oil out of the fork. Then pump the fork again. Repeat this procedure a few times to remove all the oil from the fork (± 5 times, until there is no damping felt)
Old oil is harmful for the environment, dispose of it properly.

9 Inspect the parts for their condition. Broken parts and/or leaking seals should be replaced. If an oil seal is replaced, be sure to also check the inner tube for damage.
Clean all the parts before reassembly.

10 Fully compress the fork and fill it with HYPERPRO fork oil of the right viscosity (see frontpage: **HYPERPRO OIL**) until about 200 mm under the edge.
Pump out all the air of the fork by slowly compressing and decompressing the fork (± 10 to 20 times)

11 Measure the oil level (air chamber): Compress the fork fully, with the loose parts (ring(s), preload bush and spring) removed. Make sure the fork is compressed in the **hydraulic lock**; when the compressing becomes heavier, push further until steel to steel contact is felt.
The oil level is the distance between the top of the tube and the oil inside. Hold the fork straight up. Use a tape measure; slide it in until it just lightly touches the oil inside the fork. Hold it against the upper edge of the tube.

Add or remove oil until the setting on the frontpage is reached (see: **OIL LEVEL**)
Make sure there is no air in the fork (view step 10)

12 Mount the HYPERPRO spring in the fork. View the frontpage for the mounting direction, usually the progressive side (circle) is mounted up. Sometimes there is a sticker marking which side up. Fit the spring without the sticker.

Fit the ring(s) and the preload bush if present. The mounting order of the parts is the same as original.

Unless there is a remark on the frontpage

13 Place tool A on the bush (5) Compress the bush and spring. Let the second person pull out the damper rod and place plate B between the nut and the bush.

14 Screw the nut (6) down. Remove tool C. Fit the rebound adjustment rod in the damper rod. Screw the screwcap (4) onto the damper rod until it stops, don't overtighten as this upsets the adjustment mechanism. Counterhold the cap (4) and tighten the nut (6) against the cap.

15 Hold down tool A. Let the second person remove plate B. Slowly decompress the spring, making sure everything falls correctly into place.

16 Mount the screwcaps (4) in the fork.

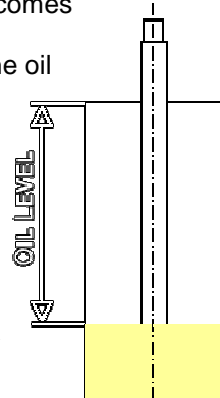

- 17** Set the spring preload (3, if available) as specified on the frontpage (view **SPRING PRELOAD**) Less rings showing indicates more preload, the preload can be adjusted to set the static sag, view setup chapter 2. The forks with reversed preload (check the **frontpage** for a **remark**) have a bush (11) which slides up and down in the cap (4) using screw (3) More rings (10) showing indicates more preload; normally more rings indicate less preload. The turning direction is the same; clockwise for more preload.



Fork cap with reversed preload

Set the damping settings (if available) as specified on the frontpage.

The rebound screw (2) is located on the top of the fork. The compression adjustment screw is usually located on the bottom of the fork.

Clicks or turns are counted from the maximum setting out. Turn the screw in (clockwise) to the maximum setting. Now turn the screw out (counter clockwise) the number of clicks or turns specified on the frontpage (view **REBOUND & COMPRESSION**)



- 18** HYPERPRO fork lubricant reduces the friction of the front fork. Carefully prise off the dust seals from the outer tube of the fork with a small flat screwdriver. Put the grease on the inner tube of the fork. Move the fork in and out. Repeat this. Put some grease on the dust seals to make them slide in more easily. Refit the dust seals and remove the excess grease.



- 19** Mount everything on the bike. Fit the fork at the distance as measured at step 1; **Unless there is a remark on the frontpage** Make sure everything is tightened to the correct torque setting.

- 20** Loosen the clamping bolt(s) of the front axle.

Push the front fork a few times as deep as possible to let the fork settle itself in the position with the least friction.

Tighten the front axle bolt(s)



Front fork 3: Upside down, with cartridge

- 1 Measure the distance from the top of the fork **tubes** to the top of fork clamp (1)
Loosen the top clamp screws (5) Loosen the fork screw caps (4), but not yet remove them.

Tip: Put a piece of paper on the caps to help protect them from damaging.

If this is not possible in the normal position, move the fork down in the clamps; retain the tubes in the bottom clamp, at about 30 mm distance. Loosen the caps.

Removing the fork first and later unscrew the caps is difficult, it is virtually impossible to counter hold the fork. Always use the fork clamp to hold the fork; Never place the fork in a vice as this causes damage to the tubes. It is possible to counter hold the fork by hand when a compressed air wrench is used.

- 2 Place the bike stable with the front wheel off the ground. Remove the front fork from the bike. View the bike manual for details.
- 3 Turn the rebound screw (2, if available) clockwise, until the damping is fully closed; else the adjustment mechanism will be upset when disassembling the fork. The position of the compression adjustment (if available) is not important.

Unscrew the screwcaps (4) from the fork.

Press down the outer tube.

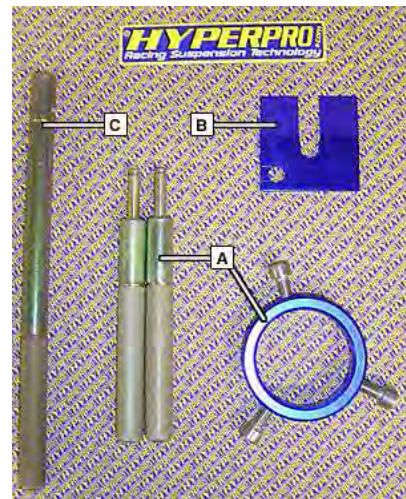
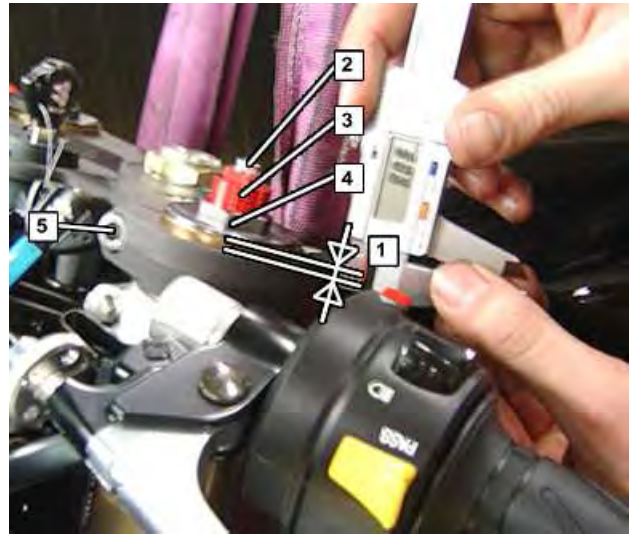

Special tool kit



- 4 Place special tool A on the preload bush (6), through the holes in the bush. If there are no holes in the bush, clamp the bush between the bolts on tool A, not too tight as this can cause damage.

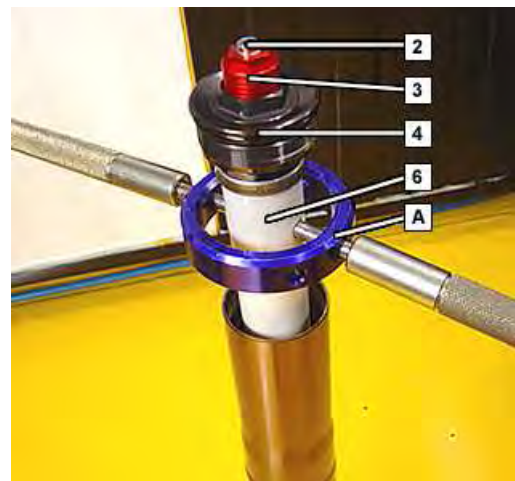

- 5** Use tool A to press the bush (6) and spring fully down. Let somebody else put the plate B between the bush (6) and the nut (7) by pulling the damper rod up with the screwcap (4)

For forks with reversed preload adjustment (check for a **remark** on the **frontpage**) the preload has to be set to the minimum (1 ring showing) before this can be done.

- 6** Remove the screwcap (4) by counterholding the nut (7) and turning the screwcap (4)
Remove the rebound adjustment rod (9) out of the damper rod (8)
Note how it fits the fork.
Sometimes the rebound adjustment rod is attached to the screwcap.

- 7** Screw tool C on the damper rod (8) Use it to remove tool B from between the nut (7) and the preload bush (6) the second person pulls the damper rod out with C and removes the plate B while the first person presses down on A.

- 8** Remove tool A, then remove all the parts from the fork: the preload bush (6), ring(s) and the spring.
Note how the parts fit in the fork. Sometimes the spring has a tapered end on one side.

- 9** Pour the old oil into a tank. Pump the fork: move the damper rod and outer tube up and down slowly a few times to pump all the old oil out off the dampingcartridge. Hold the fork upside down and pour the oil out of the fork. Pump the fork again. Repeat the procedure to remove all the oil from the fork (± 5 times, until there is no damping felt)
Note: Do not remove the outer tube from the inner tube.

Old oil is harmful for the environment, dispose of it properly.

- 10** Inspect the parts for their condition. Broken parts and/or leaking seals should be replaced. If an oil seal is replaced, be sure to also check the inner tube for damage. Clean all the parts before reassembly.



Fork with reversed preload

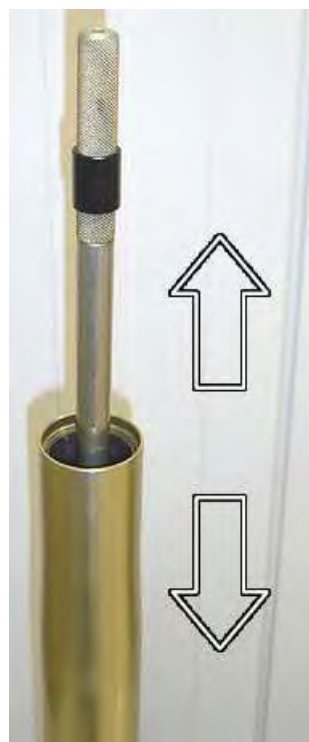
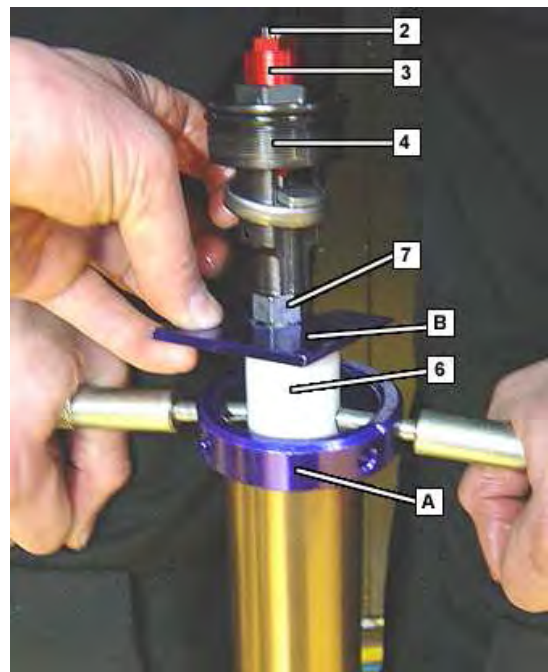

- Compress the fork fully and fill it with HYPERPRO oil of the right viscosity (see frontpage: **HYPERPRO OIL**) until about 200 mm under the edge of the fork tube. **Remove all the air from the fork by moving the outer tube and the damper rod slowly up and down (± 10 to 20 times)**



- Fill the fork to the specified oil level (see frontpage: **OIL LEVEL**)
The oil level (air chamber) is measured with the fork fully compressed and all the loose parts (preload bush, ring(s) and spring) removed. Make sure the fork is compressed in the **hydraulic lock**; when the compressing becomes heavier, push further until steel to steel contact is felt.

The air chamber is the length between the top of the tube and the oil inside the fork. The fork must be held straight up. Slide a tape measure in until it just lightly touches the oil. Hold it against the upper edge of the tube.

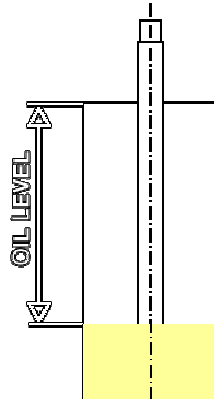

Add or remove oil until the correct setting is reached.

Be sure there is no air in the damping cartridge (view step 11)

- Mount the HYPERPRO spring in the fork. View the frontpage for the mounting direction, usually the progressive side (circle) is mounted up. Sometimes there is a sticker marking which side up. Fit the spring without the sticker.

Fit the ring(s) and the preload bush if present. The mounting order of the parts is the same as original. **Unless there is a remark on the frontpage**



- Place the plate B between the nut (7) and the bush (6) using tool A to press the bush and spring down.
- Screw down the nut (7) Remove tool C from the damper rod (8) Fit the rebound adjustment rod (9) and then screw the cap (4) on until it stops, don't overtighten as this upsets the adjustment mechanism. Counter hold the screwcap (4) and tighten the nut (7) against the cap, be careful not to overtighten it.
- Press down on tool A, let a second person pull out the damper rod (8) with the screwcap (4) Remove the plate B. Make sure everything falls into place correctly when the pressure on tool A is slowly released.

- Tighten the screwcap (4) in the fork.

- Set the preload (3, if available) to the setting specified on the frontpage (view: **SPRING PRELOAD**) Less rings showing indicates more preload, the preload can be adjusted to set the static sag, view setup chapter 2.

The forks with reversed preload (check the **frontpage** for a **remark**) have a bush (11) which slides up and down in the cap (4) using screw (3) More rings (10) showing indicates more preload; normally more rings indicate less preload. The turning direction is the same; clockwise for more preload.



Fork cap with reversed preload

Set the damping settings (if available) according to the settings on the frontpage.

The rebound is adjusted with the screw (2) on the top of the fork. The compression setting screw is usually located on the bottom of the fork (picture)

Clicks or turns are counted from the maximum setting out. Turn the screw in (clockwise) to the maximum setting. Now turn the screw out (counter clockwise) the number of clicks or turns specified on the frontpage (view: **REBOUND & COMPRESSION**)



- 19** HYPERPRO fork lubricant reduces the friction of the front fork. Carefully prise off the dust seals from the outer tube of the fork with a small flat screwdriver. Put the grease on the inner tube of the fork. Move the fork in and out as far as possible. Repeat this.

Put a small amount of grease on the dust seals to make them slide in easily. Refit the dust seals and remove the excess grease.

- 20** Mount everything on the bike. Fit the fork at the distance (1) as measured at step 1; **Unless there is a remark on the frontpage** Make sure everything is tightened to the correct torque setting.



- 21** Loosen the clamping bolt(s) of the front axle.

Hold the front brake and push the front fork a few times as deep as possible to let the fork settle itself in the position with the least friction.

Tighten the front axle bolt(s)



Front fork 4: Upside down, with separate cartridge

- 1** Measure the distance from the top of the **tubes** to the top fork clamp (1)
Place the bike stable with the front wheel off the ground. Remove the front forks from the bike. View the bike manual for details.
- 2** Turn the damping adjustment screws counter clockwise until the minimum setting is reached.
Screw out the damper with the screwcaps. Counterhold the outer tube and turn the cap.
Tip: Use a piece of paper to help protect the caps from damaging.

If it is not possible to counterhold the outer tube by hand, use the fork clamp to counterhold the tube. Place the tube in with about 30 mm clearance from the clamp. Don't use a vice on the round part of the fork as this causes damage to the fork. It is possible to counter hold the fork by hand when a compressed air wrench is used.
- 3** Pour the oil out of the fork. Catch the oil in a tank. Hold the fork upside down for a while to let all the oil drain out of the fork. Also drain the oil from the oil hole in the damper. Compress and decompress the fork slowly (± 10 to 20 times) to pump all the oil out of the fork.
Old oil is harmful for the environment; dispose of it properly.
- 4** Temporarily screw the damper back in the outer tube.
Hold the fork with a vice, clamp it at the axle clamp. Use soft jaws or wood to protect the axle clamp from damaging. Don't overtighten the vice.
- 5** Screw out the bolt which holds the internal damper in place.
Push the fork together so the damper rod is out the fork. Place special tool A between the locknut and the axle clamp.
- 6** Counterhold the locknut and screw off the damper bolt.
Remove the damping adjustment rod from the damper rod. Leave the locknut on the damper rod. Push the fork to remove the special tool from between the locknut and axle clamp.
- 7** Screw out the cap from the outer tube. Remove the damper and spring from the fork. Remove the fork from the vice.
- 8** Check the locknut; if it is removed when the damper is opened, it is impossible to rebuild the damper. Counterhold the damper and screw out the fork cap. Pour the oil out of the damper. Hold the damper upside down and pump out all the oil.
- 9** Fill the damper with HYPERPRO fork oil of the specified viscosity (Frontpage: **HYPERPRO OIL**)
Compress and decompress the damper slowly to remove all the air from the damper (± 10 to 20 times)
Pull out the damper to the maximum length. Fill the damper until the oil is 5 to 10 mm above the edge in the damper (picture)
- 10** Fit the cap in the damper. If it is difficult to fit the cap, there might be too much oil in the damper. Counterhold the damper and tighten the screwcap (29 Nm)
- 11** Hold the damper straight up and pump the rod 100 mm in and out slowly a few times.
Cover the damper rod end with a piece of cloth to prevent damage. Pump the damper full stroke to remove excess oil from the damper. Be careful not to bend or damage the damper.
- 12** Drain oil trough the oil hole in the damper. Blow out the excess oil out of the damper spring chamber with compressed air through the oil hole.
It is also possible to remove the pressure release screw and let the excess oil drain from the damper (let it rest upside down ± 10 min)
- 13** Compress the damper. Let the damper extend by itself. If the damper does not extend to full length, bleed the damper again.
Check the damper for oil leakage.

- 14 Inspect all the parts for their condition. Broken parts and/or leaking seals should be replaced. If an oil seal is replaced, be sure to also check the inner tube for damage. Clean all the parts before reassembly.
- 15 Screw the locknut tight on the rod. Measure the thread length; this should be 15 – 17 mm.
- 16 Fit the HYPERPRO spring in the fork, usually the progressive side is mounted up. Sometimes there is a sticker marking this side up or there is a remark on the frontpage.
- 17 Mount the damper in the fork. Place the fork with the axle clamp in a vice. Use soft jaws or wood to protect the fork. Don't overtighten the vice to prevent damage. Temporarily screw the damper in the outer tube. Push the fork and damper until the rod is out the axle clamp. Use special tool A between the axle clamp and locknut.



- 18 Fit the damping adjustment rod in the damper rod. Screw the damper bolt completely onto the damper rod. Hand screw the locknut against the damper bolt. Secure the damper bolt with the locknut (22 Nm)
- 19 Push the fork together and remove special tool A from the fork. Screw the damper bolt in the fork and tighten it (69 Nm)

- 20 Loosen the damper from the outer tube. Fully compress the fork and fill it with HYPERPRO fork oil of the right viscosity (see frontpage: **HYPERPRO OIL**) until about 200 mm under the edge.
Pump out all the air of the fork by compressing and decompressing the outer tube (± 10 to 20 times)



- 21 Measure the oil level (air chamber): Compress the fork fully. Hold the fork straight up. Use a tape measure; slide it in until it just lightly touches the oil in the fork. Hold it against the upper edge of the tube.

The oil level is the distance between the top of the tube and the oil.
 Add or remove oil until the setting on the frontpage is reached (see: **OIL LEVEL**)

- 22 Screw the screwcap and damper in the fork. Use some grease on the thread to prevent scoring.
- 23 Set the spring preload (if available) as specified on the frontpage (see: **SPRING PRELOAD**)

Set the damping settings as specified on the frontpage (**REBOUND & COMPRESSION**)
 The rebound setting is located at the bottom of the fork. The compression setting is located at the top of the fork.
 Clicks or turns are counted from the maximum setting out. Turn the screw clockwise to the maximum. Turn the screw counter clockwise the number of clicks or turns as specified on the frontpage.

- 24** HYPERPRO fork lubricant reduces the friction of the front fork. Prise off the dust seals from the outer tube of the fork. Put the grease on the inner tube of the fork. Move the fork up and down. Repeat this.

Put some grease on the dust seals to make them slide in more easily. Refit the dust seals and remove the excess grease.

- 25** Fit the fork on the bike. Mount the fork at the distance as measured at step 1; **Unless there is a remark on the frontpage** Make sure everything is tightened to the correct torque setting.

- 26** Loosen the clamping bolt(s) on the fork axle clamp.

Push the front fork a few times as deep as possible to let the fork settle in the position with the least friction.

Tighten the front axle bolt(s)



Mounting type 1: Mono shock

- 1** Place the bike stable, with the rear wheel off the ground. Don't use a stand which supports the swingarm, as there is still weight on the rear suspension.
Note: for telelever front ends this procedure is the same for the front.
- 2** Remove the seat and fairing if necessary. Remove the nuts from the shock absorber retaining bolts (1 & 2)

If the shock has an external reservoir with a tube, the shock has to be removed with the reservoir; it must not be detached from the shock. Remove the bolt(s) holding the external reservoir to the bike.
Shocks with hydraulic preload sometimes have a remote adjustment. The adjuster must be removed with the shock, don't detach it, as the hydraulic fluid would leak out. Remove the bolt(s) which hold the adjuster to the bike.

- 3** Hold the rear wheel to remove the shock bolts. Remove the bolts and the shock from the bike.
- 4** Exchange the original spring for the HYPERPRO spring (view a different section of this manual)
- 5** Mount bolt (1) and the shock absorber in place. Hold the rear wheel and shock in place to fit bolt (2)
Tighten the nuts. Bolt on the remote reservoir and/or preload adjuster. Remount the seat and fairing.

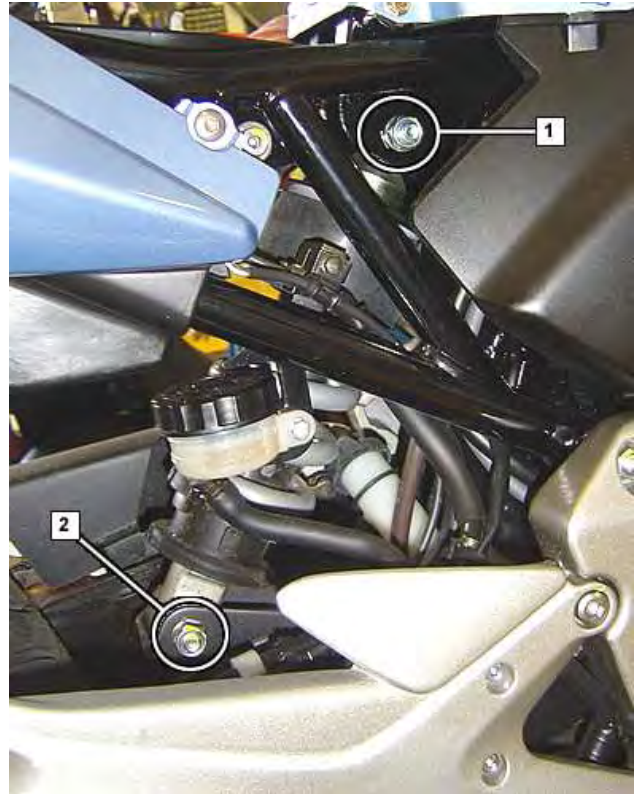

Mounting type 2: Twin shock

- 1 Place the bike stable, with the rear wheel off the ground. Don't use a stand which supports the swingarm, as there is still weight on the rear suspension.
- 2 Screw out the bolts (1 & 2) of the shocks. Hold the rear wheel in place to remove the bolts more easily. Remove the shocks from the bike.

If the shock has an external reservoir with a tube, the shock has to be removed with the reservoir; it must not be detached from the shock. Remove the bolt(s) holding the external reservoir to the bike. Shocks with hydraulic preload sometimes have a remote adjustment. The adjuster must be removed with the shock, don't detach it, as the hydraulic fluid would leak out. Remove the bolt(s) which hold the adjuster to the bike.

- 3 Exchange the original springs for the HYPERPRO springs (view a different section of this manual)
- 4 Hold the shock absorbers to the bike with bolt (1) Hold the rear wheel up a little to fit bolt (2) Tighten all the bolts to the correct torque setting. Bolt on the remote reservoir and/or preload adjuster.

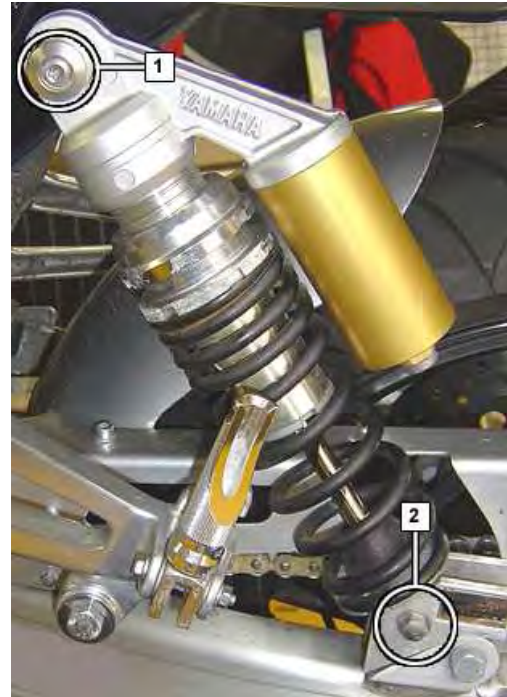

Mounting type 3: Link system

- 1 Place the bike stable, with the rear wheel off the ground. Don't use a stand which supports the swingarm, as there is still weight on the rear suspension.
- 2 Remove the seat and fairing if necessary to reach the bolts.
- 3 If the shock has an external reservoir with a tube, the shock has to be removed with the reservoir; it must not be detached from the shock. Remove the bolt(s) holding the external reservoir to the bike.
Shocks with hydraulic preload sometimes have a remote adjuster. The adjuster must be removed with the shock, don't detach it, as the hydraulic fluid would leak out. Remove the bolt(s) which hold the adjuster to the bike.
- 4 For links with straight link plates (A):
Screw out bolts 3 & 5 to remove the link plates (6) If this does not create enough space to remove the shock absorber, also remove the link (7) Remove the bolts from the shock (1 & 4) Hold the rear wheel in place while you do this. Mostly some movement of the swingarm is necessary for disassembly.

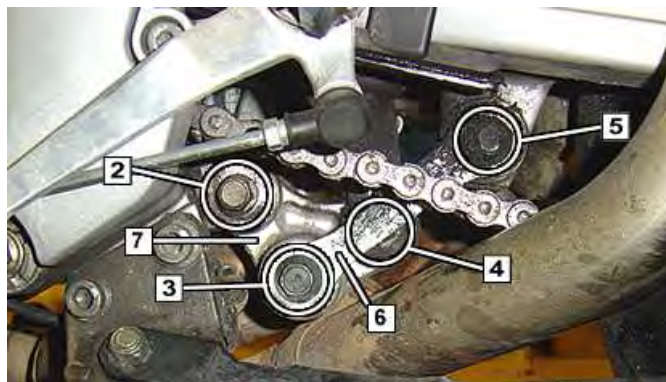

Detail A

For links with triangular link plates (B):
The most easy way is usually to remove the link plates (8) Screw out bolts 2, 3 & 4
Sometimes removing the bolt from the shock (4) and removing one of the link bolts (2 & 3) creates enough space to move out the shock. Remove the upper shock bolt (1) Hold the rear wheel in place in order to remove the bolts.

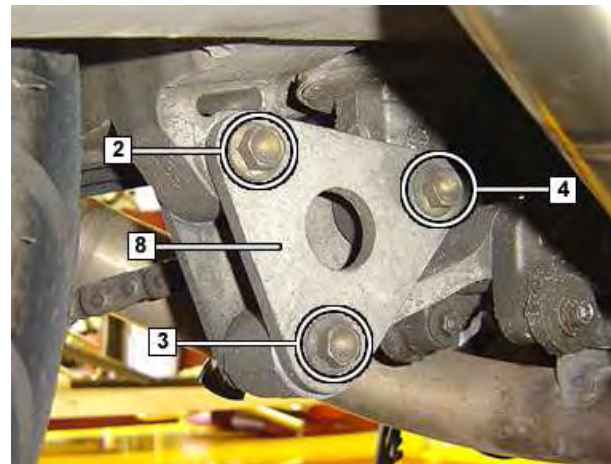

Detail B

Note how the link plates (8) are fitted on the bike. There sometimes are markings i.e. arrows pointing in the driving direction, check your bike manual for details. Wrong assembly upsets the handling of the bike!



-
- 5** Move the shock out off the swingarm. Depending on the bike this is possible through the upper or lower side of the swingarm. Sometimes the wheel needs to be lifted to create enough space (i.e. to move out the shock through the bottom)
 - 6** Exchange the original spring for the HYPERPRO spring (view a different section of this manual)
 - 7** Check the condition of the linkage parts. Regrease the bearings if needed. Check the bearings for damage, if they are worn out; replace them.
 - 8** Move the shock into the swingarm. Place the upper bolt (1) through the hole, holding the shock absorber in place.
 - 9** Links with straight link plates (A):
Bolt the link (7) back to the bike with bolt 2 Move the shock and link in place so bottom shock bolt (4) can be placed through the hole. Bolt the link plates (6) to the bike with only one of the bolts (3 or 5) Move the rear wheel up or down to make the link and linkage arms align. Put the other bolt through the hole.

Links with triangular plates (B):
Place the plates (8) on the bike with two of the three bolts (2, 3 & 4) Move the rear wheel up or down to make the last parts align. Place the last bolt through the hole.
 - 10** Tighten all the nuts and bolts to the correct torque setting. Make sure the linkage is assembled correctly. Bolt on the remote reservoir and/or preload adjuster. Remount the fairing and seat.

Shock type 1: Cam collar adjustable preload shock

- 1 Remove the shock absorber from the bike (view a different section of this manual)
- 2 Remove the spring from the damper with the spring (de)mounting tool. Make sure only the spring and nothing else will be compressed. Set the plates against, but not over, the clip(s) on the spring. Make sure the shock is placed stable, with no possibility of jumping out. Compress the spring and remove the retaining clip(s) Decompress the spring.

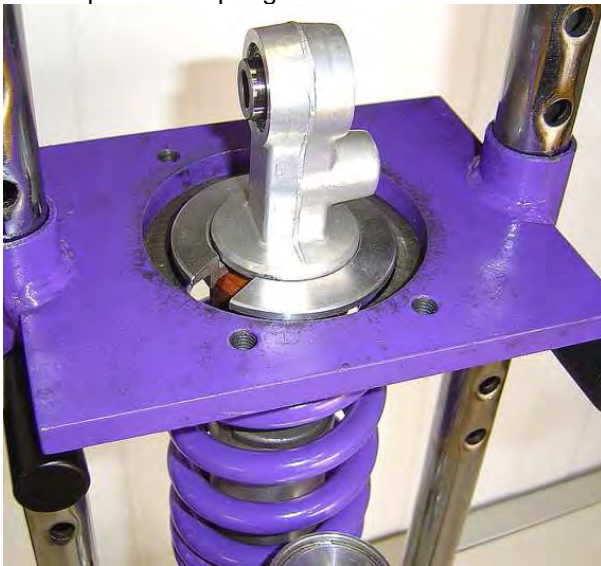

- 3 Check the parts for their condition. A leaking shock should be fixed.

Some shocks have an external reservoir. Never remove or open a reservoir; as this causes the damper to depressurise.

Note some shocks have a screw on the opposite side of the rebound screw on the fork. Removing this screw also depressurizes the damper.

- 4 Set the preload collar to the correct position (View frontpage: **SPRING PRELOAD**)

The positions are always counted from the lowest preload setting (longest possible spring length on the shock) to the highest setting (i.e. the picture shows position 2)
 Sometimes there is a clipping system, with a clipping (3) a camring (2) which holds the cam collar (1) in place. The notches for the cam collar are mounted inside the camring (2)
 The settings are counted from the lowest preload (rings fully right in the picture) to the highest setting (left in the picture)



There are shocks with two main springs and two settings (soft & hard)

Remove the springs with the adjustment mechanism. The adjustment mechanism will not be reused; the two springs are replaced by one spring. The original spring seat with adjustment ring must remain on the shock (picture) although the adjustment ring will not adjust the shock any more.



- 5** Mount the HYPERPRO spring on the damper. View the frontpage for the mounting direction. Usually the progressive side (circle) is mounted upwards. Compress the spring and place the retaining clip(s) on the shock. Decompress the spring. Make sure the bolt holes are in line. One side of the shock can usually be slid over the workbench, use a screwdriver through the other side to twist the parts in line. Otherwise put a screwdriver through each hole of the shock to twist the holes in the correct position.



- 6** Set the damping adjustment (if available) according to the settings as specified on the frontpage (**REBOUND & COMPRESSION**)

The rebound screw (1) is usually located at the rod of the shock. Sometimes there is a ring which must be turned around the damper rod. The compression adjustment screw (2) is usually located at the external reservoir.

Turn the adjustment screws clockwise to the maximum. Turn the screws out (counter clockwise) the number of clicks or turns as specified on the frontpage.

- 7** Mount the shock absorber on the bike (view a different section of this manual)



Shock type 2: Threaded ring adjustable preload shock

- 1 Remove the shock absorber from the bike (view a different section of this manual)
- 2 Remove the spring from the damper with the spring (de)mounting tool. Make sure only the spring and nothing else will be compressed. Set the plates against, but not over, the clip(s) on the spring. Make sure the shock is placed stable, with no possibility of jumping out. Compress the spring and remove the retaining clip(s)

Decompress the spring.



- 3 Check the parts for their condition. Leakage should be fixed.

Some shocks have an external reservoir. Never remove or open a reservoir; as this causes the damper to depressurise. Note some shocks have a screw on the opposite side of the rebound screw on the fork. Removing this screw also depressurizes the damper.



- 4 Measure the unsprung length of the HYPERPRO spring before mounting.
- 5 Screw the spring preload ring to the correct setting. Sometimes a locking screw has to be loosened before this can be done, else there are two rings.

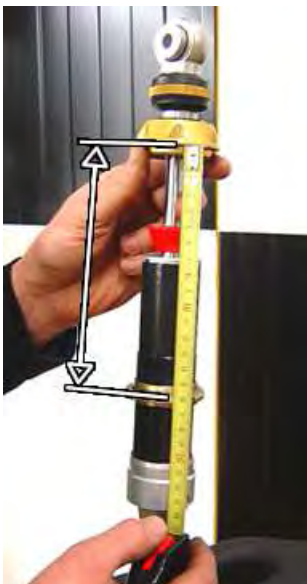

The length of the spring mounted on the shock should be “unsprung length” – “preload length” (view frontpage: **SPRING PRELOAD**)

Be sure to measure from the seating of the spring on the preload ring to the spring seating on the retaining clip(s)

Pull the damper out far enough; there is usually a rebound spring which affects the length.

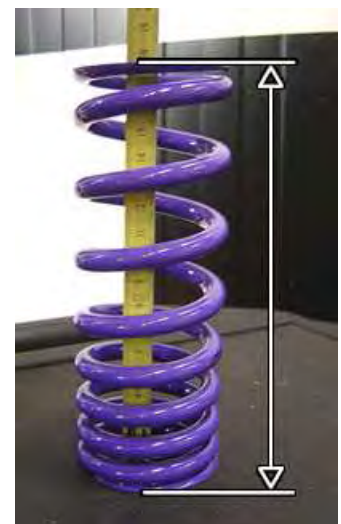

6 Mount the HYPERPRO spring on the damper. View the frontpage for the mounting direction. Usually the progressive side (circle) is mounted upwards. Compress the spring on the damper and place the clip(s) in place. Decompress the spring. Make sure the bolt holes are in line. One side of the shock can usually be slid over the workbench, use a screwdriver through the other side to twist the parts in line. Otherwise put a screwdriver through each hole of the shock to twist the holes in the correct position.



7 Remeasure the length of the spring; to be sure the preload is correct. The rebound spring could have affected the shock length measured at step (5) The preload can be adjusted with the spring fitted. When the preload is correct, make sure the ring is locked in place, it must not move any more. The two rings are turned against each other or a locking screw is tightened.

8 Set the damping settings (if available)

The rebound setting screw (1) is usually located at the bottom of the damper rod of the shock absorber. Sometimes there is a ring which must be turned around the damper rod. The compression setting screw (2) is located at the external reservoir of the shock absorber.

Turn the adjustment screws clockwise to the maximum setting. Turn the screws counter clockwise the number of clicks or turns specified on the frontpage (view: **REBOUND & COMPRESSION**)

9 Mount the shock absorber on the bike (view a different section of this manual)



Shock type 3: Hydraulic adjustable preload shock

- 1 Remove the shock absorber from the bike (view a different section of this manual)
- 2 For removing the spring from the damper, a spring (de)mounting tool is used. Make sure only the spring and nothing else will be compressed, preventing damage to the shock. Be sure to place the shock in the tool correctly, else it could bounce out, causing serious injury. Setting the preload to a minimum makes spring removal more easy. Don't adjust the preload when the spring is removed!

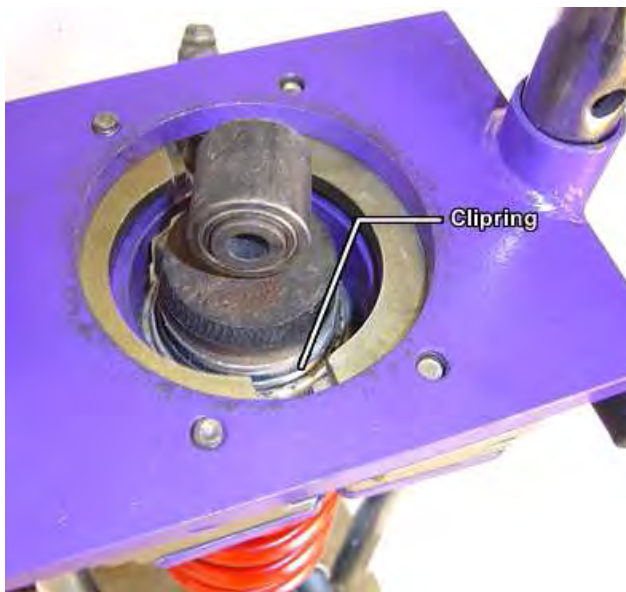

- 3 There are two possibilities for removing the spring (dependent on the shock):

Some shocks have clips on one side (circle; the opposite side of the preload adjuster) Set up the (de)mounting tool

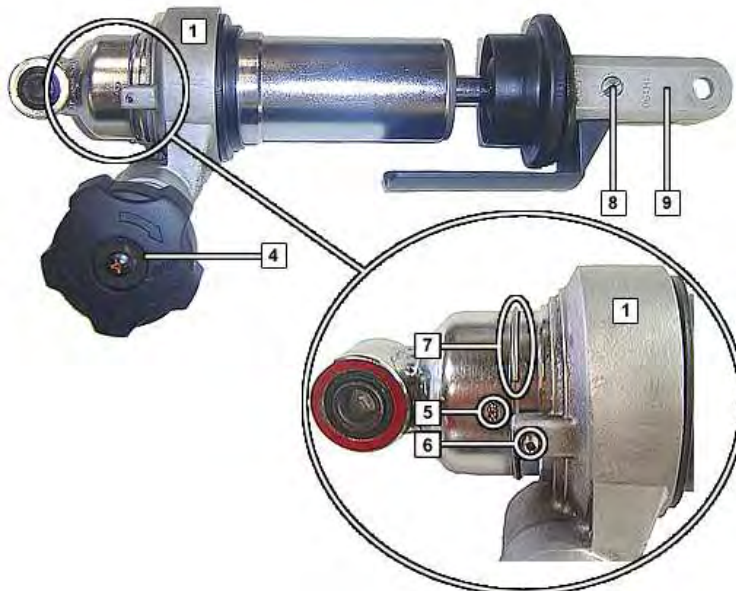
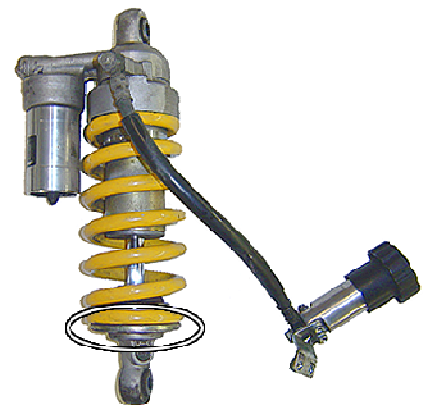

against the clips so only the spring will be compressed, don't press the clips onto the shock. Compress the spring, remove the clips from the shock and then decompress the spring. Other shocks have a hydraulic preload adjuster which is held by a clipping. Loosen the securing screw (6) on the preload adjuster (1) Compress the spring using the (de)mounting tool on the preload adjuster. The spring and preload adjuster are compressed. Remove the clipping (7), then decompress the spring. Note the alignment (5) for the screw (6) on the shock.

- 4 Check the parts for their condition. A leaking shock should be fixed.

Some shocks have an external reservoir. Never remove or open a reservoir; as this causes the damper to depressurise. Removing screw (8) or the fork (9) will also depressurize the damper!

- 5 Mount the HYPERPRO spring on the damper. View the frontpage for the mounting direction. Usually the progressive side (circle) is mounted upwards. Compress the spring and place the retaining clip(s) on the shock. Decompress the spring. Make sure the bolt holes are in line. One side of the shock can usually be slid over the workbench, use a screwdriver



through the other side to twist the parts in line. Otherwise put a screwdriver through each hole of the shock to twist the holes in the correct position.

If the spring was removed with the preload adjuster, tighten the securing screw (6) in place when the preload adjuster is in the correct position. The securing screw should align with the mark (5)

- 6 Set the preload adjustment to the correct setting. Turn the knob (4) clockwise to the maximum setting, then turn it counter clockwise the number of clicks or turns as specified on the frontpage (view: **SPRING PRELOAD**)

- 7 Set the damping settings (if available) according to the frontpage (view: **REBOUND & COMPRESSION**) Turn the screw clockwise to the maximum setting. Then turn it counter clockwise the number of clicks or turns specified on the frontpage.

The compression setting (3) is located at the external reservoir. The rebound screw (2) is located on the bottom of the rod of the shock, sometimes there is a ring which must be turned around the damper rod. Note some shocks have another screw (8) on the opposite side of the fork (9) Use the correct screw; there is a marking "Tension" or "Ten" near the screw.



- 8 Mount the shock on the bike (view a different section of this manual)

Shock type 4: Pull shock

- 1 Remove the shock absorber from the bike (view a different section of this manual)
- 2 Compress the spring using the spring (de)mounting tool as picture A. Compress until clip (10) is visible. Remove clip (10) from inside the shell (3) Decompress the spring.
- 3 Compress the spring as picture B, **be careful not to compress too far as this damages the shock**. Compress until clipping (9) is visible. Remove clip (9) from the shock.
- 4 Screw loose the retaining nut (7) while counter holding the retaining clip (8) Remove the clip/preload adjuster (8) and ring (4) followed by the spring. Note the mounting order of the parts.
- 5 Check the parts for their condition. A leaking shock should be fixed.

Some shocks have an external reservoir. Never remove or open a reservoir; as this causes the damper to depressurise. Removing the screw on the opposite side of the compression adjustment or the fork (6) will also depressurize the damper!

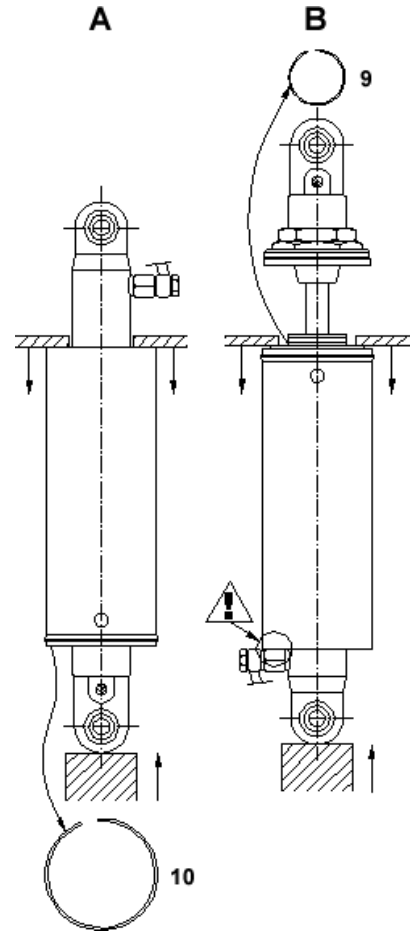

- 6 Fit the HYPERPRO spring in the shell. Place the spring retaining ring (4) on the spring. Compress the spring as picture B until the groove for the clipping is visible on the shock body. Fit clipping (9) on the damper. Decompress the spring. Place the preload adjusting clip (8) on the damper.



- 7** Measure the spring preload with the damper fully compressed. Adjust the preload to the setting as specified on the frontpage (view **PRELOAD**) Note the preload adjustment for pull shocks is done opposite to normal shocks (picture)

Turn clip (8) until the specified preload setting is reached.
Hold the preload clip (8) in place and tighten nut (7) to lock it in place.

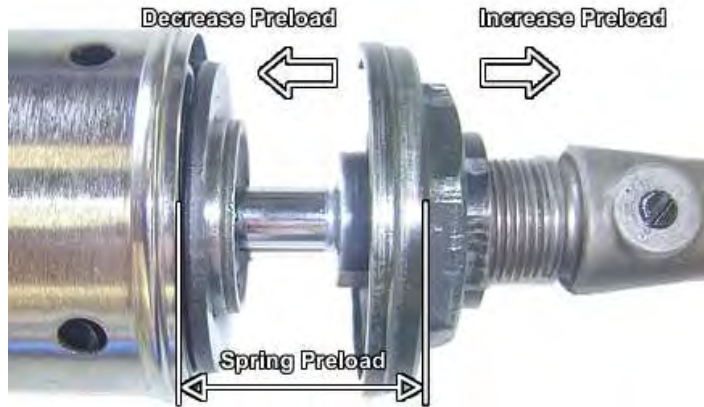

- 8** Compress the spring as picture A until clip (8) falls under the edge of the shell (3) Place clipring (10) inside the groove in the shell. Decompress the spring.

- 9** Make sure the bolt holes are in line. One side of the shock can usually be slid over the workbench, use a screwdriver through the other side to twist the parts in line. Otherwise put a screwdriver through each hole of the shock to twist the holes into the correct position.



- 10** Set the damping settings as specified on the frontpage (view **REBOUND & COMPRESSION**)

The rebound setting can usually be found at the external reservoir. The compression setting (2) is normally located at the bottom of the pull shock, on the fork (6)

Turn the screws clockwise to the maximum setting. Then turn the screws counter clockwise the number of clicks or turns as specified on the frontpage.

- 11** Mount the shock on the bike (view a different section of this manual)



Setup 1: Maintenance, things to check first

- 1** Before there are any adjustments made to the suspension settings, be sure everything else is in a good working order using the following steps. Look up the details and settings in your motorcycle manual.
Handling problems do not only occur when the suspension is set up wrong. Setting up the suspension is useless when the rest of the bike is bad!
- 2** Check the tires. Wrong tire pressure causes various handling problems; it should be checked regularly to insure good handling. The tire manufacturer can provide the information for your tires. Check the tires for any unusual wear, damage, leaks and correct thread depth. If the tyres are worn out or otherwise bad, replace them.
- 3** Check the front suspension. Place the bike stable with the front wheel off the ground. Make sure there is no weight resting on the front suspension.
Grab the forks near the front axle. Try to push them front and back, there should be no play between the steering head and the forks. Also notice if there is play in the forks, there should be little play between the inner and outer tube. If there is play, it is likely the fork bushings are worn out; the fork should be rebuild.
The steering stem can be tightened to set the play. Too tight and the steering becomes heavy. If there is play with a tight steering stem, check the steering head bearings as they're probably worn out, replace them if necessary.
Steer the bike. If the movement is not smooth and/or nothciness is felt, the steering head bearings should be checked and if worn out they should be replaced.
Check the suspension for leaking seals.
- 4** Check the rear suspension. Place the bike stable with the rear wheel off the ground. Don't use a stand which supports the swingarm, as there is still weight on the rear suspension.
Try to move the swingarm from side to side. There should be little play between the swingarm and the rest of the bike. If there is play the swingarm bearings should be checked and if worn out they should be replaced.
Try to move the swingarm up and down. Feel for play between the swingarm, the frame and the shock bearings. If there is play, the bearings of the swingarm and/or the shock are probably worn out.
Check the suspension for leaking seals.
- 5** Check the chain. Make sure the freeplay is adjusted correctly.
Clean and lubricate the chain if necessary. The lubricant penetrates best when the chain is warm, just after riding the bike.
Tip: lubricate the chain after driving in the rain as the lubricant can be washed off by the rain.
Make sure the wheel and sprockets are aligned properly. There are usually measuring stripes on the swingarm, for the alignment of the rear wheel when the chain freeplay is adjusted.
If any chain links are damaged, worn out, do not move smooth and/or the sprockets are worn out, the chain and sprockets should be replaced.
- 6** Check the wheels. Make the wheels spin. If a wheel doesn't move smooth or has a lot of drag, check for brake drag.
If a wheel has play in the mounting (the wheel can move sideways while the axle is tightened) the bearings are probably worn out; replace them if necessary. If there still are a lot of vibrations during driving, check the balancing of the wheels.
- 7** Check the wheel alignment; if the wheels are not aligned properly the bike tends to steer to one side. This is also the case when the frame is not straight; if your bike has been in a crash it is possibly bent.
- 8** If your bike is not in a good working order, visit a qualified motorcycle mechanic for service.

Setup 2: Static Sag measurement and adjustment

1 Right side up front fork:

Measure the fork length between the lower fork clamp and the top of the dust seal.

Upside down front fork:



Measure the fork length between the top of the axle clamp and the bottom of the dust seal.

Measure the following situations:

A: The front wheel is off the ground, no weight rests on the front suspension.

B: The bike stands on both wheels, on a flat surface without rider. Pull up the front of the bike and let it come down on its own weight slowly, don't push!

C: The bike stands on both wheels, on a flat surface without rider. Push the front of the bike down and let it come up slowly, slow down the movement a little. Don't let the bike bounce!



$$A - \left(\frac{B + C}{2} \right) \text{ is the } \textbf{STATIC SAG}$$

2 Rear suspension:

Measure the length of the swingarm (L) Use a piece of tape to mark a point at the same distance (L) from the swingarm front bolt to the fairing.

Measure the distance from the rear axle to the point when:

A: The rear wheel is off the ground, no weight rests on the rear suspension.

B: The bike is on both wheels, on a flat surface without rider. Lift the rear end of the bike and let it come down under its own weight slowly, don't push!

C: The bike stands on both wheels, on a flat surface without rider. Push the rear of the bike down let it come up slowly, don't let it bounce!

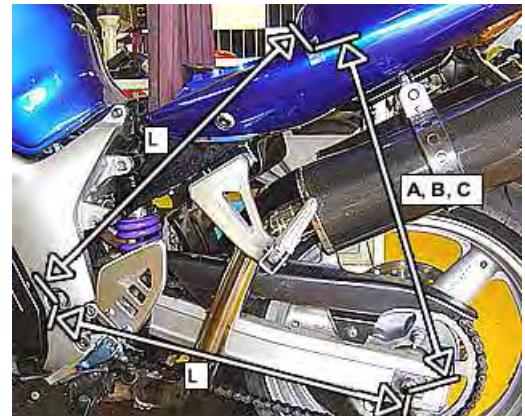

$$A - \left(\frac{B + C}{2} \right) \text{ is the } \textbf{STATIC SAG}$$

Note: Be sure to use tape that doesn't damage the fairing.

- 3** The static sag can be adjusted with the preload setting (if available) For less static sag, apply more spring preload. For more static sag apply less spring preload. Adjust the preload if needed to create the **STATIC SAG** specified on the frontpage. At the rear suspension special tools are usually needed for this. Front: less rings indicates more preload (unless there is a **remark** on the **frontpage**: reversed preload) Rear: view the shock manual for the preload indication.



- 4** Under heavy loads (i.e. with a passenger and luggage for a vacation) the sag increases (the bike is pushed to the ground more) It is possible to apply more preload to compensate this.



Setup 3: Damping setup

- 1** The damping only adjusts the speed of the suspension movement, not the spring force. The suspension will eventually move the same distance when the applied force is the same for long enough, independent of the damping settings. The damping settings only change the time it takes to get there.
- 2** The settings recommended by HYPERPRO can be found on the frontpage (view: **REBOUND & COMPRESSION**)
The HYPERPRO recommended settings are average settings for normal use. It is possible to adjust the suspension to your personal preference and driving style.
- 3** To set the suspension up properly, test drive the bike every time something is changed. Test drive the bike according to your normal driving conditions and driving style.
Always drive safely and don't take unnecessary risks! If you change the suspension settings, the bike feels and handles different. Avoid driving in heavy traffic because it can be dangerous when the bike handles different. Make only small changes to one setting at a time.
- 4** Check the current setting and write it down. Turn the damping screws to the maximum (clockwise) counting the number of clicks or turns while doing so. Clicks or turns are always counted from the maximum setting outwards (counter clockwise)
First check the overall condition of the bike and make sure the static sag is adjusted properly before setting up the damping.

Make notes while setting up your suspension. Note the changes and the effect of the changes. Change only one setting at a time as this also gives only one effect at a time. The left & right fork (and left & right twin shocks) should be set the same, else the bike becomes unstable (there are exceptions; check the frontpage to be sure)

- 5** A lot of damping makes the bike feel very hard/firm and it feels reasonably controlled on smooth roads, especially with much rebound damping. The bike feels harsh and uncomfortable and it skips or kicks up over bumps in bad roads.
Little damping makes the bike feel vague, with little feel of traction and control. The bike is very soft and comfortable over bumps, though it wallows around and can feel unstable when damping is too little.

Damping settings (rebound & compression) can affect each other slightly in some forks and shocks. I.e. a big increase in fork compression damping can also give an increase in fork rebound damping. The dependence affects all the parts separately; left and right forks and shocks can not affect each other obviously as the damping oil is separated.

- 6 The rebound setting** adjusts the speed with which the suspension extends to the normal ride height after going over a bump or when releasing the brake. Turn the screw clockwise for more damping (slower) and turn counter clockwise for less damping (faster) Rebound damping is also sometimes referred to as tension damping (“ten”)

Front:

Too much rebound damping can make the fork pack down; the bike does not return fast enough to the standard ride height after being compressed and gets lower and lower over a series of bumps. The front sits low and the bike tends to oversteer (drives towards the inside) in long fast corners and it sits up in slow corners. While accelerating, the front can tank slap because the front wheel loses traction.

Too much rebound damping makes the front feel locked up and harsh, feel of control is lost.

Too little rebound makes the fork shoot up when the brake is released. The suspension extends too fast when entering a corner, causing understeer in fast corners and falling down to the inside in slow corners. The front feels vague and gives little feedback.



Rear:

Too much rebound damping can make the rear pack down; the bike sits low at the rear and runs wide going out of long corners. The rear feels locked up and harsh. The bike sometimes kicks over bumps. The rear tire has bad traction, because the suspension doesn't allow the rear wheel to follow the road surface properly.

The rear wheel bounces or hops uncomfortably over the ground during hard braking; it has some road contact and it's easy to hold a straight line.

Too little rebound damping can make the bike wallow in a corner and over bumps. The rear can feel less controlled; it acts like a pogo stick. During hard braking the rear wheel has little traction and feels like it slides over the ground; it feels like the bike wants to pivot around the front. It's difficult to hold the bike in a straight line during braking.



General rebound setup:

With the compression screwed completely out (counter clockwise, until the minimum is reached) compress the suspension as much as possible and note how it comes back up.

Front: Increase the rebound damping until the suspension comes up with a smooth movement. It shouldn't move too fast (shoot up) and only bounce once; come up and topping out, move back down to the static sag height and stop.

Rear: Increase the rebound damping until the rear comes up in one smooth movement. It should move as fast upwards as possible, without shooting over the static sag level. Push the rear, the bike comes back up. It should move with your hands, you shouldn't be able to lift your hands from the bike and the bike shouldn't be able to push your hands upwards.

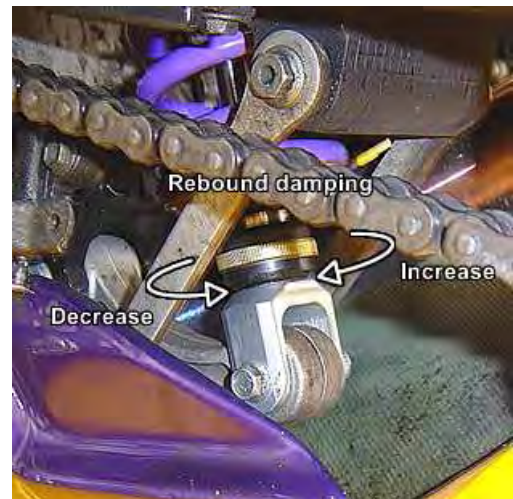

7 The compression setting adjusts the speed with which the suspension is pushed together when hitting a bump or braking hard. Turn the screw clockwise for more damping (slower) and turn counter clockwise for less damping (faster) Compression damping is also sometimes referred to as bump damping.

Front:

Too much compression damping can make the fork compress too slow, resulting in slow steering into fast corners. Much compression damping can feel good during hard braking although the front feels very harsh over bumps, sometimes even kicking up. The front can shake and most bumps are felt directly through the handlebars.

Too little compression damping can make the fork dive much too fast during braking. The bike does not feel controlled when braking hard and over bumps. The bike oversteers (steers too fast) into corners. While braking hard the rear wheel can lose traction.



Rear:

Too much compression damping can make the rear feel very hard. The rear of the bike can kick up over bumps and most bumps are felt directly through the chassis. With too much compression damping the rear wheel can lose traction and slide while accelerating hard; the rear tire will overheat.

Too little compression damping can make the rear compress too fast when accelerating. The bike squats, causing understeer, the bike runs wide when accelerating hard out of fast corners. Sometimes the rear compresses so fast it results in tank slapping due to loss of traction at the front tire.



General compression setup:

Use as little compression damping as possible. The major part of the suspension force should be absorbed by the spring, with the damping as speed restriction. If the suspension compresses too fast increase the compression damping. Reduce the compression damping when the suspension compresses too slow, the bike feels harsh and bumps are directly passed through the frame to the rider.

8 High speed & low speed:

Sometimes there are high speed and low speed damping settings (usually compression damping) High speed and low speed indicate the speed of suspension movement, not the driving speed of the motorcycle.

High speed damping damps out high speed suspension movements; i.e. hitting a big bump in the road. On a bump the suspension has to move very fast to absorb it. Don't use a lot of damping as this causes harshness, the wheel must be able to follow the road surface in order to maintain traction.

Low speed damping damps out low speed suspension movements; i.e. front compression during braking or rear compression during accelerating. Normally there is more low speed damping necessary than high speed damping. Low speed adjustments usually also affect the high speed adjustment; if the low speed damping is increased, the high speed damping is also increased.





The shape of the bump and the speed with which the bump is taken are the biggest influence for the speed with which the suspension must compress in order to make the tire follow the road surface. A sharp edged bump creates a higher suspension compressing speed than a rounded bump of the same height.

If the bike is harsh over bumps: decrease the high speed compression damping. If the bike dives too fast under braking: increase front low speed compression. If the rear squats too fast under acceleration: increase rear low speed compression. Rebound usually has one setting (no high or low speed) because the bike rebounds under the force of the spring; this isn't dependent on road conditions.

9 Front and rear balance:

There must also be a balance between front and rear. Hold the bike when it is on both wheels. Push in the centre of the bike (seat or tank) and notice how it sags and comes back up.

Front and rear should compress and rebound at roughly the same rate. The suspension travel should be about the same distance front and rear.

The suspension can move a bit faster at the front, although the difference must not be too great as that would result in wallowing (weave/wobble) and unstable handling behaviour through corners.

10 Find an optimum setting that suits your driving style. Experiment by increasing or decreasing the damping to give the bike the desired handling behaviour. Use your own notes and experience to get a good feeling for the handling of your bike.

Increase or decrease the damping with no more than a few clicks at a time; else there is too much difference in damping.

For racing or duo riding there usually is some more damping needed than under normal conditions, in order to absorb the higher forces. Turn the adjustment screws a few clicks clockwise to increase the damping. Duo riding and/or holiday luggage affect the shock more than the fork, as the weight rests more at the rear of the bike, so the damping increase for the shock should usually be larger. Racing affects the front as much as the rear.



Setup 4: Handling problems and possible solutions

Suspension parameter ► Handling problem ▼	Front preload	Front rebound	Front compression	Rear preload	Rear rebound	Rear compression	Ride height / geometry	Notes
Long fast corners: Bike runs wide (understeered) Bike sits up	Decrease	Increase	Decrease	Increase	Decrease	Increase	Lower front / raise rear	Front end rides high through the corner (multiple possible causes)
Long fast corners: Bike runs narrow (oversteered) Bike falls down	Increase	Decrease	Increase	Decrease	Increase	Decrease	Raise front / lower rear	Front end rides low through the corner (multiple possible causes)
Short slow corners: Bike falls down to the inside (oversteered)	Decrease	Increase	Decrease	Increase	Decrease	Increase	Lower front / raise rear	Front end rides high through the corner (multiple possible causes)
Short slow corners: Bike sits up while turning (understeered)	Increase	Decrease	Increase	Decrease	Increase	Decrease	Raise front / lower rear	Front end rides low through the corner (multiple possible causes)
Front dives too fast when braking hard, doesn't bottom out			Increase					Bike usually also oversteers in fast corners, steers into corners too easily (falls in)
Front shoots up too fast after braking, turning into corners is difficult		Increase						Bike usually also oversteers in fast corners
Rear squats fast under acceleration				2 Slightly increase		1 Increase		Bike usually understeers when accelerating out of long corners
Rear wheel loses road contact (traction) under hard braking	3 Increase		2 Increase	4 Decrease	1 Increase			It feels like the rear pivots around the front wheel, also a lot of dive during braking
Tank slapping / front end shake at high speeds and fast acceleration (wobble)		2 Decrease			3 increase	1 Increase	4 Lower front / raise rear	Loss of front tire traction. A steering damper can reduce the unstable feel
Wallowing / weave in mid corner (long, fast corners)		2 Increase	4 Increase		1 Increase	3 Increase		A steering damper can reduce the unstable feel
Over a series of bumps or ripples the bike packs down, there is no more travel to absorb bumps		If the front packs down; decrease (oversteered in fast corners)			If the rear packs down; decrease (understeered in fast corners)			There is too much damping for the suspension to return fast enough to the normal ride height, ride is harsh
Bike feels too harsh over bumps, suspension feels "locked up" over bumps, the bumps are felt directly through the frame			If the front is harsh; decrease			If the rear is harsh; decrease		Harshness is felt when the bike kicks up or skips over bumps. Locked up and harsh feel can also be caused by packing down!

The numbers resemble the likeliness of the solution (1 is most likely)

Make sure the bike is in a good state of maintenance using setup chapter one as many handling problems are caused by bad maintenance.

Make sure the static sag is adjusted properly using setup chapter two.

Ride height/geometry is adjusted with: ride height adjuster on shock, link plate dimensions and fork distance from the top of the tubes to the fork clamp; not the spring preload.

Note this only indicates the most common problems with the most likely solutions. Many handling problems are complicated; please contact HYPERPRO if your problem isn't in the chart above.



Setup 5: Standard torque settings for bolts

Size	Strength class		
	8.8	10.9	12.9
	Torque [Nm]		
M4	3,2	5	6
M5	6,4	9	11
M6	11	16	19
M8	27	39	46
M10	53	78	91
M12	92	135	155
M16	230	335	390
M20	460	660	770
M24	790	1150	1300
M30	1600	2250	2650
M36	2780	3910	4710
M42	4470	6290	7540