



Installation Instructions: S&S Standard and Easy Start Chain Drive Camshafts for Harley-Davidson® Twin Cam 88® Engines 1999–2006 Big Twin, except 2006 Dyna® models

DISCLAIMER:

S&S parts are designed for high performance, closed course, racing applications and are intended for the very experienced rider only. The installation of S&S parts may void or adversely affect your factory warranty. In addition such installation and use may violate certain federal, state, and local laws, rules and ordinances as well as other laws when used on motor vehicles used on public highways, especially in states where pollution laws may apply. Always check federal, state, and local laws before modifying your motorcycle. It is the sole and exclusive responsibility of the user to determine the suitability of the product for his or her use, and the user shall assume all legal, personal injury risk and liability and all other obligations, duties, and risks associated therewith.

The words Harley®, Harley-Davidson®, H-D®, Sportster®, Evolution®, and all H-D part numbers and model designations are used in reference only. S&S Cycle is not associated with Harley-Davidson, Inc.

SAFE INSTALLATION AND OPERATION RULES:

Before installing your new S&S part it is your responsibility to read and follow the installation and maintenance procedures in these instructions and follow the basic rules below for your personal safety.

- Gasoline is extremely flammable and explosive under certain conditions and toxic when breathed. Do not smoke. Perform installation in a well ventilated area away from open flames or sparks.
- If motorcycle has been running, wait until engine and exhaust pipes have cooled down to avoid getting burned before performing any installation steps.
- Before performing any installation steps disconnect battery to eliminate potential sparks and inadvertent engagement of starter while working on electrical components.
- Read instructions thoroughly and carefully so all procedures are completely understood before performing any installation steps. Contact S&S with any questions you may have if any steps are unclear or any abnormalities occur during installation or operation of motorcycle with a S&S part on it.
- Consult an appropriate service manual for your motorcycle for correct disassembly and reassembly procedures for any parts that need to be removed to facilitate installation.
- Use good judgment when performing installation and operating motorcycle. Good judgment begins with a clear head. Don't let alcohol, drugs or fatigue impair your judgment. Start installation when you are fresh.
- Be sure all federal, state and local laws are obeyed with the installation.
- For optimum performance and safety and to minimize potential damage to carb or other components, use all mounting hardware that is provided and follow all installation instructions.
- Motorcycle exhaust fumes are toxic and poisonous and must not be breathed. Run motorcycle in a well ventilated area where fumes can dissipate.

IMPORTANT NOTICE:

Statements in this instruction sheet preceded by the following words are of special significance.



WARNING

Means there is the possibility of injury to yourself or others.



CAUTION

Means there is the possibility of damage to the part or motorcycle.

NOTE

Other information of particular importance has been placed in italic type.

S&S recommends you take special notice of these items.

WARRANTY:

All S&S parts are guaranteed to the original purchaser to be free of manufacturing defects in materials and workmanship for a period of twelve (12) months from the date of purchase. Merchandise that fails to conform to these conditions will be repaired or replaced at S&S's option if the parts are returned to us by the purchaser within the 12 month warranty period or within 10 days thereafter.

In the event warranty service is required, the original purchaser must call or write S&S immediately with the problem. Some problems can be rectified by a telephone call and need no further course of action.

A part that is suspect of being defective must not be replaced by a Dealer without prior authorization from S&S. If it is deemed necessary for S&S to make an evaluation to determine whether the part was defective, a return authorization number must be obtained from S&S. The parts must be packaged properly so as to not cause further damage and be returned prepaid to S&S with a copy of the original invoice of purchase and a detailed letter outlining the nature of the problem, how the part was used and the circumstances at the time of failure. If after an evaluation has been made by S&S and the part was found to be defective, repair, replacement or refund will be granted.

ADDITIONAL WARRANTY PROVISIONS:

- (1) S&S shall have no obligation in the event an S&S part is modified by any other person or organization.
- (2) S&S shall have no obligation if an S&S part becomes defective in whole or in part as a result of improper installation, improper maintenance, improper use, abnormal operation, or any other misuse or mistreatment of the S&S part.
- (3) S&S shall not be liable for any consequential or incidental damages resulting from the failure of an S&S part, the breach of any warranties, the failure to deliver, delay in delivery, delivery in non-conforming condition, or for any other breach of contract or duty between S&S and a customer.
- (4) S&S parts are designed exclusively for use in Harley-Davidson® and other American v-twin motorcycles. S&S shall have no warranty or liability obligation if an S&S part is used in any other application.

CONTENTS OF CHAIN DRIVE CAMSHAFT KIT

- Chain drive cams front and rear
- Inner cam bearings
- Retaining ring
- Cam cover gasket
- Oil pump scavenge o-ring
- 5ml tube of Loctite® 262
- 5ml tube of Loctite 243

INSTRUCTION CONTENTS:

- Introduction & Specifications
- Securing Motorcycle
- Disassembly
- Installing New Cams and Reassembly
- Pushrod Adjustment



A. Introduction & Specifications

The S&S® chain drive cams outlined in this instruction sheet are intended for 1999-2006 Harley-Davidson® Twin Cam 88® models.

Cam Name	Lobe	Timing		Duration	Lift	Centerline	TDC Lift	99-04 Models Works with stock valve springs	05-UP Models Works with stock valve springs	Works with stock pushrods
		Open	Close							
475	Int	2°	34°	216°	0.475"	106°	.060"	X	X	X
	Exh	36°	4°	220°		106°	.060"			
509C	Int	18°	18°	216°	0.509"	90°	.0174"	X	X	X
	Exh	46°	11°	237°		107.5°	0.140"			
510C	Int	20°	38°	238°	0.510"	99°	0.187"	X	X	X
	Exh	52°	20°	252°		106°	0.179"			
551C (E)	Int	17°	19°	216°	0.550"	91°	0.178"		X	
	Exh	41°	17°	238°		102°	0.170"			
570C (E)	Int	20°	40°	240°	0.570"	100°	0.187"		X	
	Exh	55°	20°	255°		107.5°	0.179"			
583C (E)	Int	5°	18°	203°	0.583"	96.5°	0.113"		X	
	Exh	58°	24°	262°		107°	0.206"			
585C (E)	Int	20°	45°	245°	0.585"	102.5°	0.186"		X	
	Exh	60°	20°	260°		110°	0.179"			
625C (E)	Int	20°	55°	255°	0.625"	107.5°	0.189"			
	Exh	60°	20°	260°		110°	0.184"			
640C (E)	Int	25°	60°	265°	0.640"	107.5°	0.228"			
	Exh	65°	25°	270°		110°	0.214"			
675C (E)	Int	25°	60°	269°	0.675"	109.5°	0.235"			
	Exh	74°	25°	275°		112.5°	0.205"			

NOTES

- 1999–2004 stock springs will handle camshafts with lift up to 0.510". If a camshaft with higher lift is installed, high performance valve springs capable of handling a greater lift must be used.
- 2005–up stock valve springs will handle camshafts with lift up to 0.585". If a camshaft with higher lift is installed, high performance valve springs capable of handling a greater lift must be used. Cams with over 0.585" of lift will cause interference between the valve spring top collar and the valve seal with stock cylinder heads.
- Piston to valve clearance will need to be confirmed when using a cam with over 0.585" of lift. Clearance should be at least 0.060" intake and .080" exhaust.
- Valve to valve clearance will need to be confirmed when using a cam over 0.585" lift. Clearance should be a minimum of 0.060"
- Installation of S&S chain drive cams requires special tools. **See Picture 1 on page 3** for the required tools. Attempting the cam change operation without these tools will be difficult. Damage can result which will not be covered under warranty.
- Possible failure may result if thread locking compound is not applied to the cam drive sprocket flange bolts. Always prepare threads according to the instructions on the container.
- S&S® chain drivecams are compatible with the stock splined chain sprocket used in 2000–up Twin Cam 88 engines, but may be used in 1999 engines if the Harley-Davidson 2000–up splined rear cam sprocket and appropriate 2000-up sprocket spacer are used.
- Changing camshafts in the Twin Cam 88® engine requires use of hydraulic press and special tools. This installation should be undertaken only by experienced mechanic with access to Harley-Davidson® service manual and all required tools or equivalent. Tightening fasteners to correct specifications with accurate torque wrench is mandatory.

- For lifts over .510" S&S strongly recommends that the stock chain drive cam be upgraded to the S&S gear drive or to the H-D® part number 25284-08. This kit upgrades the problematic spring loaded chain tensioners to more reliable hydraulic tensioners, and also upgrades the oil pump.
- The S&S® chain drive cams outlined in this instruction sheet are intended for 1999-2006 Harley-Davidson Twin Cam 88 models, except 2006 Dyna® models.

OVERVIEW OF EASY START CAMSHAFTS (IF EQUIPPED):

S&S® has developed Easy Start cams to assist starting with a built in centrifugally operated compression release. The operation is simple: at cranking speeds a spring loaded decompression lever holds the exhaust valve open slightly. Once the engine fires and exceeds 750 RPM, centrifugal force move the lever to a retracted position, allowing the engine to run normally.

Important Notes Regarding Easy Start Camshafts:

- Stock EFI engines require a minimum of 80 PSI cranking compression, checked with the throttle open, for the ECU to fire the spark plugs.
- S&S easy start cams were designed to work with specific compression ratio and displacement combinations. If an Easy Start cam set is used in an application other than what it was designed for occasionally an engine may not build the required compression to start the bike.
- Cranking compression numbers are no longer a valid health check of the engine. We recommend performing a leak down test.
- If the lifters have been disassembled or bled down for any purpose, the starter may have difficulty with the initial start. Although the decompression lobe lifts the lifter body, the lifter is not pumped up and it will not lift the exhaust valve. You may need to remove the spark plugs and crank the engine to get oil pressure to the lifters.
- Easy Start cams require no special service. If they are ever removed for any reason however, inspect the mechanism for wear and verify that the lever operates smoothly.
- If your bike is carbureted, the starting routine may be slightly different, allow yourself time to experiment to find the best method.
- When the engine is turned off, you may hear a slight click as the decompression lever resets. This is normal and does no harm.
- If engine speed drops below 900 RPM, you may hear clicking as the decompression lever starts engaging. Idle speed should be adjusted higher. The engine idle should be set at 1000-1100 RPM.

Special Tools Required: See Picture 1, below

- H-D #42314 Crankshaft/Camshaft Sprocket Locking Tool
- H-D #42325 Camshaft Needle Bearing Remover/Installer
- H-D #43644 Camshaft Remover/Installer
- H-D #42313 Cam Chain Tensioner Unloader



Picture 1

All reference to Harley-Davidson® part numbers is for identification purposes only. We in no way are implying that any of S&S® Cycle's products are original equipment parts or that they are equivalent to the corresponding Harley-Davidson part number shown.

General Notes On Cam Installation

- Whenever new camshafts are installed, it is highly recommended that new tappets be installed. If tappets are reused, they must be reinstalled in the same position they were removed from.

Cam	Intended Displacement	Intended Compression Ratio
551	88-106	9.0-10.0
570	88-106	9.0-10.0
583	88-106	9.0-10.0
585	88-106	9.2-10.5
625	95+	10.0-10.75
640	95+	10.5-11.5
675	120+	11+

- Attempting the cam change operation without the required tools will be difficult and can easily result in damage to the components not covered under warranty.
- 1999 models used interchangeable ball bearings on the outer end of both cams. For 2000 and up, the rear bearing is a roller type and the front bearing is a ball bearing type. It is highly recommended to update 1999 models to the 2000 and up bearing set, which is included in the S&S Cam Installation Kit. These instructions are for 2000-up installation. **See Picture 2, next page.**
- Possible failure may result if Loctite® is not applied to cam drive sprocket flange bolts. Always prepare threads for Loctite according to instructions on container.

CAUTION

Failure of fasteners or parts caused by incorrect installation can cause extensive damage not covered under warranty.

WARNING

Failure of camshaft related parts caused by incorrect installation can cause immediate seizure of engine. Engine seizure can result in serious injury to motorcycle operator, passenger, or others.

- Original cam bearings will likely be damaged during removal. S&S strongly recommends installing new bearings at same time as cam change. S&S camshaft installation kit 33-5175 provides parts needed to install S&S chain drive camshaft sets. The installation kit also includes a new oil pump scavenge o-ring. The oil pump scavenge o-ring should never be reused since it can become stiff from heat and exposure to oils. This often results in poor sealing and inadequate oil scavenging.

CAUTION

For 2000 models and up, the front and rear cam bearings are not interchangeable! Ball bearing in front, roller bearing in rear.

B. Securing Motorcycle

CAUTION

Motorcycle must be adequately secured to avoid falling over during the cam change operation! Use of tie down straps on both sides of motorcycle is recommended.

1. Place motorcycle on a suitable repair stand so that motorcycle is stable and secure with the rear tire elevated. Shift transmission in

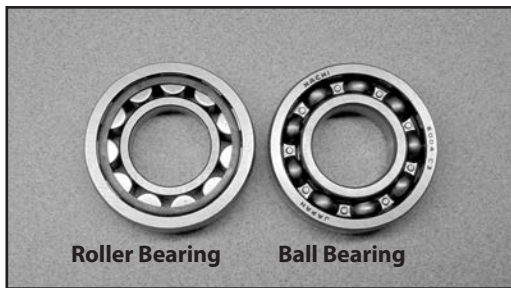

Picture 2

4th or 5th gear. Remove spark plugs. These steps are necessary so that the rear tire can be used to rotate the engine to correctly align the cam timing marks during installation, and align the oil pump during reassembly.

2. Disconnect negative terminal of battery to eliminate potential sparks and inadvertent engagement of starter while working on motorcycle.

NOTE: S&S® 475, 509, and 510 cams are compatible with stock pushrods. However, replacing stock pushrods with S&S adjustable pushrods 93-5096 will simplify cam set installation.

C. Disassembly for Early (99–06 excluding 06 Dyna)

1. Removing pushrods
 - a. If stock pushrods are to be reused, remove motorcycle gas tank and top rocker covers. Remove rocker assemblies and pushrods according to procedure described in the Harley-Davidson® Service Manual.
 - b. To remove stock pushrods which will not be reused, remove pushrod cover clips, collapse pushrod covers, place motorcycle in gear, and rotate rear tire (see Step B securing motorcycle) to place lifters and pushrods for either cylinder at lowest point on camshaft. Piston for same cylinder will be at TDC on Compression stroke and pushrods will spin with light finger pressure. Use bolt cutters to cut pushrods.



Cutting pushrods when they are under spring pressure can result in pushrod parts being ejected with considerable force, and can cause bodily injury.



Cutting pushrods with saw may result in metal chips entering engine and causing extensive engine damage not covered under warranty.

2. Remove engine gear cover and gasket. It is not necessary to remove ignition sensor from cover. Secure lifters with magnetic tappet tool or one made from large binder clip spring. **See Picture 3 above right.**
3. Rotate rear tire (see Step B securing motorcycle) to align timing marks on the pinion shaft sprocket and the rear cam sprocket.

NOTE: S&S recommends using Harley-Davidson Sprocket Locking Tool H-D® #42314 to secure sprockets while bolts are removed or installed. **See Picture 4 right.**

4. Remove bolt and washer from 17-tooth crankshaft sprocket.
5. Remove bolt and washer from 34-tooth rear camshaft sprocket.
6. Use tool H-D® #42313 (Cam Chain Tensioner Unloader) to swing primary cam chain tensioner away from chain. Secure with retention pin. **See Picture 5, next page.**

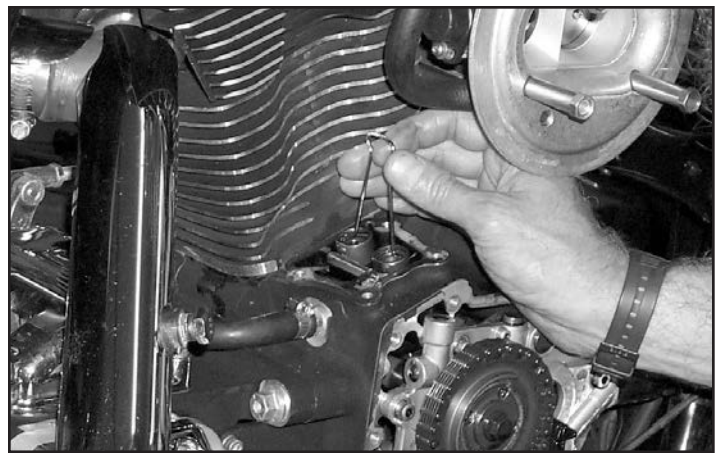

Picture 3



Do not pull the retention pins from the primary or secondary cam chain tensioners when the chain and sprockets are removed! The primary and secondary cam tensioner springs exert 35–40 pounds of pressure when retained. Removing a retaining pin without supporting the shoe will cause the spring to snap open through its full travel, damaging it, and/or the tensioner shoe. The tensioner can also injure hands and fingers in its path.

NOTE: If cam chain tensioner retaining pins interfere with cleaning or service procedures when the cam support plate is removed, use cam chain tensioner unloader tool (H-D #42313) to hold against spring pressure, then remove retaining pin and ease spring assembly into the unloaded position.

7. Working gradually around edge of sprocket, carefully pry sprockets off cams until loose on shaft. Remove sprocket/chain assembly and mark chain with magic marker to indicate direction of travel. Chain should be reinstalled in same direction.
8. Remove chain guide. **See Picture 6, next page.**
9. Gradually loosen and remove four oil pump bolts according to sequence shown in **Figure 1, next page.**
10. Gradually loosen and remove six support plate bolts according to sequence shown in **Figure 2, next page.**

NOTE: Failure to remove or install bolts according to correct procedure may result in parts damage not covered under warranty.

11. Carefully remove cam support plate assembly from crankcase. Use unloading tool H-D #42313 to swing secondary cam tensioner away from chain. Secure tensioner with second retention pin inserted through front of support plate. Do not remove pin until support plate assembly has been reinstalled in engine.

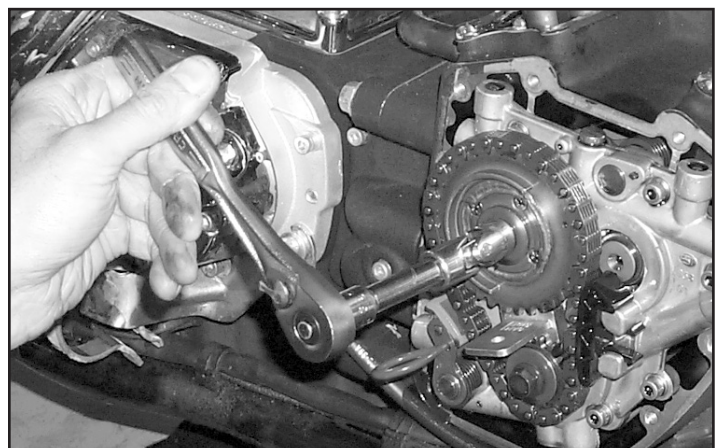

Picture 4

All reference to Harley-Davidson part numbers is for identification purposes only. We in no way are implying that any of S&S Cycle's products are original equipment parts or that they are equivalent to the corresponding Harley-Davidson part number shown.

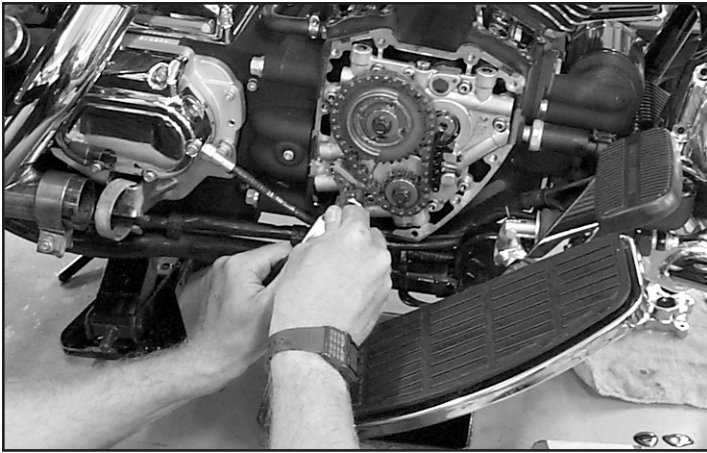

Picture 5

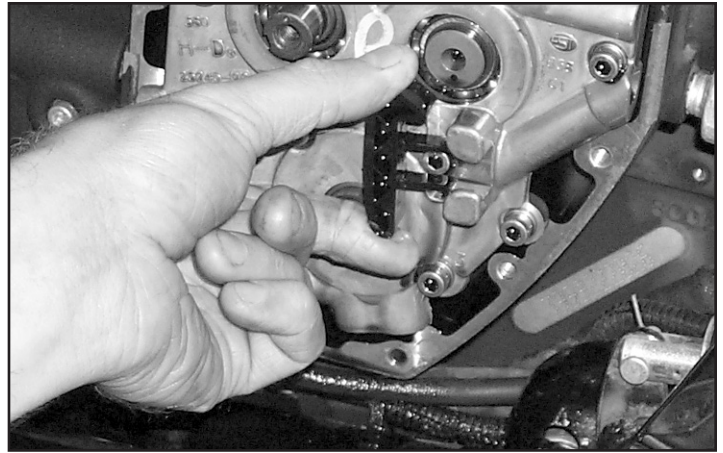

Picture 6

NOTE: Before reinstalling cam support plate, replace oil pump scavenge o-ring (supplied in kit) even if the original appears to be in good condition. The stock o-ring can become brittle and provide a poor seal if reused. This can cause poor oil scavenging, oil carry-over and loss of power..

12. Remove screws that secure bearing retainer to support plate and remove retainer from plate.
13. Support cam support plate on table of hydraulic press. Using camshaft remover/installer tool H-D® #43644, remove stock cams and bearings from plate. Mark chain with magic marker to indicate direction of travel. See Picture 7, next page.

CAUTION

in bearing plate. Cams and bearings must be removed from plate together. See Picture 7, next page.

Cam and bearings may press out easily. Use care to support cams so they don't unexpectedly fall to the floor.

NOTES: Bearings are usually damaged during removal and should not be reused. If S&S® Cam Installation Kit (33-5175) is not used, new cam bearings should be obtained from other source and installed with new cams.

- Check primary and secondary cam shoes for wear and/or damage. Do not re-use either shoe if more than ½ the shoe thickness is worn, or if there is any evidence of melting, burning, or cracking.
- Replacement shoes are installed per appropriate Harley-Davidson® service manual.
- If upgrading from keyed rear camshaft to splined rear camshaft,

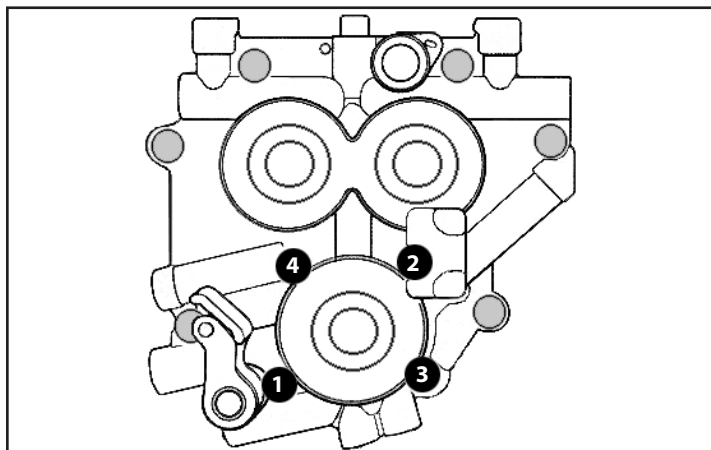

Figure 1

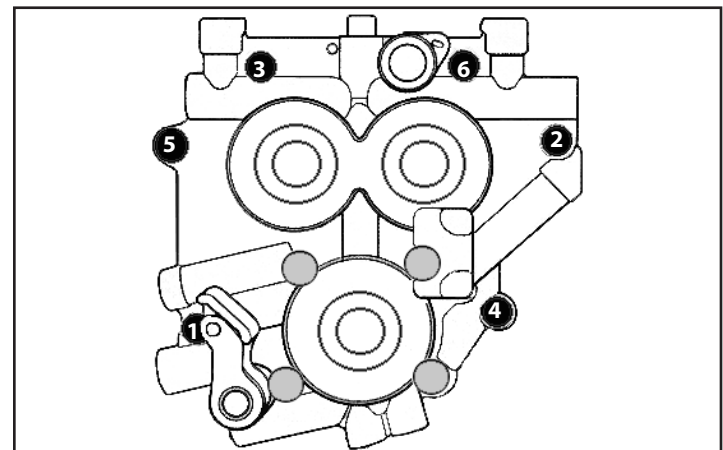

Figure 2

further steps require use of 2000 and up splined rear sprocket and spacer. Spacer style used with keyed cams is not compatible with splined cams. Spacers are available in five different thickness.

Prepare cam for installation:

NOTE: When using 551C, 583C, 585C, 625C, or 640C camshafts clearance between pinion bearing boss and rear cam lobe must be checked. See Pictures 9 & 10 next page. Remove just enough material to provide .030" clearance between top of cam lobe and pinion bearing boss when camshaft is rotated in inner needle bearing. Also check clearance between all cam lobes and tappet guide bosses. To avoid contamination of engine with chips, we recommend that all holes in the gear case be taped off with duct tape and that gear case be thoroughly cleaned with parts cleaner or solvent after clearancing is performed.

D. Replacing Cams ONLY — Early (99–06 excluding 06 Dyna)

NOTE: Not recommended for cams above .510 lift. If replacing cams and upgrading cam plate (recommended), follow instructions included with H-D® Kit #25284-08. After cam plate and cams have been installed, go to Section E for pushrod adjustments and special notes on compression releases.

NOTE: Before reinstalling cam support plate, replace oil pump scavenge o-ring (supplied in kit) even if the original appears to be in good condition. The stock o-ring can become brittle and provide a poor seal if reused.

1. Test fit front and rear bearings into bearing bores. If either bearing will slip into the bore, use red Loctite® 271 on bearing outer race during installation. If either bearing will not slip into bearing bore, use assembly lube on bearing outer race during installation. Using tool H-D #43644 and hydraulic press, install cam bearings in support plate, roller bearing in rear location, and ball bearing in front location. See Picture 11 next page.

All reference to Harley-Davidson part numbers is for identification purposes only. We in no way are implying that any of S&S Cycle's products are original equipment parts or that they are equivalent to the corresponding Harley-Davidson part number shown.

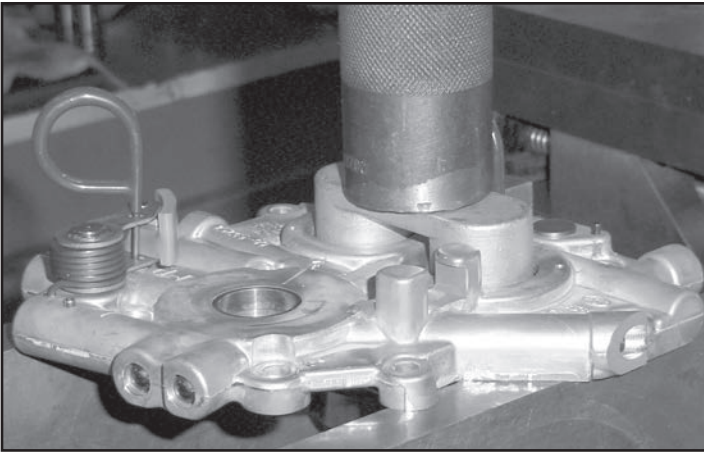

Picture 7

2. Using Loctite® 243 (blue) on screw threads, reinstall bearing retainer and tighten screws to 20-30 in-lbs.

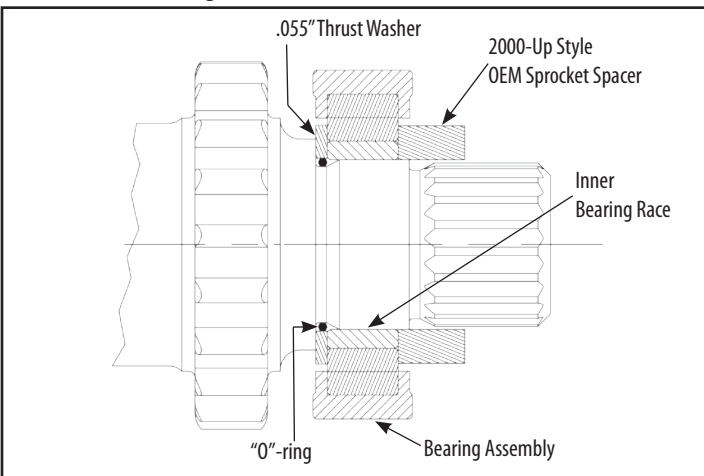
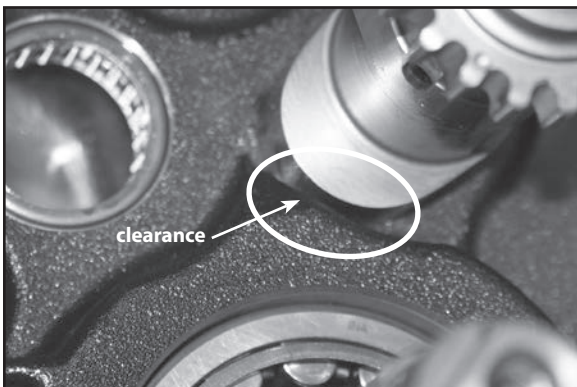
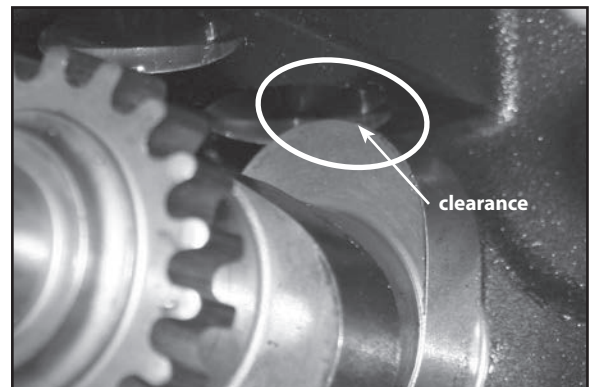

Figure 3 - Rear Cam Detail

3. Align cam timing marks and install secondary cam chain in original direction of travel. **See Picture 12 next page.**
4. Apply thin film of assembly lube to bearing surface of S&S® camshafts and inner race of cam bearings in cam plate. Support bearings by inner race. Using tool H-D® #43644, align both cams with bearings, install into cam bearings by pressing on front cam only, guide slip-fit rear cam into bearing. **See Picture 13 next page.**
5. Install new retaining ring in groove at end of front cam.



Picture 9



Picture 10

6. Remove cam needle bearings from crankcase with tool H-D #42325 and replace with new bearings provided in S&S installation kit 33-5175 or obtained from other source. Lubricate with clean engine oil.
7. Apply thin layer of assembly lube to cam journals and lobe surfaces. Align cams with needle bearings and carefully slide support plate assembly over crankcase dowels. **See Picture 14 below right.**
8. Apply Loctite® 243 (blue) to six support plate screws, install screws, and gradually tighten to 95 in-lbs. in sequence illustrated in **Figure 2 on page 7.**

NOTE: Support plate assembly should slide into place without resistance. If resistance is encountered, determine cause before proceeding. Do not force plate assembly!



S&S® has stripped holes for support plate screws when using maximum 120 in-lb. maximum torque spec recommended by Harley-Davidson®. Holes stripped are those which pass through alignment dowels, Positions #1 & #2 in Harley-Davidson diagram of Cam Support Plate/Oil Pump Torque Sequence.

9. Apply Loctite® #243 (blue) to threads and reinstall four oil pump bolts according to following procedure:
 - a. Gently bottom screws, then back out ¼ turn.
 - b. Center pump by rotating engine while snugging screws.
 - c. Rotate engine by turning rear wheel (see Section B securing motorcycle).
 - d. Tighten bolts to 90-120 in-lbs. in sequence illustrated in **Figure 1 on page 5.**



rotate engine.

10. Carefully remove secondary cam tensioner retaining pin.
11. Check front to back alignment of outer drive sprockets.
 - a. Place rear cam sprocket spacer next to rear bearing race.
 - b. Install rear camshaft and crankshaft sprockets.
 - c. Temporarily install crankshaft and camshaft sprocket bolts. Temporarily use a smaller diameter washer under the head of the crankshaft bolt. (This will allow a straightedge to fit on the sprocket face for Steps 13 d and e.)
 - d. Torque crankshaft and rear camshaft sprockets to 25 ft-lb. Do not use Loctite® at this time.
 - e. Push on rear camshaft to remove end play.

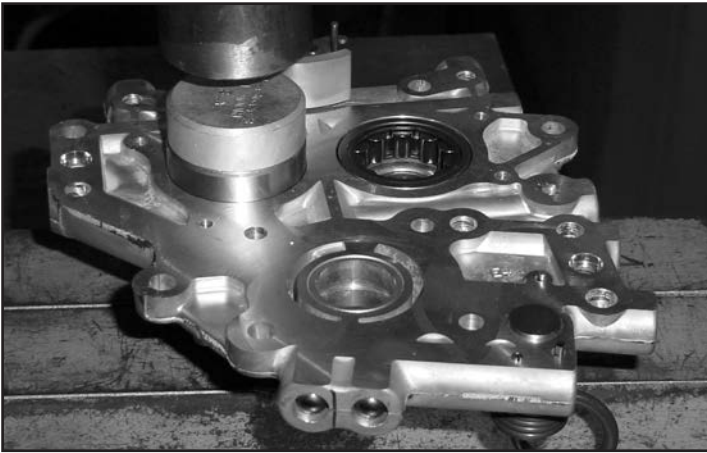

Picture 11

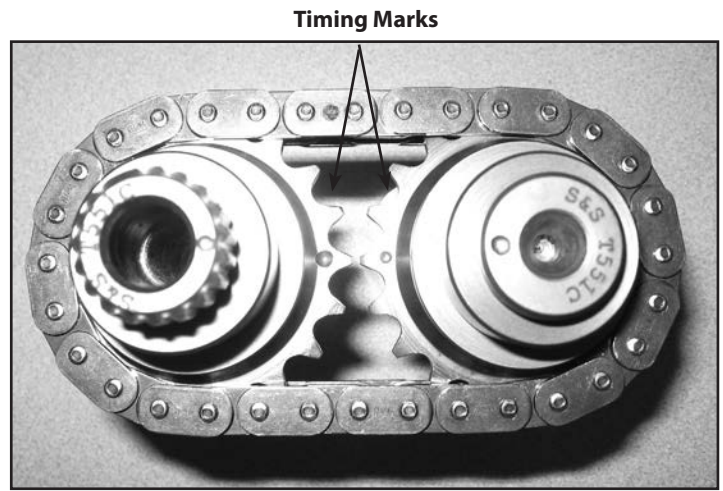

Picture 12

- f. Place a straightedge across the cam and crankshaft sprockets.
 - g. Try to slide a .010" thick feeler gauge between the straightedge and each sprocket face. If the feeler gauge does not fit at either location, the front to rear alignment of the sprockets is correct. In most situations, re-using the original crankshaft and camshaft sprockets, the alignment will be correct. Mis-alignment is generally because a different camshaft sprocket is used at re-assembly. In cases where the alignment front to back is not within .010", spacing washers are available from the OEM or aftermarket sprocket manufacturer to align the gears. Gear alignment must be within .010" before proceeding.
 - h. After verifying correct sprocket spacing, remove camshaft and crank sprocket bolts, remove both sprockets, and discard smaller diameter washer used under head of crank sprocket during alignment check.
12. Installing outer sprockets and drive chain.
- a. While holding rear cam sprocket vertically in one hand, place drive chain over sprocket with timing mark pointing down. Then, with the other hand place the crank sprocket in the chain loop with the timing mark pointing up. **See Picture 15, next page.**
 - b. Maintaining the position of the sprockets in the chain, rotate the rear drive sprocket until it slides on the splines of the rear cam. (The sprocket will only go onto the splines in one position.)
 - c. Continue to maintain the position of the sprockets on the chain. Rotate the rear cam and sprocket until the flat on the crank sprocket aligns with the flat on the crankshaft. Slide drive sprocket onto crankshaft.
 - d. Rotate engine by turning rear wheel to align the timing marks as close as possible. (See Section B Securing Motorcycle.)
 - e. Lay a straight edge across the centers of the crank and cam

sprockets and verify the timing marks are in alignment.

NOTE: If timing marks are not in alignment, the sprocket and chain installation must be removed and reinstalled. Misaligned sprockets will cause the engine to run erratically.

13. Replace cam chain guide. **See Picture 6 on page 5.**
14. Apply red Loctite® to threads of rear cam sprocket bolt and crankshaft sprocket bolt and a drop of clean 20W-50 engine oil beneath bolt heads. Place original large washer onto crank sprocket bolt. Use sprocket tool H-D® #42314 to secure sprockets. Tighten rear cam sprocket bolt to 34 ft./lbs. Tighten crank sprocket bolt to 24 ft./lbs.
15. Using H-D #42313 (Cam Chain Tensioner Unloader) relieve spring pressure on retaining pin and remove pin.
16. Install outer cover with new gasket and tighten bolts to 90-120 in-lbs. in sequence shown in **Picture 16, next page.**
17. Release lifters and slide them down the tappet bore to contact cams. If using stock pushrods or S&S Quickee pushrods, tappet covers may be left in place. If using S&S standard adjustable pushrods, tappet covers must be removed.

E. Pushrod Installation And Adjustments

1. Using Stock Non-Adjustable Pushrods

NOTE: Using stock pushrods is only possible if the camshafts installed have the same base circle as stock, and no more than .585" lift. S&S® labels these cams as "Bolt-In" for easy reference. Currently S&S 475, 509, and 510 cams are bolt-in.

- a. Rotate engine so one piston is at TDC compression, by rotating the rear tire while feeling the tappets. When both tappets are at the bottom of their travel, and the cylinder is at TDC, the cylinder is at TDC compression.

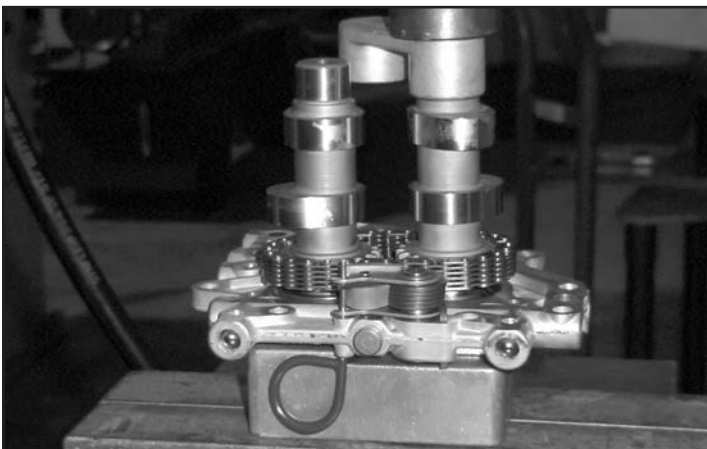

Picture 13

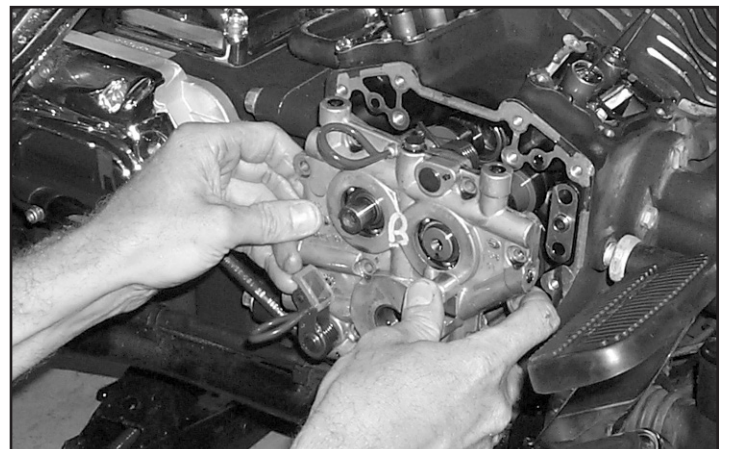

Picture 14



Picture 15

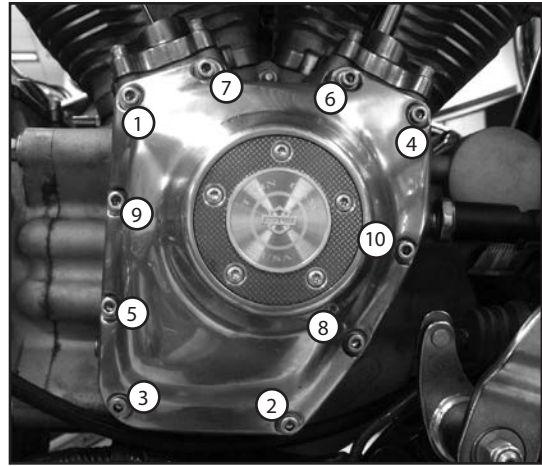

Picture 16

- b. Insert the pushrods into the collapsed pushrod tubes. Make sure the proper o-rings are installed in the tappet covers, and on the cylinder head end of the pushrod covers.
- c. Verify the correct locations for the pushrods that were removed. The longer pushrods go in the exhaust locations and the shorter pushrods are for the intakes.
- d. Insert the top of the pushrod into the hole in the head, then drop the bottom into the tappet cover.
- e. Apply assembly lube or suitable clean engine oil to the pushrod tips where they will contact the rocker arms.
- f. Insert the rocker arm support assembly into the rocker box.
- g. Ensure that the pushrod tips are fully engaged in the rocker arms.
- h. Apply Loctite® 243, then evenly snug the four 5/16" bolts which hold the rocker arms in place just finger tight at this time.
- i. Start the two breather cover bolts at this time, but do not tighten them.
- j. Begin tightening the rocker arm bolts. Following the sequence of lowest bolt on spark plug side, highest bolt on intake side, lowest bolt on intake side, then highest bolt on spark plug side. Tighten each bolt 1/4 turn at a time following this sequence until they have reached a torque of 18-22 ft-lbs.
- k. Tighten the two breather cover bolts to 90-120 ft-lbs.
- l. Allow lifters to bleed down, then check to ensure both pushrods rotate freely by hand.
- m. Install pushrod cover keepers.
- n. Install new rocker box gasket, and rocker box top cover.
- o. Apply blue threadlocker to the six rocker cover bolts and tighten in a star pattern to 15-18 ft-lbs.
- p. Repeat for the other cylinder, following steps 1 through 15.
- q. Install the gas tank.
- r. Shift transmission into neutral.
- s. Lower motorcycle onto lift and remove jack.
- t. Install spark plugs and plug wires.
- u. Reconnect negative battery cable.

2. Using Adjustable Pushrods

- a. Place transmission in high gear and turn rear wheel to rotate engine until both lifters for front cylinder are at lowest point in their travel. The front piston is now at TDC of compression stroke. If equipped with S&S Easy Start cams, you must use extra care when adjusting pushrods. Because the decompression lobe is near TDC, you must make sure that the tappet is not on the lobe. This will cause incorrect exhaust pushrod adjustment. To verify correct

position, you can rotate the engine in the forward direction and feel for the exhaust tappet to slightly lift (about .030") and set back down on base circle. This is the proper point to adjust the pushrods.

- b. Loosen locknuts on adjustable pushrods and turn adjusters to make all rods as short as possible. Z. When installing pushrods, note that longer S&S® pushrods are for exhaust valves, and shorter ones are for intake. Pass one long and one short pushrod through assembled pushrod covers.
- c. Place pushrod and cover assemblies through lifter cover. Inner tappet hole is for intake pushrod, and outer tappet hole is for exhaust pushrod. If using S&S standard adjustable pushrods, hold a new gasket under lifter cover and install push rod, pushrod cover, lifter cover, and gasket as an assembly on crankcase. Tighten lifter cover screws to 95 in-lbs. torque. Stock pushrods or S&S Quickee pushrods, can be installed without removing tappet cover.
- d. While holding the top of the pushrod into the cup of the rocker arm, extend the bottom end into the tappet until the pushrod is just making contact with the cup of the tappet. From this point, extend the pushrod 24 flats (4 full turns). Move the jam nut on the threaded portion of the pushrod to lock the end in place and tighten.

NOTE: S&S® adjustable pushrods have 32 threads per inch, and 24 flats will place the pushrod in the optimal position of the stock style tappet. If pushrods other than S&S adjustable or quickee's are used, refer to the manufacturer's instruction sheets to find the number of flats needed.

- e. Allow the tappet to bleed down until you are able to rotate the pushrod freely by hand, before adjusting the next pushrod.
- f. Repeat steps 5 and 6 for the other pushrod on the same cylinder.
- g. Ensure both pushrods rotate freely, then repeat steps 1 through 6 for the other cylinder.
- h. Install pushrod clips.
- i. Shift transmission into neutral.
- j. Lower motorcycle onto lift and remove jack.
- k. Install spark plugs and plug wires.
- l. Reconnect negative battery cable.

NOTE: The tappets may be noisy upon initial start-up after installing cams. This is normal after the tappets have all been bled down, and will go away shortly as long as the proper oil pressure is available.



If the engine is rotated before the tappets have bled down and the pushrods can be rotated by hand, valve to valve or valve to piston contact may occur. Serious engine damage could result.