

Instruction 106-5912  
02-21-14

**S&S<sup>®</sup> Cycle, Inc.**

14025 Cty Hwy G PO Box 215  
Viola, Wisconsin 54664

Phone: 608-627-1497 • Fax: 608-627-1488  
Technical Service Phone: 608-627-TECH (8324)  
Technical Service Email: [sstech@sscyle.com](mailto:sstech@sscyle.com)  
Website: [www.sscyle.com](http://www.sscyle.com)



Copyright © 2009–2014

by S&S<sup>®</sup> Cycle, Inc.

All rights reserved.  
Printed in the U.S.A.

## Installation Instructions: S&S Standard and Easy Start Chain Drive Camshafts for 2006 Harley-Davidson<sup>®</sup> Dyna<sup>®</sup> models and all 2007-up Big Twins

### DISCLAIMER:

S&S parts are designed for high performance, closed course, racing applications and are intended for the very experienced rider only. The installation of S&S parts may void or adversely affect your factory warranty. In addition such installation and use may violate certain federal, state, and local laws, rules and ordinances as well as other laws when used on motor vehicles used on public highways, especially in states where pollution laws may apply. Always check federal, state, and local laws before modifying your motorcycle. It is the sole and exclusive responsibility of the user to determine the suitability of the product for his or her use, and the user shall assume all legal, personal injury risk and liability and all other obligations, duties, and risks associated therewith.

The words Harley<sup>®</sup>, Harley-Davidson<sup>®</sup>, H-D<sup>®</sup>, Sportster<sup>®</sup>, Evolution<sup>®</sup>, and all H-D part numbers and model designations are used in reference only. S&S Cycle is not associated with Harley-Davidson, Inc.

### SAFE INSTALLATION AND OPERATION RULES:

Before installing your new S&S part it is your responsibility to read and follow the installation and maintenance procedures in these instructions and follow the basic rules below for your personal safety.

- Gasoline is extremely flammable and explosive under certain conditions and toxic when breathed. Do not smoke. Perform installation in a well ventilated area away from open flames or sparks.
- If motorcycle has been running, wait until engine and exhaust pipes have cooled down to avoid getting burned before performing any installation steps.
- Before performing any installation steps disconnect battery to eliminate potential sparks and inadvertent engagement of starter while working on electrical components.
- Read instructions thoroughly and carefully so all procedures are completely understood before performing any installation steps. Contact S&S with any questions you may have if any steps are unclear or any abnormalities occur during installation or operation of motorcycle with a S&S part on it.
- Consult an appropriate service manual for your motorcycle for correct disassembly and reassembly procedures for any parts that need to be removed to facilitate installation.
- Use good judgment when performing installation and operating motorcycle. Good judgment begins with a clear head. Don't let alcohol, drugs or fatigue impair your judgment. Start installation when you are fresh.
- Be sure all federal, state and local laws are obeyed with the installation.
- For optimum performance and safety and to minimize potential damage to carb or other components, use all mounting hardware that is provided and follow all installation instructions.
- Motorcycle exhaust fumes are toxic and poisonous and must not be breathed. Run motorcycle in a well ventilated area where fumes can dissipate.

### IMPORTANT NOTICE:

Statements in this instruction sheet preceded by the following words are of special significance.



**WARNING**

Means there is the possibility of injury to yourself or others.



**CAUTION**

Means there is the possibility of damage to the part or motorcycle.

**NOTE**

*Other information of particular importance has been placed in italic type.*

*S&S recommends you take special notice of these items.*

### WARRANTY:

All S&S parts are guaranteed to the original purchaser to be free of manufacturing defects in materials and workmanship for a period of twelve (12) months from the date of purchase. Merchandise that fails to conform to these conditions will be repaired or replaced at S&S's option if the parts are returned to us by the purchaser within the 12 month warranty period or within 10 days thereafter.

In the event warranty service is required, the original purchaser must call or write S&S immediately with the problem. Some problems can be rectified by a telephone call and need no further course of action.

A part that is suspect of being defective must not be replaced by a Dealer without prior authorization from S&S. If it is deemed necessary for S&S to make an evaluation to determine whether the part was defective, a return authorization number must be obtained from S&S. The parts must be packaged properly so as to not cause further damage and be returned prepaid to S&S with a copy of the original invoice of purchase and a detailed letter outlining the nature of the problem, how the part was used and the circumstances at the time of failure. If after an evaluation has been made by S&S and the part was found to be defective, repair, replacement or refund will be granted.

### ADDITIONAL WARRANTY PROVISIONS:

- (1) S&S shall have no obligation in the event an S&S part is modified by any other person or organization.
- (2) S&S shall have no obligation if an S&S part becomes defective in whole or in part as a result of improper installation, improper maintenance, improper use, abnormal operation, or any other misuse or mistreatment of the S&S part.
- (3) S&S shall not be liable for any consequential or incidental damages resulting from the failure of an S&S part, the breach of any warranties, the failure to deliver, delay in delivery, delivery in non-conforming condition, or for any other breach of contract or duty between S&S and a customer.
- (4) S&S parts are designed exclusively for use in Harley-Davidson<sup>®</sup> and other American v-twin motorcycles. S&S shall have no warranty or liability obligation if an S&S part is used in any other application.

**Contents Of Chain Drive Camshaft Kit 106-5929:**

- Chain drive cams front and rear
- Inner cam bearings
- Retaining ring
- Cam cover gasket
- Oil pump scavenger o-ring
- 5ml tube of Loctite® 262
- 5ml tube of Loctite 243

**Instruction Contents:**

- Introduction and Specifications
- Securing Motorcycle
- Disassembly
- Reassembly
  - Crankcase Preparation
  - Cam Installation
  - Rear Cam Endplay Adjustment
  - Final Assembly
  - Pushrod Installation & Adjustment

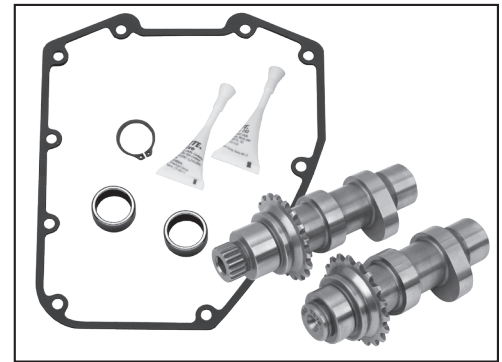

**Complete Chain Drive Camshaft Kit**

**Introduction and Specifications**

The S&S® chain drive cams outlined in this instruction sheet are intended for 2007-up big twin and 2006-up Harley-Davidson® Dyna® models.

Cam Name	Lobe	Timing		Duration	Lift	Centerline	TDC Valve Lift	05-UP Models Works with stock valve springs	Works with stock pushrods
		Open	Close						
510C	Int	20°	38°	238°	0.510"	99°	0.187"	X	X
	Exh	52°	20°	252°		106°	0.179"		
551C (E)	Int	17°	19°	216°	0.550"	91°	0.178"	X	X
	Exh	41°	17°	238°		102°	0.170"		
557	Int	6°	27°	212°	0.557"	100°	0.113"	X	X
	Exh	39°	12°	231°		103°	0.146"		
570C (E)	Int	20°	40°	240°	0.570"	100°	0.187"	X	X
	Exh	55°	20°	255°		107.5°	0.179"		
583C (E)	Int	5°	18°	203°	0.583"	96.5°	0.113"	X	X
	Exh	58°	24°	262°		107°	0.206"		
585C (E)	Int	20°	45°	245°	0.585"	102.5°	0.186"	X	X
	Exh	60°	20°	260°		110°	0.179"		
625C (E)	Int	20°	55°	255°	0.625"	107.5°	0.189"		
	Exh	60°	20°	260°		110°	0.184"		
635	Int	19.5°	43.5°	243°	0.635"	102°	0.186"		
	Exh	58.5°	37.5°	276°		100.5°	0.284"		
640C (E)	Int	25°	60°	265°	0.640"	107.5°	0.228"		
	Exh	65°	25°	270°		110°	0.214"		
HP103	Int	20°	49°	249°	0.575"	102.7°	0.199"	X	X
	Exh	45°	26°	251°		101.5°	0.206"		
MR103	Int	13°	33°	226°	0.585"	100°	0.097"	X	X
	Exh	50°	22°	252°		104°	0.191"		

**NOTES:**

- 2005-up stock valve springs will handle camshafts with lift up to 0.585". If a camshaft with higher lift is installed, high performance valve springs capable of handling a greater lift must be used.
- A cam with over 0.585" of lift will cause interference between the valve spring top collar and the valve seal with stock valve springs.
- Piston to valve clearance will need to be confirmed when using a cam with over 0.585" of lift. Clearance should be at least 0.060" intake and .080" exhaust.
- Valve to valve clearance will need to be confirmed when using a cam over 0.585" lift. Clearance should be a minimum of 0.060".
- Installation of S&S chain drive cams requires special tools. **See Picture 1** for the required tools. Attempting the cam change operation without these tools will be difficult. Damage can result which will not be covered under warranty.
- Possible failure may result if thread locking compound is not applied to the cam drive sprocket flange bolts. Always prepare threads according to the instructions on the container.
- All reference to Harley-Davidson part numbers is for identification purposes only. We in no way are implying that any of S&S Cycle's products are original equipment parts or that they are equivalent to the corresponding Harley-Davidson part numbers.

① Crankshaft/Camshaft Sprocket Locking Tool, H-D® Part Number: 47941

② Camshaft Needle Bearing Remover/Installer, H-D Part Number: 42325

• All reference to Harley-Davidson part numbers is for identification purposes only. We in no way are implying that any of S&S Cycle's products are original equipment parts or that they are equivalent to the corresponding Harley-Davidson part numbers.

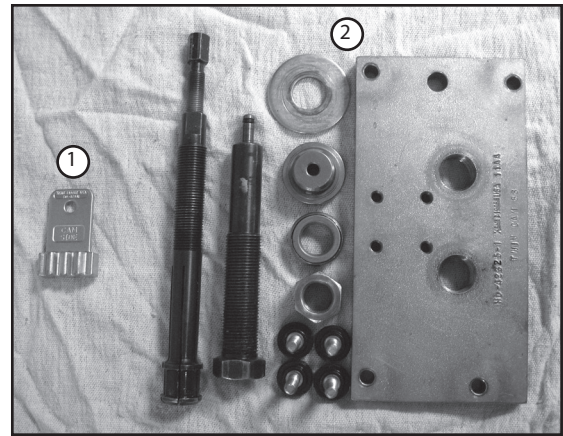

Picture 1

### Overview of Easy Start camshafts (if equipped):



Easy Start Chain Drive Cams

S&S® has developed Easy Start Cams to assist starting with a centrifugally operated compression release. The operation is simple: at cranking speeds a spring loaded decompression lever holds the exhaust valve open slightly. Once the engine fires and exceeds 750 RPM, centrifugal force takes over and sends the lever to a retracted position, allowing the engine to run normally.

### Important Notes Regarding Easy Start Camshafts:

Cam	Intended Displacement	Intended Compression Ratio
551	88-106	9.0-10.0
557	96-103	9.6-10.0
570	88-106	9.0-10.0
583	88-106	9.0-10.0
585	88-106	9.2-10.5
625	95+	10.0-10.75
635	106-124	10.2-10.8
640	95+	10.5-11.5
675	120+	11+
HP103	103	9.6-10.0
MR103	103	9.6-10.0

- Stock EFI engines require a minimum of 80 PSI cranking compression, checked with the throttle open, for the ECU to fire the spark plugs.
- S&S easy start cams were designed to work with specific compression ratio and displacement combinations. If an Easy Start cam set is used in an application other than what it was designed

for occasionally an engine may not build the required compression to start the bike.

- Cranking compression numbers are no longer a valid health check of the engine. We recommend performing a leak down test.
- If the lifters have been disassembled or bled down for any purpose, the starter may have difficulty with the initial start. Although the decompression lobe lifts the lifter body, the lifter is not pumped up and it will not lift the exhaust valve. You may need to remove the spark plugs and crank the engine to get oil pressure to the lifters.
- Easy Start cams require no special service. If they are ever removed for any reason however, inspect the mechanism for wear and verify that the lever operates smoothly.
- When the engine is turned off, you may hear a slight click as the decompression lever resets. This is normal and does no harm.
- If engine speed drops below 900 RPM, you may hear clicking as the decompression lever starts engaging. Idle speed should be adjusted higher. The engine idle should be set at 1000-1100 RPM.

### Securing the motorcycle



**Motorcycle must be adequately secured during the cam change operation! Use of tie down straps on both sides of the motorcycle is recommended.**

1. Place motorcycle on a suitable repair stand so that the motorcycle is stable and secure with the rear tire elevated.
2. Disconnect the negative terminal of the battery to eliminate potential sparks and inadvertent engagement of the starter while working on the motorcycle.
3. Place motorcycle in top gear. Remove spark plugs. These steps are necessary so that the rear tire can be used to rotate the engine to correctly align the cam timing marks during installation, and align the oil pump during reassembly.

### Disassembly



**Cutting the pushrods with a saw may result in metal chips entering the engine and causing extensive damage which will not be covered under warranty.**



**Cutting pushrods without relieving valve spring force on the pushrods may result in injury.**

1. Remove pushrods.
  - a. Remove pushrod cover clips with a small screwdriver and compress pushrod covers to expose pushrods. Lift rear tire of motorcycle with a suitable jack. Rotate the engine until one of the cylinders is on "top dead center compression stroke" (TDCC). TDCC can be found by rolling the rear tire forward while watching or feeling the pushrods move through their travel. When BOTH pushrods are at the lowest point of their travel and the piston for that cylinder is at TDC, the engine is at TDCC. Rotate the pushrods to ensure there is no load on them. If the pushrods will not rotate freely by hand, either the engine is not on TDCC, or the lifters need to bleed down. It may be necessary to let the lifters bleed down for a few minutes before the pushrods will rotate freely.
  - b. If stock non-adjustable pushrods will not be re-used, they may be removed by cutting them. When cutting pushrods, S&S recommends a bolt cutter be used as it is the cleanest method. Be sure to only cut the pushrods that are not loaded and rotate freely by hand.
  - c. If stock one piece pushrods are to be re-used, they must be removed using the factory procedure. Remove the gas tank and rocker box covers. Remove the rocker arm support by first removing the two smaller bolts which hold the breather cover in place. Next break loose the four bolts holding the rocker arm support plate in place with an alternating pattern. Remove the four rocker arm support plate bolts, and then the rocker arm support assembly. The pushrods may now be removed by sliding them up into the head slightly and then pulling the bottom of the pushrod towards you. Mark the original pushrod location as it is removed to ensure it is replaced in its original position. The intake pushrod is shorter than the exhaust pushrod. Interchanging the intake and exhaust pushrods upon reassembly, will cause the intake valve to stay open on the compression stroke and the engine will not run.
  - d. Rotate the engine so the other cylinder is on TDC compression and repeat the above procedure.
2. Remove cam cover and gasket. Secure lifters with a magnetic tappet tool or a tool made from a large binder clip spring. **See Picture 2, below.**

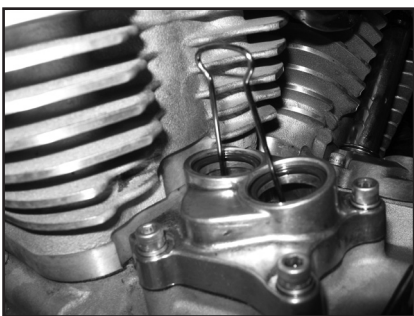

Picture 2

3. Rotate rear wheel to align timing marks on the primary cam chain.
4. Remove the primary chain tensioner by removing the two retaining bolts and install sprocket locking tool.
5. Remove the crank sprocket bolt and flat washer.
6. Remove rear cam sprocket bolt and flat washer.
7. Remove sprocket locking tool.
8. Gently pry off crank sprocket and rear cam sprocket.

### Cam Support Plate and Cam Removal

1. Gradually loosen and remove the four oil pump bolts/washers according to the sequence shown in **Picture 3, below.**
2. Gradually loosen and remove the six support plate bolts/washers according to the sequence shown below.

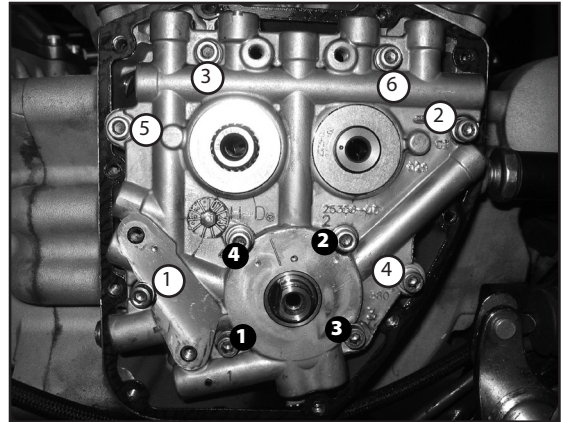

Picture 3

3. Remove spacer from rear cam, this spacer is thicker than the front spacer.
4. Remove cam plate and cams from engine.
5. Remove retaining ring and spacer from front cam. This spacer is 0.100" thick.
6. Remove the secondary cam chain tensioner.
7. Remove the cams and cam chain. Mark the direction of the cam chain so that it is installed in the original direction of rotation with the new cams.

### Reassembly

#### Crankcase Preparation

1. When using 551G, 570G, 583G, 585G, 625G, or 640G camshafts clearance between the pinion bearing boss and the rear cam lobe must be checked. **See Pictures 4 & 5, top of next page.** Remove just enough material to provide .030" of clearance between the top of the cam lobe and the pinion bearing boss when the camshafts are rotated in the inner needle bearing. Also check clearances between the cam lobe and the tappet guide bosses. To avoid contamination of the engine with chips, we recommend that all holes in the gear case be taped off with duct tape and that the gear case be thoroughly cleaned with parts cleaner or solvent after clearancing is performed.
2. Replace inner cam needle bearings. Be sure to use a full complement needle bearing such as those supplied with the chain drive installation kit. These bearings offer a higher load carrying capacity associated with high lift camshafts. Refer to the H-D® service manual for proper installation procedure.

**NOTE:** Before reinstalling cam support plate, replace oil pump scavenge o-ring (supplied in kit) even if the original appears to be in good condition. The stock o-ring can become brittle and provide a poor seal if reused. This can cause poor oil scavenging, oil carry-over and loss of power.



Picture 4

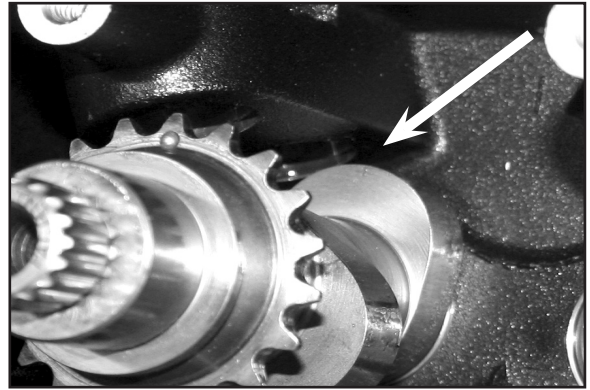

Picture 5

### Cam Installation

1. Place the cam support plate on a flat surface with the outside of the support plate facing down. Place supports under the cam support plate so that the cams can be easily installed.
2. Install the secondary cam chain around the front and rear cam sprockets. Ensure that the timing marks are still aligned. Also, the timing chain should be installed in its original direction of rotation. **See Picture 6, below.**
3. Lubricate the cam bearing cavities on the cam support plate with engine assembly lube, or suitable clean engine oil.
4. Install the cams into the cam support plate. Be careful not to damage the cam support plate while installing the cams.
5. Install the secondary cam chain tensioner. Apply Loctite® 243 and torque bolts to 100-120 in-lbs.
6. Turn the cam support plate over. Take care so that the cams do not slide out of the support plate. Install the 0.100" spacer over the end of the front cam. Install the new retaining ring.
7. Double check to make sure the oil pump has not pulled out of the crankcase.
8. Lubricate the cam needle bearings and decompression lever, if equipped, with assembly lube and install the cam support plate assembly.
9. Apply a small amount of Loctite 243 to the six bolts that hold on the cam support plate and torque in the sequence shown in **Picture 3, page 4**. Torque to 100-120 in-lbs.
10. Apply a small amount of Loctite 243 to the four bolts that hold the oil pump to the cam support plate. While rotating the engine, alternatively tighten bolts 1 and 2 until the bolts are snug. Tighten bolts 3 and 4 until they are snug. Finally, torque the four bolts in the sequence shown in to 90-120 in-lbs. This procedure ensures that the oil pump is properly centered.

### Rear Cam Endplay Adjustment

1. Install the spacer over the end of the rear cam. Install the primary cam sprocket to the rear cam and hand tighten bolt.
2. Install the crank sprocket to the crankshaft and hand tighten bolt.
3. Align the timing marks and install the sprocket locking tool and torque each bolt to 15 ft-lbs.
4. Push crank sprocket towards the drive side of the motorcycle to eliminate end play. Push the rear cam inwards to eliminate end play.
5. Lay a straight edge across the face of the crank sprocket and the primary cam sprocket. If the gap between the straight edge and the sprocket faces is smaller than 0.010", no adjustment of the spacer behind the rear cam sprocket is necessary. Select the proper spacer for the rear cam so that this gap is no greater than 0.010". Spacers are available from Harley-Davidson® in the following sizes and part numbers:
  - .100" thick H-D® Part Number 25729-06
  - .110" thick H-D Part Number 25731-06
  - .120" thick H-D Part Number 25734-06
  - .130" thick H-D Part Number 25736-06
6. Remove sprockets so that the outer drive chain can be installed for the final assembly.

### Final Assembly

1. Place primary chain over the rear cam sprocket. Install the crank sprocket into the primary chain so that the timing marks on both sprockets are aligned as shown in **Picture 7**.
2. Install the primary timing chain assembly onto the crankshaft and rear cam.

**NOTE:** Align the crankshaft and rear cam so that the primary timing chain assembly fits so that the timing marks are aligned.

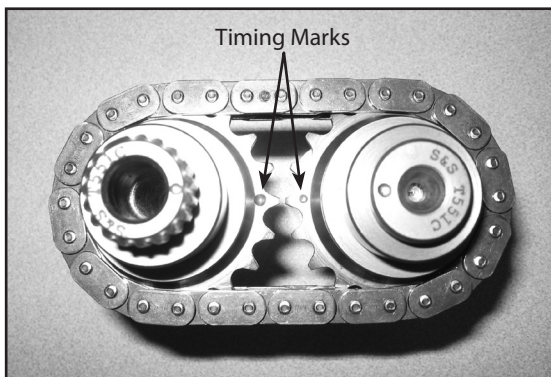

Picture 6

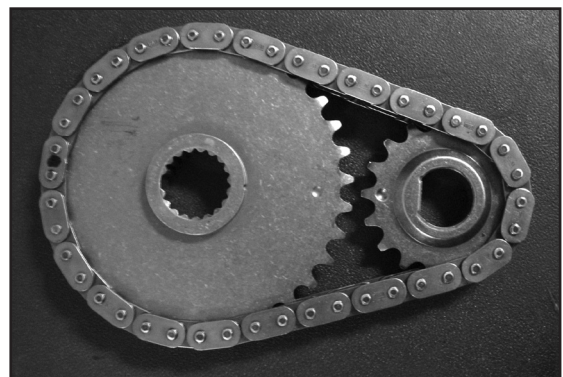

Picture 7

3. Thoroughly clean the flange bolts and apply a small amount of Loctite® 262, 271, or 272 to the threads. Apply a drop of clean 20W-50 engine oil under the bolt flanges.
4. Install the sprocket locking tool and tighten the crankshaft gear bolt to 25 ft.-lbs. torque. Torque the camshaft gear bolt to 34 ft.-lbs.
5. Install primary cam chain tensioner, tighten fasteners to 100-120 in.-lbs.
6. Inspect the blind tapped holes for the cam cover in the crankcase for cleanliness. Remove any foreign debris.
7. Install cam cover with new gasket. Torque the 10 bolts to 125-155 in.-lbs in the sequence shown below in **Picture 8**.
8. Remove the clips holding the tappets in place.

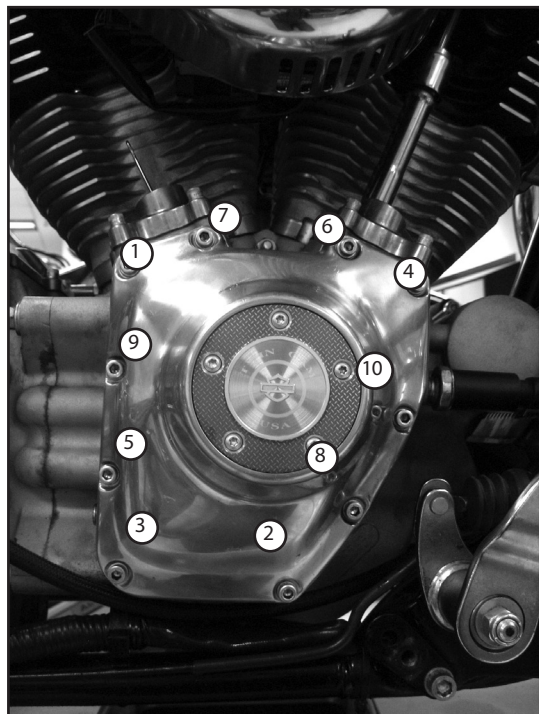

**Picture 8**

### Adjustable Pushrod Installation And Adjustment

1. Rotate engine so one piston is at TDC compression, by rotating the rear tire while feeling the tappets. When both tappets are at the bottom of their lift, and the piston is at TDC, the cylinder is at TDC compression. If equipped with compression releases, you must use extra care when installing pushrods. Because the decompression lobe is near TDC, it is possible to adjust the pushrod while the tappet is on the lobe if it is not exactly at TDC. This will cause incorrect exhaust pushrod adjustment. To verify correct position, you can rotate the engine in the forward direction and feel for the exhaust tappet to slightly lift ( about .030") and set back down on base circle. This is the proper point to install the pushrods.
2. Insert the adjustable pushrods into the collapsed pushrod tubes. Make sure the proper o-rings are installed in the tappet covers, and on the cylinder head end of the pushrod covers.
3. If the pushrod kit contains different length pushrods, the longer pushrods go in the exhaust locations and the shorter pushrods are for the intakes.
4. Insert the top of the pushrod into the hole in the head, then drop the bottom into the tappet cover.

5. While holding the top of the pushrod into the cup of the rocker arm, extend the bottom end into the tappet until the pushrod is just making contact with the cup of the tappet. From this point, extend the pushrod 24 flats (4 full turns). Move the jam nut on the threaded portion of the pushrod to lock the end in place and tighten.

**NOTE:** S&S® adjustable pushrods have 32 threads per inch, and 24 flats will place the pushrod in the optimal position of the stock style tappet. If pushrods other than S&S adjustable or quickee's are used, refer to the manufacturer's instruction sheets to find the number of flats needed.

6. Allow the tappet to bleed down until you are able to rotate the pushrod freely by hand, before adjusting the next pushrod.
7. Repeat steps 5 and 6 for the other pushrod on the same cylinder.
8. Ensure both pushrods rotate freely, then repeat steps 1 through 6 for the other cylinder.
9. Install pushrod clips.
10. Shift transmission into neutral.
11. Lower motorcycle onto lift and remove jack.
12. Install spark plugs and plug wires.
13. Reconnect Negative battery cable.



### CAUTION



**If the engine is rotated before the tappets have bled down and the pushrods can be rotated by hand, valve to valve or valve to piston contact may occur. Serious engine damage could result.**

### Stock Non-Adjustable Pushrod Installation

**NOTE:** Using stock pushrods is only possible if the camshafts installed have the same base circle as stock, and no more than .585" lift. S&S® labels these cams as "Bolt-In" for easy reference. Currently S&S 510, 551 and 583 cams are bolt-in.

1. Rotate engine so one piston is at TDC compression, by rotating the rear tire while feeling the tappets. When both tappets are at the bottom of their lift, and the cylinder is at TDC, the cylinder is at TDC compression. If equipped with compression releases, you must use extra care when adjusting pushrods. Because the decompression lobe is near TDC, it is possible to adjust the pushrod while the tappet is on the lobe if it is not exactly at TDC. This will cause incorrect exhaust pushrod adjustment. To verify correct position, you can rotate the engine in the forward direction and feel for the exhaust tappet to slightly lift (about .030") and set back down on base circle. This is the proper point to adjust the pushrods.
2. Insert the pushrods into the collapsed pushrod tubes. Make sure the proper o-rings are installed in the tappet covers, and on the cylinder head end of the pushrod covers.
3. Verify the correct locations for the pushrods that were removed. The longer pushrods go in the exhaust locations and the shorter pushrods are for the intakes.
4. Insert the top of the pushrod into the hole in the head, then drop the bottom into the tappet cover.
5. Apply assembly lube or suitable clean engine oil to the pushrod tips where they will contact the rocker arms.
6. Insert the rocker arm support assembly into the rocker box.
7. Ensure that the pushrod tips are fully engaged in the rocker arms.

8. Apply Loctite® 243, then evenly snug the four 5/16" bolts which hold the rocker arms in place just finger tight at this time.
9. Start the two breather cover bolts at this time, but do not tighten them.
10. Begin tightening the rocker arm bolts. Following the sequence of lowest bolt on spark plug side, highest bolt on intake side, lowest bolt on intake side, then highest bolt on spark plug side. Tighten each bolt ¼ turn at a time following this sequence until they have reached a torque of 18-22 ft-lbs.
11. Tighten the two breather cover bolts to 90-120 in-lbs.
12. Allow lifters to bleed down, then check to ensure both pushrods rotate freely by hand.
13. Install pushrod cover keepers.
14. Install new rocker box gasket, and rocker box top cover.
15. Apply blue threadlocker to the six rocker cover bolts and tighten in a star pattern to 15-18 ft-lbs.
16. Repeat for the other cylinder, following steps 1 through 15.
17. Install the gas tank.
18. Shift transmission into neutral.
19. Lower motorcycle onto lift and remove jack.
20. Install spark plugs and plug wires.
21. Reconnect negative battery cable.

**NOTE:** *The tappets may be noisy upon initial start-up after installing cams and adjusting pushrods. This is normal after the tappets have all been bled down, and will go away shortly as long as the proper oil pressure is available to the tappets.*

