

K8097

ILLUSTRATED ASSEMBLY MANUAL H8097IP'1

4- Channel USB stepper motor card



velleman®
projects



With the K8097 4-channel stepper motor card you can drive 4 stepper motors via USB, and monitor and assign actions if needed to 5 dry contacts

(for example an emergency stop signal, current limit detection).



Optional stepping motor: MOTS3

Search product

Search Product

Navigation

- ▶ Main page
- ▶ Products
- ▶ Sales outlets
- ▶ Support
- ▶ Publications
- ▶ Jobs
- ▶ About us

News

NEW MK193 LED CUBE

CubeAnimator software
available for download
here!!!

Posted on 04-06-12

[Read more...](#)

Velleman Projects Newsletter

Are you an electronics enthusiastic or simply interested in our kits, mini-kits, modules and instruments?

Subscribe to our Newsletter and receive every month the latest news, new products & updates on Velleman Projects.

You will receive an e-mail. Click on the link in that e-mail to confirm your subscription.

Email:



Do you want to unsubscribe? Click on the 'unsubscribe' link in the footer of the last received newsletter from Velleman Projects.



- velleman.eu
- h4power.eu
- perel.eu
- vellemanprojects.com
kits - modules - instruments
- velbus.eu
- forum.velleman.eu

Advertisements

DAC1
DAC2
A1
K8055(N) / VM110(N)
Android Application

Login Register

FAQ Search

It is currently Fri Sep 14, 2012 1:50 pm

View unanswered posts | View active topics

Board index

All times are UTC

Forum		Topics	Posts	Last post
General				
1	Forum rules / Règlements du forum Read first / À lire en premier lieu Moderators: Velleman Support	2	2	Wed Dec 06, 2006 10:44 am velleman
2	Forum Administration Velleman In-House Forum Discussions Moderator: Velleman Support	1	4	Thu May 03, 2012 1:22 pm VEL448
Velbus				
2	Velbus Home Automation Special section for our new Velbus Home Automation System (domotick) Moderator: Velleman Support	404	2072	Tue Sep 11, 2012 1:11 pm Daweb
Kits (Soldering projects - Projects à souder)				
2	General For other topics, general tips and tricks, new ideas Moderator: Velleman Support	131	428	Wed Sep 05, 2012 2:37 pm VEL417
2	Audio Hi Fi Projects All audio related projects, amplifiers, valve amplifiers Moderator: Velleman Support	557	2450	Fri Sep 14, 2012 6:32 am VEL417
2	PC Related Projects For projects that are connected to the PC like interface cards Moderator: Velleman Support	1428	6948	Thu Sep 13, 2012 8:04 pm Hark
2	Microcontroller Programmer - Experimenting Projects Here you can discuss PIC programming, example soft... Moderator: Velleman Support	457	1749	Tue Sep 11, 2012 4:27 am Ben490
2	Timers and Clocks All about our time related projects from regular clocks to programmable timers Moderator: Velleman Support	261	864	Fri Sep 07, 2012 6:40 am VEL417
2	Home Projects Household related projects, from light drivers to remote control Moderator: Velleman Support	636	2283	Fri Sep 14, 2012 12:00 pm VEL255



Participate our Velleman Projects Forum



Subscribing our newsletter?, visit www.vellemanprojects.eu

With the K8097 4-channel stepper motor card you can drive 4 stepper motors via USB, and monitor and assign actions if needed to 5 dry contacts (for example an emergency stop signal, current limit detection).

There is 1 open collector output that can be switched via USB. Write your own application (.DLL included). Suitable for all positioning applications (for example plotters, printers, valves, automation, etc.).

Features

- capable of driving 4 stepper motors
- suited for bipolar motors
- current of the motor can be adjusted (trimmer)
- over current protection sensing
- onboard switch mode supply
- USB connection: control the motor using your computer
- DLL file supplied to write your own software
- Includes board to wire connections

Specifications

- power output: 750mA continuous, (1A peak)
- wide range AC - power input: 5 ... 30V
- 5 dry-contact inputs
- 1 logic open collector output
- power supply: 10 ... 30VAC
- dimensions: 117 x 65.5 x 25mm / 4.6 x 2.58 x 0.98"



For software, visit www.vellemanprojects.eu

Leds and how to use them

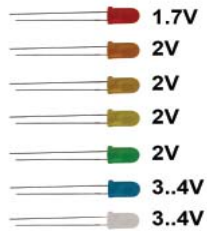

Leds feature a specific voltage drop, depending on type and colour. Check the datasheet for exact voltage drop and rated current !

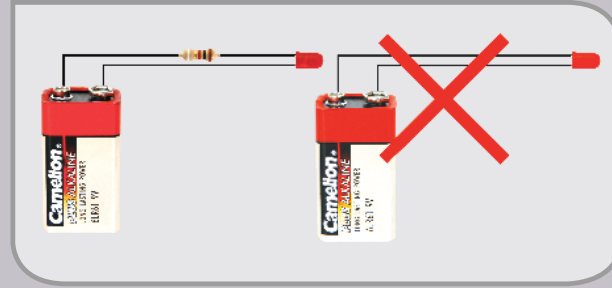
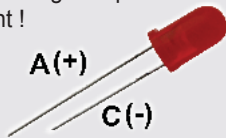

Never connect leds in parallel

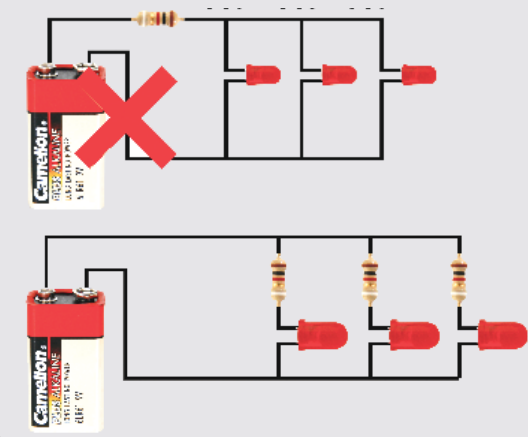

How to Calculate the series resistor:

Example: operate a red led (1.7V) on a 9Vdc source.

Required led current for full brightness: 5mA (this can be found in the datasheet of the led)

$$\frac{\text{Supply voltage (V)} - \text{led voltage (V)}}{\text{required current (A)}} = \text{series resistance (ohms)}$$

$$\rightarrow \frac{9V - 1.7V}{0.005A} = 1460 \text{ ohm}$$

closest value :
use a 1k5 resistor

Required resistor power handling=
voltage over resistor x current passed trough resistor

$$\rightarrow (9V - 1.7V) \times 0.005A = 0.036W$$

a standard 1/4W resistor
will do the job

LEDs in series:

Example: 3 x red led (1.7V) on 9V battery

Required led current for full brightness: 5mA
(this can be found in the datasheet of the led)

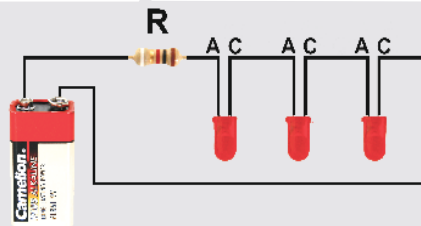

$$\frac{\text{Supply voltage (V)} - (\text{number of leds} \times \text{led voltage (V)})}{\text{required current (A)}} = \text{series resistance (ohms)}$$

$$\rightarrow \frac{9V - (3 \times 1.7V)}{0.005A} = 780 \text{ ohm}$$

use an
820 ohm resistor

open collector outputs

An open collector output can be compared to a switch which switches to ground when operated

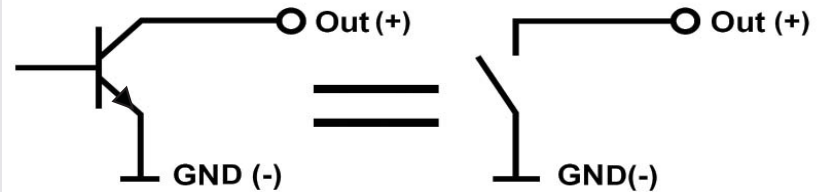

Example: How to switch an LED by means of an open collector output

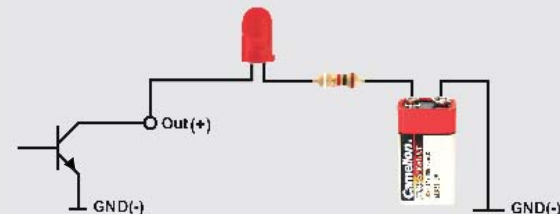

assembly hints

1. Assembly (Skipping this can lead to troubles !)

Ok, so we have your attention. These hints will help you to make this project successful. Read them carefully.



1.1 Make sure you have the right tools:

- A good quality soldering iron (25-40W) with a small tip.
- Wipe it often on a wet sponge or cloth, to keep it clean; then apply solder to the tip, to give it a wet look. This is called 'thinning' and will protect the tip, and enables you to make good connections. When solder rolls off the tip, it needs cleaning.
- Thin raisin-core solder. Do not use any flux or grease.
- A diagonal cutter to trim excess wires. To avoid injury when cutting excess leads, hold the lead so they cannot fly towards the eyes.
- Needle nose pliers, for bending leads, or to hold components in place.
- Small blade and Phillips screwdrivers. A basic range is fine.

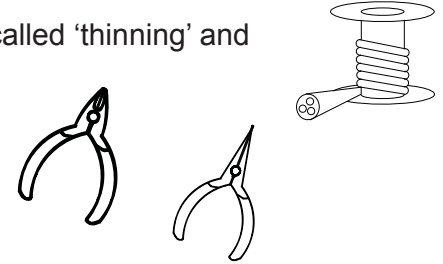

☞ For some projects, a basic multi-meter is required, or might be handy

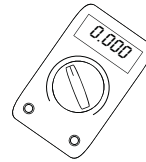

1.2 Assembly Hints :

- Make sure the skill level matches your experience, to avoid disappointments.
- Follow the instructions carefully. Read and understand the entire step before you perform each operation.
- Perform the assembly in the correct order as stated in this manual
- Position all parts on the PCB (Printed Circuit Board) as shown on the drawings.
- Values on the circuit diagram are subject to changes, the values in this assembly guide are correct*
- Use the check-boxes to mark your progress.
- Please read the included information on safety and customer service

* Typographical inaccuracies excluded. Always look for possible last minute manual updates, indicated as 'NOTE' on a separate leaflet.

1.3 Soldering Hints :

1. Mount the component against the PCB surface and carefully solder the leads

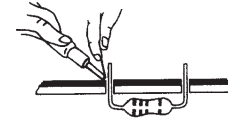

2. Make sure the solder joints are cone-shaped and shiny

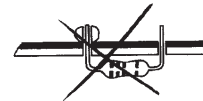

3. Trim excess leads as close as possible to the solder joint



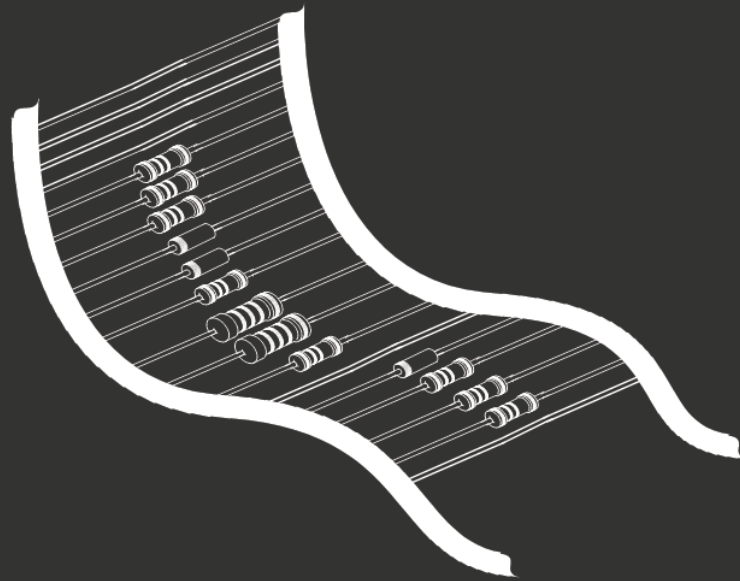

REMOVE THEM FROM THE TAPE ONE AT A TIME !

Included in
this kit

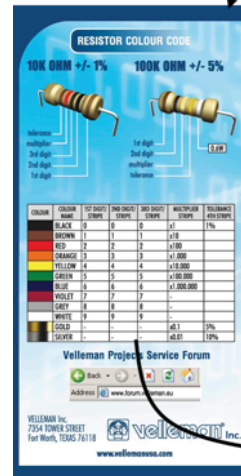

2. RESISTOR

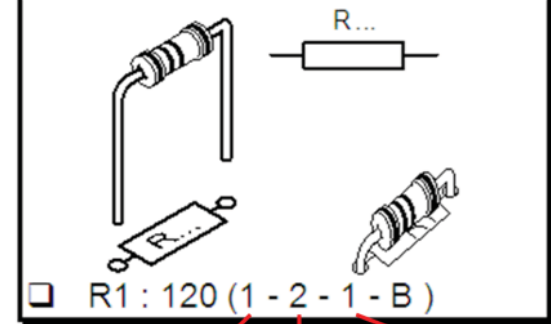

COLOUR	COLOUR NAME	1ST DIGIT/ STRIPE	2ND DIGIT/ STRIPE	3RD DIGIT/ STRIPE	MULTIPLIER STRIPE	TOLE 4TH!
	BLACK	0	0	0	x1	1%
	BROWN	1	1	1	x10	
	RED	2	2	2	x100	
	ORANGE	3	3	3	x1.000	
	YELLOW	4	4	4	x10.000	
	GREEN	5	5	5	x100.000	
	BLUE	6	6	6	x1.000.000	

DO NOT BLINDLY FOLLOW THE ORDER OF THE COMPONENTS ONTO THE TAPE. ALWAYS CHECK THEIR VALUE ON THE PARTS LIST!

1 Resistors

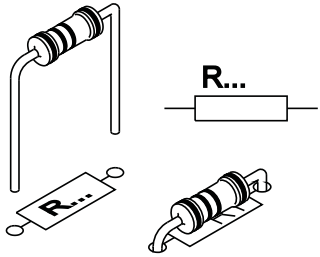

<input type="checkbox"/>	R1	: 10Ω	(1 - 0 - 0 - B)
<input type="checkbox"/>	R2	: 4K7	(4 - 7 - 2 - B)
<input type="checkbox"/>	R3	: 1Ω	(1 - 0 - B - B - 9)*
<input type="checkbox"/>	R4	: 1Ω	(1 - 0 - B - B - 9)*
<input type="checkbox"/>	R5	: 1K	(1 - 0 - 2 - B)
<input type="checkbox"/>	R6	: 1Ω	(1 - 0 - B - B - 9)*
<input type="checkbox"/>	R7	: 1Ω	(1 - 0 - B - B - 9)*
<input type="checkbox"/>	R8	: 1K	(1 - 0 - 2 - B)
<input type="checkbox"/>	R9	: 1Ω	(1 - 0 - B - B - 9)*
<input type="checkbox"/>	R10	: 1Ω	(1 - 0 - B - B - 9)*
<input type="checkbox"/>	R11	: 1K	(1 - 0 - 2 - B)
<input type="checkbox"/>	R12	: 1Ω	(1 - 0 - B - B - 9)*
<input type="checkbox"/>	R13	: 1Ω	(1 - 0 - B - B - 9)*
<input type="checkbox"/>	R14	: 1K	(1 - 0 - 2 - B)
<input type="checkbox"/>	R15	: 1Ω	(1 - 0 - B - B - 9)*
<input type="checkbox"/>	R16	: 1Ω	(1 - 0 - B - B - 9)*
<input type="checkbox"/>	R17	: 1K	(1 - 0 - 2 - B)
<input type="checkbox"/>	R18	: 1Ω	(1 - 0 - B - B - 9)*
<input type="checkbox"/>	R19	: 1Ω	(1 - 0 - B - B - 9)*
<input type="checkbox"/>	R20	: 1K	(1 - 0 - 2 - B)

* metalfilm resistor !

<input type="checkbox"/>	R21	: 1Ω	(1 - 0 - B - B - 9)*
<input type="checkbox"/>	R22	: 1Ω	(1 - 0 - B - B - 9)*
<input type="checkbox"/>	R23	: 1K	(1 - 0 - 2 - B)
<input type="checkbox"/>	R24	: 56K	(5 - 6 - 3 - B)
<input type="checkbox"/>	R25	: 56K	(5 - 6 - 3 - B)
<input type="checkbox"/>	R26	: 56K	(5 - 6 - 3 - B)
<input type="checkbox"/>	R27	: 56K	(5 - 6 - 3 - B)
<input type="checkbox"/>	R28	: 56K	(5 - 6 - 3 - B)
<input type="checkbox"/>	R29	: 56K	(5 - 6 - 3 - B)
<input type="checkbox"/>	R30	: 56K	(5 - 6 - 3 - B)
<input type="checkbox"/>	R31	: 56K	(5 - 6 - 3 - B)
<input type="checkbox"/>	R32	: 10KΩ	(1 - 0 - 3 - B)
<input type="checkbox"/>	R33	: 10KΩ	(1 - 0 - 3 - B)
<input type="checkbox"/>	R34	: 10KΩ	(1 - 0 - 3 - B)
<input type="checkbox"/>	R35	: 10KΩ	(1 - 0 - 3 - B)
<input type="checkbox"/>	R36	: 10KΩ	(1 - 0 - 3 - B)
<input type="checkbox"/>	R37	: 10KΩ	(1 - 0 - 3 - B)
<input type="checkbox"/>	R38	: 1K	(1 - 0 - 2 - B)
<input type="checkbox"/>	R39	: 1K	(1 - 0 - 2 - B)
<input type="checkbox"/>	R40	: 1Ω	(1 - 0 - B - B - 9)*
<input type="checkbox"/>	R41	: 1Ω	(1 - 0 - B - B - 9)*
<input type="checkbox"/>	R42	: 1K	(1 - 0 - 2 - B)
<input type="checkbox"/>	R43	: 1K2	(1 - 2 - 0 - 1 - 1)
<input type="checkbox"/>	R44	: 3K9	(3 - 9 - 0 - 1 - 1)
<input type="checkbox"/>	R45	: 10KΩ	(1 - 0 - 3 - B)
<input type="checkbox"/>	R46	: 10KΩ	(1 - 0 - 3 - B)
<input type="checkbox"/>	R47	: 10KΩ	(1 - 0 - 3 - B)
<input type="checkbox"/>	R48	: 10KΩ	(1 - 0 - 3 - B)
<input type="checkbox"/>	R49	: 10KΩ	(1 - 0 - 3 - B)
<input type="checkbox"/>	R50	: 10KΩ	(1 - 0 - 3 - B)

2 Ceramic Capacitors

<input type="checkbox"/>	C2	: 100nF	(104)
<input type="checkbox"/>	C3	: 100nF	(104)
<input type="checkbox"/>	C4	: 100nF	(104)
<input type="checkbox"/>	C5	: 100nF	(104)
<input type="checkbox"/>	C7	: 100nF	(104)
<input type="checkbox"/>	C8	: 100nF	(104)
<input type="checkbox"/>	C10	: 100nF	(104)
<input type="checkbox"/>	C11	: 100nF	(104)
<input type="checkbox"/>	C13	: 100nF	(104)
<input type="checkbox"/>	C14	: 100nF	(104)
<input type="checkbox"/>	C36	: 100nF	(104)

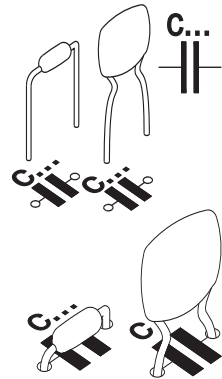

3 Schottky diode

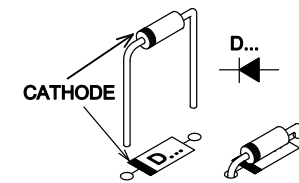

Watch the
polarity!

D3 : SB130

4 IC socket

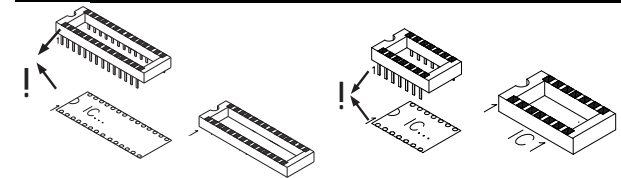

<input type="checkbox"/>	IC1: 40p	<input type="checkbox"/>	IC4: 24p
<input type="checkbox"/>	IC2: 24p	<input type="checkbox"/>	IC5: 24p
<input type="checkbox"/>	IC3: 24p	<input type="checkbox"/>	IC6: 16p

Watch the
position of
the notch!

5 Trimmer

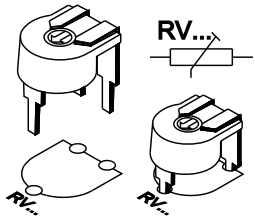

- RV1 : 10K
- RV2 : 10K
- RV3 : 10K
- RV4 : 10K

Adjust trimmer for appropriate output current.

6 Ceramic Capacitors

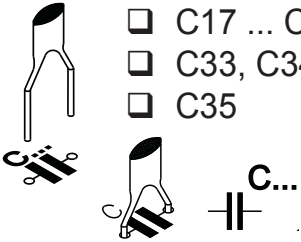

- C17 ... C32 : 820pF (821)
- C33, C34 : 22pF (22)
- C35 : 470nF (474)

7 Vertical diodes

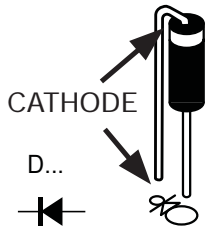

Watch the polarity!

- D1, D2 : 1N4007

8 USB connector



- SK6

9 Board to wire

- SK1 : 4p (MOTOR 1)
- SK2 : 4p (MOTOR 2)
- SK3 : 4p (MOTOR 3)
- SK4 : 4p (MOTOR 4)
- SK7 : 2p (SW1)
- SK8 : 2p (SW2)
- SK9 : 2p (SW3)
- SK10 : 2p (SW4)
- SK11 : 2p (SW5)
- SK12 : 2p (SW6)
- SK13 : 3p (OUT)

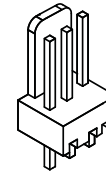
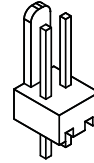
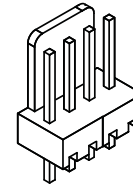

10 Inductor

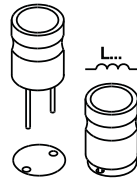

- L1, L2 : 330μH

11 Electrolytic capacitors

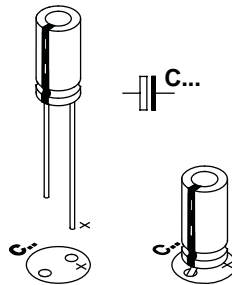

Watch the polarity!

- C1 : 4,7μF (50V)
- C6 : 100μF (35V)
- C9 : 100μF (35V)
- C12 : 100μF (35V)
- C15 : 100μF (35V)
- C39 : 100μF (35V)
- C40 : 330μF (16V)
- C41 : 100μF (**16V**)!!!

12 Terminal Block

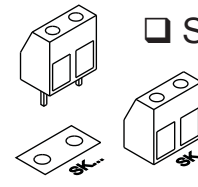

- SK14 : 2p (AC power 10 -30V)

13 Quartz crystal

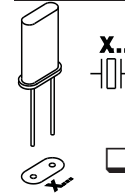

- X1 : 12MHz

14 Switch regulator

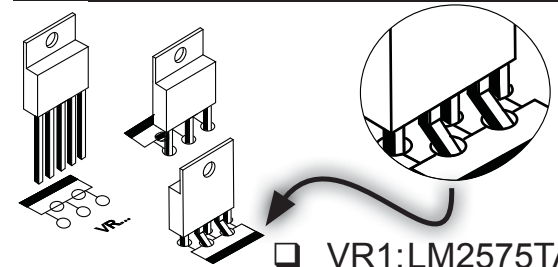

- VR1:LM2575TADJ

15 Bridge

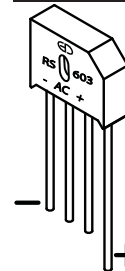

- BR1 : RS603 (6A-200V)

16 Electrolytic capacitors

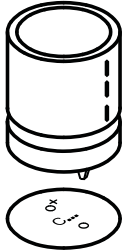

Watch the polarity!



□ C37 : 3300 μ F

17 IC

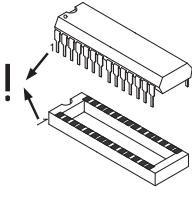

Watch the position
of the notch!

- IC1 : VK8097 (programmed PIC18F4450-I/P)
- IC2 : L6219
- IC3 : L6219
- IC4 : L6219
- IC5 : L6219
- IC6 : ULN2003

18 Rubber feet

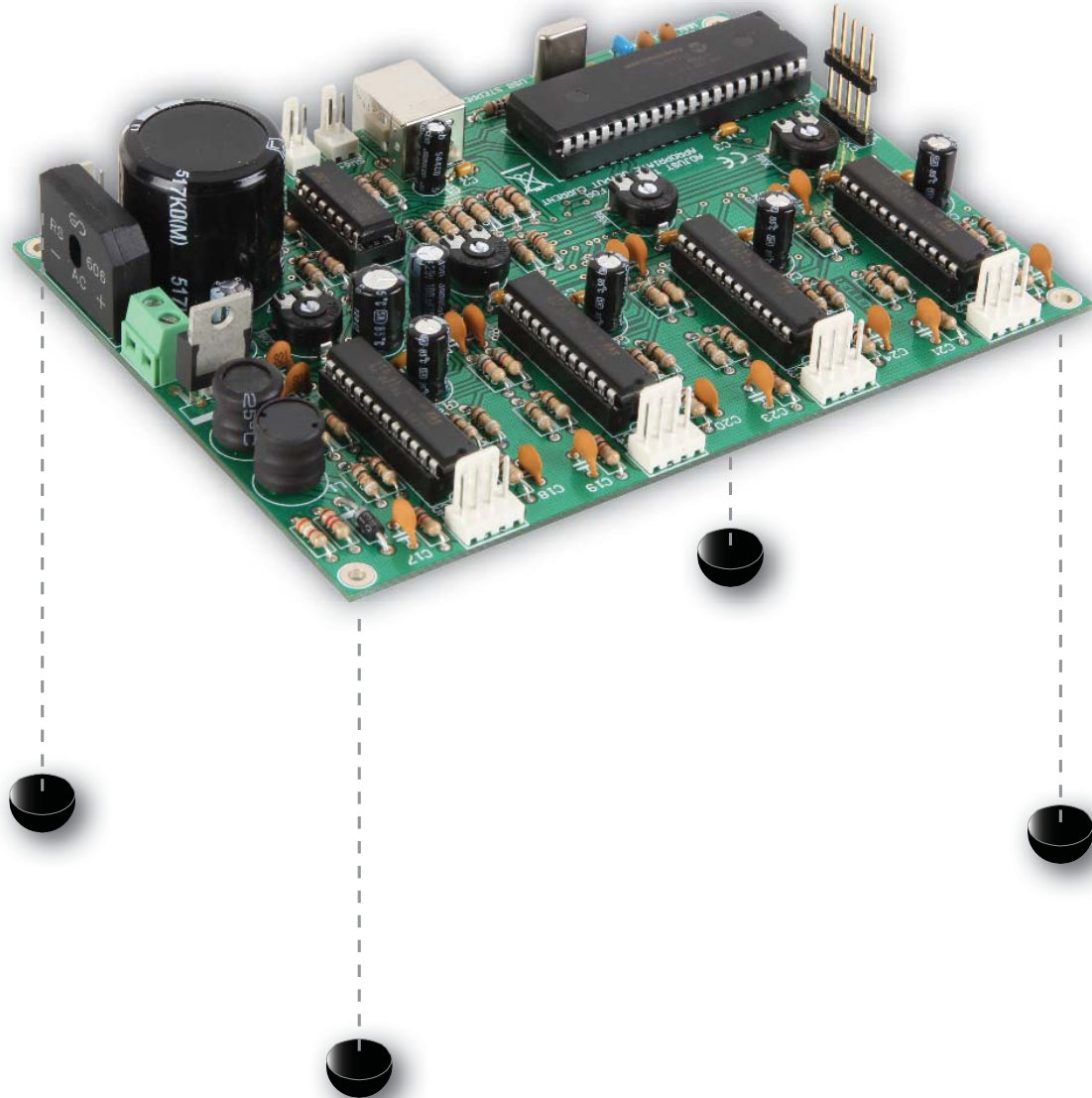

19. SOFTWARE INSTALLATION

After assembly of the circuit, it is now time to install the software.



For software, visit www.vellemanprojects.eu

Step 1: Download the software on our website or via the QR-code.

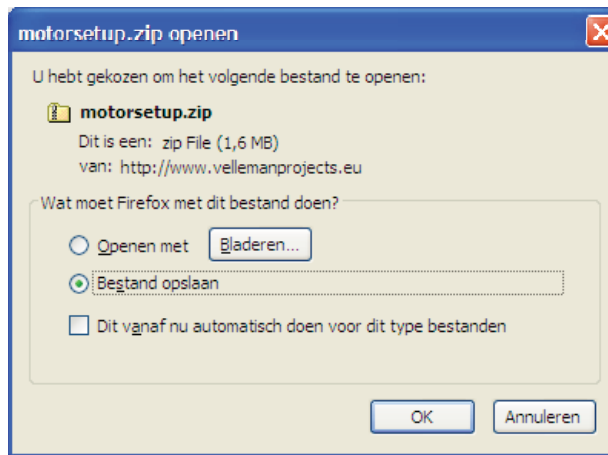

Step 2: open the file en select the software.

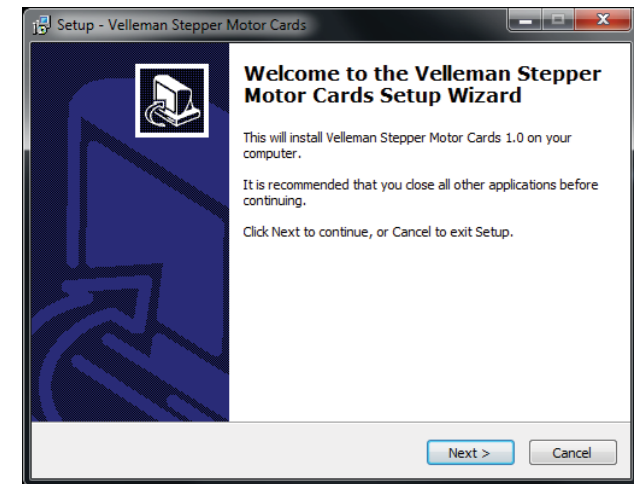

Step 3: Select “next” to begin the installation procedure.

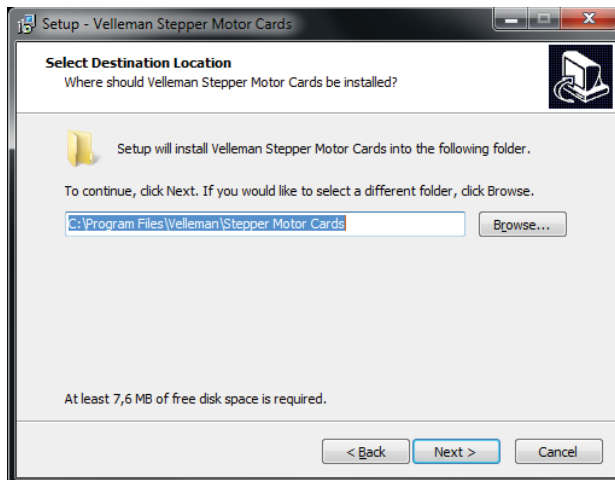

Step 4: Select the destination on your PC

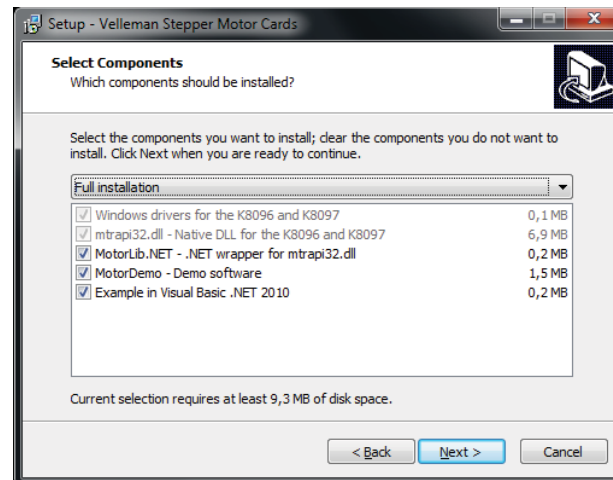

Step 5: Select the type of installation, we recommend the full installation

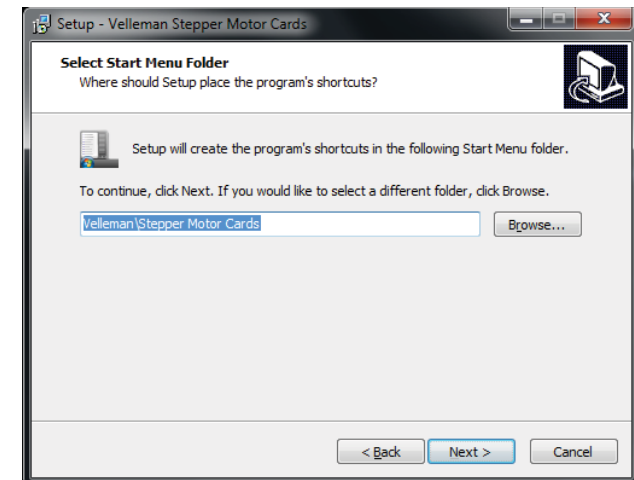

Step 6: Select “next” or browse to select a different folder.

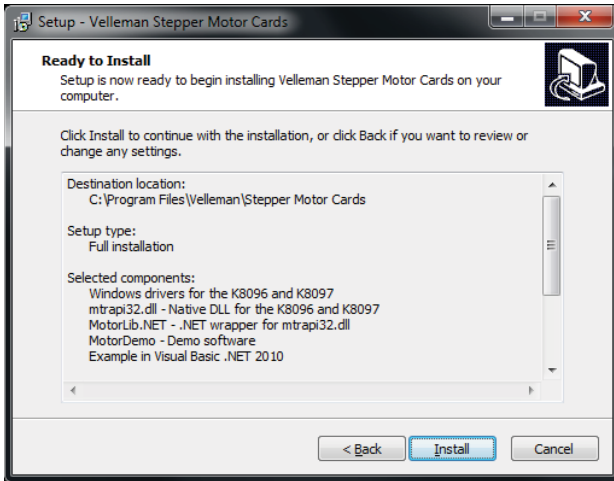

Step 7: Select “install” for installing the software.

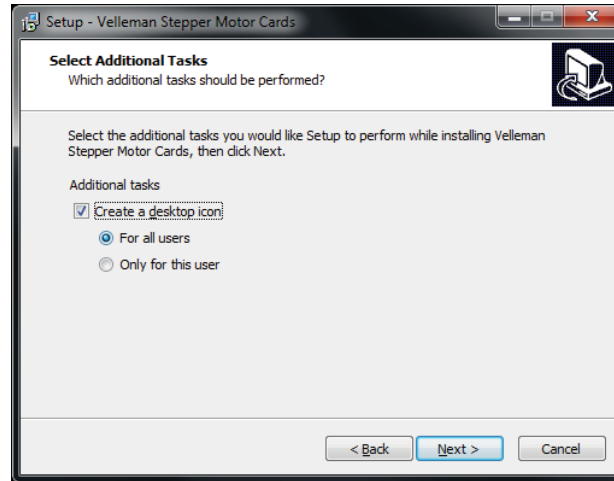

Step 8: Select the additional tasks you would like, then click “next”.

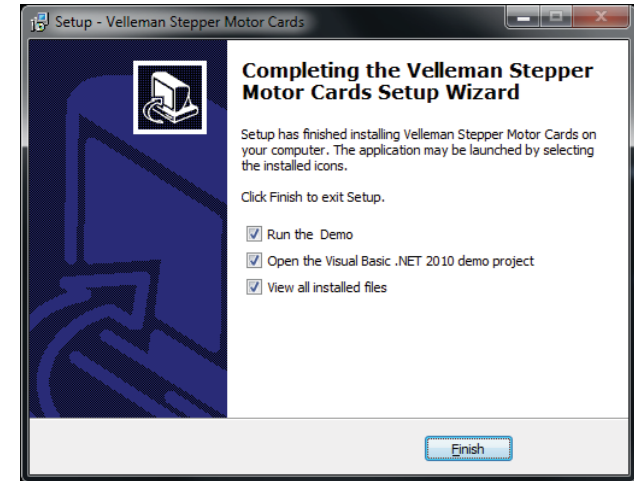

Step 9 : Click “finish” to exit setup.

20. DRIVER INSTALLATION

Connect the USB connector of the K8097 to your PC using an USB cable.

With the first connection, you should install the USB driver of the Stepper Motor Card onto the PC first.

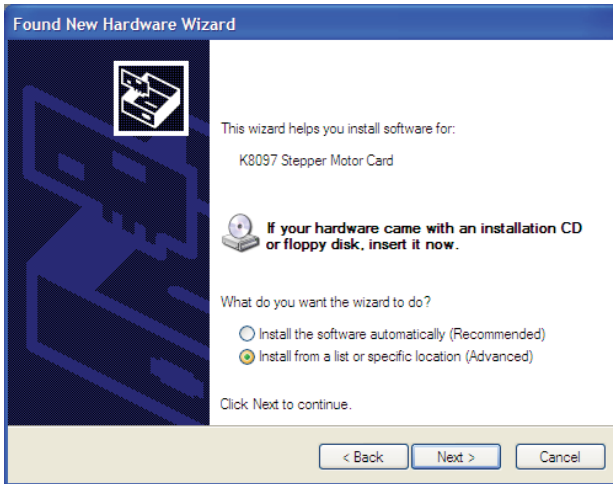

Step 1: Select “specific location”

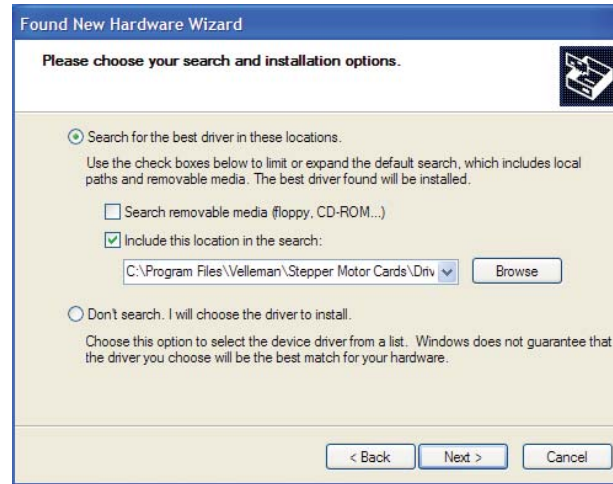

Step 2: Choose the desired location on your hard drive (the default location is C:\Program Files\Velleman\stepper motor cards\...).



Step 3: Click “Continue Anyway”

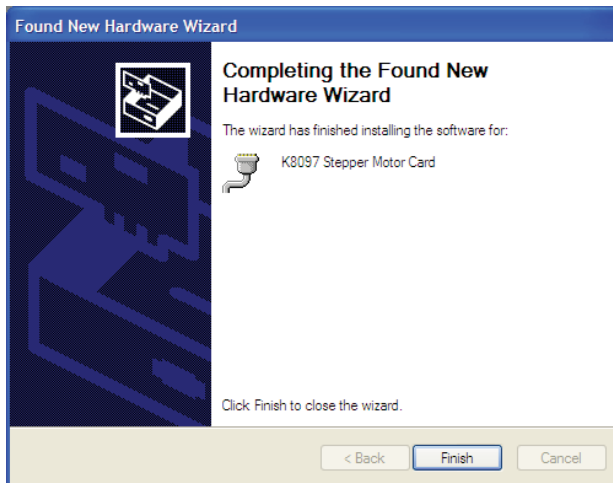

Step 4: Click “Finish”

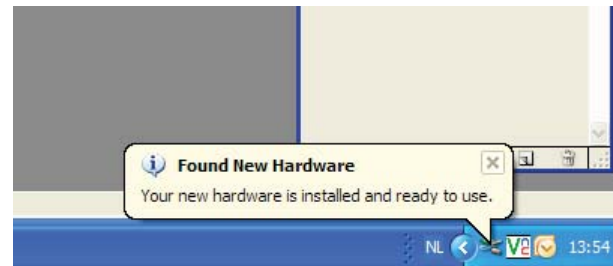

Installation is successful

The screens can change depending the used Windows™ software version.

21. CONNECTION DIAGRAM : OUTPUT - POWER SUPPLY - PC

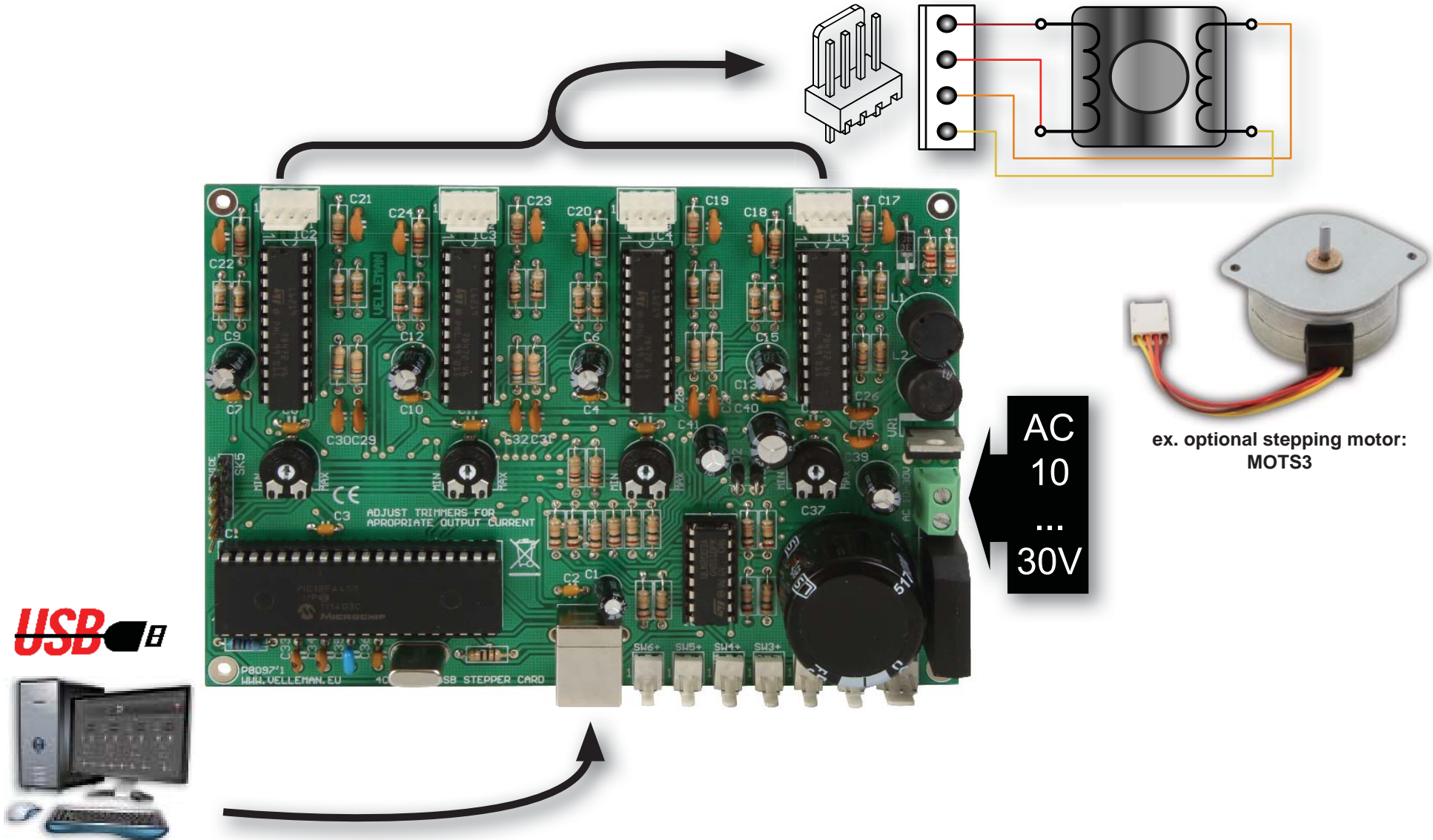

22. CONNECTION DIAGRAM : INPUTS

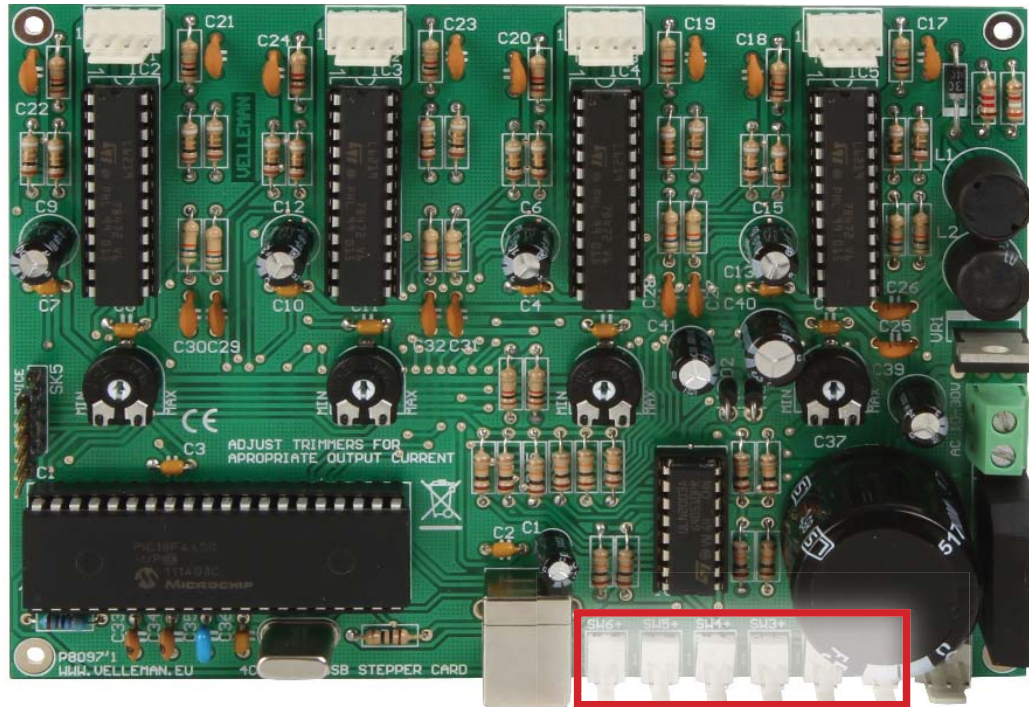

INPUT
.....

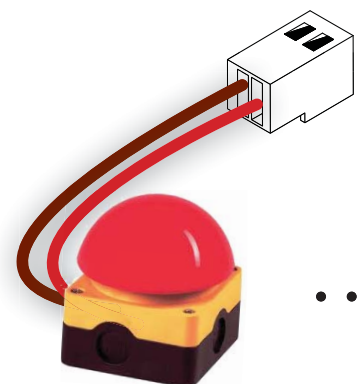

ex. alert switch

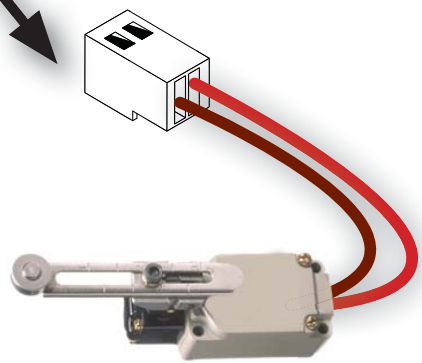

ex. limit switch

23. CONNECTION DIAGRAM : OPEN-COLLECTOR

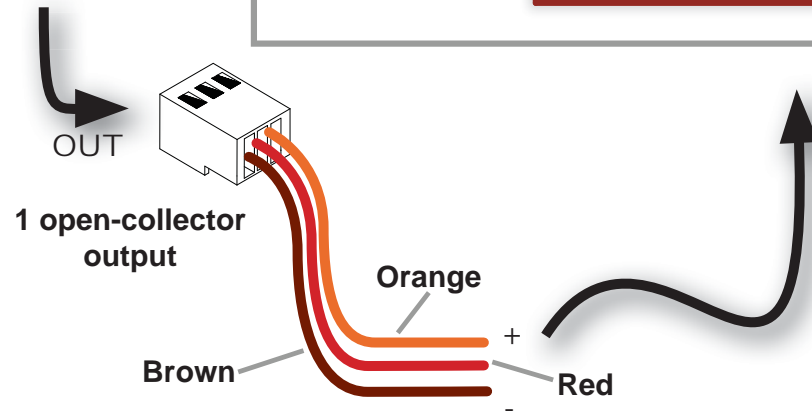
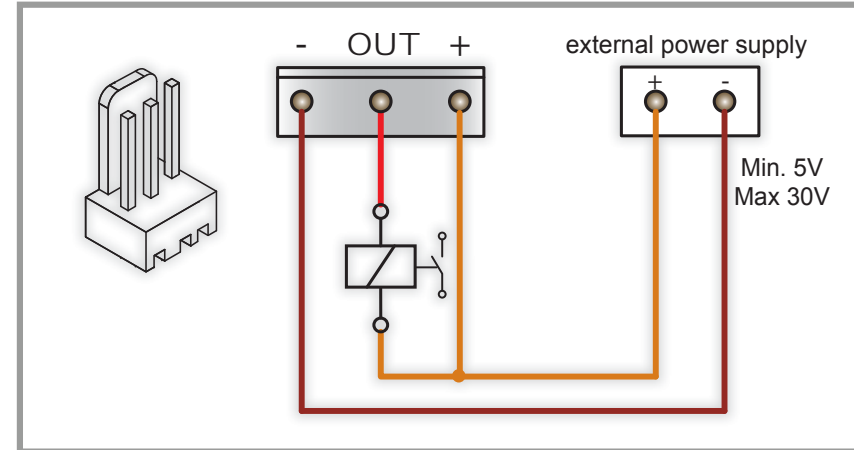
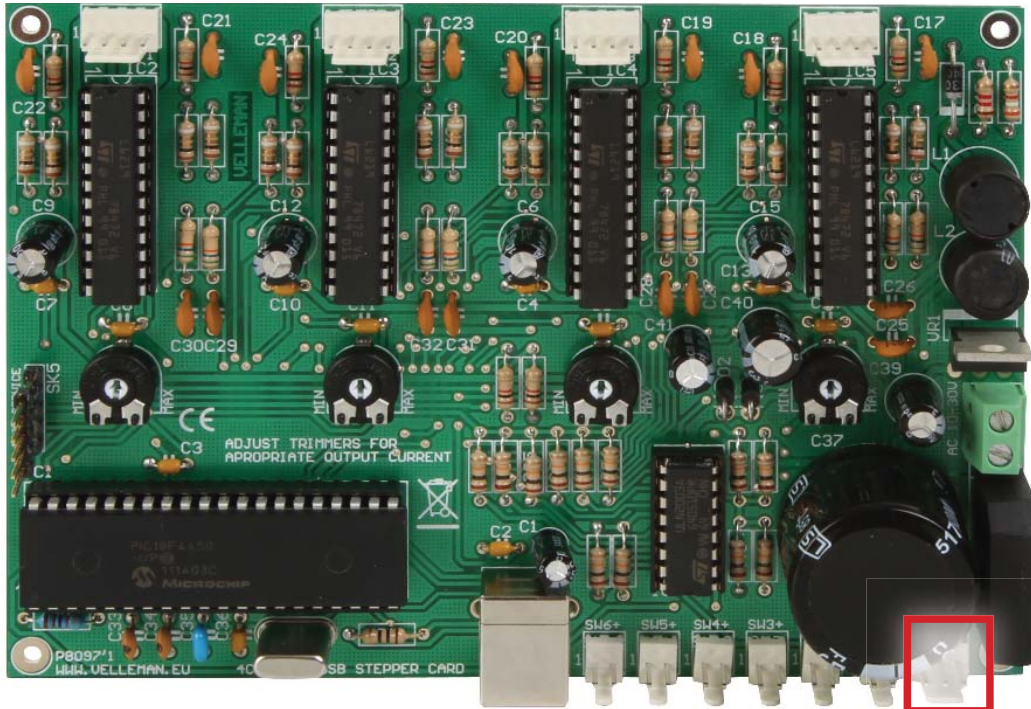

24. MOTOR DEMO

Start the program by clicking the icon  on your desktop.

Card Type: Select the type of motor card that you want to control*

Port: Fill in the COM port number to which the card is connected.
You can find this as follows: START ⇒ CONTROL PANEL ⇒ DEVICE MANAGER ⇒ PORTS.

Disconnect: When closing the program or removing the card, always use Disconnect to guarantee a correct shutdown.

Connect: You can connect to the card when “Card type” and “Port” are filled in.

Steps: Fill in the number of steps the motor needs to execute..

Speed: This indicated the time between each step. A larger number results in a slower running motor. A lower number results in a faster running motor. Min: 1. Max: 255. If the number is too low, it is possible that the motor stops running, depending on the motor’s properties.

Left: Let the motor turn to the left according to the selected number of steps. This button lights when the motor runs or stops.

Right: Let the motor turn to the right according to the selected number of steps. This button lights when the motor runs or stops.

Stop: Cancel a command.

Torque: By pressing this button, you can lock the rotor. Commands are still possible, but if the motor is not running, the rotor is locked so it cannot rotate by applying an external force. The indicator shows when the rotor is locked or when the motor is running (because the motor then cannot be influenced by external forces).

Inputs: The inputs show the status of each input, activated or not.

Output: This button switches the output on or off. The indicator shows the current setting.

Demo: This button switches the demo mode on or off. The indicator shows the current setting.

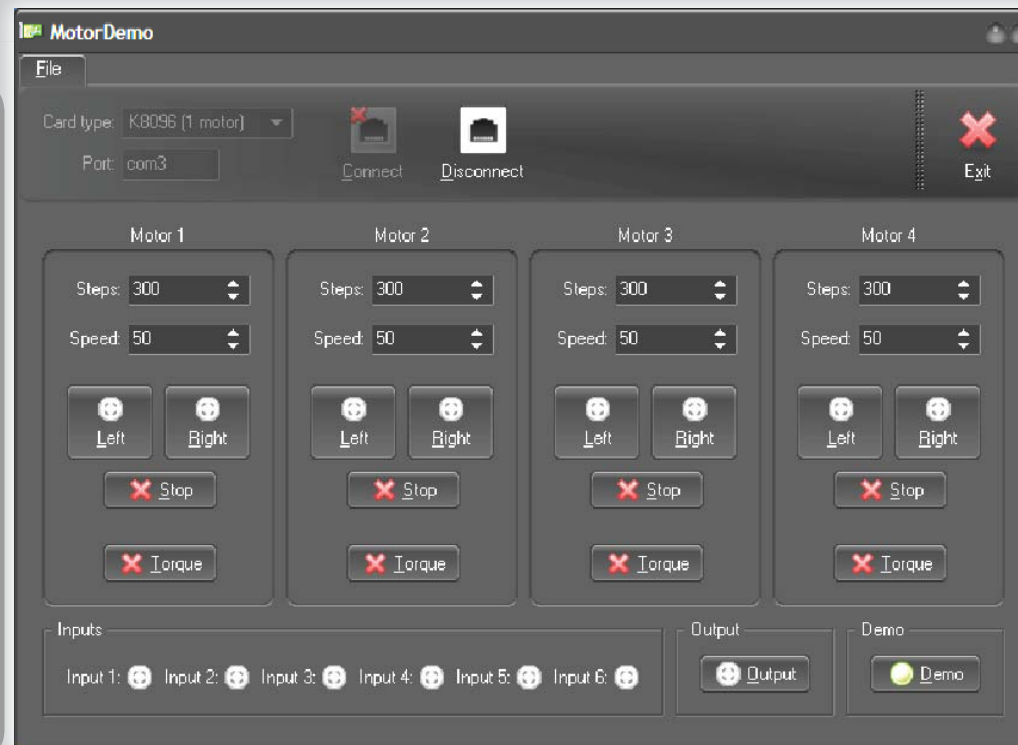

* The first channel is only active if K8096 is selected.

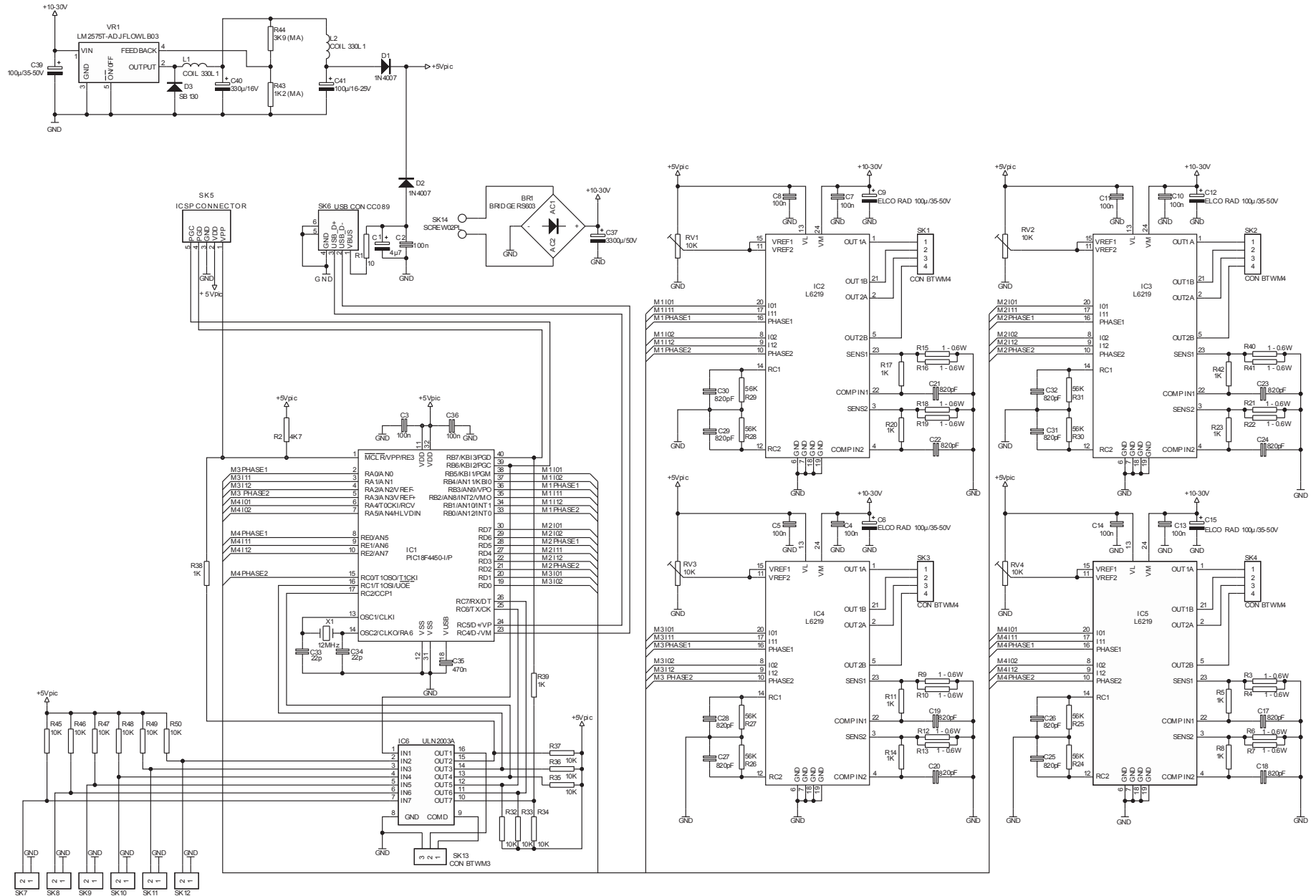



Velleman N.V.

Legen Heirweg 33

9890 Gavere

(België)

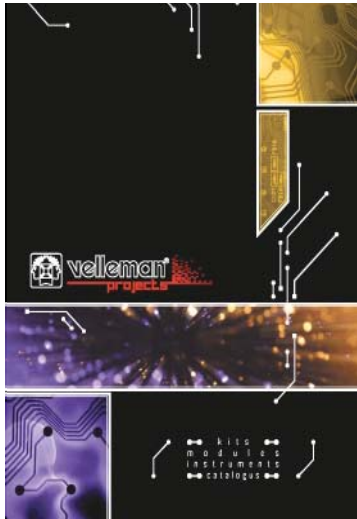

The new Velleman Projects catalogue is now available. Download your copy here:
www.vellemanprojects.eu



Modifications and typographical errors reserved - © Velleman nv. H8097'IP
Velleman NV, Legen Heirweg 33 - 9890 Gavere.