

KA05

ILLUSTRATED ASSEMBLY MANUAL HKA05P'1

IN/OUT shield for Arduino®



velleman®
projects

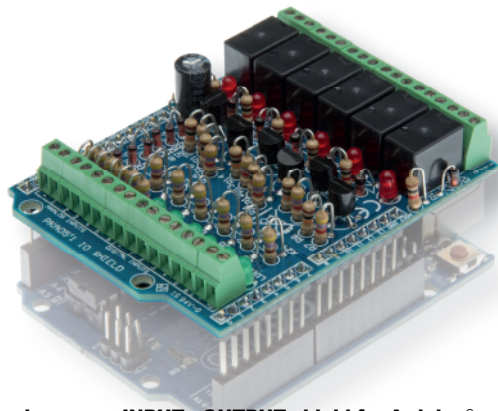

General purpose INPUT - OUTPUT shield for Arduino®

Features

- For use with Arduino Due, Arduino Uno, Arduino Mega
- 6 analog inputs
- 6 digital input
- 6 relay contact outputs: 0.5A max 30V (*)
- Indicator leds for relay outputs and digital inputs

Specifications

- Analog inputs: 0..+5VDC
- Digital inputs: dry contact or open collector
- Relays: 12V
- Relay contacts: NO/NC 24VDC/1A max.
- Dimensions: 68 x 53mm / 2.67 x 2.08"



(*) It is required to power the Arduino UNO (not supplied) with a 12V DC 500mA power supply (not supplied). This shield will not work with the Arduino Yún. Use the KA08 or VMA08 with the Arduino Yún.

Search product

Search Product

Navigation

- ▶ [Flash card](#)
- ▶ [Products](#)
- ▶ [Sales outlets](#)
- ▶ [Support](#)
- ▶ [Publications](#)
- ▶ [Jobs](#)
- ▶ [About us](#)

News

NEW HK303 LED CWB

CubaAromator software
available for download
here!!

Posted on 04-08-12

[Read more...](#)

Velleman Projects Newsletter

Are you an electronics enthusiastic or simply interested in our kits, mini-kits, modules and instruments?

Subscribe to our Newsletter and receive every month the latest news, new products & updates on Velleman Projects.

You will receive an e-mail. Click on the link in that e-mail to confirm your subscription.

email:



Do you want to unsubscribe? Click on the 'unsubscribe' link in the footer of the last received newsletter from Velleman Projects.



- [velleman.eu](#)
- [helloworld.eu](#)
- [joomla.eu](#)
- [vellemanprojects.com](#)
- [info@velleman.eu](#)
- [vello.eu](#)
- [forums.velleman.eu](#)

Advertisements

- EM1
- EM2
- EM
- KAS303 / VML103
Android Application**



Subscribing our newsletter?, visit www.vellemanprojects.eu

Login Register

Help Search

View unanswered posts | View active topics

It is currently 04 Aug 2012 01:46 pm

Support

10 Topics in 10/10

Message	Topics	Posts	Last post
Faire un robot: Programmation de l'Arduino Uno - Kit en anglais (FR) Mediation - Instrument Support	2	2	Fri May 04, 2012 01:46 pm VELLUM ✎
Faire un robot: Programmation de l'Arduino Uno - Kit en français (FR) Mediation - Instrument Support	3	4	Fri May 04, 2012 02:02 pm VELLUM ✎
Modules Velleman (Mini) Automation Central section for our new Velleman Home Automation System (MiniKit) Mediation - Instrument Support	424	2072	Tue May 15, 2012 03:03 pm Clouet ✎
Kits (Building complete - Projects & boards) General For other topics, general tips and tricks, user advice Mediation - Instrument Support	126	402	Fri May 04, 2012 02:07 pm VELLUM ✎
Audio Kit Projects All audio related projects, amplifiers, volume amplifiers Mediation - Instrument Support	187	2480	Fri May 18, 2012 03:07 pm VELLUM ✎
PC Projected Projects All projects that are connected to the PC via USB/RS485 serial Mediation - Instrument Support	2438	6948	The Sep 13, 2012 03:04 pm VELLUM ✎
Microcontroller (Single-board) - Experimental Projects Here you can discuss PCB programming, assembly, etc. Mediation - Instrument Support	447	1748	Fri May 11, 2012 03:07 pm VELLUM ✎
Home Automation All about our home related projects from regular checks to programmable clocks Mediation - Instrument Support	241	884	Fri May 04, 2012 03:07 pm VELLUM ✎
Velleman Projects Project-related projects, from light effects to remote control Mediation - Instrument Support	638	2283	Fri May 18, 2012 03:08 pm VELLUM ✎



Participate our Velleman Projects Forum



Velleman N.V.
Legen Heirweg 33
9890 Gavere
(België)

assembly hints

1. Assembly (Skipping this can lead to troubles !)

Ok, so we have your attention. These hints will help you to make this project successful. Read them carefully.

1.1 Make sure you have the right tools:

- A good quality soldering iron (25-40W) with a small tip.
- Wipe it often on a wet sponge or cloth, to keep it clean; then apply solder to the tip, to give it a wet look. This is called 'thinning' and will protect the tip, and enables you to make good connections. When solder rolls off the tip, it needs cleaning.
- Thin raisin-core solder. Do not use any flux or grease.
- A diagonal cutter to trim excess leads. To avoid injury when cutting excess leads, hold the lead so they cannot fly towards the eyes.
- Needle nose pliers, for bending leads, or to hold components in place.
- Small blade and Phillips screwdrivers. A basic range is fine.

☞ For some projects, a basic multi-meter is required, or might be handy.

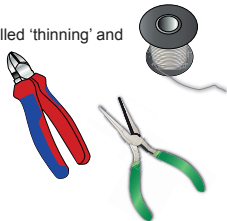

1.2 Assembly Hints :

- Make sure the skill level matches your experience, to avoid disappointments.
- Follow the instructions carefully. Read and understand the entire step before you perform each operation.
- Perform the assembly in the correct order as stated in this manual.
- Position all parts on the PCB (Printed Circuit Board) as shown on the drawings.
- Values on the circuit diagram are subject to changes, the values in this assembly guide are correct*.
- Use the check-boxes to mark your progress.
- Please read the included information on safety and customer service.

* Typographical inaccuracies excluded. Always look for possible last minute manual updates, indicated as 'NOTE' on a separate leaflet.

1.3 Soldering Hints :

1. Mount the component against the PCB surface and carefully solder the leads. →

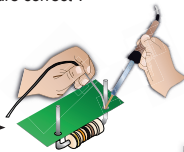

2. Make sure the solder joints are cone-shaped and shiny. →



3. Trim excess leads as close as possible to the solder joint. →



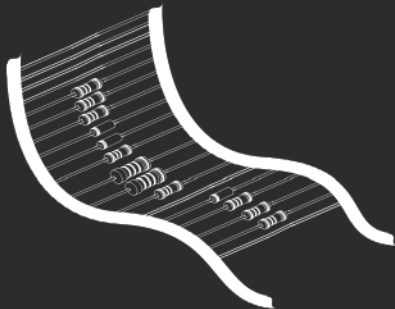

REMOVE THEM FROM THE TAPE ONE AT A TIME !

Included in
this kit

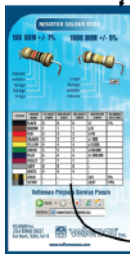

2. RESISTOR

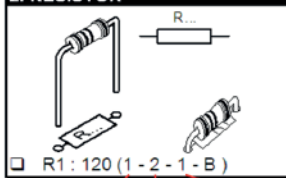

COLOUR	COLOUR NAME	1ST DIGIT/ STRIPE	2ND DIGIT/ STRIPE	3RD DIGIT/ STRIPE	MULTIPLIER STRIPE	TOL 4TH!
BLACK	BLACK	0	0	0	x1	1%
BROWN	BROWN	1	1	1	x10	
RED	RED	2	2	2	x100	
ORANGE	ORANGE	3	3	3	x1.000	
YELLOW	YELLOW	4	4	4	x10.000	
GREEN	GREEN	5	5	5	x100.000	
BLUE	BLUE	6	6	6	x1.000.000	

DO NOT BLINDLY FOLLOW THE ORDER OF THE COMPONENTS ON THE TAPE. ALWAYS CHECK THEIR VALUE ON THE PARTS LIST!

I CONSTRUCTION

1 Ceramic capacitor

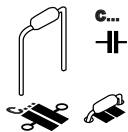

- C2: 100nF (104)

2 Diodes

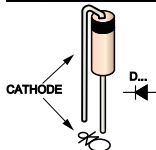

Watch the polarity!

- D1 : 1N4148
- D2 : 1N4148
- D3 : 1N4148
- D4 : 1N4148
- D5 : 1N4148
- D6 : 1N4148
- D7 : 1N4148
- D8 : 1N4148
- D9 : 1N4148
- D10: 1N4148
- D11: 1N4148
- D12: 1N4148

3 Zenerdiodes

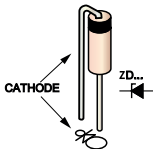

- ZD1 : 5V1
- ZD2 : 5V1
- ZD3 : 5V1
- ZD4 : 5V1
- ZD5 : 5V1
- ZD6 : 5V1

Watch the polarity!

4 LED

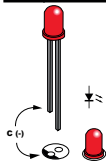

- LD1 : Red
- LD2 : Red
- LD3 : Red
- LD4 : Red
- LD5 : Red
- LD6 : Red

Watch the polarity!

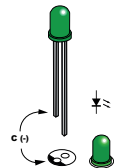

- LD7 : Green
- LD8 : Green
- LD9 : Green
- LD10: Green
- LD11: Green
- LD12: Green

5 Transistors

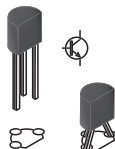

- T1: BC547B
- T2: BC547B
- T3: BC547B
- T4: BC547B
- T5: BC547B
- T6: BC547B

6 Resistors

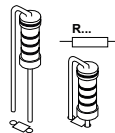

- R1 : 1K (1-0-2-B)
- R2 : 1K (1-0-2-B)
- R3 : 1K (1-0-2-B)
- R4 : 1K (1-0-2-B)
- R5 : 1K (1-0-2-B)
- R6 : 1K (1-0-2-B)
- R7 : 4K7 (4-7-2-B)
- R8 : 10K (1-0-3-B)
- R9 : 4K7 (4-7-2-B)
- R10: 10K (1-0-3-B)
- R11: 4K7 (4-7-2-B)
- R12: 10K (1-0-3-B)

- R13: 4K7 (4-7-2-B)
- R14: 10K (1-0-3-B)
- R15: 4K7 (4-7-2-B)
- R16: 10K (1-0-3-B)
- R17: 4K7 (4-7-2-B)
- R18: 10K (1-0-3-B)
- R19: 470 (4-7-1-B)
- R20: 470 (4-7-1-B)
- R21: 470 (4-7-1-B)
- R22: 470 (4-7-1-B)
- R23: 470 (4-7-1-B)
- R24: 470 (4-7-1-B)
- R25: 4K7 (4-7-2-B)
- R26: 4K7 (4-7-2-B)
- R27: 4K7 (4-7-2-B)
- R28: 4K7 (4-7-2-B)
- R29: 4K7 (4-7-2-B)
- R30: 4K7 (4-7-2-B)

7 Terminal blocks

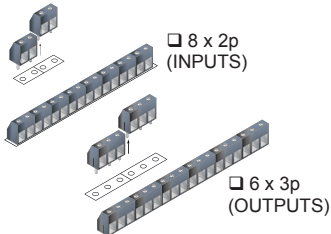

8 Relays

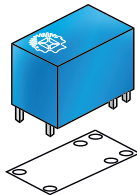

- RY1
- RY2
- RY3
- RY4
- RY5
- RY6

9 Electrolytic capacitors



Watch the polarity!

- C1 : 100µF

10 Male header

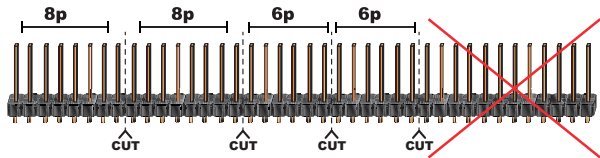

2 X 6 pins

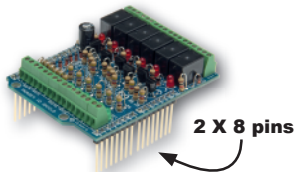

II CONNECTION DIAGRAM

1 OUTPUT MAX. 24VDC / 1A

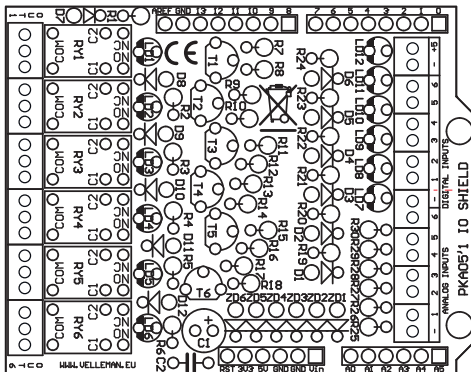
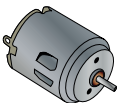

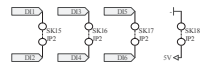
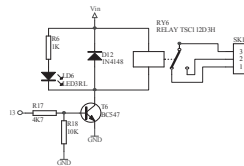
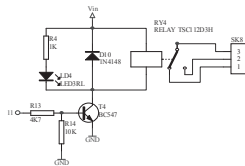
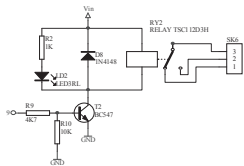
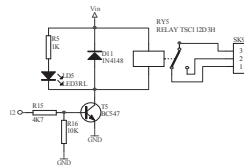
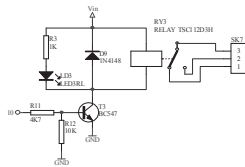
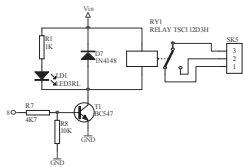
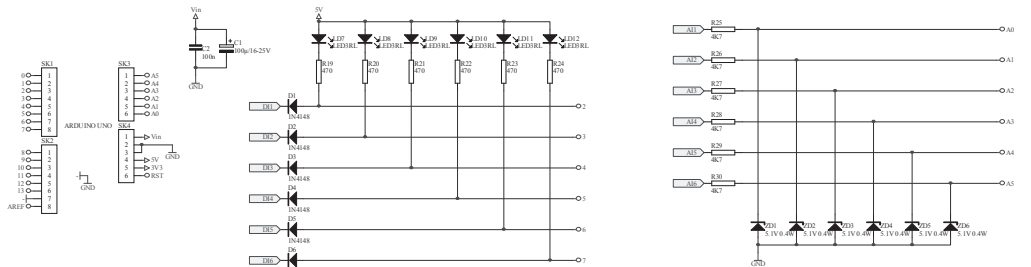

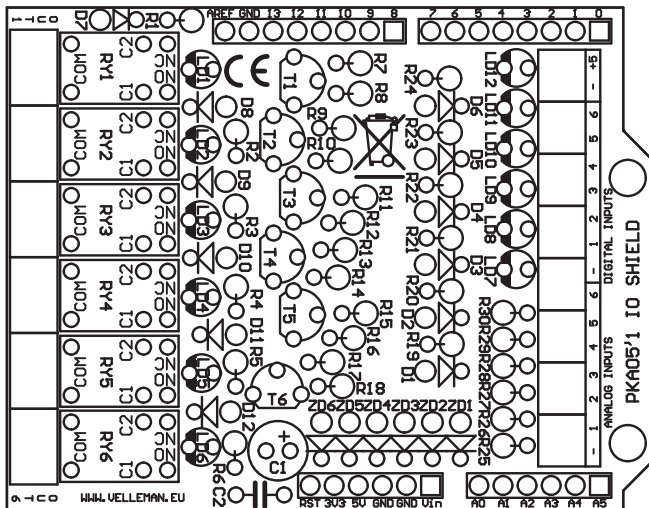

Leds and how to use them

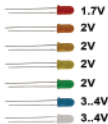

Leds feature a specific voltage drop, depending on type and colour. Check the datasheet for exact voltage drop and rated current !

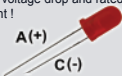

Never connect leds in parallel

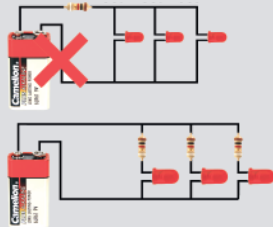

How to Calculate the series resistor:

Example: operate a red led (1.7V) on a 9Vdc source.

Required led current for full brightness: 5mA (this can be found in the datasheet of the led)

$$\frac{\text{Supply voltage (V) - led voltage (V)}}{\text{required current (A)}} = \text{series resistance (ohms)}$$

$$\rightarrow \frac{9V - 1.7V}{0.005A} = 1460 \text{ ohm}$$

closest value :
use a 1k5 resistor

Required resistor power handling=
voltage over resistor x current passed trough resistor

$$\rightarrow (9V - 1.7V) \times 0.005A = 0.036W$$

a standard 1/4W resistor
will do the job

LEDs in series:

Example: 3 x red led (1.7V) on 9V battery
Required led current for full brightness: 5mA
(this can be found in the datasheet of the led)

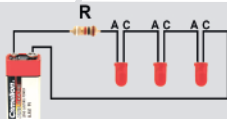

$$\frac{\text{Supply voltage (V) - (number of leds x led voltage (V))}}{\text{required current (A)}} = \text{series resistance (ohms)}$$

$$\rightarrow \frac{9V - (3 \times 1.7V)}{0.005A} = 780 \text{ ohm}$$

use an
820 ohm resistor

open collector outputs

An open collector output can be compared to a switch which switches to ground when operated

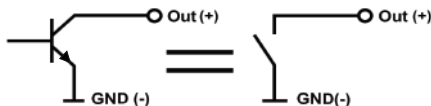

Example: How to switch an LED by means of an open collector output

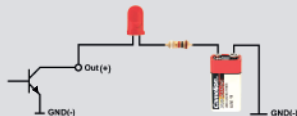

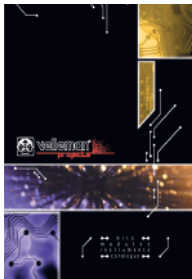

The new Velleman Projects catalogue is
now available. Download your copy here:
www.vellemanprojects.eu



Modifications and typographical errors reserved - © Velleman nv. HKA05'IP (rev.4)
Velleman NV, Legen Heinweg 33 - 9890 Gavere.