

# 1.8° 42MM High Torque Hybrid Stepping Motor

Item	Specifications
Step Angle	1.8°
Step Angle Accuracy	±5% ( full step, no load )
Resistance Accuracy	±10%
Inductance Accuracy	±20%
Temperatru Rise	80°CMax. ( rated current,2 phase on )
Ambient Temperatuar	-20°C~+50°C
Insulation Resistance	100M?Min.,500VDC
Dielectric Strength	500VAC/ for one minute
Shaft Radial Play	0.02Max. ( 450 g-load )
Shaft Axial Play	0.08Max. ( 450 g-load )
Max. radial force	28N ( 20mm foom the flange )
Max.axial force	10N



## ● 42MM Hybrid Stepping Motor Specifications

Model No	Rated Voltage	Current /phase	Resistance /phase	Inductance /phase	Holding Torque	#of Leads	Moment of inertia	Weinght	Orientation Torque	Length
	V	A	Ω	mH	Kg-cm		g-cm <sup>2</sup>	kg	g-cm	mm
SL42STH48-1504A	2.8	1.5	1.2	1.4	5.5	4	68	0.36	200	48

## ● Dimension

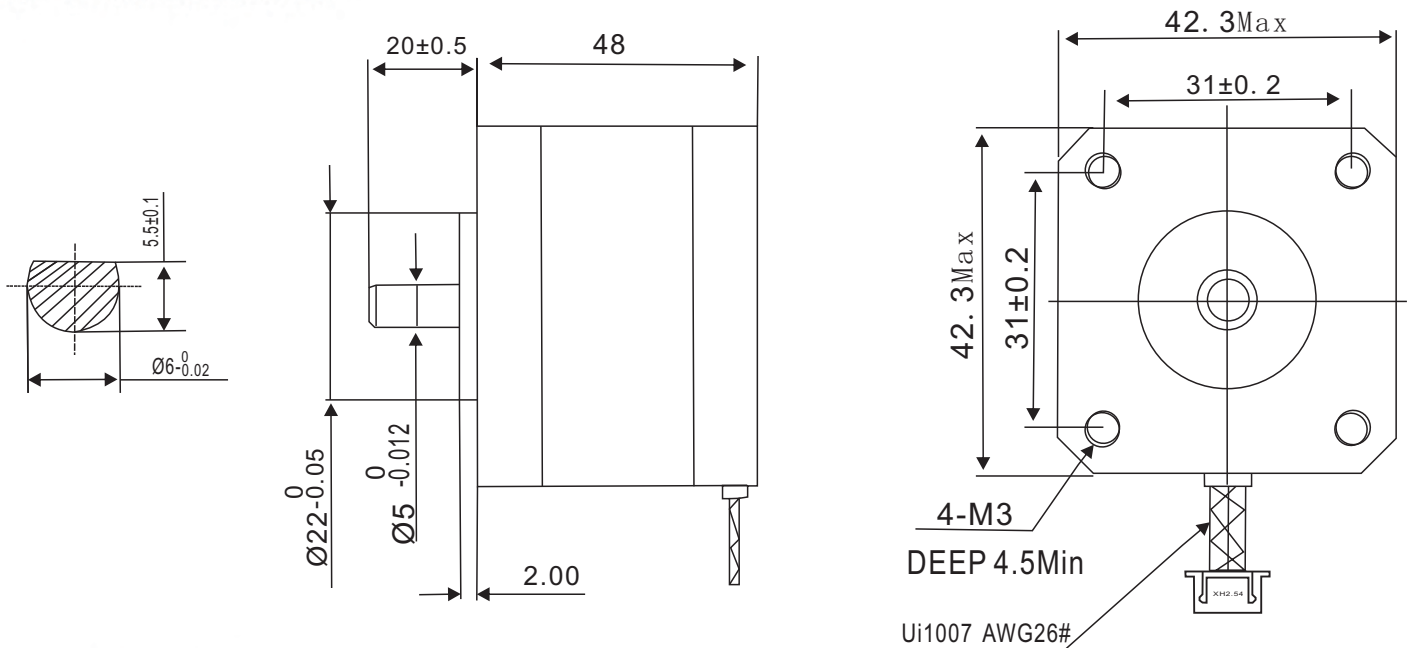

## ● Wiring Diagram

