

## ALKALINE-MANGANESE DIOXIDE BATTERY

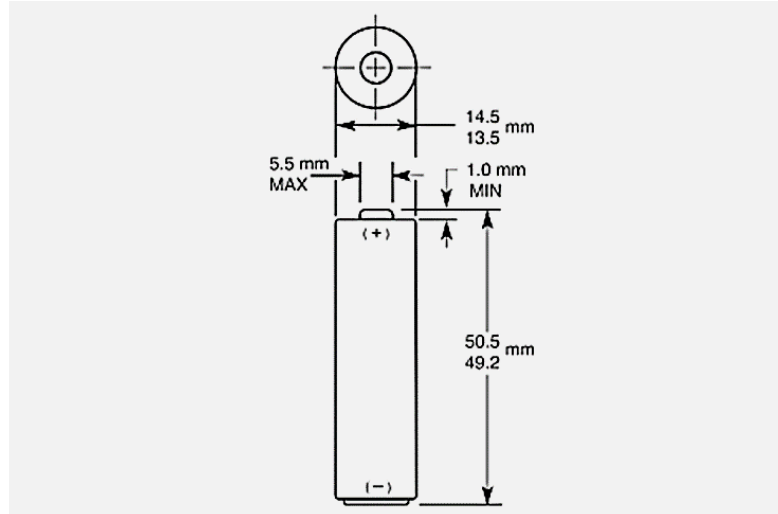

Size: AA (LR6) PX1500



Dimensions shown are IEC standards

### KEY FEATURES

- Reliable Performance
- Excellent resistance to corrosion
- Designed to meet all major quality, safety and environmental standards:
  - Safety: IEC 60086-5
  - ANSI C 18.1M, Part-2
  - EU Battery Directive
  - Quality: ISO 14001 and 9001, Duracell World Class Continuous Improvement Program

### TYPICAL APPLICATIONS

- Medical Devices
- Security Cameras
- Soap Dispensers
- Electronic Door Locks
- Window Blinds/Shades

### ELECTRICAL CHARACTERISTICS

- |   |           |
|---|-----------|
| ▪ Nominal capacity (25 mA Cont., .8V cut-off) | 3,112 mAh |
| ▪ Typical Voltage (at + 20 °C)                | 1.5 V     |
| ▪ AC Impedance @ 1kHz                         | 68 mΩ     |

### PHYSICAL CHARACTERISTICS

- |                  |  |
|------------------|--|
| ▪ Typical weight | 24.3 g (0.9 oz)                            |
| ▪ Typical volume | 8.4 cm <sup>3</sup> (0.5 in <sup>3</sup> ) |
| ▪ Terminals      | Flat                                       |

### OPERATING & STORAGE CONDITIONS

- |  |                                  |
|--|----------------------------------|
| ▪ Operating temperature range  | -20°C to 54°C<br>(-4°F to 130°F) |
| ▪ Recommended Storage (storage area should be clean, cool, dry and ventilated) | 5°C to 30°C<br>(41°F to 86° F)   |

TYPICAL PERFORMANCE

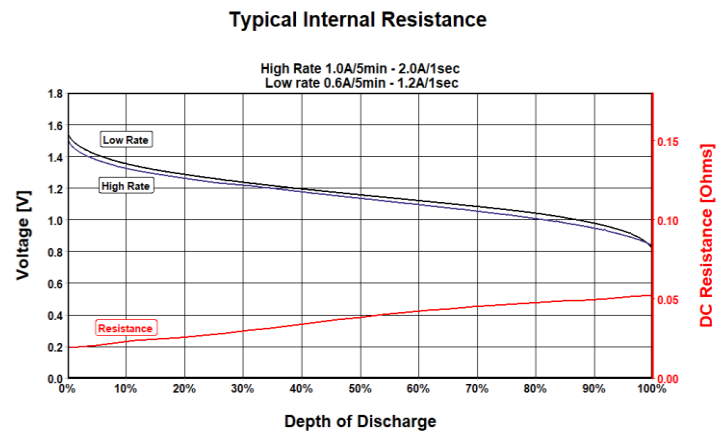
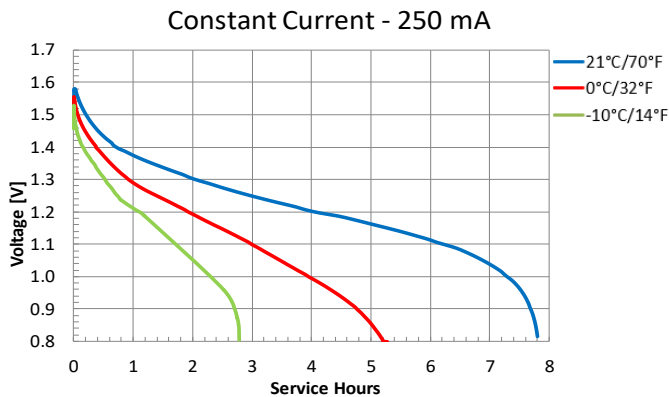
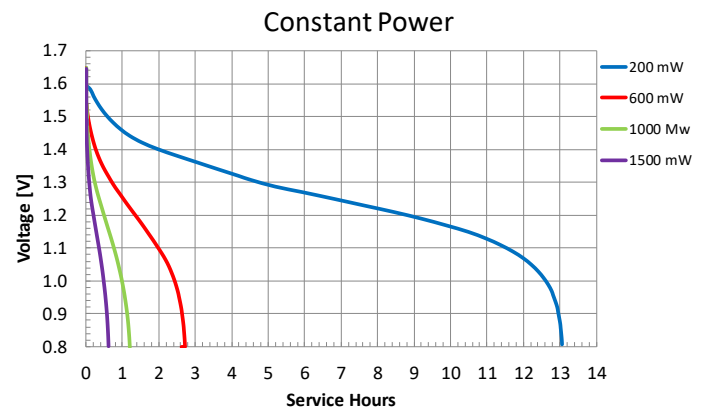
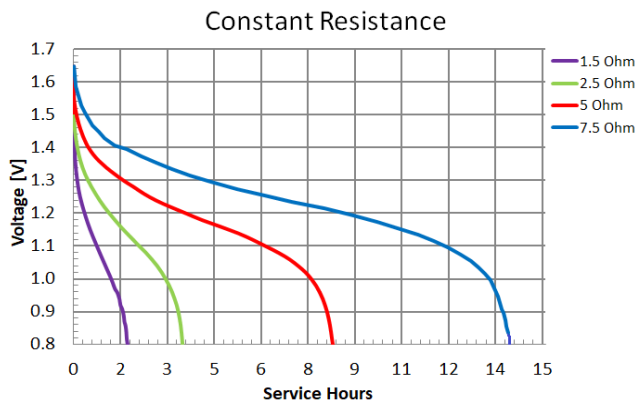
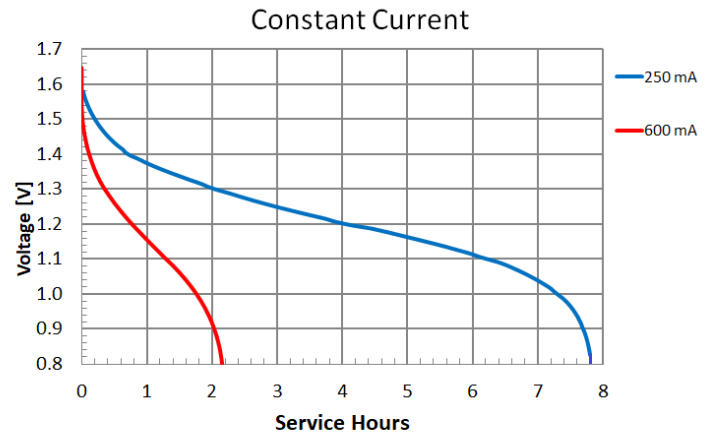
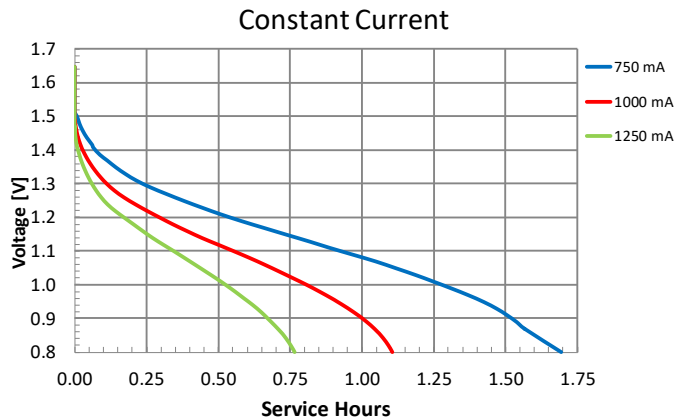

**PROCELL**<sup>®</sup>  
PROFESSIONAL BATTERIES  
Procell Professional batteries  
Berkshire Corporate Park  
Phone: 1-800-544-5454 (Toll-free)  
[www.procell.com](http://www.procell.com)

Delivered capacity is dependent on the applied load, operating temperature and cut-off voltage. Please refer to the charts and discharge data shown for examples of the energy/service life that the battery will provide for various load conditions.

This data is subject to change. Performance information is typical. Contact Duracell for the latest information.