

# SILLA COLGANTE BAHAMAS CON SOPORTE CADEIRA PENDENTE BAHAMAS COM SUPORTE

MODELO: 52483

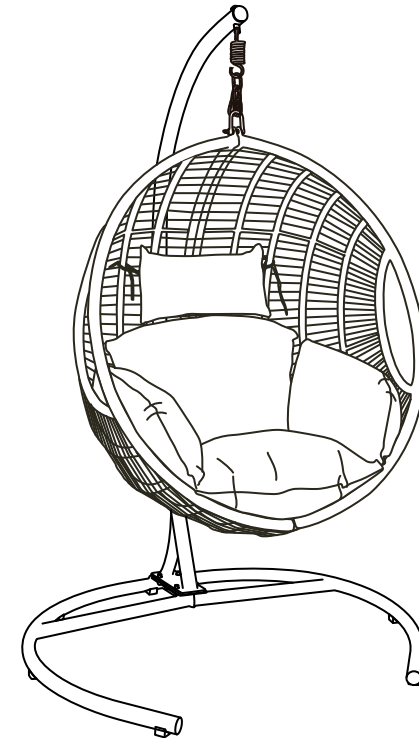

Por cualquier reclamo o desperfecto dirijase a la tienda Sodimac donde adquirió el producto junto con su comprobante de compra, nuestro servicio de post venta lo asistirá con gusto.  
Para quaisquer consultas ou reclamações, dirija-se à loja Sodimac onde adquiriu o produto, munido do comprovante de compra; nosso Serviço de Pós Vendas o atenderá com prazer.

<b>ARGENTINA</b> Teléfono de contacto: 0810-222-7634 www.sodimac.com.ar	<b>BRASIL</b> Telefone para contato: 0300 7634622 www.sodimac.com.br	<b>CHILE</b> Teléfono de contacto: 600 600 4020 www.sodimac.cl	<b>COLOMBIA</b> Teléfono de contacto: 3208899933 www.homecenter.com.co
<b>MEXICO</b> Teléfono de contacto: 01 800 062 5222 www.sodimac.com.mx	<b>PERÚ</b> Teléfono de contacto: 4192000 www.sodimac.com.pe www.maestro.com.pe	<b>URUGUAY</b> Teléfono de contacto: 0800-7634 www.sodimac.com.uy	

Importado y/e Distribuido por: Argentina: FALABELLA S.A., C.U.I.T. 30-65572582-9 - Suipacha 1111 P. 18 (1008) - Buenos Aires. Tel.:54-11-4710-5600. - Brasil : CONSTRUDECOR S.A - CNPJ: 03.439.316/0038-64 - SAC: 55-11-2065-2500. - Chile: SODIMAC S.A., RUT 96.792.430-K. - Av. Pdte. Eduardo Frei M. 3092, Renca, Santiago. Tel.: 56-2-2738-1000 / IMPERIAL S.A., RUT 76.821.330-5. Av. Santa Rosa 7876, La Granja - Santiago - Tel.: 56-2-2399-7000 / FALABELLA RETAIL S.A., RUT 77.261.280-K - Manuel Rodríguez Norte 730, Santiago - Tel.: 600-380-5000 / HIPERMERCADOS TOTTUS S.A., RUT 78.627.210-6 - Nataniel Cox 620 Subterráneo, Santiago - Tel.: 56-2-2827-0211 - Colombia: SODIMAC COLOMBIA S.A., Cód. SIC 800242106; NIT. 800.242.106-2 - Carrera 680 N° 80-70, Bogotá, Tel.: 57-1-3904100 / FALABELLA DE COLOMBIA S.A., NIT.900.017.447-8 - Calle 99 No 11A - 32, No. Reg. SIC: 900017447 - Bogotá - Tel.: 57-1-5878002 Nacional: 01-8000-113252. - Perú: Tiendas del Mejoramiento del Hogar S.A. RUC 20112273922. Av. Angamos Este Nro. 1805 Int. 2, Surquillo - Lima - Lima. Tel: 51-1-2119500 / SAGA FALABELLA S.A., RUC: 20100128056 , Av.Paseo de la República 3220, San Isidro, Lima - Tel.: 51-01-512-3333 / HIPERMERCADOS TOTTUS S.A., Av. Angamos Este 1805 , oficina 5 , Piso 10 , Surquillo, Lima - RUC. 20508565934 - Tel.: 51-01-513-3355 - Uruguay: Homecenter Sodimac S.A., RUT 21.699.665 0015 - Plaza Independencia 811, Montevideo, Uruguay - Tel.: 598-2604-7105 - México: COMERCIALIZADORA SDMHC S.A. de C.V. Avenida Adolfo López Mateos 201, Colonia Santa Cruz Acatlán, Naucalpan de Juárez, Estado de México, C.P. 53150. RFC CSDT61207R2A, Tel.: +52 55 1516 4400. V20200605

IMAGEN/IMAGEM MERAMENTE ILUSTRATIVA

## ATENCIÓN / ATENÇÃO

- Lea el manual de instrucciones, instalación y uso del producto y el certificado de garantía, en caso de dudas consulte al proveedor.
- Ordene las piezas que componen este producto.
- Agrupe y ordene la quincallería.
- Prepare una zona despejada para el montaje.
- Monte las piezas sin forzar los ensambles. Una vez que todas las partes están ensambladas, apretar firmemente.
- Volver a apretar los tornillos después de un tiempo de uso.
- No exponga las partes y piezas a la luz solar directa, pueden sufrir deterioro y deformaciones, especialmente los tableros de madera.
- Conserve el manual de instrucciones.

- Leia o manual de instruções, instalação e uso do produto e as condições de garantia. Em caso de dúvidas, entre em contato com o fornecedor
- Ordene as peças que compõem este produto.
- Agrupe e ordene as peças de montagem.
- Prepare uma superfície desocupada para a montagem.
- Monte as peças sem forçar os encaixes. Uma vez que todas as peças estejam encaixadas, aperte firmemente.
- Reaperte os parafusos após certo período de uso.
- Não exponha as peças à luz solar. A luz solar direta pode deteriorar ou deformar as peças, especialmente as que são feitas de madeira.
- Conserve as instruções.



Personas para armado  
Pessoas para a montagem

CANTIDAD/  
 QUANTIDADE

(A)

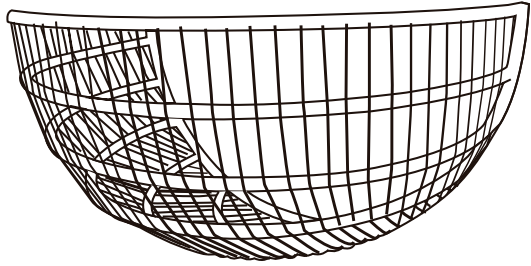

1

(B)



1

(C)



1

(D)

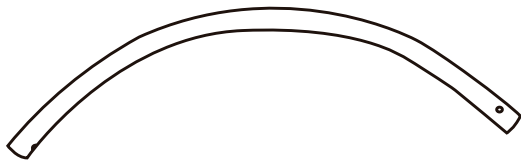

1

(E)

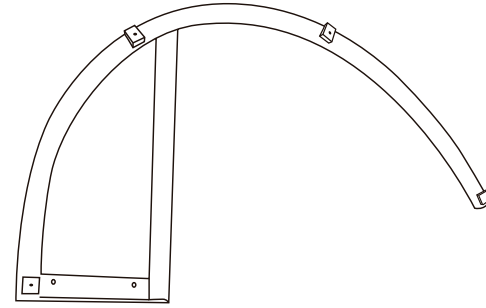

1

(F)

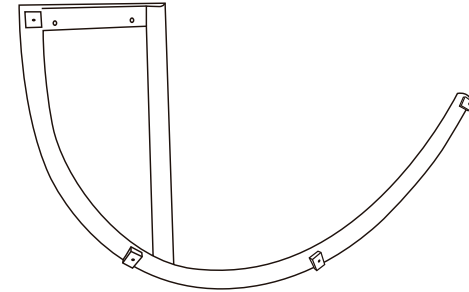

1

(G)

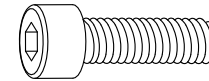

6

(H)

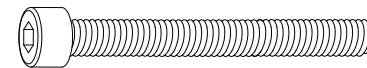

2

(I)

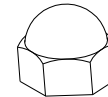

6

(IA)

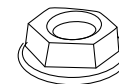









2

(J)

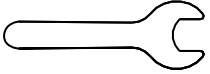

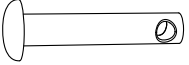
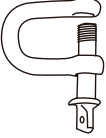
5

(K)		10
(L)		5
(M)		1
(N)		1
(O)		2
(P)		1
(Q)		1
(R)		1
(S)		1
(T)		12

**1**

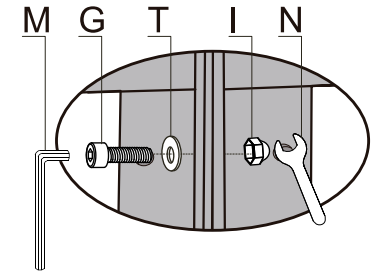
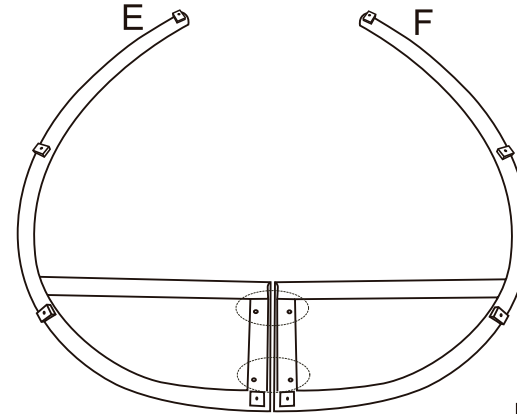

**2**

