

ASSEMBLE INSTRUCTION
 CODE:LDC-17072 NELSON-CAPPUCCINO

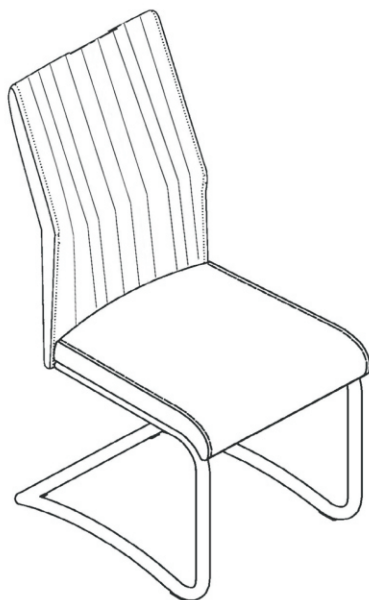

A X1	B X1	C X1	M8x20 X4	M8x22 X4	M6x20 X4
M6x16 X4	M6 X1	M4 X1	X4		
G X4	H X1	I X1	J X4		

2-1

①

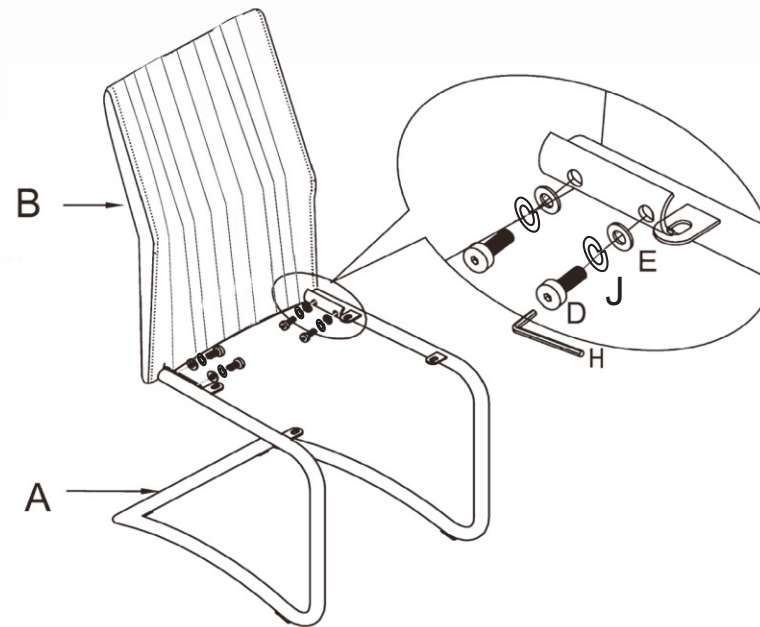

②

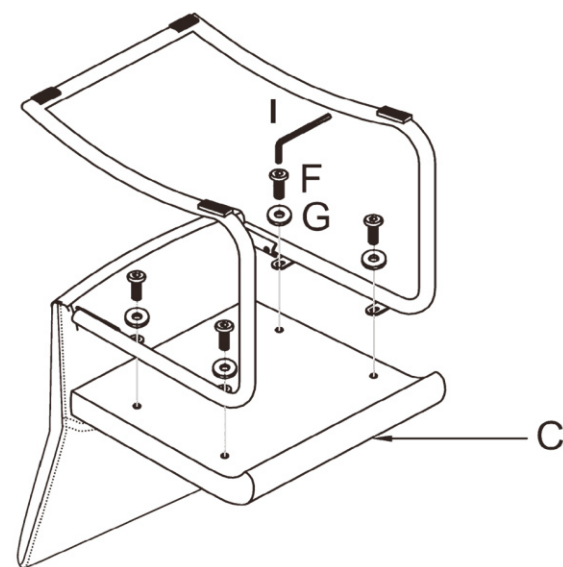

2-2

FT4700 ASSEMBLE INSTRUCTION

Step 1

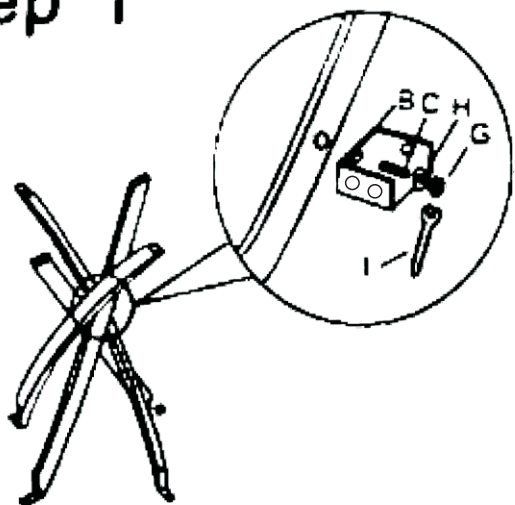

Step 2

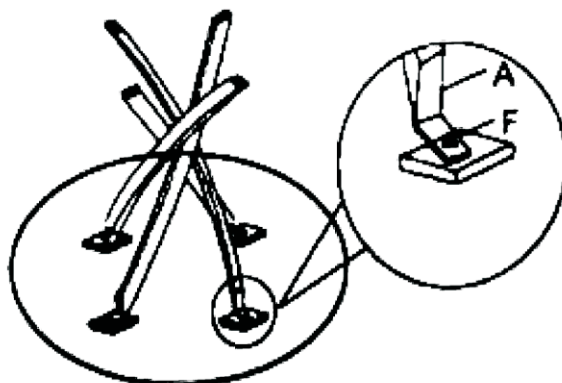

Step 3

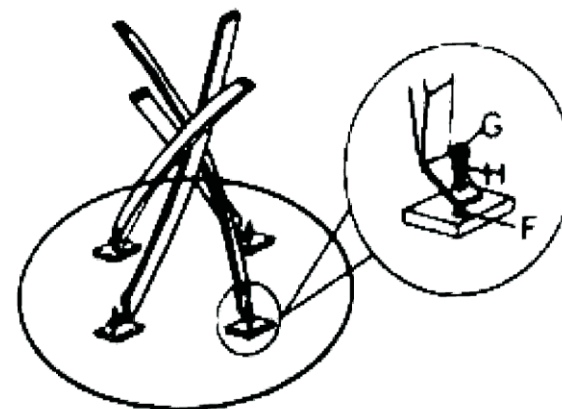



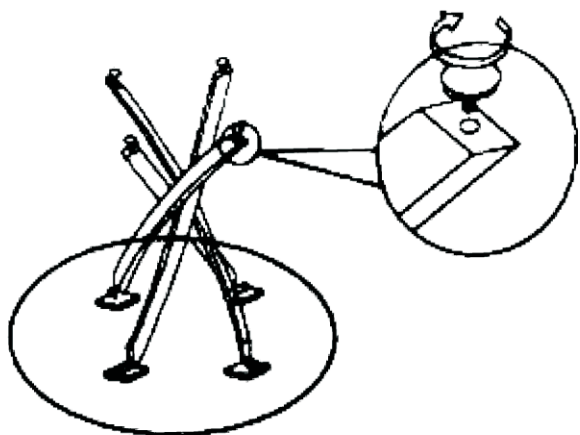



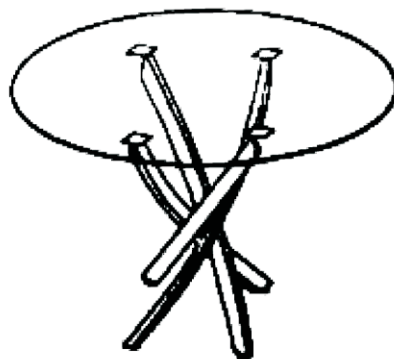

Step 4



Step 5



A		4	I		1
B		1			
C	 8x40mm	8			
D		4			
E		1			
F	 8x20mm	4			
G		12			
H		12			