

MANUAL DE MONTAGEM

ASSEMBLY INSTRUCTIONS

INSTRUCCIONES DE MONTAJE

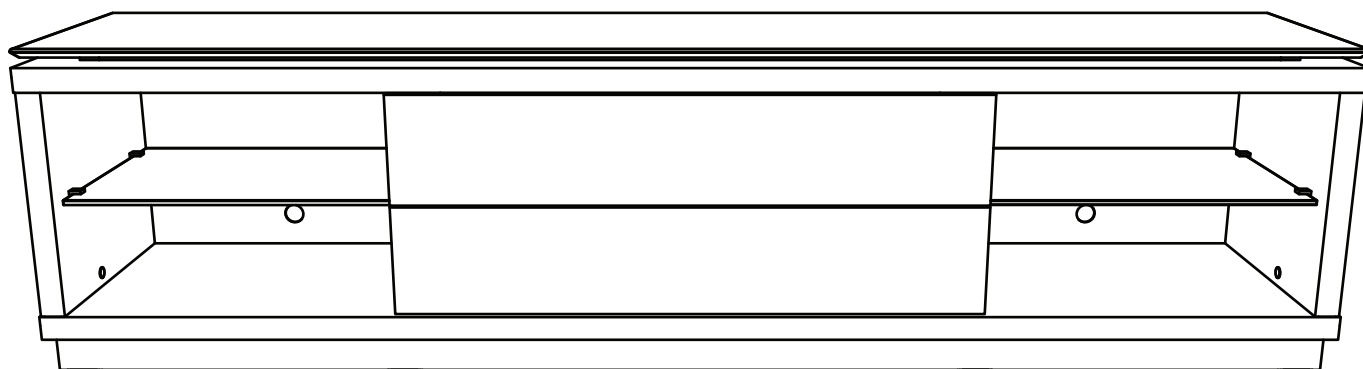

COD: 221300

REV. 01

OBSERVAÇÕES IMPORTANTES

IMPORTANT REMARKS

OBSERVACIONES IMPORTANTES



Nunca escale ou se apoie sobre o móvel. Você pode sofrer graves acidentes.

Never climb or lean on the furniture. You may suffer serious accidents.

Nunca escale o apoye sobre el mobiliario. Usted puede sufrir accidentes graves.

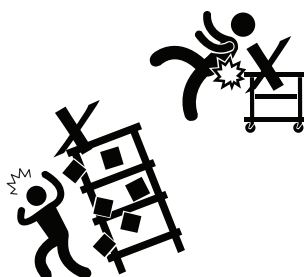

Utilize a embalagem para forrar a área de montagem e separar todas as peças.

Use the packaging to cover the assembly area and separate all parts.

Utilice el embalaje para cubrir la area de montaje y separe las piezas.

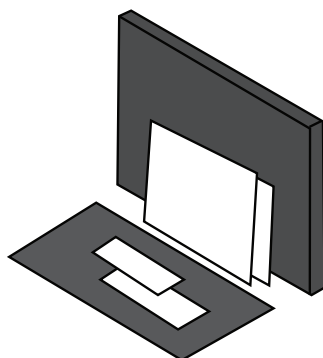

Observe os números impressos nas bordas para identificar as peças.

Identify the parts by observing the number printed on their edges.

Identifique las piezas observando el numero impreso en sus bordes.

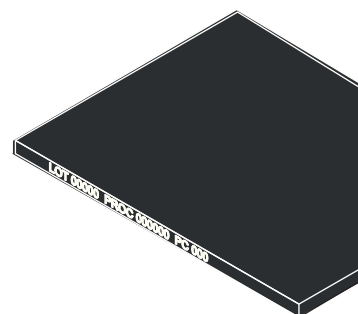

LIMPEZA E CONSERVAÇÃO

CARE INSTRUCTIONS

LIMPIEZA Y CONSERVACIÓN

Limpe com um pano limpo e umedecido em água e sabão neutro. Não utilizar produtos químicos e abrasivos.

Wipe clean using a damp cloth and a mild cleaner. Do not use abrasive and chemical products.

Limpie con un paño limpio humedecido con agua y jabón neutro. No utilice productos químicos y abrasivos



MOVIMENTAÇÃO

HANDLING

MOVIMENTO

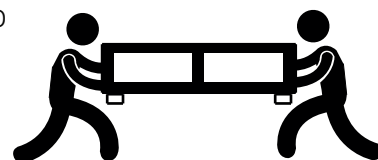

Movimente o móvel com cuidado, sem arrastar. Peça ajuda a outra pessoa para fazê-lo.

Move the piece carefully, don't drag it. Ask for someone else's help to do so.

Mover la unidad con cuidado, sin arrastrar. Pedir ayuda a otra persona para moverlo.

ACESSÓRIOS HARDWARE HERRAJES



Identifique e separe os acessórios utilizados.
Em cada embalagem, uma etiqueta identifica
as peças e onde utilizá-las.

Identify and separate the the hardware used in
the assembly. There's a label on each package
identifying the parts and where to use them.

Identifique y separete los accesorios utilizados
en el montaje. Observe la etiqueta en cada
paquete para saber donde montar.

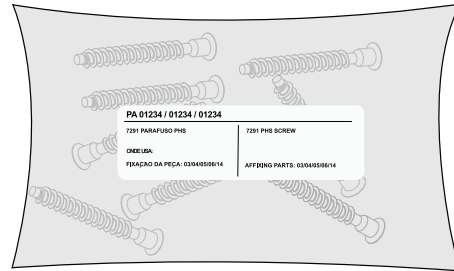

ADESIVO - 4x
STICKER
ADHESIVO

cod. 1669-14x

cod. 1668-32x

cod. 0342-8x

cod. 2661-2x

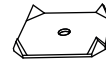
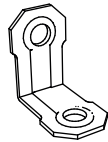
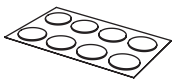

A

B

C

D

E

cod. 0357-28x

cod. 0136-8x

cod. 0338-4x

cod. 4439-8x

cod. 10063-20x

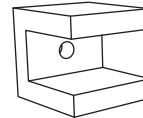
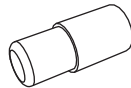
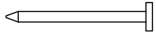

F

G

H

I

J

cod. 0162-22x

cod. 1533-68x

cod. 3527-8x

cod. 6533-8x

cod. 9895-20x

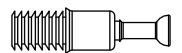
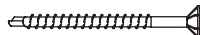
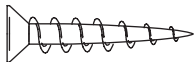

K

L

M

N

O

VIDRO
GLASS
VIDRIO



P

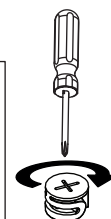
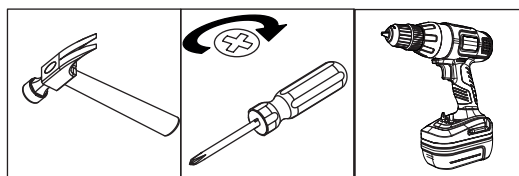

DESCRIÇÃO DESCRIPTION DESCRIPCIÓN

L:1950mm A:552mm P:447mm
 W:76.77 inches H:21.73 inches D:17.60 inches

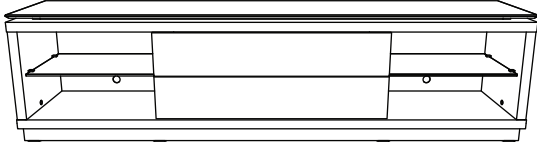

CÓD:221300				
PEÇA PART PIEZA	QUANTIDADE QUANTITY CANTIDAD	DESCRIÇÃO	DESCRIPTION	DESCRIPCIÓN
21	01	BASE	BASE	BASE
22	02	LATERAL EXT.	OUTER SIDE	LATERAL EXTERNA
23	02	LATERAL INT.	INNER SIDE	LATERAL INTERNA
24	01	TAMPO	TOP BOARD	CUBIERTA
25	01	SARRAFO FRONTAL	FRONT BATTEN	SOPORTE FRONTAL
26	01	SARRAFO TRASEIRO	BACK BATTEN	SOPORTE TRASERO
27	02	SARRAFO LATERAL	SIDE BATTEN	SOPORTE LATERAL
28	01	TAMPO	TOP BOARD	CUBIERTA
29	02	FUNDO LATERAL	BACKPLATE SIDE	FONDO LATERAL
30	01	FUNDO	BACKPLATE	FONDO
31	02	FRENTE GAVETA	DRAWER FRONT	FRENTE DEL CAJÓN
32	04	LATERAL GAVETA	DRAWER SIDE	LATERAL DEL CAJÓN
33	04	CONTRA FUNDO	BACK PANEL	CONTRA FONDO
34	02	FUNDO GAVETA	DRAWER BOTTOM	FONDO DEL CAJÓN
39	01	FRONTAL BASE	BASE FRONT	FRONTAL BASE
40	01	TRASEIRO BASE	BASE BACK	TRASERO BASE
41	01	LATERAL ESQ. BASE	BASE LEFT SIDE	LATERAL IZQ. BASE
42	01	LATERAL DIR. BASE	BASE RIGHT BOTTOM	LATERAL DER. BASE
43	02	CENTRAL BASE	BASE CENTER	CENTRAL BASE

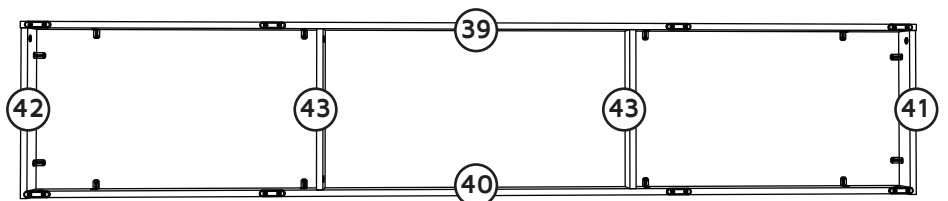
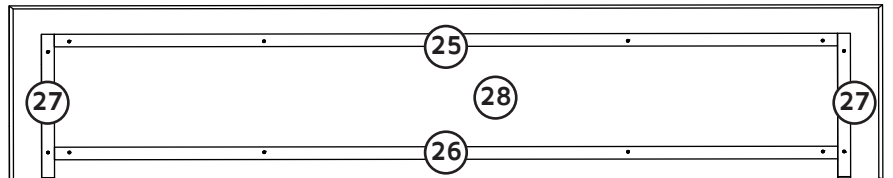
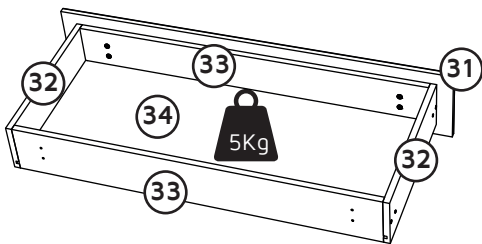
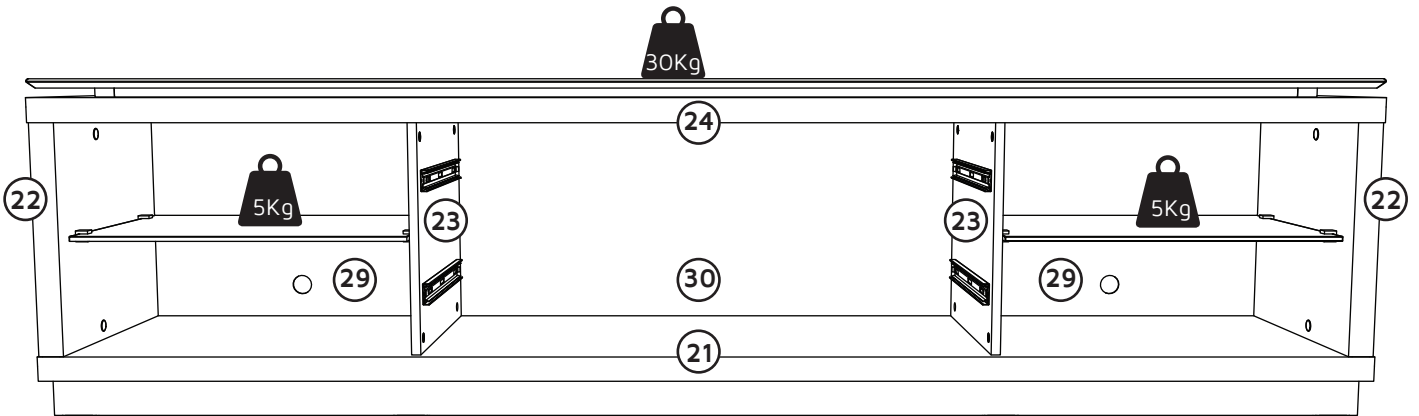

30Kg = 66Lb
 5Kg = 11Lb

01

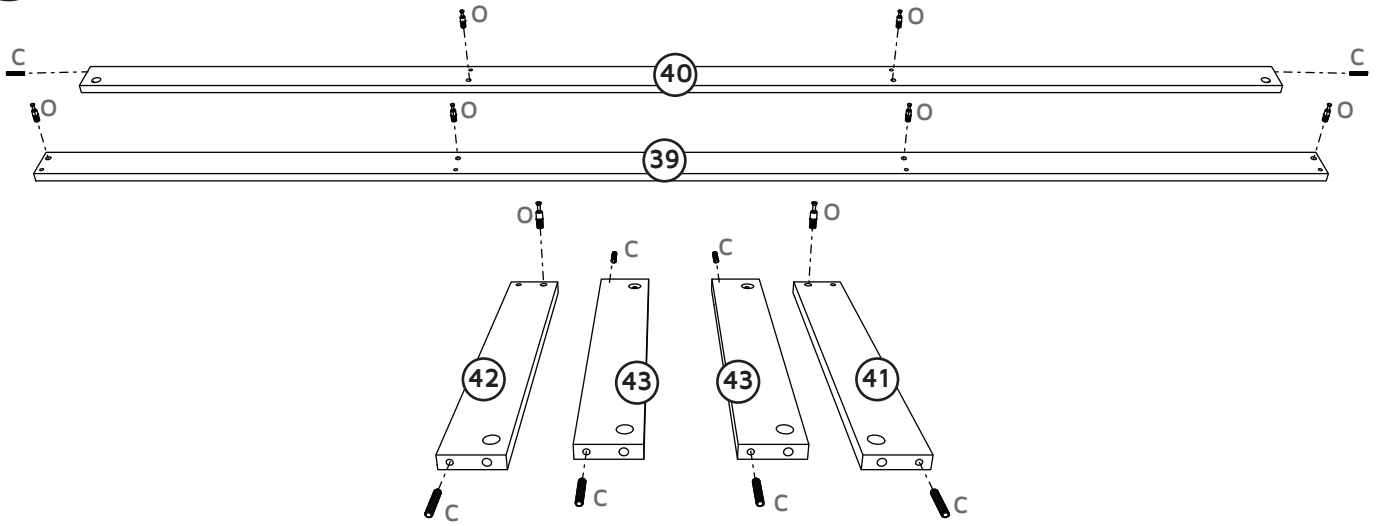

02

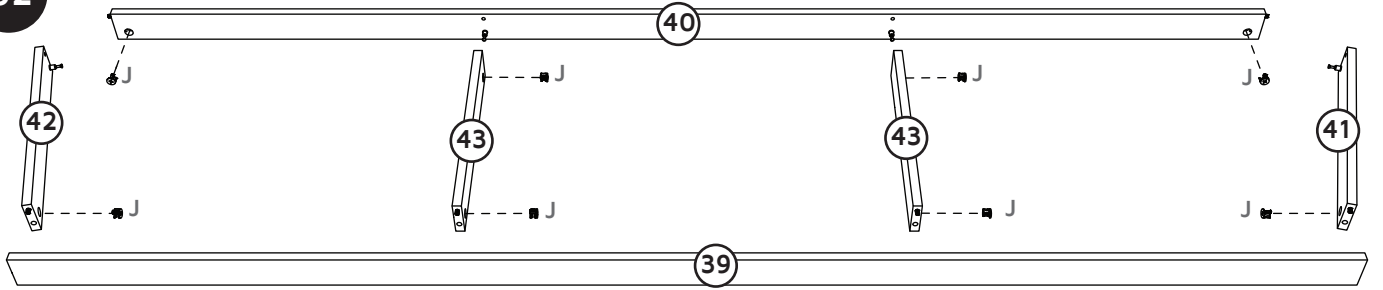

03

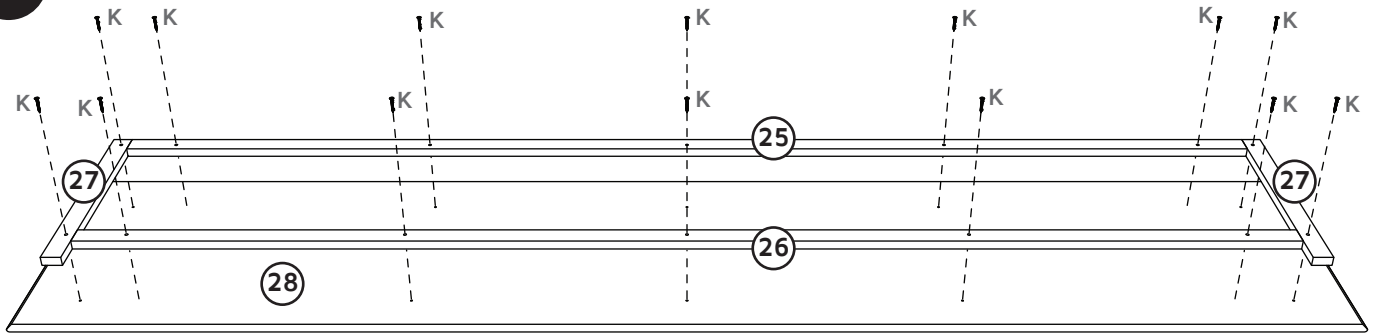

04

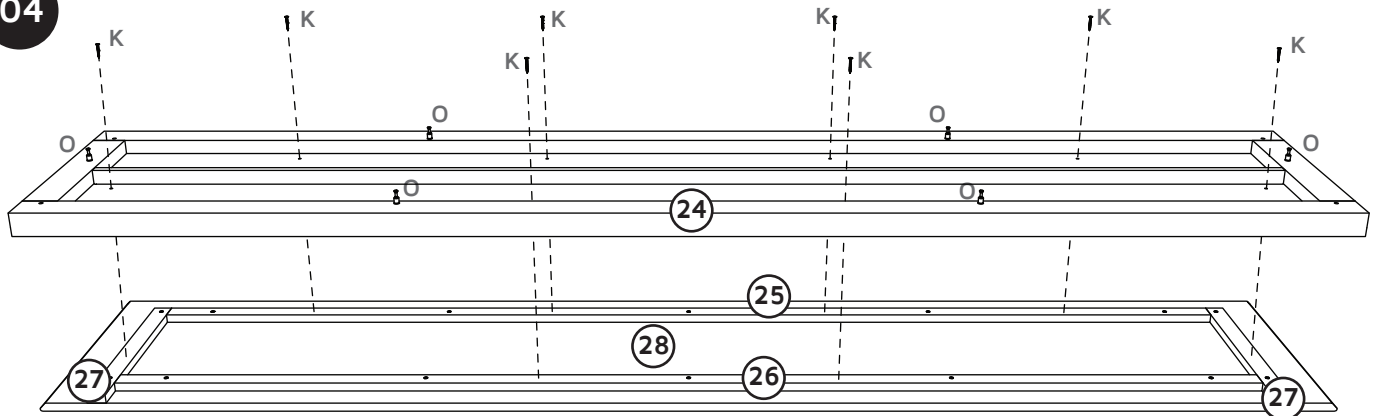

05

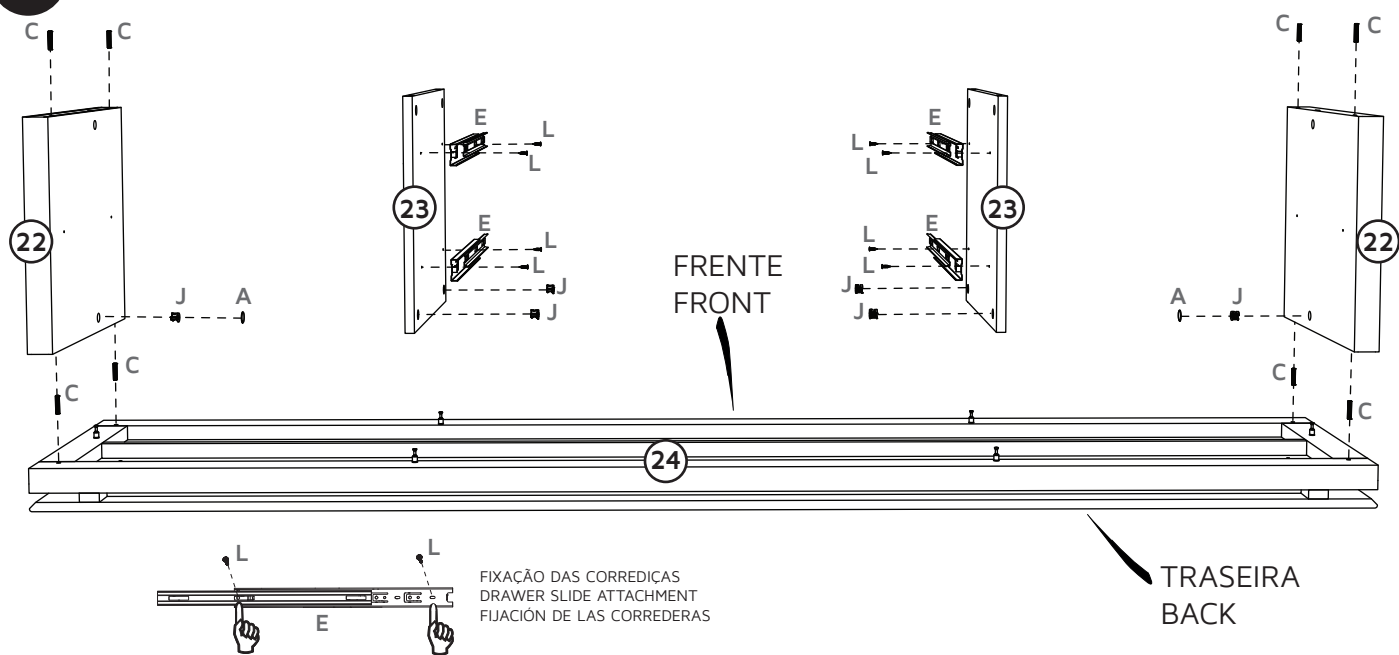

06

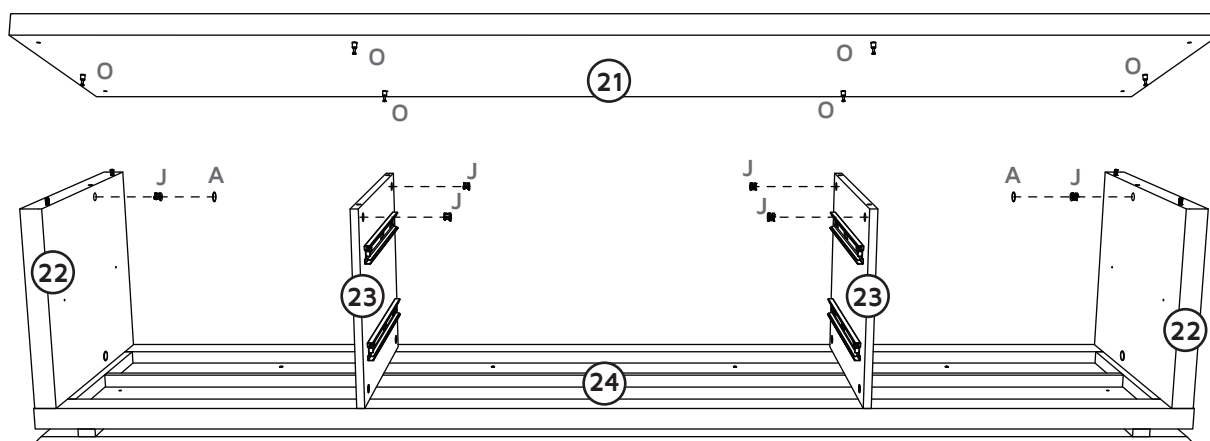

07



Atenção / Attention / Atención

A APLICAÇÃO DO PRODUTO RODIZIO (150151)*
DEVE SER FEITA NESTA ETAPA.
* VENDIDO SEPARADAMENTE.

The casters (150151) must be assembled
in this step.

*Sold separately.

La instalación del Ruedas (150151)* debe realizarse
en este paso.

* Se vende en separado.

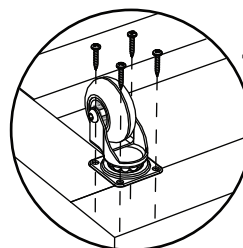

150151

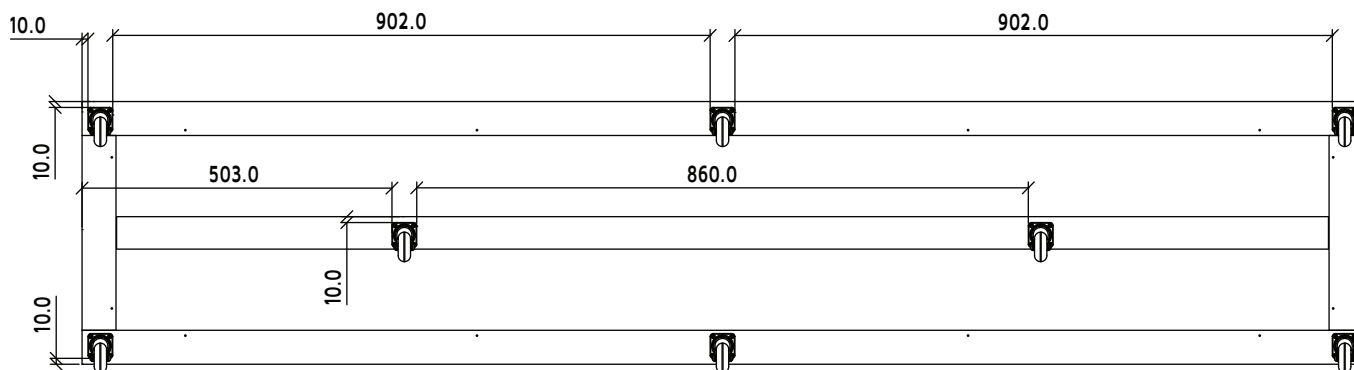
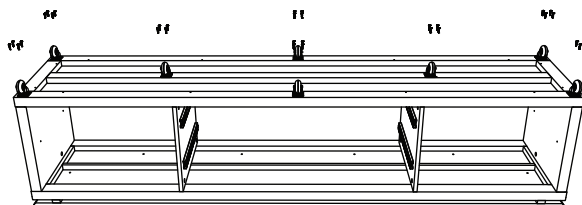

08

Atenção
Atención
Attention

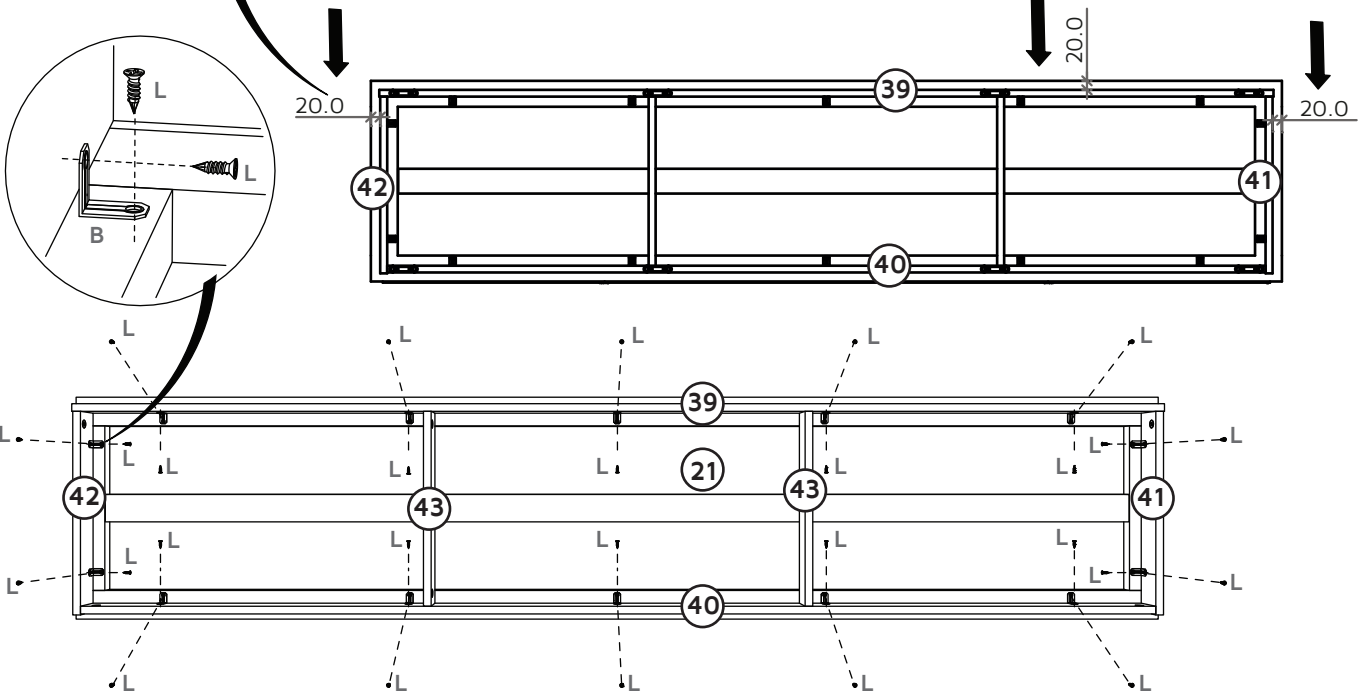
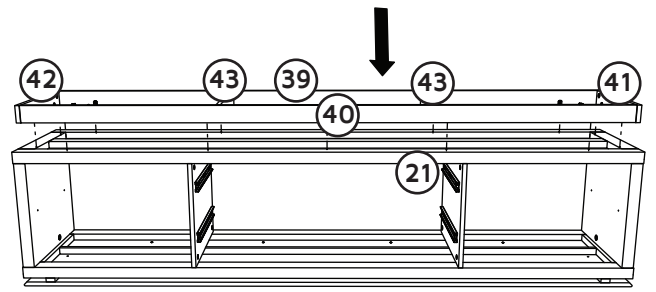

09

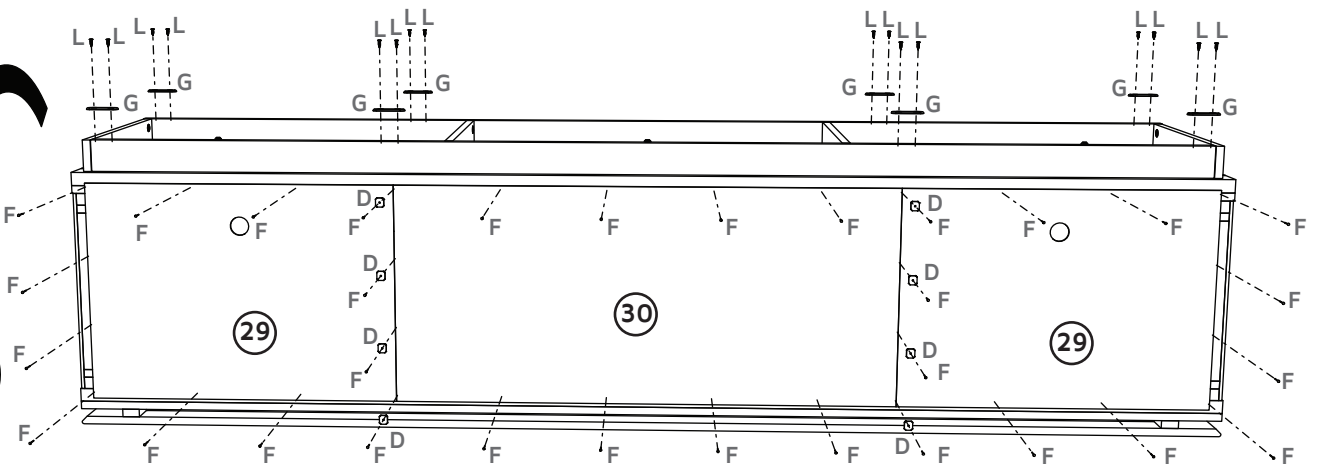
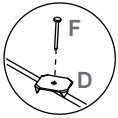

10

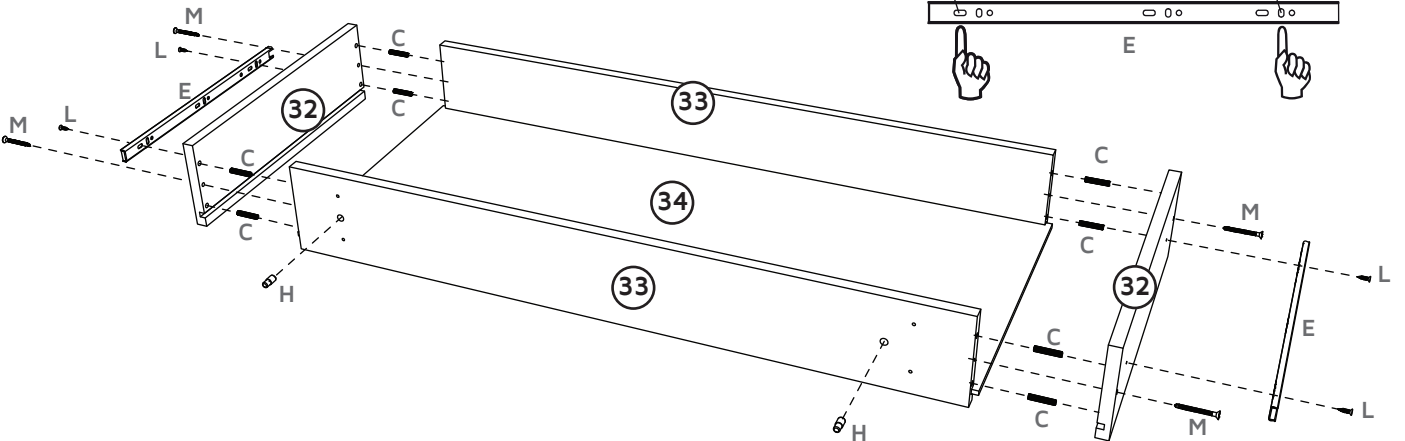
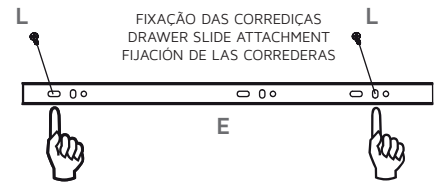

11

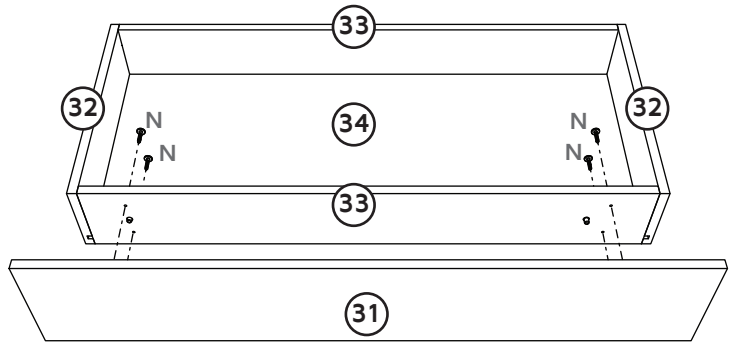
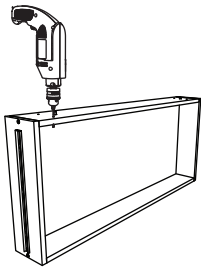

12

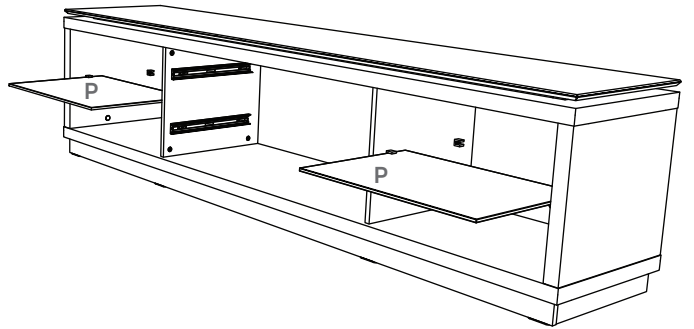
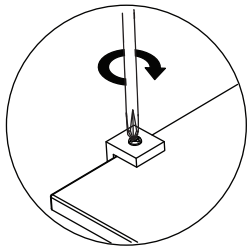
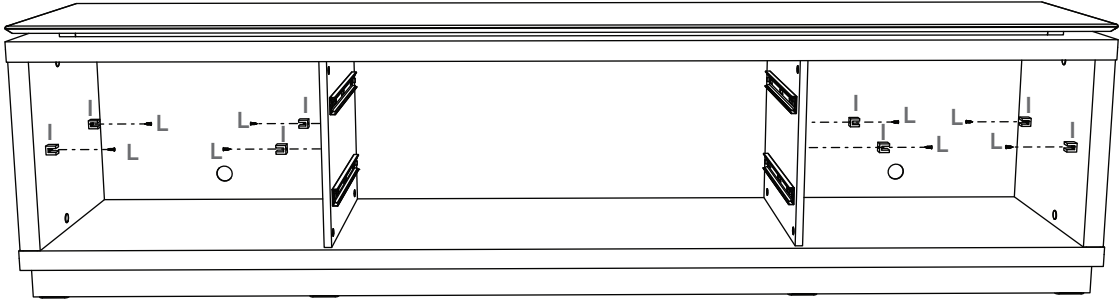

13

