

# INSTRUCTIVO DE ARMADO INSTRUÇÕES DE MONTAGEM

Mueble de baño Seia gris  
Móvel para banheiro Seia cinza

MODELO: SD043-50GREY

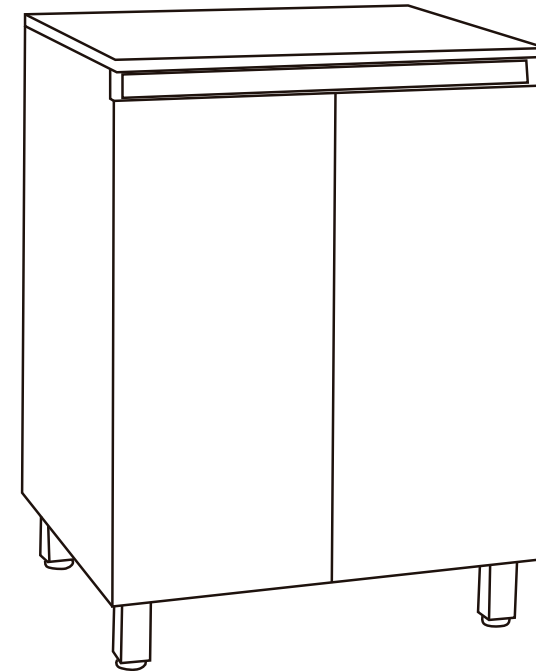

IMAGEN/IMAGEM MERAMENTE ILUSTRATIVA

Por cualquier reclamo o desperfecto diríjase a la tienda Sodimac donde adquirió el producto junto con su comprobante de compra, nuestro servicio de post venta lo asistirá con gusto.

Para quaisquer consultas ou reclamações, dirija-se à loja Sodimac onde adquiriu o produto, munido do comprovante de compra; nosso Serviço de Pós Vendas o atenderá com prazer.

ARGENTINA  
Teléfono de contacto:  
0810-222-7634  
www.sodimac.com.ar

BRASIL  
Teléfono de contacto:  
0300 7634622  
www.sodimac.com.br

CHILE  
Teléfono de contacto:  
600 600 4020  
www.sodimac.cl

COLOMBIA  
Teléfono de contacto:  
01 8000 115 150  
www.homecenter.com.co

MEXICO  
Teléfono de contacto:  
018005225353

PERÚ  
Teléfono de contacto:  
4192000  
www.sodimac.com.pe  
(Maestro) 6310300  
www.maestro.com.pe

URUGUAY  
Teléfono de contacto:  
0800-7634  
www.sodimac.com.uy

Importado y/e Distribuido por: Argentina: FALABELLA S.A., C.U.I.T. 30-65572582-9 - Suipacha 1111 P. 18 (1008) - Buenos Aires, Tel.:54-11-4710-5600. - Brasil: CONSTRUDECOR S.A. - CNPJ: 03.439.316/0038-64 - SAC: 55-11-2065-2500. - Chile: SODIMAC S.A., RUT 96.792.430-K - Av. Pdte. Eduardo Frei M. 3092, Renca, Santiago, Tel.: 56-2-2738-1000 / IMPERIAL S.A., RUT 76.821.330-5. Av. Santa Rosa 7876, La Grana - Santiago - Tel.: 56-2-2399-7000 / FALABELLA RETAIL S.A., RUT 77.261.280-K - Manuel Rodríguez Norte 730, Santiago - Tel.: 600-380-5000 / HIPERMERCADOS TOTTUS S.A., RUT 78.627.210-3 - Nataniel Cox 620 Subterráneo, Santiago - Tel.: 562-827-0211 - Colombia: SODIMAC COLOMBIA S.A., Cód. SIC 800242106, NIT. 800.242.106-2 - Carrera 680 N° 80-70, Bogotá, Tel.: 57-1-5440000 / FALABELLA DE COLOMBIA S.A., NIT.900.017.447-8 - Calle 99 No 11A - 32, No. Reg. SIC: 900017447 - Bogotá - Tel.: 57-1-5878002 Nacional: 01-8000-113252. - México: COMERCIALIZADORA SDMHC S.A. de C.V. Avenida Adolfo Lopez Mateos 201, Colonia Santa Cruz Acatlan, Naucalpan De Juarez, Estado de México, C.P. 53150, RFC CSD161207RZA, Tel.: +52 55 5375 9000. - Perú: SODIMAC PERÚ S.A., RUC. 20389230724, Av. Angamos Este N° 1805 Int. 2, Surquillo - Lima - Lima, Tel.:51-1-2119500 / MAESTRO PERÚ S.A., RUC. 20112273922. Jr. San Lorenzo N° 881 (Esq. Angamos con Rep. de Panamá), Surquillo - Lima - Lima. Tel.: 51-1-6111900 / SAGA FALABELLA S.A., RUC: 20100128056, Av. Paseo de la República 3220, San Isidro, Lima - Tel.: 51-01-512-3333 / HIPERMERCADOS TOTTUS S.A., Av. Angamos Este 1805, oficina 5, Piso 10, Surquillo, Lima - RUC. 20508565934 - Tel.: 51-01-513-335 - Uruguay: Homecenter Sodimac S.A., RUT 21.699.665 0015 - Plaza Independencia 811, Montevideo, Uruguay - Tel.: 598-2604-7105.











## ATENCIÓN / ATENÇÃO













- Lea el manual de montaje, instalación y uso del producto y el certificado de garantía, en caso de dudas consulte al proveedor.
- Ordene las piezas que componen este producto
- Agrupe y ordene la quincallería.
- Prepare una zona despejada para el montaje.
- Monte las piezas sin forzar los ensamblés. Una vez que todas las partes están ensambladas, apretar firmemente.
- Volver a apretar los tornillos después de un tiempo de uso.
- No exponga las partes y piezas a la luz solar directa, pueden sufrir deterioro y deformaciones, especialmente los tableros de madera.
- Conserve las instrucciones de montaje.

- Leia o manual de montagem, instalação e uso do produto e as condições de garantia. Em caso de dúvidas, entre em contato com o fornecedor.
- Ordene as peças que compõem este produto.
- Prepare uma superfície desocupada para a montagem.
- Prepare uma superfície desocupada para a montagem.
- Monte as peças sem forçar os encaixes. Uma vez que todas as peças estejam encaixadas, aperte firmemente.
- Reaperte os parafusos após certo período de uso.
- Não exponha as peças à luz solar. A luz solar direta pode deteriorar ou deformar as peças, especialmente as que são feitas de madeira.
- Conserve as instruções de montagem.

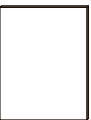

Personas para armado  
Pessoas para a montagem

Nº	PIEZAS PEÇAS	CANTIDAD CANTIDADE	DIMENSIONES/ DIMENSÕES (mm)
1		24	D 8 mm x 30 mm
2		34	D 6 mm x 32 mm
3		34	
4		30	
5		32	M4 x 14 mm
6		4	
7		4	100 mm
8		27	M4 x 12 mm
9-10		2	
11		1	

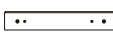
Nº	PIEZAS PEÇAS	CANTIDAD CANTIDADE	DIMENSIONES/ DIMENSÕES (mm)
1		1	684.5 mm x 435 mm x 16 mm
1		1	684.5 mm x 435 mm x 16 mm
3		1	567 mm x 79.5 mm x 16 mm
4		1	567 mm x 99.5 mm x 16 mm
5		1	567 mm x 199.5 mm x 16 mm
6		1	567 mm x 435 mm x 16 mm
7		1	600 mm x 460 mm x 16 mm
8		2	648 mm x 299 mm x 16 mm
9		1	300 mm x 100 mm x 16 mm
10		1	300 mm x 100 mm x 16 mm
11		1	199.5 mm x 66.5 mm x 16 mm
12		1	199.5 mm x 66.5 mm x 16 mm
13		1	504 mm x 300 mm x 16 mm
14		1	546 mm x 100 mm x 16 mm
15		2	290 mm x 45 mm x 4.7 mm

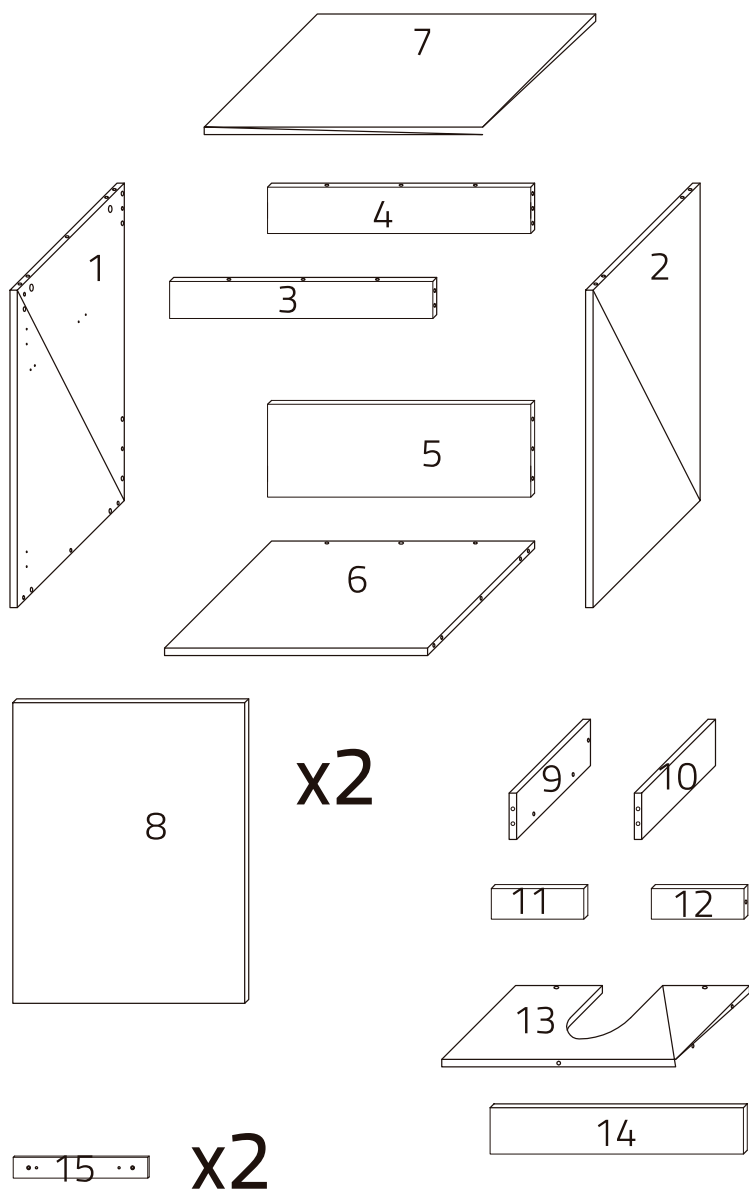

① x 24 	② x 21 	 NO INCLUIDO NÃO INCLUIDO	 NO INCLUIDO NÃO INCLUIDO	⑤ x 4  M4x14
------------	------------	---------------------------------	---------------------------------	--------------------

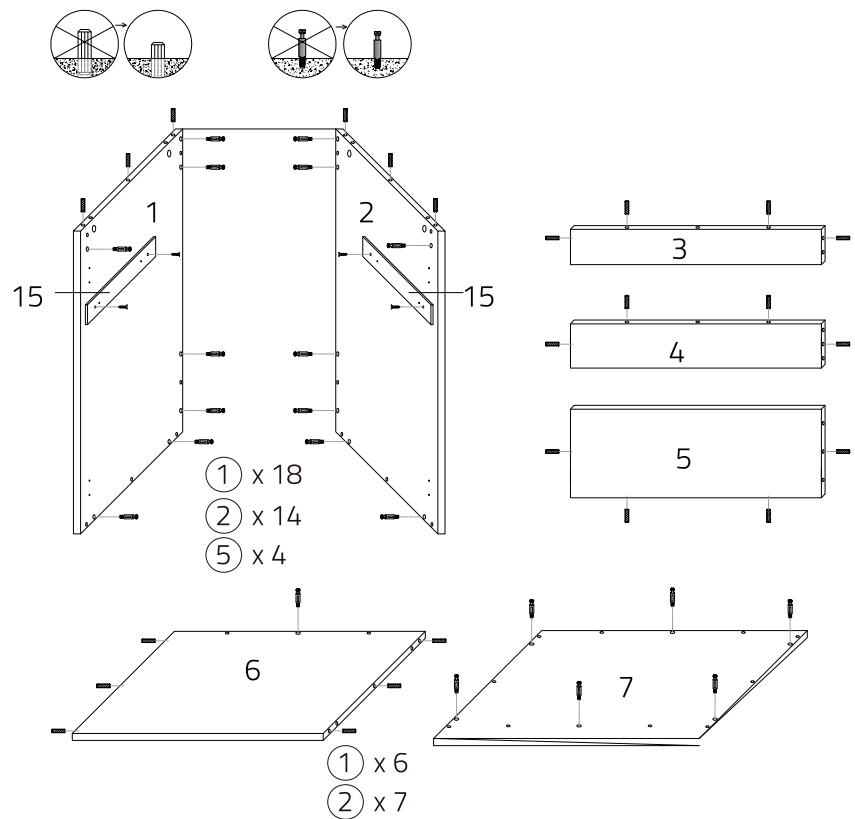

2

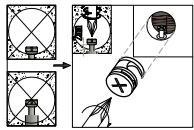
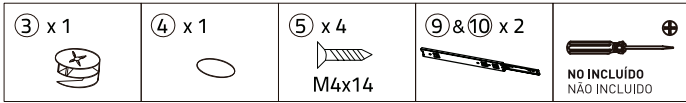

③ x 1  
④ x 1

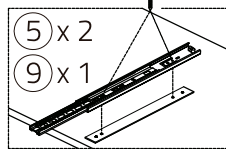
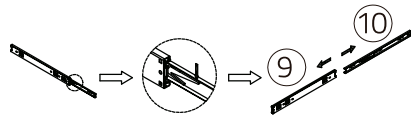
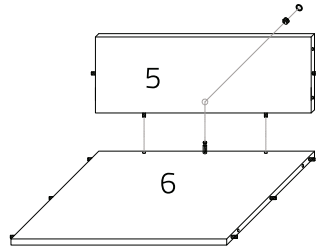

x2

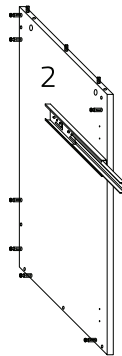
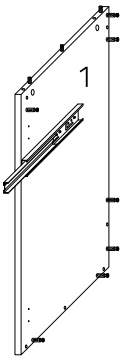

3

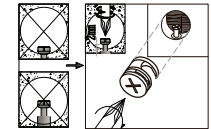
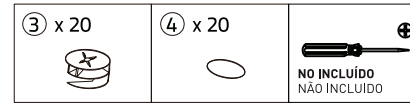



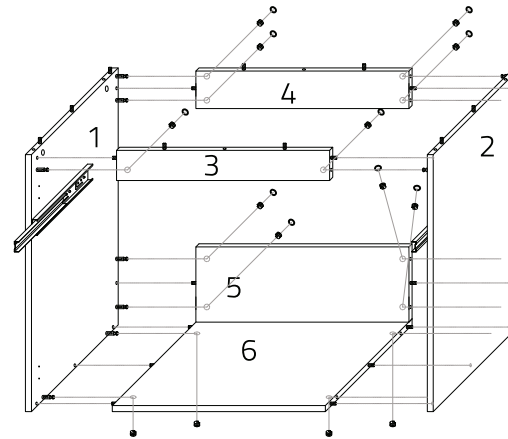

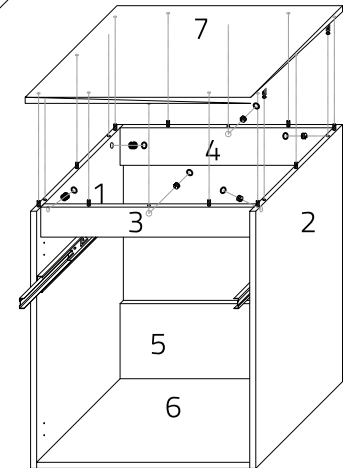

③ x 14  
④ x 14



③ x 6  
④ x 6



4

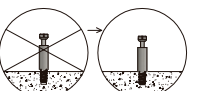

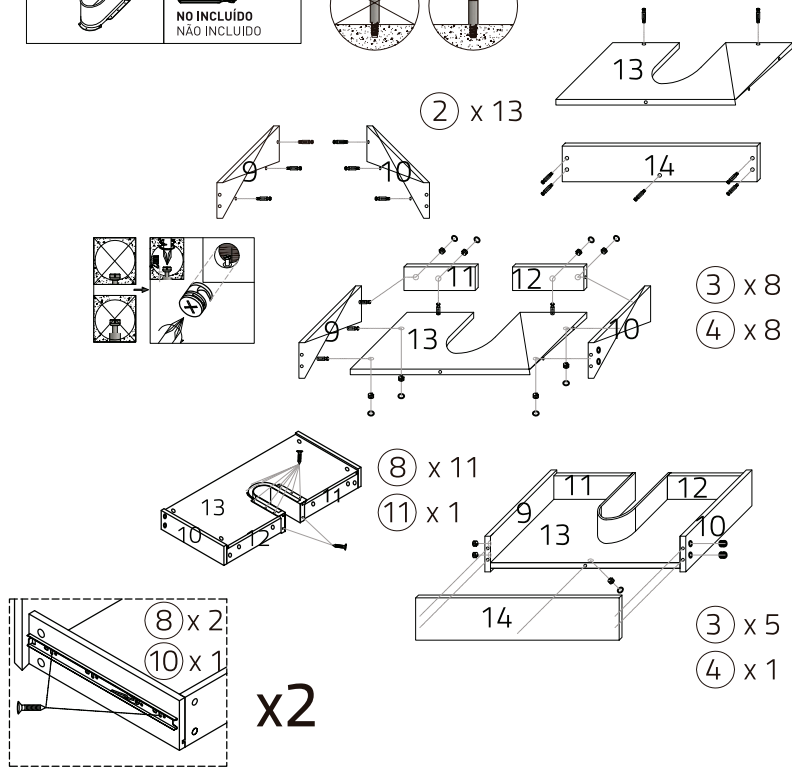
② x 13 	③ x 13 	④ x 9 	⑧ x 15 M4 x 12 	⑩ x 2 
⑪ x 1 	 NO INCLUIDO NÃO INCLUIDO			

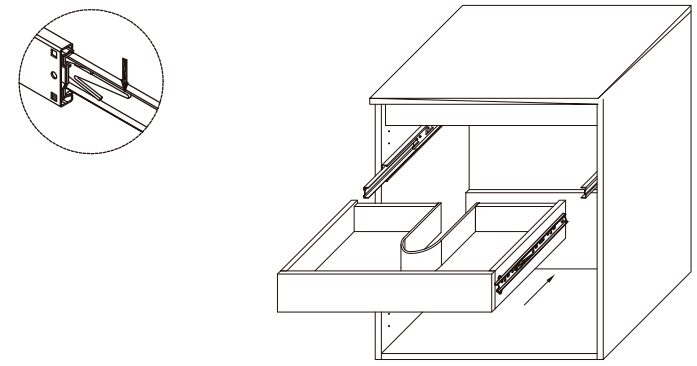

5



6

⑤ x 24 M4 x 14 	⑥ x 4 	 NO INCLUIDO NÃO INCLUIDO
--	--	--

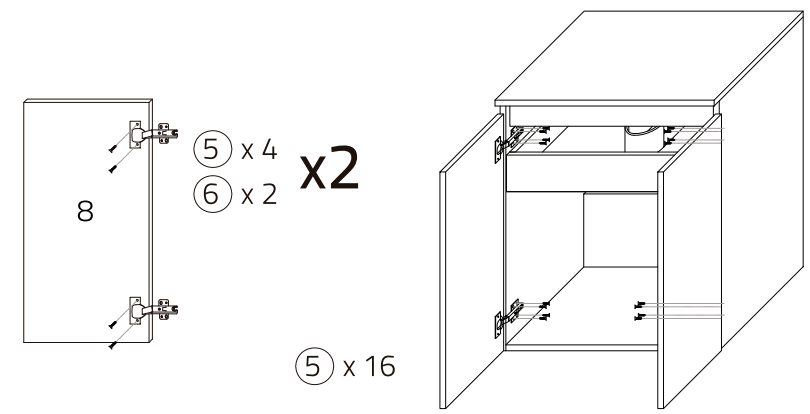

7

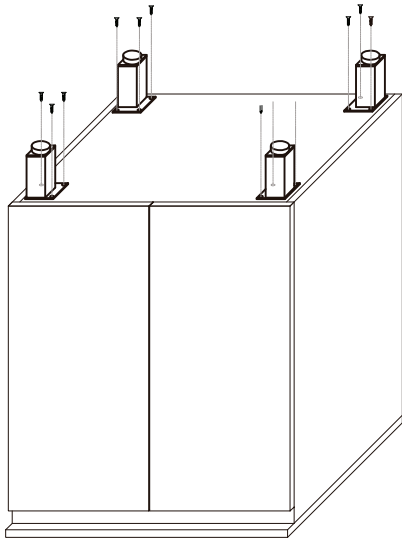
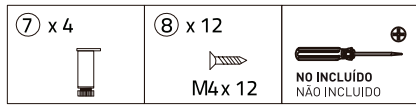

⑦ x 4  
⑧ x 12

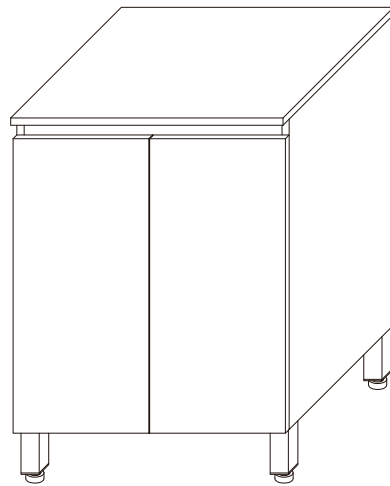

## DIMENSIONES/ DIMENSÕES

