



MANUAL DE INSTRUCCIONES
MANUAL DE INSTRUÇÕES

PÉRGOLA AROMANA CON CORTINAS

GAZEBO ROMANO COM CORTINAS

MODELO: GFS00050F-TP2



⚠️ ATENCIÓN / ATENÇÃO

Para garantizar la durabilidad de este producto es necesario que sea anclado a la superficie o que utilice una base adecuada. En caso de viento fuerte, lluvia o nieve cierre la sombrilla o desarme el toldo, no cuelgue objetos ni ropa del armazón del producto; antes de abrir la sombrilla o armar el toldo, asegúrese que no hay personas ni objetos con los que se pueda tropezar con las partes del producto.

Para garantir a durabilidade deste produto, é necessário que seja fixado à superfície ou utilizar uma base adequada. Em caso de vento forte, chuva e de neve, fechar o guarda-Sol ou desmontar o gazebo, não pendurar objetos ou roupas no produto; antes de abrir o guarda-Sol ou armar o gazebo, garantir que não hajam pessoas ou objetos que possam tropeçar nas partes do produto.

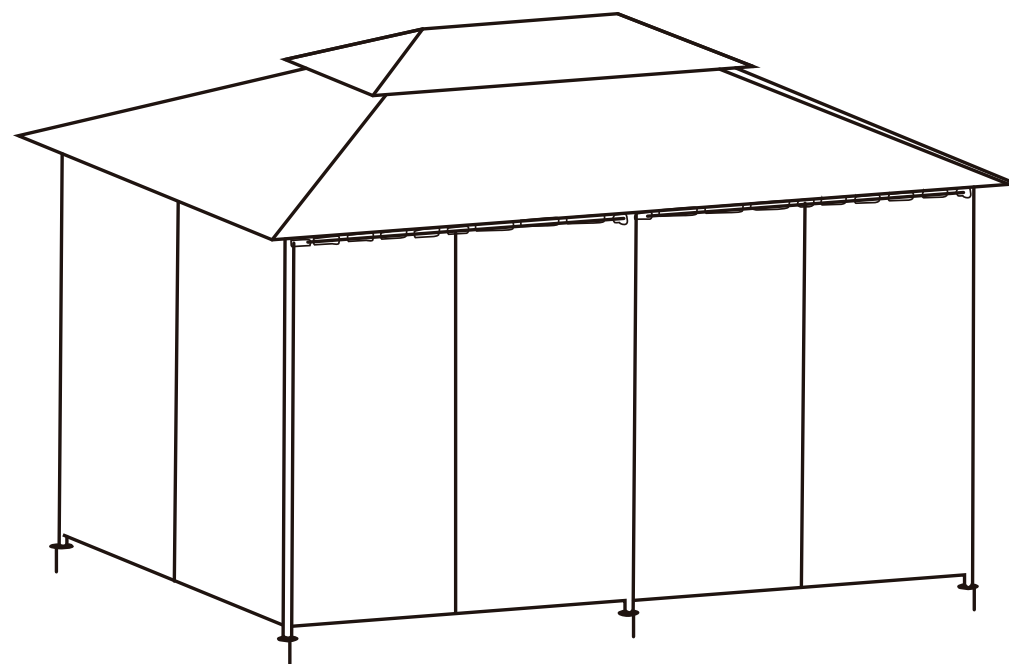

IMAGEN/IMAGEM MERAMENTE ILUSTRATIVA

Por cualquier reclamo o desperfecto diríjase a la tienda Sodimac donde adquirió el producto junto con su comprobante de compra, nuestro servicio de post venta lo asistirá con gusto.

Para quaisquer consultas ou reclamações, dirija-se à loja Sodimac onde adquiriu o produto, munido do comprovante de compra; nosso Serviço de Pós Vendas o atenderá com prazer.

ARGENTINA

Teléfono de contacto:
0810-222-7634
www.sodimac.com.ar

BRASIL

Telefone para contato:
+55 (11) 3004-5678
São Paulo e Grande
São Paulo | 0800 7634622
www.sodimac.com.br

CHILE

Teléfono de contacto:
600 329 2002
www.sodimac.cl

COLOMBIA

Teléfono de contacto:
3208899933
www.homecenter.co

MEXICO

Teléfono de contacto:
800 062 5222
www.sodimac.com.mx

URUGUAY

Teléfono de contacto:
0800-7634
www.sodimac.com.uy

PERÚ

Teléfono de contacto:
4192000
www.sodimac.com.pe
www.maestro.com.pe

Importado y/ e Distribuido por: Argentina: FALABELLA S.A., C.U.I.T. 30-65572582-9 - Suipacha 1111 P. 18 (1008) - Buenos Aires. Tel.: 54-11-4710-5600. - Brasil: CONSTRUDECOR S.A - CNPJ: 03.439.316/0078-51 - SAC: +55 (11) 3004-5678 SP e Grande SP | 0800 7634622. - Chile: SODIMAC S.A., RUT 96.792.430-K - Presidente Riesco 5685, oficina 801, Piso 14 y 16, Las Condes, Santiago - Tel.: 600 329 2002 / IMPERIAL S.A., RUT 76.821.330-5. Av. Santa Rosa 7876, La Granja - Santiago - Tel.: 56-2-2399-7000 / FALABELLA RETAIL S.A., RUT 77.261.280-K - Catedral 1401, Dpto. 1401, Santiago - Tel.: 600-380-5000 / HIPERMERCADOS TOTTUS S.A., RUT 78.627.210-6 - Nataniel Cox 620 Subterráneo, Santiago - Tel.: 56-2-2827-0211 - Colombia: SODIMAC COLOMBIA S.A., Cód. SIC 800242106, NIT. 800.242.106-2 - Carrera 680 N° 80-70, Bogotá, Tel.: 57 601 3904100. www.homecenter.co - notificacionesjudiciales@homecenter.co / FALABELLA DE COLOMBIA S.A., NIT. 900.017.447-8 - Calle 99 No 11A - 32, No. Reg. SIC 900017447 - Bogotá - Tel.: 57 601 5878002 Nacional: 01-8000-113252. - Perú: Tiendas del Mejoramiento del Hogar S.A. RUC 20112273922. Av. Angamos Este Nro. 1805 Int. 2, Surquillo - Lima - Tel.: 51-1-2119500 / SAGA FALABELLA S.A., RUC: 20100128056 - Av. Paseo de la República 3220 San Isidro, Lima - Tel.: 51-01-512-3333 / HIPERMERCADOS TOTTUS S.A., Av. Angamos Este 1805, oficina 5, Piso 10, Surquillo, Lima - RUC: 20508565934 - Tel.: 51-01-513-3355 - Uruguay: Homecenter Sodimac S.A., RUT 21.699.665 0015 - Plaza Independencia 811, Montevideo, Uruguay - Tel.: 598-2604-7105 - México: COMERCIALIZADORA SDMHC S.A. de C.V. Avenida Adolfo López Mateos 201, Colonia Santa Cruz Acatlán, Naucalpan De Juárez, Estado de México, C.P. 53150. RFC CSD161207R2A, Tel.: +52 55 1516 4400. ARTE: 20250402

ATENCIÓN / ATENÇÃO





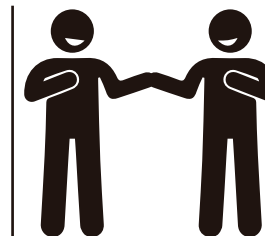









- Lea el manual de instrucciones, instalación y uso del producto y el certificado de garantía, en caso de dudas consulte al proveedor.
- Ordene las piezas que componen este producto.
- Agrupe y ordene la quincallería (tornillería).
- Prepare una zona despejada para el montaje.
- Monte las piezas sin forzar los ensamblados, apretar firmemente.
- Volver a apretar los tornillos después de un tiempo de uso.
- No exponga las partes y piezas a la luz solar directa, pueden sufrir deterioro y deformaciones, especialmente los tableros de madera.
- Conserve el manual de intrucciones.

- Leia o manual de montagem, instalação e uso do produto e as condições de garantia. Em caso de dúvidas, entre em contato com o fornecedor.
- Ordene as peças que compõem este produto.
- Agrupe e ordene as peças de montagem.
- Prepare uma superfície desocupada para a montagem.
- Monte as peças sem forçar os encaixes. Uma vez que todas as peças sem forçar os encaixes, aperte firmemente.
- Reaperte os parafusos após certo período de uso.
- Não exponha as peças à luz solar. A luz solar direta pode deteriorar ou deformar as peças, especialmente as que são feitas de madeira.
- Conserve as instruções de montagem.













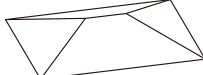
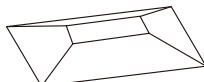

Personas para armado
Pessoas para a montagem

ACCESORIOS
ACESSÓRIOS

		CANTIDAD/ QUANTIDADE
(A)		4
(B)		2
(C)		4
(D)		2
(E)		2
(F)		1
(G)		1
(H1)		2
(H2)		2
(I)		32
(J)		2
(K1)		4
(K2)		4
(K3)		1
(L)		2

ACCESORIOS
ACESSÓRIOS

			CANTIDAD/ QUANTIDADE
(M)		M6 x 15 mm	18
(N)		M6 x 25 mm	10
(O)		M6 x 52 mm	4
(P)			16
(Q)			16
(R)			2
(S1)			1
(S2)			1
(S2)			4
(T)			2
(V)			16
(W)			4
(X)			6

MONTAJE
MONTAGEM



Herramientas necesarias
para armado /
Ferramentas necessárias
para armado

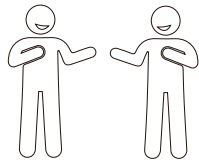

1

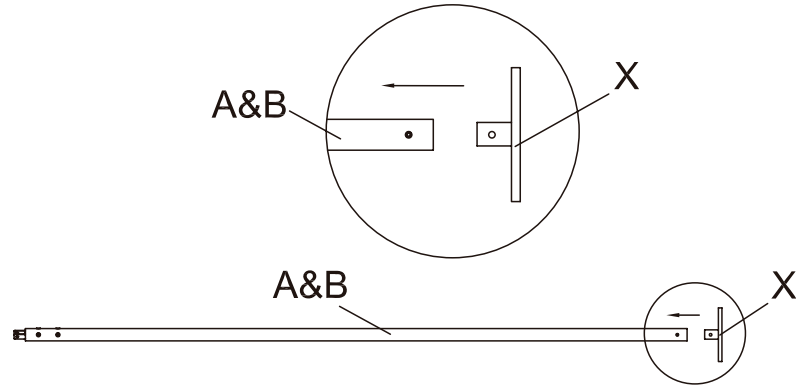

2

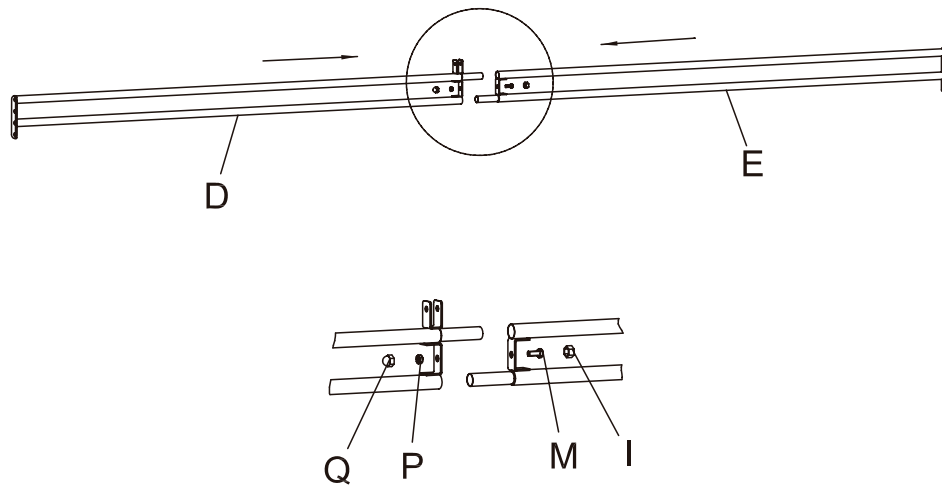

MONTAJE
MONTAGEM



Herramientas necesarias
para armado /
Ferramentas necessárias
para armado

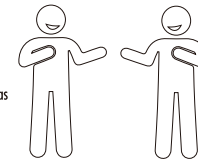

3

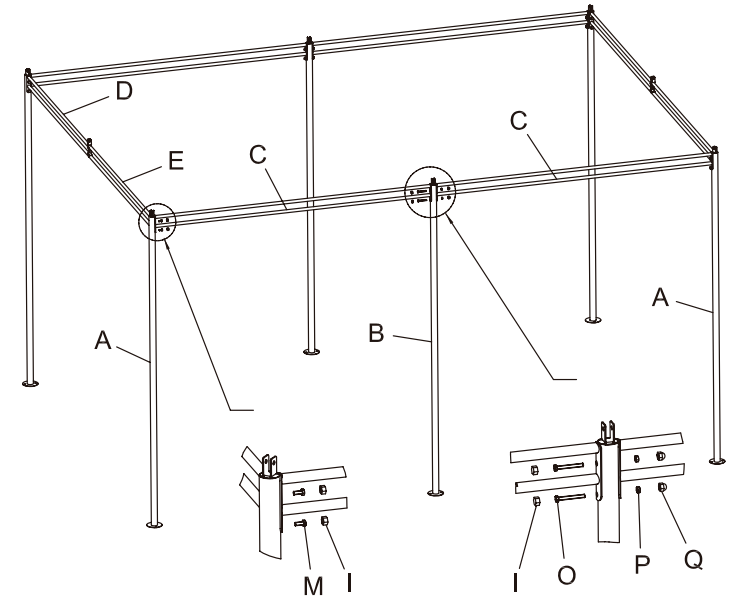

4

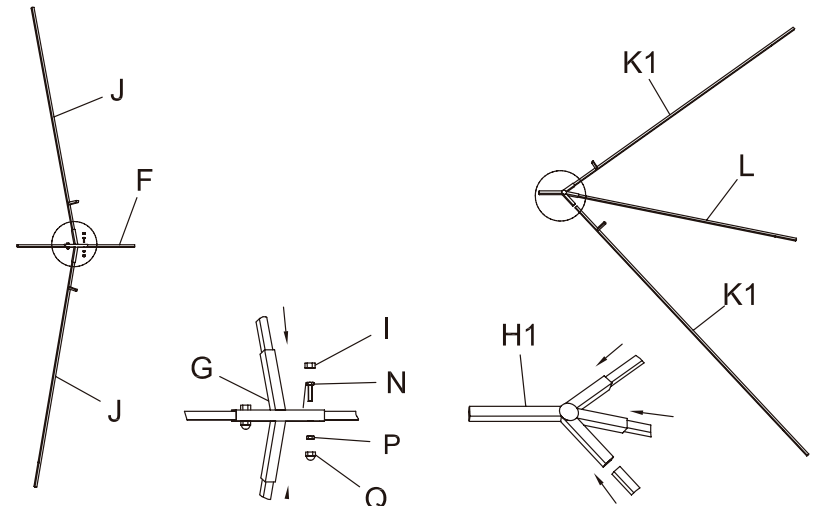

MONTAJE
MONTAGEM



Herramientas necesarias
para armado /
Ferramentas necessárias
para armado

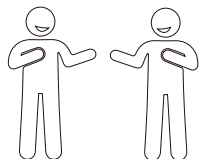

5

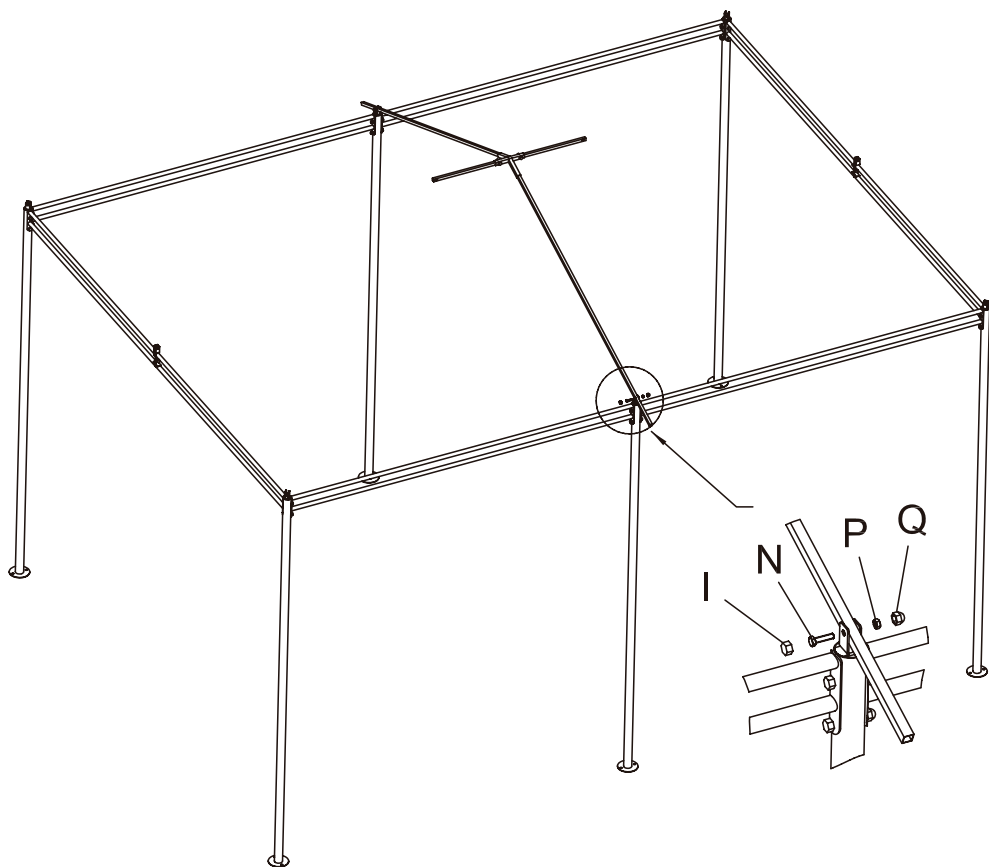

MONTAJE
MONTAGEM



Herramientas necesarias
para armado /
Ferramentas necessárias
para armado

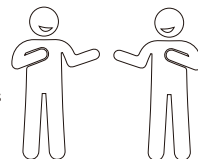

6

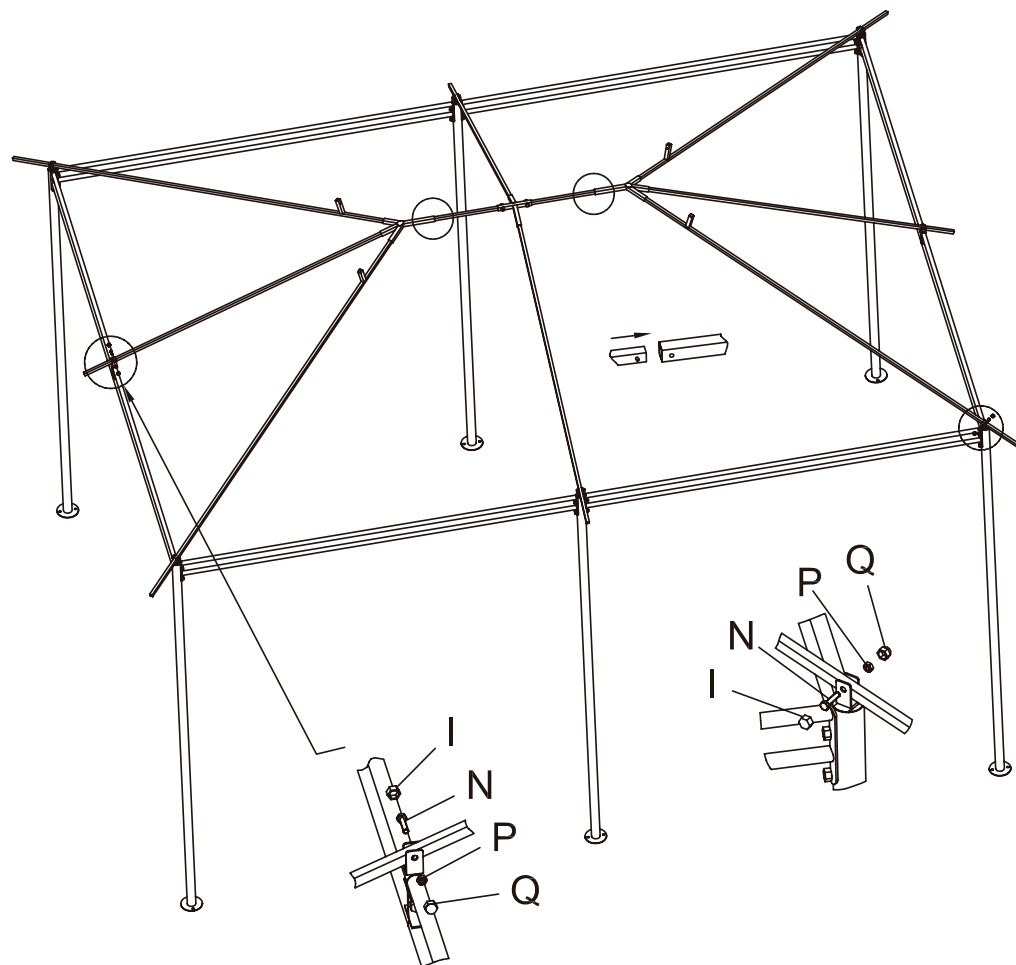



Herramientas necesarias
para armado /
Ferramentas necessárias
para armado

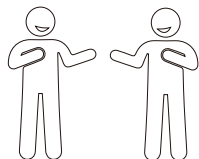

Herramientas necesarias
para armado /
Ferramentas necessárias
para armado

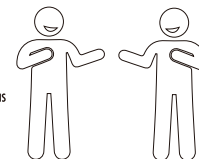

7

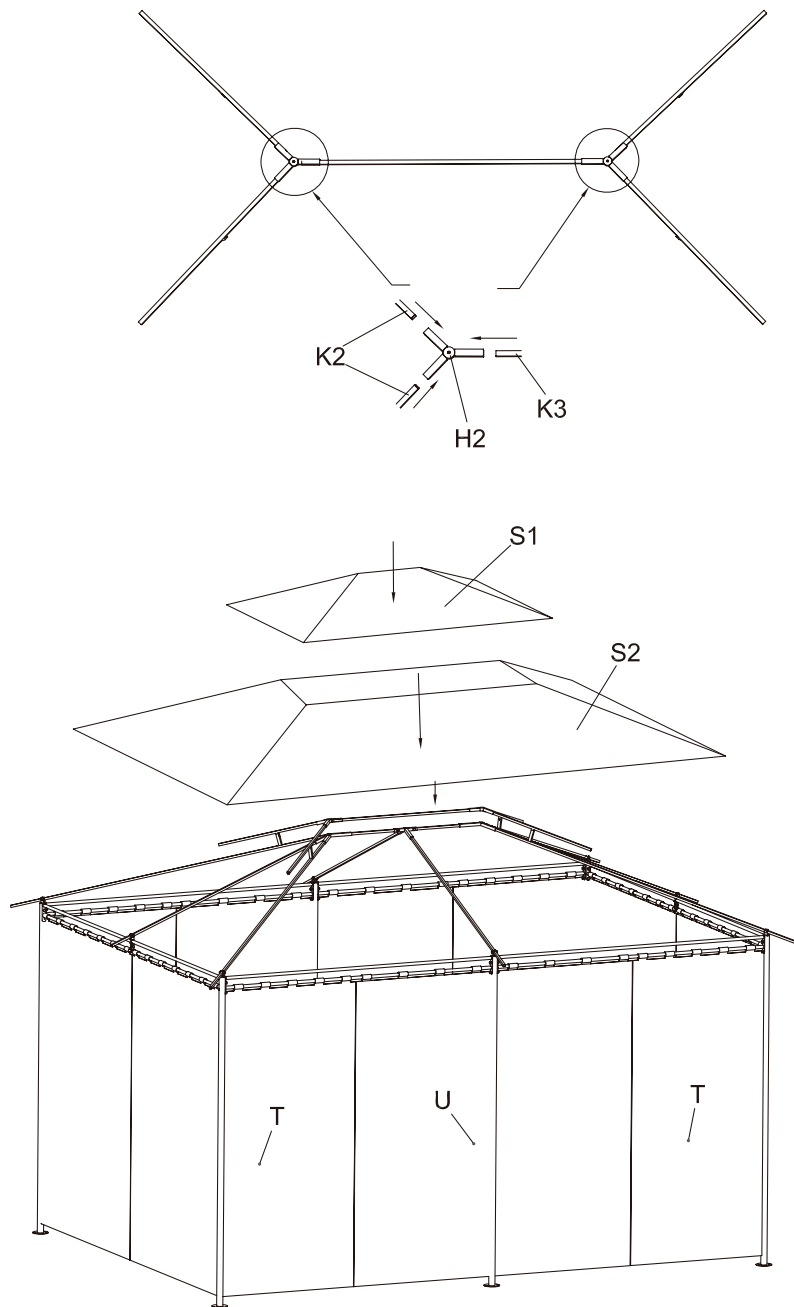

8

