

1P SERIES (Indoor, Keyed)

2P SERIES (Outdoor, Keyed)



1P Series Plastic housing models (page 14)

Straight plugs

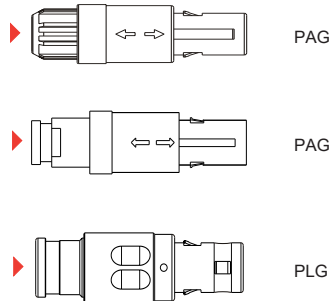

Fixed sockets

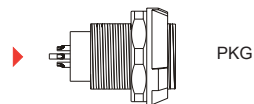

Free sockets

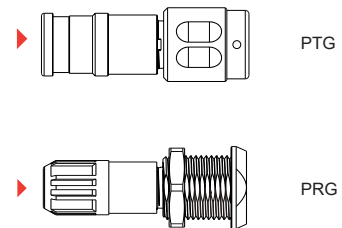

2P Series Plastic housing models (page 14)

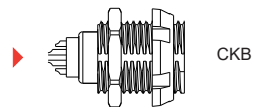
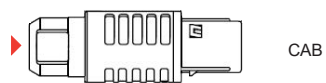

Part Section Showing Internal Components

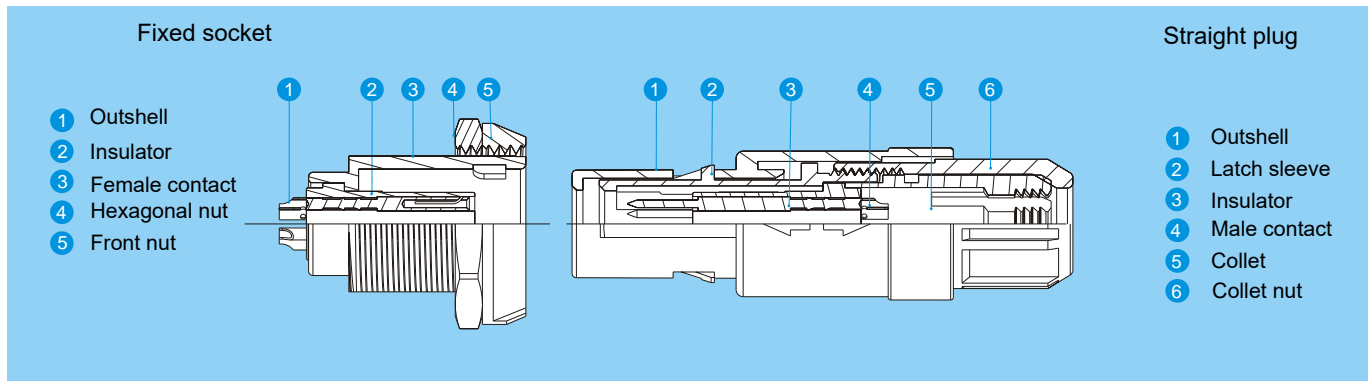

1P series connectors have main features as follows:

- security of the Push-Pull self-latching system
- multipole types 2 to 14 contacts
- solder, print contacts
- high packing density for space savings
- a keying system combined with colour coding can be incorporated on all connector types to assist in the prevention of mismatching.
- plastic shell, IP 50

1P Series Connectors Technical Characteristics:

- Endurance: > 1000 cycles
- Humidity: up to 95% at 60° C
- Temperature range: - 50° C, + 150° C
- Shock resistance: 100 g, 6 ms
- Resistance to vibrations: 10-2000 Hz, 15g
- Withstand voltage: 500V AC, 60S
- Protection index (mated): IP 50

1P Series Part Numbering System

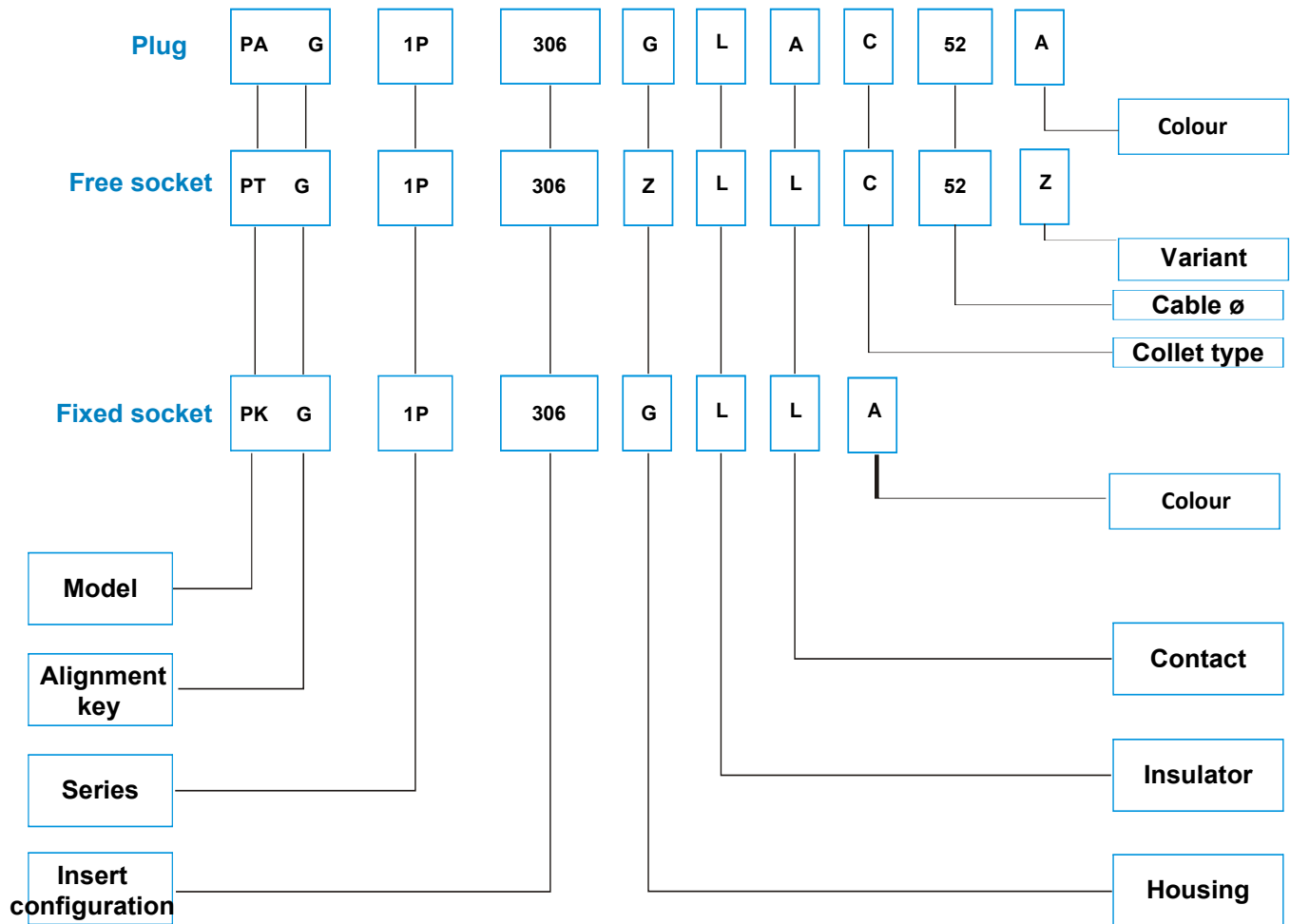

Part Number Example

Straight Plug with Cable Collet:

[PAG.1P.306.GLAC52A](#) = straight plug with key (G) and cable collet, 1P series, multipole type with 6 contacts, outer shell in grey PSU, PPS insulator, male solder contacts, collet for a cable 4.5 to 5.5 mm diameter and blue collet nut.

Free socket:

[PTG.1P.306.ZLLC52Z](#) = free socket with key (G) and cable collet, 1P series, multipole type with 6 contacts, outer shell in aluminium alloy, PPS insulator, female solder contacts, collet for a cable 4.5 to 5.5 mm diameter and nut for fitting a bend relief.

Fixed Socket:

[PKG.1P.306.GLLA](#) = fixed socket, nut fixing, with key (G), 1P series, multipole type with 6 contacts, outer shell in grey PSU, PPS insulator, female solder contacts.

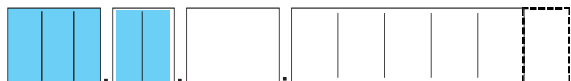

Plastic Housing Models:1P series

PAG Straight plug with cable collet

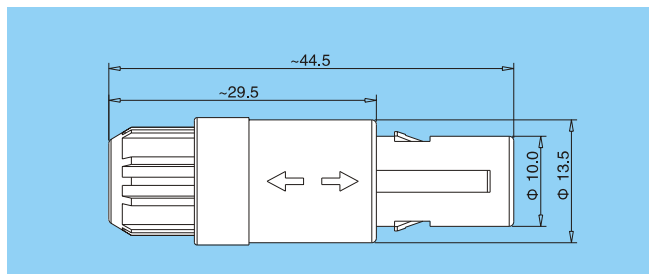

PLG Straight plug, out shell aluminum alloy, cable collet and nut for fitting a bend relief

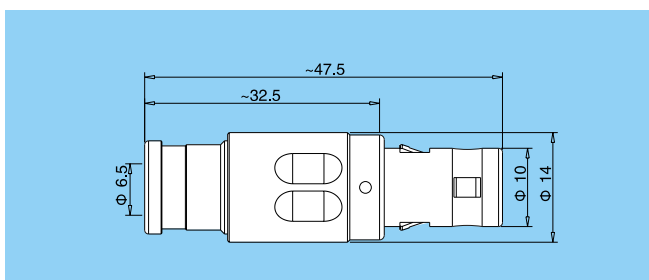

PKG Fixed socket with two nuts(back panel mounting)

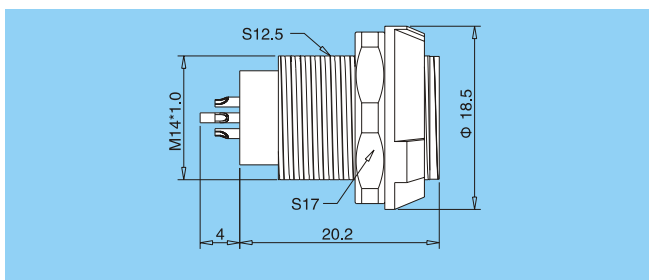

PRG Fixed socket with two nuts and cable collet(back panel mounting), out shell aluminum alloy

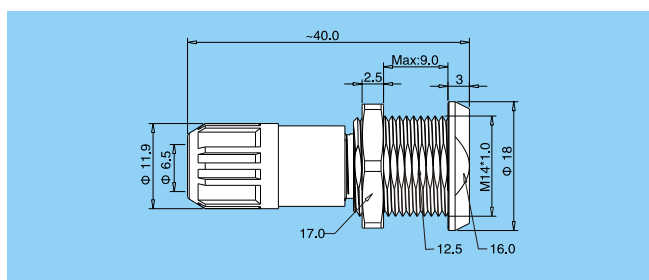
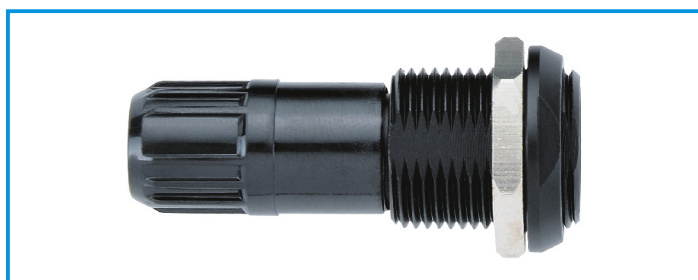

PTG Free socket, out shell aluminum alloy

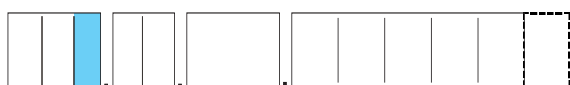
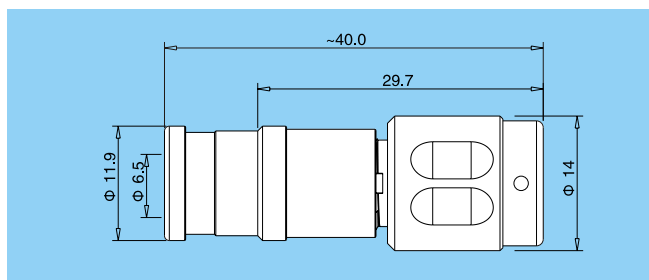
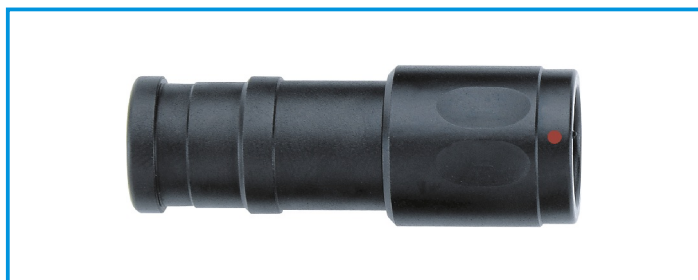

Alignment Key (1P series)

Alignment Key and Polarized Keying System

1P series connector model part numbers are composed of three letters. The LAST LETTER indicates the key position and the contact type (male or female)

	Graphical			
<p>Reference</p>	<p>0°</p> <p>G</p>	<p>40°</p> <p>A</p>	<p>60°</p> <p>B</p>	<p>80°</p> <p>C</p>

Part Section Showing Internal Components

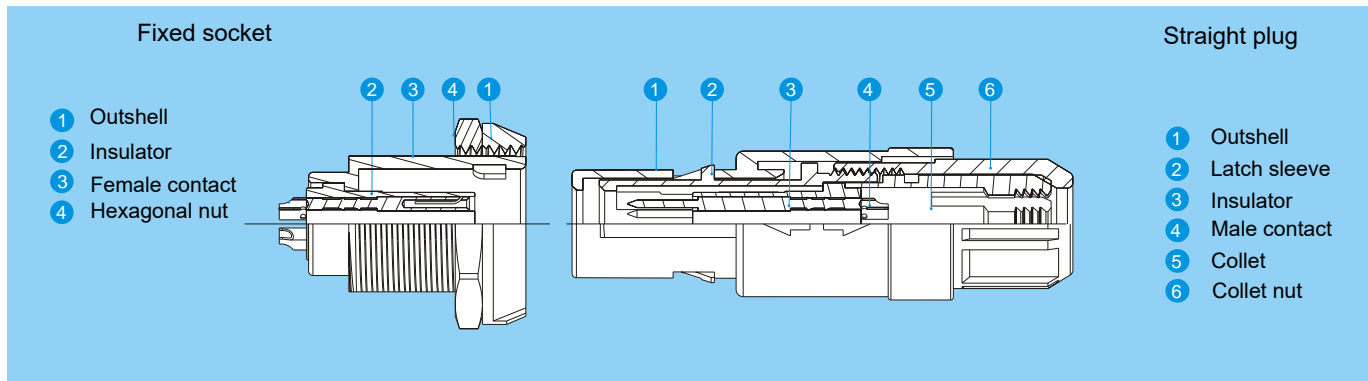

2P series connectors have main features as follows:

- security of the Push-Pull self-latching system
- multipole types 2 to 34 contacts
- ϕ 18 mm connector accommodates cable up to 9 mm and allows up to 34 solder contacts.
- high packing density for space savings
- colour coding of plug and socket flange will give an instant visual indication as to whether connectors are compatible or not.
- plastic shell, water resistant to IP 66 options are available.

2P Series Connectors Technical Characteristics:

- Endurance: > 1000 cycles
- Humidity: up to 95% at 60° C
- Temperature range: - 50° C, + 150° C
- Shock resistance: 100 g, 6 ms
- Resistance to vibrations: 10-2000 Hz, 15g
- Withstand voltage: 500V AC, 60S
- Protection index (mated): IP 66

2P Series Part Numbering System

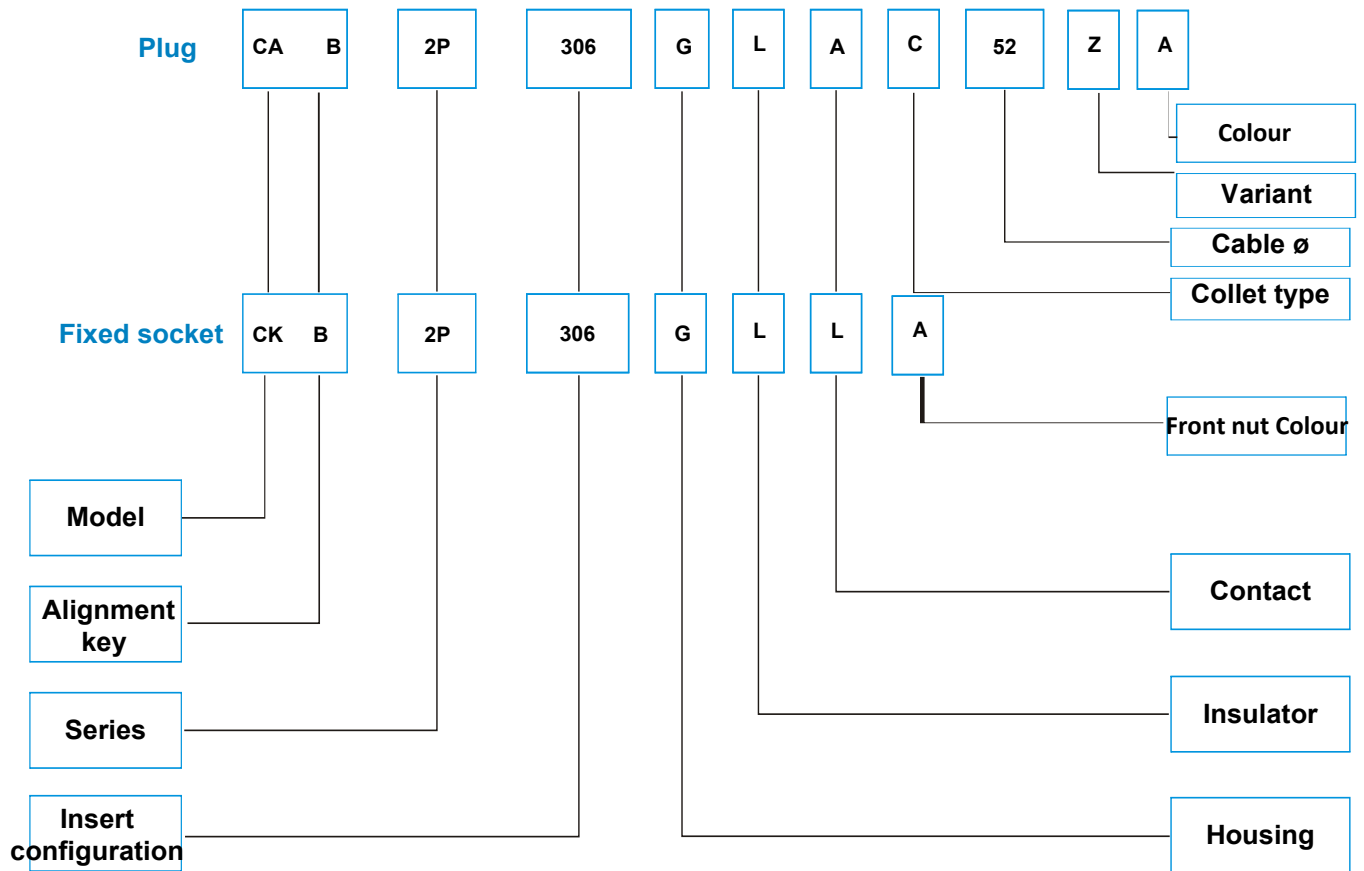

Part Number Example

Straight Plug with Cable Collet:

CAB.2P.306.GLAC52A = straight plug with key (B) and cable collet, 2P series, multipole type with 6 contacts, outer shell in grey PSU, PPS insulator, male solder contacts, collet for a cable 4.5 to 5.5 mm diameter and blue collet nut.

Fixed Socket:

CKB.2P.306.GLL = fixed socket, nut fixing, with key (G), 2P series, multipole type with 6 contacts, outer shell in grey PSU, PPS insulator, female solder contacts.



Plastic Housing Models:2P series

CAB Straight plug with cable collet

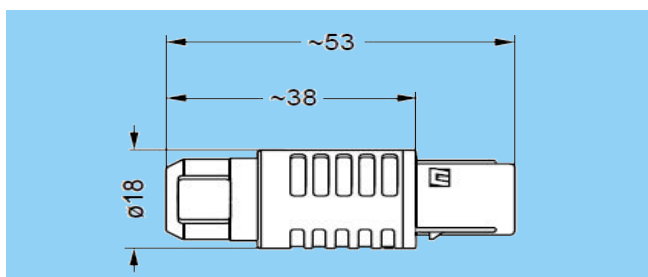

CKB Fixed socket with two nuts(back panel mounting)

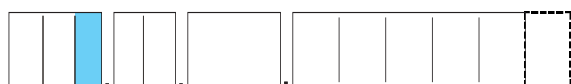
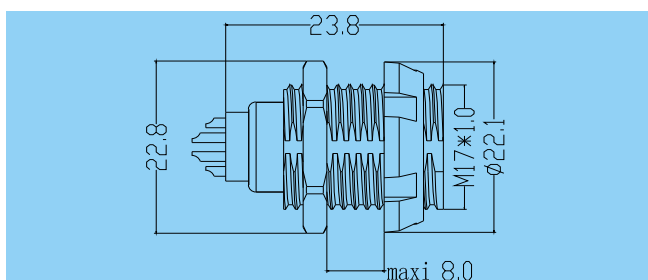

Alignment Key (2P series)

Alignment Key and Polarized Keying System

2P series connector model part numbers are composed of three letters. The LAST LETTER indicates the key position and the contact type (male or female)

	Graphical		
	 60°	 100°	 110°
Reference	B	C	D

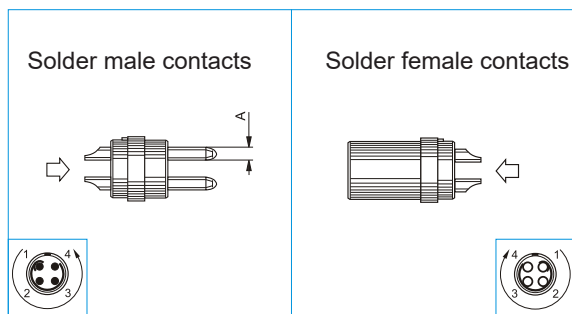

1P

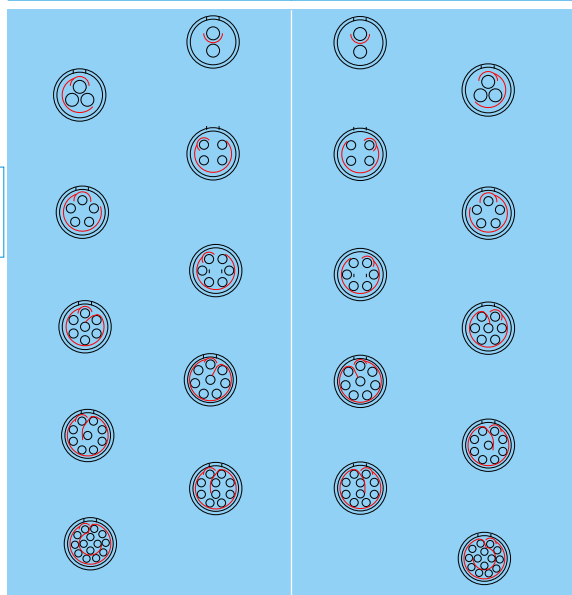

2P

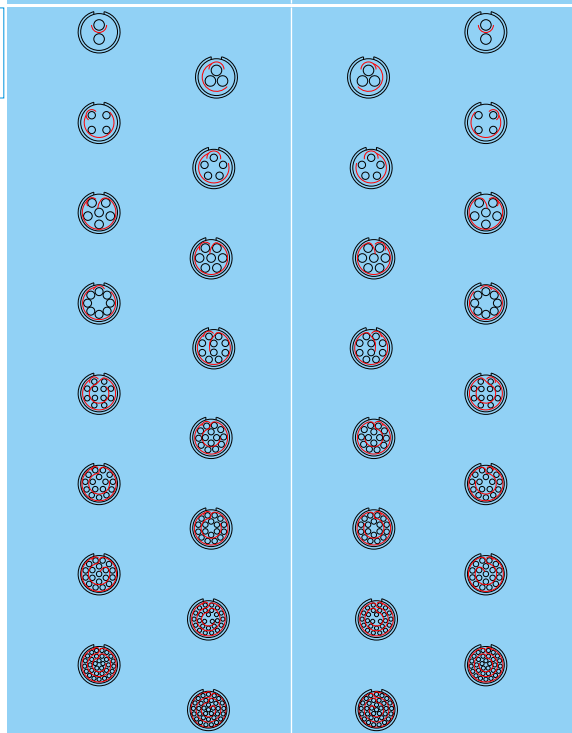

Reference	Multipole(contacts)	Φ A (mm)	Conductor Size(AWG)	Test voltage (kV rms) Contact-contact	Test voltage (kV rms) Contact-shell	Rated current (A)
302	2	1.3	20	1.20	1.30	10.0
303	3	1.3	20	1.15	1.25	9.0
304	4	0.9	22	1.20	1.20	8.0
305	5	0.9	22	1.05	0.80	7.0
306	6	0.7	22	1.05	0.85	6.0
307	7	0.7	22	1.05	0.85	5.0
308	8	0.7	22	1.05	0.60	5.0
309	9	0.5	28	0.85	0.60	3.0
310	10	0.5	28	0.85	0.45	3.0
314	14	0.5	28	0.65	0.50	2.0
302	2	2.0	14	2.10	1.60	30.0
303	3	1.6	16	2.40	1.50	17.0
304	4	1.3	20	1.85	1.80	15.0
305	5	1.3	20	1.75	1.10	14.0
306	6	1.3	20	1.35	0.85	12.0
307	7	1.3	20	1.75	0.95	11.0
308	8	0.9	22	1.50	1.00	10.0
310	10	0.9	22	1.45	0.75	8.0
312	12	0.7	22	1.25	0.85	7.0
314	14	0.7	22	1.50	0.65	6.5
316	16	0.7	22	1.40	0.60	6.0
318	18	0.7	22	0.85	1.20	5.5
319	19	0.7	22	0.95	1.25	5.0
326	26	0.5	28	1.00	0.55	2.0
332	32	0.5	28	0.70	0.35	1.5
334	34	0.5	28	0.70	0.30	1.5



Ref.	Outer shell and collet nut	Note
	Material	
G	Grey PSU	
Z	Aluminium alloy	
N	Black PSU	

Note:

PSU

Polysulfone (PSU) - A family of sulfur-containing thermoplastics, closely related to polyethersulfone (PES). The structure of the polysulfones is aromatic groups, generally with more than one benzene ring, joined by a sulfone group. Generally, polysulfone is a high cost, rigid, amorphous material with low moisture absorption. Reinforcement improves toughness and further enhances dimensional stability, but turns materials opaque. In addition, polysulfones are characterized by high strength, very high surface-temperature limits, low creep, good electrical characteristics, transparency, self-extinguishing ability, and resistance to greases, many solvents, and chemicals. Polysulfones may be processed by extrusion, injection molding, and blow molding.

Aluminium alloy

In the aviation, aerospace industry, portable mobile devices and so on. It is suitable for the connector with aluminium alloy shell.

In addition to its high mechanical lightness and excellent corrosion resistance, the surface of aluminium alloys can be protected by anodic plating, with a variety of colors to choose from.



Ref.	Material	Contact type	Note
T	Teflon	Solder or print	
L	PPS	Solder or print	

>>> Contacts (1P, 2P series)

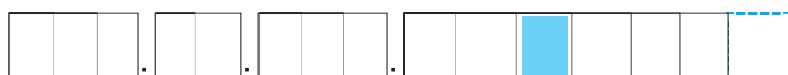

Contact Type	Plug		Socket	
	Male	Female	Male	Female
Solder	A	L	A	L

>>> Collets (1P, 2P series)



Reference	Cable ø(mm)
42	3.5–4.5
52	4.5–5.5
62	5.5–6.5

>>> Variant (1P, 2P series)



To order a model with cable collet and nut for fitting a bendrelief, you should write a "Z" in the variant position.

Bend reliefs to be ordered separately (see page 19)

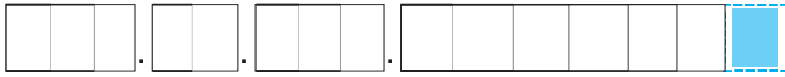

Colours	blue	grey	yellow	black	red	green
Reference	A	G	J	N	R	V

➤➤➤ Plug assembly instructions: (1P, 2P series)

Plug assembly instructions for 1P, 2P series

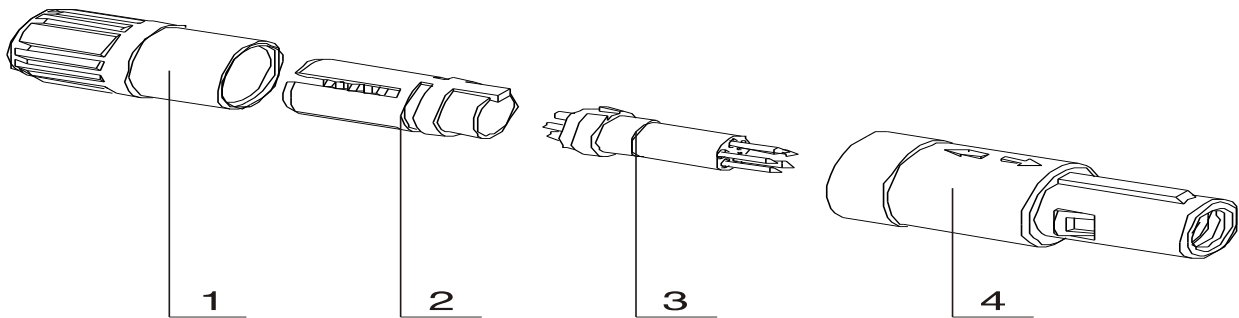

1. The cable is passed through the collet nut ① in sequence, and the cable collet ② is soldered to the corresponding position of the insulator with contacts ③.
2. Attach the cable collet ② to the welded the insulator with contacts ③, paying attention to the projection of the cable collet ② and the groove of the insulator with contacts ③.
3. Insert the insulator with contacts ③ into the housing subassy ④, noting that the projections on the cable collet ② are to be correspondingly fitted to the recesses in the housing subassy ④.
4. Insert the collet nut ① into the housing subassy ④ and tighten the collet nut.

➤➤➤ Panel cut-out: (1P, 2P series)

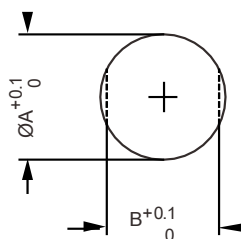

Panel Cut-Outs

Series	$\varnothing A$	B
1P	14.1	12.6
2P	17.1	15.6

Mounting Nut Torque

Series	Torque (Nm)
1P	1.5
2P	0.8

1N=0.102kg