



Kia Optima 2011-2013

KIT FEATURES

- ISO DDIN radio provision
- Painted matte black match factory dash

KIT COMPONENTS

- A) Radio trim panel • B) Radio brackets • C) (3) #8 x 3/8" Phillips screws

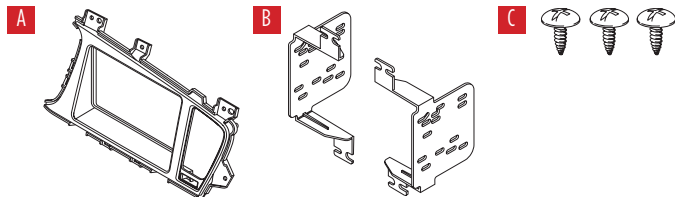

TABLE OF CONTENTS

Dash Disassembly	2
Kit Preparation	3
Kit Assembly	3

WIRING & ANTENNA CONNECTIONS (sold separately)

- Wiring Harness: 70-7304 • AX-HYKIA1-SWC & AX-HYKIA-SPDIF (for amplified models)
- Antenna Adapter: Not required
- Steering wheel control interface: AXSWC

TOOLS REQUIRED

- Panel removal tool • Phillips screwdriver

CAUTION! All accessories, switches, climate controls panels, and especially air bag indicator lights must be connected before cycling the ignition. Also, do not remove the factory radio with the key in the on position, or while the vehicle is running.

DASH DISASSEMBLY

1. Unsnap and remove trim from around top center to passenger side dash. (Figure A)
2. Unsnap panel from outside edge of driver's side dash. (Figure B)
3. Remove (2) screws from knee panel and pull top of panel back so it doesn't overlap the instrument cluster. (Figure C)
4. Remove (2) screws from the driver's side vent trim and remove. (Figure D)

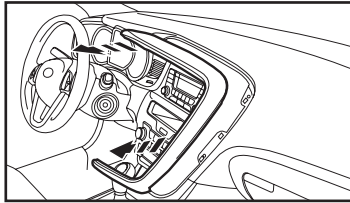

(Figure A)

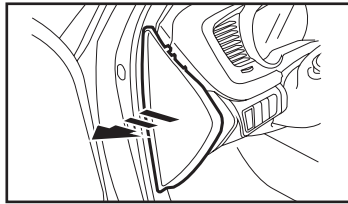

(Figure B)

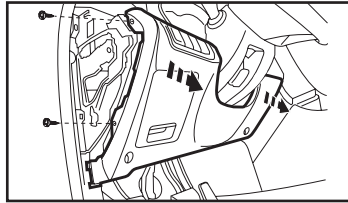

(Figure C)

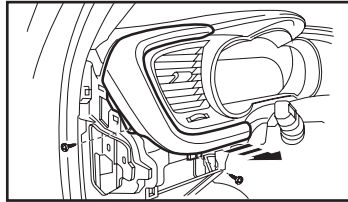

(Figure D)

5. Remove (5) screws from instrument cluster and remove. (Figure E)
6. Remove (4) screws from the climate controls and remove. (Figure F)
7. Remove (6) screws securing the radio trim panel and remove. (Figure G)
8. Remove (4) screws securing the factory radio chassis and remove it. (Figure H)

Continue to Kit Preparation

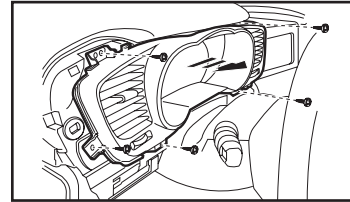

(Figure E)

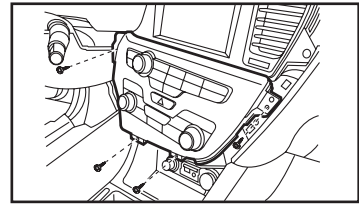

(Figure F)

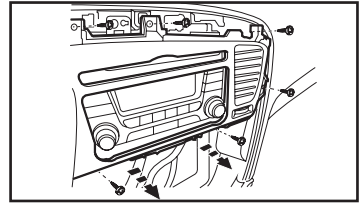

(Figure G)

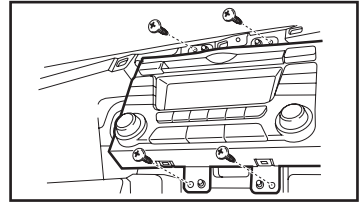

(Figure H)

KIT PREPARATION

1. Remove (3) screws and remove the vent from the factory radio panel. (Figure A)
2. Using the supplied #8 x 3/8" Phillips screws, install the vent to the kits trim panel. (Figure B)

Continue to Kit Assembly

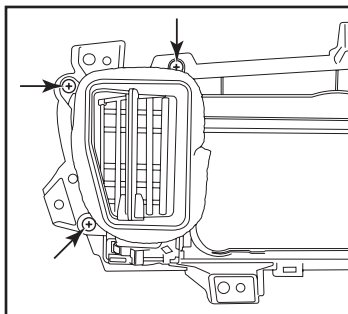

(Figure A)

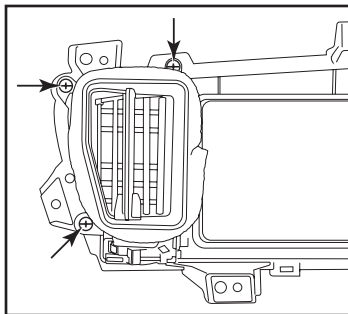

(Figure B)

KIT ASSEMBLY

1. Secure the *radio brackets* to the radio using the screws supplied with the radio. (Figure A)
2. Locate the factory wiring harness and antenna connector in the dash and complete all necessary connections to the radio. Metra recommends using the proper mating adapter from Metra and/or Axxess. Test the radio for proper operation.
3. Secure the radio assembly to the dash using the factory screws. (Figure B)
4. Snap the *radio trim panel* over the radio assembly, then reassemble the dash in reverse order of disassembly. (Figure C)

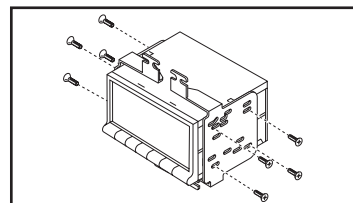

(Figure A)

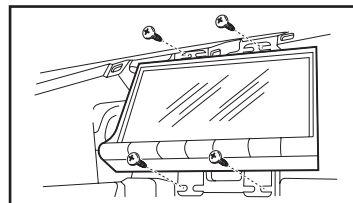

(Figure B)

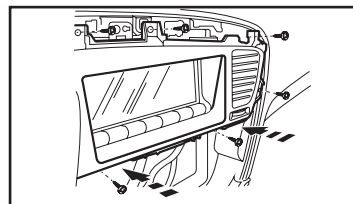

(Figure C)



95-7345B
INSTALLATION INSTRUCTIONS



IMPORTANT

If you are having difficulties with the installation of this product, please call our Tech Support line at 1-800-253-TECH. Before doing so, look over the instructions a second time, and make sure the installation was performed exactly as the instructions are stated. Please have the vehicle apart and ready to perform troubleshooting steps before calling.



KNOWLEDGE IS POWER

Enhance your installation and fabrication skills by enrolling in the most recognized and respected mobile electronics school in our industry. Log onto www.installerinstitute.com or call 800-354-6782 for more information and take steps toward a better tomorrow.



**Metra recommends MECP
certified technicians**



Kia Optima 2011-2013

CARACTERÍSTICAS DEL KIT

- Provisión de radio ISO DDIN
- Pintado en negro mate para igualar el acabado de fábrica

COMPONENTES DEL KIT

- A) Panel de moldura de radio • B) Soportes de radio • C) (4) Tornillos Phillips #8 x 3/8"

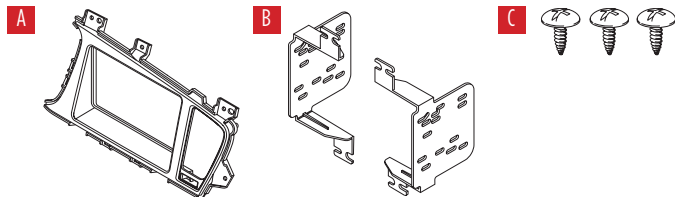

INDICE

Desmontaje del tablero	2
Preparación del Kit	3
Ensamble del kit	3

CABLEADO Y CONEXIONES DE ANTENA

(se venden por separado)

- Arnés de cables: 70-7304 • AX-HYKIA1-SWC
y AX-HYKIA-SPDIF (para modelos amplificados)
- Adaptador de antena: No se requiere
- Interfaz de control en volante Axxess: AXSWC

HERRAMIENTAS REQUERIDAS

- Herramienta para quitar paneles
- Destornillador Phillips

¡PRECAUCIÓN! Todos los accesorios, interruptores, paneles de controles de clima y especialmente las luces del indicador de las bolsas de aire deben estar conectados antes de encender el vehículo. Además, no quite el radio de fábrica con la llave en la posición de encendido ni con el vehículo funcionando.

DESMONTAJE DEL TABLERO

1. Desenganche y quite la moldura de alrededor de la parte de arriba del centro al tablero del lado del pasajero. (Figura A)
2. Desenganche el panel del borde de afuera del tablero del lado del conductor. (Figura B)
3. Quite los (2) tornillos del panel que protege las rodillas y jale la parte de arriba del panel hacia atrás para que no se empalme con el conjunto de instrumentos. (Figura C)
4. Quite los (2) tornillos de la moldura de la rejilla del lado del conductor y quítela. (Figura D)

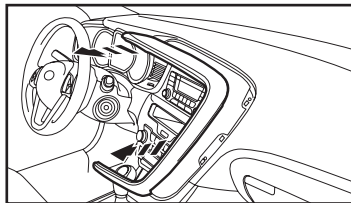

(Figura A)

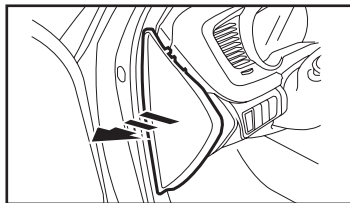

(Figura B)

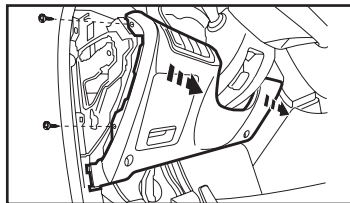

(Figura C)

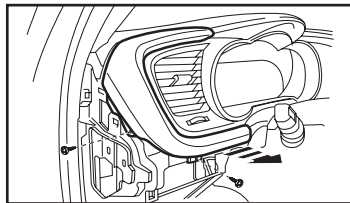

(Figura D)

5. Quite los (5) tornillos del conjunto de instrumentos y quítelo. (Figura E)
6. Quite los (4) tornillos de los controles del clima y quítelos. (Figura F)
7. Quite los (6) tornillos que sostienen el panel de la moldura del radio y quítelo. (Figura G)
8. Quite los (4) tornillos que sostienen el chasis del radio de fábrica y quítelo. (Figura H)

Continúe con la Preparación del Kit

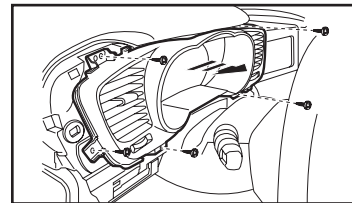

(Figura E)

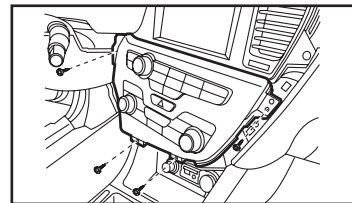

(Figura F)

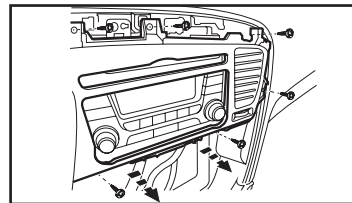

(Figura G)

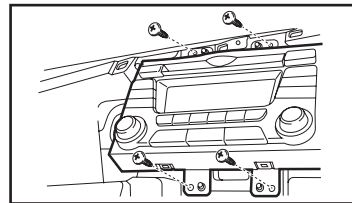

(Figura H)

PREPARACIÓN DEL KIT

1. Quite los (3) tornillos y quite la rejilla del panel del radio de fábrica. (Figura A)
2. Con los tornillos Phillips # 8 x 3/8" provistos, instale la ventilación en el panel de acabado de los kits. (Figura B)

Continúe con el Ensamble del Kit

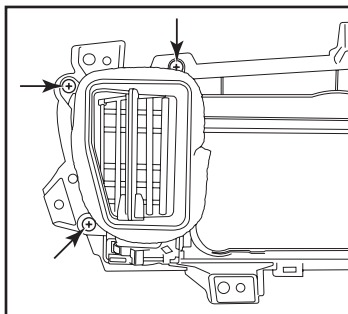

(Figura A)

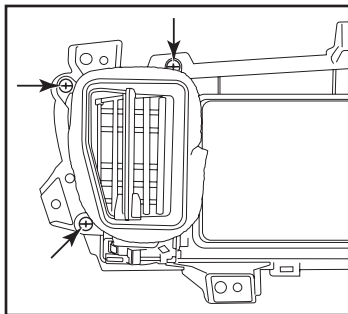

(Figura B)

ENSAMBLE DEL KIT

1. Asegure los *soportes de radio* a la radio usando los tornillos suministrados con el radio. (Figura A)
2. Localice el arnés de cableado de fábrica y el conector de la antena en el tablero y haga todas las conexiones necesarias al radio. Metra recomienda que use adaptadores adecuados de acoplamiento de Metra y/o de AXCESS. Pruebe el radio para verificar que funcione correctamente.
3. Asegure el ensamble de la radio al tablero usando los tornillos de fábrica.
4. Enganche el *panel de la moldura del radio* sobre el ensamble del radio, luego vuelva a ensamblar el tablero en orden inverso al del desmontaje. (Figura C)

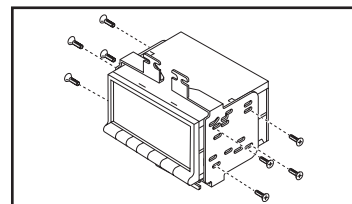

(Figura A)

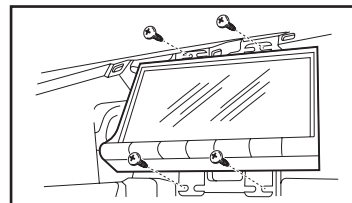

(Figura B)

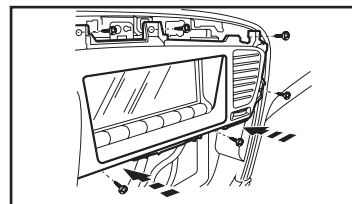

(Figura C)



95-7345B
INSTRUCCIONES DE INSTALACIÓN



IMPORTANTE

Si tiene dificultades con la instalación de este producto, llame a nuestra línea de soporte técnico al 1-800-253-TECH. Antes de hacerlo, revise las instrucciones por segunda vez y asegúrese de que la instalación se haya realizado exactamente como se indica en las instrucciones. Por favor tenga el vehículo desarmado y listo para ejecutar los pasos de resolución de problemas antes de llamar.



EL CONOCIMIENTO ES PODER

Mejore sus habilidades de instalación y fabricación inscribiéndose en la escuela de dispositivos electrónicos móviles más reconocida y respetada de nuestra industria. Regístrese en www.installerinstitute.com o llame al 800-354-6782 para obtener más información y avance hacia un futuro mejor.



Metra recomienda técnicos con certificación del Programa de Certificación en Electrónica Móvil (Mobile Electronics Certification Program, MECP).