



### Nissan **Rogue 2014-2020,** Nissan **Rogue Sport 2017-Up**

Visit [MetraOnline.com](http://MetraOnline.com) for more detailed information about the product and up-to-date vehicle specific applications

#### KIT FEATURES

- DDIN radio provision
- Painted high-gloss black metallic

#### KIT COMPONENTS

- A) Radio housing • B) Brackets

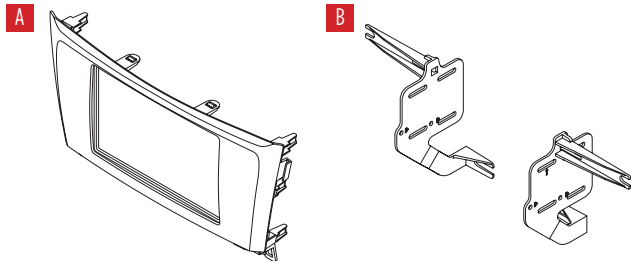

#### TABLE OF CONTENTS

Dash Disassembly .....	2
Kit Assembly .....	3

#### WIRING & ANTENNA CONNECTIONS (sold separately)

Wiring Harness: 70-7552

Antenna Adapter: 40-N112

#### TOOLS REQUIRED

- Panel removal tool • Phillips screwdriver

**Attention!** With the key out of the ignition, disconnect the negative battery terminal before installing this product. Ensure that all installation connections are secure before cycling the ignition to test this product.

## DASH DISASSEMBLY

1. Unclip and remove the trim panel on the end of the passenger side of the dash. (Figure A)
2. Remove (1) Phillips screw securing the A/C vent then unclip and remove the vent. (Figure B)
3. Unclip and remove the trim panel above the glove box starting at the vent and working your way over to the radio. **Note:** There is a hook on the radio side of this panel so make sure you start from the vent on the passenger side. (Figure C)

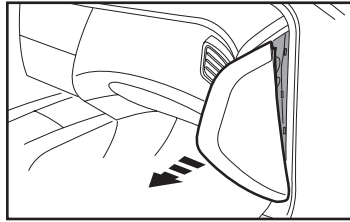

(Figure A)

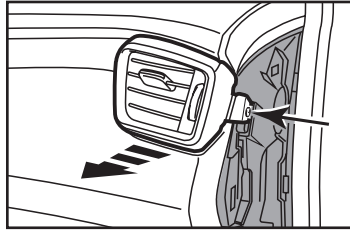

(Figure B)

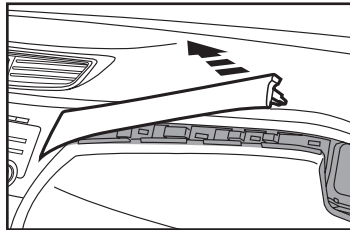

(Figure C)

4. Unclip and remove the A/C control. (Figure D)
5. Unclip and remove the trim panel to the left of the factory radio. **Note:** On push to start models this panel will have the start button on it. (Figure E)
6. Remove (4) Phillips screws securing the factory radio then unclip and remove the radio. (Figure F)

*Continue to Kit Assembly*

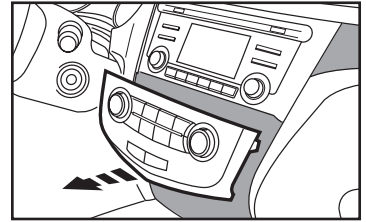

(Figure D)

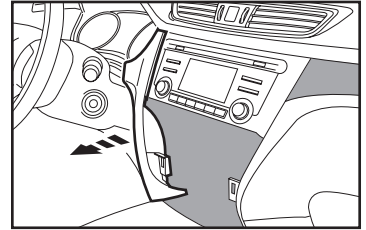

(Figure E)

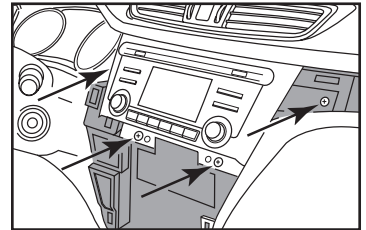

(Figure F)

## KIT ASSEMBLY

1. Attach the **brackets** to the aftermarket radio using the screws supplied with the radio. (Figure A)
2. Locate the factory wiring harness in the dash. Metra recommends using the proper mating adapter from Metra or AXCESS. Re-connect the negative battery terminal and test the unit for proper operation.
3. Mount the new radio assembly into the dash then snap the **radio housing** over the radio assembly.
4. Reassemble dash in reverse order of disassembly.

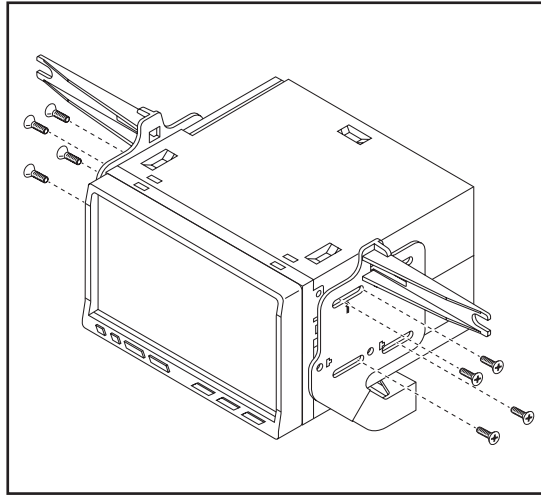

(Figure A)



**95-7622HG**  
INSTALLATION INSTRUCTIONS



Having difficulties? We're here to help.



Contact our Tech Support line at:

**386-257-1187**



Or via email at:

[techsupport@metra-autosound.com](mailto:techsupport@metra-autosound.com)

**Tech Support Hours (Eastern Standard Time)**

Monday - Friday: 9:00 AM - 7:00 PM

Saturday: 10:00 AM - 7:00 PM

Sunday: 10:00 AM - 4:00 PM



**KNOWLEDGE IS POWER**

Enhance your installation and fabrication skills by enrolling in the most recognized and respected mobile electronics school in our industry. Log onto [www.installerinstitute.edu](http://www.installerinstitute.edu) or call 386-672-5771 for more information and take steps toward a better tomorrow.



**Metra recommends MECP  
certified technicians**



### Nissan Rogue 2014-2020, Nissan Rogue Sport 2017 y mas

Visite [MetraOnline.com](http://MetraOnline.com) para más información acerca del producto y las aplicaciones específicas más actualizadas del vehículo

#### CARACTERÍSTICAS DEL KIT

- Provisión de radio DDIN
- Pintura negra metálica de alto brillo

#### COMPONENTES DEL KIT

- A) Carcasa del radio • B) Soportes

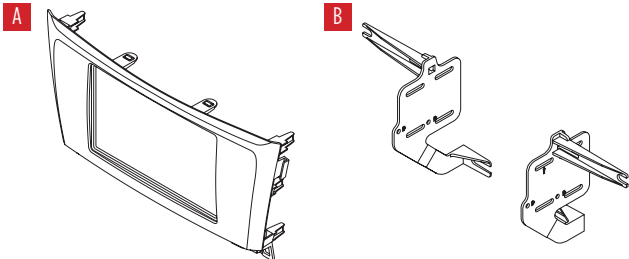

#### INDICE

Desmontaje del tablero .....	2
Ensamble del kit .....	3

#### CABLEADO Y CONEXIONES DE ANTENA

(se venden por separado)

- Arnés de cableado: 70-7522
- Adaptador de antena: 40-N112

#### HERRAMIENTAS NECESARIAS

- Herramienta para remoción de paneles
- Destornillador Phillips

**¡Atención!** Con la llave fuera del encendido, desconecte el terminal negativo de la batería antes de instalar este producto. Asegúrese de que todas las conexiones de la instalación estén seguras antes de encender y apagar el encendido para probar este producto.

## DESMONTAJE DEL TABLERO

1. Desenganche y quite el panel de moldura que está al final del lado del pasajero en el tablero. (Figura A)
2. Quite (1) tornillo Phillips que sujeta la rejilla del aire acondicionado, luego desenganche y quite la rejilla. (Figura B)
3. Desenganche y retire el panel de la moldura de arriba de la guantera, empezando en la rejilla y avanzando hacia el radio. **Nota:** Hay un gancho en el lado del radio de este panel, así que asegúrese de empezar desde la rejilla del lado del pasajero. (Figura C)

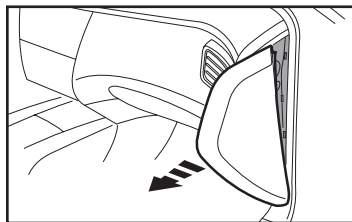

(Figura A)

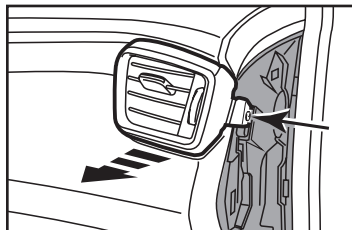

(Figura B)

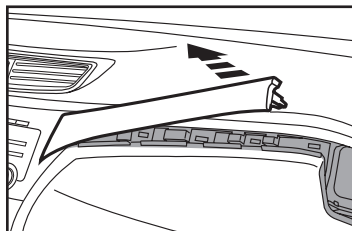

(Figura C)

4. Desenganche y quite el control del aire acondicionado. (Figura D)
5. Desenganche y quite el panel de moldura a la izquierda del radio de fábrica. **Nota:** En los modelos de presionar para arrancar, este panel contendrá el botón de inicio. (Figura E)
6. Quite los (4) tornillos Phillips que sujetan el radio de fábrica, luego desenganche y quite el radio. (Figura F)

*Continúe con el ensamble del kit*

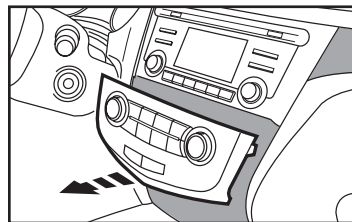

(Figura D)

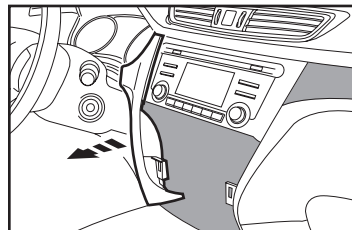

(Figura E)

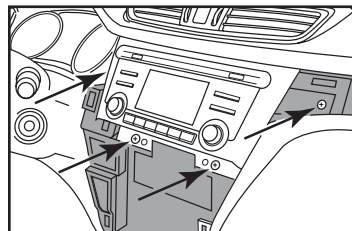

(Figura F)

## ENSAMBLE DEL KIT

1. Coloque el radio en los **soportes** con los tornillos que vienen con el radio y monte en la apertura del tablero. (Figura A)
2. Ubique el arnés de cableado de fábrica en el tablero. Metra recomienda el uso de un adaptador adecuado de acoplamiento de Metra o de AXCESS. Vuelva a conectar la terminal negativa de la batería y pruebe la unidad para verificar que funcione correctamente.
3. Monte el nuevo ensamble de radio/cavidad en el tablero y coloque a presión la **carcasa del radio** encima del ensamble del radio.
4. Vuelva a armar el tablero al revés de como lo desarmó.

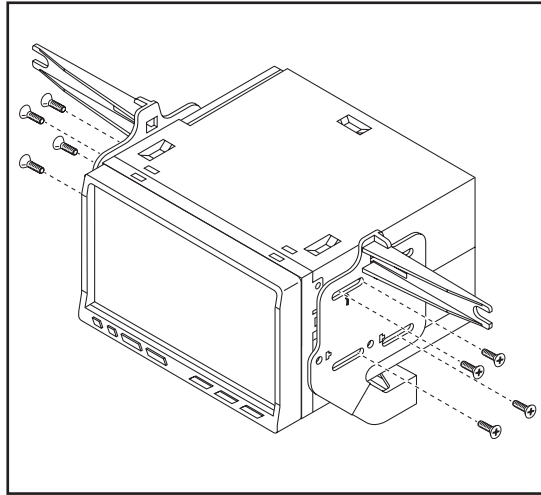

(Figura A)



**95-7622HG**  
INSTRUCCIONES DE INSTALACIÓN



¿Tienes dificultades? Estamos aquí para ayudar.



Póngase en contacto con nuestra  
línea de soporte técnico en:  
**386-257-1187**



O por correo electrónico a:  
[techsupport@metra-autosound.com](mailto:techsupport@metra-autosound.com)

**Horas de soporte técnico (hora estándar del este)**

Monday - Friday: 9:00 AM - 7:00 PM

Saturday: 10:00 AM - 7:00 PM

Sunday: 10:00 AM - 4:00 PM



**KNOWLEDGE IS POWER**

Enhance your installation and fabrication skills by enrolling in the most recognized and respected mobile electronics school in our industry. Log onto [www.installerinstitute.edu](http://www.installerinstitute.edu) or call 386-672-5771 for more information and take steps toward a better tomorrow.



**Metra recomienda MECP  
técnicos certificados**