



Honda Pilot 2003-2005

Honda Pilot (without factory NAV) 2006-2008

Visit MetraOnline.com for more detailed information about the product and up-to-date vehicle specific applications

KIT FEATURES

- ISO DIN radio provision with pocket
- ISO DDIN radio provision

KIT COMPONENTS

- A) "LX" trim panel • B) "EX" trim panel • C) "LX" Radio brackets • D) "EX" Radio brackets • E) Pocket • F) #8 x 3/8" Phillips screws (4)

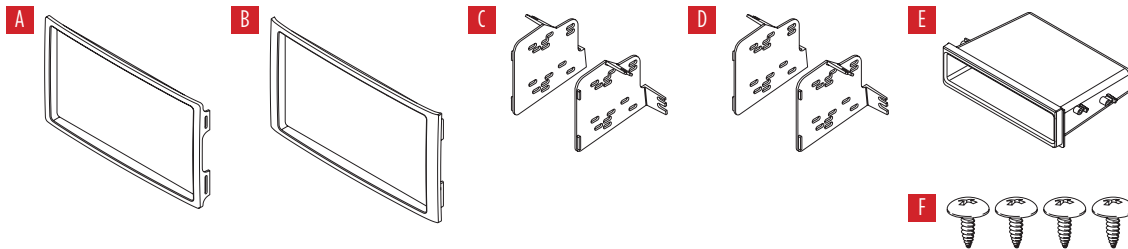

TABLE OF CONTENTS

Dash Disassembly	
– . Pilot 2003-2005	2
– . Pilot 2006-2008 (without factory NAV)	2
Kit Assembly	
– . ISO DIN radio provision with pocket	3
– . ISO DDIN radio provision	3

WIRING & ANTENNA CONNECTIONS (sold separately)

Wiring Harness: 70-1721

Antenna Adapter: 03-05 Not required,
06-08 40-HD10

TOOLS REQUIRED

- Panel removal tool • Phillips screwdriver
- 10mm socket wrench

Attention! Let the vehicle sit with the key out of the ignition for a few minutes before removing the factory radio. When testing the aftermarket equipment, ensure that all factory equipment is connected before cycling the key to ignition.

DASH DISASSEMBLY

Pilot 2003-2005

1. Using a panel removal tool, remove the blank plate from upper right side of radio trim panel. (Figure A)
2. Unsnap radio trim panel. Unplug switches and remove panel. (Figure B)
3. Remove (4) 10mm bolts securing radio, unplug and remove radio. (Figure C)

Continue to Kit Assembly

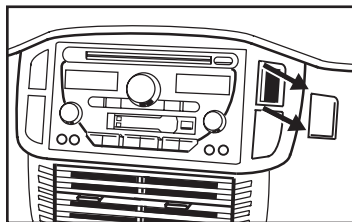

(Figure A)

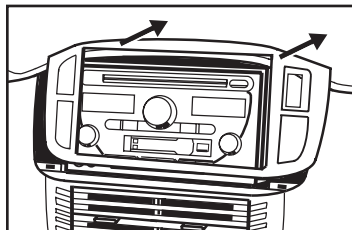

(Figure B)

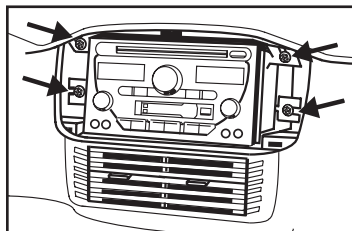

(Figure C)

Pilot 2006-2008 (without factory NAV)

1. Remove (2) screws from the top of the instrument panel trim, and then unclip and remove the instrument panel trim. (Figure A)
2. Unclip and remove the left center trim panel. (Figure B)
3. Unclip the radio trim panel, and then plug and remove the panel. (Figure C)
4. Remove the (4) screws securing the radio. Unplug and remove the radio. (Figure D)

Continue to Kit Assembly

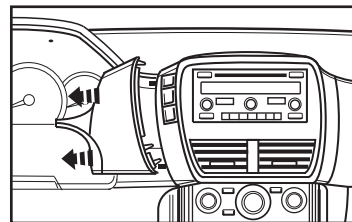

(Figure A)

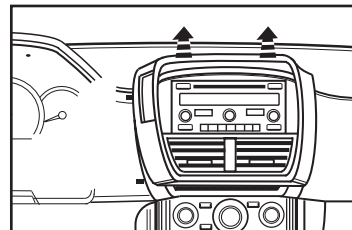

(Figure B)

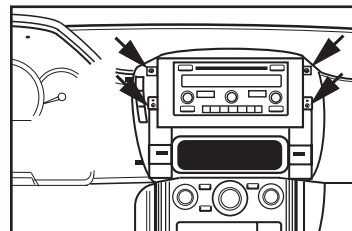

(Figure C)

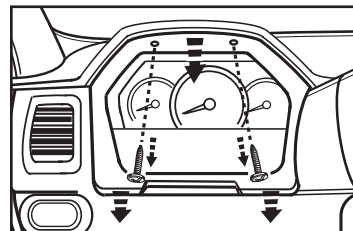

(Figure A)

KIT ASSEMBLY

ISO DIN radio provision with pocket

Note: Select the proper radio housing for your vehicle. EX models use the (EX) Double DIN Trim Plate and (EX) brackets. LX models use the (LX) Double DIN Trim Plate and (LX) brackets

1. Clip the **radio brackets** onto the **radio trim panel**. (Figure A)
2. Attach the **pocket** to the lower section of the **radio brackets** using the (4) #8 x 3/8" Phillips screws provided. (Figure B)
3. Remove the metal DIN sleeve and trim ring from the aftermarket radio.
4. Slide the radio into the bracket/pocket assembly, and then secure using the screws supplied with the radio. (Figure C)
5. Locate the factory wiring harness and antenna connector in the dash and complete all necessary connections to the radio. Metra recommends using the proper mating adapter from Metra and/or AXXESS. Test the radio for proper operation.
6. Reassemble the dash in reverse order of disassembly.

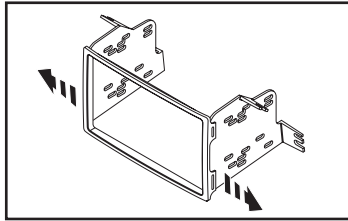

(Figure A)

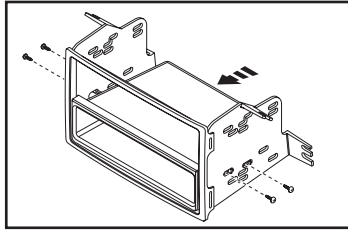

(Figure B)

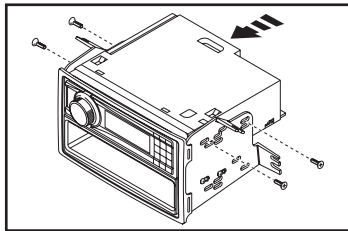

(Figure C)

ISO DDIN radio provision

Note: Select the proper radio housing for your vehicle. EX models use the (EX) Double DIN Trim Plate and (EX) brackets. LX models use the (LX) Double DIN Trim Plate and (LX) brackets

1. Clip the **radio brackets** onto the **radio trim panel**. (Figure A)
2. Slide the radio into the bracket/radio trim panel assembly, and then secure using the screws supplied with the radio. (Figure B)
3. Locate the factory wiring harness and antenna connector in the dash and complete all necessary connections to the radio. Metra recommends using the proper mating adapter from Metra and/or AXXESS. Test the radio for proper operation.
4. Reassemble the dash in reverse order of disassembly.

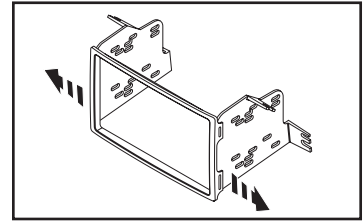

(Figure A)

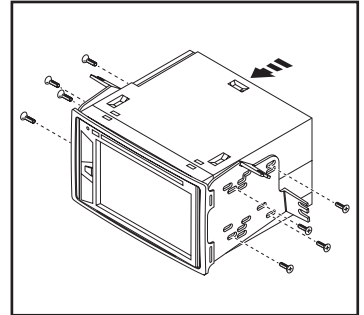

(Figure B)



99-7818
INSTALLATION INSTRUCTIONS



If you are having difficulties with the installation of this product, contact our Tech Support line either by phone at **1-800-253-TECH**, or email at **techsupport@metra-autosound.com**. Before doing so, look over the instruction booklet a second time and ensure that the installation was performed exactly as the instruction booklet is stated. Have the vehicle apart and ready to perform troubleshooting steps before contacting Metra/Axxess Tech Support.



KNOWLEDGE IS POWER

Enhance your installation and fabrication skills by enrolling in the most recognized and respected mobile electronics school in our industry. Log onto www.installerinstitute.com or call 800-354-6782 for more information and take steps toward a better tomorrow.



Metra recommends MECP certified technicians