



Honda Accord 2008-2012*

Honda Accord Crosstour 2010-2011*

*For non-navigation models with dual zone automatic climate controls
 Visit MetraOnline.com for up-to-date vehicle specific applications

KIT FEATURES

- DIN radio provision with pocket
- ISO mount radio provision with pocket
- Double DIN radio provision
- Stacked ISO mount units provision
- Painted to match factory dash 99-7875=Charcoal, 99-7875T=Taupe

KIT COMPONENTS

- A) Radio Housing • B) ISO Brackets • C) ISO Trim Plate • D) Double DIN Brackets • E) Double DIN Trim Plate • F) Pocket

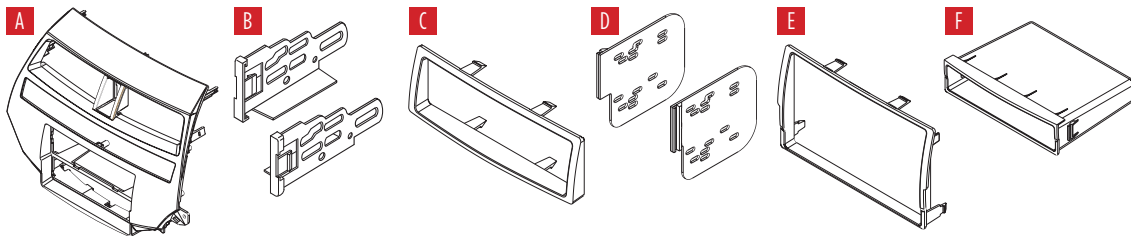

TABLE OF CONTENTS

Dash Disassembly.....	2
Kit Preparation.....	4
Kit Assembly	
–DIN mount radio provision with pocket.....	5
–ISO mount radio provision with pocket.....	6
–DDIN/Stacked ISO mount units provision.....	6
Final Assembly.....	7

WIRING & ANTENNA CONNECTIONS (sold separately)

- Wiring Harness: 70-1729 - Honda harness 2008-up
 • 70-1730 Honda amp interface harness 2008-up
- Antenna Adapter: 40-HD10 - Honda antenna adapter 2005-up

TOOLS REQUIRED

- Small flat blade screwdriver • Panel removal tool
- Phillips screwdriver • Cutting tool

Attention! With the key out of the ignition, disconnect the negative battery terminal before installing this product. Ensure that all installation connections are secure before cycling the ignition to test this product.

DASH DISASSEMBLY

1. Unclip and remove the trim panel from above the glove box located on the right side of the factory radio. (Figure A)
2. Unclip and detach the trim panel located on the left side of the factory radio. (Figure B)

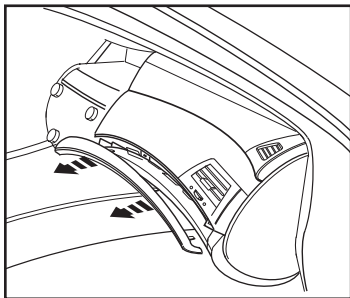

(Figure A)

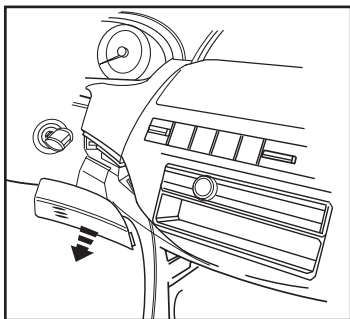

(Figure B)

3. Remove the (2) Phillips screws from the left and right side of the factory radio. (Figure C)
4. Unsnap and remove the top of the center console, including the cup holders. (Figure D)
5. Remove (2) Phillips screws at the bottom edge of the pocket assembly. (Figure E)

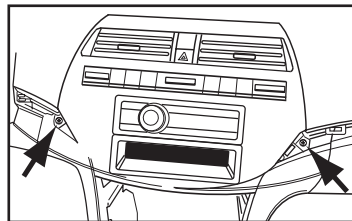

(Figure C)

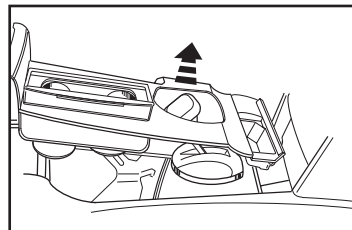

(Figure D)

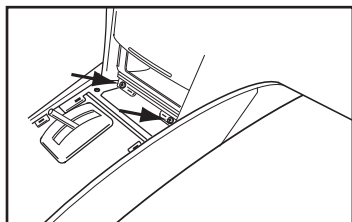

(Figure E)

DASH DISASSEMBLY

- Remove (2) Phillips screws facing up inside of the pocket below the factory radio. (Figure F)
- Unsnap and remove the pocket assembly. (Figure G)
- Remove (2) Phillips screws facing out on the bottom of the factory radio. (Figure H)

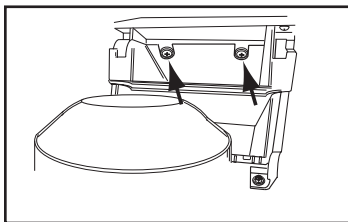

(Figure F)

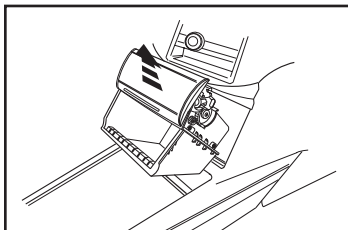

(Figure G)

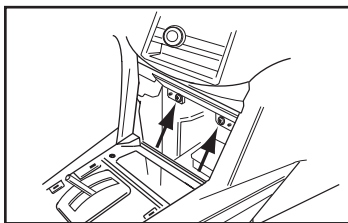

(Figure H)

- Unclip the factory radio assembly. Unplug and remove the radio assembly. (Figure I)
- Remove (6) Phillips screws securing the climate controls to the factory radio assembly and detach the controls from the assembly. (Retain the screws and climate controls for reuse during kit preparation.)
- Remove (4) Phillips screws securing the a/c vents to the factory radio assembly and detach the a/c vent from the assembly. (Retain the screws and a/c vents for re-use during kit preparation.)
- Unclip and remove the hazard switch/passenger air bag light assembly. (Retain the hazard switch/passenger air bag light assembly for re-use during kit preparation.)
- Remove (4) Phillips screws securing trim panel at the bottom edge of the factory radio assembly and remove the trim panel. (Retain the screws and trim panel for re-use during kit preparation.)

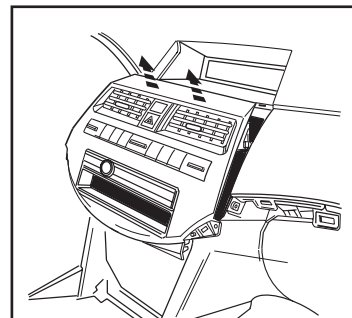

(Figure I)

- Unsnap (9) clips from the back of the factory radio assembly. (Retain the clips for re-use during kit preparation.)

Continue to Kit Preparation

KIT PREPARATION

1. Snap the hazard switch/passenger air bag light assembly into the radio housing from front. (Figure A)
2. From the back, reattach the a/c vents to the radio housing using the (4) original screws from step 12 Dash Disassembly. (Figure B)

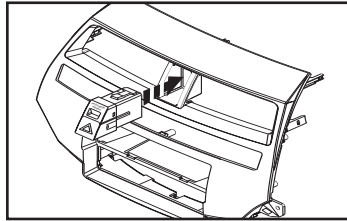

(Figure A)

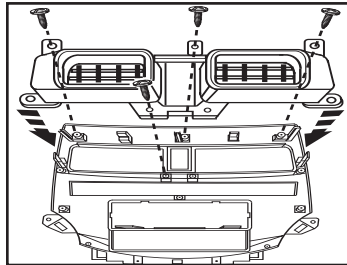

(Figure B)

3. From the back, reattach the climate controls to the radio housing using the (6) original screws from step 11 Dash Disassembly. (Figure C)
4. Secure the trim panel to the radio housing using the (4) original screws from step 14 Dash Disassembly. (Figure D)
5. Reattach the clips to the back of the radio housing. (Figure E).

Continue to Kit Assembly

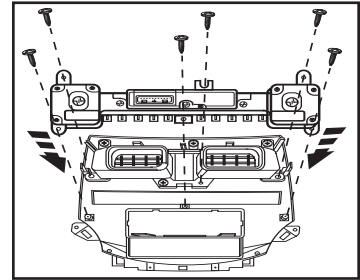

(Figure C)

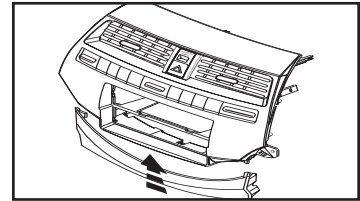

(Figure D)

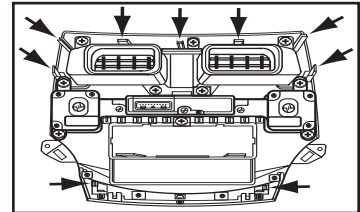

(Figure E)

KIT ASSEMBLY

DIN Mount Radio Provision with Pocket

1. Slide the DIN cage into the Radio Housing and secure by bending the metal locking tabs outward. (Figure A)
2. Slide the aftermarket radio into the DIN cage until it snaps into place. (Figure B)

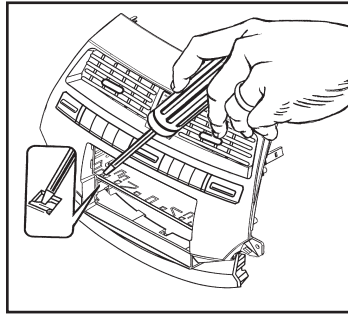

(Figure A)

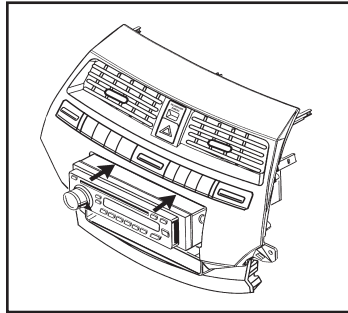

(Figure B)

3. Slide the pocket into the radio housing until it snaps into place. (Figure C)

Continue to Final Assembly

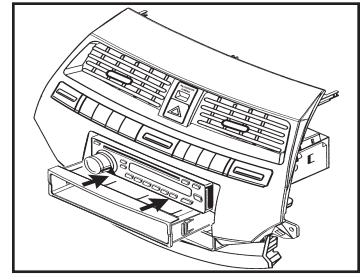

(Figure C)

KIT ASSEMBLY

ISO Mount Radio Provision with Pocket

1. Attach the ISO Brackets to the radio using the screws supplied with the radio. (Figure A)
2. Slide the aftermarket radio into the Radio Housing until it snaps into place. (Figure B)
3. Snap the Trim Plate onto the front of the Radio Housing. (Figure C)
4. Slide the pocket into the radio housing until it snaps into place. (Figure C)

Continue to Final Assembly

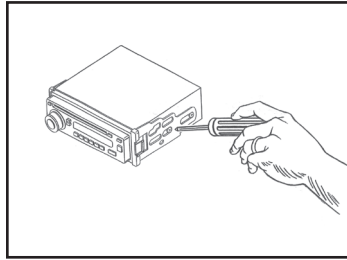

(Figure A)

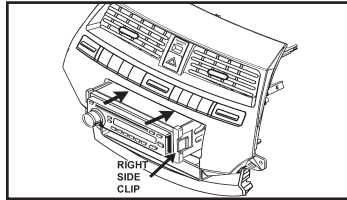

(Figure B)

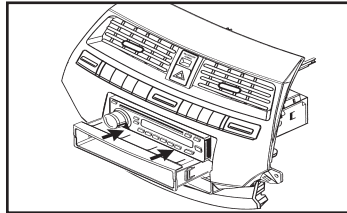

(Figure C)

DDIN/Stacked ISO Mount Units Provision

1. Cut and remove the center bar from the Radio Housing. (Figure A)
2. Affix the Double DIN brackets to the inside edge of the Radio Housing. (Figure B)
3. Slide the aftermarket radio into the bracket/radio housing and secure the unit(s) to the assembly using the screws supplied with the unit(s). (Figure C)
4. Snap the Double DIN trim plate onto the front of the Housing/Radio assembly. (Figure C)

Continue to Final Assembly

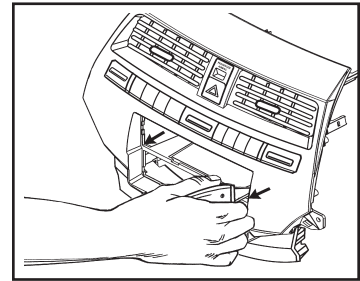

(Figure A)

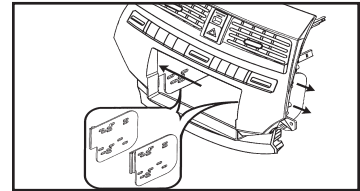

(Figure B)

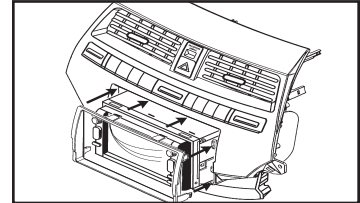

(Figure C)

FINAL ASSEMBLY

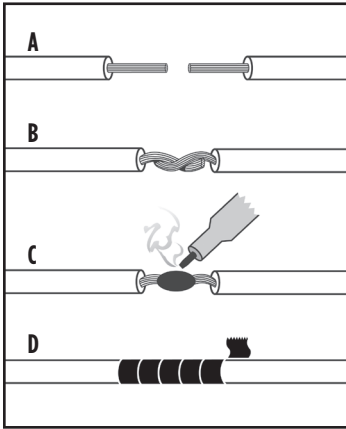

A) Strip wire ends back 1/2"

B) Twist ends together

C) Solder

D) Tape

1. Locate the factory wiring harness in the dash. Metra recommends using the proper mating adapter and making connections as shown. (Isolate and individually tape off the ends of any unused wires to prevent electrical short circuit.)
2. Re-connect the negative battery terminal and test the unit for proper operation.
3. Reassemble radio and dash assemblies in reverse order of disassembly.

Final Wiring Connections

Make wiring connections using the EIA color code chart shown below and the instructions included with the head unit. Metra recommends making connections as shown below; Strip, Splice, Solder, Tape. Isolate and individually tape off ends of any unused wires to prevent electrical short circuit.

METRA / EIA WIRING CODE

12V Ignition / Acc. Red	Right Front (+)..... Gray
12V Batt / Memory..... Yellow	Right Front (-)..... Gray/ Black
Ground..... Black*	Left Front (+)..... White
Power Antenna..... Blue	Left Front (-)..... White / Black
Amp Turn-On..... Blue / White	Right Rear (+)..... Violet
Amp Ground..... Black / White	Right Rear (-)..... Violet / Black
Illumination..... Orange	Left Rear (+)..... Green
Dimmer..... Orange / White	Left Rear (-)..... Green / Black

***NOTE:** When a Black wire is not present, ground radio to vehicle chassis. All colors may not be present on all leads due to manufacturer's specifications.



99-7875
INSTALLATION INSTRUCTIONS



Having difficulties? We're here to help.



Contact our Tech Support line at:

386-257-1187



Or via email at:

techsupport@metra-autosound.com

Tech Support Hours (Eastern Standard Time)

Monday - Friday: 9:00 AM - 7:00 PM

Saturday: 10:00 AM - 7:00 PM

Sunday: 10:00 AM - 4:00 PM



KNOWLEDGE IS POWER

Enhance your installation and fabrication skills by enrolling in the most recognized and respected mobile electronics school in our industry. Log onto www.installerinstitute.edu or call 386-672-5771 for more information and take steps toward a better tomorrow.



**Metra recommends MECP
certified technicians**