



## Installation instructions for 99-8101

# Toyota 1984-2004 99-8101/CF-952TY

### KIT FEATURES

- DIN radio provision
- Pocket provision



### KIT COMPONENTS

- A) Radio housing • B) Bracket set #1 • C) Bracket set #2 • D) Bracket set #3
- E) Bracket set #4 • F) Equalizer dummy plate • G) (6) #6 Phillips screws • H) (2) 3/8" Hex-head screws

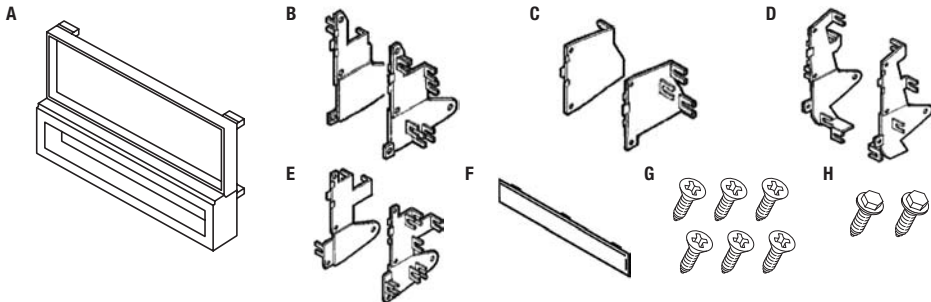

### WIRING & ANTENNA CONNECTIONS (sold separately)

#### Wiring Harness:

- 70-1761 Toyota

#### Antenna Adapter:

- Not required

### TOOLS REQUIRED

- Panel removal tool • Phillips screwdriver
- Socket wrench

**CAUTION:** Metra recommends disconnecting the negative battery terminal before beginning any installation. All accessories, switches, and especially air bag indicator lights must be plugged in before reconnecting the battery or cycling the ignition.

**NOTE:** Refer to the instructions included with the aftermarket radio.



99-8101

## Table of Contents

### Dash Disassembly

– Toyota 4-Runner 1984-1988 .....	3
– Toyota 4-Runner 1989-1995 .....	3
– Toyota 4-Runner 1996-2002 .....	4
– Toyota Camry 1987-1991 .....	4
– Toyota Celica ( <i>GT/GTS</i> ) 1986-1989 .....	5
– Toyota Celica 1990-1993 .....	5
– Toyota Corolla ( <i>GTS/SR5</i> ) 1984-1987 .....	6
– Toyota Corolla ( <i>sedan/wagon, lower dash</i> ) 1988-1992.....	6
– ToyotaCorolla ( <i>sedan/wagon, upper dash</i> ) 1988-1992.....	7
– ToyotaCorolla ( <i>coupe, lower dash</i> ) 1993-1997.....	7
– ToyotaCorolla ( <i>coupe, upper dash</i> ) 1993-1997.....	8
– Toyota MR2 1991-1995 .....	8

– Toyota Pickup 1984-1988 .....	9
– Toyota Pickup 1989-1991 .....	9
– Toyota Pickup 1992-1995 .....	10
– Toyota Supra 1986.5-1992 .....	10
– Toyota T-100 1993-1998 .....	11
– Toyota Tacoma 1995-2004.....	11

### Kit Assembly

– Pocket retention provision .....	12
– Upper dash ( <i>Corolla applications</i> ) mounting provision .....	12
– All ( <i>other</i> ) vehicle mounting provision .....	13
– DIN radio provision.....	13

### Toyota 4-Runner 1984-1988

1. Remove the ashtray and (3) screws from the ashtray bracket. (Figure A)
2. Remove (1) screw from each side of the dash console and unsnap the trim bezel. (Figure A)
3. Remove (1) screw from each side of the dash console and unsnap the trim bezel. (Figure A)
4. Cut and remove all mounting tabs on bracket set #1 EXCEPT tabs "A" (mounting tabs can be identified by a stamped letter on the back of each tab). (Figure B)

*Continue to kit assembly*

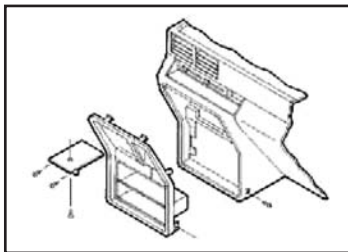

(Figure A)

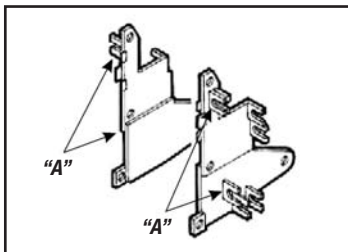

(Figure B)

### Toyota 4-Runner 1989-1995

1. Remove the driver's side speaker panel by removing (3) screws and (1) 10 mm bolt. (Figure A)
2. Remove (1) screw from the left side of the housing and unsnap the ignition cover.
3. Remove the glove compartment assembly by removing (1) 10 mm bolt from the bottom of the speaker panel and (3) screws from the right side of the housing.
4. Remove the remaining (3) screws securing the radio trim bezel. (Figure A)
5. Cut and remove all mounting tabs on bracket set #1 EXCEPT top tabs "C" and bottom tabs "B" (mounting tabs can be identified by a stamped letter on the back of each tab). (Figure B)

*Continue to kit assembly*

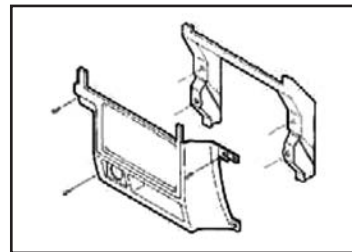

(Figure A)

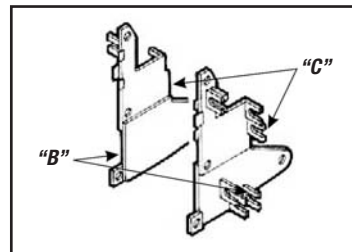

(Figure B)

**Toyota 4-Runner 1996-2002**

1. Open the center armrest door. Unsnap the parking brake trim panel to access the gear shifter trim panel.
2. Unsnap the gear shifter trim panel and remove. Remove the climate control knobs.
3. Remove the climate control trim plate and (2) Phillips screws exposed. Unclip the radio trim bezel and remove. (Figure A)
4. Remove (4) Phillips screws securing the factory radio and disconnect the wiring.
5. Cut and remove all mounting tabs on bracket set #1 EXCEPT tabs "B" (mounting tabs can be identified by a stamped letter on the back of each tab). (Figure B)

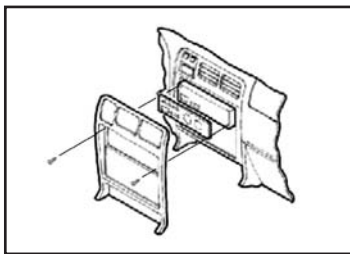
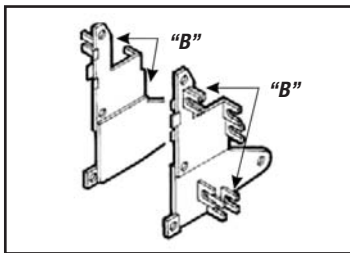
*(Figure A)**(Figure B)*

*Continue to kit assembly*

**Toyota Camry 1987-1991**

1. Remove (2) screws above the climate controls and gently unsnap the dash trim bezel. (Figure A)
2. Remove (4) screws securing the factory radio and disconnect the wiring.
3. Cut and remove all mounting tabs on bracket set #4 EXCEPT tabs "B" (mounting tabs can be identified by a stamped letter on the back of each tab). (Figure B)

*Continue to kit assembly*

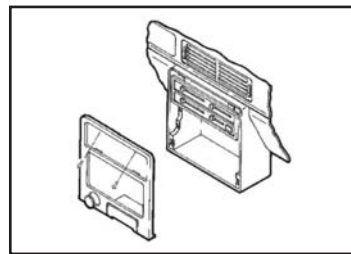
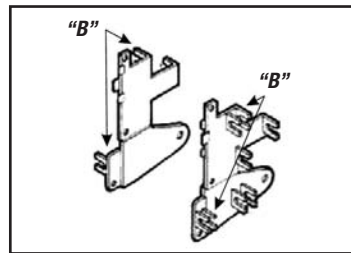
*(Figure A)**(Figure B)*

**Toyota Celica (GT/GTS) 1986-1989**

1. Remove (2) screws from the lower steering column panel and remove.
2. Remove the (2) screws exposed on the radio trim bezel.
3. Open the glove box and remove (1) screw and (1) bolt exposed.
4. Remove (2) screws from the ashtray cavity and (2) screws from the bracket.
5. Remove (2) screws from each lower side of the trim bezel and unsnap the bezel. (Figure A)
6. Cut and remove all mounting tabs on bracket set #4 EXCEPT tabs "C" (mounting tabs can be identified by a stamped letter on the back of each tab). (Figure B)

*Continue to kit assembly*

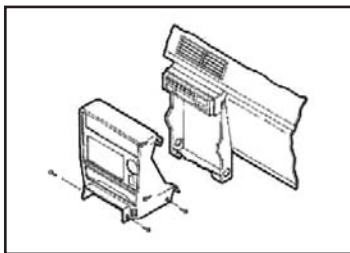

(Figure A)

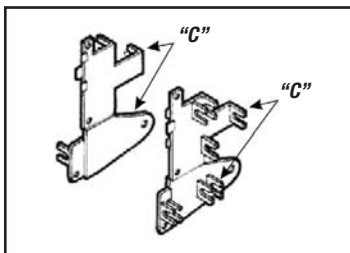

(Figure B)

**Toyota Celica 1990-1993**

1. Carefully pry up on the gear shifter trim panel and remove.
2. Remove (2) screws exposed on the bottom edge of the radio trim panel.
3. Unsnap the panel and disconnect the ashtray and cigarette lighter wiring. (Figure A)
4. Cut and remove all mounting tabs on bracket set #4 EXCEPT tabs "A" (mounting tabs can be identified by a stamped letter on the back of each tab). (Figure B)

*Continue to kit assembly*

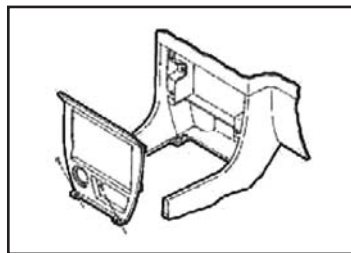

(Figure A)

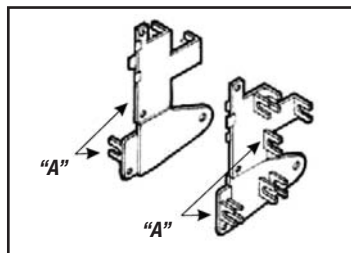

(Figure B)

## Toyota Corolla (GTS/SR5) 1984-1987

1. Remove (2) Phillips screws from each side of the console trim bezel. (Figure A)
2. Remove (4) screws securing the factory radio and disconnect the wiring.
4. Cut and remove all mounting tabs on bracket set #4 EXCEPT tabs "D" (mounting tabs can be identified by a stamped letter on the back of each tab). (Figure B)

*Continue to kit assembly*

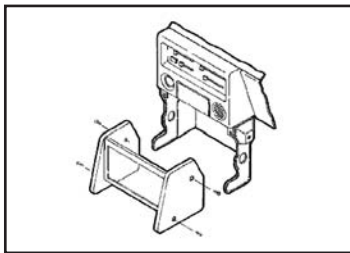

(Figure A)

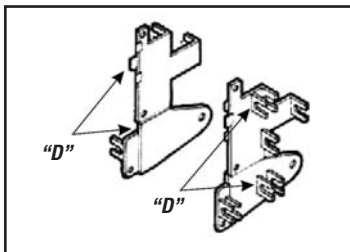

(Figure B)

## Toyota Corolla (sedan/wagon, lower dash) 1988-1992

1. Remove (1) screw located to the right of the ignition switch.
2. Remove (1) screw located above the driver's side speaker.
3. Carefully unsnap the dash trim bezel (some force may be required). (Figure A)
4. Cut and remove all mounting tabs on bracket set #3 EXCEPT tabs "C" (mounting tabs can be identified by a stamped letter on the back of each tab). (Figure B)

*Continue to kit assembly*

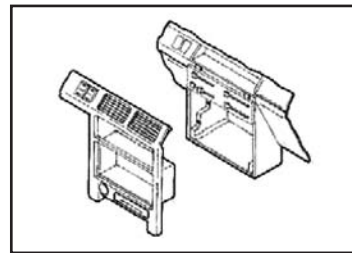

(Figure A)

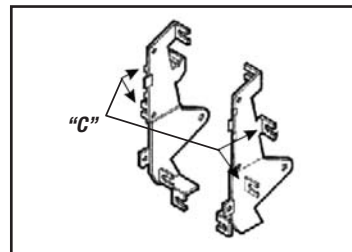

(Figure B)

### Toyota Corolla (sedan/wagon, upper dash) 1988-1992

1. Remove (4) screws from the top edge of the instrument trim bezel and (2) screws below the radio opening.
2. Remove (1) screw from the lower-left tab of the bezel (to the right of the a/c vent) and unsnap the bezel. (Figure A)
3. Cut and remove all mounting tabs on bracket set #2 EXCEPT tabs "A" (mounting tabs can be identified by a stamped letter on the back of each tab). (Figure B)

Continue to kit assembly

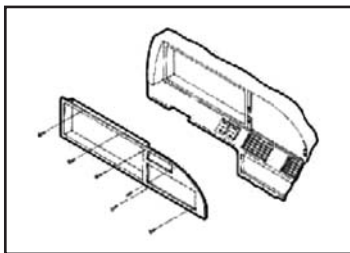

(Figure A)

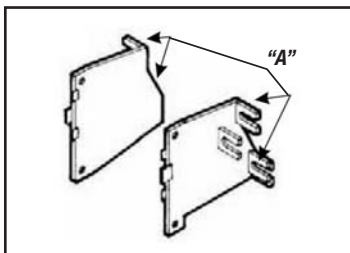

(Figure B)

### Toyota Corolla (coupe, lower dash) 1993-1997

1. Remove the climate control knobs, unsnap the upper trim bezel and disconnect the hazard and clock leads.
2. Remove (2) screws from the lower trim bezel and remove. (Figure A)
3. Cut and remove all mounting tabs on bracket set #3 EXCEPT tabs "A" (mounting tabs can be identified by a stamped letter on the back of each tab). (Figure B)

Continue to kit assembly

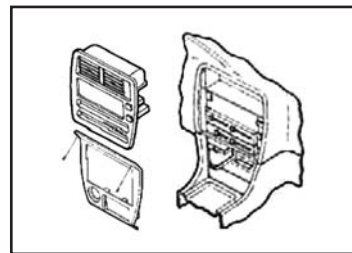

(Figure A)

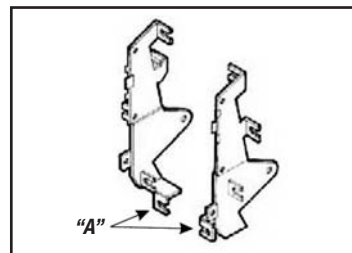

(Figure B)

## Toyota Corolla (coupe, upper dash) 1993-1997

1. Remove the climate control knobs and unsnap the dash trim bezel. (Figure A)
2. Disconnect the clock and hazard leads.
3. Cut and remove all mounting tabs on bracket set #2 EXCEPT tabs "B" (mounting tabs can be identified by a stamped letter on the back of each tab). (Figure B)

*Continue to kit assembly*

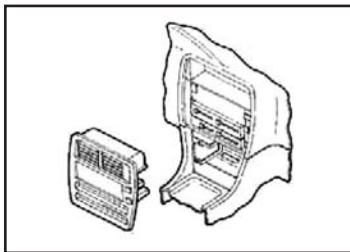

(Figure A)

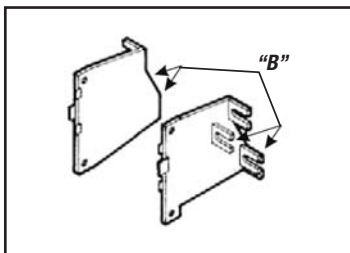

(Figure B)

## Toyota MR2 1991-1995

1. Remove the ashtray and (2) screws from the ashtray cavity.
2. Unsnap and remove the shifter console bezel.
3. Remove (1) screw below the ignition switch and remove the dash trim bezel. (Figure A)
4. Cut and remove all mounting tabs on bracket set #1 EXCEPT tabs "D" (mounting tabs can be identified by a stamped letter on the back of each tab). (Figure B)

*Continue to kit assembly*

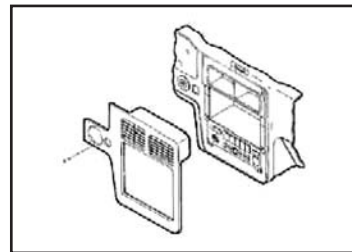

(Figure A)

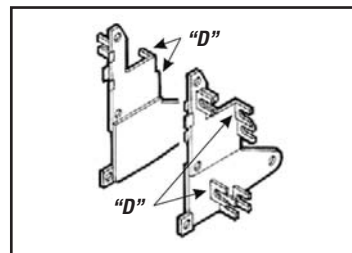

(Figure B)



### Toyota Pickup 1984-1988

1. Remove the ashtray and (3) screws from the ashtray bracket. (Figure A)
2. Remove (1) screw from each side of the dash console and unsnap the trim bezel. (Figure A)
3. Cut and remove all mounting tabs on bracket set #1 EXCEPT tabs "A" (mounting tabs can be identified by a stamped letter on the back of each tab). (Figure B)

*Continue to kit assembly*

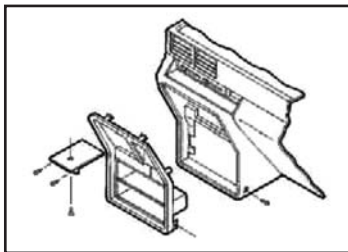

(Figure A)

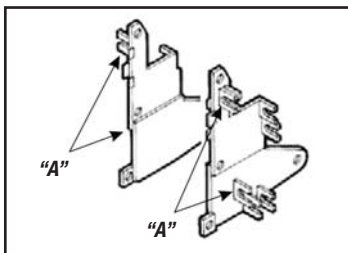

(Figure B)

### Toyota Pickup 1989-1991

1. Remove the driver's side speaker panel by removing (3) screws and (1) 10 mm bolt.
2. Remove (1) screw from the left side of the housing and unsnap the ignition cover.
3. Remove the glove compartment assembly by removing (1) 10 mm bolt from the bottom of the speaker panel and (3) screws from the right side of the housing.
4. Remove the remaining (3) screws securing the radio trim bezel. (Figure A)
5. Cut and remove all mounting tabs on bracket set #1 EXCEPT tabs "B" (mounting tabs can be identified by a stamped letter on the back of each tab). (Figure B)

*Continue to kit assembly*

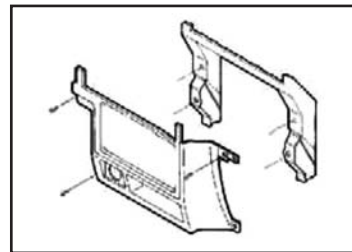

(Figure A)

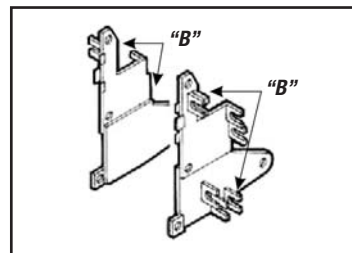

(Figure B)

## Toyota Pickup 1992-1995

1. Remove the driver's side speaker panel by removing (3) screws and (1) 10 mm bolt.
2. Remove (1) screw from the left side of the housing and unsnap the ignition cover.
3. Remove the glove compartment assembly by removing (1) 10 mm bolt from the bottom of the speaker panel and (3) screws from the right side of the housing.
4. Remove the remaining (3) screws securing the radio trim bezel. (Figure A)
5. Cut and remove all mounting tabs on bracket set #1 EXCEPT tabs "C" (mounting tabs can be identified by a stamped letter on the back of each tab). (Figure B)

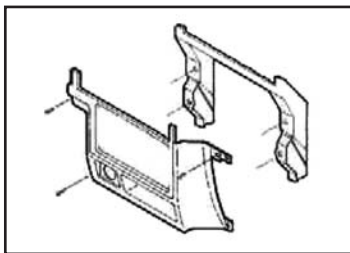

(Figure A)

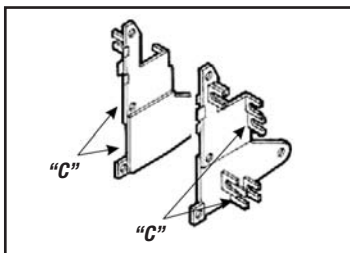

(Figure B)

*Continue to kit assembly*

## Toyota Supra 1986.5-1992

1. Remove the ashtray and (2) screws from the ashtray cavity.
2. Remove (1) screw located to the right of the steering column and (1) screw located to the left of the gear shifter. (Figure A)
3. Cut and remove all mounting tabs on bracket set #3 EXCEPT tabs "B" (mounting tabs can be identified by a stamped letter on the back of each tab). (Figure B)

*Continue to kit assembly*

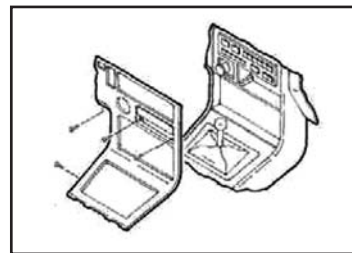

(Figure A)

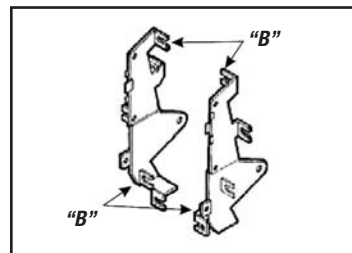

(Figure B)

## Toyota T-100 1993-1998

1. Pull the cupholder out and unsnap the trim bezel from the dash. (Figure A)
2. Remove (4) screws securing the factory radio and disconnect the wiring.
3. Cut and remove all mounting tabs on bracket set #1 EXCEPT tabs "B" (mounting tabs can be identified by a stamped letter on the back of each tab). (Figure B)

*Continue to kit assembly*

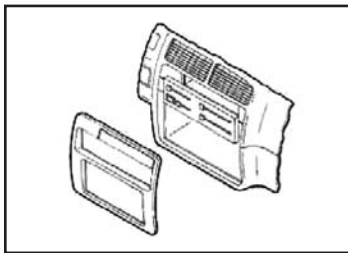

(Figure A)

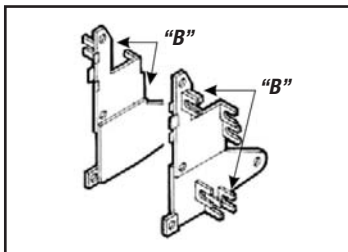

(Figure B)

## Toyota Tacoma 1995-2004

1. Remove the climate control knobs.
2. Unsnap the climate control trim panel and remove (2) screws exposed. (Figure A)
3. Gently unclip the dash trim bezel, lift up on the panel and remove.
4. Cut and remove all mounting tabs on bracket set #1 EXCEPT tabs "B" (mounting tabs can be identified by a stamped letter on the back of each tab). (Figure B)

*Continue to kit assembly*

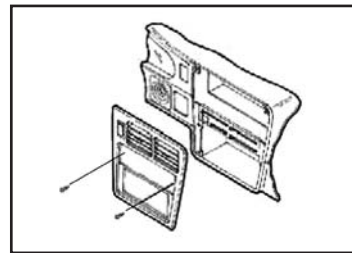

(Figure A)

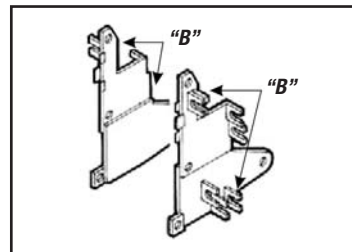

(Figure B)

## Pocket retention provision

1. Cut a diagonal score line on each side of the radio housing and then break away the bottom portion of the housing and discard. (Figure A)
2. Mount the brackets to the converted radio housing with (4) #6 Phillips screws. (Figure B)
3. Order the Metra 88-00-8000, cut and remove sockets "C", and mount the pocket to the brackets with (2) 3/8" hex-head screws and (2) locator pins. (Figure C)

*Continue to DIN radio provision*

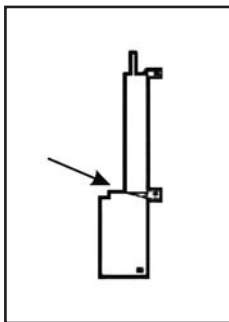

(Figure A)

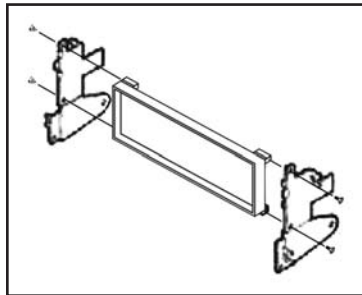

(Figure B)

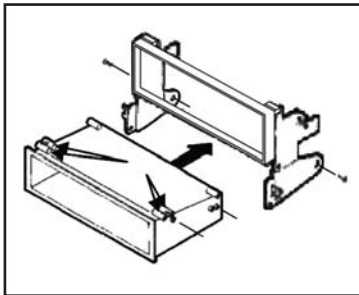

(Figure C)

## Upper dash (Corolla applications) mounting provision

1. Cut a diagonal score line on each side of the radio housing and then break away the bottom portion of the housing and discard. (Figure A)
2. Mount the brackets to the converted radio housing with (4) #6 Phillips screws. (Figure B)

*Continue to DIN radio provision*

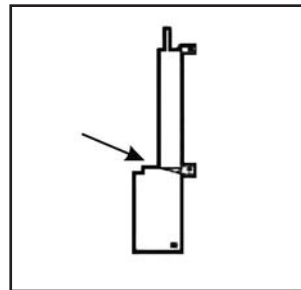

(Figure A)

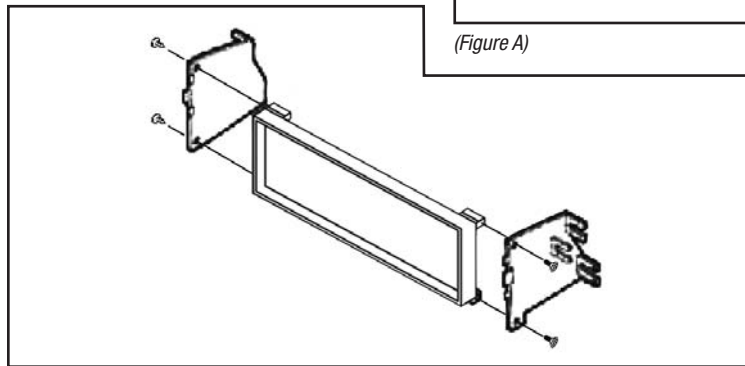

(Figure B)

**All (other)  
vehicle mounting provision**

1. Mount the brackets to the radio housing with (6) #6 Phillips screws. (Figure A)

*Continue to DIN radio provision*

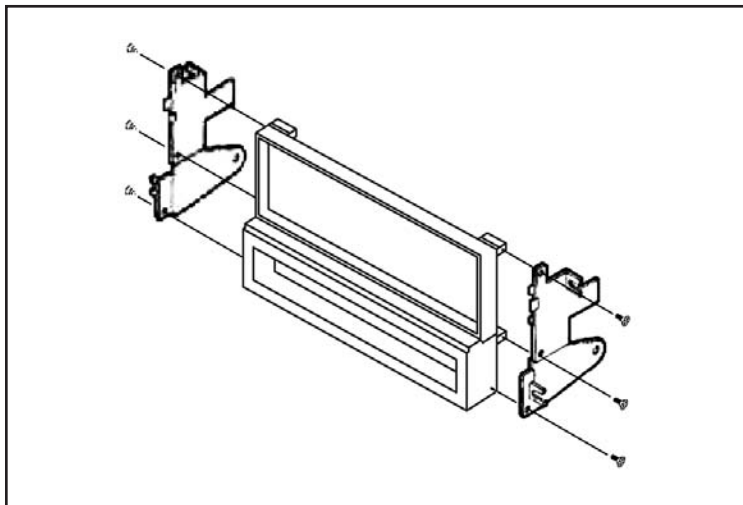

(Figure A)

**DIN radio provision**

1. Slide the DIN cage into the radio housing and secure by bending the metal locking tabs down.
2. Slide the aftermarket radio into the cage until secure. (Figure A)

**Note:** *If an equalizer will be included, slide the equalizer into the back of the radio housing and secure.*

*If an equalizer will NOT be used, snap the equalizer dummy plate into the opening.*

3. Locate the factory wiring harness in the dash. Metra recommends using the proper mating adapter from Metra or AXCESS. Reconnect the negative battery terminal and test the radio for proper operation.
4. Mount the completed assembly to the sub-dash with screws previously removed.

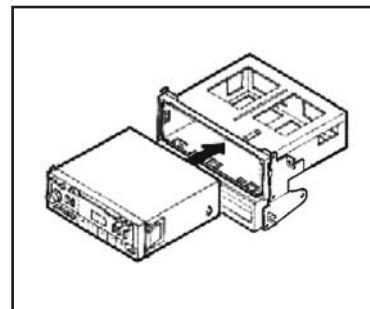

(Figure A)

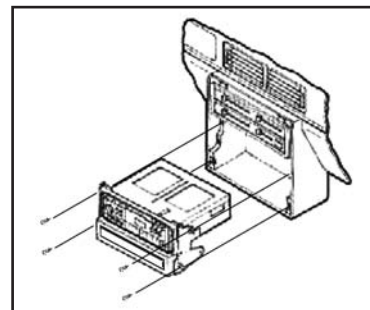

(Figure B)



99-8101

## Notes

---

---

---

---

---

---

---

---

---

---

---

---

---



99-8101

## Notes

---

---

---

---

---

---

---

---

---

---

---



Installation instructions for 99-8101



REV 1/12/2015 INST99-8101



### KNOWLEDGE IS POWER

Enhance your installation and fabrication skills by enrolling in the most recognized and respected mobile electronics school in our industry. Log onto [www.installerinstitute.com](http://www.installerinstitute.com) or call 800-354-6782 for more information and take steps toward a better tomorrow.



**Metra recommends MECP  
certified technicians**