











# ASSEMBLY INSTRUCTION

ITEM: 6350-90367-03 Ashore 6/0-6/6 Uph Panel Headboard  
 6350-90368-03 Ashore 6/0-6/6 Panel Footboard  
 6350-90351-03 Ashore 5/0 Uph Panel Headboard  
 6350-90352-03 Ashore 5/0 Panel Footboard  
 6350-90353-03 Ashore 6/6 Rails  
 6350-90363-03 Ashore 6/0 Rails

Thank you for purchasing this quality product. Be sure to unpack carefully looking for small parts which may have come loose during shipment.

Read all instruction and study the drawing carefully before starting the assembly process.

HARDWARE PACK					PARTS LIST			
NO.	DRAWING	DESCRIPTION	SIZE	Q'TY	NO.	DRAWING	DESCRIPTION	Q'TY
A		Open Wrench	Ø5/16"	1 PC	1		Headboard	1 PC
B		Nut	Ø5/16"	8 PCS	2		Rail	2 PCS
C		Curved Washer	Ø5/16"	8 PCS	3		Footboard	1 PC
D		Threaded Rod	5/16*100mm	8 PCS	4		Slat	4 PCS (5/0) 5 PCS (6/0-6/6)
E		Screw	8*32mm	16 PCS (5/0) 20 PCS (6/0-6/6)	5		Support Leg	4 PCS (5/0) 5 PCS (6/0-6/6)

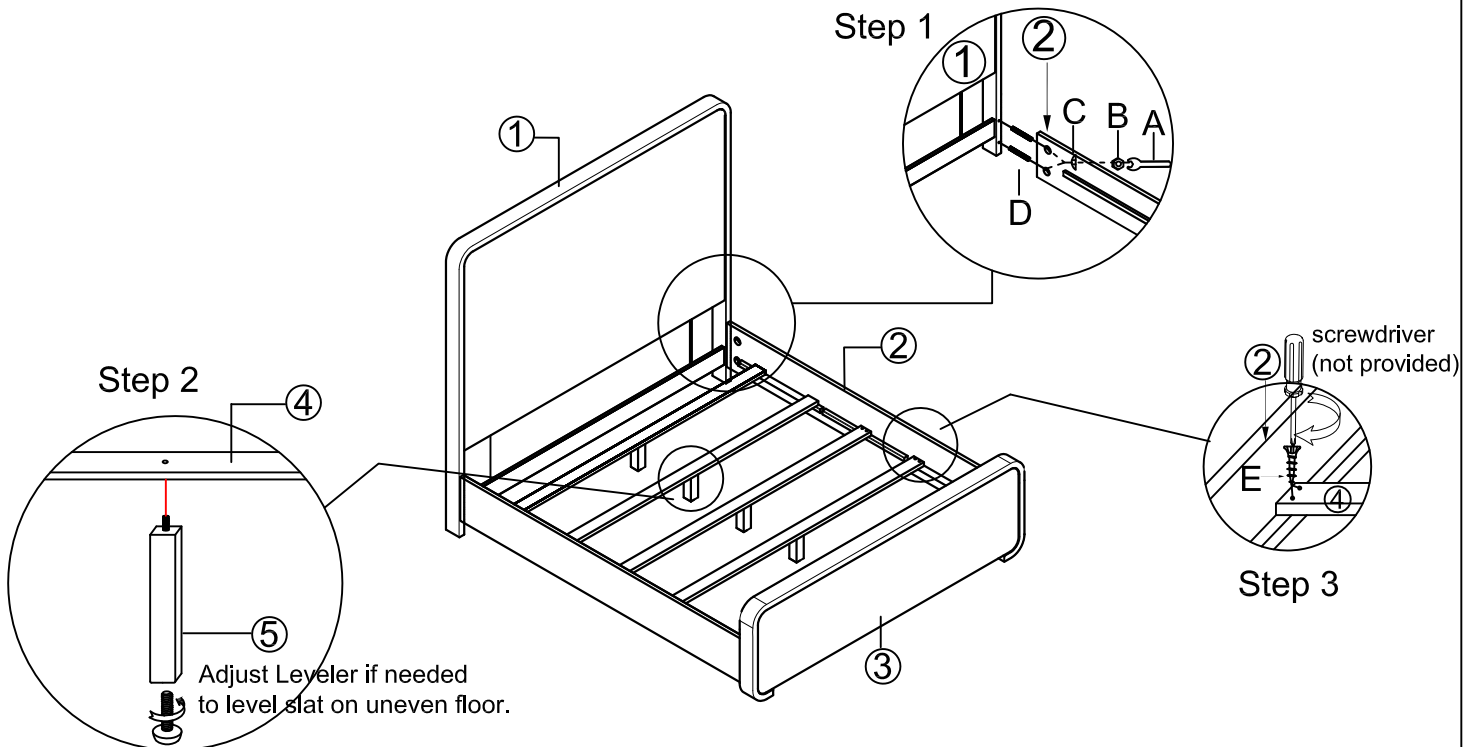

Step 1: Attach Rails (2) to Headboard (1) and Footboard (3) by using Threaded Rods (D), Curved Washers (C) and Nuts (B), tighten them with Open Wrench (A) .

Step 2: Attach support legs (5) to slats (4).

Step 3: Attach slats (4) to the rails (2) and tighten them by using Phillips head screwdriver.