

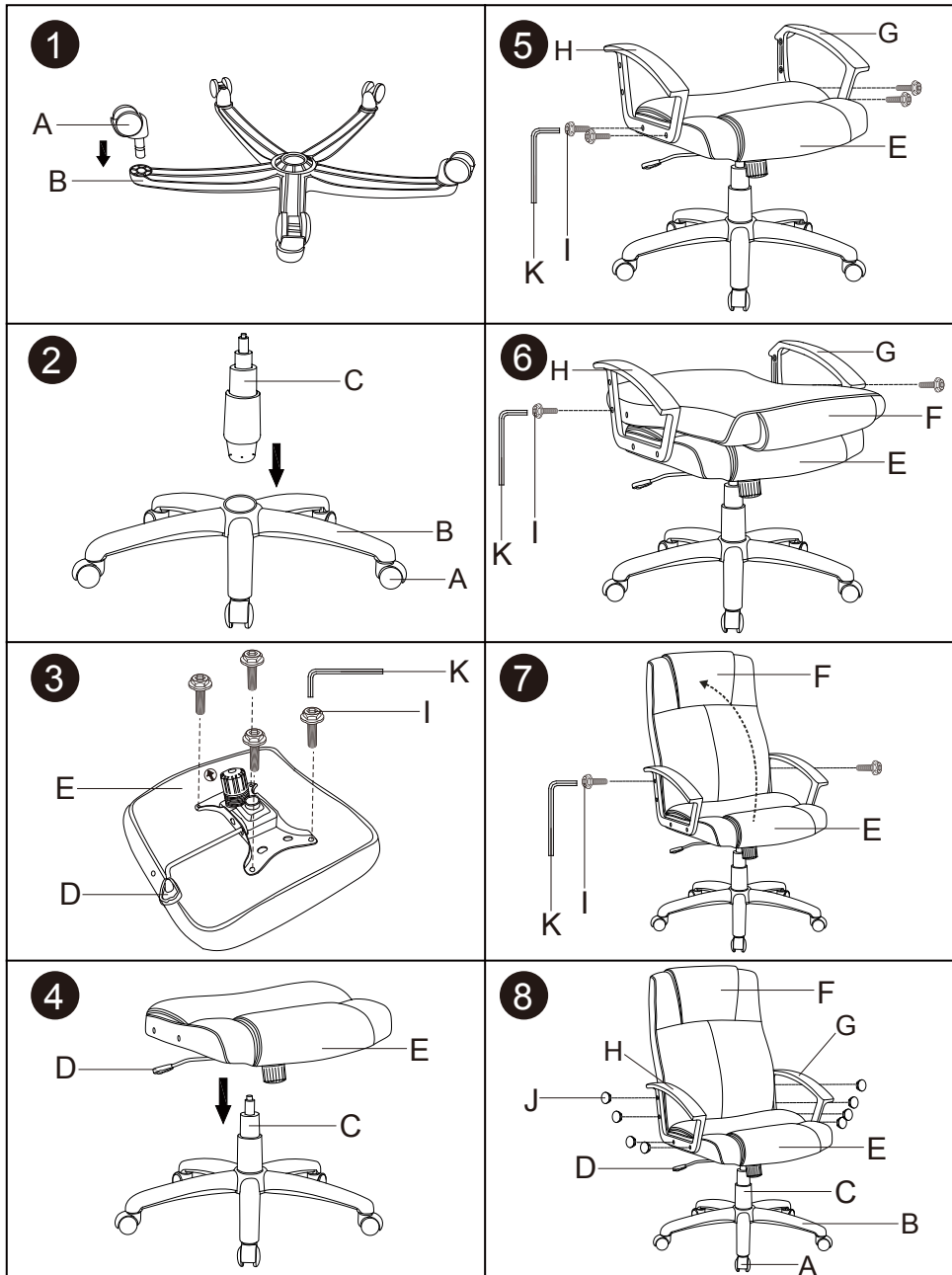

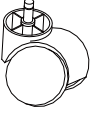



ASSEMBLY INSTRUCTIONS

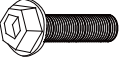
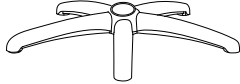
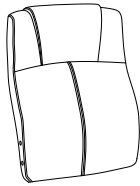

<p>A.</p>  <p>5PCS</p>	<p>E.</p>  <p>1PC</p>	<p>I.</p>  <p>12PCS</p>
<p>B.</p>  <p>1PC</p>	<p>F.</p>  <p>1PC</p>	<p>J.</p>  <p>8PCS</p>
<p>C.</p>  <p>1PC</p>	<p>G.</p>  <p>1PC</p>	<p>K.</p>  <p>1PC</p>
<p>D.</p>  <p>1PC</p>	<p>H.</p>  <p>1PC</p>	

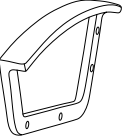
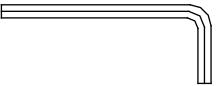
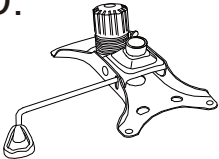
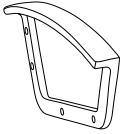
Model: ALE-CL4119

Manufactured for/ Hecho para/ Fabriqué pour Alera®/ Essendant Co.,
One Parkway North, Deerfield, IL 60015 © 2015 Essendant Co.

Made in/ Hecho en/ Fabriqué en China

Product support and parts: 1-800-733-4000

Ayuda del producto y partes / Support technique et pieces

08-015/2



OPERATING INSTRUCTIONS

ALE-CL4119

A. Seat height adjustment

To raise the seat height, stand up from the chair while lifting the lever (A) under the right side of the seat. To lower the seat height, lift the lever (A) while sitting in the chair.

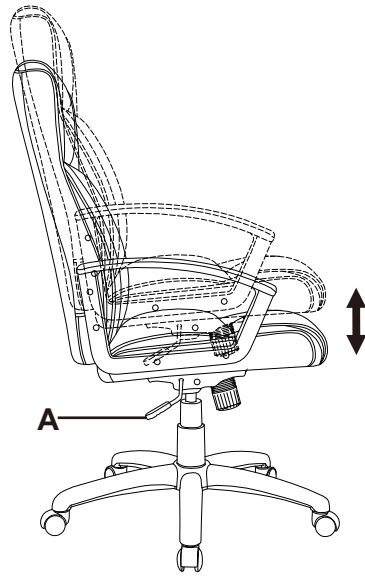

B. Tilt tension

Knob underneath seat adjusts angle and ease with which chair reclines to the different weights and strengths for different users. To increase tension, turn knob to the right. To release tension (loosen), turn knob to the left.

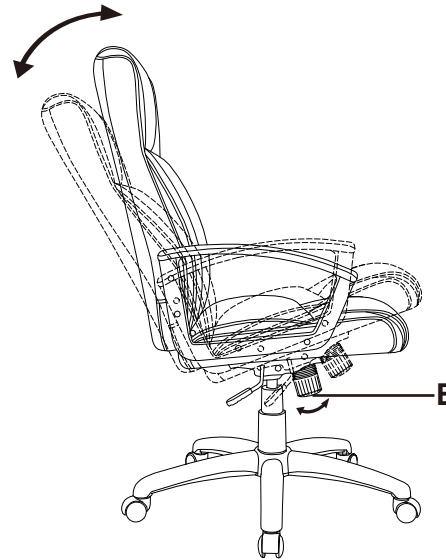

C. Tilt Lock

Pull the lever, "A", on the right side of the seat away from the chair to recline. To lock the chair in the right position, push the lever in towards the chair.

