

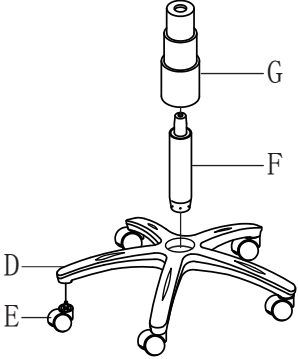

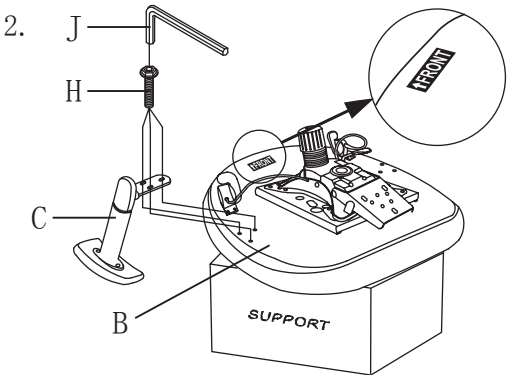

# ASSEMBLY INSTRUCTIONS

1. 

2. 

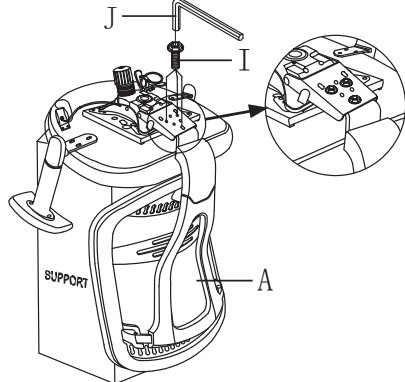







Repeat for other arm.

3. 

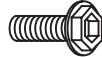
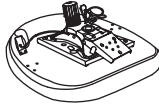
4. 

5. 

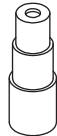
**Trouble shooting:**  
If seat height won't adjust or is not maintained, adjust screw until normal function resumes.

<p>A.  1 PC</p>	<p>E.  5 PCS</p>	<p>I.  3 PCS</p>
<p>B.  1 PC</p>	<p>F.  1 PC</p>	<p>J.  1 PC</p>
<p>C.  1 PAIR</p>	<p>G.  1 PC</p>	
<p>D.  1 PC</p>	<p>H.  6 PCS</p>	

Model: ALE-EN4215  
 Manufactured for/ Hecho para/ Fabriqué pour Alera®/ USSCo,  
 1 Parkway North, Suite 100, Deerfield, IL 60015 ©2014 USSCo  
 Made in/ Hecho en/ Fabriqué en China  
 Product support and parts: 1-800-733-4000  
 Ayuda del producto y partes / Support technique et pieces



# OPERATING INSTRUCTIONS

Model: ALE-EN4215

## A. Seat height adjustment

To raise the seat height, stand up from the chair while lifting the lever (A) under the right side of the seat. To lower the seat height, lift the lever (A) while sitting in the chair.

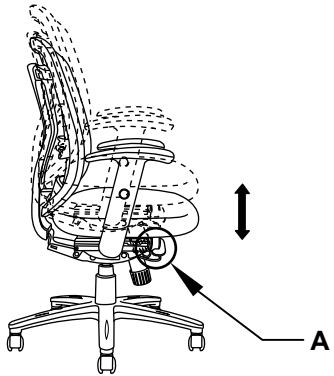

## B. Seat angle adjustment

Put down the lever(B), Random lean back will cause the chair seat to tilt backwards, Raise the lever(B) to lock the chair back and seat at random position.

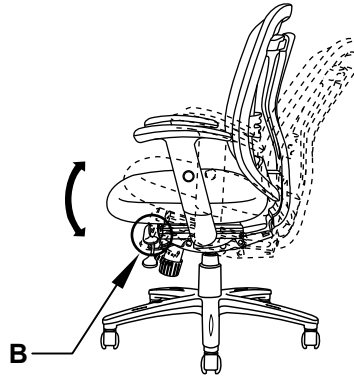

## C. Tilt tension

Knob underneath seat adjusts angle and ease with which chair reclines to the different weights and strengths to different users. To increase tension, turn knob to the right. To release tension, turn knob to the left.

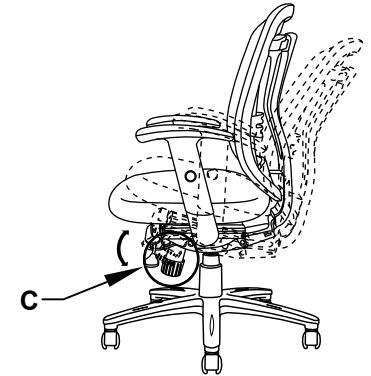

## D. Arm height adjustment

To adjust arm height, push the button on the outside of each arm and move the arm up or down. Release the button to set the height.

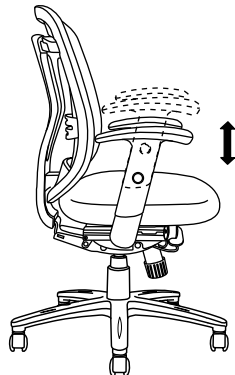

## E. Sliding seat adjustment

Push the lever (E) upward to allow seat to slide forward or backward. Release handle to lock in desired seat position

